

BELLSOUTH  
TELECOMMUNICATIONS  
FLORIDA

ISSUED: June 30, 2011  
BY: Marshall M. Criser III, President -FL  
Miami, Florida

ACCESS SERVICES TARIFF

Fourth Revised Page 1  
Cancels Third Revised Page 1

EFFECTIVE: July 1, 2011

**TITLE PAGE**  
ACCESS SERVICES TARIFF  
FOR THE  
STATE OF FLORIDA

(N)  
(T)  
(T)  
(T)

This Tariff contains Regulations, Rates and Charges applying to the provision of Access Services within a Local Access and Transport Area (LATA) or equivalent market area for Connection to Intrastate Communications Facilities for Customers within the operating territory of BellSouth Telecommunications, *LLC*<sup>1</sup> in the State of Florida as provided herein.

(C)

**Note 1:** Wherever in this Tariff *or its headings*, the term "Company" or the name "*Southern Bell Telephone and Telegraph Company*", "*BellSouth Telecommunications*" or "BellSouth" appears, that shall mean and shall refer to BellSouth Telecommunications, *LLC* d/b/a AT&T Florida or AT&T Southeast, unless the context clearly indicates otherwise.

(C)

BELLSOUTH  
TELECOMMUNICATIONS, INC.

**ACCESS SERVICES TARIFF**

Original Page 1

FLORIDA

ISSUED: July 1, 1996

EFFECTIVE: July 15, 1996

BY: Joseph P. Lacher, President -FL  
Miami, Florida

**PREFACE<sup>1</sup>**

(N)

All service offerings and features in this Tariff are available for resale under the rules and regulations in Section E2. of this Tariff unless otherwise indicated.

**Note 1:** Text is shown as new due to reissue to all Tariff Sections. No changes were made in rates or regulations with this filing.

ISSUED: April 28, 2000  
BY: Joseph P. Lacher, President -FL  
Miami, Florida

EFFECTIVE: May 15, 2000

**ACCESS SERVICE TARIFF FOR THE STATE OF FLORIDA**  
**REFERENCE TO TECHNICAL PUBLICATIONS**

(T)

The following technical publications are referenced in this Tariff and may be obtained from Literary Data Center Inc., G.P.O. Box C-9014, Brooklyn, N.Y. 11202.

<b>Technical Reference</b>	<b>Date Issued</b>	<b>Date Available</b>
PUB 41451	January, 1983	May 17, 1983
PUB 62310	September, 1983	October, 1983
TR-NPL-000054	April, 1989	April, 1989
TR-NPL-000334	June, 1986	June, 1986
TR-NPL-000335	June, 1986	June, 1986
TR-NPL-000336	October, 1987	October, 1987
TR-NPL-000337	July, 1987	July, 1987
TR-NPL-000341	March, 1989	April, 1989
TA-TSY-000342	March, 1990	March, 1990
PUB 62501	December, 1983	March 15, 1984
PUB 62501 Addendum	March, 1984	April, 1984
PUB 62502	December, 1983	January, 1984
PUB 62503	December, 1983	March 15, 1984
PUB 62503 Addendum	March, 1984	April, 1984
PUB 62504	December, 1983	March 15, 1984
PUB 62504 Addendum	March, 1984	April, 1984
PUB 62505	December, 1983	January, 1984
PUB 62505 Addendum	March, 1984	April, 1984
PUB 62506	December, 1983	January, 1984
PUB 62507	December, 1983	March 15, 1984
PUB 62508	December, 1983	January, 1984

The following technical publications are referenced in this Tariff and may be obtained by contacting BellCore at (800) 521-2673.

<b>Technical Reference</b>	<b>Date Issued</b>	<b>Date Available</b>
TR-NWT-000020	December, 1992	December, 1992
TR-NWT-000063	September, 1993	September, 1993

The following technical publications are referenced in this Tariff and are available from BellSouth Documentation Operations, North W5A1, 3535 Colonnade Parkway, Birmingham, Alabama 35243.

<b>Technical Reference</b>	<b>Date Issued</b>	<b>Date Available</b>
TR-73505	March, 1994	March, 1994

The following technical publications, referenced in this Tariff, may be obtained from the Internet Engineering Task Force (IETF) at Corporation for National Research Initiatives, Attention: Accounting Department – IETF Proceedings, 1895 Preston White Drive, Suite 100, Reston, VA 20191-5434 or via Internet at [www.ietf.org](http://www.ietf.org).

STD001, Internet Official Protocol Standards, J. Reynolds, R. Braden, Editor, issued June, 1999

RFC 2138, Remote Authentication Dial-In User Service (RADIUS); C. Rigney, A. Rubens, W. Simpson, S. Willens,

Issued April, 1997

(N)

(N)

(N)

## ACCESS SERVICES TARIFF FOR THE STATE OF FLORIDA

### EXPLANATION OF SYMBOLS

When changes are made in any tariff page, a revised page will be issued canceling the tariff page affected; such changes will be identified through the use of the following symbols:

(B)	To signify rates established under bond
(C)	To signify a changed regulation or tariff
(D)	To signify discontinued rate, regulation or text
(I)	To signify increase in rate
(M)	To signify a move from one page to another with no change to text, regulation or tariff
(N)	To signify new rate and/or new regulation, and/or new text
(O)	To signify obsoleted rate, regulation or text
(R)	To signify reduction in rate
(S)	To signify matter already appearing in another part of the tariff and repeated for clarification
(T)	To signify a change in text but no change in rate or regulation
(U)	To signify USOC added or changed only

The preceding symbols will apply except where additional symbols are identified at the bottom of an individual page or at the beginning or end of a section or paragraph.

### TRADEMARKS AND SERVICEMARKS

AT&T Intellectual Property owns the trademarks and servicemarks shown below. All of the trademarks and servicemarks shown below may or may not be an offering available in this Tariff.

BellSouth® AccuPulse® Service (AccuPulse Service)  
BellSouth® Digital ESSX® Service (Digital ESSX Service)  
BellSouth® ESSX® Service (ESSX Service)  
BellSouth® FlexServ® Service (a.k.a. BellSouth SPA Customer Reconfiguration) {FlexServ Service}  
BellSouth® LightGate® Service (a.k.a. BellSouth SPA Point to Point Network) {LightGate Service}  
BellSouth® MegaLink® Service (MegaLink Service)  
BellSouth® MultiServ® Service (MultiServ Service)  
BellSouth® Products (BellSouth Products)  
BellSouth® Service (BellSouth Service)

(D)

BellSouth® SMARTLine® Service (SMARTLine Service)  
BellSouth® SMARTPath® Service (a.k.a. BellSouth SPA Shared Ring) {SMARTPath Service}  
BellSouth® SMARTRing® Service (a.k.a. BellSouth Dedicated Ring) {SMARTRing Service}

Telcordia® and Common Language® are registered trademarks and iconectiv, CLCI, CLEI, CLFI, CLLI, USOC, FID, NC, NCI and NC/NCI, are trademarks of Telcordia Technologies, Inc. The Common Language codes identified in this Tariff are the proprietary information of Telcordia Technologies, Inc. dba iconectiv ("iconectiv") and are licensed to AT&T Services, Inc. The Common Language codes are provided herein solely for the purpose of this Tariff and may not be reproduced, stored, or used for any other purpose without the express, written consent of iconectiv.

ISSUED: November 18, 2003  
BY: Joseph P. Lacher, President -FL  
Miami, Florida

EFFECTIVE: December 3, 2003

## ACCESS SERVICES TARIFF FOR THE STATE OF FLORIDA

(N)

### REFERENCE TO TECHNICAL PUBLICATIONS

(M)

The following technical publications are referenced in this Tariff and may be obtained from Literary Data Center Inc., G.P.O. Box C-9014, Brooklyn, N.Y. 11202.

(M)

Technical Reference	Date Issued	Date Available	
PUB 41451	January, 1983	May 17, 1983	(M)
PUB 62310	September, 1983	October, 1983	(M)
TR-NPL-000054	April, 1989	April, 1989	(M)
TR-NPL-000334	Junc, 1986	Junc, 1986	(M)
TR-NPL-000335	Junc, 1986	Junc, 1986	(M)
TR-NPL-000336	October, 1987	October, 1987	(M)
TR-NPL-000337	July, 1987	July, 1987	(M)
TR-NPL-000341	March, 1989	April, 1989	(M)
TA-TSY-000342	March, 1990	March, 1990	(M)
PUB 62501	December, 1983	March 15, 1984	(M)
PUB 62501 Addendum	March, 1984	April, 1984	(M)
PUB 62502	December, 1983	January, 1984	(M)
PUB 62503	December, 1983	March 15, 1984	(M)
PUB 62503 Addendum	March, 1984	April, 1984	(M)
PUB 62504	December, 1983	March 15, 1984	(M)
PUB 62504 Addendum	March, 1984	April, 1984	(M)
PUB 62505	December, 1983	January, 1984	(M)
PUB 62505 Addendum	March, 1984	April, 1984	(M)
PUB 62506	December, 1983	January, 1984	(M)
PUB 62507	December, 1983	March 15, 1984	(M)
PUB 62508	December, 1983	January, 1984	(M)

The following technical publications are referenced in this Tariff and may be obtained by contacting BellCore at (800) 521-2673.

(M)

Technical Reference	Date Issued	Date Available	
TR-NWT-000020	December, 1992	December, 1992	(M)
TR-NWT-000063	September, 1993	September, 1993	(M)

The following technical publications are referenced in this Tariff and are available from BellSouth Documentation Operations, North W5A1, 3535 Colonnade Parkway, Birmingham, Alabama 35243.

(M)

Technical Reference	Date Issued	Date Available	
TR-73505	March, 1994	March, 1994	(M)

The following technical publications, referenced in this Tariff, may be obtained from the Internet Engineering Task Force (IETF) at Corporation for National Research Initiatives, Attention: Accounting Department – IETF Proceedings, 1895 Preston White Drive, Suite 100, Reston, VA 20191-5434 or via Internet at [www.ietf.org](http://www.ietf.org).

(M)

- STD001, Internet Official Protocol Standards, J. Reynolds, R. Braden, Editor, issued June, 1999 (M)
- RFC 2138, Remote Authentication Dial-In User Service (RADIUS); C. Rigney, A. Rubens, W. Simpson, S. Willens, Issued April, 1997 (M)

Material appearing on this page previously appeared on page(s) 1 of this section.

All BellSouth marks contained herein and as set forth in the trademarks and servicemarks section of this Tariff are owned by BellSouth Intellectual Property Corporation

## TABLE OF CONTENTS

E1.	APPLICATION OF TARIFF	
E2.	GENERAL REGULATIONS	
E3.	CARRIER COMMON LINE ACCESS	
E4.	CARRIER ACCESS CAPACITY	
E5.	ORDERING OPTIONS FOR ACCESS SERVICES	
E6.	BELLSOUTH SWA SERVICES	(T)
E7.	DEDICATED ACCESS SERVICES	
E8.	<b>(DELETED)</b>	(D)
E9.	BELLSOUTH DIRECTORY ASSISTANCE ACCESS SERVICE	(T)
E10.	LATA CONFIGURATIONS	
E11.	SPECIAL FACILITIES ROUTING OF ACCESS SERVICES	
E12.	SPECIALIZED SERVICE OR ARRANGEMENT	
E13.	ADDITIONAL ENGINEERING, ADDITIONAL LABOR AND MISCELLANEOUS CHARGES	
E14.	SPECIAL CONSTRUCTION	
E15.	RESERVED FOR FUTURE USE	
E16.	ACCESS SERVICE FOR LOCAL EXCHANGE COMPANIES COMPLETION OF INTRALATA - INTERCOMPANY LONG DISTANCE MTS AND WATS CALLS	
E17.	RESERVED FOR FUTURE USE	
E18.	BELLSOUTH OPERATOR SERVICES ACCESS SERVICE	(T)
E19.	RESERVED FOR FUTURE USE	
E20.	BELLSOUTH EXPANDED INTERCONNECTION SERVICE (EIS)	(T)
E21.	FAST PACKET ACCESS SERVICE	
E22.	RESERVED FOR FUTURE USE	
E23.	RESERVED FOR FUTURE USE	
E24.	RESERVED FOR FUTURE USE	
E25.	RESERVED FOR FUTURE USE	
E26.	BELLSOUTH SWA CONTRACT TARIFFS	
E27.	RESERVED FOR FUTURE USE	(T)
E28.	RESERVED FOR FUTURE USE	
E29.	RESERVED FOR FUTURE USE	
E30.	RESERVED FOR FUTURE USE	
E31.	RESERVED FOR FUTURE USE	
E32.	RESERVED FOR FUTURE USE	
E33.	RESERVED FOR FUTURE USE	
E34.	ADVANCED INTELLIGENT NETWORK (AIN) SERVICES	

**TABLE OF CONTENTS**

(T)

E100.	RESERVED FOR FUTURE USE	
E101.	RESERVED FOR FUTURE USE	
E102.	RESERVED FOR FUTURE USE	
E103.	RESERVED FOR FUTURE USE	
E104.	RESERVED FOR FUTURE USE	
E105.	RESERVED FOR FUTURE USE	
E106.	RESERVED FOR FUTURE USE	
E107.	RESERVED FOR FUTURE USE	
E108.	RESERVED FOR FUTURE USE	
E109.	RESERVED FOR FUTURE USE	
E110.	RESERVED FOR FUTURE USE	
E111.	RESERVED FOR FUTURE USE	
E112.	RESERVED FOR FUTURE USE	
E113.	OBSOLETE SERVICE OFFERING - ADDITIONAL ENGINEERING, ADDITIONAL LABOR AND MISCELLANEOUS CHARGES	
E114.	RESERVED FOR FUTURE USE	(N)
E115.	RESERVED FOR FUTURE USE	(N)
E116.	RESERVED FOR FUTURE USE	(N)
E117.	RESERVED FOR FUTURE USE	(N)
E118.	RESERVED FOR FUTURE USE	(N)
E119.	RESERVED FOR FUTURE USE	(N)
E120.	RESERVED FOR FUTURE USE	(N)
E121.	RESERVED FOR FUTURE USE	(N)
E122.	RESERVED FOR FUTURE USE	(N)
E123.	RESERVED FOR FUTURE USE	(N)
E124.	RESERVED FOR FUTURE USE	(N)
E125.	RESERVED FOR FUTURE USE	(N)
E126.	OBSOLETE SERVICE OFFERING - BELLSOUTH SWA CONTRACT TARIFFS	(N)

**Note 1: (DELETED)**

(D)

**SUBJECT INDEX**

**A.**

<b>SUBJECT</b>	<b>SECTION</b>
Acceptance Testing	
Dedicated Access .....	E7.1
BellSouth®SWA .....	E6.1
Access Codes	
700 Service Access Code .....	E2.
800 Service Access Code .....	E6.
900 Service Access Code .....	E6.
Access Connections .....	E7.
Access Orders .....	E5.2
Additional Cooperating Acceptance Testing (ACAT) .....	E13.3
Additional Engineering .....	E13.1
Additional Labor .....	E13.2
Advanced Intelligent Network (AIN) Services .....	E34.
Alternate Use (Dedicated Access Services) .....	E7.1
Analog (a.k.a. BellSouth® SPA DS0 VG) Services (Dedicated Access Service) .....	E7.2
Application of Move Charges .....	E12.
Application of Tariff .....	E1.
Assignment or Transfer of Service (General Regulation Limitations) .....	E2.
Asynchronous Transfer Mode (ATM) Service .....	E21.
Automatic Scheduled Testing (AST) .....	E13.3
Available Inventory .....	E5.3
Availability for Testing .....	E2.

(N)

® BellSouth is a registered trademark of BellSouth Corporation



**SUBJECT INDEX**

**B.**

<b>SUBJECT</b>	<b>SECTION</b>
Balance .....	E2.
Basic Channelization System .....	E7.
BellSouth AIN SMS Access Service .....	E34.6
BellSouth AIN Toolkit Service .....	E34.7
BellSouth Billing Name and Address for ANI Service .....	E13.3
BellSouth CCS7 Access Arrangement .....	E6
BellSouth Customer Change Activity Service .....	E13.3
BellSouth Customer Name and Address .....	E13.3
BellSouth Dedicated Ring Service .....	E6., E7.
BellSouth Directory Assistance Access Service .....	E9
BellSouth Expanded Interconnection Service .....	E21
BellSouth Equal Access Subscription .....	E13.3
<b>(DELETED)</b>	
<b>(DELETED)</b>	
BellSouth Network Visibility Service .....	E21.6
BellSouth Remote Access Service .....	E6.
BellSouth Resold Customer List Information .....	E13.
BellSouth SWA Common Transport IP Option .....	E6
BellSouth SWA Contract Tariffs .....	E26
BellSouth SWA CCSAC .....	E6
BellSouth SWA FGA .....	E6
BellSouth SWA FGB .....	E6
<b>(DELETED)</b>	
BellSouth SWA FGD .....	E6
BellSouth SWA Transport .....	E6
BellSouth SWA 500 Service .....	E6
BellSouth SWA 900 Service .....	E6
BellSouth SWA 8XX Toll Free Dialing Ten Digit Screening Service .....	E6
<b>(DELETED)</b>	
<b>(DELETED)</b>	
<b>(DELETED)</b>	
Billing Information (Provision of Access Service) .....	E13.3
<b>(DELETED)</b>	
<b>(DELETED)</b>	
Bipolar with 8 Zero Substitution (B8ZS) .....	E2.
Bridging (Dedicated Access Services) .....	E7.

(D)

**SUBJECT INDEX**

<b>C.</b>		<b>SECTION</b>
<b>SUBJECT</b>		
Calling Party Number.....		E6.
Cancellation of an Access Order.....		E5.
Carrier Access Capacity.....		E4., E16.
Carrier Common Line Access.....		E3.
Carrier Selection Parameter.....		E6.
Central Office Channel Interface.....		E7.
Changes and Substitutions (General Regulations).....		E2.
Charge Number.....		E6.
Claims and Demands for Damages.....		E2.
Clear Channel Capability.....		E7.
Commitment Guarantee Program.....		E2.
Common Channel Signaling Access Capability (BellSouth SWA CCSAC).....		E6.
Common Switching.....		E6.3
Compensation Rate.....		E2.4
Concurring Carriers.....		E1.
Connections.....		E2.
Contract Service Arrangements.....		E12.3
Controller Arrangement.....		E13.3
Cooperative Scheduled Testing (CST).....		E13.3
Cost Assessment Charge.....		E2.
Credit Allowance for BellSouth Directory Assistance Access Service.....		E9.4
Credit Allowance for Service Interruptions.....		E2.
Customer Change Activity Service (BellSouth Customer Change Activity Service).....		E13.3
Customer Name and Address (BellSouth Customer Name and Address).....		E13.3

(N)

## SUBJECT INDEX

### D.

SUBJECT	SECTION
Damages.....	E2.3
Data Transmission Specifications .....	E6.
Dedicated Access Line (a.k.a. BellSouth SPA Line).....	E7.
Dedicated Access Services (a.k.a. BellSouth SPA).....	E7.
Dedicated Access Line Termination .....	E6.
Definitions.....	E2.6
Deposits.....	E2.4
Design and Traffic Routing of BellSouth SWA Service .....	E6.
Design Blocking Probability .....	E6.
Design Change Charges (Access Order Modifications).....	E5.
Design of IC Services.....	E2.3
Design Layout Report .....	E6.1
<b>(DELETED)</b>	
Digital Data (a.k.a. BellSouth SPA DS0 Digital Data) Services (Dedicated Access Services).....	E7.
Digital Hierarchy Facility Interface Codes (4DS).....	E6.1
Digital Services (Dedicated Access Services).....	E7.
Directory Assistance Access Service (BellSouth Directory Assistance Access Service).....	E9.
Directory Transport (BellSouth Directory Assistance Access) .....	E9.2
Discontinuance and Refusal of Service .....	E2.1

(D)

**SUBJECT INDEX**

**E.**

<b>SUBJECT</b>	<b>SECTION</b>	
Egress Circuits.....	E2	(N)
End Office Transport Terminations .....	E6.	
Equal Access Exchange Areas (EAEA).....	E10.3	
Equipment Space and Power .....	E2.3	
Exchange Access Connectionless Data Service (a.k.a. BellSouth Exchange Access Connectionless Data Service).....	E21.	
Exchange Access Frame Relay Service (a.k.a. BellSouth Exchange Access Frame Relay service).....	E21.	
Expanded Interconnection Service (BellSouth Expanded Interconnection Service) .....	E20.	

ISSUED: December 19, 2013  
BY: Marshall M. Criser III, President -FL  
Miami, Florida

EFFECTIVE: December 20, 2013

### SUBJECT INDEX

#### F.

SUBJECT	SECTION
Facilities, Ownership of .....	E2.3
Feature Group A ( <i>BellSouth SWA</i> FGA) .....	E6.2
Feature Group B ( <i>BellSouth SWA</i> FGB) .....	E6.2
<b>(DELETED)</b>	
Feature Group D ( <i>BellSouth SWA</i> FGD) .....	E6.2

(D)

**SUBJECT INDEX<sup>1</sup>**

(N)

**G.**

<b>SUBJECT</b>	<b>SECTION</b>
General Regulations.....	E2.
Gross Receipts Tax (Provision for).....	E2.4

**Note 1:** Text is shown as new due to reissue of all Tariff Sections. No changes in rates or regulations were made with this filing.

BELLSOUTH  
TELECOMMUNICATIONS, INC.  
FLORIDA  
ISSUED: February 14, 1997  
BY: Joseph P. Lacher, President -FL  
Miami, Florida

ACCESS SERVICES TARIFF

First Revised Page 8  
Cancels Original Page 8  
EFFECTIVE: March 1, 1997

**SUBJECT INDEX**

(T)

**H.**

**SUBJECT**

**SECTION**

High Capacity (*a.k.a. BellSouth SPA High Capacity*) (Dedicated Access Service) ..... E7.

(T)

## SUBJECT INDEX

### I.

SUBJECT	SECTION
Ingress Circuits .....	E2
Installation and Termination of Service .....	E2.1
Interface Groups (BellSouth SWA Transport) .....	E6.
Interference or Impairment .....	E2.2
<b>(DELETED)</b>	
<b>(DELETED)</b>	

(D)



BELLSOUTH  
TELECOMMUNICATIONS, INC.  
FLORIDA  
ISSUED: February 14, 1997  
BY: Joseph P. Lacher, President -FL  
Miami, Florida

ACCESS SERVICES TARIFF

First Revised Page 10  
Cancels Original Page 10  
EFFECTIVE: March 1, 1997

**SUBJECT INDEX**

(T)

**J.**

**SUBJECT**

**SECTION**

Jurisdictional Reports

Dedicated Access ..... E2.3., E7.1.

*BellSouth SWA* ..... E2.3.

(T)

BELLSOUTH  
TELECOMMUNICATIONS, INC.  
FLORIDA  
ISSUED: July 1, 1996  
BY: Joseph P. Lacher, President - FL  
Miami, Florida

ACCESS SERVICE TARIFF

Original Page 11

EFFECTIVE: July 15, 1996

SUBJECT INDEX<sup>1</sup>

(N)

K.

SUBJECT

SECTION

**Note 1:** Text is shown as new due to reissue of all Tariff Sections. No changes in rates or regulations were made with this filing.

## SUBJECT INDEX

### L.

SUBJECT	SECTION
LATA Configurations .....	E10.
Late Payment Penalty (General Regulations).....	E2.
Liability (General Regulations).....	E2.1
<b>(DELETED)</b>	
Limitations (General Regulations) .....	E2.1
Local Switching .....	E6.
Local Switching Optional Features .....	E6.
Local Transport (BellSouth SWA Transport).....	E6.8

(D)

**SUBJECT INDEX**

**M.**

<b>SUBJECT</b>	<b>SECTION</b>	
Maintenance of Service.....	E2., E13.3.1	(T)
Manual Scheduled Testing (MST) .....	E13.3	
<b>(DELETED)</b>		
Measuring Access Minutes .....	E6.	
<b>(DELETED)</b>		
<b>(DELETED).</b>		
Message Unit Credit.....	E6.	
Metallic Facilities (Limitations of Use).....	E2.	
Mileage Calculation .....	E10.4	
Mileage Measurement.....	E7.4.	
Minimum Monthly Charges (BellSouth SWA Service) .....	E6.	
<b>(DELETED)</b>		
Minimum Periods.....	E2.	
<b>(DELETED)</b>		
BellSouth Directory Assistance Access Service .....	E9.	
Dedicated Access.....	E7.	
Television and Program Audio (a.k.a. BellSouth SPA Program Audio) Dedicated Access Services .....	E5.	
Testing.....	E13.	
<b>(DELETED)</b>		
Moves		
BellSouth SWA Service .....	E6.	
Dedicated Access Services.....	E7.	
Multipoint Service (Dedicated Access Service).....	E7.	

FLORIDA  
ISSUED: April 12, 1999  
BY: Joseph P. Lacher, President -FL  
Miami, Florida

EFFECTIVE: April 27, 1999

## SUBJECT INDEX

### N.

SUBJECT	SECTION
Narrowband Service .....	E7.3
Network Blocking Charge for BellSouth SWA FGD .....	E6.
Network Contingencies (Coordination) .....	E2.
Network Interface (NI) Combination .....	E7.1.
<b>(DELETED)</b>	
Network Management .....	E6.
Nonscheduled Testing (NST) .....	E13.3

(D)

EFFECTIVE: July 15, 1996

**SUBJECT INDEX<sup>1</sup>**

(N)

**O.**

<b>SUBJECT</b>	<b>SECTION</b>
Operator Services Access Service.....	E18.
Ordering Options for Access Services.....	E5.
Overtime Installation.....	E13.2
Labor.....	E13.2
Repair.....	E13.2

**Note 1:** Text is shown as new due to reissue of all Tariff Sections. No changes in rates or regulations were made with this filing.

## SUBJECT INDEX

### P.

SUBJECT	SECTION
Partial Cancellation Charge (Access Order Modifications).....	E5.
Payment Arrangements and Credit Allowances .....	E2.
<b>(DELETED).</b>	
Carrier Common Line Access.....	E3.
Payment of Rates, Charges, and Deposits .....	E2.
Physical Access Collocation Cross-Connect Service .....	E13.
Presubscription (BellSouth Equal Access Subscription Service).....	E13.3.
<b>(DELETED)</b>	(D)
Program Audio (Wired Music) (a.k.a. BellSouth SPA Program Audio).....	E7.3.
<b>(DELETED)</b>	(D)
)Proof of Certification .....	E2.
Protective Connecting Arrangements.....	E13.3.
Provision for Gross Receipts Tax .....	E2.4.
Provision of Access Service Billing Information .....	E13.3.
Provision of Specialized Service or Arrangements .....	E12.1.
<b>(DELETED)</b>	(D)

EFFECTIVE: July 15, 1996

**SUBJECT INDEX<sup>1</sup>**

(N)

Q.

**SUBJECT**

**SECTION**

Quotation Charge.....E2.

**Note 1:** Text is shown as new due to reissue of all Tariff Sections. No changes in rates or regulations were made with this filing.



## SUBJECT INDEX

### R.

SUBJECT	SECTION
<b>(DELETED)</b>	(D)
Re-establishment of Service Following Fire, Flood or Other Occurrence.....	E2.
References to the Company.....	E2.
Refusal and Discontinuance of Service.....	E2.
Remote Access Server.....	E2
Reports	
<b>(DELETED)</b>	(D)
Design Layout .....	E6.
Jurisdictional.....	E2.3., E7.1.
BellSouth SWA Report Requirements.....	E6.
Trunk Group Measurements .....	E6.
Resale of BellSouth SWA WATS-Type and BellSouth SWA WATS Services (BellSouth SWA Service).....	E6.

**SUBJECT INDEX**

**S.**

<b>SUBJECT</b>	<b>SECTION</b>
Secondary Channel .....	E7.
Sectionalization - Trouble Reporting .....	E2.
Service Access Codes	
700 Service Access Code .....	E2.
800 Service Access Code .....	E6.
900 Service Access Code .....	E6.
Service - Affecting Activities .....	E2.
Service Date Change Charge (Access Order Modifications) .....	E5.
Service Installation Guarantee .....	E2.
Service Mark Protection .....	E2.
Service Performance Data .....	E6.
<b>(DELETED)</b>	
Service Rearrangements .....	E6.
Shared Use Facilities (Access Orders) .....	E5.
Signal Transfer Point .....	E6.
SMARTRing® service (a.k.a. BellSouth Dedicated Ring) .....	E7
Special Access Line (See Dedicated Access Line)	
Special Access Service (See Dedicated Access Service)	
Special Construction .....	E14.
Special Facilities Routing .....	E11.
Special Transport .....	E7.
Specialized Service or Arrangements .....	E12.
Stand By (Additional Labor) .....	E13.2.
Standard Jacks - Registration Program .....	E13.3.
Standard Transmission Specifications .....	E6.
Supervisory Signaling .....	E6.
Symbols .....	Title Section

(D)

\* Registered Service Mark of BellSouth Corporation

## SUBJECT INDEX

T.	
SUBJECT	SECTION
TDM to IP Transition.....	E2
Technical Publications Reference .....	Title Section
Telephone Numbers .....	E2.
Telecommunications Service Priority (TSP) System .....	E13.
Temporary Facilities .....	E14.
Testing Services .....	E13.
Theft.....	E2.
Time of Day Discounts .....	E6.7
Title Or Ownership Rights (General Regulations).....	E2.
Traffic Routing of BellSouth SWA Service.....	E6.
Transfer of Service (General Regulations Limitations).....	E2.1, E6. E7.
Transmission Paths.....	E6.4
Transmission Specifications.....	E6.4
Transport Payment Plan (TPP).....	E2
Transport Termination Optional Features .....	E6.3
Trouble Location Charge (TLC) .....	E13.3
Trunk Group Measurement Reports.....	E6.5

(N)

BELLSOUTH  
TELECOMMUNICATIONS, INC.  
FLORIDA  
ISSUED: March 28, 2005  
BY: Joseph P. Lacher, President -FL  
Miami, Florida

ACCESS SERVICES TARIFF

Second Revised Page 21  
Cancels First Revised Page 21  
EFFECTIVE: April 12, 2005

**SUBJECT INDEX**

**U.**

**SUBJECT**

**SECTION**

**(DELETED)**

**(D)**

Undertaking of the Company (General Regulations) .....	E2.
Unlawful Use (General Regulations) .....	E2.

BELLSOUTH  
TELECOMMUNICATIONS, INC.  
FLORIDA  
ISSUED: April 13, 2005  
BY: Joseph P. Lacher, President -FL  
Miami, Florida

ACCESS SERVICES TARIFF

Second Revised Page 22  
Cancels First Revised Page 22

EFFECTIVE: April 29, 2005

**SUBJECT INDEX**

V.

**SUBJECT**

**SECTION**

Virtual Access Collocation Cross-Connect Service .....	E13.	(N)
Voice Grade (a.k.a. BellSouth SPA DS0 VG) Service (Dedicated Access Service) .....	E7.3.	

BELLSOUTH  
TELECOMMUNICATIONS, INC.  
FLORIDA  
ISSUED: February 14, 1997  
BY: Joseph P. Lacher, President -FL  
Miami, Florida

ACCESS SERVICES TARIFF

First Revised Page 23  
Cancels Original Page 23  
EFFECTIVE: March 1, 1997

**SUBJECT INDEX**

(T)

W.

**SUBJECT**

**SECTION**

Wideband Service ..... E7.3.  
Wired Music-Program Audio (*a.k.a. BellSouth SPA Program Audio*) ..... E7.2.

(T)

BELLSOUTH  
TELECOMMUNICATIONS, INC.  
FLORIDA  
ISSUED: July 1, 1996  
BY: Joseph P. Lacher, President - FL  
Miami, Florida

ACCESS SERVICE TARIFF

Original Page 24

EFFECTIVE: July 15, 1996

SUBJECT INDEX<sup>1</sup>

(N)

X.

SUBJECT

SECTION

**Note 1:** Text is shown as new due to reissue of all Tariff Sections. No changes in rates or regulations were made with this filing.

BELLSOUTH  
TELECOMMUNICATIONS, INC.  
FLORIDA  
ISSUED: July 1, 1996  
BY: Joseph P. Lacher, President - FL  
Miami, Florida

ACCESS SERVICE TARIFF

Original Page 25

EFFECTIVE: July 15, 1996

SUBJECT INDEX<sup>1</sup>

(N)

Y.

SUBJECT

SECTION

Note 1: Text is shown as new due to reissue of all Tariff Sections. No changes in rates or regulations were made with this filing.



BELLSOUTH  
TELECOMMUNICATIONS, INC.  
FLORIDA  
ISSUED: July 1, 1996  
BY: Joseph P. Lacher, President - FL  
Miami, Florida

ACCESS SERVICE TARIFF

Original Page 26

EFFECTIVE: July 15, 1996

SUBJECT INDEX<sup>1</sup>

(N)

Z.

SUBJECT

SECTION

**Note 1:** Text is shown as new due to reissue of all Tariff Sections. No changes in rates or regulations were made with this filing.

BELLSOUTH  
TELECOMMUNICATIONS, INC.  
FLORIDA  
ISSUED: February 14, 1997  
BY: Joseph P. Lacher, President -FL  
Miami, Florida

ACCESS SERVICES TARIFF

First Revised Page 27  
Cancels Original Page 27

EFFECTIVE: March 1, 1997

**SUBJECT INDEX**

(T)

SUBJECT	NUMERICS	SECTION	
<i>BellSouth SWA</i> 500 Service .....		E6.2	(T)
700 Service Access Code .....		E2.	
<i>BellSouth SWA 8XX Toll Free Dialing Ten Digit Screening</i> Service .....		E6.2	(T)
<i>BellSouth SWA</i> 900 Service .....		E6.2	(T)

EFFECTIVE: July 15, 1996

**E1. APPLICATION OF TARIFF <sup>1</sup>**

(N)

CONTENTS

	New	Old
	Page	Page
<b>E1.1 General</b>	1	1
<b>E1.2 Concurring Carriers</b>	1	1

**Note 1:** Text is shown as new due to reissue of all Tariff Sections. No changes in rates or regulations were made with this filing.

ISSUED: June 21, 2012

EFFECTIVE: June 22, 2012

BY: Marshall M. Criser III, President -FL  
Miami, Florida

## E1. APPLICATION OF TARIFF

### E1.1 General

- A. This Tariff contains regulations, rates and charges applicable to the provision of Carrier Common Line, Carrier Access Capacity, BellSouth SWA, Dedicated Access, BellSouth Expanded Interconnection Service, and other miscellaneous services, hereinafter referred to as service(s), provided by BellSouth Telecommunications, Inc., hereinafter referred to as the Company, to end users, as specified in Sections E2., E4., E6., and E7. following, and to Interexchange Carriers, Resellers and Alternate Operator Service (AOS) providers and, Enhanced Service Providers (as defined in E2.6), Alternative Local Exchange Companies (ALECs) (as defined in E2.6) and 500 Service Providers (as defined in E2.6), any other entity authorized to order service out of this Tariff, hereinafter referred to as IC(s) or ALECs. These services are appropriate for customer use in the provision of interLATA and intraLATA communications.
- B. The provision of such services by the Company as set forth in this Tariff does not constitute a joint undertaking with the IC for the furnishing of any service.
- C. The regulations, rates, and charges contained herein are in addition to the applicable regulations, rates, and charges specified in other tariffs of the Company which are referenced herein.
- D. The Company code for Florida is 5191.

(D)

## E2. GENERAL REGULATIONS

### CONTENTS

<b>E2.1 Undertaking of the Company</b>	1
E2.1.1 Scope	1
E2.1.2 Limitations	1
E2.1.3 Liability	1
E2.1.4 Provision of Services	3
E2.1.5 Installation and Termination of Services	4
E2.1.6 Maintenance of Services	4
E2.1.7 Changes and Substitutions	4
E2.1.8 Refusal and Discontinuance of Service	4
E2.1.9 Quotation Charge	5
E2.1.10 Limitation of Use of Metallic Facilities	5
E2.1.11 Notification of Service-Affecting Activities	6
E2.1.12 Coordination with Respect to Network Contingencies	6
E2.1.13 Provision and Ownership of Telephone Numbers	6
<b>E2.2 Use</b>	6
E2.2.1 Interference or Impairment	6
E2.2.2 Unlawful Use	6
E2.2.3 Use by Others	7
<b>(DELETED)</b>	

(D)

ISSUED: January 4, 2012

EFFECTIVE: January 5, 2012

BY: Marshall M. Criser III, President -FL  
Miami, Florida

## E2. GENERAL REGULATIONS<sup>1</sup>

### CONTENTS

<b>E2.3 Obligations of the IC</b>	7	
E2.3.1 Damages	7	
E2.3.2 Ownership of Facilities and Theft	7	
E2.3.3 Equipment Space and Power	7	
E2.3.4 Proof of Certification	8	
E2.3.5 Reserved for Future Use	8	
E2.3.6 Availability for Testing	8	
E2.3.7 Balance	8	
E2.3.8 Design of IC Services	8	
E2.3.9 References to the Company	8	
E2.3.10 Reserved for Future Use	9	
E2.3.11 Claims and Demands for Damages	9	
E2.3.12 Reserved for Future Use	9	
E2.3.13 Coordination with Respect to Network Contingencies	9	
E2.3.14 Jurisdictional Report Requirements	9	
E2.3.15 Determination of Intrastate Charges for Mixed Interstate and Intrastate Access Service	17	
E2.3.16 Reserved for Future Use	18	
E2.3.17 Reserved for Future Use	18	
E2.3.18 Reserved for Future Use	18	
E2.3.19 800 Number Reporting	18	
E2.3.20 Identification and Rating of VoIP-PSTN Traffic	18	(T)
E2.3.21 Utilization of Alternative Access Providers	18.3	(T)

**Note 1:** Text is shown as new due to reissue of all Tariff Sections. No changes in rates or regulations were made with this filing.

## E2. GENERAL REGULATIONS

### CONTENTS

<b>E2.4 Payment Arrangements and Credit Allowance</b>	18	
E2.4.1 Payment of Rates, Charges and Deposits	18	
E2.4.2 Minimum Periods	23	
E2.4.3 Cancellation of an Order for Service	24	
E2.4.4 Credit Allowance for Service Interruptions	24	
E2.4.5 Provision For Gross Receipts Tax	27	
E2.4.6 Re-establishment of Service Following Fire, Flood or Other Occurrence	27	
E2.4.7 Title or Ownership Rights	28	
E2.4.8 Billing of Access Service Provided By Multiple Companies	28	
E2.4.9 Optional Payment Plan	35	
E2.4.10 Service Installation Guarantee	45	
E2.4.11 <b>Cost Assessment Charge (CAC)</b>	46	(T)
E2.4.12 Reserved for Future Use	46	
E2.4.13 Reserved for Future Use	46	
E2.4.14 Reserved for Future Use	46	
E2.4.15 Reserved for Future Use	46	
E2.4.16 Commitment Guarantee Program	47	(T)
<b>E2.5 Connections</b>	48	
E2.5.1 General	48	

## E2. GENERAL REGULATIONS

### CONTENTS

<b>E2.6</b>	<b>Definitions</b>	48	
<b>E2.7</b>	<b>Special Promotions</b>	65	
E2.7.1	Regulations	65	
E2.7.2	Descriptions	65	
<b>E2.8</b>	<b>Reserved for Future Use</b>	65	
<b>E2.9</b>	<b>Reserved for Future Use</b>	65	
<b>E2.10</b>	<b>Reserved for Future Use</b>	65	
<b>E2.11</b>	<b>Trademarks and Servicemarks Protection</b>	65	
E2.11.1	Use of Trademarks and Servicemarks	65	
<b>E2.12</b>	<b>TDM to IP Transition</b>	66	(N)
E2.121.1	General TDM to IP Transition Provisions	66	(N)



## E2. GENERAL REGULATIONS

(T)

### E2.1 Undertaking of the Company

#### E2.1.1 Scope

- A. The Company does not undertake to transmit messages under this Tariff.
- B. The Company shall be responsible only for the installation, operation and maintenance of the service it provides.
- C. The Company will, for maintenance purposes, test its services only to the extent necessary to detect and/or clear troubles.
- D. Services are provided 24 hours daily, seven days per week except as set forth in other applicable sections of this Tariff.
- E. The Company has the authority to disconnect the end user's service for nonpayment of the IC charges billed to the End User by the Company.
- F. The Company does not warrant that its facilities and services meet standards other than those set forth in this Tariff.

#### E2.1.2 Limitations

- A. The IC may not assign or transfer the use of services provided under this Tariff, except as provided herein. Where there is no interruption of use or relocation of the services, such assignment or transfer may be made to:
  - 1. Another IC, whether an individual, partnership, association or corporation, provided the assignee or transferee assumes all outstanding indebtedness for such services, and the unexpired portion of the minimum period and the termination liability applicable to such services, if any; or
  - 2. A court appointed receiver, trustee or other person acting pursuant to law in bankruptcy, receivership, reorganization, insolvency, liquidation or other similar proceedings, provided the assignee or transferee assumes the unexpired portion of the minimum period and the termination liability applicable to such services, if any.

In all cases of assignment or transfer, the written acknowledgment of the Company is required prior to such assignment or transfer. Such acknowledgment shall be made within 15 days from the receipt of notification. All regulations and conditions contained in this Tariff shall apply to such assignee or transferee.

The assignment or transfer of services does not relieve or discharge the assignor or transferor from remaining jointly or severally liable with the assignee or transferee for any obligations existing at the time of the assignment or transfer.

- B. The use and restoration of services shall be in accordance with Part 64, Subpart D, Appendix A, of the Federal Communications Commission's Rules and Regulations, which specifies the priority system for such activities.
- C. Subject to compliance with the rules mentioned in B. preceding, the services offered herein will be provided to ICs on a first come, first served basis.

#### E2.1.3 Liability

The following liability provisions apply for all services except *BellSouth* Expanded Interconnection Service. Liability provisions for *BellSouth Expanded Interconnection Service* arrangements are contained in Section E20. following.

(T)

EFFECTIVE: July 15, 1996

## E2. GENERAL REGULATIONS<sup>1</sup>

(N)

### E2.1 Undertaking of the Company (Cont'd)

#### E2.1.3 Liability (Cont'd)

- A. The Company's liability, if any, for its willful misconduct is not limited by this Tariff. With respect to any other claim or suit, by an IC, End User or by any others, for damages associated with the installation, provision, preemption, termination, maintenance, repair or restoration of service, and subject to the provisions of B. through H. following, the Company's liability shall not exceed an amount equal to the proportionate charge for the service for the period during which the service was affected. This liability for damages shall be in addition to any amounts that may otherwise be due the IC or End User under this Tariff as a Credit Allowance for a Service Interruption.
- B. The Company shall not be liable for any act or omission of any other carrier or IC providing a portion of a service, nor shall the Company for its own act or omission hold liable any other carrier or IC providing a portion of a service.
- C. The Company is not liable for damages to the IC terminal location or End User's premises resulting from the furnishing of a service, including the installation and removal of equipment and associated wiring, unless the damage is caused by the Company's negligence.
- D. The Company shall be indemnified, defended and held harmless by the End User against any claim, loss or damage arising from the End User's use of services offered under this Tariff, involving:
  1. Claims for libel, slander, invasion of privacy, or infringement of copyright arising from the End User's own communications.
  2. Claims for patent infringement arising from the End User's acts combining or using the service furnished by the Company in connection with facilities or equipment furnished by the IC or End User or;
  3. All other claims arising out of any act or omission of the End User in the course of using services provided pursuant to this Tariff.
- E. The Company shall be indemnified, defended and held harmless by the IC against any claim, loss or damage arising from the IC's use of services offered under this Tariff, involving:
  1. Claims for libel, slander, invasion of privacy, or infringement of copyright arising from the IC's own communications;
  2. Claims for patent infringement arising from the IC's acts combining or using the service furnished by the Company in connection with facilities or equipment furnished by the End User or IC or;
  3. All other claims arising out of an act or omission of the IC in the course of using services provided pursuant to this Tariff.
- F. The Company does not guarantee or make any warranty with respect to its services when used in an explosive atmosphere. The Company shall be indemnified, defended and held harmless by the IC or End User from any and all claims by any person relating to such IC or End User use of services so provided.

**Note 1:** Text is shown as new due to reissue of all Tariff Sections. No changes in rates or regulations were made with this filing.

## E2. GENERAL REGULATIONS

### E2.1 Undertaking of the Company (Cont'd)

#### E2.1.3 Liability (Cont'd)

- G. No license under patents (other than the limited license to use) is granted by the Company or shall be implied or arise by estoppel, with respect to any service offered under this Tariff. The Company will defend the IC or End User against claims of patent infringement arising solely from the use by the IC or End User of services offered under this Tariff and will indemnify such IC or End User for any damages awarded based solely on such claims.
- H. The Company's failure to provide or maintain services under this Tariff shall be excused by labor difficulties, governmental orders, civil commotions, criminal actions taken against the Company, acts of God and other circumstances beyond the Company's reasonable control, subject to the Credit Allowance for a Service Interruption as set forth in E2.4.4 following.
- I. Should any federal, state or local jurisdiction determine that sales, use, gross receipts or any other taxes (including interest, penalties and surcharges thereon) are due by the Company as a result of the Company's purchase of accounts receivable, the Company will advise the IC and the IC shall be liable for any such tax, interest, penalties and surcharge, and the IC shall immediately reimburse the Company the amount of such tax, interest, penalties and surcharge paid by the Company. If the IC disagrees with the Company's determination that any taxes are due by the Company or disagrees with an assessment of any tax, penalty, surcharge and interest due by the Company as a result of the Company's purchase of accounts receivable, the IC shall, at its option and expense (including immediate payments of any such assessment), have the right to seek a ruling as to the inapplicability of any such tax or to protest any assessment and participate in any legal challenge to such assessment, but shall be liable for any tax, penalty, surcharge and interest ultimately determined to be due.

#### J. Unauthorized Computer Intrusion

The Company's liability, if any, for its willful misconduct is not limited by this section of this Tariff. With respect to any other claim or suit by a subscriber, common carrier, reseller, or any other party for damages caused by, or associated with, any unauthorized computer intrusion, including but not limited to the input of damaging information such as a virus, time bomb, any unauthorized access, interference, alteration, destruction, theft of, or tampering with, a Company computer, switch, data, database, software, information, network or other similar system, the Company's liability, if any, shall not exceed an amount equal to the proportionate charge by the Company for the service for the period during which the service provided by the Company was affected or so utilized.

Each subscriber of the Company shall be responsible for providing appropriate security measures to protect the subscriber's computer, data, or telecommunications network.

#### K. Transmission of Data

Voice-grade lines are primarily conditioned to handle data speeds up to 9.6 kilobits per second (kbps). The Company makes no guarantee that voice-grade access lines and/or facilities are suitable for the transmission of data. However, in those cases where the transmission of data is attempted, the Company shall not be held liable for any damage, harm or loss of data caused by the subscriber using the Company's voice-grade telephone access lines and/or facilities for the transmission of data. The Company's liability shall be limited to errors or damages to the transmission of voice messages over these facilities, and the liability shall be limited to an amount equal to the proportionate amount of the Company's billing for the period of service during which the errors or damages occur.

#### L. Errors or Damages Caused by System Date Limitations

The Company's liability for errors or damage resulting from the inability of the Company's systems to process unusual date requirements shall be limited to an amount equal to the proportionate amount of the Company's billing for the period of service during which the errors or damages occur.

#### M. Unauthorized Devices

The Company shall not be liable or responsible for any damage or harm that may occur as the result of unauthorized devices or the failure of the Company to detect unauthorized devices on the subscriber's line.

#### E2.1.4 Provision of Services

- A. The Company, to the extent that such services are or can be made available with reasonable effort, and after provision has been made for the Company's telephone exchange services, will provide to the IC upon reasonable notice services offered in other applicable sections of this Tariff at rates and charges specified therein.
- B. The Company may discontinue certain Company services in geographic areas for which the Company has no customers subscribing to those services. (N)
- C. Unless otherwise specified, service will be provided only to those ICs holding certificates of public convenience and necessity issued by the Florida Public Service Commission. (T)

## E2. GENERAL REGULATIONS

### E2.1 Undertaking of the Company (Cont'd)

#### E2.1.5 Installation and Termination of Services

With the exception of BellSouth Expanded Interconnection Service arrangements, the Access Services provided under this Tariff (a) will include any entrance cable or drop wiring and wire or intrabuilding cable to that point where provision is made for termination of the Company's outside distribution network facilities at a location of minimum penetration inside of the IC terminal location or End User premises and, (b) will be installed by the Company to such point of termination. This point of termination is defined as the Point of Interface at the IC terminal location and the Network Interface at the End User premises.

Provisions addressing BellSouth Expanded Interconnection Service arrangements are contained in Section E20. following.

#### E2.1.6 Maintenance of Services

The services provided under this Tariff shall be maintained by the Company. The IC or others may not rearrange, move, disconnect, remove or attempt to repair any facilities provided by the Company, other than by connection or disconnection to any interface means used, except with the written consent of the Company.

#### E2.1.7 Changes and Substitutions

Except as provided for equipment and systems subject to F.C.C. Part 68 Regulations at 47C.F.R. Section 68-110(b), the Company may, where such action is reasonably required in the operation of its business:

- A. Substitute, change or rearrange any facilities used in providing service under this Tariff, including but not limited to:
  - 1. Substitution of different metallic facilities,
  - 2. Substitution of carrier or derived facilities for metallic facilities used to provide other than metallic facilities, and
  - 3. Substitution of metallic facilities for carrier or derived facilities used to provide other than metallic facilities,
- B. Change minimum protection criteria,
- C. Change operating or maintenance characteristics of facilities, or,
- D. Change operations or procedures of the Company.

In case of any such substitution, change or rearrangement, the transmission parameters will be within the range as set forth in Section 6 of Tariff FCC No. 1 and Section E7. of this intrastate Tariff. The Company shall not be responsible if any such substitution, change or rearrangement renders any IC furnished services obsolete or requires modification or alteration thereof or otherwise affects their use or performance. If such substitution, change or rearrangement materially affects the operating characteristics of the facility, the Company will provide reasonable notification to the IC in writing. Reasonable time will be allowed for any redesign and implementation required by the change in operating characteristics. The Company will work cooperatively with the IC to determine reasonable notification requirements.

(C)

#### E2.1.8 Refusal and Discontinuance of Service

- A. Unless the provisions of E2.2.1.B. or E2.5. following apply, if the IC or End User fails to comply with E2.1.6. preceding or E2.2.2., E2.3.1., E2.3.6., E2.3.7., **E2.3.14.** or E2.4. following, including any payments to be made by it on the dates and times herein specified, the Company may, on thirty (30) *calendar* days written notice *by Certified Mail or Overnight Delivery* to the person designated by the IC or End User to receive such notices of noncompliance, refuse additional applications for service and/or refuse to complete any pending orders for service by the noncomplying IC or End User at any time thereafter. If the Company does not refuse additional applications for service on the date specified in the thirty (30) days notice and the IC's or End User's noncompliance continues, nothing contained herein shall preclude the Company's right to refuse additional applications for service to the noncomplying IC or End User without further notice.

## E2. GENERAL REGULATIONS

### E2.1 Undertaking of the Company (Cont'd)

#### E2.1.8 Refusal and Discontinuance of Service (Cont'd)

- B.** Unless the provisions of E2.2.1.B. or E2.5. following apply, if the IC or End User fails to comply with E2.1.6. preceding or E2.2.2., E2.3.1., E2.3.6., E2.3.7., **E2.3.14.** or E2.4. following, including any payments to be made by it on the dates and times herein specified, the Company may on thirty (30) *calendar* days written notice by **Certified Mail or Overnight Delivery** to the person designated by the IC or End User to receive such notices of noncompliance, discontinue the provision of the services to the noncomplying IC or End User at any time thereafter. In the case of such discontinuance, all applicable charges, including termination charges, shall become due. If the Company does not discontinue the provision of the services involved on the date specified in the thirty (30) days notice, and the IC's or End User's noncompliance continues, nothing contained herein shall preclude the Company's right to discontinue the provision of the services to the noncomplying IC or End User without further notice. (C)
- C.** In addition to and not in limitation of the provisions of E2.1.8.A. and E2.1.8.B. preceding, unless the provisions of E2.2.2.B. or E2.5. following apply, if a customer fails to comply with E2.4.1.A. or with E2.4.1.B.3. following, including any payment to be made by it on the dates and times herein specified, the Company may take actions specified in E2.1.8.A. and E2.1.8.B. on fifteen (15) calendar days written notice, such notice period to start the day after the notice is rendered by Certified Mail or Overnight Delivery, if the customer has not complied with respect to amounts due in a subject bill and either: (N)
1. The Company has within seven (7) business days of the subject bill date: (N)
    - a. Mailed via the United States Postal Service (USPS) to the customer the subject bill in paper or CDROM form, or (N)
    - b. Overnight service delivered to the customer the subject bill in Magnetic Tape form, or (N)
    - c. Electronically Transmitted to the customer the subject bill. (N)The Company will maintain records sufficient to validate the date upon which a subject bill was rendered to the customer. (N)
  2. The Company has rendered the subject bill, using one of the media described in 1. above, to the customer more than thirty (30) calendar days before notice under this section has been rendered. (N)
- In all other cases, the Company will give thirty (30) calendar days written notice pursuant to E2.1.8.A. of E2.1.8.B.. Action will not be taken with regard to the subject bill if the customer cures the noncompliance prior to the expiration of the fifteen (15) or thirty (30) calendar day notice period, as applicable. (N)
- D.** In any event, if evidence is not presented to the Company that the IC has obtained a certificate of public convenience and necessity from the Florida Public Service Commission, the Company will not provide services contained in this Tariff to the IC. (T)
- If at any time after service has been provided to a certified IC, the IC's certificate of public convenience and necessity is revoked by the Florida Public Service Commission, the Company will, on thirty (30) days notice to the person designated by the IC to receive such notices, discontinue the provision of the services to the IC at any time thereafter. In the case of such discontinuance, all applicable charges, including termination charges, shall become due.

#### E2.1.9 Quotation Charge

A nonrecurring charge (USOC QPA) for the preparation of a quotation applies whenever an IC requests an estimate of rates and charges for any service for which the rates and charges are determined on an individual case basis prior to placing an order for service. The charge includes the costs associated with the development and preparation of the quotation. A bill for the quotation preparation will be rendered. The quotation is valid for 90 days and will identify all estimated costs associated with the provision of the facilities needed to satisfy the IC's service requirements. Within this 90 day period, if the IC orders the service as quoted and service is subsequently provided, the Quotation Charge will be credited to the IC's account. If the IC cancels the request for a quotation prior to its completion, the IC will be billed for the costs incurred, for quotation preparation, through the cancellation date.

#### E2.1.10 Limitation of Use of Metallic Facilities

Signals applied to the metallic facility shall conform to the limitations set forth in Technical Reference Publication AS No. 1. In the case of application of de telegraph signaling systems, the IC shall be responsible, at its expense, for the provision of current limiting devices to protect the Company facilities from excessive current due to abnormal conditions and for the provision of noise mitigation networks when required to reduce excessive noise.

ISSUED: May 19, 2000  
BY: Joseph P. Lacher, President -FL  
Miami, Florida

EFFECTIVE: June 18, 2000

## **E2. GENERAL REGULATIONS**

### **E2.1 Undertaking of the Company (Cont'd)**

#### **E2.1.11 Notification of Service-Affecting Activities**

The Company will provide the IC reasonable notification of service-affecting activities that may occur in normal operation of its business. Such activities may include, but are not limited to, equipment or facilities additions, removals or rearrangements, routine preventative maintenance and major switching machine change-out. Generally, such activities are not individual IC service specific, they affect many IC services. No specific advance notification period is applicable to all service activities. The Company will work cooperatively with the IC to determine reasonable notification requirements.

#### **E2.1.12 Coordination with Respect to Network Contingencies**

The Company intends to work cooperatively with the IC to develop network contingency plans in order to maintain maximum network capability following natural or man-made disasters which affect telecommunications services.

This includes developing plans for originating or terminating traffic associated with mass calling events directed to end users served from specific end offices. Where it is determined that such non-random calling generates problems on the Telephone Company's Common Transport network, the Telephone Company will work cooperatively with the customer to relieve the traffic congestion. Remedial measures may include isolation of the customer from the Telephone Company network in the impacted area for the duration of the problem or until the customer notifies the Telephone Company that the problem has been resolved. (N)

#### **E2.1.13 Provision and Ownership of Telephone Numbers**

The Company reserves the reasonable right to assign, designate or change telephone numbers, any other call number designations associated with Access Service, or the Company serving central office prefixes associated with such numbers, when necessary in the conduct of its business. Should it become necessary to make a change in such number(s), the Company will furnish to the IC or End User 6 months notice, in writing of the effective date and an explanation of the reason(s) for such change(s).

### **E2.2 Use**

#### **E2.2.1 Interference or Impairment**

- A. The characteristics and methods of operation of any circuits, facilities or equipment provided by other than the Company and associated with the facilities utilized to provide services under this Tariff shall not interfere with or impair service over any facilities of the Company, its affiliated companies, or its connecting and concurring carriers involved in its services, cause damage to their plant, impair the privacy of any communications carried over their facilities or create hazards to the employees of any of them or the public.
- B. Except as provided for equipment or systems subject to the FCC Part 68 Rules in 47C.F.R. Section 68.108, if such characteristics or methods of operation are not in accordance with A. preceding, the Company will, where practicable, notify the IC or End User that temporary discontinuance of the use of a service may be required; however, where prior notice is not practicable, nothing contained herein shall be deemed to preclude the Company's right to temporarily discontinue forthwith the use of a service if such action is reasonable under the circumstances. In case of such temporary discontinuance, the IC or End User will be promptly notified and afforded the opportunity to correct the condition which gave rise to the temporary discontinuance. During such period of temporary discontinuance, credit allowance for service interruptions as set forth in E2.4.4.A and B. following is not applicable.

#### **E2.2.2 Unlawful Use**

The service provided under this Tariff shall not be used for an unlawful purpose.

## E2. GENERAL REGULATIONS

### E2.2 Use (Cont'd)

#### E2.2.3 Use by Others

- A. Any entity intending to resell private line services must be certificated by the Florida Public Service Commission as an Alternative Access Vendor (AAV) for intraexchange services, and as an AAV or Interexchange Carrier (IC) for interexchange services. Those entities certificated as an AAV or IC may resell private line services only by purchasing the like service from Section E7., Dedicated Access Services, of the Company's intrastate Access Service Tariff. Any entity certificated as an AAV or IC may purchase and resell a Local Exchange Company's (LEC's) private line service only between affiliated entities.
- B. Alternative Access Vendors (AAVs) can resell a special access service which is part of a dedicated interexchange private line between affiliates, and a special access service to an ICs switched network without affiliate restriction. In addition, an IC can resell an interexchange private line service under its existing IC certificate with no affiliate restriction, provided the LEC provides the local channel (LC) on each end of the private line service. However, if an IC utilizes an AAV to provide the LCs, the affiliate restrictions will apply.

(DELETED)

(D)

### E2.3 Obligations of the IC

#### E2.3.1 Damages

The IC shall reimburse the Company for damages to Company facilities utilized to provide services under this Tariff caused by the negligence or willful act of the IC or an End User or resulting from the IC's or an End User's improper use of the Company facilities, or due to malfunction of any facilities or equipment provided by other than the Company. Nothing in the foregoing provision shall be interpreted to hold one IC or End User liable for another IC's or End User's actions. The Company will, upon reimbursement for damages, cooperate with the IC in prosecuting a claim against the person causing such damage and the IC shall be subrogated to the right of recovery by the Company for the damages to the extent of such payment.

#### E2.3.2 Ownership of Facilities and Theft

Facilities utilized by the Company to provide service under the provisions of this Tariff shall remain the property of the Company. Such facilities shall be returned to the Company by the IC or end user, whenever requested, within a reasonable period following the request in as good condition as reasonable wear will permit.

#### E2.3.3 Equipment Space and Power

The IC shall furnish or arrange to have furnished to the Company, at no charge, equipment space and electrical power required by the Company to provide services under this Tariff at the points of termination of such services. The selection of ac or dc power shall be mutually agreed to by the IC and the Company. The IC shall also make necessary arrangements in order that the Company will have access to such spaces at reasonable times for installing, testing, repairing or removing Company services.

## E2. GENERAL REGULATIONS

### E2.3 Obligations of the IC (Cont'd)

#### E2.3.4 Proof of Certification

- A. When an IC places an order with the Company for services provided in this Tariff, the IC shall be responsible for furnishing to the Company, at the time the service is requested, proof that the IC has obtained or is in the process of obtaining a certificate of public convenience and necessity from the Florida Public Service Commission. Unless this proof as described is presented to the Company, the IC's request for service will not be processed.
- B. If at the time service was requested, the IC had not obtained a certificate of public convenience and necessity from the Florida Public Service Commission, the IC must furnish to the Company on or before the date service is to be provided proof that a certificate has been issued to the IC by the Florida Public Service Commission. If the IC fails to provide proof of certification to the Company, service will not be provided.
- C. When an End User places an order with the Company for *BellSouth SWA FGB* service provided in this Tariff, the End User shall be responsible for furnishing to the Company, at the time the service is requested, proof through a letter of certification to the Company that the *BellSouth SWA FGB* service as ordered by the End User is to provide intrastate telecommunications services for its own use. *BellSouth SWA FGB* service to End Users cannot be resold and is only available where facilities permit.

#### E2.3.5 Reserved for Future Use

#### E2.3.6 Availability for Testing

The services provided under this Tariff shall be available to the Company at times mutually agreed upon in order to permit the Company to make tests and adjustments appropriate for maintaining the services in satisfactory operating condition. Such tests and adjustments shall be completed within a reasonable time. No credit will be allowed for any interruptions involved during such tests and adjustments.

#### E2.3.7 Balance

All signals for transmission over the services provided under this Tariff shall be delivered by the IC balanced to ground except for ground start, duplex (DX) and McCulloh-Loop (Alarm System) type signaling and dc telegraph transmission at speeds of 75 baud or less.

#### E2.3.8 Design of IC Services

Subject to the provisions of E2.1.7 preceding, the IC shall be solely responsible, at its own expense, for the overall design of its services and for any redesigning or rearrangement of its services which may be required because of changes in facilities, operations or procedures of the Company, minimum protection criteria or operating or maintenance characteristics of the facilities.

#### E2.3.9 References to the Company

The IC may advise the end user that certain services are provided by the Company in connection with the service the IC furnishes to its end users; however, the IC shall not represent that the Company jointly participates in the IC's services.



## E2. GENERAL REGULATIONS

### E2.3 Obligations of the IC (Cont'd)

#### E2.3.10 Reserved for Future Use

#### E2.3.11 Claims and Demands for Damages

- A. With respect to claims of patent infringement made by third persons, the IC shall defend, indemnify, protect and save harmless the Company from and against all claims arising out of the combining with, or use in connection with, the services provided under this Tariff, any circuit, apparatus, system or method provided by the IC or end users.
- B. The IC shall defend, indemnify and save harmless the Company from and against any suits, claims, losses or demands, including punitive damages, attorney fees and court costs by third persons arising out of the construction, installation, operation, maintenance, or removal of the IC's circuits, facilities, or equipment connected to the Company's services provided under this Tariff including, without limitation, Workmen's Compensation claims, actions for infringement of copyright and/or unauthorized use of program material, libel and slander actions based on the content of communications transmitted over the IC's circuits, facilities or equipment, and proceedings to recover taxes, fines, or penalties for failure of the IC to obtain or maintain in effect any necessary certificates, permits, licenses, or other authority to acquire or operate the services provided under this Tariff; provided, however, the foregoing indemnification shall not apply to suits, claims, and demands to recover damages for damage to property, death, or personal injury unless such suits, claims or demands are based on the tortious conduct of the IC, its officers, agents or employees.

#### E2.3.12 Reserved for Future Use

#### E2.3.13 Coordination with Respect to Network Contingencies

The IC shall, in cooperation with the Company, coordinate in planning the actions to be taken to maintain maximum network capability following natural or man-made disasters, which affect telecommunications services.

#### E2.3.14 Jurisdictional Report Requirements<sup>1</sup>

##### A. Jurisdictional Reports

##### 1. Percent Interstate Usage (PIU)

- a. When the Company receives sufficient call detail to permit it to determine the jurisdiction of originating and terminating access minutes of use or messages the Company will bill according to these actual minutes of use or messages and will not use customer reported Percent Interstate Usage (PIU) factors. The Company developed percent intrastate usage for access minutes will be determined at a statewide level.

The intrastate percentage will be developed on a monthly basis by end office when the access minutes are measured by dividing the measured intrastate originating or terminating access minutes (the access minutes where the calling number is in one state and the called number is in another state) by the total originating or terminating access minutes.

The Company will bill according to actual measured minutes of use or messages for all services listed in b. and 5. following, with the exception of those listed:

- BellSouth SWA Local Channel
- BellSouth SWA Dedicated Interoffice Channel
- BellSouth SWA Billing Name and Address
- 
- BellSouth Operator Assistance Access Service
- Channelization Equipment
- DNALs<sup>2</sup> associated with BellSouth SWA LSBSA

**Note 1:** Except where indicated herein, references to BellSouth SWA FGs will also include the applicable BellSouth SWA Basic Serving Arrangement as detailed in the matrix in Section 6.1.3 of Tariff FCC No. 1 (e.g., the term BellSouth SWA FGA represents both BellSouth SWA FGA and BellSouth SWA LSBSA).

**Note 2:** Where BellSouth SWA LSBSA is provisioned with a DNAL, the DNAL rates should be apportioned between interstate and intrastate using the same PIU factor as applied to the associated BellSouth SWA LSBSA.

(D)

## E2. GENERAL REGULATIONS

### E2.3 Obligations of the IC (Cont'd)

#### E2.3.14 Jurisdictional Report Requirements<sup>1</sup> (Cont'd)

##### A. Jurisdictional Reports (Cont'd)

##### 1. Percent Interstate Usage (PIU) (Cont'd)

##### a. (Cont'd)

Where the Company receives insufficient call detail to identify the calling station to determine the jurisdiction, the Company will charge the applicable rates for terminating BellSouth SWA as set forth in this Tariff. There may be a percentage of usage where it is not possible to know, and therefore to send to BellSouth, the needed originating information. Accordingly, BellSouth will charge the terminating BellSouth SWA rate for only those minutes lacking originating information from all SWA customers, currently 7.00 percent (%) (the "floor"). *A 2.00 percent (%) grace threshold will be granted in conjunction with the floor. When the percentage of the carrier's traffic without the sufficient call detail to determine jurisdiction does not exceed the sum of the floor plus the grace threshold, or 9.00 percent (%), BellSouth will not apply the provisions of this tariff. When the percentage is greater than 9.00 percent (%), BellSouth will exercise the provisions of this tariff.* For example, if 30 percent (%) of a customer's minutes sent to BellSouth do not contain sufficient originating information to allow BellSouth to determine the originating location, then BellSouth would apply the provisions of this tariff to those minutes exceeding the "floor", or 23.00 percent (%) in this example.

BellSouth may recalculate the overall SWA customer average "floor" quarterly. In addition, subsequent reviews or audits of specific customer usage may result in a new "floor" for that customer.

In the event that BellSouth applies the intrastate terminating access rate to calls without the Calling Party Number as provided in this tariff, BellSouth's access customers will have the opportunity to request backup documentation of BellSouth's basis for such application, and further request that BellSouth change the application of the intrastate access rate upon a showing of why the intrastate rate should not be applied.

For the purpose of this tariff, where the customer is a third-party provider of CCS7 services to its customers ("Third Party Customers"), the customer will develop its projected PIU factor based upon a weighted average of the PIUs of its Third Party Customers' end-user traffic in accordance with the procedures described below. A Third Party Customer may elect to have the Company determine the weighted PIU and in so doing the CCS7 provider shall name and identify their third party customers. In the event a Third Party Customer does not provide a projected PIU or does not elect to have the Company determine the PIU, a 50 percent PIU will be utilized for that Third Party Customer until such time as the Company obtains sufficient data to develop the PIU as specified in b. following.

The IC will provide in its initial order the projected Percent Interstate Usage (PIU) at a statewide level on a local exchange company specific basis. When the IC and/or End User computes the PIU, it will subtract the developed percentage from 100 and the difference is the percent intrastate usage. The sum of the interstate and intrastate percentage will equal 100 percent. A PIU of less than 100 percent is not allowed where the service is not available as an intrastate access service. The projected PIU may include up to two decimals.

The intrastate usage is to be developed as though every call that originates from a calling location within the same state as that in which the called station is situated is an intrastate communication and every call for which the originating location is in a state other than that where the called station is situated is an interstate communication. The manner in which the call is routed through the telecommunications network does not affect the jurisdiction of a call, i.e., a call between two points within the same state is an intrastate communication even if the call is routed through another state.

The Company will designate the number obtained by subtracting the intrastate percentage furnished by the IC from 100 (100 - customer percentage = interstate percentage) as the projected interstate percentage of use.

**Note 1:** Except where indicated herein, references to BellSouth SWA FGs will also include the applicable BellSouth SWA Basic Serving Arrangement as detailed in the matrix in Section 6.1.3 of Tariff FCC No. 1 (e.g., the term BellSouth SWA FGA represents both BellSouth SWA FGA and BellSouth SWA LSBSA).

(C)  
(C)

ISSUED: May 31, 2013

EFFECTIVE: July 2, 2013

BY: Marshall M. Criser III, President -FL  
Miami, Florida

## E2. GENERAL REGULATIONS

### E2.3 Obligations of the IC (Cont'd)

#### E2.3.14 Jurisdictional Report Requirements<sup>1</sup> (Cont'd)

A. Jurisdictional Reports (Cont'd)

1. Percent Interstate Usage (PIU) (Cont'd)

- b. When an IC initially orders service(s), as defined in the following, the IC will state in its order the Percent Interstate Usage (PIU) separately for each, as set forth in a. preceding.

- BellSouth SWA FGA
- BellSouth SWA FGB
- BellSouth SWA FGD
- BellSouth SW 500 Service
- 700 Service
- BellSouth SWA 8XX Toll Free Dialing Ten Digit Screening Service
- BellSouth SWA 900 Service

**Note 1:** Except where indicated herein, references to BellSouth SWA FGs will also include the applicable BellSouth SWA Basic Serving Arrangement as detailed in the matrix in Section 6.1.3 of Tariff FCC No. 1 (e.g., the term BellSouth SWA FGA represents both BellSouth SWA FGA and BellSouth SWA LSBSA).

(C)  
(C)

## E2. GENERAL REGULATIONS

### E2.3 Obligations of the IC (Cont'd)

#### E2.3.14 Jurisdictional Report Requirements<sup>1</sup> (Cont'd)

##### A. Jurisdictional Reports (Cont'd)

##### 1. Percent Interstate Usage (Cont'd)

##### b. (Cont'd)

- Switched Local Channel
- BellSouth SWA Dedicated Interoffice Channel
- BellSouth SWA Dedicated Interoffice Channel
- Channelization Equipment
- DNALs associated with BellSouth SWA LSBSA<sup>2</sup>
- BellSouth Billing Name and Address
- 
- BellSouth Operator Assistance Access Service

(D)

#### **(DELETED)**

When an End User initially orders BellSouth SWA FGB service, where facilities permit, the End User will state in the order, the PIU for each state.

The Percent Interstate Usage (PIU) factors associated with BellSouth SWA FGA, BellSouth SWA FGB, BellSouth SWA FGD and BellSouth SWA 500, 700, BellSouth SWA 8XX Toll Free Dialing Ten Digit Screening and BellSouth SWA 900 service will also apply to all associated elements and services, e.g. Carrier Common Line, Local Switching, BellSouth SWA Common Interoffice Channel, Interconnection, Access Tandem Switching, Common Trunk Port Service and minute of use based multiplexer rate elements, where applicable.

The PIU category, BellSouth SWA Local Channel, includes Dedicated End Office Trunk Port Service and Dedicated Tandem Trunk Port Service charges and other flat rated charges not specifically covered by other PIU categories.

The customer will provide a single factor as the projected Percent Interstate Usage (PIU) to apportion the usage between interstate and intrastate. This factor will be applied to the following categories:

- BellSouth SWA Local Channel
- BellSouth SWA Dedicated Interoffice Channel
- Channelization Equipment

The PIU factor provided for each of the foregoing facilities categories (Switched Local Channel, BellSouth SWA Dedicated Interoffice Channel and Channelization Equipment) will reflect the combination of all traffic types which traverse such facility category.

When Dedicated Access service is provided on a BellSouth SWA facility, e.g., Dedicated Access DS1 (a.k.a. BellSouth SPA DS1) on a BellSouth SWA DS3, the facility will be apportioned between BellSouth SWA and Dedicated Access. The jurisdiction of the Dedicated Access service shall reflect the composite of the jurisdiction of the lower capacity services, if any, of which it is comprised.

The IC and/or End User shall compute the PIU using the following formula (rounded to a whole percentage).

$$\frac{\text{Total Interstate Originating Minutes}}{\text{Total Interstate Terminating Minutes}} + \frac{\text{Total Interstate Terminating Minutes}}{\text{Total Interstate Originating Minutes}}$$

$$\frac{\text{Total Originating Minutes}}{\text{Total Terminating Minutes}} + \frac{\text{Total Terminating Minutes}}{\text{Total Originating Minutes}}$$

**Note 1:** Except where indicated herein, references to BellSouth SWA FGs will also include the applicable BellSouth SWA Basic Serving Arrangement as detailed in the matrix in Section 6.1.3 of Tariff FCC No. 1 (e.g., the term BellSouth SWA FGA represents both BellSouth SWA FGA and BellSouth SWA LSBSA).

**Note 2:** Where BellSouth SWA LSBSA is provisioned with a DNAL, the DNAL rates should be apportioned between interstate and intrastate using the same PIU factor as applied to the associated BellSouth SWA LSBSA.

BELLSOUTH  
TELECOMMUNICATIONS, INC.  
FLORIDA

ISSUED: July 17, 2000  
BY: Joseph P. Lacher, President -FL  
Miami, Florida

ACCESS SERVICES TARIFF

Third Revised Page 12  
Cancels Second Revised Page 12

EFFECTIVE: **AUG 02 21**

## **E2. GENERAL REGULATIONS**

### **E2.3 Obligations of the IC (Cont'd)**

#### **E2.3E2.3.14 Jurisdictional Report Requirements (Cont'd)**

##### **A. Jurisdictional Reports (Cont'd)**

(T)

## E2. GENERAL REGULATIONS

### E2.3 Obligations of the IC (Cont'd)

#### E2.3.14 Jurisdictional Report Requirements<sup>1</sup> (Cont'd)

##### A. Jurisdictional Reports (Cont'd)

2. For BellSouth Directory Assistance Access service, the Company developed PIU for BellSouth SWA FGD terminating will apply.
3. **(DELETED)**
4. **(DELETED)**

Effective October 1, 2000, the customer will provide a single factor as the projected Percent Interstate Usage (PIU) to apportion the usage between interstate and intrastate. This PIU will apply to the following categories: BellSouth SWA Local Channel, BellSouth SWA Dedicated Interoffice Channel and Channelization Equipment.

Effective July 1, 2000, the customer's and/or end user's projected Percent Interstate Usage (PIU) will be provided at a statewide level on a local exchange company specific basis.

Effective on the first of January, April, July and October of each year the IC will update the interstate and intrastate jurisdictional report. End Users must update the jurisdictional report on a quarterly basis for the Feature Group B services provided from this Tariff. The IC will forward to the Company, to be received no later than 30 days after the first of each such month, a revised report or letter for all services showing the intrastate percentage of use for the past three months ending the last day of December, March, June and September, respectively, for each service arranged for intrastate use. The revised report or letter will serve as the basis for the next three months' billing and will be effective on the bill date for that service. If the IC or End User does not supply an updated quarterly report or letter, the Company will assume the percentages to be the same PIU provided in the last quarterly report or letter accepted by the Company. For those cases in which quarterly reports have never been received from the IC or End User, the Company will assume the PIU factors to be the most recent audit results or to be the same as those provided in the order for services if no audit has been performed. If an audit has been completed and an updated quarterly report or letter has not been submitted subsequent to the audit, the Company will assume the PIU factors to be the most recent audited results.

5. When mixed interstate and intrastate Dedicated Access Service is provided, the jurisdiction will be determined as follows.
  - If the IC or End User's estimate of the interstate traffic on the service involved constitutes 10 percent or less of the total traffic on that service, the service will be provided in accordance with the applicable rules and regulations of this Tariff.

**Note 1:** Except where indicated herein, references to BellSouth SWA FGs will also include the applicable BellSouth SWA Basic Serving Arrangement as detailed in the matrix in Section 6.1.3 of Tariff FCC No. 1 (e.g., the term BellSouth SWA FGA represents both BellSouth SWA FGA and BellSouth SWA LSBSA).

(C)  
(C)

## E2. GENERAL REGULATIONS

### E2.3 Obligations of the IC (Cont'd)

#### E2.3.14 Jurisdictional Report Requirements<sup>1</sup> (Cont'd)

##### A. Jurisdictional Reports (Cont'd)

5. When mixed interstate and intrastate Dedicated Access Service is provided, the jurisdiction will be determined as follows. (Cont'd)
  - If the IC or End User's estimate of the interstate traffic on the service involved constitutes more than 10 percent of the total traffic on that service, the service will be provided in accordance with the applicable rules and regulations of Tariff FCC No. 1.

The IC or End User shall keep records from which the percentage of interstate and intrastate use was estimated and upon request of the Company make the records available for inspection as reasonably necessary for purposes of verification of the percentages. The IC or End User shall supply the data within 30 days of the Company request. (D)

##### B. Jurisdictional Report Verification

1. When an IC or End User provides a projected interstate usage percent as set forth in A. preceding, or when a billing dispute arises or a regulatory commission questions the projected interstate percentage for BellSouth SWA, the Company may, by written request, require the IC or End User to provide the data the IC or End User used to determine the projected interstate percentage. This written request will be considered the initiation of the audit. The IC or End User shall supply the data to an independent auditor within thirty days of the Company request. The IC or End User shall keep records of call detail from which the percentage of interstate and intrastate use can be ascertained as set forth in C. following and upon request of the Company make the records available for inspection at an agreed upon location during normal business hours as reasonably necessary for purposes of verification of the percentages. The Company will audit data from one quarter unless a longer period is requested by the IC or End User and agreed to by the Company. Changes to the reported PIU will not be made for the test period. If the IC or End User does not provide the requested data to the Company or independent auditor within (30) days of the notice of audit, the IC or End User will be in violation of this Tariff and subject to E2.1.8 of this Tariff.

Where attempts to obtain the appropriate data from the IC or End User beyond the 30-day time limit have failed, the Company may provide such documentation to the FPSC as an indication of the IC or End User being in violation of this Tariff.

2. For BellSouth SWA service, verification audits may be conducted no more frequently than once per year except in extreme circumstances. The Company and IC or End User will attempt to limit the audit to a reasonable time to effectively complete the audit. The Company and IC or End User shall respond promptly to requests generated during the audit to ensure timely completion of the audit.

**Note 1:** Except where indicated herein, references to BellSouth SWA FGs will also include the applicable BellSouth SWA Basic Serving Arrangement as detailed in the matrix in Section 6.1.3 of Tariff FCC No. 1 (e.g., the term BellSouth SWA FGA represents both BellSouth SWA FGA and BellSouth SWA LSBSA). (C)  
(C)

## E2. GENERAL REGULATIONS

### E2.3 Obligations of the IC (Cont'd)

#### E2.3.14 Jurisdictional Report Requirements<sup>1</sup> (Cont'd)

##### B. Jurisdictional Report Verification (Cont'd)

3. Audits may be conducted by an independent auditor under contract to the Company; (b) a mutually agreed upon independent auditor; or (c) an independent auditor selected and paid for by the IC or End user. If the IC or End User selects option (c), where it pays for its own independent audit, the selected auditor must certify that the audit was performed following FCC procedures for measuring interstate and intrastate traffic as established by Commission orders, and provide to the Company a report with supporting documentation to verify such procedures. In the event that the IC's auditor is agreed upon to perform the audit, the auditor shall produce an attestation audit report upon completion of the audit.

When an auditor cannot be agreed upon within 30 days by one of the three options above, the Joint LEC Audit Committee's auditor shall perform the audit.

4. If a billing dispute arises or a regulatory commission questions the projected interstate percentage for Dedicated Access Service, the Company will ask the IC or End User to provide the data the IC or End User uses to determine the projected interstate percentage. The IC or End User shall supply the data to an independent auditor within thirty days of the Company request. The IC or End User shall keep records from which the percentage was determined and upon request of the Company make the records available for inspection as reasonably necessary for purposes of verification of the percentages.

Where an independent auditor cannot be agreed upon within 30 days the IC or End User shall supply the data to the Joint LEC Audit Committee's auditor. If the IC or End User does not comply within the 30 day time frame, the FPSC shall be notified and provided with all documentation substantiating requests made by the Company.

##### C. Maintenance of IC Records

1. The IC, Reseller, End User and AOS provider shall retain for a minimum of six (6) months call detail records, that substantiate the percentage data provided to the Company as set forth in A. preceding for *BellSouth SWA* service. Such records shall consist of one of a. and b. (if applicable), following:
  - a. All call detail records, such as workpapers and/or backup documentation including paper, magnetic tapes or any other form of records for billed IC or End User traffic, call information including call terminating address (i.e., called number), the call duration, all originating and terminating trunk groups or access lines over which the call is routed, and the point at which the call enters the IC or End User's network; and
  - b. If the IC has a mechanized system in place that calculated the PIU, then a description of that system and the methodology used to calculate the PIU must be furnished and any other pertinent information (such as but not limited to flowcharts, source code, etc.) relating to such system must also be made available.

**Note 1:** Except where indicated herein, references to *BellSouth SWA FGs* will also include the applicable *BellSouth SWA* Basic Serving Arrangement as detailed in the matrix in Section 6.1.3 of Tariff FCC No. 1 (e.g., the term *BellSouth SWA* FGA represents both *BellSouth SWA* FGA and *BellSouth SWA* LSBSA).

(C)  
(C)



ISSUED: May 31, 2013

EFFECTIVE: July 2, 2013

BY: Marshall M. Criser III, President -FL  
Miami, Florida

## E2. GENERAL REGULATIONS

### E2.3 Obligations of the IC (Cont'd)

#### E2.3.14 Jurisdictional Report Requirements<sup>1</sup> (Cont'd)

##### C. Maintenance of IC Records (Cont'd)

2. Correspondence between the Company and the IC or End User shall be limited to Certified U.S. Mail for the following: Audit Results, Choice of Auditor and Choice of Test Period. Response times by the parties shall be limited to the following: Audit Results-30 days, Choice of Auditor-30 days and Choice of Test Period-10 business days. In the absence of a response within these time frames, concurrence will be assumed on the contents of such correspondence, where applicable.

##### D. Audit Results for *BellSouth SWA*

1. Audit results will be furnished to the IC or End User via Certified U.S. Mail (return receipt requested.) The Company will adjust the IC or End User's PIU based upon the audit results. The PIU resulting from the audit shall be applied to the usage for the quarter the audit was completed, the usage for the quarter prior to completion of the audit, and to the usage for the two (2) quarters following the completion of the audit. After that time, the IC or End User may report a revised PIU pursuant to A. preceding. If the revised PIU submitted by the IC or End User represents a deviation of five percentage points or more from the audited PIU, and that deviation is not due to identifiable reasons, the provisions in B. preceding will be applied.
2. Both credit and debit adjustments will be made to the IC or End User's interstate and intrastate access charges for the specified period to accurately reflect the usage for the IC or End User's account consistent with E2.4.1 following.
3. If, as a result of an audit conducted by an independent auditor under contract to the Company, an IC or End User is found to have over stated the PIU by twenty percentage points or more, the Company shall require reimbursement from the IC or End User for the cost of the audit. The mutually agreed upon auditor will be paid for by the IC or End User. Such bill(s) shall be due and paid in immediately available funds thirty days from receipt and shall carry a late payment penalty as set forth in E2.4.1 following. If, after the 30 days, payment is not received from the IC or End User, all documentation that demonstrates attempts to collect the cost of the audit shall be turned over to the FPSC.

##### E. Contested Audits

1. When a PIU audit is conducted by an independent auditor selected by the Company, the audit results will be furnished to the IC or End User by Certified U.S. Mail (return receipt requested). The IC or End User may contest the audit results based on substantive cause by providing written notification, by Certified U.S. Mail (return receipt requested), to the Company within thirty (30) calendar days from the date the audit report is furnished to the IC or End User by Certified U.S. Mail. When a PIU audit is conducted by an independent auditor selected by the IC or End User, the audit results will be furnished to the Company by Certified U.S. Mail (return receipt requested). The Company may contest the audit results by providing written notification, by Certified U.S. Mail (return receipt requested), to the IC or End User within thirty (30) calendar days from the date the audit report is furnished to the Company by Certified U.S. Mail.

**Note 1:** Except where indicated herein, references to *BellSouth SWA* Feature Groups will also include the applicable *BellSouth SWA* Basic Serving Arrangement as detailed in the matrix in Section 6.1.3 of Tariff FCC No. 1 (e.g., the term *BellSouth SWA* FGA represents both *BellSouth SWA* FGA and *BellSouth SWA* LSBSA).

(C)

ISSUED: May 31, 2013

EFFECTIVE: July 2, 2013

BY: Marshall M. Criser III, President -FL  
Miami, Florida

## E2. GENERAL REGULATIONS

### E2.3 Obligations of the IC (Cont'd)

#### E2.3.14 Jurisdictional Report Requirements<sup>1</sup> (Cont'd)

##### E. Contested Audits (Cont'd)

2. Contested audits may be resolved by a neutral arbitrator mutually agreed upon by the Company and the IC or End User. Arbitration is an option provided in addition to the IC or End User's existing right to file a complaint or legal action in a court of law or at the Commission for resolution of the dispute. The arbitration hearing will be conducted in a state or location within the Company operating territory where the IC or End User maintains a principle or significant presence as mutually agreed upon by both parties, or a state and location within the Company operating territory that is mutually agreed upon by both parties. The arbitration proceeding shall be governed by the law (both statutory and case) of the state in which the arbitration hearing is held, including, but not limited to, the Uniform Arbitration Act, as adopted in that state. The arbitration shall determine the IC or End User's PIU based on A. preceding.
3. Prior to the arbitration hearing, each party shall notify the arbitrator of the PIU percentage which that party believes to be correct. The arbitrator, in deciding, may adopt the PIU percentage of either party or may adopt a PIU percentage different from those proposed by the parties. If the arbitrator adopts a PIU percentage proposed by one of the parties, the other party (whose PIU percentage was not adopted) shall pay all costs of the arbitration. If the arbitrator adopts a PIU percentage higher than either of the PIU percentages proposed by the parties, then the party proposing the lower PIU percentage shall pay all costs of the arbitration. If the arbitrator adopts a PIU percentage lower than either of the PIU percentages proposed by the parties, then the party proposing the higher PIU percentage shall pay all costs of the arbitration. If the arbitrator adopts a PIU percentage which falls between the two percentages adopted by the parties, then the parties shall each pay one-half of the arbitration costs.
4. Absent written notification, within the time frame noted above, the IC or End User must comply with the provisions set forth in D. preceding. If the IC or End User fails to comply with these provisions, the Company may refuse additional applications for service and/or refuse to complete any and all pending orders for service or may discontinue the provision of the services to the IC or End User as specified in E2.1.8 preceding.
5. The FPSC shall be notified and given all documentation that substantiates the IC or End User non-payment.

#### E2.3.15 Determination of Intrastate Charges for Mixed Interstate and Intrastate BellSouth SWA Service

- A. When mixed interstate and intrastate BellSouth SWA service is provided, all charges (i.e., nonrecurring, monthly and/or usage) including optional feature and Basic Service Element (BSE) charges, will be prorated between interstate and intrastate. The percentage provided in the reports as set forth in E2.3.14.A preceding will serve as the basis for prorating the charges. The intrastate percentage will change as revised jurisdictional reports are submitted. The percentage of a BellSouth SWA service to be charged as intrastate is applied in the following manner:

**Note 1:** Except where indicated herein, references to *BellSouth SWA FGs* will also include the applicable *BellSouth SWA* Basic Serving Arrangement as detailed in the matrix in Section 6.1.3 of Tariff FCC No. 1 (e.g., the term *BellSouth SWA* FGA represents both *BellSouth SWA* FGA and *BellSouth SWA* LSBSA).

(C)  
(C)

## E2. GENERAL REGULATIONS

### E2.3 Obligations of the IC (Cont'd)

#### E2.3.15 Determination of Intrastate Charges for Mixed Interstate and Intrastate BellSouth SWA Service (Cont'd)

##### A. (Cont'd)

1. For monthly and nonrecurring chargeable rate elements, multiply the percent intrastate use times the quantity of chargeable elements times the stated tariff rate per element.
2. For usage sensitive (i.e., access minutes and calls) chargeable rate elements, multiply the percent intrastate use times the actual use (i.e., measured or Company assumed average use) times the stated tariff rate.

#### E2.3.16 Reserved for Future Use

#### E2.3.17 Reserved for Future Use

#### E2.3.18 Reserved for Future Use

#### E2.3.19 800 Number Reporting

For *BellSouth SWA 8XX Toll Free Dialing* Ten Digit Screening service, the IC will be responsible for reporting to the Company or directly to the Service Management System 800 numbers that are in service in the Company serving area and the activation date of every 800 number assigned.

Additionally, the provision of *BellSouth SWA 8XX Toll Free Dialing* Ten Digit Screening service, provided from Section 6 of Tariff FCC No. 1 requires the IC's subscription to basic *BellSouth 8XX Toll Free Dialing* Number *Administration* service features found in Section E13. of this Tariff; or as an alternative, the provision of those features by other responsible organizations or through direct access by the IC to the Service Management System.

(C)  
(C)

#### E2.3.20 Identification and Rating of VoIP-PSTN Traffic

##### (A) Scope

This Section applies to VoIP-PSTN Traffic exchanged between the Company and the customer in time division multiplexing ("TDM") format that originates and/or terminates in Internet protocol ("IP") format. VoIP-PSTN traffic originates and/or terminates in IP format if it originates from and/or terminates to an end-user customer of a service that requires Internet protocol-compatible customer premises equipment.<sup>(1)</sup>

- (1) This Section governs the identification of originating and terminating intrastate toll VoIP-PSTN traffic and facilities to which switched access rates apply (unless the parties have agreed otherwise) in accordance with the transitional Inter-carrier Compensation framework for VoIP-PSTN traffic adopted by the Federal Communications Commission in its Report and Order, FCC Release No. 11-161 (Nov. 18, 2011) ("FCC Order"). Specifically, this Section establishes the method that will be used to identify the percentage of the customer's intrastate access traffic that will be treated as intrastate toll VoIP-PSTN traffic (referred to in this tariff as "Relevant VoIP-PSTN Traffic").
- (2) This Section applies to originating and terminating intrastate switched access minutes of use ("MOU") and facility rate elements of all Access customers.
- (3) The customer shall not modify its reported PIU factor to account for the VoIP-PSTN Traffic for MOU and facility rate elements.

<sup>(1)</sup> Although the Company has taken the position that this tariff, by its own terms, already applies to VoIP-PSTN traffic, as defined herein, the Company has included this Section in the tariff out of an abundance of caution to prevent any claim that it does not so apply, and to implement the decision by the Federal Communications Commission in its Report and Order in WC Docket Nos. 10-90, etc., FCC Release No. 11-161 (Nov. 18, 2011) ("FCC Order") that VoIP-PSTN access traffic should be exchanged at interstate access rates (unless the parties have agreed otherwise). By its terms, the FCC Order is prospective only, and does not address preexisting law with regard to the applicability of inter-carrier compensation or the enhanced service providers ("ESP") exemption to VoIP-PSTN Traffic. Including this section in the tariff in no way alters or otherwise affects the applicability of this tariff to VoIP-PSTN Traffic before the effective date of the FCC Order.

## E2. GENERAL REGULATIONS

### E2.3 Obligations of the IC (Cont'd)

#### E2.3.20 Identification and Rating of VoIP-PSTN Traffic

(B) Rating of VoIP-PSTN Traffic

The Relevant VoIP-PSTN Traffic exchanged between the customer and the Company or another provider and facility rate elements identified in accordance with this tariff section will be billed at rates equal to the Company's applicable tariffed interstate switched access rates as specified in BellSouth Telecommunications LLC Tariff F.C.C. No. 1 unless the corresponding intrastate rate is lower. If the intrastate rate is lower then that rate will be used for billing. Hereafter, these billed rates will be referred to in this tariff as the relevant "VoIP Rates." (D)

(C) Calculation and Application of Percent-VoIP-Usage Factors<sup>1</sup> (N)

The Company will determine the number of Relevant VoIP-PSTN Traffic originating MOU and the originating facility rate elements effective July 1, 2014 to which VoIP Rates will be applied under subsection (B), above, by applying the Percent VoIP Usage ("PVU") factor to the originating intrastate access MOU and the facilities between the Company and the customer. The PVU factors will be derived and applied as follows: (C)

- (1) The customer will calculate and furnish to the Company a factor (the "PVUC") on an ACNA basis which would aggregate traffic from all Carrier Identification Code ("CIC") or Operating Company Numbers ("OCNs") associated with the ACNA. This PVUC represents the percentage (whole number) of the originating intrastate access MOU that the customer receives from the Company end users in the state which is sent from the Company that is terminated in IP format at the customer's end user. This PVUC shall be based on information such as the number of the customer's retail VoIP subscriptions in the state (e.g., as reported on FCC Form 477), traffic studies, actual call detail, or other relevant and verifiable information satisfactory to the Company. (C)
- (2) The Company will calculate and periodically update a (the "PVUT") VOIP usage factor for the Company. This factor (percentage) is calculated on an individual state basis: the intrastate originating minutes delivered to the customer which were originated in IP format by the Company's end users divided by the total intrastate originating access MOU that the Company delivered to the customer's end users. This PVUT shall be based on information such as the number of the customer's retail VoIP subscriptions in the state (e.g., as reported on FCC Form 477), traffic studies, actual call detail, or other relevant and verifiable information. (C)

<sup>1</sup> Consistent with FCC regulations (47 CFR 51.913(a)), for the period of July 2012 through June 2014 Intrastate VoIP originating usage and originating dedicated facilities charges are required to be at the Intrastate rate and rate structure. Effective July 1, 2013, the Terminating usage and dedicated facilities are at the Interstate rate structure and the lower of the Interstate or Intrastate rates. (N)

## E2. GENERAL REGULATIONS

### E2.3 Obligations of the IC (Cont'd)

#### E2.3.20 Identification and Rating of VoIP-PSTN Traffic (Cont'd)

##### (C) Calculation and Application of Percent-VoIP-Usage Factors (Cont'd)

- (3) The Company will develop a customer Percent VoIP Usage ("PVU") factor combining the customer's PVUC factor with the Company's PVUT factor.
- a) The PVU calculation below is applied when the Company does not bill based on actual call detail records for the Company's intrastate IP traffic at VoIP Rates. (T)
- $PVU = PVUC + [PVUT \times (1 - PVUC)]$  is applied to the Company's end user's originating intrastate MOU and facility rate elements (C)
- Example: The customer reported that their PVUC is 40%. The Company's PVUT is 10%. This results in the following: (T)  
 $PVU = 40\% \text{ plus } (10\% \text{ times } (1 - 40\%)) = 46\%$   
This means that 46% of the originating Intrastate MOU exchanged between the Company's end users and the customer will be rated at VoIP Rates. (C)
- b) The PVU calculation below is applied when the Company bills are based on the actual originating call detail records for the Company's intrastate IP traffic at VoIP Rates. (T)
- The formula for usage will be as follows:
- $PVU = PVUC \times (1 - PVUT)$  applied to the Company's TDM end user's originating intrastate MOU. (C)
- $PVU = PVUC + [PVUT \times (1 - PVUC)]$  applied to the facility rate elements.
- Example: The Company has identified that there were 10,500 originating intrastate MOU from the Company's IP end users and delivered to the customer's end users. The customer reported that their PVUC as 40%. The Company's PVUT is 10%. (C)  
This results in the following: (C)  
 $PVU = 40\% \text{ times } (1 - 10\%) = 36\%$   
This means that 36% of the originating Intrastate MOU exchanged between the Company's TDM end users and the customer will be rated at VoIP Rates and the originating intrastate 10,500 MOU will also be rated at VoIP Rates. (C)  
For the originating facility rate elements, the formula that is applied to the intrastate dedicated facilities is as follows: (C)  
 $PVU = 40\% \text{ plus } (10\% \text{ times } (1 - 40\%)) = 46\%$   
Therefore, 46% of the originating intrastate facilities will be rated at VoIP Rates. (C)
- (4) The Company will apply the customer's PVUC to originating traffic exchanged between the third party providers (e.g. Independent Company and local exchange carrier) subtending the Company's access tandem and customer. (C)
- The customer may elect to provide a different factor ("PVUC3") that represents the originating VoIP-PSTN traffic that is exchanged between the third party providers and the customer. (C)
- (5) If the customer does not furnish the Company with a PVUC pursuant to the preceding paragraph (C) (1), the Company will utilize a customer PVUC of 0%. (C)

## E2. GENERAL REGULATIONS

### E2.3 Obligations of the IC (Cont'd)

#### E2.3.20 Identification and Rating of VoIP-PSTN Traffic (Cont'd)

##### (D) PVU Factor Updates

The customer may update the PVUC factor quarterly using the method set forth in Subsection (C)(1) and (4), above. If the customer chooses to submit such updates, it shall forward to the Company, no later than 15 days after the first day of January, April, July and/or October of each year, a revised PVUC factor based on data for the prior three months, ending the last day of December, March, June and September, respectively. The Company will use the revised PVUC to calculate a revised PVU. The revised PVU factor will only apply prospectively and serve as the basis for billing until superseded by a new PVU.

The customer must update the PVUC factor no later than June 1, 2014 to reflect the use of originating VoIP traffic as delineated in Subsection (C) (1) and (4) or the Company will utilize a customer PVUC of 0%. (C)  
(C)

##### (E) PVU Factor Verification

Not more than twice in any year, the Company may ask the customer to verify the PVUC factor furnished to the Company. The customer shall comply, and shall reasonably provide the records and other information used to determine their PVUC, as specified in section (C)(1), and (4), above. The customer shall retain and maintain (for verification purposes) the records and other information used to determine the PVUC, for at least 12 months after the PVUC is filed (or longer if any other section of the Company's tariffs or applicable law requires a longer period). The verification process shall be conducted consistent with the provisions in Section 2.3.10(B)(D)(E) of BellSouth Telecommunications LLC Tariff F.C.C. No. 1.

##### (F) Verification Process

The Telephone Company will review these customer-provided PVUC records referenced in (E), above. If the review results represent what the Telephone Company considers to be a substantial deviation from the customer's previously reported PVUC or if the PVUC appears unreasonable as compared to other related types of data, the Telephone Company will contact the customer within 30 days. This deviation issue will be dealt with in one of the following ways. The current PVUC will continue to be utilized until resolution from either of the 2 methods below.

- 1) The Telephone Company and the customer will come to an agreement as to an appropriate PVUC within 30 days of the provision of the PVUC records.
- 2) Within 90 days of the receipt of these records, the Telephone Company will review or audit these records. If these PVUC records are not available or these records are not substantive enough to calculate a PVUC, then a PVUC factor of zero will be assigned. This zero PVUC will be utilized until either a PVUC can be agreed upon between the Telephone Company and the customer or an audit can be completed utilizing records acceptable for an audit conclusion. When an audit has been completed employing the records acceptable for an audit conclusion, the PVUC resulting from the audit will be employed until the next customer-provided PVUC is available as referenced in the (D) or (E) procedures above.

#### **E2.3.21 Utilization of Alternative Access Providers**

When the IC of record for an access service utilizes the service(s) of an alternative access provider, it will be the obligation of the IC to monitor the actions of the alternative access provider to insure that the IC's desired service interconnections and grades of service are maintained.

### E2.4 Payment Arrangements and Credit Allowances

#### **E2.4.1 Payment of Rates, Charges and Deposits**

## E2. GENERAL REGULATIONS

(T)

### E2.4 Payment Arrangements and Credit Allowances (Cont'd)

#### E2.4.1 Payment of Rates, Charges and Deposits (Cont'd)

- A. The Company will, in order to safeguard its interests, only require an IC which has a proven history of late payments to the Company or does not have established credit to make a deposit prior to or at any time after the provision of a service to the IC to be held by the Company as a guarantee of the payment of rates and charges.

The Company will notify the customer of a deposit requirement by Certified Mail or Overnight Delivery. The customer will be required to make payment of such deposit prior to the provision of new service in those cases where the customer has not established credit with the Company, or otherwise within fifteen (15) days of such notice for customers with existing services. Such notice period will start the day after the notice is rendered by Certified Mail or Overnight Delivery.

No such deposit will be required of an IC which is a successor of a company which has established credit and has no history of late payments to the Company. Such deposit may not exceed the actual or estimated rates and charges for the service for a two month period. The fact that a deposit has been made in no way relieves the IC from complying with the Company's regulations as to the prompt payment of bills. At such time as the provision of the service to the IC is terminated, the amount of the deposit will be credited to the IC's account and any credit balance which may remain will be refunded.

Such a deposit will be refunded or credited to the IC's account when the IC has established credit or, in any event, after the IC has established a one-year prompt payment record at any time prior to the termination of the provision of the service to the IC. In case of a cash deposit, for the period the deposit is held by the Company, the IC will receive interest at the same percentage rate as that set forth in B.3.a. or in B.3.b following whichever is lower. The rate will be compounded daily for the number of days from the date the IC's deposit is received by the Company to and including the date such deposit is credited to the IC's account or the date the deposit is refunded by the Company. Should a deposit be credited to the IC's account, as indicated above, no interest will accrue on the deposit from the date such deposit is credited to the IC's account.

- B. The Company shall bill on a current basis all charges incurred by and credits due to the IC under this Tariff attributable to services, including, but not limited to the Trouble Location Charge as set forth in E13.3.1 following, established or discontinued during the preceding billing period. In addition, the Company shall bill in advance charges for all services to be provided during the ensuing billing period except for charges associated with service usage, and for the Federal Government which will be billed in arrears. The bill day (i.e., the billing date of a bill for an End User or IC for Access Service under this Tariff), the period of service each bill covers and the payment date will be as follows:

1. For services provided under this Tariff that are billed directly to the End User, the Company will establish a bill day each month for each end user account. The bill will cover charges applicable to the End User for the ensuing billing period, except for the Federal Government which will be billed in arrears. Any known unbilled charges for prior periods and any known unbilled adjustments for prior periods for the charges applicable to the End User will be applied to this bill. Such bills are due when rendered.
2. For services provided under this Tariff that are billed directly to the IC the Company will establish a bill day each month for each IC account. The bill will cover nonusage sensitive service charges for the ensuing billing period for which the bill is rendered, any known unbilled nonusage sensitive charges for prior periods and unbilled usage charges for the period after the last bill day thru the current bill day. Any known unbilled usage charges for prior periods and any known unbilled adjustments will be applied to this bill. Payment for such bills is due as set forth in 3. following. If payment is not received by the payment due date, as set forth in 3. following in immediately available funds, a late payment penalty will apply as set forth in 3. following.

(N)

## E2. GENERAL REGULATIONS (T)

### E2.4 Payment Arrangements and Credit Allowances (Cont'd)

#### E2.4.1 Payment of Rates, Charges and Deposits (Cont'd)

##### B. (Cont'd)

3. All bills dated as set forth in 2. preceding for services provided to the IC and/or End User by the Company are due on the payment due date. The payment due date is the date which is 31 days after the bill day or by the next bill date (i.e., same date in the following month as the bill date) whichever is the shortest interval, except as provided herein, and are payable in immediately available funds. a. All bills dated as set forth in 2. preceding for service, other than BellSouth Equal Access Subscription, provided to the customer by the Company are due on the payment due date. The payment due date is the date which is 31 days after the bill day, or by the next bill date (i.e. same date in the following month as the bill date), whichever is the shortest interval, except as provided herein, and are payable in immediately available funds. If such payment date would cause the payment to be due on a Saturday, Sunday or *federal observed* Holiday (e.g., New Year's Day, *Birthdays of Martin Luther King, Jr.*, Washington's Birthday, Memorial Day, Independence Day, Labor Day, Columbus Day, *Veterans Day*, Thanksgiving Day and Christmas Day), payment for such bills will be due from the customer as follows:

If such payment due date falls on a Sunday or on a *federal observed* Holiday which is observed on a Monday, the payment due date shall be the first non-*federal observed* Holiday day following such Sunday or *federal observed* Holiday. If such payment due date falls on a Saturday or on a *federal observed* Holiday which is observed on Tuesday, Wednesday, Thursday or Friday, the payment due date shall be the last non- *federal observed* Holiday day preceding such Saturday or *federal observed* Holiday.

Further, if any portion of the payment is received by the Company after the payment due date as set forth preceding, or if any portion of the payment is received by the Company in funds which are not immediately available to the Company, then a late payment penalty may be due to the Company. The late payment penalty shall be the portion of the payment not received by the payment due date times a late factor. The late factor shall be the lessor of:

- a. The highest interest rate (in decimal value) which may be levied by law for commercial transactions, compounded daily for the number of days from the payment due date to and including the date that the IC and/or End User actually makes the payment to the Company, or
  - b. 0.000590 per day, compounded daily for the number of days from the payment due date to and including the date that the IC and/or End User actually makes the payment to the Company.
4. In the event of a billing dispute, the IC or End User must submit a documented claim for the disputed amount. If the dispute is submitted on or before the payment due date or within 90 days after the payment due date and the disputed amount is paid prior to resolution of the dispute, any interest credits due the IC or End User upon resolution of the dispute shall be calculated from the date of the overpayment to the resolution date. If the dispute is submitted more than 90 days after the payment due date and the disputed amount is paid prior to resolution of the dispute, any interest credits due the IC or End User upon resolution of the dispute shall be calculated from the dispute date or the date the payment is made, whichever occurs later, to the resolution date. The Company will resolve the dispute and assess interest credits or late payment penalties to the IC or End User as follows:
- If the dispute is resolved in favor of the Company and the IC or End User has paid the disputed amount on or before the payment due date, no credits or late payment penalties will apply to the disputed amount.
  - If the dispute is resolved in favor of the Company and the IC or End User has withheld the disputed amount, any payments withheld pending settlement of the dispute shall be subject to the late payment penalty.



ISSUED: May 31, 2013

EFFECTIVE: July 2, 2013

BY: Marshall M. Criser III, President -FL  
Miami, Florida

## E2. GENERAL REGULATIONS<sup>1</sup>

### E2.4 Payment Arrangements and Credit Allowances (Cont'd)

#### E2.4.1 Payment of Rates, Charges and Deposits (Cont'd)

##### B. (Cont'd)

##### 4. (Cont'd)

- If the dispute is resolved in favor of the IC or End User and the IC or End User has withheld the disputed amount, no credits or late payment penalties will apply to the disputed amount.
- If the dispute is resolved in favor of the IC or End User and the IC or End User has paid the disputed amount, the IC or End User will receive a credit from the Company for the disputed amount times a penalty factor as set forth preceding. The penalty factor shall be the lesser of:
  - a. The highest interest rate (in decimal value) which may be levied by law for commercial transactions, compounded daily for the number of days from the payment due date to and including the date that the IC and/or End User actually makes the payment to the Company, or
  - b. 0.000590 per day, compounded daily for the number of days from the payment due date to and including the date that the IC and/or End User actually makes the payment to the Company.

If an IC's traffic terminates to an end office via an alternative Tandem Service Provider (TSP), any terminating usage dispute for that end office must identify the quantity of MOUs the IC's records indicate to be terminated via an alternative TSP.

Upon receipt of the dispute involving usage terminated via an alternative TSP, the Company will verify that the disputed bill accurately represents the information provided to the Company pursuant to Section 6.6.5 of Tariff FCC No. 1 within five days of receipt of a dispute notification. (C)

If the billing agrees with the billing data received pursuant to Section 6.6.5 of Tariff FCC No. 1 the Company will refer the dispute to the entity providing the billing data information within sixteen days from the date the dispute was received. (C)

The provider of the billing data information will investigate the claim and reply to the Company within fifteen days of the referral.

The provider of the billing data information, the IC and the Company will work cooperatively to resolve any remaining discrepancies.

If the entity providing the billing data information fails to cooperate with the Company to resolve billing disputes involving usage billed based on the billing data information received, the Company may refuse to accept future billing data information and bill the full terminating charges for all usage to the alternative TSP.

The terms and conditions in E2.4.1.B.3. preceding still apply except for the following:

- If the Company accurately billed the usage as contained in the billing data information provided to it, the Company will not be liable for any interest due the IC for overpayment if the dispute is resolved in the IC's favor.

**Note 1:** Text is shown as new due to reissue of all Tariff Sections. No changes in rates or regulations were made with this filing.

## E2. GENERAL REGULATIONS

(T)

### E2.4 Payment Arrangements and Credit Allowances (Cont'd)

#### E2.4.1 Payment of Rates, Charges and Deposits (Cont'd)

- C. Adjustments for the quantities of services established or discontinued in any billing period beyond the minimum period set forth for services in other sections of this Tariff will be prorated based on the number of days the IC or End User had service during the billing period times one-thirtieth (1/30th) the monthly rate. Billing for service begins on the day following the date of installation and shall accrue through and include the day service is discontinued. The Company will, upon request and if available, furnish such detailed information as may reasonably be required for verification of any bill.
- D. When a rate as set forth in this Tariff is shown to more than two decimal places, the charges will be determined using the rate shown. The resulting amount will then be rounded to the nearest penny (i.e., rounded to two decimal places).
- E. When more than one copy of an IC bill for services provided under the provisions of this Tariff is furnished to the IC an additional charge applies for each additional copy of the bill as set forth in E13.3.6 following.
- F. The dispute date is the date the IC or End User presents sufficient documentation to support the claim. Sufficient documentation consists of the following information, where such information is relevant to the dispute and reasonably available to the IC or End User:
1. Dedicated Access
    - a. The nature of the dispute (i.e., incorrect rate, incorrect circuit type etc.), including the basis for the IC's or End User's belief that the bill is incorrect.
    - b. The billing account number(s) assigned by the Company.
    - c. The amount of money in dispute.
    - d. The date of the bill in dispute.
  2. **BellSouth SWA** (Non-Usage) (T)
    - a. The nature of the dispute (i.e., incorrect rate etc.), including the basis for the IC's belief that the bill is incorrect.
    - b. The billing account number(s) assigned by the Company.
    - c. The amount of money in dispute.
    - d. The date of the bill in dispute.
  3. **BellSouth SWA** (Usage) (T)
    - a. The nature of the dispute (i.e., incorrect rate, incorrect minutes of use, etc.), including the basis for the IC's belief that the bill is incorrect.
    - b. The type of usage (i.e., originating or terminating).
    - c. The Company end office where the minutes of use originated or terminated (if applicable).
    - d. The number of minutes in dispute.
    - e. The billing account number(s) assigned by the Company.
    - f. The amount of money in dispute.
    - g. The date of the bill. (M)

Material appearing on this page previously appeared on page(s) 23 of this section.

ISSUED: May 31, 2013

EFFECTIVE: July 2, 2013

BY: Marshall M. Criser III, President -FL  
Miami, Florida

## E2. GENERAL REGULATIONS

### E2.4 Payment Arrangements and Credit Allowances (Cont'd)

#### E2.4.1 Payment of Rates, Charges and Deposits (Cont'd)

- G. The Company and the IC or End User shall work cooperatively to resolve the dispute.

If additional information from the IC or End User would assist in resolving the dispute, the IC or End User may be requested to provide additional information relevant to the dispute and reasonably available to the IC or End User. This data may include, but is not limited to summarized usage data by time of day. The request for such additional information shall not affect the dispute date established pursuant to F. preceding.

- H. For purposes of B.4., the resolution date is the date on which the Company completes the investigation of the dispute, and the Company's service representative notifies the IC or End User of the disposition and notes the IC's or End User's account or when the Company forwards the amount of credit to the customer, depending upon IC or End User preference.

- I. At the option of the IC or end user, all nonrecurring charges associated with a Standard or Negotiated Interval Access Order may be billed over a three month period subject to the following:

- 50 percent of the total nonrecurring charges will be billed in the first monthly billing period after the charges are incurred, and 25 percent of the total nonrecurring charges plus an Extended Billing Plan Charge will be billed in each of the following two monthly billing periods.
- The Extended Billing Plan Charge is calculated at a rate of 1.0 percent per month or 12 percent annually, on the unbilled balance of the nonrecurring charges.
- The IC or end user must request extended billing at the time the Access Service request is placed for a Standard or Negotiated Interval Access Order.
- If the IC or end user disconnects service before the expiration of the plan period, all unbilled charges plus the Extended Billing Plan Charge, if applicable, will be included in the final bill rendered.
- This payment arrangement is not available for Daily Program Audio (*a.k.a. BellSouth SPA Program Audio*).
- If the IC or end user fails to make any of the payments on the payment due date as set forth in B.3. preceding, these late payment charges as specified in B.3.a. or b. preceding will apply.

#### E2.4.2 Minimum Periods

- A. The minimum periods for which services are provided and for which rates and charges are applicable are set forth in Sections E5. and E7 of this intrastate Tariff and Section 6 of Tariff FCC No. 1 for *BellSouth SWA* and *Dedicated* Access services; in Sections E8. and E9. following, for Billing and Collection Services and *BellSouth* Directory Assistance *Access* Service; in Section E13. following, for Scheduled Testing; and, in Section E14. following for Special Construction.

(C)

ISSUED: May 31, 2013

EFFECTIVE: July 2, 2013

BY: Marshall M. Criser III, President -FL  
Miami, Florida

## E2. GENERAL REGULATIONS

### E2.4 Payment Arrangements and Credit Allowances (Cont'd)

#### E2.4.2 Minimum Periods (Cont'd)

- B. The minimum period for which service is provided and for which rates and charges are applicable for a Specialized Service or Arrangement provided on an individual case basis, as set forth in Section E12. *of this Tariff* is one month unless a different minimum period is established with the individual case filing.
- C. When a service is discontinued prior to the expiration of the minimum period, charges are applicable for the remaining portion of the minimum period, whether the service is used or not, and will be based on the rates in effect for the service at the time of discontinuance.

#### E2.4.3 Cancellation of an Order for Service

Provisions for the cancellation of an order for service are set forth in other applicable sections of this Tariff.

#### E2.4.4 Credit Allowance for Service Interruptions

##### A. General

A service outage is when service becomes unusable to the IC or End User because of a failure of a facility component used to furnish service under this Tariff, or in the event that the protective controls applied by the Company result in the complete loss of service by the IC or End User as set forth in Section 6.5.1 of Tariff FCC No. 1. An outage period starts when an inoperative service is reported by the IC and ends when the service is operative. (C)

##### B. When A Credit Allowance Applies

In case of an outage to any service, allowance for the period of outage, if not due to the negligence of the IC or End User, shall be as follows:

1. For *BellSouth SWA* Dedicated Interoffice Channels, Channelization Equipment, Switched Local Channels, Dedicated Access Service, *Dedicated End Office Trunk Port Service*, *Dedicated Tandem Trunk Port Service* and for Fast Packet Access Services no credit shall be allowed for an outage of less than 30 minutes. The IC or End User shall be credited for an outage of 30 minutes or more at the rate of 1/1440 of the monthly charges for the facility or service for each period of 30 minutes or major fraction thereof that the outage continues.

The monthly charges used to determine the credit shall be as follows:

- a. The monthly charge shall be the total of all the monthly rate element charges associated with the service.
  - (1) For BellSouth SWA Transport: Switched Local Channel, BellSouth SWA Dedicated Interoffice Channel, *Dedicated End Office Trunk Port Service*, *Dedicated Tandem Trunk Port Service*, Channelization Equipment (if applicable), and any Optional Features and Functions.
  - (2) For Dedicated Access two-point services: two Local Channels, Interoffice Channel and Optional Features and Functions.
- b. For Dedicated Access multipoint services, the monthly charge shall be only the total of all the monthly rate element charges associated with that portion of the service that is inoperative (i.e., a local channel between the Hub and IC or End User premises and associated channel interface, interoffice channel mileage and optional features and functions.)

## E2. GENERAL REGULATIONS

### E2.4 Payment Arrangements and Credit Allowances (Cont'd)

#### E2.4.4 Credit Allowance for Service Interruptions (Cont'd)

**B. When A Credit Allowance Applies (Cont'd)**

1. (Cont'd)

- c. For Dedicated Access channelized services, the monthly charge shall be the total of all the monthly rate element charges associated with that portion of the service that is inoperative. When the facility which is channelized or the Basic Channelization System itself is inoperative, the monthly charge shall be the total of all the monthly rate element charges associated with the service (i.e., the local channel to the Hub and its associated channel interface, interoffice channel mileage and any optional features and functions, including the Basic Channelization System, and the local channels from the Hub and their associated Central Office Channel Interfaces, channel mileages and optional features and functions). When the service which rides a channel of the channelized facility is inoperative, the monthly charge shall be the total of all the monthly rate element charges associated with that portion of the service from the Hub to IC or End User premises (i.e., local channel, Central Office Channel Interface, channel mileage and optional features and functions).
  - d. For BellSouth SWA channelized services, the monthly charge shall be the total of all monthly rate element charges associated with that portion of service that is inoperative. When the facility which is channelized or the Basic Channelization System itself is inoperative, the monthly charge shall be the total of all the monthly rate element charges associated with the service (e.g., the Switched Local Channel, Switched Interoffice Channels, Channelization Equipment, including the Basic Channelization System on the facility to the Hub, if applicable).
  - e. For SMARTPath<sup>®</sup> service (a.k.a. BellSouth SPA Shared Ring), the monthly charge shall be the total of all the monthly rate element charges associated with the service (i.e., SMARTPath<sup>®</sup> (a.k.a. BellSouth SPA Shared Ring) Area Connection and SMARTPath<sup>®</sup> (a.k.a. BellSouth SPA Shared Ring) Area Junction).
  - f. For and BellSouth Managed Shared Ring service, the monthly charge shall be the monthly charges associated with the service (e.g., Off-Net). (D)
2. For Program Audio Dedicated Access (a.k.a. BellSouth SPA Program Audio) services, no credit shall be allowed for an outage of less than 30 seconds. The IC or End User shall be credited for an outage of 30 seconds or more as follows:
- a. For two-point services, when monthly rates are applicable, the credit shall be at the rate of 1/8640 of the monthly charges for the service for each period of 5 minutes or major fraction thereof that the outage continues.
  - b. For multipoint services, when monthly rates are applicable, the credit shall be at the rate of 1/8640 of the monthly charges for each connecting channel and associated channel interface, channel mileage and optional features and functions that is inoperative for each period of 5 minutes or major fraction thereof that the outage continues.
  - c. For multipoint services, the credit for the monthly charges includes the charges for the distribution amplifier only when the distribution amplifier is inoperative.
  - d. When two or more outages occur during a period of 5 consecutive minutes, such multiple outages shall be considered as one outage.
3. For BellSouth SWA service and BellSouth Directory Assistance Access service, no credit shall be allowed for an outage of less than 24 hours. The IC or End User shall be credited for an outage of 24 hours or more at the rate of 1/30 of the monthly rates or the assumed minutes of use charge, whichever is applicable to the service involved, for each period of 24 hours or major fraction thereof that the outage continues. In the case of service billed based upon actual usage, no credit allowance is applicable.

<sup>®</sup> Registered Service Mark of BellSouth Corporation  
\* Service Mark of BellSouth Corporation

## E2. GENERAL REGULATIONS

### E2.4 Payment Arrangements and Credit Allowances (Cont'd)

#### E2.4.4 Credit Allowance for Service Interruptions (Cont'd)

##### B. When A Credit Allowance Applies (Cont'd)

4. The credit allowance(s) for an outage or for a series of outages shall not exceed the sum of the monthly rates or the assumed minutes of use charge for the service that is out of operation in any one monthly billing period.
5. For certain Dedicated Access services (Wideband Digital, WD1-4; Digital Data Access (a.k.a. BellSouth SPA DS0 Digital Data), DA1-4; and High Capacity (a.k.a. BellSouth SPA High Capacity), HC1) any period during which the error performance is below that specified for the service will be considered as an outage.
6. Service outages for Specialized Service or Arrangements provided under the provisions of Section E12. following shall be administered in the same manner as those set forth in this Section unless other regulations are specified with the individual case filing.
7. For SMARTPath service (a.k.a. BellSouth SPA Shared Ring), a credit, in addition to the credit described in 1. preceding, failure by the Company to meet the performance guarantee described in E7.2.12.C.1. of this Tariff, will prompt a credit equal to 100 percent for affected SMARTPath service (a.k.a. BellSouth SPA Shared Ring) rate elements. A customer request for credit will not be required. The credit will be applied through normal administrative processes and the dollar amount will be reflected on the customer's bill. The credit will apply no more than once per calendar month. This credit is in addition to those provided in 1. preceding. The combined total of the credit allowance during a month for failure to meet the performance guarantee in E7.2.12.C.1. of this Tariff and the credit for service outage contained in 1. preceding shall not exceed the monthly rate for the service.
8. For the channels used with BellSouth Managed Shared Ring service, failure by the Company to meet the performance guarantee described in E7.5.1 of this Tariff will prompt the credit described in that Section. The combined total of the credit allowance during a month for failure to meet the performance guarantee for BellSouth Managed Shared Ring in Section 6.7.21 of Tariff FCC No. 1, as applicable, and the credit for service interruption contained in this section shall not exceed the monthly rate for the portion of the service affected. (D)

##### C. When Credit Allowance Does Not Apply

No credit allowance will be made for:

1. Interruptions caused by the negligence of the IC, end user *or the IC's authorized agent*.
2. Interruptions of a service due to the failure of equipment or systems provided by the IC, end user or others.
3. Outages of a service during any period in which the Company is not afforded access to the premises where the service is terminated.
4. Interruptions of a service when the IC or End User has released that service to the Company for maintenance purposes, to make rearrangements, or for the implementation of an order for a change in the service during the time that was negotiated with the IC or End User prior to the release of that service. Thereafter, a credit allowance as set forth in B. preceding applies.
5. Interruptions of a service which continue because of the failure of the IC or End User to authorize replacement of any element of special construction, as set forth in E14 following. The period for which no credit allowance is made begins on the seventh day after the IC or End User receives the Company's written notification of the need for such replacement and ends on the day after receipt by the Company of the IC's or End User's written authorization for such replacement.
6. Periods when the IC or End User elects not to release the service for testing and/or repair and continues to use it on an impaired basis.
7. An outage or a group of outages, resulting from a common cause, for amounts less than one dollar.
8. Interruptions of a service due to commercial power failure.
9. Interruptions of a service due to labor difficulties, governmental orders, civil commotions, criminal action against the Telephone Company, acts of God, war, or other circumstances beyond the Telephone Company's control.
10. (DELETED)

EFFECTIVE: July 15, 1996

## E2. GENERAL REGULATIONS<sup>1</sup>

(N)

### E2.4 Payment Arrangements and Credit Allowances (Cont'd)

#### E2.4.4 Credit Allowance for Service Interruptions (Cont'd)

**D. Use of an Alternative Service Provided by the Company**

Should the IC elect to use an alternative service provided by the Company during the period that a service is out of operation, the IC must pay the tariffed rates and charges for the alternative service used.

**E. Temporary Surrender of a Service**

In certain instances, the IC may be requested by the Company to surrender a service for purposes other than maintenance, testing or activity relating to a service order. If the IC consents, a credit allowance will be granted. The credit allowance will be 1/1440 of the monthly rate for each period of 30 minutes or fraction thereof that the service is surrendered. In no case will the credit allowance exceed the monthly rate for the service surrendered in any one monthly billing period.

#### E2.4.5 Provision for Gross Receipts Tax

Any IC failing to furnish to the Company the appropriate certificate, issued by the State of Florida or its appropriate agency, indicating the IC's exemption from the Florida gross receipts tax imposed by Florida Rule 12B-6.04, shall pay to the Company an amount equal to the gross receipts tax on the IC's purchase of access services from the Company.

Until the aforementioned certificate is received by the Company, the Company shall calculate the amount of tax owed by the IC and shall bill this amount to the IC. Payment of these charges by the IC shall be subject to the payment arrangements as specified in E2.4.1 preceding.

#### E2.4.6 Re-establishment of Service Following Fire, Flood or Other Occurrence

**A. Nonrecurring Charges Do Not Apply**

Charges do not apply for the re-establishment of service following a fire, flood or other occurrence attributed to an Act of God provided that:

1. The service is of the same type as was provided prior to the fire, flood or other occurrence.
2. The service is for the same IC or End User.
3. The service is at the same location on the same premises.
4. The re-establishment of service begins within 60 days after Company service is available. (The 60 day period may be extended a reasonable period if the renovation of the original location on the premises affected is not practical within the allotted time period.)

**B. Nonrecurring Charges Apply**

Nonrecurring Charges apply for establishing service at a different location on the same premises or at a different premises pending re-establishment of service at the original location.

**Note 1:** Text is shown as new due to reissue of all Tariff Sections. No changes in rates or regulations were made with this filing.

ISSUED: December 19, 2013

EFFECTIVE: December 20, 2013

BY: Marshall M. Criser III, President -FL  
Miami, Florida

## E2. GENERAL REGULATIONS<sup>1</sup>

### E2.4 Payment Arrangements and Credit Allowances (Cont'd)

#### E2.4.7 Title or Ownership Rights

- A. The payment of rates and charges by ICs or End Users for the services offered under the provisions of this Tariff does not assign, confer or transfer title or ownership rights to proposals or facilities developed or utilized, respectively, by the Company in the provision of such services.

#### E2.4.8 Billing of Access Service Provided by Multiple Companies

The Company will adhere to the standards for billing of Access Service by multiple companies that are set forth in reference documents Ordering and Billing Forum: Multiple Exchange Carrier Access Billing (MECAB) and Ordering and Billing Forum: Multiple Exchange Carrier Ordering and Design (MECOD).

A. Feature Group A (FGA) Service<sup>2</sup>

When a Feature Group A (or LSBSA)<sup>3</sup> Switched Access Service is ordered by an IC or End User where one end of the Transport element is in the Company's operating territory and the other end is in another Exchange Telephone Company's operating territory, the Exchange Telephone Company in whose territory the FGA dial-tone office is located will accept the order. In addition, the Exchange Telephone Company in whose territory the IC's or End User's serving wire center is located must also receive a copy of the order from the IC or End User. The Exchange Telephone Company that accepts the order will then determine the charges involved, arrange to provide the Access Service ordered and bill the charges in accordance with its Access Service Tariff.

Upon agreement of the Exchange Telephone Companies involved in the provision of FGA service, the dedicated portion of FGA service (i.e., Switched Dedicated Interoffice Channel, Switched Local Channel and Channelization Equipment) will be billed in accordance with the provisions of B. and C. following. For non-dedicated portions of FGA service, including the Interconnection charge, the rates of the billing Company will apply.

B. Single Bill Arrangements

I. General

If agreed to by the Exchange Telephone Companies involved in the provision of the service, a single bill arrangement will be provided for FGB, FGD and the dedicated portions of FGA service. In the event that the Exchange Telephone Companies involved agree to change from one billing arrangement to another, the IC or End User will be notified at least 30 days prior to the effective date of such change. (D)

2. Ordering

The IC shall place its access service request with each Exchange Telephone Company involved in the provision of the service.

3. Rating and Billing of Service

**Note 1:** Text is shown as new due to reissue of all Tariff Sections. No changes in rates or regulations were made with this filing.

**Note 2:** Except where indicated herein, references to feature groups will also include the applicable Basic Serving Arrangement (BSA) as detailed in the matrix of Section 6.1.3 of Tariff FCC No. 1 (e.g., the term FGA represents both FGA and Line Side Basic Service Arrangement (LSBSA)).

**Note 3:** Where LSBSA is provisioned with a DNAL, this sub-section, E2.4.8 shall also apply to the DNAL.



ISSUED: December 19, 2013

EFFECTIVE: December 20, 2013

BY: Marshall M. Criser III, President -FL  
Miami, Florida

## E2. GENERAL REGULATIONS<sup>1</sup>

### E2.4 Payment Arrangements and Credit Allowances (Cont'd)

#### E2.4.8 Billing of Access Service Provided by Multiple Companies (Cont'd)

##### B. Single Bill Arrangements (Cont'd)

##### 3. Rating and Billing of Service (Cont'd)

The billing company will be as agreed to by the Exchange Telephone Companies involved in the provision of the service. The single bill arrangement may be provided under the following single bill alternatives if agreed to by such companies:

- a. The billing company will bill and collect all appropriate charges in accordance with the regulations, rates and charges in its Access Service Tariff, or
- b. The billing company will bill and collect all appropriate charges in accordance with the rates and charges in its access tariff, for the portion of the service it provides, and in accordance with the rates and charges of the access tariffs of the other Exchange Telephone Companies involved, for the portion of the service which they provide. The Interconnection charge of the end office Telephone Company will apply. The bill will separately identify each company's rates and charges, or
- c. The billing company will bill and collect all appropriate charges in accordance with the rates and charges in the access tariffs of the other involved Exchange Telephone Companies, as forwarded to it by such companies for the portion of the service they provide, and in accordance with the rates and charges in its own access tariff for the portion of the service it provides. The Interconnection charge of the end office Telephone Company will apply. The bill will separately identify each company's rates and charges.

For b. and c. preceding, the charges billed for the portion of service provided by this Company are determined as set forth in C.3.a., b. and c. following. For nonrecurring charges, 100 percent of this Company's charge shall apply.

##### C. Multiple Bill Arrangements

##### 1. General

Separate bills will be rendered by the Exchange Telephone Companies for FGB<sup>2</sup>, and FGD the dedicated portions of FGA Access Service if the administration of a single bill arrangement, as set forth in B. preceding, is not agreed upon by the companies involved. In the event that the Exchange Telephone Companies involved agree to change from one billing arrangement to another, the IC or End User will be notified at least 30 days prior to the effective date of such change. (D)

##### 2. Ordering

The IC shall place its access service request with each Exchange Telephone Company involved in the provision of the service.

##### 3. Rating and Billing of Service

**Note 1:** Text is shown as new due to reissue of all Tariff Sections. No changes in rates or regulations were made with this filing.

**Note 2:** Except where indicated herein, references to feature groups will also include the applicable Basic Serving Arrangement (BSA) as detailed in the matrix of Section 6.1.3 of Tariff FCC No. 1 (e.g., the term FGA represents both FGA and Line Side Basic Service Arrangement (LSBSA)).

ISSUED: May 31, 2013

EFFECTIVE: July 2, 2013

BY: Marshall M. Criser III, President -FL  
Miami, Florida

## E2. GENERAL REGULATIONS

### E2.4 Payment Arrangements and Credit Allowances (Cont'd)

#### E2.4.8 Billing of Access Service Provided by Multiple Companies (Cont'd)

##### C. Multiple Bill Arrangements (Cont'd)

##### 3. Rating and Billing of Service (Cont'd)

Each company will provide its portion of the Access Service based on the regulations, rates and charges contained in its Access Service Tariff, subject to the following rules, as appropriate:

a. The charges billed by this Company for mileage sensitive rate elements, e.g., BellSouth SWA Transport, Dedicated Access Service Interoffice Channels or BellSouth Directory Assistance Access Transport, are determined as follows:

- (1) The total mileage for the service is computed using the V&H Coordinate Method set forth in NATIONAL EXCHANGE CARRIER ASSOCIATION TARIFF FCC NO. 4 (NECA NO. 4).
- (2) A billing factor is determined from NECA No. 4 directly.
- (3) This Company's rates and charges are then multiplied by the appropriate quantity(ies) and the billing factor to obtain the charges for this Company.

An example of this methodology is shown in 4. following.

b. The application of nondistance sensitive rate elements varies according to the rate structure and the location of the facilities involved:

- (1) When rates and charges are listed on a per point of termination basis, this Company's rates will be billed for the termination(s) within this Company's operating territory.
- (2) When rates and charges are listed on a per unit basis, e.g., central office bridging or channelization, this Company's rates and charges will apply for units located in this Company's operating territory. *For switched access common transport between a Company access tandem and an end office of another Company, fifty percent of this Company's Common Transport DS3 to DS1 Multiplexer rate, as set forth in Section 6.8.1 of Tariff FCC No. 1, and this Company's Directory Transport DS3 to DS1 Multiplexer rate, as set forth in E9.5.3 of this Tariff, shall apply.*
- (3) When rates and charges are developed on an individual case basis, such rates will be developed for the portion of the service provided by this Company.
- (4) When rates and charges are listed on a per service basis, this Company's rates and charges are allocated based upon the ratio of points on the dedicated access circuit that a company owns, in relation to the total number of points on the circuit.
- (5) For the fixed portion of rates applicable to the mileage between central offices on Dedicated Access Service, and for the nonrecurring charges applicable to interoffice channels, fifty percent of this Company's rate will apply for each end of the interoffice channel that this Company provides.

For example:

If the interoffice channel is in a mileage band for which the appropriate rate for that band is \$11.80, and this Company provides only one end of the interoffice channel, the rate would be fifty percent of \$11.80, or \$5.90. Likewise, fifty percent of this Company's nonrecurring charge would apply when this Company provides only one end of the interoffice channel.

(C)  
(C)

ISSUED: May 31, 2013

EFFECTIVE: July 2, 2013

BY: Marshall M. Criser III, President -FL  
Miami, Florida

## E2. GENERAL REGULATIONS

### E2.4 Payment Arrangements and Credit Allowances (Cont'd)

#### E2.4.8 Billing of Access Service Provided by Multiple Companies (Cont'd)

C. Multiple Bill Arrangements (Cont'd)

3. Rating and Billing of Service (Cont'd)

- b. The application of nondistance sensitive rate elements varies according to the rate structure and the location of the facilities involved: (Cont'd)

(5) (Cont'd)

If this Company does not provide either end of the interoffice channel, this Company's fixed rate for mileage between central offices and this Company's nonrecurring charges for interoffice channels shall not apply.

- (6) For BellSouth SWA Dedicated Interoffice Channel Facility Termination rates, fifty percent of this Company's rate will apply for each end of the Dedicated Interoffice Channel that this Company provides.

For example:

If the BellSouth SWA Dedicated Interoffice Channel Facility Termination rate is \$15.00, and this Company provides only one end of this BellSouth SWA Dedicated Interoffice Channel, the rate would be fifty percent of \$15.00, or \$7.50.

If this Company does not provide either end of the BellSouth SWA Dedicated Interoffice Channel, this Company's BellSouth SWA Dedicated Interoffice Channel Facility Termination rate shall not apply.

- (7) Where this Company is the end office Company, 100 percent of this Company's Interconnection charge will apply.

- c. For nonrecurring charges, 100 percent of this Company's charge shall apply, except as specified in b.(5) preceding; *provided however, that for installation charges pursuant to Section 6.8.1 (E) of Tariff FCC No. 1, only fifty percent of this Company's installation charges will apply where, for trunks installations this Company owns neither the involved end office or access tandem, or for line side installations this Company does not own the Feature Group A dial tone office.* (C)

4. Multiple Bill Example<sup>1</sup> for Switched Transport Rate Elements

- a. Assume Switched Dedicated/Common Transport is ordered to an End Office in the operating territory of Company A. The IC premises is located in the operating territory of Company B.

(1) Switched Dedicated Transport

**Note 1:** Rates used in each example are for example purposes only.

FLORIDA  
ISSUED: July 1, 1996  
BY: Joseph P. Lacher, President - FL  
Miami, Florida

EFFECTIVE: July 15, 1996

**E2. GENERAL REGULATIONS<sup>1</sup>**

(N)

**E2.4 Payment Arrangements and Credit Allowances (Cont'd)**

**E2.4.8 Billing of Access Service Provided by Multiple Companies (Cont'd)**

C. Multiple Bill Arrangements (Cont'd)

4. Multiple Bill Example<sup>2</sup> for Switched Transport Rate Elements (Cont'd)

a. Assume Switched Dedicated/Common Transport is ordered to an End Office in the operating territory of Company A. The IC premises is located in the operating territory of Company B. (Cont'd)

(1) Switched Dedicated Transport (Cont'd)

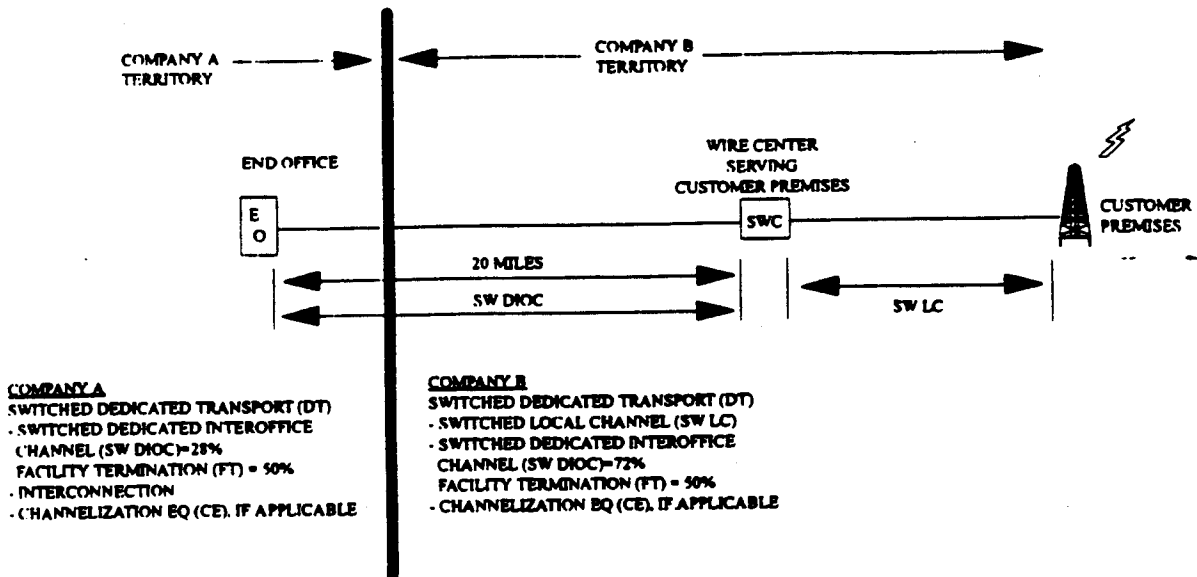

Assume 20 miles of Switched Dedicated Transport (DT); Assume 8,000 minutes of use; Assume billing factor from NECA No. 4 of 28% for Company A and 72% for Company B.

COMPANY A - DT = \$1.00 per mile  
 FT = \$25.00 per month  
 INTERC. = \$.002 per mou

**Note 1:** Text is shown as new due to reissue of all Tariff Sections. No changes in rates or regulations were made with this filing.

**Note 2:** Rates used in each example are for example purposes only.

FLORIDA

ISSUED: July 1, 1996

BY: Joseph P. Lacher, President - FL  
Miami, Florida

EFFECTIVE: July 15, 1996

## E2. GENERAL REGULATIONS<sup>1</sup>

(N)

### E2.4 Payment Arrangements and Credit Allowances (Cont'd)

#### E2.4.8 Billing of Access Service Provided by Multiple Companies (Cont'd)

##### C. Multiple Bill Arrangements (Cont'd)

##### 4. Multiple Bill Example<sup>2</sup> for Switched Transport Rate Elements (Cont'd)

- a. Assume Switched Dedicated/Common Transport is ordered to an End Office in the operating territory of Company A. The IC premises is located in the operating territory of Company B. (Cont'd)

DT	20 mi x \$1.00 x 28%	= \$ 5.60
FT	\$25.00 x 50%	= \$12.50
INTERC.	\$.002 x 8,000 mou	= \$16.00

COMPANY A SWITCHED TRANSPORT = \$34.10

COMPANY B - DT	= \$ .50 per mile
FT	= \$15.00 per month
SW LC	= \$10.00 per month

SW LC	= \$ 10.00
FT	\$15.00 x 50% = \$ 7.50
DT	20 mi x \$.50 x 72% = \$ 7.20

COMPANY B SWITCHED TRANSPORT = \$24.70

##### (2) Switched Common Transport

**Note 1:** Text is shown as new due to reissue of all Tariff Sections. No changes in rates or regulations were made with this filing.

**Note 2:** Rates used in each example are for example purposes only.

## E2. GENERAL REGULATIONS

### E2.4 Payment Arrangements and Credit Allowances (Cont'd)

#### E2.4.8 Billing of Access Service Provided by Multiple Companies (Cont'd)

##### C. Multiple Bill Arrangements (Cont'd)

##### 4. Multiple Bill Example' for Switched Transport Rate Elements (Cont'd)

- a. Assume Switched Dedicated/Common Transport is ordered to an End Office in the operating territory of Company A. The IC premises is located in the operating territory of Company B. (Cont'd)

##### (2) Switched Common Transport (Cont'd)

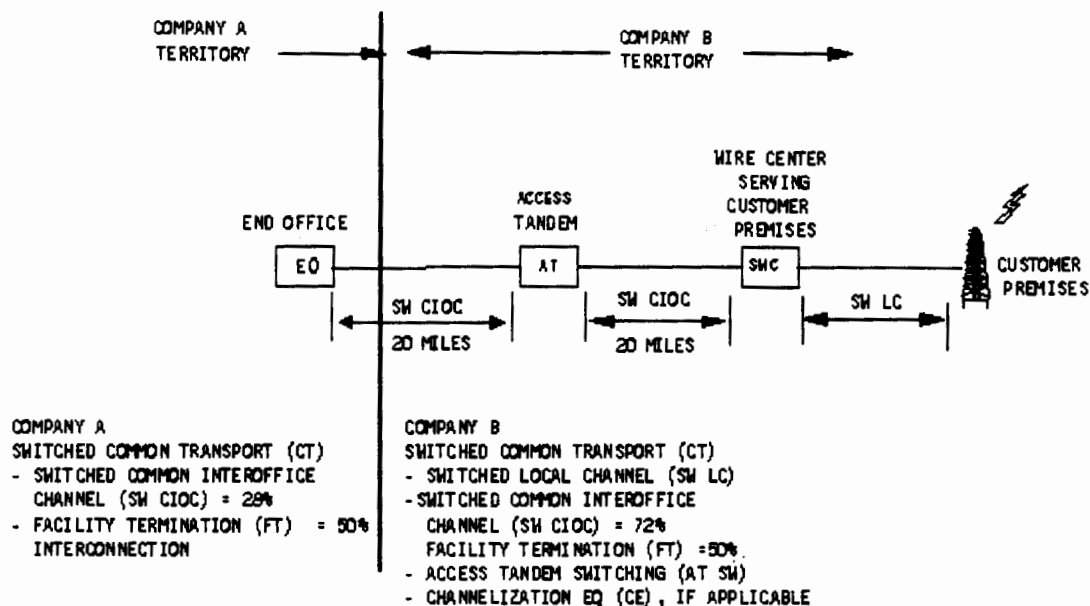

Assume 20 miles of Switched Common Transport (CT); 20 miles of Switched Dedicated Transport (DT); and 8,000 minutes of use. **Further**, assume a billing factor from NECA 4 of 28% for Company A and 72% for Company B.

COMPANY A - CT	= \$.0001 per mou/per mile
- CT FT	= \$.0001 per mou
- Interconnection	= \$.002 per mou
- Interconnection \$ .002 x 8,000 mou	= \$16.00
- CT 20 mi. x \$.0001 x 8,000 mou x 28%	= \$4.48
- CT FT \$.0001 x 8,000 mou x 50%	= \$.40

COMPANY A SWITCHED TRANSPORT = \$20.88

**Note 1:** Rates used in each example are for example purposes only **and do not include multiplexing, tandem trunk ports and end office trunk ports.**

## E2. GENERAL REGULATIONS

### E2.4 Payment Arrangements and Credit Allowances (Cont'd)

#### E2.4.8 Billing of Access Service Provided by Multiple Companies (Cont'd)

##### C. Multiple Bill Arrangements (Cont'd)

##### . Multiple Bill Example<sup>1</sup> for Switched Transport Rate Elements (Cont'd)

- a. Assume Switched Dedicated/Common Transport is ordered to an End Office in the operating territory of Company A. The IC premises is located in the operating territory of Company B. (Cont'd)
  - (2) Switched Common Transport (Cont'd)

COMPANY B - CT	= \$.0003 per mou/per mile
CT FT	=\$.0001 per mou
AT Switching	=\$.00005 per mou
SWLC	=\$10.00
DT	=\$2.00 per mile
DT FT	=\$30.00 per month
SWLC	=\$10.00
AT SW \$.00005 x 8.000 mou	=\$.40
CT 20 mi. x \$.0001 x 8.000 mou x 72%	=\$11.52
CT FT \$.0001 x 8.000 mou x 50%	=\$.40
DT 20 mi. x \$2.00	=\$40.00
DT FT	=\$30.00
COMPANY B SWITCHED TRANSPORT	=\$92.32

#### E2.4.9 Optional Payment Plan

##### A. Channel Services Payment Plan

##### 1. General

- a. The regulations specified herein are applicable to Dedicated Access Services as indicated in Section E7. of this Tariff.
- b. Facilities furnished under the Channel Services Payment Plan (CSPP) are subject to all general regulations applicable to the provision of service by the Company as stated elsewhere in this Tariff except as noted herein.
- c. The CSPP is a payment plan which allows customers to pay fixed rates for channel equipment and/or facilities over variable contractual payment periods. A specific monthly rate applies for the duration of each period as follows, or as specified otherwise in this Tariff.
  - (1) 36 month Term Payment Plan - payment periods may be selected from 24 months to 48 months in length, at 36 month rates and charges.<sup>2, 3, 4</sup> (C)
  - (2) 60 month Term Payment Plan - payment periods may be selected from 49 months to 72 months in length, at 60 month rates and charges.<sup>2, 3</sup>
  - (3) 84 month Term Payment Plan - payment periods may be selected from 73 months to 96 months in length, at 84 month rates and charges.<sup>2, 3</sup>

**Note 1:** Rates used in each example are for example purposes only and do not include multiplexing, tandem trunk ports and end office trunk ports.

**Note 2:** Effective March 23, 2019, Customers may not: (1) Establish CSPPs for Derived Data Channel Service, Digital Data Access Service and FlexServ Service, (2) Establish CSPPs greater than 36 months for High Capacity Service and SMARTPath Service, and (3) Convert or renew CSPPs for Derived Data Channel Service, Digital Data Access Service, FlexServ Service, High Capacity Service and SMARTPath Service.

**Note 3:** Effective November 1, 2022, customers may not establish new term plans of greater than 24 months for High Capacity Service Channel Service Payment Plans.

**Note 4:** Effective March 17, 2024, customers may not establish new term plans of greater than month-to-month for High Capacity Service Channel Service Payment Plans. (N)

## E2. GENERAL REGULATIONS<sup>1</sup>

### E2.4 Payment Arrangements and Credit Allowances (Cont'd)

#### E2.4.9 Optional Payment Plan (Cont'd)

- A. Channel Services Payment Plan (Cont'd)
1. General (Cont'd)
    - d. When the customer extends service beyond a 96 month service period, the 84 month<sup>2, 3, 4</sup> Term Payment Plan (or the longest available tariffed service period) rates will apply. (C)
    - e. When the customer orders service to be provided under a CSPP arrangement, the customer must designate to the Company the payment plan and the service period desired, e.g. 84 month<sup>2, 3, 4</sup> Term Payment Plan and 96 months<sup>3</sup>. (C)
  2. Application of Rates and Charges
    - a. Rates stabilized under a CSPP arrangement are exempt from Company-initiated increases. However, decreases for any rate element will automatically flow through to the customer.
    - b. In the event that all or any part of a service is disconnected at customer request prior to expiration of any selected payment period of greater than one month's duration, the customer will be required to pay a termination charge as stated in that service's section of this Tariff.
    - c. When customers renew or change the length of their payment period, the rates applicable for the new period are those currently in effect at the time of the renewal or change in the length of the payment period.
    - d. Recurring rates and nonrecurring charges apply according to the appropriate schedules for services offered as associated items to Channel Services, and are filed elsewhere in this Tariff.
    - e. Customer requests for inside moves of service will not affect the contract period.
    - f. A change in jurisdiction will not constitute a disconnect of service provided the new CSPP arrangement is a minimum 24 month<sup>2, 3, 4</sup> service period or equals/exceeds the remaining service period, whichever is greater, provided the new CSPP arrangement is for the same customer at the same location for the same capacity service. (C)
  3. Additions
    - a. Additions of services or rate elements for activating spare or unused capacities of a service under a CSPP arrangement will be considered part of the existing CSPP arrangement.
    - b. Additions of services or rate elements, i.e., new local channels, interoffice channels, etc., other than for activating spare or unused capacities, must be under a new CSPP arrangement at rates and charges as specified in 2. preceding.
    - c. Termination charges for premature disconnection of added contractual services will apply as set forth under Disconnects as stated in 4. following.
    - d. Additions under CSPP are exempt from Company initiated rate changes for all payment periods longer than one month. However, decreases for any rate element will automatically flow through to the customer.
    - e. Nonrecurring charges, as specified in this Tariff, will apply to the added channel services.
  4. Disconnects

**Note 1:** Text is shown as new due to reissue of all Tariff Sections. No changes in rates or regulations were made with this filing.

**Note 2:** Effective March 23, 2019, Customers may not: (1) Establish CSPPs for Derived Data Channel Service, Digital Data Access Service and FlexServ Service, (2) Establish CSPPs greater than 36 months for High Capacity Service and SMARTPath Service, and (3) Convert or renew CSPPs for Derived Data Channel Service, Digital Data Access Service, FlexServ Service, High Capacity Service and SMARTPath Service.

**Note 3:** Effective November 1, 2022, customers may not establish new term plans of greater than 24 months for High Capacity Service Channel Service Payment Plans.

**Note 4:** Effective March 17, 2024, customers may not establish new term plans of greater than month-to-month for High Capacity Service Channel Service Payment Plans. (N)



## E2. GENERAL REGULATIONS

### E2.4 Payment Arrangements and Credit Allowances (Cont'd)

#### E2.4.9 Optional Payment Plan (Cont'd)

##### A. Channel Services Payment Plan (Cont'd)

##### 4. Disconnects (Cont'd)

- a. When a service or rate element, included under a CSPP arrangement, is disconnected prior to expiration of the selected service period, termination liability charges apply as set forth in the rate regulations in this Tariff for such service. Remaining services or rate elements will not be affected by such disconnections.
- b. When a tariffed service under a CSPP arrangement is disconnected prior to the expiration of a selected service period as a result of a change of Tariff jurisdiction and/or a customer requested change to a higher order of a separately tariffed service, termination liability charges will not apply when:
  - the completed service period is twelve months, or twenty-five percent of the length of the originally selected service period, whichever is greater, and
  - the service period of the new CSPP arrangement for the higher order of service is a minimum 24 month<sup>1, 2, 3</sup> service period or equals/exceeds the remaining service period of the disconnected arrangement, whichever is greater, and
  - the service orders to install the new higher order of service and disconnect the old service are related together and there is no lapse in service between installation of the higher order of service and disconnection of the existing service, and
  - the service orders are for the same customer at the same location

For the purposes of determining a higher order of service, the following ranking will be used (Analog Voice Grade (a.k.a. BellSouth SPA DS0 VG) = lowest, Channels for use with BellSouth Managed Shared Ring service = Highest):

Analog Voice Grade (a.k.a. BellSouth SPA DS0 VG) Services  
DS0 (a.k.a. BellSouth SPA DS0 Digital Data) Services  
DS1 High Capacity (a.k.a. BellSouth SPA DS1) Service  
SMARTPath<sup>®</sup> Service (a.k.a. BellSouth SPA Shared Ring)

##### 5. Moves of Equipment

- a. The appropriate nonrecurring charges for inside moves for items associated with channel services as specified in this and other Tariffs are applicable. This type movement will not affect the contract period.
- b. Customer requests for moves of service(s) under CSPP, other than inside moves, will be subject to the conditions stated in 11. following.

##### 6. Requests for Changes in Length of Optional Payment Period

- a. Subsequent to the establishment of a contract with a CSPP period, and prior to the completion of that period, the existing payment period may be replaced by:
  - (1) A currently offered payment period at the current rates, with a length equal to or longer than the time remaining in the existing service agreement, subject to the following conditions:

**Note 1:** Effective March 23, 2019, Customers may not: (1) Establish CSPPs for Derived Data Channel Service, Digital Data Access Service and FlexServ Service, (2) Establish CSPPs greater than 36 months for High Capacity Service and SMARTPath Service, and (3) Convert or renew CSPPs for Derived Data Channel Service, Digital Data Access Service, FlexServ Service, High Capacity Service and SMARTPath Service.

**Note 2:** Effective November 1, 2022, customers may not establish new term plans of greater than 24 months for High Capacity Service Channel Service Payment Plans.

**Note 3:** Effective March 17, 2024, customers may not establish new term plans of greater than month-to-month for High Capacity Service Channel Service Payment Plans. (N)

## E2. GENERAL REGULATIONS<sup>1</sup>

### E2.4 Payment Arrangements and Credit Allowances (Cont'd)

#### E2.4.9 Optional Payment Plan (Cont'd)

##### A. Channel Services Payment Plan (Cont'd)

6. Requests for Changes in Length of Optional Payment Period<sup>3,4</sup> (Cont'd) (C)
  - a. Subsequent to the establishment of a contract with a CSPP period, and prior to the completion of that period, the existing payment period may be replaced by: (Cont'd)
    - (1) A currently offered payment period at the current rates, with a length equal to or longer than the time remaining in the existing service agreement, subject to the following conditions: (Cont'd)
      - No credit will be given for payments made during the formerly selected period.
      - The new payment period begins with the new CSPP effective date.
      - No termination charge applies for the remaining portion of the former payment period.
      - Nonrecurring charges will not be reapplied.
    - (2) A currently offered payment period at the current rates, with a length shorter than the time remaining in the existing service agreement, subject to the following conditions:
      - No credit will be given for payments made during the formerly selected period.
      - The new payment period begins with the new CSPP effective date.
      - A termination charge applies for the remaining portion of former payment period.
      - Nonrecurring charges will not be reapplied.
7. Renewal Options (C)
  - a. The customer has the following renewal<sup>2,3,4</sup> options: (C)
    - (1) Prior to completion of the current payment period, any period available under the CSPP may be selected at the rates in effect for new customers at the time of the renewal.<sup>2,3,4</sup> The customer will be charged the current rate for the newly selected payment period, commencing the day following completion of the prior payment period.
    - (2) Service may be continued on a month-to-month basis at the current rate for the one-month payment period, unless otherwise specified in this Tariff. The customer has no additional service commitment and, consequently, when service is terminated will not be subject to any termination charge. The one month service will be subject to Company-initiated rate adjustments when approved by the appropriate regulatory authority.
    - (3) If the customer does not elect an additional payment period or does not request discontinuance of service, service will be continued at the monthly rate currently in effect for the month-to-month payment rate, under the terms specified in (2) preceding.
  - b. Any new services added to a customer's network at the time of renewal will be subject to all appropriate nonrecurring charges. Nonrecurring charges are not applicable for services renewed under the CSPP.
  - c. The Company may discontinue or change any or all renewal options with approval of the appropriate regulatory authority.

**Note 1:** Text is shown as new due to reissue of all Tariff Sections. No changes in rates or regulations were made with this filing.

**Note 2:** Effective March 23, 2019, Customers may not: (1) Establish CSPPs for Derived Data Channel Service, Digital Data Access Service and FlexServ Service, (2) Establish CSPPs greater than 36 months for High Capacity Service and SMARTPath Service, and (3) Convert or renew CSPPs for Derived Data Channel Service, Digital Data Access Service, FlexServ Service, High Capacity Service and SMARTPath Service.

**Note 3:** Effective November 1, 2022, customers may not establish new term plans of greater than 24 months for High Capacity Service Channel Service Payment Plans.

**Note 4:** Effective March 17, 2024, customers may not establish new term plans of greater than month-to-month for High Capacity Service Channel Service Payment Plans. (N)

## E2. GENERAL REGULATIONS

### E2.4 Payment Arrangements and Credit Allowances (Cont'd)

#### E2.4.9 Optional Payment Plan (Cont'd)

##### A. Channel Services Payment Plan (Cont'd)

##### 7. Renewal Options (Cont'd)

- d. When a customer renews a CSPP arrangement, the rates and charges in effect on the first day of service of the renewal will apply.
- e. Recognition of previous service will be given to customers who renew an existing CSPP arrangement<sup>1, 2, 3</sup>, for the same or larger system(s) and all associated rate elements at the same location(s), provided that the length of the new CSPP arrangement is a minimum 24 month<sup>1</sup> service period or equals/exceeds the remaining service period of the original CSPP arrangement, whichever is greater. An example of a larger system is the renewal of an Analog Voice Grade (a.k.a. BellSouth SPA DS0 VG) service with a DS1 High Capacity (a.k.a. BellSouth SPA DS1) service. (C)
- f. Recognition of previous service will be given to month-to-month customers with a service date of January 1, 1994 or later who convert to a CSPP arrangement, provided the minimum service period has been met. For customers whose service date is January 1, 1994 or earlier, recognition will be given for the previous service back to January 1, 1994. For customers whose service date is later than January 1, 1994, recognition for the previous service will be given back to the actual service date.
- g. To determine the appropriate CSPP<sup>1, 2, 3</sup> Payment Plan for the renewed arrangement, recognition of service will consist of the sum of months in service of the completed service arrangement and the sum of the months of the proposed service period of the CSPP arrangement<sup>1, 2, 3</sup>. For example, a CSPP arrangement for a 36-month service period under the 36 month Term Payment Plan is renewed for 24 months<sup>2, 3</sup> with no changes at the end of the 36 month period. The sum of months for the completed and proposed service periods would equal 60 months<sup>2</sup> and would be billed under the 60 month<sup>2, 3</sup> Term Payment Plan. Another example is a Month-to-Month customer, in service for 15 months, who wishes to convert to a 60-month<sup>2, 3</sup> CSPP arrangement with no changes. The combined service period of the Month-to-Month arrangement and the CSPP arrangement is equal to 75 months<sup>2, 3</sup>, which would be billed under the 84 month<sup>2, 3</sup> Term Payment Plan. (C)

##### 8. Transfer of Service

- a. Service may be transferred to a new customer at the same location upon prior written concurrence by the new customer as specified in this Tariff. This does not constitute a disconnect of service or a discontinuance of an existing CSPP arrangement. The new customer will be subject to all provisions and equipment configurations currently in effect for the previous customer. Regulations concerning transfer of service between subscribers as stated in other sections of this Tariff also apply under CSPP.

##### 9. Prepayment

- a. For payment periods longer than one month, the customer may prepay the total outstanding recurring monthly rates. The prepayment of monthly rates in no way constitutes a purchase and the Company retains full ownership of all services covered by the prepayment. The following conditions apply:
  - (1) Customers who prepay six months or more will have an allowance applied. The prepayment factor to be used for each month prepaid will be revised periodically by the Company.
  - (2) Monthly rates for all services covered by a single Letter of Election must be prepaid. Monthly rates must be prepaid for services added subsequently and placed on the same Letter of Election (i.e., customer-elected coterminous option) with a prepaid system.

**Note 1:** Effective March 23, 2019, Customers may not: (1) Establish CSPPs for Derived Data Channel Service, Digital Data Access Service and FlexServ Service, (2) Establish CSPPs greater than 36 months for High Capacity Service and SMARTPath Service, and (3) Convert or renew CSPPs for Derived Data Channel Service, Digital Data Access Service, FlexServ Service, High Capacity Service and SMARTPath Service.

**Note 2:** Effective November 1, 2022, customers may not establish new term plans of greater than 24 months for High Capacity Service Channel Service Payment Plans.

**Note 3:** Effective March 17, 2024, customers may not establish new term plans of greater than month-to-month for High Capacity Service Channel Service Payment Plans. (N)

## E2. GENERAL REGULATIONS

(T)

### E2.4 Payment Arrangements and Credit Allowances (Cont'd)

#### E2.4.9 Optional Payment Plan (Cont'd)

##### A. Channel Services Payment Plan (Cont'd)

##### 9. Prepayment (Cont'd)

##### a. (Cont'd)

- (3) Customers who change the length of a prepaid payment period will be credited any unused portion of the prepayment, subject to termination charges as specified in 4. preceding.
- (4) Customers who prematurely disconnect will have termination charges deducted from the prepaid amount and any balance credited to their bill.

##### 10. Exception to Termination Liability For State, County, and Municipal Governments

- a. In the event that all or any part of the service is disconnected at customer request prior to expiration of any selected payment period of greater than one month's duration, the customer will be required to pay a termination charge as stated in the service tariffs. The Tariffs provisions concerning termination liability for recurring charges only shall be inapplicable to any state, county or municipal governmental entity when there is in effect, as a result of action by such entity and through a duly constituted legislative, administrative body:

- (1) a statute;
- (2) an ordinance;
- (3) a policy directive; or
- (4) a constitutional provision

which restricts or prohibits an additional contractual payment for early termination of a contract by any such entity, or agency thereof, due to an unavailability of funding. When service is being provided and funding to the governmental entity for such service becomes unavailable, the governmental entity may cancel the service without additional payment obligation. Provided however, that if the governmental entity cancels the service for any reason other than the unavailability of funds, the termination liability provisions in the Tariff shall apply.

##### 11. Exceptions to Termination Liability regarding *BellSouth Expanded* Interconnection Service arrangements

Pursuant to the Florida Public Service Commission Order No. PSC-95-1188-FOF-TP in Docket No. 92-1074-TP, issued September 21, 1995, upon the effective date of *BellSouth Expanded* Interconnection Service, customers with the Company's dedicated access services, with terms equal to or greater than, three years, entered into on or before February 1, 1994, shall be permitted to switch those services to competitive alternatives during the 90-day period after *BellSouth Expanded Interconnection Service* arrangements are available in a Company central office.

If a customer chooses to switch to a competitor, termination charges to the Company's contract for service shall be limited to the additional charges that the customer would have paid for the contract covering the term actually used, plus the prime rate of interest.

##### 12. Moves of Service(s) under CSPP

Termination Liability Charges will not apply to customer requests for moves of service under CSPP from one location to another location subject to the following:

FLORIDA

ISSUED: February 14, 1997

EFFECTIVE: March 1, 1997

BY: Joseph P. Lacher, President -FL  
Miami, Florida

## E2. GENERAL REGULATIONS

### E2.4 Payment Arrangements and Credit Allowances (Cont'd)

#### E2.4.9 Optional Payment Plan (Cont'd)

##### A. Channel Services Payment Plan (Cont'd)

###### 12. Moves of Service(s) under CSPP (Cont'd)

- a. The original and new premises locations must be in Company territory within the same state.
- b. The move from the original location to the new location must be completed within thirty days of the original premises disconnect date.
- c. No lapse in billing will occur for moves of service under CSPP.
- d. Orders to disconnect the existing service and reestablish it at the new location must be related.
- e. Any local channels, interoffice channels, and/or optional features and functions from the original location that are not reestablished at the new location will be subject to applicable Termination Liability charges.
- f. Any additions made at the new location will be treated as coterminous additions in accordance with 3. preceding.
- g. All regulations and charges for changes made to the service coincident to the move shall apply.
- h. All appropriate nonrecurring charges for moves of service under CSPP as specified elsewhere in this Tariff will apply.
- i. Moves of services that involve a change of jurisdiction, e.g., intraLATA to interstate, will not be treated as a disconnect of service with regard to Termination Liability charge application. The customer must subscribe to a payment arrangement offered in the appropriate tariff which is a minimum 24-month service period or equals/exceeds the remaining contract period, whichever is greater.

##### B. Fast Packet Services Payment Plan

###### 1. General

- a. The regulations specified herein are applicable only to specific Fast Packet Access Services as indicated in the rate regulations for such services in Section E21. following.
- b. The terms of this Fast Packet Services Payment Plan (SPP) apply to such specific Fast Packet Services except as noted in the rate regulations for the given service.
- c. The Fast Packet SPP allows customers to pay stabilized monthly rates for fixed service periods selected by the customer. The two payment plans offered are as follows:
  - (1) Term Payment Plan A - service periods may be selected from 12 months to 24 months in length.
  - (2) Term Payment Plan B - service periods may be selected from 25 months to 48 months in length.
- d. When the customer renews a Fast Packet SPP arrangement under E2.4.9.B.7.d. following and the sum of months is greater than the number of months for which the services is available under a Fast Packet SPP, the current rates for the longest payment plan available for that service will apply. For example, when the customer extends XACDS (*a.k.a. BellSouth Exchange Access Connectionless Data service*) beyond 48 months, Payment Plan B rates will apply.

## E2. GENERAL REGULATIONS

(T)

### E2.4 Payment Arrangements and Credit Allowances (Cont'd)

#### E2.4.9 Optional Payment Plan (Cont'd)

##### B. Fast Packet Services Payment Plan (Cont'd)

###### 1. General (Cont'd)

- e. When the customer orders service to be provided under a Fast Packet SPP arrangement, the customer must designate to the Company the payment plan and the service period desired, e.g., Plan B and 36 months.
- f. Rates stabilized under a Fast Packet SPP arrangement are exempt from Company initiated increases, however, decreases to any rate element will automatically flow through to the customer.

###### 2. Application of Rates and Charges

- a. The rates and charges applicable are those in effect as set forth in the rate regulations of this tariff for the particular Fast Packet Access Service involved as of the Application Date, provided that the actual service date does not exceed the later of the following.

- (1) the Service Date under a standard service interval, or
- (2) the earliest date on which service can reasonably be made available to the customer by the Company.

- b. If the customer desires a service date later than as provided in A. preceding, the rates and charges in effect at the time of the actual service date are applicable.

- c. The customer will be required to pay a Termination Liability Charge in the event that all or any part of a service is disconnected at the customer's request prior to expiration of any selected payment period of greater than one month's duration *except as specified in E2.4.9.B.4 following*.

(C)

- d. The Termination Liability Charge is determined by multiplying the number of months remaining in the contract payment period by the contracted monthly rate by 90 percent.

- (1) For example, a customer subscribes to a Fast Packet Transport Service using Term Payment Plan A and selects the 18-month payment period. After 12 months the customer chooses to terminate service. The Termination Liability Charge is calculated by multiplying 6 months (18 months - 12 months) by the monthly rate by 90 percent.

###### 3. Additions

- a. Additions of services or rate elements (e.g., Network Interfaces) must be under a new Fast Packet SPP arrangement at rates and charges as specified in E2.4.9.B.2. preceding.
- b. Termination charges for premature disconnection of added contractual services will apply as set forth under Disconnects in E2.4.9.B.4. following.
- c. Additions under Fast Packet SPP are exempt from Company-initiated rate changes for all payment periods longer than one month. However, decreases for any rate element will automatically flow through to the customer.

###### 4. Disconnects

- a. When a service or rate element, included under a Fast Packet SPP arrangement, is disconnected prior to expiration of the selected service period, Termination Liability Charges apply as set forth in E2.4.9.B.2. preceding *except as specifically stated otherwise in E2.4.9.B.4.b following*. Remaining services or rate elements will not be affected by such disconnections.

(C)(M)

## E2. GENERAL REGULATIONS

### E2.4 Payment Arrangements and Credit Allowances (Cont'd)

#### E2.4.9 Optional Payment Plan (Cont'd)

##### B. Fast Packet Services Payment Plan (Cont'd)

##### 4. Disconnects (Cont'd)

- b. When a tariffed service under a Fast Packet SPP arrangement is disconnected prior to the expiration of a selected service period as a result of a customer requested change at the same location to either another speed of the same tariffed service or to another Fast Packet Access Service under an Optional Payment Plan, termination liability charges will not apply when:

- (1) The completed service period is *a minimum of six (6) months*, and
- (2) The service period of the new Optional Payment Plan arrangement for the newly selected service is equal to or longer than the remaining service period of the disconnected arrangement, and
- (3) The newly selected service is a transmission speed that is either higher than the old service, or is a transmission speed that is the next lower transmission speed from the old service, and
- (4) The service orders to install the newly selected service and disconnect the old service are related together and received by the Telephone Company at the same time, and there is no lapse in service between installation of the newly selected service and disconnection of the existing service.

(C)

Nonrecurring charges apply for the installation of the newly requested service. Termination liability charges may apply for changes to associated Special Access Services under an Optional Payment Plan as set forth in tariffs regulating those services.

##### 5. Moves of Service Under Fast Packet SPP

- a. Termination Liability Charges will not apply to customer requests for moves of service under Fast Packet SPP from one location to another location subject to the following:

- (1) The original and new premises locations must be in Company territory within the same state.
- (2) The move from the original location to the new location must be completed within thirty days of the original premises disconnect date.
- (3) No lapse in billing will occur for moves of service under Fast Packet SPP.
- (4) Orders to disconnect the existing service and re-establish it at the new location must be related together and received by the Company at the same time.
- (5) Any rate elements (i.e., Network Interfaces) from the original location that are not re-established at the new location will be subject to applicable Termination Liability Charges.
- (6) Any additions made at the new location will be treated as coterminous additions in accordance with E2.4.9.B.3. preceding.
- (7) All regulations and charges for changes made to the service coincident to that move shall apply.
- (8) Moves of service that involve a change of jurisdiction (e.g., interstate to intrastate) will not be treated as a disconnect of service with regard to Termination Liability Charge application. The customer must subscribe to a payment arrangement offered in the appropriate intrastate tariff which is equal to or greater than the remaining contract period.

##### 6. Requests for Changes in Length of Optional Payment Period

- a. Subsequent to the establishment of a Fast Packet SPP arrangement and prior to the completion of the selected service period for that arrangement, the Fast Packet SPP arrangement may be replaced by a new Fast Packet SPP arrangement at rates and charges in effect on the first day of service under the new Fast Packet SPP arrangement, subject to the following conditions:

- (1) No credit will be given for payments made under the original Fast Packet SPP arrangement except for credits allowed in E2.4.9.A. following.
- (2) The service period selected for the new Fast Packet SPP arrangement begins on the new Fast Packet SPP effective date but not later than the expiration date of the Fast Packet SPP being replaced.
- (3) Nonrecurring charges will not be reapplied for existing services.

## E2. GENERAL REGULATIONS<sup>1</sup>

(N)

### E2.4 Payment Arrangements and Credit Allowances (Cont'd)

#### E2.4.9 Optional Payment Plan (Cont'd)

##### B. Fast Packet Services Payment Plan (Cont'd)

##### 6. Requests for Changes in Length of Optional Payment Period (Cont'd)

##### a. (Cont'd)

- (4) If the new Fast Packet SPP arrangement has a service period shorter in length than the time remaining under the service period for the existing Fast Packet SPP arrangement, the change to the new Fast Packet SPP constitutes a disconnection of the existing Fast Packet SPP arrangement for which Termination Liability Charges apply.

##### 7. Renewal Options

- a. When a service period under an existing Fast Packet SPP arrangement is completed, the customer may select a new Fast Packet SPP arrangement at rates and charges in effect on the first day of service under the new Fast Packet SPP arrangement, continue service under the month-to-month rates, or discontinue service with no Termination Liability Charge. If the customer does not elect to either discontinue service or continue service under a new Fast Packet SPP arrangement, service will be continued under month-to-month rates.
- b. Any new rate elements added to a customer's network or changes to existing services at the time of renewal will be subject to all appropriate nonrecurring charges.
- c. When a customer renews a Fast Packet SPP arrangement, the rates and charges in effect on the first day of service of the renewal will apply.
- d. Recognition of previous service will be given to customers who renew an existing Fast Packet SPP arrangement, for all associated rate elements at the same location(s), provided that the length of the new Fast Packet SPP arrangement is equal to or greater than the remaining service period of the original Fast Packet SPP arrangement.
- e. Recognition of previous service back to the actual service date will be given to month-to-month customers who convert to a Fast Packet SPP arrangement.
- f. To determine the appropriate Fast Packet SPP Payment Plan for the renewed arrangement, recognition of service will consist of the sum of months in service of the completed service arrangement and the sum of the months of the proposed service period of the Fast Packet SPP arrangement. For example, a Fast Packet SPP arrangement for a 24-month service period under Term Payment Plan A is renewed for 16 months with no changes at the end of the 24-month period. The sum of months for the completed and proposed service periods would equal 40 months and would be billed under Term Payment Plan B.  
Another example is a month-to-month customer, in service for 15 months, who wishes to convert to a 24-month Fast Packet SPP arrangement with no changes. The combined service period of the Month-to-Month arrangement and the Fast Packet SPP arrangement is equal to 39 months which would be billed under Payment Plan B.

##### 8. Transfer of Service

- a. Service transferred to a new customer at the same location in accordance with E2.1.2 preceding does not constitute a disconnect of service or a discontinuance of an existing Fast Packet SPP arrangement.

**Note 1:** Text is shown as new due to reissue of all Tariff Sections. No changes in rates or regulations were made with this filing.



## E2. GENERAL REGULATIONS

### E2.4 Payment Arrangements and Credit Allowances (Cont'd)

#### E2.4.9 Optional Payment Plan (Cont'd)

##### B. Fast Packet Services Payment Plan (Cont'd)

###### 9. Prepayment

- a. Upon entering into a Fast Packet SPP arrangement, the customer may prepay the outstanding recurring monthly rates in whole or in part for all rate elements included in the Fast Packet SPP arrangement. The Company retains full ownership of services in accordance with E2.4.7 preceding. The following conditions apply:
- (1) A prepayment allowance will be applied to the amount prepaid for each given month equal to 0.6666% per month compounded monthly for the number of months the payment is advanced.
  - (2) The customer may elect the percentage of the monthly rates to be prepaid, provided however, the same percentage shall apply to all rate elements included in the Fast Packet SPP arrangement for all months remaining in the service period.
  - (3) The same prepayment percentage will apply in the event the customer adds services to an existing Fast Packet SPP arrangement subsequent to the establishment of the service.
  - (4) When the customer who has prepaid recurring monthly rates replaces the existing Fast Packet SPP arrangement with a new Fast Packet SPP arrangement, the customer will be credited with that portion of the prepayment amount, representing a prepayment of the monthly recurring rates remaining in the existing Fast Packet SPP arrangement.
  - (5) Customers who prematurely disconnect will have Termination Liability Charges deducted from the unused prepaid balance. The remaining prepaid balance, if any, will be credited to their bill.

##### C. Transport Payment Plan (TPP)

###### 1. General

- a. The regulations and terms specified herein are applicable only to BellSouth Dedicated Ring, *BellSouth Metro Ethernet service* and/or SMARTRing service (a.k.a. *BellSouth Dedicated Ring*) access services as indicated in the rate regulations in Section 6 of Tariff FCC No. 1 and Section E7. of this intrastate Tariff. (C)
- b. The TPP allows customers to pay stabilized monthly rates for fixed service periods selected by the customer. The three payment plans offered are as follows:
- (1) Payment Plan A, service periods may be selected from 12 months to 36 months in length.
  - (2) Payment Plan B, service periods may be selected from 37 months to 60 months in length.
  - (3) Payment Plan C, service periods may be selected from 61 months to 96 months in length.
- c. For conversions to the TPP arrangement, the number of months under the TPP arrangement must equal or exceed the number of months remaining under the CSPP arrangement.
- d. Termination liability charges and nonrecurring charges will not apply when a CSPP customer converts to a TPP arrangement.
- e. When the customer renews a TPP arrangement and the sum of months in service added to the new contract period is greater than the number of months for which the service is available under a TPP, the current Payment Plan C rates will apply.
- f. When the customer orders service to be provided under a TPP arrangement, the customer must designate to the Telephone Company the payment plan desired.
- g. Rates stabilized under a TPP arrangement are exempt from Telephone Company initiated increases, however, decreases for any rate element will automatically be reflected in the rates charged to the customer.
- h. Conversions of LightGate service (a.k.a BellSouth SPA Point to Point Network), BellSouth Dedicated Ring and/or SMARTRing service (a.k.a BellSouth Dedicated Ring) TPP arrangements to a higher order of CSPP service are allowed.

ISSUED: May 31, 2013

EFFECTIVE: July 2, 2013

BY: Marshall M. Criser III, President -FL  
Miami, Florida

## E2. GENERAL REGULATIONS

### E2.4 Payment Arrangements and Credit Allowances (Cont'd)

#### E2.4.9 Optional Payment Plan (Cont'd)

##### C. Transport Payment Plan (Cont'd)

##### 2. Application of Rates

- a. The stabilized monthly recurring rates as set forth in Section 6 of Tariff FCC No. 1 and Section E7. of this intrastate Tariff are set as of the Application Date for BellSouth Dedicated Ring, **BellSouth Metro Ethernet service** and/or SMARTRing service (a.k.a. BellSouth Dedicated Ring), provided that the actual service date does not exceed the latter of the following:
  - (1) the Service Date under a standard service interval, or
  - (2) the earliest date by which service can be made available to the customer by the Telephone Company.
- b. If the customer desires a service date later than as provided in a. preceding, the stabilized monthly recurring rates in effect on the service date are applicable.

##### 3. Additions

- a. Additions of services or rate elements, to existing BellSouth Dedicated Ring and/or SMARTRing service (a.k.a. **BellSouth** Dedicated Ring) systems, to activate spare or unused capacities, must be activated under the same rate plan as the existing TPP arrangement. BellSouth Dedicated Ring and/or SMARTRing service (a.k.a. BellSouth Dedicated Ring) channel interfaces must be activated as set forth in Section 6 of Tariff FCC No. 1 and Section E7. of this intrastate Tariff.

##### 4. Disconnects

- a. Except as provided in b. through f. following, when a BellSouth Dedicated Ring, **BellSouth Metro Ethernet service** and/or SMARTRing service (a.k.a. BellSouth Dedicated Ring) rate element is disconnected prior to being in service for a 12-month period, (e.g., the minimum term for a Plan A TPP), the termination liability charge will be derived by multiplying the difference in rates between the current month-to-month rate and the rate for the TPP arrangement selected. For example, a customer subscribes to a TPP for 24 months (Plan A) and terminates service after 10 months. The termination liability charge will be applied by multiplying the number of months in service (10) by the difference between the month-to-month and Plan A monthly rates. With the exception of Renewal Options in 7 following, a four month minimum service period for BellSouth Dedicated Ring, **BellSouth Metro Ethernet service** and/or SMARTRing service (a.k.a. BellSouth Dedicated Ring) TPP customers will be applicable and all month-to-month regulations will be applicable.

When a BellSouth Dedicated Ring, **BellSouth Metro Ethernet service** or SMARTRing service (a.k.a. BellSouth Dedicated Ring) TPP customer disconnects a rate element prior to the 12 month TPP minimum, all current month-to-month nonrecurring charges associated with the BellSouth Dedicated Ring, **BellSouth Metro Ethernet service** or the SMARTRing service (a.k.a. BellSouth Dedicated Ring) ring level rate elements will apply.

BellSouth Dedicated Ring and SMARTRing service (a.k.a. BellSouth Dedicated Ring) service ring level rate elements are defined as following: Local Channel, Interoffice Channel, Internodal Channel, Alternate Central Office Channel, Customer Node and Central Office Node.

- b. Except as provided in c. through f. following, when a BellSouth Dedicated Ring, **BellSouth Metro Ethernet service** or SMARTRing service (a.k.a. BellSouth Dedicated Ring) TPP customer disconnects services or rate elements prior to the minimum number of months for the plan period selected, termination liability charges will apply. The termination liability charge will be derived at the time of disconnection by taking the difference between the rate for the TPP period for which the customer subscribed, and the rate for the TPP period that the customer's completed service would otherwise qualify, and multiplying the difference by the number of months service the customer completed under a TPP. For example, a customer subscribes to a TPP for 73 months (Plan C) and terminates service after 20 months (Plan A). The termination liability charge will be applied by multiplying the number of months in service (20) by the difference between the Plan A and Plan C monthly rates. When a BellSouth Dedicated Ring, **BellSouth Metro Ethernet service** or SMARTRing service (a.k.a. BellSouth Dedicated Ring) customer disconnects service after the minimum number of months for the TPP arrangement selected but prior to the actual expiration date of the TPP arrangement, termination liability charges do not apply.

## E2. GENERAL REGULATIONS

### E2.4 Payment Arrangements and Credit Allowances (Cont'd)

#### E2.4.9 Optional Payment Plan (Cont'd)

##### C. Transport Payment Plan (Cont'd)

##### 10. Disconnects (Cont'd)

- c. When a TPP arrangement is disconnected prior to the expiration of a plan period due to a customer requested change to a higher order of service at the same location, or to expand or upgrade an existing service, termination liability charges will not apply when:

- (1) the customer has completed at least 6 months of the originally selected TPP service period, and
- (2) the service period of the new arrangement for the new service is equal to or longer than the remaining service period of the disconnected arrangement, and
- (3) the service orders to install the new service and disconnect the old service are related together and received by the Telephone Company at the same time, and there is no lapse in service between installation of the higher order of service and disconnection of the existing service, and
- (4) the capacity of the new service is equal to or greater than the existing service. For converting LightGate service (a.k.a. BellSouth SPA Point to Point Network) to SMARTPath service DS3 Transport service (a.k.a. BellSouth SPA DS3 Shared Ring), the capacity of the LightGate service (a.k.a. BellSouth SPA Point to Point Network) is considered to be the quantity of DS3s activated on the LightGate service (a.k.a. BellSouth SPA Point to Point Network). *Specific changes of BellSouth Metro Ethernet service that are considered to be the same or higher order of service are set forth in E7.4.32 of this Tariff.*

For the purposes of determining a higher order of service in all payment plans, the following ranking will be used (Analog Voice Grade (a.k.a. BellSouth SPA DSO VG) service=lowest, SMARTRing service (a.k.a. BellSouth Dedicated Ring)=highest):

- Analog Voice Grade (a.k.a. BellSouth SPA DSO VG) services
- DSO (a.k.a. BellSouth SPA DSO Digital Data) Services
- DS1 (a.k.a. BellSouth SPA DS1) Services
- SMARTPath service (a.k.a. BellSouth SPA DS1 Shared Ring)
- SMARTRing service (a.k.a. BellSouth Dedicated Ring)/Channels for use with BellSouth Managed Shared Ring/BellSouth Dedicated Ring

- d. A termination liability charge will not apply to disconnects of channel interfaces associated with LightGate service (a.k.a. BellSouth SPA Point to Point Network), BellSouth Dedicated Ring and/or SMARTRing services (a.k.a. **BellSouth** Dedicated Ring).
- e. Disconnects, moves, or rearrangements involving the removal of the following BellSouth Dedicated Ring and SMARTRing service (a.k.a. BellSouth Dedicated Ring) rate elements, local channel, interoffice channel, customer node and central office node, to allow the placement of additional nodes and channels for existing customers where the total number of nodes does not decrease, will not be subject to termination liability charges.

(D)

## E2. GENERAL REGULATIONS

### E2.4 Payment Arrangements and Credit Allowances (Cont'd)

#### E2.4.9 Optional Payment Plan (Cont'd)

- C. Transport Payment Plan (Cont'd)
4. Disconnects (Cont'd)
- f. A change of jurisdiction from interstate to intrastate service constitutes a disconnection of service for which termination charges are applicable. However, if such service continues between the same serving locations, and the customer enters into a new TPP arrangement in the intrastate jurisdiction for the same or larger service capacity and associated rate elements for a service period equal to or greater than the service period remaining under the interstate TPP arrangement, no interstate termination liability charge will be applicable.
- (g) Termination liability charge will not apply to any OC-3+ SMARTRing service (a.k.a. BellSouth SPA Dedicated Ring) disconnected on or after July 4, 2015. (N)  
(N)
5. Moves of Service Under TPP
- a. Moves to a different building will be treated as a discontinuance and start of service and all associated nonrecurring charges will apply as stated in Section E7.4.5 except as provided in c. following. A four month minimum service period must be satisfied for all service rate elements serving the original building location. (T)
- b. Moves of service within the same building will not constitute a disconnection of service for purposes of the application of termination liability charges. Current month-to-month nonrecurring charges specified in Section E7.4.5 are applicable. (T)
- c. Termination Liability Charges will not apply to customer requests for moves of service to a different building subject to the following conditions:
- (1) The move from the original location to the new location must be completed within thirty days of the original premises disconnect date. For LightGate<sup>®</sup> service systems (a.k.a. BellSouth SPA Point to Point Network), the new customer premises must be served by the same serving wire center as the original location.
- (2) No lapse in billing will occur for moves of service under a TPP arrangement.
- (3) Orders to disconnect the existing service and reestablish it at the new location must be related together and received by the Telephone Company at the same time.
- (4) Any additions made at the new location will be handled in accordance with (3) preceding.
- (5) All regulations and charges for changes made to the service coincident with the move will apply.
- (6) All appropriate nonrecurring charges for moves of service as specified in Section E7.4.5 will apply. (T)
- Any rate elements or quantities for local channels, interoffice channels, and/or optional features and functions from the original location that are not reestablished at the new location will be subject to applicable Termination Liability Charges.
6. Requests for Changes in Length of Service Period
- a. Subsequent to the establishment of a TPP arrangement, and prior to the completion of the selected service period for that arrangement, the TPP arrangement may be replaced by a new TPP arrangement at rates and charges in effect on the first day of service under the new TPP arrangement, subject to the following conditions:
- (1) No credit will be given for payments made under the original TPP arrangement, except for credits allowed under 10.a. following.
- (2) The service period selected for the new TPP arrangement begins on the new TPP effective date but not later than the expiration date of the TPP being replaced.
- (3) Nonrecurring charges do not apply for existing services.
- (4) If the new TPP arrangement has a service period shorter in length than the time remaining under the service period for the existing TPP arrangement, the change to the new TPP arrangement constitutes a disconnection of the existing TPP arrangement for which termination liability charges apply.

## E2. GENERAL REGULATIONS

### E2.4 Payment Arrangements and Credit Allowances (Cont'd)

#### E2.4.9 Optional Payment Plan (Cont'd)

##### C. Transport Payment Plan (Cont'd)

###### 7. Renewal Options

- a. When a service period under an existing CSPP or TPP arrangement is completed, the customer may select a new TPP arrangement at rates and charges in effect on the first day of service under the new TPP arrangement, continue service under the month-to-month rates, or discontinue service with no termination liability charge. If the customer does not elect to either discontinue service or continue service under a new TPP arrangement, service will be continued under month-to-month rates. The TPP customer of record will have a 60-day grace period after which current month-to-month rates will apply. The stabilized monthly recurring rates as set forth in Section E7. *of this Tariff* remain in effect during the 60-day grace period. (T)
- b. Any new services added to a customer's network or changes to existing services at the time of renewal will be subject to all appropriate nonrecurring charges and four month minimum service period requirements.
- c. When a customer renews a TPP arrangement, the rates and charges in effect on the first day of service of the renewal will apply.
- d. To determine the appropriate TPP Payment Plan for the renewed arrangement, recognition of service will consist of the sum of months in service of the completed service arrangement and the sum of months of the proposed service period of the TPP arrangement.
- e. Recognition of previous service will be given to customers who renew an existing TPP arrangement, for the same or larger system(s) and all associated rate elements at the same location(s), provided that the length of the new TPP arrangement is equal to or greater than the remaining service period of the original TPP arrangement. Recognition for satisfying the four month service period will be given for renewals of the same size systems, rings, and all associated rate elements. Conversion to larger systems and rings will incur new four month minimum service requirements.
- f. Recognition of previous service will be given to month-to-month customers who convert to a TPP arrangement, for the same or larger system(s) and all associated rate elements at the same location(s), provided the four month minimum service period for that service has been met.
- g. Recognition of previous service will be given to TPP customers who convert from CSPP arrangements provided the customer is the original customer of record at the time of transfer.
- h. When an existing, BellSouth Dedicated Ring, *BellSouth Metro Ethernet service* and/or SMARTRing service (a.k.a. BellSouth SPA Dedicated Ring) customer has completed the selected TPP commitment period and the service reverts to month-to-month service, only the month-to-month service will receive recognition for determining the appropriate TPP arrangement or any subsequent TPP arrangement. (C)

###### 8. Transfer of Service

- a. Service transferred to a new customer at the same location in accordance with E2.1.2 preceding does not constitute a disconnect of service or a discontinuance of an existing TPP arrangement.

###### 9. Prepayment

- a. Upon entering into a TPP arrangement, the customer may prepay the outstanding recurring monthly rates in whole or in part for all rate elements included in the TPP arrangement. The following conditions apply:
  - (1) A prepayment allowance will be applied to the amount prepaid for each given month equal to 0.6666 percent per month compounded monthly for the number of months the payment is advanced.
  - (2) The customer may elect the percentage of the monthly rates to be prepaid, provided however, the same percentage shall apply to all rate elements included in the TPP arrangement for all months remaining in the service period.
  - (3) This same prepayment percentage will apply in the event the customer adds services to an existing TPP arrangement subsequent to the establishment of the service.
  - (4) When a customer who has prepaid recurring monthly rates replaces the existing TPP arrangement with a new TPP arrangement, the customer will be credited with that portion of the prepayment amount, representing a prepayment of the monthly recurring rates remaining in the existing TPP arrangement.
  - (5) Customers who disconnect service and incur termination liability charges, such charges shall be deducted from the unused prepaid balance. The remaining prepaid balance, if any, will be credited to their bill.

## E2. GENERAL REGULATIONS

### E2.4 Payment Arrangements and Credit Allowances (Cont'd)

#### E2.4.10 Service Installation Guarantee

- A. The Company assures that orders for services to which the Service Installation Guarantee applies will be installed and available for customer use no later than the Service Date as specified in E5.2.4.B. following. The Service Installation Guarantee is applicable only as specified in Section 6.7.1 (A) of Tariff FCC No. 1 and Section E7.4.1.A. of this intrastate Tariff *and for the DS1 and DS3 cross connect element in E20.1.6* following. (C)  
(C)
- B. The failure of the Company to meet this commitment will result in the credit of an amount equal to the nonrecurring charges associated with the individual service having the missed Service Date being applied to the customer's bill. The credit will include only nonrecurring charges associated with the services specified in Section 6.7.1 (A) of Tariff FCC No. 1 and Section E7.4.1.A. of this intrastate Tariff *and the DS1 and DS3 cross connect element in E20.1.6* following for which nonrecurring charges are applicable. The nonrecurring charges will be credited at the rate at which they were billed. The credit will not be provided if a credit of the same nonrecurring charge for the same service is provided under any other provisions of this Tariff. (C)  
(C)
- C. For Commercial Quality Video service (a.k.a. BellSouth SPA Commercial Quality Video) which is jointly provided by this Telephone Company and one or more other local exchange companies, the Service Installation Guarantee is applicable only for those portions of the Commercial Quality Video service (a.k.a. BellSouth SPA Commercial Quality Video) within this Telephone Company's serving territory and only if the failure to meet the commitment is the fault of this Telephone Company.
- D. For BellSouth Dedicated Ring and SMARTRing<sup>®</sup> service (a.k.a. BellSouth Dedicated Ring), the Service Installation Guarantee is applicable for all channel interface rate elements. BellSouth Dedicated Ring and SMARTRing<sup>®</sup> service (a.k.a. BellSouth Dedicated Ring) ring level rate elements are excluded from the Service Installation Guarantee. BellSouth Dedicated Ring and SMARTRing<sup>®</sup> service (a.k.a. BellSouth Dedicated Ring) ring level rate elements are defined as follows: Local Channel, Interoffice Channel, Internodal Channel, Alternate Central Office Channel, Customer Node and Central Office Node.
- E. Service Installation Guarantees do not apply:
  1. when failure to meet the Service Date occurs because of:
    - a. any act or omission, *which shall include an accurate and complete service order, from* this customer, any other customer or any third party, or of any other entity providing a portion of a service,
    - b. labor difficulties, governmental orders, civil commotions, criminal actions against the Company, acts of God, war, or other circumstances beyond the Company's control,
    - c. unavailability of the customer's facilities and/or equipment,

## E2. GENERAL REGULATIONS

### E2.4 Payment Arrangements and Credit Allowances (Cont'd)

#### E2.4.10 Service Installation Guarantee (Cont'd)

E. Service Installation Guarantees do not apply: (Cont'd)

2. to service requiring Special Construction as set forth in Section E14. following,
3. to Specialized Service or Arrangements or Individual Case Basis filings,
4. for jointly provisioned services,
5. to BellSouth Virtual Expanded Interconnection service arrangements, except for the cross-connect element, as set forth in E20.1.6 following, or
6. to other telephone companies concurring in the rates and regulations of the Company; provided however, that the following telephone company does also concur in the preceding provisions of Section E2.4.10 of this intrastate Tariff and Section 6 of Tariff FCC No. 1.

Vista-United Telecommunications

7. to BellSouth SWA or Dedicated Access installation, moves and arrangements of service with an agreed upon service date interval of four business days or less following the Application Date of the service order.

In addition, Service Installation Guarantees will not apply during a declared National Emergency. Priority installation of National Security Emergency Preparedness (NSEP) telecommunications services shall take precedence.

#### E2.4.11 Cost Assessment Charge (CAC)

- A. A Cost Assessment Charge is assessed on a percentage basis against all billed revenue for business Customers subscribing to the transport services listed below. The CAC is established to recover property taxes. This charge is not a tax or fee that the government requires AT&T to collect from Customers. The CAC will not apply to Federal, State or Local Government Accounts, or to any accounts identified in the billing systems of the Company as being exempt from application of the Federal Universal Service Fund (FUSF).

Description

Monthly Rate

Cost Assessment Charge (CAC)

Transport services

7.00%

(0)

- BellSouth Metro Ethernet Service
- AT&T Switched Ethernet Service
- AT&T Dedicated Ethernet Service

**E2.4.12 Reserved for Future Use**

**E2.4.13 Reserved for Future Use**

**E2.4.14 Reserved for Future Use**

**E2.4.15 Reserved for Future Use**

## E2. GENERAL REGULATIONS

### E2.4 Payment Arrangements and Credit Allowances (Cont'd)

#### E2.4.16 Commitment Guarantee Program

##### A. General

1. The Commitment Guarantee Program will provide a credit to end users should the Company fail to meet its commitment in connection with installation or repair of service(s) provided via Company facilities. The term "Commitment" denotes an undertaking by the Company to install or repair service(s) as agreed to by the Company. (M)
2. The failure of the Company to meet its commitment will result in a credit being applied to the end user's bill, when contact is initiated by the end user, unless an exception is applicable. (M)
3. Where a service is jointly provided with another Local Exchange Carrier (LEC), the guarantee is applicable only to installation or repair commitments made to end users by the Company. This guarantee is not applicable to commitments made by other LECs, regardless of their concurrence in this Tariff. (M)

##### B. Application

1. In the event Company contact is initiated by the end user, in reference to the provisions of A. preceding, the Company will arrange for a credit of \$100.00 on an end user's account for the missed commitment, unless an exception is applicable. The credit will be applied against the total amount due on the end user's bill. (M)
2. One credit will apply, under the provisions of 1. preceding, per end user commitment missed.
3. More than one attempt to invoke the guarantee, for the same commitment and end user, will be disallowed.
4. The credit will apply in addition to waivers, promotions, or other guarantees in effect at the time of the missed commitment unless specifically excluded.
5. The guarantee is applicable to services provided in this Tariff except as noted in C. following.
6. Receipt of a credit under the provisions of 1. through 5. preceding will have no effect on recurring rates, nonrecurring charges, or minimum service periods according to the appropriate schedules for services filed elsewhere in this Tariff.
7. Credits issued to an end user's account, in excess of the total monthly rate in any one monthly billing period, may be applied to the following monthly billing period.
8. When service is terminated, any credit due will be applied to the final amount due the Company.
9. The program may be suspended by the Company during or following a natural disaster.

##### C. Exceptions

The Commitment Guarantee Program credit will not apply to:

1. commitments missed as a result of action initiated by, or information omitted by, the end user, any other end user, or any third party,
2. maintenance requests resulting from:
  - a. interruptions of service due to the failure of equipment or systems provided by others,
  - b. interruptions of a service where the Company is not afforded access to the premises where the service is terminated,
  - c. interruptions of a service which continue because of the failure of the end user to authorize replacement of any element of Special Construction, as set forth in E14.2.6 following,
  - d. negligence, or a willful act by the end user, or
  - e. suspension of service for non-payment of charges.
3. commitments missed during or as a result of labor difficulties, governmental orders, civil commotion, criminal actions against the Company, natural or man-made disasters, war, general network failures, a declared national emergency, or any other circumstances beyond the control and/or knowledge of the Company,
4. service(s) provided in conjunction with disaster relief,
5. BellSouth SWA service in Section 6 of Tariff FCC No. 1, or
6. Interexchange Carrier services.



ISSUED: November 23, 1998  
BY: Joseph P. Lacher, President -FL  
Miami, Florida

EFFECTIVE: December 8, 1998

## E2. GENERAL REGULATIONS

### E2.5 Connections

#### E2.5.1 General

- A. Equipment and Systems (i.e., terminal equipment, multiline terminating systems and communications systems) may be connected with BellSouth SWA and Dedicated Access Services furnished by the Company where such connection is made in accordance with the provisions specified in Technical Reference Publication AS No. 1 and in E2.1 preceding.

### E2.6 Definitions

Certain terms used herein are defined as follows:

#### ACCESS CODE

The term "Access Code" denotes a uniform five or seven digit code assigned by the Company to an individual IC. The five digit code has the form 10XXXX and the seven digit code has the form 101XXXX, 950-0XXX or 950-1XXX.

#### ACCESS MINUTES

The term "Access Minutes" denotes that usage of exchange facilities in Intrastate service for the purpose of calculating chargeable usage. On the originating end of an intrastate call, usage is measured from the time the originating End User's call is delivered by the Company to and acknowledged as received by the IC's facilities connected with the originating exchange. On the terminating end of an intrastate call, usage is measured from the time the call is received by the End User in the terminating exchange. Timing of usage at both originating and terminating ends of an intrastate call shall terminate when the calling or called party disconnects, whichever event is recognized first in the originating and terminating end exchanges, as applicable.

#### ACCESS ORDER

The term "Access Order" denotes a request for service received by the Company from an IC or End User or End User's authorized agent.

#### ACCESS TANDEM

The term "Access Tandem" denotes a Company switching system that provides a concentration and distribution function for originating or terminating traffic between end offices and an IC's terminal locations.

#### ACCESS TANDEM NETWORK

The term "Access Tandem Network" denotes the network of trunk groups for originating and/or terminating BellSouth SWA traffic between a single access tandem and Company subtending end offices.

#### ACCESS TANDEM SWITCHING

Access Tandem Switching denotes a rate element which provides for switching an IC's traffic through the Access Tandem to the Company's end office switch(es).

#### ACTUAL COST

The term "Actual Cost" denotes all costs charged against a specific case of special construction, including any appropriate taxes.

#### ALTERNATE CENTRAL OFFICE

The term "Alternate Central Office" denotes a wire center other than the serving wire center of the location of a customer node associated with BellSouth Dedicated Ring and SMARTRing® service (a.k.a. BellSouth Dedicated Ring).

#### ALTERNATIVE LOCAL EXCHANGE COMPANY (ALEC)

The term "Alternative Local Exchange Company or ALEC" denotes a landline telephone company, other than the Company, authorized by the Florida Public Service Commission to provide local exchange service within the Company's operating area in Florida. (M)

#### ANSWER/DISCONNECT SUPERVISION

The term "Answer/Disconnect Supervision" denotes the transmission of the switch trunk equipment supervisory signal (off-hook or on-hook) to the IC's point of termination as an indication that the called party has answered or disconnected. (M)

#### ASSUMED AVERAGE ACCESS MINUTES

The term "Assumed Average Access Minutes" denotes the usage that will be billed each month to ICs for BellSouth SWA FGA and BellSouth SWA FGB access arrangements served from Company serving end offices where recorded minutes of use are not available. (M)

## E2. GENERAL REGULATIONS

### E2.6 Definitions (Cont'd)

#### ATM

The term Asynchronous Transfer Mode (ATM) denotes one of the general class of packet switching technologies that relay traffic via an address contained within the packet (referred to in ATM as cells). ATM is a switching method in which information does not occur periodically with respect to some reference such as a frame pattern.

#### ATM CELL

The term ATM cell denotes the fixed length packets utilized in ATM cell-based switching services. An ATM cell is 53 bytes long, consisting of a five-byte header containing the address and a fixed 48-byte information field.

#### ATM CELL-BASED SWITCHING

The term ATM cell-based switching denotes the transfer of fixed length ATM cells as opposed to variable length frames used in other packet switching technologies.

#### ATTENUATION DISTORTION

The term "Attenuation Distortion" denotes the difference in loss at specified frequencies relative to the loss at 1004 Hz, unless otherwise specified .

#### AVERAGE BUSINESS DAY (ABD)

The term "Average Business Day" denotes 8:00 A.M. to 5:00 P.M., Monday through Friday, excluding national holidays. For trunk measurement and provisioning, Saturdays and Sundays may be substituted for a weekday when the measured traffic load for the Saturday or Sunday consistently exceeds the traffic load for the least loaded weekday.

#### BALANCE (100 TYPE) TEST LINE

The term "Balance (100 Type) Test Line" denotes an arrangement in an end office which provides for balance and noise testing.

#### BASIC SERVICE ELEMENT

The term Basic Service Element denotes an optional network capability associated with a Basic Serving Arrangement.

#### BELLSOUTH DIRECTORY ASSISTANCE (INTRASTATE)

The term "BellSouth Directory Assistance" denotes the provision of telephone numbers by a Company operator when the operator location is accessed by a customer by dialing (NPA) 555-1212.

#### BELLSOUTH DIRECTORY ASSISTANCE ACCESS LOCATION (INTRASTATE)

The term "BellSouth Directory Assistance Access Location" denotes a Company office where Company equipment first receives the Directory Assistance call from an IC's premises and selects the first operator position to respond to the Directory Assistance call.

#### BELLSOUTH SWA BASIC SERVING ARRANGEMENT

The term BellSouth SWA Basic Serving Arrangement denotes the connection of a customer to and through the BOCs networks, and should be considered the fundamental connection to those networks.

#### BELLSOUTH SWA COMMON TRANSPORT

The term "BellSouth SWA Common Transport" denotes the transmission of the customer's switched access traffic between the Access Tandem and the end office, between the BellSouth SWA FGA dial tone office and the end office (for terminating traffic) and, between the end office which serves as the host office for a remote switching system or module (RSS or RSM) and the RSS or RSM.

## E2. GENERAL REGULATIONS

### E2.6 Definitions (Cont'd)

#### **BELLSOUTH SWA DEDICATED TRANSPORT**

The term "**BellSouth SWA Dedicated Transport**" denotes the transmission of the customer's switched access traffic utilizing dedicated facilities between the customer's serving wire center (SWC) and customer designated points, i.e. SWC to a Company Facility Hub (Hub), SWC to an Access Tandem, SWC to a customer designated end office, Hub to an Access Tandem, Hub to Hub, and Hub to an end office.

#### **BELLSOUTH SWA FGD AND BELLSOUTH SWA TSBSA 3 SIGNALING**

The term "**BellSouth SWA FGD and BellSouth SWA TSBSA 3 Signaling**" denotes the signaling system which is used, by equal access end offices, to transmit originating information and address digits to the customer's premises. Features of this system include overlap outpulsing, identification of the type of call, identification of the ten-digit telephone number of the calling party, and acknowledgment wink supervisory signals.

#### **BELLSOUTH WATS SERVING OFFICE**

The term "**BellSouth SWA WATS Serving Office**" denotes a telephone company designated serving wire center where switching, screening and/or recording functions are performed in connection with the closed-end of **BellSouth SWA WATS** or **BellSouth SWA WATS**-type services.

#### **BIT**

The term "Bit" denotes the smallest unit of information in the binary system of notation.

#### **BIPOLAR WITH 8 ZERO SUBSTITUTION (B8ZS)**

The term "Bipolar with 8 Zero Substitution" (B8ZS) denotes a line code which allows transport of an all zero octet over a DS1/1.544 Mbps High Capacity channel. B8ZS enables Clear Channel Capability on DS1/1.544 Mbps High Capacity service.

#### **BRIDGING WIRE CENTER**

The term "Bridging Wire Center" denotes the Company designated wire center in which bridging is accomplished.

#### **BUSINESS DAY**

The term "Business Day" denotes the times of day that a company is open for business. Generally, in the business community, these are 8:00 or 9:00 A.M. to 5:00 or 6:00 P.M., respectively, with an hour for lunch, Monday through Friday, resulting in a standard forty (40) hour work week. Due to the possibility of variations in Business Day hours based on company policy, union contract and location, verification of the hours should be made via contact with the specific company location involved.

#### **CABLE SPACE**

The term "Cable Space" denotes any passage or opening in, on, under/over or through the central office cable support structure (e.g., cable risers, cable racks, cable vault or alternate splicing chamber, etc.) required to bring fire retardant fiber optic riser cable from an Expanded Interconnection Service (EIS) arrangement to the location where the riser cable and the feeder cable meet and are spliced and the spaces between the splice and the conduit space, as well as the space between the EIS arrangement and the Company point of termination any other space required to bring other fire retardant communications cable from one EIS arrangement to another EIS arrangement of the same collocator.

#### **CALL**

The term "Call" denotes a communication including an off-hook signal and routing information, initiated by an IC or End User (calling party) and completed to a **BellSouth** Directory Assistance Access service location or End User (called party) or to an IC terminal location or in the case of **BellSouth SWA 8XX Toll Free Dialing Ten Digit Screening** service when the address code is provided to the office performing the translation or screening function.

#### **CARRIER IDENTIFICATION CODE (CIC)**

The term "Carrier Identification Code" (CIC) denotes a unique three or four digit access identification code that is assigned to an IC for use with **BellSouth SWA FGB** and/or **BellSouth SWA FGD** service.

#### **CARRIER OR COMMON CARRIER**

See Interexchange Carrier

#### **CCS**

The term "CCS" denotes a hundred call seconds which is a standard unit of traffic load that is equal to 100 seconds of usage or capacity of a group of servers (e.g., trunks).

BELLSOUTH  
TELECOMMUNICATIONS, INC.  
FLORIDA  
ISSUED: January 18, 2002  
BY: Joseph P. Lacher, President -FL  
Miami, Florida

ACCESS SERVICES TARIFF

Second Revised Page 50.1  
Cancels First Revised Page 50.1

EFFECTIVE: February 17, 2002

**E2. GENERAL REGULATIONS**

**E2.6 Definitions (Cont'd)**

CCS7 SIGNALING CONNECTION

The CCS7 Signaling Connection provides a 56 kbps facility dedicated to a single customer which originates at the customer's signaling point of interconnection in a LATA and terminates at a Company Signaling Transfer Point (STP) selected by the Company. This facility, connecting the customer to a BellSouth STP, is ordered to a Company FSPOI within the same LATA as the customer's signaling point of interconnection.

(N)  
(N)

CCS7 SIGNALING TERMINATION

The CCS7 Signaling Termination provides a dedicated point of interface at a Company STP for a customer's CCS7 Signaling Connection.

(N)  
(N)

CCS7 ACCESS ARRANGEMENT USAGE

CCS7 Access Arrangement Usage refers to messages traversing the Company's CCS7 Signaling network for call set-up (ISUP) and non-call set-up (TCAP) purposes.

(N)  
(N)

## E2. GENERAL REGULATIONS

### E2.6 Definitions (Cont'd)

#### CENTRAL OFFICE

The term "Central Office" denotes a local Company switching system where Telephone Exchange Service customer station loops are terminated for purposes of interconnection to each other and to trunks.

#### CENTRAL OFFICE PREFIX

The term "Central Office Prefix" denotes the first three digits (NXX) of the seven digit telephone number assigned to an End User's Telephone Exchange Service when dialed on a local basis.

#### CENTRALIZED AUTOMATIC REPORTING ON TRUNKS (CAROT) TESTING

The term "Centralized Automatic Reporting on Trunks (CAROT) Testing" denotes a type of testing which includes the capacity for measuring operational and transmission parameters.

#### CHANNEL(S)

The term "Channel(s)" denotes an electrical or photonic, in the case of fiber optic based transmission systems, communications path between two or more points of termination.

#### CHANNEL SERVICE UNIT

The term "Channel Service Unit" denotes equipment which performs one or more of the following functions: termination of a digital facility, regeneration of digital signals, detection and/or correction of signal format errors and remote loop back.

#### CHANNELIZATION EQUIPMENT

Equipment which provides individual channels of voice and/or data of a higher capacity to a lower capacity or bandwidth or vice versa.

#### CHANNELIZE

The term "Channelize" denotes the process of multiplexing-demultiplexing wider bandwidth or higher speed channels into narrower bandwidth or lower speed channels and vice versa.

#### CHARGEABLE CALL

See Access Minutes.

#### CLEAR CHANNEL CAPABILITY

The term "Clear Channel Capability" denotes the ability to transport twenty-four, 64 Kbps channels over a 1.544 Mbps High Capacity service via B8ZS line code format.

#### C-MESSAGE NOISE

The term "C-Message Noise" denotes the frequency weighted average noise within an idle voice channel. The frequency weighting, called C-message, is used to simulate the frequency characteristic of the 500-type telephone set and the hearing of the average subscriber.

#### C-NOTCHED NOISE

The term "C-Notched Noise" denotes the C-message frequency weighted noise on a voice channel with a holding tone, which is removed at the measuring end through a notch (very narrow band) filter.

#### (DELETED)

(D)

#### COLLOCATOR'S FACILITIES

The term "Collocator's Facilities" denotes the collocator provided transmission equipment and cabling for the sole use in the BellSouth Expanded Interconnection Service arrangement in accordance with the BellSouth Expanded Interconnection Service tariff provisions.

## E2. GENERAL REGULATIONS

### E2.6 Definitions (Cont'd)

#### COLLOCATOR

The term "Collocator" denotes any person, corporation, or other legal entity with whom the Company has negotiated for the purpose of provisioning an BellSouth Expanded Interconnection Service arrangement in accordance with the BellSouth Expanded Interconnection Service tariff provisions.

#### COMMERCIAL RADIO MOBILE SERVICE (CMRS) PROVIDERS

The term "Commercial Radio Mobile Service (CMRS) Providers" denotes carriers which are regulated under Part 22 of the Federal Communications Commission's Rules and Regulations.

#### COMMITMENT GUARANTEE

The term "Commitment Guarantee" denotes a program under which the Company will provide a credit to the end user's account, under conditions set forth in E2.4.16 preceding, for certain services in those instances when the Company's installation or repair commitment is not met due to Company reasons.

#### COMMON LINE

The term "Common Line" denotes a line, trunk, pay telephone line or other facility provided under the General Subscriber Service Tariff of the Company, terminated on a central office switch. A common line-residence is a line or trunk provided under the residence regulations of the General Subscriber Service Tariff. A common line-business is a line provided under the business regulations of the General Subscriber Service Tariff.

#### COMMUNICATIONS SYSTEM

The term "Communications System" denotes channels and other facilities, which are capable of communications between terminal equipment provided by other than the Company.

#### COMPANY

Whenever used in this Tariff or its headings, "Company" and "South Central Bell" refer to BellSouth Telecommunications, LLC. (C)  
unless the context clearly indicates otherwise.

#### CONDUIT SPACE

The term "Conduit Space" denotes any reinforced passage or opening in, on, under/over or through the ground between the feeder route conduit system (entry point) and cable vault location capable of containing communications facilities, and includes: cable entrance facilities; main conduit; ducts; inner ducts; gas traps; underground dips such as short sections of conduit under roadway, driveways, parking lots and similar conduit installations; required to bring the collocator-provided fiber optic feeder cable into the Company central office.

#### CUSTOMER(S)

The term "Customer(s)" denotes any individual, partnership, association, joint-stock company, trust, corporation, or governmental entity or other entity which subscribes to the services offered under this Tariff, including both Interexchange Carriers (ICs) and End Users except in Section 6 of Tariff FCC No. 1, **BellSouth SWA** service, where "Customer(s)" denotes Interexchange Carriers (ICs), Enhanced Service Providers (ESPs), End Users for **BellSouth SWA** FGA FX/ONAL service, and 500 Service Providers for **BellSouth SWA** 500 service. (C)

#### CUSTOMER LOCATION

The term "Customer Location" denotes a carrier's premises within the Local Access Transport Area (LATA).

#### DATA TRANSMISSION (107 TYPE) TEST LINE

The term "Data Transmission (107 Type) Test Line" denotes an arrangement which provides for a connection to a signal source which provides test signals for one-way testing of data and voice transmission parameters.

#### DECIBEL (dB)

The term "Decibel" denotes a unit used to express relative difference in power, usually between acoustic or electric signals, equal to ten (10) times the common logarithm of the ratio of two signal powers.

## E2. GENERAL REGULATIONS

### E2.6 Definitions (Cont'd)

#### DECIBEL REFERENCE NOISE C-MESSAGE WEIGHTING

The term "Decibel Reference Noise C-Message Weighting" denotes noise power measurements with C-Message Weighting in decibels relative to a reference 1000 Hz tone of 90 dB below 1 milliwatt.

#### DECIBEL REFERENCE NOISE C-MESSAGE REFERENCED TO 0

The term "Decibel Reference Noise C-Message Referenced to 0" denotes noise power in "Decibel Reference Noise C-Message Weighting" referred to or measured at a zero transmission level point.

#### DETAIL BILLING

The term "Detail Billing" denotes the listing of each message and/or rate element for which charges to an IC or End User are due on a bill prepared by the Company.

#### DS0

This denotes a channel service expressed in terms of its digitally encoded data bit rate in accordance with the North American hierarchy of digital signal levels. It is generally referred to as having a 64 Kbps transmission data rate signal; however, customer transmitted bit rates are limited to 56 Kbps. The required format and interface specifications are contained in BellSouth Technical Reference TR-NPL-000341.

#### DS1

This denotes a channel service expressed in terms of its digitally encoded data bit rate in accordance with the North American hierarchy of digital signal levels. It has a 1.544 Mbps transmission data rate, and provides for the two-way simultaneous transmission of isochronous timed, Bipolar Return-to-Zero (BPRZ) bit stream format. Unframed signal formats are not permitted or compatible with Company equipment. The required format and interface specifications are contained in BellSouth Technical Reference TR-NPL-000054.

#### DUAL TONE MULTIFREQUENCY ADDRESS SIGNALING

The term "Dual Tone Multifrequency Address Signaling" denotes a type of signaling that is an optional feature of *BellSouth SWA FGA* and *BellSouth SWA FGA* LSBSA. It may be utilized when *BellSouth SWA FGA* and *BellSouth SWA FGA* LSBSA is being used in the terminating direction (from the point of interface with the IC to the local exchange end office). An office arranged for Dual Tone Multifrequency Signaling would expect to receive address signals from the IC in the form of Dual Tone Multifrequency signals.

Material previously appearing on this page now appears on page(s) 49 and 50 of this section.

## E2. GENERAL REGULATIONS

### E2.6 Definitions (Cont'd)

#### ECHO CONTROL

The term "Echo Control" denotes the control of reflected signals in a telephone transmission path.

#### ECHO PATH LOSS (EPL)

The term "Echo Path Loss" denotes the measure of reflected signal at a 4-wire point of termination without regard to the send and receive Transmission Level Point (TLP).

#### ECHO RETURN LOSS (ERL)

The term "Echo Return Loss" denotes a frequency weighted measure of return loss over the middle of the voiceband (approximately 500 to 2500 Hz), where talker echo is most annoying.

#### EFFECTIVE 2-WIRE

The term "Effective 2-Wire" denotes a condition which permits the simultaneous transmission in both directions over a channel, but it is not possible to insure independent information transmission in both directions. Effective 2-wire channels may be terminated with 2-wire or 4-wire interfaces.

#### EFFECTIVE 4-WIRE

The term "Effective 4-Wire" denotes a condition which permits the simultaneous independent transmission of information in both directions over a channel. The method of implementing effective 4-wire transmission is at the discretion of the Company (physical, time domain, frequency-domain separation or echo cancellation techniques). Effective 4-wire channels may be terminated with a 2-wire interface at the customer premises. However, when terminated 2-wire, simultaneous independent transmission cannot be supported, because the 2-wire interface combines the transmission paths into a single path.

#### EGRESS CIRCUITS

The term "Egress Circuits" denotes the facility used to transport the customer's dialed BellSouth® Remote Access Service traffic to the customer's designated location once it has been collected and aggregated by the remote access server.

(N)

(N)

#### END OFFICE SWITCH

The term "End Office Switch" denotes a local Company switching system where Telephone Exchange Service customer station loops are terminated for purposes of interconnection to trunks. Included are Remote Switching Modules and Remote Switching Systems served by a host office in a different wire center.

#### END USER

The term "End User" denotes any individual, partnership, association, corporation, governmental agency or any other entity which (A) obtains a common line, uses a pay telephone or obtains intrastate service arrangements in the operating territory of the Company or (B) subscribes to intrastate service(s) provided by an IC or uses the services of the IC when the IC provides intrastate service(s) for its own use or (C) subscribes to intrastate BellSouth SWA FGB service for its own use.

#### ENHANCED SERVICE PROVIDER (ESP)

An ESP provides enhanced and/or information services which are defined as those services offered over the Company's common carrier facilities and which employ computer processing applications that: act on the format, content, code, protocol, or similar aspects of the end user's transmitted information; provide the end user additional, different, or restructured information; or involve end user interaction with stored information.



## E2. GENERAL REGULATIONS

### E2.6 Definitions (Cont'd)

#### ENTRY POINT

The term "Entry Point" denotes the physical entrance into the central office and/or central office vault. Not all central offices have a central office vault. Multiple entry points are more than one physical entrance into the central office and/or central office vault. Normally, multiple entry points will be distinct and/or separate conduit systems.

#### ENTRY SWITCH

See First Point of Switching.

#### ENVELOPE DELAY DISTORTION

The term "Envelope Delay Distortion" denotes a measure of the linearity of the phase versus frequency of a channel.

#### EQUAL ACCESS EXCHANGE AREAS (EAEA)

The term "Equal Access Exchange Areas" (EAEA) denotes geographic areas, configured based on 1987 planned toll center/access tandem areas, in which local exchange telephone companies are responsible for providing equal access to both interexchange carriers and the customers of interexchange carriers in the most economically efficient manner.

#### EQUAL LEVEL ECHO PATH LOSS (ELEPL)

The term "Equal Level Echo Path Loss" (ELEPL) denotes the measure of Echo Path Loss (EPL) at a 4-wire interface which is corrected by the difference between the send and receive Transmission Level Path (TLP). ( $ELEPL = EPL - TLP(\text{send}) + TLP(\text{receive})$ ).

#### EXCHANGE

The term "Exchange" denotes a unit, generally smaller than a Local Access and Transport Area, established by the Company for the administration of communications service in a specified area which usually embraces a city, town or village and its environs. It consists of one or more central offices together with the associated facilities used in furnishing communications service within that area. One or more designated exchanges comprise a given Local Access and Transport Area.

#### EXPECTED MEASURED LOSS (EML)

The term "Expected Measured Loss" denotes a calculated loss which specifies the end-to-end 1004-Hz loss on a terminated test connection between two readily accessible manual or remote test points. It is the sum of the inserted connection loss and test access loss including any test pads.

#### EXTENDED SUPERFRAME FORMAT (ESF)

The term "Extended Superframe Format" specifies a twenty-four-frame repeating pattern for the framing and information bits contained in a DS1/1.544 Mbps bit stream. The required format specifications are contained in TR-NPL-000054.

## E2. GENERAL REGULATIONS

### E2.6 Definitions (Cont'd)

#### FACILITY SIGNALING POINT OF INTERCONNECTION (FSPOI)

The term FSPOI denotes a Company-designated ordering point within a Company LATA to which customers may order CCS7 Signaling Connections.

#### FEDERAL OBSERVED HOLIDAY

The term "Federal Observed Holiday" denotes public holidays for Federal employees as established by Federal Law (5 U.S.C. 6103).

(N)

(N)

#### FIELD IDENTIFIER

The term "Field Identifier" denotes two to four characters that are used on service orders to convey specific instructions. Field Identifiers may or may not have associated data. Selected Field Identifiers are used in Company billing systems to generate non-recurring charges.

#### FIRST POINT OF SWITCHING (FP OF S)

The term "First Point of Switching" denotes the first Company location at which switching occurs on the terminating path of a call proceeding from the IC premises to the terminating end office and, at the same time, the last Company location at which switching occurs on the originating path of a call proceeding from the originating end office to the IC premises.

#### FREQUENCY SHIFT

The term "Frequency Shift" denotes the change in the frequency of a tone as it is transmitted over a channel.

#### GRANDFATHERED

The term "Grandfathered" denotes Terminal Equipment, Multiline Terminating Systems and Protective Circuitry directly connected to the facilities utilized to provide services under the provisions of this Tariff, and which are considered grandfathered under Part 68 of the FCC Rules and Regulations.

#### HOST OFFICE

The term "Host Office" denotes an electronic switching system, which provides call processing capabilities for one or more Remote Switching Modules or Remote Switching Systems (RSM or RSS).

#### HUB

The term "Hub" denotes a Company designated location at which services are either joined together (as in a bridging hub) or where services are channelized (as in a Hi-Capacity hub).

#### IC TERMINAL LOCATION

The term "IC Terminal Location" denotes a location within a LATA (Point of Presence) from which the IC (1) provides and/or administers telecommunications services for its own use or for the use of its customers (End Users) and (2) has the capability of testing the facilities operated or terminated at that location.

#### IMMEDIATELY AVAILABLE FUNDS

The term "Immediately Available Funds" denotes a corporate or personal check drawn on a bank account and funds which are available for use by the receiving party on the same day on which they are received and include U.S. Federal Reserve bank wire transfers, U.S. Federal Reserve notes (paper cash), U.S. coins, U.S. Postal Money Orders and New York Certificates of Deposit.

#### IMPEDANCE BALANCE

The term "Impedance Balance" denotes the method of expressing Echo Return Loss and Singing Return Loss at a four-wire interface whereby the gains and/or losses of the four-wire portion of the transmission path, including the hybrid, are not included in the specification.

#### INGRESS CIRCUITS

The term "Ingress Circuits" denotes the facility used to transport the customer's incoming dialed BellSouth Remote Access Service traffic, e.g. Primary Rate ISDN.

## E2. GENERAL REGULATIONS

### E2.6 Definitions (Cont'd)

#### IMPULSE NOISE

The term "Impulse Noise" denotes any momentary occurrence of the noise on a channel over a specified level threshold. It is evaluated by counting the number of occurrences, which exceed the threshold.

#### INDIVIDUAL CASE BASIS (ICB)

The term "Individual Case Basis" denotes a condition in which the regulations, if applicable, rates and charges for an offering under the provisions of this Tariff are developed based on the circumstances in each case.

#### INSERTED CONNECTION LOSS

The term "Inserted Connection Loss" denotes the 1004 Hz power difference (in dBs) between the maximum power available at the originating end and the actual power reaching the terminating end through the inserted connection.

#### INTEGRATED SERVICES DIGITAL NETWORK USER PART (ISDNUP)

An SS7 protocol which provides internetwork signaling to support circuit control, ISDN access signaling and specialized subscriber facilities.

#### INTERCONNECTION

Interconnection denotes *the several Interconnection rate elements that apply to BellSouth SWA minutes of use. Separate rate elements are applicable for originating and terminating minutes of use. Additionally, separate rate elements are applicable when the IC utilizes Company-provided transport facilities versus those service applications where there are no Company transport facilities utilized.* (C)

#### INTEREXCHANGE CARRIER(S) (IC)

The term "Interexchange Carrier(s)" denotes any individual, partnership, corporation, association, joint-stock Company, governmental entity, or any other entity, which subscribes to the services offered under this Tariff and is authorized by the Florida Public Service Commission by policy statement or certification to provide intrastate telecommunications services for its own use or for the use of its customers. (T)

#### INTERMODULATION DISTORTION

The term "Intermodulation Distortion" denotes a measure of the nonlinearity of a channel. It is measured using 4 tones, and evaluating the ratios (in dBs) of the transmitted composite 4-tone signal power to the second-order products of the tones (R2), and the third-order products of the tones (R3).

#### INTRASTATE COMMUNICATIONS

The term "Intrastate Communications" denotes any communications in Florida subject to oversight by the Florida Public Service Commission as provided by the laws of the State.

#### LINE CONTROLLED PAY STATIONS

The term "Line Controlled Pay Stations" denotes line controlled pay stations utilizing Telephone Company serving central office equipment for the necessary call processing features required for pay telephone traffic. Traffic from these stations will be completed to the customer over BellSouth SWA TSBSA 3 trunks which must be equipped with the Coin Sent-Paid Capability optional feature.

#### LINE SIDE CONNECTION

The term "Line Side Connection" denotes a connection of a transmission path to the line side of a local exchange switching system.

#### LOCAL ACCESS AND TRANSPORT AREA (LATA)

The term "Local Access and Transport Area" denotes a geographic area established for the provision and administration of communications service. It encompasses one or more designated exchanges, which are grouped to serve common social, economic and other purposes.

## E2. GENERAL REGULATIONS

### E2.6 Definitions (Cont'd)

#### LOCAL CALLING AREA

The term "Local Calling Area" denotes a geographical area, as defined in the Company's General Subscriber Service Tariff, in which an End User (Telephone Exchange Service Subscriber) may complete a call without incurring MTS charges.

#### LOCATION PROVIDER

The term "Location Provider" denotes the person or persons having a legal authority to permit the Payphone Service Provider to place pay telephones on their premises.

#### LOOP AROUND TEST LINE

The term "Loop Around Test Line" denotes an arrangement utilizing a Company central end office to provide a means to make certain two-way transmission tests on a manual basis. This arrangement has two central office terminations, each reached by means of separate telephone numbers and does not require any specific IC terminal equipment. Equipment subject to this test arrangement is at the discretion of the IC.

#### LOSS DEVIATION

The term "Loss Deviation" denotes the variation of the actual loss from the designed value.

#### MAJOR FRACTION THEREOF

The term "Major Fraction Thereof" is any period of time in excess of one-half of the stated amount of time. As an example, in considering a period of 24 hours, a major fraction thereof would be any period of time in excess of 12 hours exactly. Therefore, if a given service is interrupted for a period of thirty-six hours and fifteen minutes, the IC or End User would be given a credit allowance for two twenty-four hour periods for a total of forty-eight hours.

#### MANHOLE

The term "Manhole" denotes a sub-surface enclosure which Company personnel may enter and use for the purpose of installing, operating, maintaining and repairing communications facilities.

#### MARITIME RADIO COMMON CARRIERS (MRCCs)

The term "Maritime Radio Common Carriers" (MRCCs) denotes carriers which are regulated under Part 81 on the Federal Communications Commission's Rules and Regulations.

#### MARKET AREA

See Local Access and Transport Area.

#### MASS CALLING EVENT

An activity that a subscriber (Interexchange Carrier, Alternative Local Exchange Carrier, or end user) engages in that creates or results in a heavy influx of calls into a given network. For example, if a subscriber operating a radio or television station conducts a call-in promotion, it can create a mass calling situation that locks up the network so that other subscribers can not complete their calls through that network. Likewise, a subscriber from outside the LATA can create a mass calling event by generating massive common transport terminating switched access traffic that is directed to end users served from specific end offices. The Company will work with the subscriber in advance of such promotions and mass calling activities to reroute their calls to other facilities to prevent overloading the network that provides the subscriber's service. BellSouth will not be liable for the blockage of any traffic in any way related to the mass calling event. The Company does not guarantee the completion of mass calling traffic on its network.

(N)

(N)

#### MESSAGE

The term "Message" denotes a "call" as defined preceding.

#### MILLIWATT (102 TYPE) TEST LINE

The term "Milliwatt (102 Type) Test Line" denotes an arrangement in an end office which provides a 1004 Hz tone at 0 dBm0 for one-way transmission measurements towards the IC terminal location from the Company end office.

#### MINUTES OF USE

See Access Minutes

ISSUED: January 4, 2012

EFFECTIVE: January 5, 2012

BY: Marshall M. Criser III, President -FL  
Miami, Florida

## E2. GENERAL REGULATIONS

### E2.6 Definitions (Cont'd)

#### MODIFIED ACCESS BASED COMPENSATION (MABC)

The Modified Access Based Compensation Plan ordered by the Florida Public Service Commission in Docket No. 850310-TL Order No. 17743, issued June 24, 1987 allows the Local Exchange Company (LEC) in whose area the intraLATA long distance MTS/WATS calls originate, to bill and keep the revenues for such calls. The LEC then pays appropriate access charges to other LECs that participate in the completion of the call.

#### MULTIPOINT CHANNEL

The term "Multipoint Channel" refers to any connection which terminates three or more circuits on the same bridging node.

#### NETWORK CHANNEL INTERFACE (NCI) CODE UPDATE

The term "Network Channel Interface (NCI) Code Update" denotes the manual or mechanical activity performed to update the NCI code on each sub-DSI level circuit riding a DSI High Capacity service that is converted (rolled over) to a DS3 High Capacity service.

#### NETWORK CONTROL SIGNALING

The term "Network Control Signaling" denotes the transmission of signals used in the telecommunications system which perform functions such as supervision (control, status, and charge signals), address signals (e.g., dialing), calling and called number identifications, rate of flow, service selection error control and audible tone signals (call progress signals indicating re-order or busy conditions, alerting, coin denominations, coin collect and coin return tones) to control the operation of the telecommunications system.

#### NETWORK INTERFACE

The term "Network Interface" denotes the point of demarcation on the End User's premises at which the Company's responsibility for the provision of Access Services end.

#### (DELETED)

#### NONSYNCHRONOUS TEST LINE

The term "Nonsynchronous Test Line" denotes an arrangement in step-by-step end offices which provides operational tests which are not as complete as those provided by the synchronous test lines, but which can be made more rapidly.

#### NORTH AMERICAN NUMBERING PLAN (NANP)

The term "North American Numbering Plan" denotes a 3-digit area or Numbering Plan Area (NPA) code and a 7-digit telephone number made up of a 3-digit Central Office (CO) code plus a 4-digit station number.

#### OFF-HOOK

The term "Off-hook" denotes the active condition of BellSouth SWA or a Telephone Exchange Service line.

#### ON-HOOK

The term "On-hook" denotes the idle condition of BellSouth SWA or a Telephone Exchange Service line.

#### OPEN CIRCUIT TEST LINE

The term "Open Circuit Test Line" denotes an arrangement in an end office which provides an ac open circuit termination of a trunk or line by means of an inductor of several Henries.

#### OPERATING COMPANY NUMBER

Denotes a four-character alphanumeric identifier used to determine the company of the NPA-NXX code-holders.

(N)

(N)

FLORIDA

ISSUED: March 3, 1997

EFFECTIVE: April 1, 1997

BY: Joseph P. Lacher, President -FL  
Miami, Florida

## E2. GENERAL REGULATIONS

### E2.6 Definitions (Cont'd)

#### OPERATOR SERVICES SYSTEM

The term "Operator Services System" (OSS) denotes the switching equipment, facilities, operator positions and software components utilized for the provision of Operator Services.

#### OPERATOR SERVICES SYSTEM LOCATION

The term "Operator Services System Location" (OSS location) denotes a Company office where Company equipment routes or receives IC Operator Services calls to or from the IC location.

#### OPERATOR SERVICES SYSTEM SERVING AREA

The term "Operator Services System Serving Area" (OSS serving area) denotes the geographic operational domain of an Operator Services System.

#### ORIGINATING DIRECTION

The term "Originating Direction" denotes the use of access service for the origination of calls from an End User to an IC terminal location.

#### OVERLAP OUTPULSING

The term "Overlap Outpulsing" denotes the feature of the BellSouth SWA FGD and BellSouth SWA TSBSA 3 Signaling System which permits initiation of pulsing to the IC's premises before the calling subscriber has completed dialing an originating call.

#### (DELETED)

#### PAY TELEPHONE LINE

The term "Pay Telephone Line" denotes facilities provided by the Company which connect pay telephone stations to the Local Exchange Network.

#### PAYPHONE SERVICE PROVIDER

The term "Payphone Service Provider" denotes one who provides payphone service, which is the provision of public or semi-public pay telephones, the provision of inmate telephone service in correctional institutions and any ancillary services.

#### PHASE JITTER

The term "Phase Jitter" denotes the unwanted phase variations of a transmitted signal.

#### POINT OF INTERFACE

The term "Point of Interface" denotes a demarcation point, at the IC terminal location, between Company provided and IC provided services.

#### POINT OF PRESENCE

See IC Terminal Location.

#### POINT OF TERMINATION

The term "Point of Termination" denotes the point of demarcation, within an IC-designated premises at which the Company's responsibility for the provision of Access Service ends.

#### PREMISES

The term "Premises" denotes the building or portions of a building in a multitenant building, or buildings on continuous property (except Railroad Right-of-Way, etc.) not separated by a public highway. This term is not to be limited to one building, but applies as well to a complex, or campus-type configuration of buildings.

(D)

(N)

(N)

(N)

(N)

FLORIDA

ISSUED: January 18, 2002

BY: Joseph P. Lacher, President -FL  
Miami, Florida

EFFECTIVE: February 17, 2002

## E2. GENERAL REGULATIONS

### E2.6 Definitions (Cont'd)

#### RADIO COMMON CARRIERS (RCCs)

The term "Radio Common Carriers" (RCCs) denotes carriers which are regulated under Part 22 of the Federal Communications Commission's Rules and Regulations.

#### REMOTE ACCESS SERVER

The term "Remote Access Server" denotes equipment that aggregates the customer's BellSouth® Remote Access Service dialed traffic and transports it to the customer's designated location over their egress circuits.

#### REMOTE MODULES AND/OR REMOTE SYSTEMS

The term "Remote Modules and/or Remote Systems" denotes small, end offices which obtain their call processing capability from a Host Office. The Remote Modules and/or Remote Systems cannot accommodate direct trunks to an IC.

#### RETURN LOSS

The term "Return Loss" denotes a measure of the similarity between the two impedances at the junction of two transmission paths (e.g., four to two-wire junctions). The higher the return loss, the higher the similarity.

#### REGISTERED EQUIPMENT

The term "Registered Equipment" denotes the IC's or the IC's customer's premises equipment (CPE) which complies with and has been approved within the Registration Provisions of Part 68 of the FCC Rules and Regulations.

#### SECONDARY CHANNEL

The term "Secondary Channel" denotes the offering of a companion digital transmission capability over the same physical facility as the primary channel at a lower bit rate. Terminal equipment required to support secondary channel capability must be provided by the customer.

#### SERVICE ACCESS CODE

The term "Service Access Code (SAC)" denotes the 700, 800 and 900 NXX numbers administered by Bell Communications Research as part of the North American Numbering Plan.

#### SERVICE INSTALLATION GUARANTEE

The term "Service Installation Guarantee" denotes a program under which the Company will provide a credit to the customer's account for certain services in those instances when the Service Date is not met due to Company reasons.

#### SERVICE PROVIDED UPON REQUEST

The term "Service Provided Upon Request" (SPUR) denotes a service that has not been requested by any ICs in a particular state. When a request for this service is received, a new aggregate rate will be calculated and filed in this Tariff. The new rate will include the additional demand and costs for the service.

#### SERVICE SWITCHING POINT (SSP)

The term "Service Switching Point" (SSP) denotes a node in a CCS7 Signaling System that formulates and receives signaling messages. (N)

#### SERVING WIRE CENTER

The term "Serving Wire Center" denotes the wire center from which the IC designated premises would normally obtain dial tone from the Company. (N)

#### SEVEN DIGIT MANUAL TEST LINE

The term "Seven Digit Manual Test Line" denotes an arrangement, which allows the IC to select balance, milliwatt and synchronous test lines, by manually dialing a seven digit number over the associated access connection.

#### SHARED NETWORK ARRANGEMENT

The term "Shared Network Arrangement" denotes a service offering whereby multiple ICs may connect on a channelized high capacity service and the Company will undertake to maintain separate records for each IC's portion of the shared network.

® BellSouth is a registered trademark of BellSouth Intellectual Property Corporation

## E2. GENERAL REGULATIONS

### E2.6 Definitions (Cont'd)

#### SHORT CIRCUIT TEST LINE

The term "Short Circuit Test Line" denotes an arrangement in an end office which provides an ac short circuit termination of the trunk or line by means of a capacitor of at least 4 microfarads.

#### SIGNAL-TO-C-NOTCHED NOISE RATIO

The term "Signal-to-C-Notched Noise Ratio" denotes the ratio in dB of a test signal to the corresponding C-Notched Noise.

#### SIGNAL TRANSFER POINT (STP)

The term "Signal Transfer Point" denotes a signaling point which routes and/or transfers signaling messages through the common channel signaling network.

#### SIGNALING POINT OF INTERCONNECTION

The term "Signaling Point of Interconnection" (SPOI) denotes the location where a Company-provided CCS7 Signaling Connection terminates at a customer location.

#### SIGNALING POINT CODE

The term "Signaling Point Code" denotes a binary code uniquely identifying a signaling point in a signaling network. This code is used, depending upon its position in the label, either as a destination point code, identifying the intended destination of the message, or as an originating point code, which identifies the originating point of the message.

#### SPECIAL ORDER

The term "Special Order" denotes an order for a Billing and Collection Service or an order for BellSouth Directory Assistance Access Service when the service is provided via direct trunks to the DA location or via specially designated trunk groups to the access tandem. (D)

#### SUBTENDING END OFFICE OF AN ACCESS TANDEM

The term "Subtending End Office of an Access Tandem" denotes an end office that has final trunk group routing through that tandem. (D)

#### SUPERFRAME FORMAT (SF)

The term "Superframe Format" specifies a twelve-frame repeating pattern for the framing and information bits contained in a DS1/1.544 Mbps bit stream. The required format specifications are contained in TR-NPL-000054.

#### SWITCHED LOCAL CHANNEL

The Switched Local Channel denotes a switched transport facility between the IC's serving wire center and the IC's premises.

#### SYNCHRONOUS TEST LINE

The term "Synchronous Test Line" denotes an arrangement in an end office, which performs marginal operational tests of supervisory and ring-tripping functions.

#### TELEPHONE COMPANY ANSWERING SERVICE CONCENTRATOR

The term "Telephone Company Answering Service Concentrator" denotes a device located in a central office of the Company which concentrates incoming calls to some number of Telephone Answering Service's clients lines to some smaller number of trunks/channels connected to the IC's or End User's premises equipment.

#### TERMINATING DIRECTION

The term "Terminating Direction" denotes the use of Access Service for the completion of calls from an IC terminal location to an End User's premises.



ISSUED: February 14, 1997

EFFECTIVE: March 1, 1997

BY: Joseph P. Lacher, President -FL  
Miami, Florida

## E2. GENERAL REGULATIONS

(T)

### E2.6 Definitions (Cont'd)

#### TERMINATION LIABILITY CHARGE

The term "Termination Liability Charge" when used in connection with specially constructed facilities denotes the portion of the Maximum Termination Liability that is applied as a nonrecurring charge when all services are discontinued prior to the expiration of the specified liability period. The term "Termination Liability" as used in connection with the application of termination charges for access services denotes the discontinuance, either at the request of the customer or by the Company under its regulations concerning cancellation for cause, of service or facilities (including channels and station equipment) provided by the Company.

#### TRADITIONAL SIGNALING

The term "Traditional Signaling" denotes the Intermachine Signaling System which has been traditionally used in North America for the purpose of transmitting the called number's address digits from the originating end office to the switching machine which will terminate the call. In this system, all of the dialed digits are received by the originating switching machine, a path is selected, and the sequence of supervisory signals and outpulsed digits is initiated. No overlap outpulsing, ten digit ANI or ANI information digits are included in this signaling sequence. Acknowledgment wink is required from the terminating switching machine except when the originating switching machine is SXS.

#### TRAFFIC

The term "traffic" denotes a volume of IC access minutes of use or calls.

#### TRAFFIC OPERATOR POSITION SYSTEM (TOPS) TANDEM

The term "Traffic Operator Position System" (TOPS tandem) denotes a Company office where Company equipment routes or receives IC Operator Services calls to or from the IC location. A TOPS tandem is also known as an OSS location.

#### TRANSACTIONS CAPABILITIES APPLICATION PART (TCAP) MESSAGES

The term "TCAP Messages" relates to the application of TIA Interim Standard 41 (Sub-systems 005-010) for the transmission of non-call associated messages over the *BellSouth SWA* CCSAC network.

(T)

#### TRANSMISSION MEASURING (105 TYPE) TEST LINE/RESPONDER

The term "Transmission Measuring (105 Type) Test Line/Responder" denotes an arrangement in an end office which provides far-end access to a responder and permits two-way loss and noise measurements to be made on trunks from a near end office.

#### TRANSMISSION PATH

The term "Transmission Path" denotes an electrical path capable of transmitting signals within the range of the service offering, e.g., a voice grade transmission path is capable of transmitting voice frequencies within the approximate range of 300 to 3000 Hz. A transmission path is comprised of physical or derived channels consisting of any form or configuration of facilities typically used in the telecommunications industry.

## E2. GENERAL REGULATIONS

### E2.6 Definitions (Cont'd)

#### SINGING RETURN LOSS (SRL)

The term "Singing Return Loss" denotes the frequency weighted measure of return loss at the edges of the voiceband (200 to 500 Hz and 2500 to 3200 Hz), where singing (instability) problems are most likely to occur.

#### TRUNK

The term "Trunk" denotes a communications path connecting two switching systems in a network, used in the establishment of an end-to-end connection.

#### TRUNK GROUP

The term "Trunk Group" denotes a set of trunks, which are traffic engineered as a unit for the establishment of connections between switching systems in which all of the communications paths are interchangeable.

#### TRUNK SIDE CONNECTION

The term "Trunk Side Connection" denotes the connection of a transmission path to the trunk side of a local exchange switching system.

#### TWO-WIRE TO FOUR-WIRE CONVERSION

The term "Two-Wire to Four-Wire Conversion" denotes an arrangement, which converts a four-wire transmission path to a two-wire transmission path to allow a four-wire facility to terminate in a two-wire entity such as a central office switch.

#### **(DELETED)**

#### UNIFORM SERVICE ORDER CODE

The term "Uniform Service Order Code" denotes a three or five character alphabetic, numeric, or an alphanumeric code that identifies a specific item of service or equipment. Uniform Service Order Codes are used in the Company billing system to generate recurring rates and nonrecurring charges.

#### V AND H COORDINATES METHOD

The term "V and H Coordinates Method" denotes a method of computing airline miles between two points by utilizing an established formula which is based on the Vertical (V) and Horizontal (H) coordinates of the two points.

#### WIRE CENTER

A "Wire Center" is a Company facility that houses Company equipment necessary for the provision of BellSouth SWA and non-BellSouth SWA telephone service to customers in a defined geographical area. The facility is identified with V&H coordinates and is assigned one or more NXX's for use in providing BellSouth SWA services to customers located in the specified geographical area. The Company equipment located at a Wire Center may consist of switching equipment or non-BellSouth SWA equipment working with a distant host switch as well as equipment used to terminate dedicated non-BellSouth SWA services. Wire Centers capable of terminating access facilities are designated by the Company.

(D)

## E2. GENERAL REGULATIONS

### E2.6 Definitions (Cont'd)

#### 500 SERVICE PROVIDER

The term "500 Service Provider" refers to an entity purchasing BellSouth SWA 500 Access Service for use in the provision of Personal Communication Service. A 500 Service Provider must have been assigned a 500 NXX by the North American Numbering Plan Administrator.

#### 800 DATABASE

The term "800 Database" refers to the use of database technology to determine to which access customer an originating 800 call is to be delivered. With the exception of 800 calls to Canada, Bermuda, and the Bahamas, the 800 Database routes calls to an access customer based on the dialed ten digit 800 number.

### E2.7 Special Promotions

#### E2.7.1 Regulations

- A. The Company may offer approved special promotions of new or existing services or products for limited periods as approved by the Public Service Commission. These promotions are a temporary waiver of certain recurring and/or nonrecurring charges as stated in paragraph E2.7.2.A. These promotions will be offered on a completely nondiscriminatory basis with each subscriber in the classification of service and area for which the promotion is offered having an equal opportunity for participation.

#### E2.7.2 Descriptions

- A. The following promotions are approved by the Commission:

Area of Promotion	Service	Charges Reduced	Period
BellSouth's nine state region	Listed Name and Address Service	\$0.06 per record rate reduced to \$0.03 when ordering the Listed Name and Address service	April 28, 2001 to October 28, 2001

### E2.8 Reserved For Future Use

### E2.9 Reserved For Future Use

### E2.10 Reserved For Future Use

### E2.11 Trademarks and Servicemarks Protection

#### E2.11.1 Use of Trademarks and Servicemarks

*Trademarks and Servicemarks* owned by BellSouth Intellectual Property Corporation may not be used by any entity concurring in or providing services pursuant to this Tariff except under an express written license agreement with BellSouth Intellectual Property Marketing Corporation.

(T)

(T)

(T)

## E2. GENERAL REGULATIONS

### E2.12 TDM to IP Transition

#### E2.12.1 General TDM to IP Transition Provisions

As a result of evolving network technology, the Telephone Company is able to offer new, advanced services. At the same time, certain older services will no longer be available in some geographic areas, as those services are no longer technically or economically feasible. The table below identifies services that have been withdrawn, by wire center and exchange, along with additional information related to these service withdrawals.

<u>Product Name</u>	<u>Reference</u>
Telegraph Grade (aka BellSouth SPA Telegraph) Service	E7.2.2
Voice Grade (aka BellSouth SPA DS0 VG) Service	E7.2.3
Digital Data Access (aka BellSouth SPA DS0 Digital Data) Service	E7.2.5
High Capacity (aka BellSouth SPA High Capacity) Service (64 kbps, 3.152 and 6.312 Mbps)	E7.2.6
FlexServ (aka BellSouth SPA Customer Rearrangement) Service	E7.4.12
Exchange Access Frame Relay Service (XARFS) (aka BellSouth Exchange Access Frame Relay Service)	E21.1
Exchange Access Asynchronous Transfer Mode Service (XAATMS)	E21.3
BellSouth Network Visibility Service	E21.6

Effective Date

Wire Center

Exchange

Other Information

11/01/2018

BGPIFLMA  
 SGKYFLMA

Big Pine  
 Sugar Loaf

Entire Wire Center  
 Entire Wire Center

04/29/2019

PNCYFLMA

Panama City

Distribution Areas 112452, 150751, 150752, 151002, 151553, 151851,  
 152350, 154451, 210854, 413751 and 414551

LYHNFLOH

Lynn Haven

Distribution Areas 220651 and 220652

09/15/2020

JCVLFLRV

Jacksonville

Distribution Area 420664

(N)

(N)

BELLSOUTH  
TELECOMMUNICATIONS, INC.  
FLORIDA

ACCESS SERVICES TARIFF

Second Revised Page 1  
Cancels First Revised Page 1

ISSUED: January 29, 2002  
BY: Joseph P. Lacher, President -FL  
Miami, Florida

EFFECTIVE: February 28, 2002

**E3. CARRIER COMMON LINE ACCESS**

CONTENTS

<b>E3.1</b>	<b>General Description</b>	1	
<b>E3.2</b>	<b>Limitations</b>	1	
<b>E3.3</b>	<b>Undertaking of the Company</b>	1	
<b>E3.4</b>	<b>Obligations of the IC</b>	2	
<b>E3.5</b>	<b>Payment Arrangements</b>	2	
<b>E3.6</b>	<b>Determination of Usage Subject to Carrier Common Line Access Charges</b>	3	
<b>E3.7</b>	<b>Resold Services</b>	3	
<b>E3.8</b>	<b>Reserved for Future Use</b>	6	(T)
<b>E3.9</b>	<b>Rate Regulations</b>	8	
<b>E3.10</b>	<b>Rates and Charges</b>	10	

ISSUED: January 29, 2002  
BY: Joseph P. Lacher, President -FL  
Miami, Florida

EFFECTIVE: February 28, 2002

### **E3. CARRIER COMMON LINE ACCESS**

The Company will provide Carrier Common Line Access Service (Carrier Common Line Access) to ICs or to End Users of FX/ONAL or End Users of BellSouth SWA FGB Services.

#### **E3.1 General Description**

- A. Carrier Common Line Access provides for the use of Company common lines by ICs for access to end users to furnish IC intrastate telecommunications service.
- B. Carrier Common Line Access is provided where the IC obtains BellSouth SWA services under this Tariff. (T)
- C. Premium Access is (1) BellSouth SWA service provided to ICs under this Tariff which furnish intrastate MTS/BellSouth SWA WATS, and (2) BellSouth SWA service in an end office converted to equal access.
- D. (DELETED) (D)

#### **E3.2 Limitations**

- A. A telephone number is not provided with Carrier Common Line Access.
- B. Detail billing is not provided for Carrier Common Line Access.
- C. Directory listings are not included in the rates and charges for Carrier Common Line Access.
- D. Intercept arrangements are not included in the rates and charges for Carrier Common Line Access.
- E. Where BellSouth SWA services are connected with Dedicated Access Services at Company designated BellSouth SWA WATS serving offices for the provision of BellSouth SWA WATS or BellSouth SWA WATS-type Services, BellSouth SWA service minutes which are carried on that end of the service (i.e., originating minutes for outward BellSouth SWA WATS and BellSouth SWA WATS-type services and terminating minutes for inward BellSouth SWA WATS and BellSouth SWA WATS-type services) shall not be assessed Carrier Common Line Access Service per minute charges.
- F. All line side connections provided in the same combined access group will be limited to the same features and operating characteristics. Such features and characteristics will be limited to those which are available under both this Tariff and the general and/or local exchange tariff applicable to the group involved.
- G. All trunk side connections provided in the same combined access group will be limited to the same features and operating characteristics.

#### **E3.3 Undertaking of the Company**

- A. Where the IC is provided with BellSouth SWA service under other sections of this Tariff, the Company will provide the use of Company common lines by an IC for access to end users at rates and charges as specified in E3.10 following.
- B. The BellSouth SWA service provided by the Company includes the BellSouth SWA service provided for both interstate and intrastate communications. The Carrier Common Line Access Service rates and charges as set forth in E3.10 following apply to intrastate BellSouth SWA service access minutes in accordance with the rate regulations as set forth in E3.9 following.

### E3. CARRIER COMMON LINE ACCESS

(T)

#### E3.4 Obligations of the IC

- A. The BellSouth SWA service associated with Carrier Common Line Access Service shall be ordered by the IC under other sections of this Tariff.
- B. The IC facilities at the IC terminal location of the ordering IC shall provide the necessary on-hook and off-hook supervision.
- C. Where Operator Trunk-Coin or Combined Coin and Non Coin or Operator Trunk-Full Feature Optional Features for sent-paid pay telephone access is provided to the IC and the IC wishes to receive the monies it is due for the monies collected by the Company from coin pay telephone stations, the IC shall furnish to the Company, at a location specified by the Company, the IC message call detail for the IC sent-paid (coin) pay telephone calls in accordance with the Company collection schedule. The IC message call detail furnished shall be in a standard format established by the Company as set forth in E8.2.1. following. If no IC message call detail is received from the IC for each bill period established by the Company, the Company will assume there were no IC sent-paid (coin) pay telephone calls for the period. In addition the IC shall furnish a schedule of its charges for sent-paid (coin) calls to the Company at a location and date as specified by the Company. Any change in the IC's schedule of charges shall be furnished to the Company one day after the change becomes effective.

#### E3.5 Payment Arrangements

- A. The Company will bill the Carrier Common Line Access. The bill day (i.e., the billing date of the bill) in a month for each IC account will be established by the Company. Payment is due from the IC 31 days after the bill day date (payment date) or by the next bill date (i.e., same date in the following month as the bill date), whichever is the shortest interval, and is payable in *immediately* available funds. If such payment date is a Saturday, Sunday or Holiday (i.e., New Year's Day, *Independence* Day, Labor Day, Thanksgiving Day, Christmas Day, the second Tuesday in November, and a day when Washington's Birthday, Memorial Day or Columbus Day is legally observed), payment will be due from the IC as follows:
  1. If such payment date falls on a Sunday or on a Holiday which is observed on a Monday, the payment date shall be the first non-Holiday day following such Sunday or Holiday. If such payment date falls on a Saturday or on a Holiday which is observed on Tuesday, Wednesday, Thursday or Friday, the payment date shall be the last non-Holiday day preceding such Saturday or Holiday.
- B. Further, if any portion of the Carrier Common Line Access payment is received by the Company after the payment date as set forth in A. preceding, or if any portion of the Carrier Common Line Access payment is received by the Company in funds which are not immediately available to the Company, then a late payment penalty shall be due to the Company. The late payment penalty shall be the portion of the Carrier Common Line Access payment not received by the payment date times a late factor. The late factor shall be the lesser of:
  1. The highest interest rate (in decimal value) which may be levied by law for commercial transactions, compounded daily for the number of days from the payment date to and including the date that the IC actually makes the payment to the Company, or

(T)

### E3. CARRIER COMMON LINE ACCESS

#### E3.5 Payment Arrangements (Cont'd)

- B. (Cont'd)
2. 0.000590 per day, compounded daily for the number of days from the payment date to and including the date that the IC actually makes the payment to the Company.
- C. In the event a billing dispute concerning a month's Carrier Common Line Access billed to the IC by the Company is resolved in favor of the Company, any payments withheld pending settlement of the dispute shall be subject to the late payment penalty set forth in B. preceding. If the IC disputes the bill on or before the payment date, and pays the undisputed amount on or before the payment date, any late payment charge for the disputed amount will not start until 10 days after the payment date. If the billing dispute is resolved in favor of the IC, no late payment will apply to the disputed amount. In addition, if the IC disputes the billed amount and pays the total amount (i.e., the non-disputed amount and the disputed amount) on or before the payment date and the billing dispute is resolved in the favor of the IC, the IC will receive a credit for a disputed amount penalty from the billing entity if the billing dispute is not resolved within 10 working days following the payment date or the date the IC furnishes to the billing entity documentation to support its claim plus 10 working days, whichever date is the later date. The disputed amount penalty shall be the disputed amount resolved in the IC's favor times a penalty factor.

#### E3.6 Determination of Usage Subject to Carrier Common Line Access Charges

Except as set forth herein, all *BellSouth SWA* service provided to the IC will be subject to Carrier Common Line Access Charges.

- A. When the IC reports interstate and intrastate use of *BellSouth SWA* service, the associated Carrier Common Line Access used by the IC for intrastate use will be determined as set forth in E3.9 following.

B.

- C. When access to the local exchange is required to provide an IC Service that uses service (e.g. MTS/WATS-type, telex, data, etc.) a resold Private Line Service, *BellSouth SWA FG* service rates and regulations, as set forth in E6.7 following will apply. Carrier Common Line Access rates and charges as set forth in E3.10 following apply in accordance with the resale rate regulations as set forth in E3.7 following.

#### E3.7 Resold Services

- A. Where the IC is reselling MTS or MTS-type service(s) on which the Carrier Common Line and *BellSouth SWA* charges have been assessed, the IC may, at the option of the IC, obtain *BellSouth SWA FGA*, *BellSouth SWA FGB*, *BellSouth SWA FGD*, *BellSouth SWA LSBSA* or *BellSouth SWA TSBSA 1* or 3 *BellSouth SWA FG* service under this Tariff as set forth in Section E6. following for originating and/or terminating access in the local exchange. Such access group arrangements, whether single lines or trunks or multiline hunt groups or trunk groups, will have Carrier Common Line Access Charges applied as set forth in E3.10 following in accordance with the resale rate regulations set forth in this Section. For purposes of administering this provision:

(D)  
|  
(D)



### E3. CARRIER COMMON LINE ACCESS

#### E3.7 Resold Services (Cont'd)

A. (Cont'd)

1. Resold intrastate terminating MTS and MTS-type service(s) shall include collect calls, third number calls and credit card calls where the reseller pays the underlying carrier's service charges; and shall not include interstate minutes of use.
2. Resold intrastate originating MTS and MTS-type service(s) shall not include collect, third number, credit card or interstate minutes of use.<sup>1</sup>

(N)

- B. When the IC is reselling MTS and/or MTS-type service as set forth in A. preceding, the IC will be charged the Carrier Common Line Access charges in accordance with the resale rate regulations as set forth in D. following if the IC or the provider of the MTS service furnishes documentation of the MTS usage and/or the IC furnishes documentation of the MTS-type usage.<sup>1</sup> Such documentation supplied by the IC shall be supplied each month and shall identify the involved resold MTS and/or MTS-type services. The monthly period used to determine the minutes of use for resold MTS and/or MTS-type service(s) shall be the most recent monthly period for which the IC has received a bill for such resold service(s). This information shall be delivered to the Company, at a location specified by the Company, no later than fifteen days after the bill date shown on the resold MTS and/or MTS-type service bill. If the required information is not received by the Company, the previously reported information, as described preceding, will be used for the next two months. For any subsequent month, no allocation or credit will be made until the required documentation is delivered to the Company by the IC.

(N)

- C. When the IC utilizes BellSouth SWA service as set forth in B. preceding, the Company may request a certified copy of the IC's resold MTS and/or MTS-type usage billing from either the IC or the provider of the MTS and/or MTS-type service. Requests for billing will relate back no more than twelve months prior to the current billing period.

- D. When the IC is provided an access group to be used in conjunction with the resale of MTS and/or MTS-type services as set forth in A. preceding, subject to the limitation as set forth in E3.2 preceding, and the Company receives the usage information required to calculate the adjustment of Carrier Common Line Access Charges as set forth in B. preceding, the customer will be billed as set forth following.

When the customer is provided with more than one access group in a LATA in association with the resale of MTS and/or MTS-type services, the resold minutes of use will be apportioned as follows:

1. The Company will apportion the resold originating MTS or MTS-type services and originating minutes of use for which resale credit adjustment applies, among the access groups. Such apportionment will be based on the relationship of the originating usage for each access group to the total originating usage for all access groups in the LATA. For purposes of administering this provision:
  - a. Resold originating MTS and/or MTS-type services minutes shall be only those attributable to intrastate originating MTS and/or MTS-type minutes and shall not include collect, third number, credit card or interstate minutes of use.<sup>1</sup>
  - b. The resale credit adjustment shall apply for resold originating MTS and /or MTS-type services and minutes of use, provided Carrier Common Line and BellSouth SWA Charges have been assessed on such services.

(N)

Note 1: Effective July 30, 2016, Collect calls and Third Number billing are discontinued

(N)

### E3. CARRIER COMMON LINE ACCESS

#### E3.7 Resold Services (Cont'd)

**D.** (Cont'd)

2. The Company will apportion the resold terminating MTS and/or MTS-type services and terminating minutes of use for which resale credit applies, among the access groups. Such apportionment will be based on the relationship of the terminating usage for each access group to the total terminating usage for all access groups in the LATA. For purposes of administering this provision:
  - a. Resold terminating MTS and/or MTS-type services minutes shall be only those attributable to intrastate terminating MTS and/or MTS-type (i.e., collect calls, third number calls, and credit card calls) and shall not include interstate minutes of use or MTS and/or MTS-type minutes of use paid for by another party.
  - b. The resale credit adjustment shall apply for resold terminating MTS and MTS-type services and minutes of use, provided Carrier Common Line and Switched Access Charges have been assessed on such services.<sup>1</sup>
3. In order for the rate regulations to apply as set forth following, the access groups and the resold MTS and/or MTS-type services must be provided in the same state (except when the same extended area service arrangement is provided in two different states by the same company) in the same exchange, provided by the same Company and connected directly or indirectly. For those exchanges that encompass more than one state, the IC shall report the information by state within the exchange.
4. Each of the access group arrangements used by the IC in association with the resold MTS and/or MTS-type services must be connected either directly or indirectly to the IC designated premises at which the resold MTS and/or MTS-type services are terminated. Direct connections are those arrangements where the access groups and resold MTS and/or MTS-type services are terminated at the same IC designated premises.
5. Indirect originating connections are those arrangements where the access groups and the resold originating MTS and/or MTS-type services are physically located at different IC designated premises in the same exchange. Such different IC designated premises are connected by facilities that permit a call to flow from access groups to resold MTS and/or MTS-type services.
6. Indirect terminating connections are those arrangements where the access groups and resold terminating MTS and/or MTS-type services are physically located at different IC designated premises in the same exchange. Such different IC designated premises are connected by facilities that permit a call to flow from resold terminating MTS and/or MTS-type services to access groups.
7. The adjustments as set forth following will be computed separately for each access group.

(N)

**E.** (DELETED)

Note 1: Effective July 30, 2016, Collect calls and Third Number billing are discontinued

(N)

FLORIDA

ISSUED: January 29, 2002

EFFECTIVE: February 28, 2002

BY: Joseph P. Lacher, President -FL  
Miami, Florida

### **E3. CARRIER COMMON LINE ACCESS**

#### **E3.7 Resold Services (Cont'd)**

**F. Access Groups - Equal Access Offices Only**

1. When all the usage on an access group originates from and/or terminates at end offices that have been converted to equal access the Access Charge per minute as set forth in E3.10. following will apply. The minutes billed Carrier Common Line Access Service charges will be the adjusted terminating intrastate access minutes and the adjusted originating intrastate access minutes for such access groups.
2. The adjusted terminating access minutes will be the terminating intrastate access minutes less the reported resold terminating MTS and/or MTS-type service minutes of use as set forth preceding; but not less than zero. The adjusted originating access minutes will be the originating intrastate access minutes less the reported resold originating MTS and/or MTS-type service minutes of use; but not less than zero.

**G. (DELETED)**

**H.** The adjustment as set forth in F. preceding will be made to the involved IC account no later than either the next bill date, or the one subsequent to that, depending on when the usage report is obtained. (D)

**I.** When the MTS-type and/or MTS usage is shown in hours, the number of hours shall be multiplied by sixty to develop the associated MTS and MTS-type minutes of use. If the MTS and/or MTS-type usage is shown in a unit that does not show hours or minutes, the IC shall provide a factor to convert the shown units to minutes.

**J.** The adjustment as set forth in F. preceding will be made to the involved IC account after making the adjustments to the IC account as set forth in E3.9 following.

#### **E3.8 Reserved for Future Use**

 (T)

BELLSOUTH  
TELECOMMUNICATIONS, INC.  
FLORIDA  
ISSUED: January 29, 2002  
BY: Joseph P. Lacher, President -FL  
Miami, Florida

ACCESS SERVICES TARIFF

Second Revised Page 7  
Cancels First Revised Page 7

EFFECTIVE: February 28, 2002

### **E3. CARRIER COMMON LINE ACCESS**

**E3.8 Reserved for Future Use**

(T)

ISSUED: December 19, 2013

EFFECTIVE: December 20, 2013

BY: Marshall M. Criser III, President -FL  
Miami, Florida

### E3. CARRIER COMMON LINE ACCESS

#### E3.9 Rate Regulations

- A. The Carrier Common Line Charges will be billed to each BellSouth SWA service provided under this Tariff in accordance with the regulations as set forth following except as set forth in E3.7.D preceding and D. following.
- B.
- C. When Carrier Common Line Access Service is provided in association with BellSouth SWA FGA, BellSouth SWA FGB, BellSouth SWA LSBSA and BellSouth SWA TSBSA 1 BellSouth SWA service in an end office not converted to equal access, in Company end offices that are not equipped for measurement capabilities, an assumed average access minutes will be used to determine the Carrier Common Line charges. The assumed average access minutes are as set forth in E6.7.8 following.
- D. When the IC orders line-side BellSouth SWA as set forth in E6.7.3. following and reports the data as set forth in E3.4.F. preceding and in E6.7.3. following, the IC monthly Carrier Common Line Charge access minutes will be adjusted as follows:
  - 1. For the first month both the BellSouth SWA service and the resold Dedicated Access Line Service provided under this Tariff are in service in the same state in the same LATA and provided by the same Company, the Carrier Common Line Access originating access minutes for the IC LATA account or End Office account involved, whichever type of account is used by the billing entity, will be adjusted as follows. After the billing entity verifies that the number of Dedicated Access Line Services in service as reported by the IC is accurate, the Carrier Common Line Access originating access minutes developed for the IC account involved will be reduced by the amount of minutes associated with resold Dedicated Access Line Services reported as set forth in E3.4.F. preceding and E6.7.3. following for line side BellSouth SWA service. The adjustment will be made to the involved IC account no later than either the next bill date, or the one subsequent to that, depending on when the report is received.

(D)  
|  
(D)

### E3. CARRIER COMMON LINE ACCESS

#### E3.9 Rate Regulations (Cont'd)

- D. (Cont'd)
2. For every monthly period after the first monthly period both the BellSouth SWA service and the resold Dedicated Access Line Service provided under this Tariff are in service in the same state in the same LATA and provided by the same Company, the Carrier Common Line Access originating access minutes for the IC LATA account or End Office account involved, whichever type of account is used by the billing entity, will be adjusted as follows. The Carrier Common Line Access originating access minutes developed for the IC account involved will be reduced by the amount of minutes associated with resold Dedicated Access Line Services reported as set forth in E3.4.F. preceding and E6.7.3. following for line side BellSouth SWA service. The adjustment will be made to the involved IC account no later than either the next bill date, or the one subsequent to that, depending on when the report is received.
  3. The originating access minutes for Carrier Common Line Access, adjusted as set forth in 1. or 2. preceding, whichever is appropriate, or any other section of this Tariff, that are billed to an IC in a monthly period shall not be less than zero.
  4. The adjustment as set forth in 1., 2. and 3. preceding will be made to the involved IC account after making the adjustments to the IC account as set forth in E. and F. following.
- E. When the IC reports exchange minutes of use, as long as the exchange minutes are not included in the minutes used to develop the reports as set forth in E2.3.14. preceding, as set forth in E3.4.G. preceding for in service BellSouth SWA service in a LATA, the Carrier Common Line Access minutes for the IC LATA account or End Office account involved, whichever type of account is used by the billing entity, will be adjusted as follows. After the billing entity verifies the exchange minutes reported by the IC are accurate, the Carrier Common Line Access minutes developed for the IC account involved will be reduced by the exchange minutes of use reported by the IC. If the billing entity determines the reported exchange minutes are not accurate, no adjustment will be made until a new report properly stating the exchange minutes is delivered to the billing entity by the IC. The access minutes, adjusted as set forth in this paragraph or any other section of this Tariff, that are billed to the IC in a monthly period shall not be less than zero. This adjustment will be made to the involved IC account prior to making the adjustments to the IC account as set forth in D. preceding and F. following.
- F. When the customer reports interstate and intrastate use of in-service BellSouth SWA service, the Carrier Common Line Access Service charges will be billed only to intrastate BellSouth SWA service access minutes based on the data reported by the customer as set forth in E2.3.10 preceding except where the Company is billing according to actuals by jurisdiction. The intrastate BellSouth SWA service access minutes will, after adjustment as set forth in E3.7.D. preceding, when necessary, be used to determine the Carrier Common Line Access Service charges as set forth in G. following.
- G. After the adjustments as set forth in E3.7.D. and D. preceding have been applied, when necessary, to the BellSouth SWA service access minutes, the charges for the involved customer account will be determined as follows:
1. The access minutes for all rated BellSouth SWA service subject to Carrier Common Line Access Service charges will be multiplied by the access per minute rate as set forth in E3.10 following.
  2. Carrier Common Line Access Service charges shall not be reduced as set forth in E3.7.A. preceding unless Switched Access Charges, as set forth in Section E6. following, are applied to the customer's BellSouth SWA services.
  3. Terminating access per minute charge(s) apply to:
    - all terminating access minutes of use

(C)

ISSUED: December 19, 2013

EFFECTIVE: December 20, 2013

BY: Marshall M. Criser III, President -FL  
Miami, Florida

### E3. CARRIER COMMON LINE ACCESS

#### E3.9 Rate Regulations (Cont'd)

G. After the adjustments as set forth in E3.7.D. and D. preceding have been applied, when necessary, to the BellSouth SWA service access minutes, the charges for the involved customer account will be determined as follows: (Cont'd)

3. Terminating access per minute charge(s) apply to: (Cont'd)

- all originating access minutes of use associated with BellSouth SWA FGA and BellSouth SWA LSBSA services where the off-hook supervisory signaling is forwarded by the customer's equipment when the called party answers;
- all originating access minutes of use associated with calls placed to 700, 800 and 900 numbers, less the percentage of originating access minutes of use reported by the customer, as set forth following, that are associated with calls placed to 700, 800 and 900 numbers that terminate in a BellSouth SWA service that is assessed Carrier Common Line Access Service charges.

For originating access minutes of use associated with calls placed to 700, 800 and 900 numbers which terminate on a BellSouth SWA service assessed Carrier Common Line Access Service charges, the customer shall report as follows: On or before the fifteenth day of each March, June, September and December the customer shall provide the Company a report of the percentage of total interstate 700, 800 and 900 originating minutes of use that will terminate in a BellSouth SWA service that is assessed Carrier Common Line Access Service charges for the forthcoming quarter. The reported percentage will be used by the Company to determine the customer's current monthly bill for the originating minutes of use for which the report was provided as set forth in 5. following. The customer reported percentage should reflect any under or over estimate in the prior quarter. In the event the customer does not supply a report, the Company will assume the percentage to be the same as that provided in the previous quarterly report.

If a dispute arises concerning the customer provided quarterly percentage report, the Company may request the customer to provide the data the customer used to determine the percentage. The customer shall retain for twelve (12) months call detail records from which the reported percentage credit can be ascertained. Upon request of the Company, the customer shall make records available for inspection as reasonably necessary for purposes of verification of the percentages and shall supply the data within 30 days of the Company's request. The Company will not request such data more than twice a year.

H. The originating premium access per minute charge(s) apply to all originating access minutes of use: (D)

- less those originating access minutes of use associated with BellSouth SWA FGA and BellSouth SWA LSBSA services where off-hook supervisory signaling is forwarded by the customer's equipment when the called party answers;
- less all originating access minutes of use associated with calls placed to 700, 800, and 900 numbers;
- plus all originating access minutes of use associated with calls placed to 700, 800, and 900 numbers for which the customer furnishes a report of the percentage of minutes that terminate in a BellSouth SWA service that is assessed Carrier Common Line Access Service charges, and for which a corresponding reduction in the number of terminating access minutes of use has been made as set forth in G. preceding.

I. (DELETED)

### 3. CARRIER COMMON LINE ACCESS

#### E3.10 Rates and Charges (Cont'd)

A. The rate for Carrier Common Line Access is: (Cont'd)

1. Per Originating Access Minute (Cont'd)

	<b>Rate</b>	<b>USOC</b>	
(a) 8YY BellSouth SWA FGA, BellSouth SWA FGB, BellSouth SWA FGD, BellSouth SWA LSBSA, BellSouth SWA TSBSA 1 and BellSouth SWA TSBSA 3.	<b>\$ .00</b>	<b>NA</b>	(C)
(b) Non-8YY BellSouth SWA FGA, BellSouth SWA FGB, BellSouth SWA FGD, BellSouth SWA LSBSA, BellSouth SWA TSBSA 1 and BellSouth SWA TSBSA 3.	<b>.00</b>	<b>NA</b>	(N)   (N)

2. Per Terminating Access Minute

(a) BellSouth SWA FGA, BellSouth SWA FGB, BellSouth SWA FGD, BellSouth SWA LSBSA, BellSouth SWA TSBSA 1 and BellSouth SWA TSBSA 3.	<b>.000000</b>	<b>NA</b>	
---	----------------	-----------	--



EFFECTIVE: July 15, 1996

**E4. CARRIER ACCESS CAPACITY<sup>1</sup>**

(N)

CONTENTS

	New Page	Old Page
<b>E4.1 General Description</b>	1	1
<b>E4.2 Limitations</b>	1	1
<b>E4.3 Obligations of the IC</b>	1	1
<b>E4.4 Minimum Periods and Credit Allowances</b>	1	1
<b>E4.5 Rate Regulations</b>	1	1
<b>E4.6 Rates and Charges</b>	2	2

**Note 1:** Text is shown as new due to reissue of all Tariff Sections. No changes in rates or regulations were made with this filing.

ISSUED: February 14, 1997  
BY: Joseph P. Lacher, President -FL  
Miami, Florida

EFFECTIVE: March 1, 1997

## E4. CARRIER ACCESS CAPACITY

The Company will provide Carrier Access Capacity to ICs and End Users associated with the provision of *BellSouth SWA* service. (T)

### E4.1 General Description

- A. Carrier Access Capacity is the busy hour minutes of capacity ordered by an IC or End User and provided by the Company for the purpose of furnishing intrastate telecommunications service.
- B. The capacity provided is based on the IC's and/or End User's order subject to the ordering regulations in sections E5. and E6. following.
- C. The installation charge associated with the capacity ordered is set forth in E6.8. following.

### E4.2 Limitations

- A. A telephone number is not provided with Carrier Access Capacity.
- B. Detail billing is not provided with Carrier Access Capacity.
- C. Directory listings are not provided with Carrier Access Capacity.
- D. Intercept arrangements are not provided with Carrier Access Capacity.

### E4.3 Obligations of the IC

- A. When the IC and/or End User reports interstate use of *BellSouth SWA* service, the associated Carrier Access Capacity used by the IC and/or End User for both interstate and intrastate will be apportioned as set forth in E2.3.14. preceding. (T)

### E4.4 Minimum Periods and Credit Allowances

- A. Minimum Period  
Minimum periods are described in detail in E5. following.
- B. Allowance for Interruptions  
When there is an interruption to the Carrier Access Capacity provided the IC and/or End User the credit allowance for interruptions as set forth in E2.4.4. preceding apply.
- C. Temporary Suspension of Service  
There will be no suspension of service for Carrier Access Capacity.

### E4.5 Rate Regulations

- A. The Carrier Access Capacity charge will be billed on a monthly basis per ordered busy hour minute of capacity installed as of the billing date each month.

ISSUED: June 21, 2012  
BY: Marshall M. Criser III, President -FL  
Miami, Florida

EFFECTIVE: June 22, 2012

## E4. CARRIER ACCESS CAPACITY

### E4.5 Rate Regulations (Cont'd)

- B. The application of premium rates is as set forth in E6.7.13 following.
- C. The Carrier Capacity charge in association with capacity used in the provision of BellSouth SWA FGA FX/ONAL type services will be billed to the IC, except in those instances when there is no IC involved in providing the service, i.e., BellSouth SWA FGA or BellSouth SWA LSBSA BellSouth SWA FGA FX/ONAL type service used for off-network access associated with a Company provided private network switch. When there is no IC involved in providing the BellSouth SWA FGA or BellSouth SWA LSBSA BellSouth SWA FGA FX/ONAL type service the end user will be billed the full Carrier Access Capacity charge.
- D. The Carrier Access Capacity charge in association with the provision of BellSouth SWA FGB or BellSouth SWA TSBSA 1 type service to an End User(s), will be billed to the End User(s).

### E4.6 Rates and Charges

- A. Carrier Access Capacity Charge
  - 1. Busy hour capacity  
Per Minute

(a) BellSouth Telecommunications, Inc.

Monthly Rate  
\$-

USOC  
UCMBH

(D)  
(D)  
(D)  
(D)  
(D)  
(D)  
(D)

**E5. ORDERING OPTIONS FOR ACCESS SERVICES<sup>1</sup>**

(N)

CONTENTS

	New Page	Old Page
<b>E5.1 General</b>	1	1
E5.1.1 Scope	1	1
E5.1.2 Ordering Conditions	1	1
E5.1.3 Provision of Other Services	2	1.1
E5.1.4 Special Construction	2	1.1
<b>E5.2 Access Order</b>	3	1.1
E5.2.1 Provision of Service	3	1.1
E5.2.2 Reserved for Future Use	9	2.2
E5.2.3 Access Order Modifications	9	3
E5.2.4 Cancellation of an Access Order	12	6
E5.2.5 Selection of Facilities For Access Orders	15	6.1
E5.2.6 Minimum Period	15	6.1
E5.2.7 Minimum Period Charges	16	7
E5.2.8 Shared Use Facilities	17	7
<b>E5.3 Available Inventory</b>	18	7.1
<b>E5.4 Shared Network Arrangement</b>	18	7.1
E5.4.1 General	18	7.1
<b>E5.5 Reserved for Future Use</b>	19	7.1

**Note 1:** Text is shown as new due to reissue of all Tariff Sections. No changes in rates or regulations were made with this filing.

## E5. ORDERING OPTIONS FOR ACCESS SERVICES

### E5.1 General

#### E5.1.1 Scope

- A. This section sets forth the regulations and order related charges for Access Orders for BellSouth SWA and Dedicated Access Services. These charges are in addition to other applicable charges as set forth in other sections of this Tariff.
- B. An Access Order is the Customer's request for the Telephone Company to provide the IC with BellSouth SWA service, Expanded Interconnection Service (EIS), an End User with BellSouth SWA FGB service, an End User with Dedicated Access Service and Fast Packet Access Services or, to provide modifications to existing service. An Access Order may be submitted by Access Service Request (ASR) or by such other ordering processes as the Telephone Company may provide. Depending upon the services, facilities or services intervals dates requested, one or more Access Orders may be required to provide the customer with access service. (C)
- C. The End User is ultimately responsible for the placing of and payment for all Dedicated Access orders and Dedicated Access charges as set forth in Sections E7 and E13 with the following exception. Payment for Dedicated Access Service nonrecurring charges required as a result of an IC generated activity is the responsibility of the IC. IC generated activity is defined as the relocation of an IC POP. (N)
- D. The End User is responsible for the placing of and payment for BellSouth SWA FGB and BellSouth SWA TSBSA 1 orders and charges as set forth in Sections E3 and E4 and Section 6 of Tariff FCC No. 1. (D)
- E. Any entity intending to resell private line services must be certificated by the Florida Public Service Commission as an Alternative Access Vendor (AAV) for intraexchange services, and as an AAV or Interexchange Carrier (IC) for interexchange services. Those entities certificated as an AAV or IC may resell private line services only by purchasing the like service from Section E7., Dedicated Access Services, of the Company's intrastate Access Service Tariff. Any entity certificated as an AAV or IC may purchase and resell a Local Exchange Company's (LEC's) private line service only between affiliated entities. (N)
- F. Alternative Access Vendors (AAVs) can resell a Dedicated Access Service which is part of a dedicated interexchange private line between affiliates, and a dedicated access service to an ICs switched network without affiliate restriction. In addition, an IC can resell an interexchange private line service under its existing IC certificate with no affiliate restriction, provided the LEC provides the local channel (LC) on each end of the private line service. However, if an IC utilizes an AAV to provide the LCs, the affiliate restrictions will apply. (N)

#### E5.1.2 Ordering Conditions

- A. An IC or End User may order any number of services of the same type and between the same locations on a single Access Order. All details for services for a particular order must be identical except for multipoint service.
- B. The IC or End User shall provide all information necessary for *BellSouth* to provide and bill for the requested service. In addition to the order information required in Section E5.2, the IC or End User must also provide: (T)
  - Customer name and premises address(es).
  - Billing name and address (when different from customer name and address).
  - Customer contact name(s) and telephone number(s) for the following provisioning activities: order negotiation, order confirmation, interactive design, installation and billing.
- C. A customer that orders services from this Tariff as an Enhanced Service Provider (ESP), must provide a signed statement that it meets the ESP definition as provided in Section E2.6. (T)
- D. BellSouth SWA service orders for BellSouth SWA FGA and BellSouth SWA LSBSA shall be in lines.

**E5. ORDERING OPTIONS FOR ACCESS SERVICES**

**E5.1 General (Cont'd)**

**E5.1.2 Ordering Conditions (Cont'd)**

- E. BellSouth SWA Service orders for BellSouth SWA FGB, BellSouth SWA FGD and BellSouth SWA TSBSA 1 and 3 shall be in trunks.
- F. Dedicated Access Line service must be ordered in lines for use with a BellSouth SWA FGD and BellSouth SWA TSBSA 3 service which is in service or on order.
- G. The day upon which the customer has provided to BellSouth a firm commitment for the service and complete and accurate information to allow for the processing of the Access Order *by three o'clock p.m. Eastern Standard Time (EST)*<sup>1</sup> is the Application Date. BellSouth will release an optional initial Pending Order Confirmation, which will include the BellSouth order number and circuit identification. At the customer's request, when BellSouth facility availability is verified, either a Firm Order Confirmation, which will include critical date information, or a Design and Ordering Confirmation, which will include design as well as critical date information, will be released. Critical date information will include the Service Date. The Service Date (also sometimes referred to as the due date) is the date service is to be made available to the customer and billing will commence.

(N)

A Pending Order Confirmation is available for orders for BellSouth-provided switched access dedicated transport services, where ordered separately from other switched access services, and for BellSouth-provided special access services. A Design and Ordering Confirmation is not available for orders submitted by end users. A Pending Order Confirmation and a Design and Ordering Confirmation are not available on orders for services provided jointly with another exchange telephone company.

- H. The time required to provision the service (i.e., the interval between the Application Date and the Service Date) is known as the service interval. Such intervals will be established in accordance with published service date interval guidelines which are available to ICs and End Users upon request, whether the IC's service is subject to standard or negotiated intervals. The IC or End User may request a service date other than that established pursuant to the service date interval guidelines, and the Company, where possible, will establish the service date in accordance with such request, subject, however, to other applicable provisions of this Tariff.
- I. The following charges will apply for the installation, move or rearrangement of BellSouth SWA or Special Access (a.k.a. BellSouth SPA) service orders with an agreed upon service date interval of four business days or less following the Application Date of the order. These charges are in addition to other applicable BellSouth SWA or Special Access (a.k.a. BellSouth SPA) nonrecurring charges for installations, moves or rearrangements of service. These charges will not apply to services provided on a Special Services Arrangement or on an Individual Case Basis, or in the event the agreed upon Service Date, as set forth preceding, is not met, or at the request of the customer to convert from a lower to higher order of service as provided for in Section E2.4.9A.

(T)

I. Per Service Order

	Nonrecurring	
	Charge	USOC
(a) Special Access (a.k.a. BellSouth SPA)	\$365.00	SOCSP
(b) BellSouth SWA	300.00	SOCSW

- J. An IC or End User who initiates a conversion (rollover) of a BellSouth SWA DS1 to a BellSouth SWA DS3 High Capacity service is also responsible for submitting Network Channel Interface (NCI) Code Update requests, either mechanically or manually, on all sub-DS1 level circuits that ride the channelized BellSouth SWA DS1 High Capacity service being rolled over. The Company and the IC or End User will work cooperatively to establish the number of circuits which may be submitted monthly for purposes of mechanical NCI Code updates associated with rollovers of BellSouth SWA FG DS1 High Capacity service to BellSouth SWA DS3 High Capacity service.
- K. An IC who converts from an existing feature group service to an equivalent unbundled service (i.e., BellSouth SWA FGA to BellSouth SWA LSBSA, BellSouth SWA FGB to BellSouth SWA TSBSA 1 and BellSouth SWA FGD to BellSouth SWA TSBSA 3) shall do so on no lower than an end office level. The Company and the IC will work cooperatively to accomplish these conversions.

**E5.1.3 Provision of Other Services**

- A. Testing Service, Additional Labor and Special Facilities Routing shall be ordered with an Access Order as set forth in B. following. The rates and charges for these services, as set forth in other sections of this Tariff, will apply in addition to the ordering charges set forth in this section and the rates and charges for the Access Service with which they are associated.

**Note 1:** Access Orders received after three o'clock p.m. EST will be processed the next business day, which will be the Application Date.

ISSUED: May 31, 2013

EFFECTIVE: July 2, 2013

BY: Marshall M. Criser III, President -FL  
Miami, Florida

## E5. ORDERING OPTIONS FOR ACCESS SERVICES

### E5.1 General (Cont'd)

#### E5.1.3 Provision of Other Services (Cont'd)

- B. With the agreement of the Company, the items listed in A. preceding may subsequently be added to the order at any time, up to and including the service date for the Access Service. When added subsequently, charges for a design change as set forth in E5.2.3 following will apply when an engineering review is required.
- C. Additional Engineering is not an ordering option, but will be applied to an Access Order when the Company determines that Additional Engineering is necessary to accommodate an IC or End User request. Additional Engineering will only be required as set forth in E13.1 following. When it is required, the IC or End User will be so notified and will be furnished with a written statement setting forth the justification for the Additional Engineering as well as an estimate of the charges. If the IC or End User agrees to the Additional Engineering, a firm order will be established. If the IC or End User does not want the service or facilities after being notified that Additional Engineering of Company facilities is required, the order will be withdrawn and no charges will apply. Once a firm order has been established, the total charge to the IC or End User for the Additional Engineering may not exceed the estimated amount by more than 10 percent.
- D. The regulations, rates and charges for Additional Engineering are as set forth in E13.1 following and are in addition to the regulations, rates and charges specified in this section.

#### E5.1.4 Special Construction

- A. The regulations, rates and charges for Special Construction are set forth in Section E14. following and are in addition to the regulations, rates and charges specified in this Tariff.

### E5.2 Access Order

#### E5.2.1 Provision of Service

##### A. General

An Access Order is used by the Company to provide to an IC or End User Access Service as follows:

1. **BellSouth SWA** services as set forth in Section 6 of Tariff FCC No. 1, (C)
2. Dedicated Access Services as set forth in Section E7. following, and
3. Expanded Interconnection Service (EIS) Cross-Connect Elements as set forth in Section E20. following.
4. Other Services as set forth in E5.1.3 preceding.

##### B. Information Required

When placing an order for Access Service, the IC, End User or End User's authorized agent shall provide, at a minimum, the following information:

1. For **BellSouth SWA FGA** or **BellSouth SWA LSBSA** service, the IC shall specify:
  - a. Number of lines
  - b. First point of switching (i.e., the dial tone office)
  - c. Directionality of the service

ISSUED: May 31, 2013

EFFECTIVE: July 2, 2013

BY: Marshall M. Criser III, President -FL  
Miami, Florida

## E5. ORDERING OPTIONS FOR ACCESS SERVICES

### E5.2 Access Order (Cont'd)

#### E5.2.1 Provision of Service (Cont'd)

##### B. Information Required (Cont'd)

1. For BellSouth SWA FGA or BellSouth SWA LSBSA service, the IC shall specify: (Cont'd)
  - d. BellSouth SWA Transport Options, if any
  - e. Local Switching Options, if any
  - f. Whether the off-hook supervisory signaling is to be provided by the IC's equipment or if it is to be forwarded by the IC's equipment when the called party answers
  - g. If the service is to be provided with an extension to a different exchange, (the IC's premises at which the extension is to be terminated)
  - h. Percent Interstate Usage (PIU) as specified in E2.3.14 *of this Tariff*
  - i. Provide Connecting Facility Assignment (CFA), if associated with a high capacity facility
  - j. For Switched Local Channel and Switched Dedicated Interoffice Channel, the capacity
2. For BellSouth SWA FGB or BellSouth SWA TSBSA 1 service, the IC shall specify:
  - a. The number of trunks
  - b. For trunks to an end office, the end office
  - c. For trunks to an Access Tandem
    - (1) The Access Tandem Switch
    - (2) An Estimate of the amount of traffic it will generate to and/or from each end office subtending the access tandem (to assist the Company in its own efforts to project further facility requirements.)
  - d. BellSouth SWA Transport Options, if any
  - e. Local Switching Options (including BSEs), if any
  - f. For terminating only access, whether the trunks are to be arranged in trunk group arrangements or provided as single trunks
  - g. The traffic type using the categories specified in Section 6.1.1 of Tariff FCC No. 1 following to enable efficient provisioning and billing functions. (C)
  - h. Percent Interstate Usage (PIU) as specified in E2.3.14 *of this Tariff*
  - i. Provide Connecting Facility Assignment (CFA), if associated with a high capacity facility
  - j. For *BellSouth SWA* Local Channel and Switched Dedicated Interoffice Channel, the capacity
  - k. **(DELETED)**



## E5. ORDERING OPTIONS FOR ACCESS SERVICES

### E5.2 Access Order (Cont'd)

#### E5.2.1 Provision of Service (Cont'd)

##### B. Information Required (Cont'd)

3. For BellSouth SWA FGD or BellSouth SWA TSBSA 3 service, the IC shall specify:
  - a. The number of BellSouth SWA FGD or BellSouth SWA TSBSA 3 trunks
    - (1) for trunks ordered to an end office, the end office
    - (2) for trunks ordered to an Access Tandem, the Access Tandem Switch
    - (3) for trunks with coin sent-paid capability ordered to a TOPS tandem, the TOPS Tandem Switch
    - (4) an estimate of the amount of traffic it will generate to and/or from each end office subtending the access and/or TOPS tandem (to assist the Company in its own efforts to project further facility requirements).
  - b. BellSouth SWA Transport Options, if any
  - c. Local Switching Options (including BSEs), if any
  - d. The traffic type using the categories specified in Section 6.1.1 of Tariff FCC No. 1 to enable efficient provisions and billing functions.
  - e. Provide Connecting Facility Assignment (CFA), if associated with a high capacity facility
  - f. For BellSouth SWA Local Channel and Switched Dedicated Interoffice Channel, the capacity  
The coin capable end offices and TOPS tandem switches are identified in the Wire Center Section of the NECA No. 4 Tariff.
4. For BellSouth SWA FGD and BellSouth SWA TSBSA 3 with BellSouth SWA CCSAC in addition to the information listed in 3. preceding, the IC shall provide: a reference to existing signaling connections or reference to a related BellSouth SWA CCSAC signaling connection order; BellSouth SWA CCSAC Local Switching options, if any; for BellSouth CCS7 Signaling Connections, STP point codes and location identifier codes, circuit identification codes and switch type; and, for BellSouth CCS7 Signaling Connections, specification of the level of diversity in its network, as defined in the BellSouth Guidelines to Technical Publication TR-TSV-000905.  
Service Installation Guarantees, as set forth in E2.4.10 of this Tariff, are not applicable for the installations of CCSAC signaling.  
For BellSouth SWA FGD and BellSouth SWA TSBSA 3 with 64 Clear Channel Capability (CCC), in addition to the information listed in 3. and 4. preceding, the IC shall specify 64 CCC Local Switching Options, if any.
5. When ordering Operator Transfer Service, the IC shall specify the number of new or additional BellSouth SWA FGD, BellSouth SWA TSBSA 3 Trunks desired, if any, to carry originating traffic from the Operator Services System location to the IC location in each LATA served by the Operator Services System where the IC requests Operator Transfer Service.
6. **(DELETE)**
7. For BellSouth *SWA Common Transport IP Option*, the IC shall specify:
  - a. An estimate of the amount of traffic it will generate to each access tandem stated in minutes of use.

(D)  
|  
(D)

## E5. ORDERING OPTIONS FOR ACCESS SERVICES

### E5.2 Access Order (Cont'd)

#### E5.2.1 Provision of Service (Cont'd)

(D)  
|  
(D)

#### C. Traffic Engineering Responsibilities

1. The IC is responsible to assure that sufficient access facilities have been ordered to handle its traffic.
2. When ordering BellSouth SWA service, the trunks may be determined by the IC in the following manner. For each day the IC shall determine the highest number of trunks in use for a single hour. The IC shall, for the same hour period (i.e., busy hour), pick the twenty consecutive business days in a calendar year which add up to the largest number of trunks in use. The IC shall then determine the average busy hour trunks by dividing the largest number of trunks in use figure, for the same hour period, for the twenty consecutive business day period by 20. This computation shall be performed for each end office and/or access tandem the IC wishes to serve.
3. If data to develop a twenty-consecutive day period is not available, the IC may use a twenty day period that contains as many consecutive days as is available.
4. When an IC desires BellSouth SWA service to an end office that is a remote switching office, the IC must order to the host office which controls the remote switching office since all traffic to and/or from a remote switching office must be routed through the host office.
5. When ordering Dedicated Access Services from this Tariff, the IC or End User must provide a Percent Interstate Usage (PIU) of 0 percent. The jurisdiction will be determined as set forth in E2.3.14.A.9 *of this Tariff*.
6. When ordering Dedicated Access Line Service from this Tariff, the IC must provide a Percent Interstate Usage (PIU) of 0 percent. The jurisdiction will be determined as set forth in E2.3.14.A.9 *of this Tariff*.
7. For all access services ordered by an IC, proof of certification by the Florida Public Service Commission must be provided by the IC to the Company in accordance with the provisions in E2.3 *of this Tariff*.

#### D. Determination of CCS7 Signaling Connections and Terminations

The customer shall work cooperatively with the Company to determine the number of CCS7 Signaling Connections and CCS7 Signaling Terminations required to handle its signaling traffic.

#### E. BellSouth SWA 500 Service

For BellSouth SWA 500 service, as described in Section 6.2 of Tariff FCC No. 1 the IC shall order in the same manner which is set forth preceding for ordering BellSouth SWA FGD, BellSouth SWA TSBSA and 3 except that ICs must order BellSouth SWA FGD, BellSouth SWA TSBSA or 3 to all end offices within the IC designated LATA(s), either through the tandem or by direct connections to the end office.

The IC is also responsible for reporting to the Company the percent interstate usage (PIU) for BellSouth SWA 500 service as set forth in E2.3.14 *of this Tariff*.

ISSUED: December 19, 2013

EFFECTIVE: December 20, 2013

BY: Marshall M. Criser III, President -FL  
Miami, Florida

## E5. ORDERING OPTIONS FOR ACCESS SERVICES

### E5.2 Access Order (Cont'd)

#### E5.2.1 Provision of Service (Cont'd)

**F. BellSouth SWA 8XX Toll Free Dialing Ten Digit Screening Service**

For BellSouth SWA 8XX Toll Free Dialing Ten Digit Screening Service as described in Section 6.2.5 of Tariff FCC No. 1, the IC shall order in the same manner which is set forth preceding for ordering BellSouth SWA FGD or BellSouth SWA TSBSA 3 except that the IC must order BellSouth SWA FGD or BellSouth SWA TSBSA 3 to all access tandems or direct connections to all end offices designated by the Company as Service Switching Points for BellSouth SWA 8XX Toll Free Dialing Ten Digit Screening Service within the LATA. Direct trunk routes cannot be provided unless the end office is equipped to provide the IC identification function. All traffic originating from end offices not equipped to provide the IC identification function require routing via the serving access tandem at which the function is available. Service must be ordered accordingly.

The IC is also responsible for reporting to the Company the percent interstate usage (PIU) for BellSouth SWA 8XX Toll Free Dialing Ten Digit Screening Service as set forth in E2.3.14 *of this Tariff*.

**G. BellSouth 8XX Toll Free Dialing Number Administration Service**

When ordering BellSouth 8XX Toll Free Dialing Number Administration service as described in E13.3.12 *of this Tariff*, the IC must, at a minimum, provide the following information to the Company:

- Area of service<sup>1</sup>
- Name(s) of intraLATA and interLATA carrier(s), as applicable
- Access Carrier Name Abbreviation (ACNA) Code of the interLATA and intraLATA carrier, as applicable
- Activation date

When the POTS number is to be delivered to an IC, the IC must provide the full 10-digit POTS number to be associated with the 800 number and must indicate to whom the POTS number is to be delivered. In addition, the IC must also provide the POTS numbers associated with the intraLATA portion of BellSouth SWA 8XX Toll Free Dialing Ten Digit Screening Service for subscribers who will use the Company for intraLATA BellSouth SWA 8XX Toll Free Dialing Ten Digit Screening Service.

For the transport of any intraLATA 800 call by the Company, the IC must provide the end user billing information necessary for the Company to bill the appropriate intraLATA rates.

If the IC desires any of the options available with BellSouth 8XX Toll Free Dialing Number Administration Service as set forth in E13.3.12 *of this Tariff*, these must also be specified on the order for service.

**H. BellSouth Directory Assistance Service**

For BellSouth Directory Assistance service, the IC shall specify the number of trunks from the IC premises to the Directory Assistance location. Unless direct routing is specified by the IC, BellSouth Directory Assistance service will be provided with BellSouth SWA FGB, BellSouth SWA FGD or BellSouth SWA TSBSA service. The IC shall also specify which BellSouth SWA FGB, BellSouth SWA FGD or BellSouth SWA TSBSA service trunk group is to be associated with the BellSouth Directory Assistance service. (D)

**Note 1 :** The standard area of service is the entire state. Other levels of area of service may be provided with the Customized Area of Service feature. (D)

## E5. ORDERING OPTIONS FOR ACCESS SERVICES

### E5.2 Access Order (Cont'd)

#### E5.2.1 Provision of Service (Cont'd)

- I. For all Dedicated Access Services, the End User or End User's authorized agent must specify the IC terminal location and end user premises or Hubs involved, the channel type (e.g., Voice Grade, High Capacity, etc.) the channel interface, technical specification package and options desired. For multipoint services, the channel interface at each end user premises may be different but all such interfaces shall be compatible.
- J. For BellSouth SWA Transport Services, the IC must specify the Facility Hubs involved, if applicable, the channel type (e.g. Switched Voice Grade, Switched DS1, etc.), the channel interface and any options desired.
- K. Where the Dedicated Access or WATS Access Line (a.k.a. BellSouth SPA WATS Line) service is exempt from the Dedicated Access Surcharge as set forth in Section E7. *of this Tariff*, the IC shall furnish with the order the certification as set forth in that section. (T)
- I. For WATS Access Line (a.k.a. BellSouth SPA WATS Line) service, the IC must also specify the type of calling (i.e., Originating Only, Terminating Only, or Two-Way) for which the service is to be provided. Additionally, when necessary screening functions are not provided at the wire center, which serves the IC's originating or terminating premises, the Company will provide the service to the nearest wire center where the capability exists. In these circumstances, the IC will be so notified and the order will be changed to designate the appropriate premises. No charge will apply for the change.
- M. To enable an IC to receive flat rate treatment on a WATS Access Line (a.k.a. BellSouth SPA WATS Line) used to provide terminating service (i.e., BellSouth SWA 8XX Toll Free Dialing Ten Digit Screening service), the IC must specify, by jurisdiction, the telephone number which is used to route the call.
- N. For BellSouth SWA 900 Service, the IC shall order in the same manner which is set forth preceding for ordering BellSouth SWA FGD or BellSouth SWA TSBSA 3 with the following exception. The IC must order BellSouth SWA FGD or BellSouth SWA TSBSA 3 to all access tandems or direct connections to all end offices designated by the Company as BellSouth SWA 900 service screening offices within a LATA. Direct trunk routes cannot be provided unless the end office is equipped to provide the IC identification function. All traffic originating from end offices not equipped to provide the IC identification function will require routing via the access tandem at which the function is available. Service must be ordered accordingly. In addition, the IC shall specify whether 900 NXX codes provided to the IC should be arranged for 1+ dialing only or for both 1+ and 0+ dialing. All 900 NXXs provided to an individual IC will be arranged for either 1+ dialing only or for both 1+ and 0+ dialing.  
When the IC desires activation of a 900 NXX code for 900 NXX screening the IC shall submit an Access Service Request (ASR) whether or not additional capacity is required.
- O. For BellSouth Billing Name and Address for ANI service, in addition to the ordering conditions set forth in E5.1.2 *of this Tariff*, the IC shall also provide the following: (T)
  1. The IC's Carrier Identification Code (CIC) or pseudo CIC code and Access Carrier Name Abbreviation (ACNA). In the event the IC does not have such an assignment the IC must contact the Company for this assignment.
  2. A list of Carrier Identification Codes (CICs) or pseudo CIC codes and Access Carrier Name Abbreviation (ACNA) for whom billing services are being performed.
  3. The established Company Carrier Access Billing System (CABS) Account (CO7) number and if no account exists the Company will establish a CO7 account for billing purposes.

## E5. ORDERING OPTIONS FOR ACCESS SERVICES

### E5.2 Access Order (Cont'd)

#### E5.2.1 Provision of Service (Cont'd)

- P. The Service Installation Guarantee, as set forth in Section E2.4.10, is applicable to specified services offered in this Tariff. The Service Installation Guarantee is applied on a per service order basis for BellSouth SWA services. The Service Installation Guarantee is applied on a per circuit basis for Dedicated Access Services. (T)
- Service Installation Guarantee, as set forth in Section E2.4.10, is not applicable for the installation of CCS7 Access Arrangement. (T)
- Q. For BellSouth SWA FGB, BellSouth SWA FGD and BellSouth SWA TSBSA 1 and service to a Mobile Telephone Switching Office (MTSO) directly interconnected to a Company Access Tandem Office, the IC shall provide information to the Company indicating the NXX codes(s) to be accessed.
- R. Expanded Interconnection Service (EIS)  
For EIS arrangements, the collocator must specify the type of cross-connect element to be utilized.
- S. When ordering BellSouth Remote Access Service, in addition to subscribing to the service by meeting the conditions set forth in E5.1.2 and E5.2.1.B.1, of this Tariff, the customer shall:
1. coordinate their access service request through a customer account team;
  2. populate the project field on the access service request with "BST-RAS"; and
  3. negotiate service intervals for BellSouth Remote Access Service.
- T. BellSouth *SWA Common Transport IP Option*  
For BellSouth *SWA Common Transport IP Option*, as described in Section 6.2 of Tariff FCC No. 1 the IC shall:
1. coordinate their Access Order through a customer account team;
  2. populate fields on the Access Order with information provided by the customer account team.

(DELETED)

#### E5.2.2 Reserved for Future Use

#### E5.2.3 Access Order Modifications

- A. The IC or End User may request a modification of its Access Order at any time prior to notification by the Company that service is available for the IC or End User's use. The Company will make every effort to accommodate a requested modification when it is able to do so with the normal work force assigned to complete such an order within normal business hours. If the modification cannot be made with the normal work force during normal business hours, the Company will notify the IC or End User. If the IC or End User still desires the Access Order modification, the Company will schedule a new service date. All charges for Access Order modification will apply on a per occurrence basis. (D)
- B. Any increase in the number of Dedicated Access Service channels, EIS cross-connect elements, or BellSouth SWA service lines, trunks or BellSouth SWA Transport facilities or BellSouth SWA CCS7 Signaling Connections and CCS7 Signaling Terminations will be treated as a new Access Order (for the increased amount only).
- C. If order modifications are necessary to satisfy the transmission performance for a Dedicated Access Service ordered by an IC or End User, these changes will be made without order modification charges being incurred by the End user.
- D. Service Date Change Charge
1. Access Order service dates for installation of new services or rearrangements of existing services, may be changed, but the new service date may not exceed the original service date by more than 30 calendar days. When, for any reason, the IC or End User indicates that service cannot be accepted for a period not to exceed 30 calendar days, and the Company accordingly delays the start of service, a Service Date Change Charge will apply. If the IC or End User requested service date is more than 30 calendar days after the original service date, the order will be cancelled by the Company and re-issued with appropriate cancellation charges applied unless the IC or End User indicates that billing for the service is to commence as set forth in Section E5.2.8. (T)

**E5. ORDERING OPTIONS FOR ACCESS SERVICES**

**E5.2 Access Order (Cont'd)**

**E5.2.3 Access Order Modifications (Cont'd)**

**D. Service Date Change Charge (Cont'd)**

2. Failure to notify the Company prior to the original service date to request a different service date may result in the application of a Service Date Change-Additional Dispatch Charge for installations, moves and rearrangement of services. If a Company technician is dispatched to the IC or End User's premises on the scheduled service date and the IC or End User has failed to notify the Company before three o'clock p.m. EST on the business day prior to the scheduled service date that it wishes to change the service date, the Company will delay the start of service pending negotiations with the IC or End User. If the IC or End User reschedules the service date, a Service Date Change-Additional Dispatch Charge will apply in addition to a Service Date Change Charge as specified in Section E5.2.3.D.4(a). If the IC or End User cancels the service date, cancellation charges will apply in accordance with terms and conditions for cancellation charges as set forth in Section E5.2.4. Cancellation of the order will not preclude the application of the Service Date Change Charge and Service Date Change-Additional Dispatch Charge assessed for prior occurrences on the same order. (T)
3. A new service date may be established that is prior to the original service date, if the Company determines it can accommodate the IC's or End User's request without delaying service dates for orders of other ICs, or End Users. (T)
4. A Service Date Change Charge will apply, on a per order per occurrence basis, for each service date changed. The Service Date Change-Additional Dispatch Charge will apply for each occurrence of a technician dispatch to the IC's or customer's premises when the customer is not ready for service as specified in Section E5.2.3.D.2. The applicable charges are:

	Nonrecurring Charge	USOC
(a) Service Date Change Charge, per Order	\$26.21	OMC
(B) Service Date Change-Additional Dispatch Charge, per Occurrence	\$150.00	OMCAD

5. For multiple orders with the same service date for the same customer premises, only one Service Date Change-Additional Dispatch Charge will apply. However, a Service Date Change Charge will apply for each order.
6. Service Installation Guarantee, as set forth in Section E2.4.10, is not applicable for Service Date Change charges. (T)
7. An exception to the Service Date Change Charge provisions in Sections E5.2.3.D.1 and 2 applies for BellSouth Metro Ethernet Service and AT&T Switched Ethernet Service. The following provisions apply: (N)

If a Customer is unable to accept Service on the original due date, the Customer may issue one or more supplements to an Access Order to change the original due date to a date no more than 120 calendar days after the original due date. When such requests are made, the Telephone Company will accordingly delay the start of service and the Customer will incur a Service Date Change Charge. The first supplement to the Access Order must be received by the Telephone Company on or before 30 calendar days after the original due date.

If a Customer has opted to issue a supplement to an Access Order to extend the original due date but is unable to accept Service within 121 calendar days after the original due date, one of the following will apply:

- If Service has not been fully provisioned, the Telephone Company will cancel the order on the 121st calendar day after the original due date and charges specified in Section E5.2.3.4(a) will apply, or
- If Service has been fully provisioned, the Telephone Company will begin billing for the Service on the 121st day after the original due date.

If a Customer is unable to accept Service within 31 calendar days after the original due date, and the Telephone Company has not received a supplement to the Access Order to extend the due date within 30 calendar days after the original due date, one of the following options will apply:

- If Service has not been fully provisioned, the Telephone Company will cancel the order on the 31st calendar day after the original due date and charges specified in Section E5.2.3.4(a) will apply, or
- If Service has been fully provisioned, the Telephone Company will begin billing for the Service on the 31st calendar day after the original due date. (N)

## E5. ORDERING OPTIONS FOR ACCESS SERVICES

### E5.2 Access Order (Cont'd)

#### E5.2.3 Access Order Modifications (Cont'd)

E. Partial Cancellation Charge

1. Any decrease in the number of ordered Dedicated Access Service channels, EIS cross-connect elements, or BellSouth SWA Service Lines, Trunks or BellSouth SWA Transport facilities, CCS7 Signaling Connections and CCS7 Signaling Terminations or WATS Access Lines (a.k.a. BellSouth SPA WATS Lines) will be treated as a partial cancellation and the charges as set forth in Section E5.2.4.B.4 will apply.

F. Design Change Charges

1. The IC or End User may request a design change to the service ordered. A design change is any change to an Access Order which requires engineering review. An engineering review is a review by Company personnel, of the service ordered and the requested changes to determine what changes in the design, if any, are necessary to meet the changes requested by the IC or End User. Design changes include such things as the addition or deletion of optional features or functions or a change in the type of BellSouth SWA Transport Termination type of channel interface, type of Interface Group or technical specification package. Design changes do not include a change of IC terminal location, End User premises, end office switch, BellSouth SWA FG type, BellSouth SWA Basic Serving Arrangement type, EIS cross-connect elements, or Dedicated Access Service channel type. Changes of this nature will require the issuance of a new order and the cancellation of the original order with appropriate cancellation charges applied.
2. Should an IC or End User requested design change be received on a pending access order that results in the establishment of a new service date that exceeds the original service date by more than 30 days, the IC or End User shall not be required to cancel and reissue a new order, but shall be billed a Design Change Charge and a Service Date Change Charge.
3. The Company will review the requested change, notify the IC or End User whether the change is a design change, if it can be accommodated and if a new service date is required. If the IC or End User authorizes the Company to proceed with the design change, a Design Change Charge will apply. The Design Change Charge will apply on a per order, per occurrence basis, for each order requiring a design change.

F. Design Change Charges (Cont'd)

3. (Cont'd)

The applicable charge is:

	Nonrecurring Charge	USOC
(a) Design change charge, per order	\$26.21	H28

Service Installation Guarantee, as set forth in Section E2.4.10, is not applicable for Design Change Charge.

4. If a change of service date is required, the Service Date Change Charge as set forth in Section E5.2.3.D will also apply.

G. (DELETED)

(M)  
|  
(M)

(T)  
(T)

## E5. ORDERING OPTIONS FOR ACCESS SERVICES<sup>1</sup>

(N)

### E5.2 Access Order (Cont'd)

#### E5.2.4 Cancellation of an Access Order

- A. An IC or End User may cancel an Access Order for the installation of service on any day prior to the service date. The cancellation date is the date the Company receives written notice from the IC or End User that the order is to be cancelled.

(D)

(D)

- B. When an IC or End User cancels an Access Order for the installation of service, a Cancellation Charge will apply as follows:

(D)

1. Costs incurred in conjunction with the provision of Switched Access Service, EIS Arrangements/EIS Cross-Connects, or Dedicated Access Service starts on the Application Date as defined in Section E5.2.4.B.4.b. Provisions addressing the application of charge for EIS elements are contained in Section E20.

(T)

2. When the IC or End User cancels an Access Order prior to the Design Layout Report Date, as defined in Section E5.2.4.B.4.b no charges shall apply.

(T)

3. When the IC or End User cancels an Access Order on or after the Design Layout Report Date, a charge equal to the estimated costs incurred by the Company shall apply. Such charge is determined as specified in Section E5.2.4.B.4.

(T)

4. Charges applicable as specified in Section E5.2.4.B.3. are based on the estimated costs incurred by the Company at the time the order is cancelled. The estimated costs incurred are determined based on the following:

(T)

- a. Certain Company critical dates are associated with an Access Order provisioning interval, whether standard or negotiated. These dates are used by the Company to monitor the progress of the provisioning process. At any point in the Access Order interval the Company is able to determine which critical date was last completed and can thus determine what percentage of the Company's provisioning costs have been incurred as of that critical date.

- b. The critical dates tracked by the Company are as follows:

**Application Date (APP):**

The date the IC or End User provides to the Company a firm commitment for service and sufficient information as detailed in E5.1 preceding to enable the Company to begin service provisioning. This is also the order date.

**Scheduled Issue Date (SID):**

The date that the order is to enter the Company's order distribution system.

**Loop Assignment and Make-up Date (LAM):**

The date by which Local Loop Assignment and Make-up information must be available.

**Design Layout Report Date (DLRD):**

The date the Design Layout Report (DLR) is forwarded to the IC or End User.

**Note 1:** Text is shown as new due to reissue of all Tariff Sections. No changes in rates or regulations were made with this filing.



FLORIDA

ISSUED: July 1, 1996

BY: Joseph P. Lacher, President - FL  
Miami, Florida

EFFECTIVE: July 15, 1996

## E5. ORDERING OPTIONS FOR ACCESS SERVICES<sup>1</sup>

(N)

### E5.2 Access Order (Cont'd)

#### E5.2.4 Cancellation of an Access Order (Cont'd)

- B. When an IC or End User cancels an Access Order for the installation of service, a Cancellation Charge will apply as follows: (Cont'd)
4. Charges applicable as specified in 3. preceding are based on the estimated costs incurred by the Company at the time the order is cancelled. The estimated costs incurred are determined based on the following: (Cont'd)
    - b. The critical dates tracked by the Company are as follows: (Cont'd)
      - Records Issue Date (RID):**  
The date that all design and assignment information is to be sent to the central office and installation forces.
      - Designed, Verified, and Assigned Date (DVA):**  
The date by which field implementation groups must report that all documents and materials have been received.
      - Wired and Office Tested Date (WOT):**  
The date by which all intraoffice wiring is to be completed, all plug-ins optioned, aligned, and frame continuity established, and the interoffice facilities, if applicable, tested. In addition, switching equipment, including translation loading, is to be installed and tested.
      - Frame Continuity Date (FCD):**  
Date on which frame-to-frame testing must be completed. This is sometimes referred to as the Facility Continuity Check Date.
      - Plant Test Date (PTD):**  
The date on which overall testing of the service is to be started.
      - Engineering Information Report Date (EIRD):**  
The date the engineering group in another ISS area provides information to the primary engineering group.
      - Service Date (DD):**  
The date on which service is to be made available to the IC or End User. This is sometimes referred to as the Due Date.
      - Confirming Design Layout Report Date (CDLRD):**  
The date the Design Layout Report (DLR) is to be confirmed by the IC or End User.
    - c. The percentage of the total provisioning cost incurred by the Company at a particular critical date varies by the type of service as shown in d. following.
    - d. When an IC or End User cancels an Access Order, or part of an Access Order, before the service date, the Company will apply cancellation charges to the order. Cancellation charges are calculated by multiplying all the nonrecurring charges associated with the order, or that part of the order being cancelled, by the percentage shown in e. following for the critical date last completed on the order.<sup>2</sup>
      - Note 1:** Text is shown as new due to reissue of all Tariff Sections. No changes in rates or regulations were made with this filing.
      - Note 2:** As set forth in E5.2.4.B.2., when an IC or End User cancels an order prior to the Design Layout Report Date, no cancellation charges shall apply.

**E5. ORDERING OPTIONS FOR ACCESS SERVICES**

**E5.2 Access Order (Cont'd)**

**E5.2.4 Cancellation of an Access Order (Cont'd)**

**B.** When an IC or End User cancels an Access Order for the installation of service, a Cancellation Charge will apply as follows:  
(Cont'd)

4. (Cont'd)

e. The resulting cancellation charge is also shown as follows:

(1) Cancellation Charge Percentages Listing No. 1

Type Service/ Critical Dates	After: Before:	APP SID	SID LAM	LAM EIRD	EIRD DLRD	DLRD RID	RID DVA	
DEDICATED ACCESS								
WATS (a.k.a. BellSouth SPA)		3.8%	9.6%	11.9%	16.2%	21.4%	29.6%	
Voice Grade (a.k.a. BellSouth SPA DS0 VG)		3.8%	9.5%	11.9%	16.1%	21.3%	29.7%	
Telegraph Grade (a.k.a. BellSouth SPA Telegraph)		3.8%	9.5%	11.9%	16.1%	21.3%	29.7%	
Metallic Grade (a.k.a. BellSouth SPA Metallic)		3.8%	9.5%	11.9%	16.1%	21.3%	29.7%	(T)
Program Audio (a.k.a. BellSouth SPA Program Audio)		3.6%	9.1%	11.3%	15.3%	20.3%	28.3%	
Digital Data Access (a.k.a. BellSouth SPA DS0 Digital Data)		3.6%	9.1%	11.4%	16.1%	21.9%	28.5%	
BellSouth Metro Ethernet service		11.6%	33.1%	42.9%	44.8%	47.3%	53.1%	(N)
EIS Cross-Connects		3.7%	9.3%	11.5%	15.6%	20.6%	28.8%	
BELLSOUTH SWA								
Trunks or Lines		8.6%	17.2%	17.2%	22.1%	28.0%	41.1%	
High Capacity (a.k.a. BellSouth SPA High Capacity)		3.7%	9.3%	11.5%	15.6%	20.6%	28.8%	
EIS Cross-Connects		3.7%	9.3%	11.5%	15.6%	20.6%	28.8%	

(2) Cancellation Charge Percentages Listing No. 2

Type Service/ Critical Dates	After: Before:	DVA WOT	WOT FCD	FCD PTD	PTD DD	DD	
DEDICATED ACCESS							
WATS (a.k.a. BellSouth SPA)		39.7%	47.5%	69.6%	93.3%	100.0%	
Voice Grade (a.k.a. BellSouth SPA DS0 VG)		39.5%	47.2%	69.5%	93.4%	100.0%	
Telegraph Grade (a.k.a. BellSouth SPA Telegraph)		39.5%	47.2%	69.5%	93.4%	100.0%	
Metallic Grade (a.k.a. BellSouth SPA Metallic)		39.5%	47.2%	69.5%	93.4%	100.0%	
Program Audio (a.k.a. BellSouth SPA Program Audio)		37.6%	45.0%	68.6%	93.7%	100.0%	
Digital Data Access (a.k.a. BellSouth SPA DS0 Digital Data)		36.0%	45.2%	69.9%	93.9%	100.0%	(M)
BellSouth Metro Ethernet service		53.1%	69.9%	85.6%	94.9%	100.0%	(N)
EIS Cross-Connects		38.3%	45.8%	68.9%	93.6%	100.0%	(M)
BELLSOUTH SWA							
Trunks or Lines		60.5%	67.8%	79.7%	95.8%	100.0%	(M)
BellSouth SWA High Capacity		38.3%	45.8%	68.9%	93.6%	100.0%	(M)
EIS Cross-Connects		38.3%	45.8%	68.9%	93.6%	100.0%	(M)

Material appearing on this page previously appeared on page(s) 15 of this section.

All BellSouth marks contained herein and as set forth in the trademarks and servicemarks section of this Tariff are owned by BellSouth Intellectual Property Corporation.

**E5. ORDERING OPTIONS FOR ACCESS SERVICES**

**E5.2 Access Order (Cont'd)**

**E5.2.4 Cancellation of an Access Order (Cont'd)**

5. The provisions of Sections E5.2.4.D.1-4 above shall not apply to cancellations of Access Orders for AT&T Switched Ethernet Service. Cancellation charges for AT&T Switched Ethernet Service are applied based upon the tiered fee schedule outlined below. When an IC cancels an Access Order (or a part of an order) for AT&T Switched Ethernet Service, cancellation charges will apply, even when nonrecurring installation charges would otherwise be waived. Cancellation charges will be calculated based on the number of calendar days between the Company's receipt of the Access Order and the cancellation date. A cancellation charge will apply on a per port connection basis as shown in the table below:

USOC	Cancellation Date – Calendar Days After Receipt of Order	Cancellation Charge (Per Port Connection)
NRFSC	0-10	\$0.00
NRFSD	11-30	\$650.00
NRFSE	31-60	\$2,000.00
NRFSP	61+	\$3,000.00

(N)  
 |  
 (C)  
 |  
 (N)

- C. When a customer cancels an order service for BellSouth Dedicated Ring or SMARTRing service (a.k.a. BellSouth Dedicated Ring) prior to the beginning of the selected service period, the customer will be liable for all capital expenses incurred by the Telephone Company in provisioning the BellSouth Dedicated Ring or SMARTRing service (a.k.a. BellSouth SPA Dedicated Ring), as of the date the order is canceled by the customer. The charges billed to the customer will not exceed an amount equal to the minimum period for the service as set forth in Section 6.1.3 of Tariff FCC No. 1 and Section E7.4 of this intrastate tariff at the month-to-month rates set forth in Sections E6.8 and E7.5 of this intrastate tariff. Such charges will be billed in addition to and subsequent to the cancellation charges set forth in Section E5.2.4.B.
- D. When an IC or End User cancels an order for the discontinuance of service, no charges apply for the cancellation.
- E. If the company misses a service date by more than 30 days due to circumstances over which it has direct control (excluding e.g., acts of God, government requirements, work stoppages and civil commotions), the IC or End User may cancel the Access Order without incurring cancellation charges.

**E5.2.5 Selection of Facilities For Access Orders**

- A. When an IC or End User places an Access Order, it may choose to utilize facilities it previously purchased as a facility to a Hub. If the IC has a high capacity interface or has a purchased facility, or has a Dedicated Access Service facility purchased to a Hub, the IC or End User must request that specific channels be used to implement the Access Order. If a facility assignment is not provided by the IC or End User, the Company will provide the service from available inventory as discussed in E5.3 following.
- B. For all other Access Orders, the option to request a specific transmission path or channel is not provided, except as provided for under Special Facilities Routing as set forth in Section E11.

**E5.2.6 Minimum Period**

- A. Except as set forth in Section E2.4.2 B. and Section E5.2.6C. and Section E9.4.1, the minimum period for which charges are applicable for Access Service is one month.

ISSUED: May 31, 2013

EFFECTIVE: July 2, 2013

BY: Marshall M. Criser III, President -FL  
Miami, Florida

## E5. ORDERING OPTIONS FOR ACCESS SERVICES

### E5.2 Access Order (Cont'd)

#### E5.2.6 Minimum Period (Cont'd)

- B. The minimum service period for BellSouth Remote Access Service is twelve months. The minimum service period for BellSouth Metro Ethernet service is four months.<sup>1</sup>
- C. Service Rearrangements<sup>1</sup> and Transfer of Service as set forth in Section 6.7.1 of Tariff FCC No. 1 and Section E7.4.1 of this intrastate Tariff for BellSouth SWA and Dedicated Access Services respectively, may be made without a change in minimum period requirements. (C)
- D. Changes other than those identified in Section 6.7.1 of Tariff FCC No. 1 or Section E7.4.1<sup>1</sup> of this intrastate Tariff will be treated as a discontinuance of the existing service and an installation of a new service. All associated nonrecurring charges will apply for the new service. A new minimum period will be established for the new service. The IC or End User will also remain responsible for all outstanding minimum period obligations associated with the disconnected service. (C)

The following changes are those which will be treated as a discontinuance and installation of service and for which a new minimum period will be established.

- 1. A move to a different building as set forth in Section 6.7.7 of Tariff FCC No. 1 or Section E7.4.4 of this intrastate Tariff. (C)
- 2. A change in type of service (i.e., BellSouth SWA to Dedicated Access, one type of Dedicated Access to another, or one type of BellSouth SWA service to another except as set forth in Section 6.7.6 of Tariff FCC No. 1). (C)
- 3. A change in the type of Dedicated Access Service Local Channel or Switched Local Channel.
- 4. A change in the interface for BellSouth SWA service or BellSouth Directory Assistance service .
- 5. Change in BellSouth SWA service traffic type.
- 6. Change from two-point to multipoint Dedicated Access Service or from multipoint to two-point Dedicated Access Service.
- E. An IC or End User may request disconnect of an access service at any time after the service has been established. The IC or End User must give the Company at least one business day written or verbal notice prior to the desired disconnect date. The one business day notice period will begin on the date the Company first receives the disconnect notification, either written or verbal. The verbal notice must be followed by written confirmation within 10 days.
- F. When Access Service is disconnected prior to the expiration of the minimum period, the IC or End User is obligated for payment of the minimum period charge as set forth in E2.4.9 of this Tariff and E5.2.7 following. When Access Service is disconnected after the expiration of the minimum period, billing for the service will be performed in accordance with the provisions set forth in E2.4.1.C. of this Tariff.

#### E5.2.7 Minimum Period Charges

- A. When Access Service is discontinued prior to the expiration of the minimum period, charges are applicable for the balance of the minimum period. The disconnect date is the final date the IC or End User has use of the service.

The Minimum Period Monthly Charge, for services provided with a one month minimum period will be determined as follows:

- 1. For BellSouth SWA service, usage sensitive rate elements (i.e. Carrier Common Line, Local Switching, Access Tandem Switching, BellSouth SWA Common Transport, and Interconnection), the charge for a month or fraction thereof is equal to the applicable rates for the actual or assumed usage for the month or such fraction thereof.
- 2. For BellSouth SWA Transport components which are not usage sensitive (i.e., Switched Local Channel and Switched Dedicated Interoffice Channel and Channelization Equipment), the charge for a month or fraction thereof is the applicable monthly rates for the service as set forth in Section 6.8 of Tariff FCC No. 1. (C)

**Note 1:** Specific regulations for BellSouth Metro Ethernet service minimum period, service rearrangements (reconfigurations) and changes are provided in E7.4.32 of this Tariff.

## E5. ORDERING OPTIONS FOR ACCESS SERVICES (T)

### E5.2 Access Order (Cont'd)

#### E5.2.7 Minimum Period Charges (Cont'd)

- A. When Access Service is discontinued prior to the expiration of the minimum period, charges are applicable for the balance of the minimum period. The disconnect date is the final date the IC or End User has use of the service. (Cont'd)
  3. For Dedicated Access Service, the charge for a month or fraction thereof is the applicable monthly rate for the service as set forth in E7.5 following.
  4. For *BellSouth SWA* service Dedicated Access Lines, the charge for each remaining month and/or fraction thereof is the applicable monthly rate for the service as set forth in E6.7.3 following. (T)
  5. For EIS arrangements, the charge for a month or fraction thereof is the applicable monthly rate for the service as set forth in Section E20. following.
  6. The Minimum Period Charges for *BellSouth SWA FGD* or *BellSouth SWA* TSBSA 3 service are set forth in E2.4 preceding. (T)
- B. Extraordinary circumstances may exist under which minimum period charges may be waived with Florida Public Service Commission approval.
- C. All applicable nonrecurring charges for the service will be billed in addition to the Minimum Period Charge.
- D. Should billing for a service which is disconnected prior to the expiration of the Minimum Period cover multiple billing cycles, the bill reflecting the disconnect of service will be adjusted to account for that portion of the Minimum Period Charge previously billed to the IC. In no event shall the total recurring charge billed to the IC for such service exceed the applicable Minimum Period Charge.

All applicable nonrecurring charges associated with the provision of service will be billed in addition to the Minimum Period Charge. Such nonrecurring charges include the nonrecurring charge for the installation of service and/or optional features, Service Order Modification Charges, Additional Engineering and Labor Charges, if any, etc.

#### E5.2.8 Shared Use Facilities

Shared Use occurs when *BellSouth SWA* and Dedicated Access services are provided over the same high capacity facility through a common interface. The facility may be ordered either as digital high capacity *BellSouth SWA* or Dedicated Access. (T)

Billing will commence for the high capacity facility as soon as the facility is turned over to the IC for use (i.e., on the service date). Such billing will include charges for the Local Channel or Switched Local Channel, the Channelization Equipment (i.e., the multiplexer) and the interoffice transport mileage, if any. Nonrecurring installation charges will also apply at this time.

Such billing will continue until such time as the IC requests, by placing an order for service, that one or more of the derived channels be used in the provisioning of an end to end *BellSouth SWA* or Dedicated Access service. When the end to end service is turned over to the IC for use, the existing billing may be modified and billing for the end to end service will commence. (T)

## E5. ORDERING OPTIONS FOR ACCESS SERVICES

### E5.2 Access Order (Cont'd)

#### E5.2.8 Shared Use Facilities (Cont'd)

When the original facility is ordered as Dedicated Access, the billing change to the existing facility, if any, will depend on whether the end to end service provisioned over the derived channel(s) is Dedicated or BellSouth SWA. If Dedicated Access service, the billing for the facility will not change but additional billing will commence for the end to end service provisioned over the facility. This billing will include an additional local channel(s) and interoffice mileage, if applicable, of a lower capacity level (e.g., voice grade).

When the original facility is ordered as Dedicated Access and BellSouth SWA service is provisioned over a derived channel(s), the Dedicated Access billing for the original facility will be reduced in direct proportion to the number of channels being utilized for BellSouth SWA service. For example, if six channels of BellSouth SWA DS1 are to be used for BellSouth SWA, the Dedicated Access rate will be reduced by one fourth. The IC will be billed one fourth of the BellSouth SWA DS1 rate, plus all other applicable BellSouth SWA charges for the BellSouth SWA service provided.

When the original facility is ordered as BellSouth SWA, the billing charge to the existing facility, if any, will depend on whether the end to end service provisioned over the derived channel(s) is BellSouth SWA or Dedicated Access service. If BellSouth SWA service, the billing for the facility will not change but additional billing will commence for the end to end service provisioned over the facility. This billing will include local switching, line terminations, carrier common line and additional interoffice transport at a lower capacity, if applicable.

When the original facility is ordered as BellSouth SWA and Dedicated Access service is provisioned over a derived channel(s), the BellSouth SWA billing for the original facility will be reduced in direct proportion to the number of channels being utilized for Dedicated Access service. For example, if six channels of a BellSouth SWA DS1 are to be used for Dedicated Access, the BellSouth SWA rate will be reduced by one fourth. The IC will be billed three fourths of the BellSouth SWA DS1 rate, plus all other applicable BellSouth SWA charges. The IC will be billed one fourth of the Dedicated Access DS1 rate, plus all other applicable charges for the Dedicated Access service provided.

BellSouth Dedicated Ring is only available for Shared Use with SMARTRing<sup>®</sup> service (a.k.a. BellSouth Dedicated Ring) and vice versa. When these services are ordered for Shared Use arrangements, all ring level components must be ordered as either BellSouth SWA or Dedicated Access service.

(D)

### E5.3 Available Inventory

Available inventory is limited and does not include facilities previously ordered. The Company will make every reasonable effort to maintain sufficient available inventory to provide Access Service in accordance with the IC's or End User's requested service date intervals. To the extent that service can be provided, Access Orders will be satisfied from available inventory.

### E5.4 Shared Network Arrangement

#### E5.4.1 General

- A. Shared Network Arrangement (SNA) is a service offering whereby multiple interexchange carriers (ICs) may share capacity on high capacity channelized services. SNA service configurations will be limited to ICs utilizing BellSouth SWA DS3 service sharing capacity with other ICs utilizing sub-BellSouth SWA DS3 services and/or ICs utilizing BellSouth SWA DS1 service sharing capacity with other ICs utilizing sub-BellSouth SWA DS1 services. Each rate element, associated with the SNA, will be billed to a single subscriber and the Company will maintain separate records (including billing and network configuration) for each ICs' portion of the SNA.

<sup>®</sup> Registered Service Mark of BellSouth Corporation  
• Service Mark of BellSouth Corporation

## E5. ORDERING OPTIONS FOR ACCESS SERVICES

### E5.4 Shared Network Arrangement (Cont'd)

#### E5.4.1 General (Cont'd)

- B. The *BellSouth SWA* DS3 and *BellSouth SWA* DS1 Service ICs who are sharing capacity on their services with others are considered to be the host subscribers under these arrangements. The host subscriber is considered the IC for the higher level service and is solely responsible for payment of the rate elements for such level of service, from the subscribers terminal location through channelization. Each service user of the lower level service is responsible for payment of the charges associated with lower level service. Under the SNA, the Company may share with the host subscriber record information pertaining to the services of other users of the shared network. Such disclosure will be under the sole discretion of the Company as is necessary to perform billing reconciliations and/or other functions required in connection with maintaining account records.
- C. Each subscriber entering into the SNA is solely responsible to the Company for charges associated with that subscriber's portion of the shared network.
  - 1. For example, for *BellSouth SWA* Dedicated Transport Shared Network Arrangements, the host IC would be responsible for a *BellSouth SWA* DS3 Service Switched Local Channel and the DS3 to DS1 Channelization Equipment. The service user will be responsible for payment of the Switched Dedicated Interoffice Channel charges as well as any end office based *BellSouth SWA* charges associated with the service.
- D. Disconnection of the service by the host subscriber does not relieve another user of the shared network of any obligation to pay access charges associated with the portion of the shared network to which that user subscribes. Billing for services and facilities will continue until a disconnect request from the service user has been received by the Company. The host subscriber is solely responsible for notifying the connecting service user in the event of disconnection of the host's service which affects that portion of the shared network service to which the user has subscribed.
- E. SNAs can be utilized on any of the following rate elements which comprise a service arrangement within a shared network:
  - Switched Local Channels
  - Switched Access Channelization Elements
  - Switched Access Dedicated Interoffice Channels
- F. A one-time coordination charge will be assessed with the establishment of a Shared Network Arrangement. The host subscriber and the service user may, by mutual agreement, designate which party will be responsible for payment of the coordination charge. In the event no such agreement is reached, the charge will be applied to the host subscriber's account and the host subscriber will be responsible for payment of said charge.
- G. Shared Network Arrangement coordination charges for *BellSouth SWA* services are shown in Section 6.8.7 of Tariff FCC No. (C)
  - 1. Additionally, a separate nonrecurring charge will apply to process each service order on a shared network account. (C)

### E5.5 Reserved for Future Use

ISSUED: December 19, 2013

EFFECTIVE: December 20, 2013

BY: Marshall M. Criser III, President -FL  
Miami, Florida

## E6. BELLSOUTH SWA SERVICE

### CONTENTS

<b>E6.1</b>	<b>General</b>	1	(D)
<b>E6.2</b>	<b>Provision and Description of BellSouth SWA Service Arrangements</b>	1	(D)
<b>E6.4</b>	<b>Transmission Specifications</b>	3	(M)(C)
<b>E6.7</b>	<b>Rate Regulations</b>	5	(M)(C)
<b>E6.8</b>	<b>Rates and Charges</b>	7	(M)(C)

Material appearing on this page previously appeared on Revised Pages 2, 3 and 4.



BELLSOUTH  
TELECOMMUNICATIONS  
FLORIDA

ACCESS SERVICES TARIFF

Third Revised Page 2  
Cancels Second Revised Page 2

ISSUED: December 19, 2013  
BY: Marshall M. Criser III, President -FL  
Miami, Florida

EFFECTIVE: December 20, 2013

(D)

(D)

Material previously appeared on this page now appears on Ninth revised Page 1.

BELLSOUTH  
TELECOMMUNICATIONS  
FLORIDA

ACCESS SERVICES TARIFF

Fifth Revised Page 3  
Cancels Fourth Revised Page 3

ISSUED: December 19, 2013

EFFECTIVE: December 20, 2013

BY: Marshall M. Criser III, President -FL  
Miami, Florida

(D)

(D)

Material previously appeared on this page now appears on Ninth revised Page 1.

BELLSOUTH  
TELECOMMUNICATIONS  
FLORIDA

ACCESS SERVICES TARIFF

Eighth Revised Page 4  
Cancels Seventh Revised Page 4

ISSUED: December 19, 2013  
BY: Marshall M. Criser III, President -FL  
Miami, Florida

EFFECTIVE: December 20, 2013

(D)

(D)

Material previously appeared on this page now appears on Ninth revised Page 1.

## E6. BELLSOUTH SWA SERVICE

This section concurs in BellSouth Telecommunications, LLC's (BST's) Tariff FCC No. 1, Section 6, which can be accessed via the following hypertext link:

<http://cpr.att.com/pdf/fcc/1006.pdf>

Exceptions to this concurrence of BellSouth Telecommunications, LLC's (BST's) Tariff FCC No. 1, Section 6, are as listed below. The following cited exceptions relate to that specific section in the interstate Tariff FCC No. 1.

### E6.1 General

#### E6.1.3 Rate Categories

The information surcharge is not applicable to the intrastate jurisdiction.

#### E6.1.3 (A) BellSouth SWA Transport

##### E6.1.3 (A) (6) Interface Group Arrangements

##### E6.1.3 (A) (6) (c) Interface Group 3

Interface Group 3 is not applicable to the intrastate jurisdiction.

##### E6.1.3 (A) (6) (i) CCS7 Signaling Connection Premises Interface Codes

ATM circuit emulation connecting to FGD trunks is not applicable to the intrastate jurisdiction.

#### E6.1.3 (A) (7) Optional Features

E6.1.3 (A) (7) (k) SWA BellSouth Customer Network Management Service Optional Feature is not applicable to the intrastate jurisdiction.

#### E6.1.3 (A) (10) BellSouth Dedicated Ring

E6.1.3 (A) (10) (j) Surveillance (per Node, per BellSouth Dedicated Ring) is not applicable to the intrastate jurisdiction.

#### E 6.1.3(F) BellSouth Local Number Portability Database Services

Local Number Portability Database Services do not apply to the intrastate jurisdiction.

#### E6.1.9 BellSouth Cross Connect Service

Intra-Office Collocation Cross Connect Service is not applicable to the intrastate jurisdiction.

## E 6.2 Provisions and Description of BellSouth SWA Service Arrangements

E6.2.2 (A)(3) In addition to the language in Tariff FCC No. 1, the following also applies to the intrastate jurisdiction. BellSouth SWA FGB switching provided with Automatic Number Identification (ANI) arrangements, provisioned to an End User(s) where facilities permit, must be for the End User(s) own use and cannot be resold, pursuant to Florida Public Service Commission Docket No. 900823-TL Order No. PSC-92-1081-FOF-TL, issued September 30, 1992.

#### E6.2.4 BellSouth SWA FGD

##### E6.2.4 (A) Description

##### E6.2.4 (A) (11)

BellSouth SWA FGD is provided with BellSouth Directory Assistance Access service via designated Telephone company electronic access tandem switches appropriately equipped for DA measurement. Completion of these calls is as set forth in (4) preceding. When BellSouth Directory Assistance Access service is provided with BellSouth SWA FGD switching, calls routed to the access tandem will be completed to the DA location. Calls completed to the DA location are subject to the charges set forth in 9.1.6 of this intrastate tariff.

E6.2.4 (A) (12) Government Emergency Telecommunications Service does not apply to the intrastate jurisdiction.

ISSUED: May 31, 2013

EFFECTIVE: July 2, 2013

BY: Marshall M. Criser III, President -FL  
Miami, Florida

## E6. BELLSOUTH SWA SERVICE

### E 6.2 Provisions and Description of BellSouth SWA Service Arrangements (Cont'd)

#### E6.2.4 (A) (13)

A BellSouth SWA WATS Service line may, at the option of the IC be provided for use with BellSouth SWA FGD service. A BellSouth SWA WATS Service line provides a connection between a IC's end user's premises and a Company end office switch capable of performing the necessary screening functions for 800 BellSouth SWA 8XX Toll Free Dialing Ten Digit Screening Service, BellSouth SWA WATS Service or similar services and is provided only for use at the closed end of such services.

BellSouth SWA WATS Service lines are arranged for either originating calling only or terminating calling only. They are provided with rotary dial or dual tone multifrequency address signaling and either loop start or ground start supervisory signaling. The choice of the type of signaling is at the option of the IC.

BellSouth SWA WATS Service lines are provided as either an effective two-wire or effective four-wire transmission path. Each transmission path is provided with Standard Transmission Specifications and Data Transmission Parameters as set forth in E6.4.1.D and E6.4.2.C following. At the option of the IC, the WATS Access Line BellSouth SWA WATS Service may be ordered with the Improved Two-Wire Voice Transmission Specifications (guaranteed specifications are set forth in E6.4.3 following).

#### E6.2.4 (B) Optional Features

##### E6.2.4 (B) (1) Common Switching Optional Features

**E6.2.4 (B) (1) (f)** International Carrier Option does not apply to the intrastate jurisdiction.

**E6.2.4 (B) (1) (m)** Carrier Identification Parameter (CIP) does not apply to the intrastate jurisdiction.

##### E6.2.5 BellSouth SWA Toll Free Dialing Ten Digit Screening Service

In addition to the language in Tariff FCC No. I, the following also applies to the intrastate jurisdiction, BellSouth SWA 8XX Toll Free Dialing Ten Digit Screening Service provides for routing 800 originating calls based on the dialed ten digit 800 number except for 800 calls to Canada, Bermuda and the Bahamas. Routing for 800 calls to these areas will be based on the first six digits of the dialed 800 number. Terms, conditions and rates applicable to BellSouth SWA 8XX Toll Free Dialing Ten Digit Screening Service also apply to these calls.

#### E6.2.8 BellSouth SWA TSBSA

##### E6.2.8.3 BellSouth SWA TSBSA 3

**E6.2.8.3 (A) (12)** The following also applies to Florida intrastate.

A WATS Access Line (a.k.a. BellSouth SPA WATS Line) may, at the option of the IC, be provided for use with BellSouth SWA TSBSA 3 service. A WATS Access Line (a.k.a. BellSouth SPA WATS Line) provides a connection between a IC's end user's premises and a Company end office switch capable of performing the necessary screening functions for BellSouth SWA 8XX Toll Free Dialing Ten Digit Screening service, WATS (a.k.a. BellSouth SPA WATS Line) or similar services and is provided only for use at the closed end of such services.

WATS Access Lines (a.k.a. BellSouth SAP WATS Line) are arranged for either originating calling only or terminating calling only. They are provided with rotary dial or dual tone multifrequency address signaling and either loop start or ground start supervisory signaling. The choice of the type of signaling is at the option of the IC.

WATS Access Lines (a.k.a. BellSouth SPA WATS Lines) are provided as either an effective two-wire or effective four-wire transmission path. Each transmission path is provided with Standard Transmission Specifications and Data Transmission Parameters as set forth in E6.4.1.D and E6.4.2.C following. At the option of the IC, the WATS Access Line (a.k.a. BellSouth SPA WATS Lines) may be ordered with the Improved Two-Wire Voice Transmission Specifications (guaranteed specifications are set forth in E6.4.3 following).

ISSUED: May 31, 2013

EFFECTIVE: July 2, 2013

BY: Marshall M. Criser III, President -FL  
Miami, Florida

## E6. BELLSOUTH SWA SERVICE

### E6.2 Provisions and Description of BellSouth SWA Service Arrangements (Cont'd)

#### E6.2.8.3 (B) Optional Features

##### E6.2.8.3 (B) (1) Common Switching Optional Features

E6.2.8.3 (B) (1) (e) International Carrier Option does not apply to the intrastate jurisdiction.

E6.2.8.3 (B) (1) (I) Carrier Identification Parameter (CIP) does not apply to the intrastate jurisdiction.

E6.2.8.3 (B) (3) Common Switching BSEs for use with WATS Access Lines (a.k.a. BellSouth SPA WATS Lines) are not applicable to the intrastate jurisdiction.

#### E6.2.11 BellSouth Local Number Portability Database Services

Local Number Portability Database Services do not apply to the intrastate jurisdiction.

#### E6.2.15 BellSouth Wavelength SWA Dedicated Ring Service Components

Wavelength SWA Dedicated Ring Service Components are not applicable to the intrastate jurisdiction.

#### E6.2.17 BellSouth Wavelength SWA Channel Service Components

Wavelength SWA Dedicated Ring Service Components are not applicable to the intrastate jurisdiction.

## E6.4 Transmission Specifications

### E6.4.1 Standard Transmission Specifications

#### E6.4.1 (D) WATS Access Line (a.k.a. BellSouth SPA WATS Lines) Standard Transmission Specifications

##### D. WATS Access Line (a.k.a. BellSouth SPA WATS Lines) Standard Transmission Specifications

##### 1. Standard Two-Wire Voice Transmission Specifications

##### a. Loss Deviation

The maximum Loss Deviation of the 1004 Hz loss relative to the Expected Measured Loss (EML) is + 4.0 dB.

##### b. Attenuation Distortion

The maximum Attenuation Distortion in the 404 to 2804 Hz frequency band relative to the loss at 1004 Hz is -3.0 dB to +9.0 dB.

### E6.4.1 Standard Transmission Specifications (Cont'd)

#### E6.4.1 (D) WATS Access Line (a.k.a. BellSouth SPA WATS Lines) Standard Transmission Specifications

##### 1. Standard Two-Wire Voice Transmission Specifications (Cont'd)

##### c. C-Message Noise

The maximum C-Message Noise for the transmission path at the route miles listed is less than:

Route Miles	C-Message Noise
less than 50	35 dBmCO
51 to 100	37 dBmCO
101 to 200	40 dBmCO
201 to 400	43 dBmCO
401 to 1000	45 dBmCO

##### d. Echo Control

Return Loss for both Echo Return Loss (ERL) and Singing Return Loss (SRL), is equal to or greater than:

ERL	6.0 dB
SRL	3.0 dB

ISSUED: May 31, 2013

EFFECTIVE: July 2, 2013

BY: Marshall M. Criser III, President -FL  
Miami, Florida

## E6. BELLSOUTH SWA SERVICE

### E6.4 Transmission Specifications (Cont'd)

#### E6.4.1 Standard Transmission Specifications (Cont'd)

#### E6.4.1 (D) WATS Access Line (a.k.a. BellSouth SPA WATS Lines) Standard Transmission Specifications (Cont'd)

2. Standard Four-Wide Voice Transmission Specifications

a. Loss Deviation

The maximum Loss Deviation of the 1004 Hz loss relative to the Expected Measured Loss (EML) is -3.0 dB to +3.0 dB.

b. Attenuation Distortion

The maximum Attenuation Distortion in the 404 to 2804 Hz frequency band relative to loss at 1004 Hz is -1.0 dB to +4.5 dB.

c. C-Message Noise

The Maximum C-Message Noise for the transmission path at the route miles listed is less than:

Route Miles	C-Message Noise
less than 50	35 dBmCO
51 to 100	37 dBmCO
101 to 200	40 dBmCO
201 to 400	43 dBmCO
401 to 1000	45 dBmCO

d. Echo Control

The Equal Level Echo Path Loss for both Echo Return Loss (ERL) and Singing Return Loss (SRL), is equal to or greater than:

ERL	15.0 dB
SRL	9.0 dB

#### E6.4.2 Data Transmission Parameters

C. WATS Access Line (a.k.a. BellSouth SPA WATS Lines) Data Transmission Parameters

1. Signal to C-Notched Noise Ratio

The maximum Signal-to-C-Notched Noise Ratio is 30 dB.

2. Envelope Delay Distortion

The maximum Envelope Delay Distortion for the frequency bands specified is:

1000 microseconds	604 to 2804 Hz
500 microseconds	1000 to 2404 Hz

3. Impulse Noise Counts

The Impulse Noise Counts exceeding a 67 dBmCO threshold in 15 minutes is no more than 15 counts.

4. Intermodulation Distortion

The Second Order (R2) and Third Order (R3) Intermodulation Distortion products are equal to or greater than:

Second Order (R2)	31 dB
Third Order (R3)	34 dB

5. Phase Jitter

The Phase Jitter over the 4 to 300 Hz frequency band is less than or equal to 7 peak-to-peak.

6. Frequency Shift

The maximum Frequency Shift does not exceed -2 to +2 Hz.

ISSUED: May 31, 2013

EFFECTIVE: July 2, 2013

BY: Marshall M. Criser III, President -FL  
Miami, Florida

## E6. BELLSOUTH SWA SERVICE

### E6.4 Transmission Specifications (Cont'd)

#### E6.4.3 WATS Access Line (a.k.a. BellSouth SPA WATS Line)

##### A. Improved Two-Wire Voice Transmission Specifications

###### 1. Loss Deviation

The maximum Loss Deviation of the 1004 Hz loss relative to the Expected Measured Loss (EML) is -4.0 dB to +4.0 dB.

###### 2. Attenuation Distortion

The maximum C-Message Noise for the transmission path at the route miles listed is less than:

###### 3. C-Message Noise

The maximum C-Message Noise for the transmission path at the route miles listed is less than:

Route Miles	C-Message Noise
less than 50	35 dBrnCO
51 to 100	37 dBrnCO
101 to 200	40 dBrnCO
201 to 400	43 dBrnCO
401 to 1000	45 dBrnCO

###### 4. Return Loss

The Return Loss, expressed as Echo Return Loss (ERL) and Singing Return Loss (SRL), is equal to or greater than:

ERL	13.0 dB
SRL	6.0 dB

### E 6.7 Rate Regulations

Area Commitment Plan (ACP) is not applicable to the intrastate jurisdiction.

#### E6.7.1 (B) (4) BellSouth Local Number Portability Database Services

Local Number Portability Database Services do not apply to the intrastate jurisdiction.

#### E6.7.1(C) Nonrecurring Charges

##### E6.7.1(C) (3) Service Rearrangements

E6.7.1(C) (3) (b) (xi) Flex ANI is not applicable to the intrastate jurisdiction.

#### E6.7.1 (D) Application of Rates

Transitional rates are not applicable to the intrastate jurisdiction.

#### E6.7.3 BellSouth SWA Service for Resale of Other IC Service

When the IC plans to use line side BellSouth SWA service to collect the traffic of its customers in association with the resale of an IC service that is provided through the use of originating only WATS Access Line (a.k.a. BellSouth SPA WATS Line) service provided under this Tariff (i.e., resale of WATS (a.k.a. BellSouth SPA WATS Line) service), the following regulations, rates and charges shall apply.

##### A. The IC shall notify the Company in writing that line side WATS Access Line (a.k.a. BellSouth SPA WATS Line) service is to be used in association with the resale of WATS Access Line (a.k.a. BellSouth SPA WATS Line) service. With its notification, the IC shall furnish the following data:

1. The number of WATS Access Line (a.k.a. BellSouth SPA WATS Line) services in the LATA that it is reselling in association with the line side BellSouth SWA service, and
2. The IC terminal location (i.e., closed end user location) where the WATS Access Line (a.k.a. BellSouth SPA WATS Line) services are terminated, and



ISSUED: December 19, 2013

EFFECTIVE: December 20, 2013

BY: Marshall M. Criser III, President -FL  
Miami, Florida

## E6. BELLSOUTH SWA SERVICE

### E 6.7 Rate Regulations (Cont'd)

#### E6.7.3 BellSouth SWA Service for Resale of Other IC Service (Con'td)

3. When both line side (i.e., *BellSouth SWA* FGA and *BellSouth SWA* LSBSA) and trunk side (i.e., *BellSouth SWA* FGB, *BellSouth SWA* FGD and *BellSouth SWA* TSBSA) *BellSouth SWA* service are used in association with the resale of WATS Access Line (a.k.a. *BellSouth SPA WATS Line*) service, the number of WATS Access Line (a.k.a. *BellSouth SPA WATS Line*) services to be associated with each line side or trunk side *BellSouth SWA* service. If this split is not reported, the Company will assume all the WATS Access Line (a.k.a. *BellSouth SPA WATS Line*) services are to be associated with line side *BellSouth SWA* service. (D)

The preceding information and the information required in B. following must be reported for each LATA in which the IC is reselling services. For those LATAs that are multistate LATAs, the IC must report the information by state within the LATA. In order for the rate treatment in D. following to apply, both this *BellSouth SWA* service and the associated WATS Access Line (a.k.a. *BellSouth SPA WATS Line*) services must be in the same state and be provided by the same Company.

- B. Each of the *BellSouth SWA* services used by the IC in association with the resale of WATS Access Line (a.k.a. *BellSouth SPA WATS Line*) service must be in the same LATA as the WATS Access Line (a.k.a. *BellSouth SPA WATS Line*) services in order for such *BellSouth SWA* service to be rated as set forth in D. following. The *BellSouth SWA* service must also be connected either directly or indirectly to the IC terminal location at which the associated WATS Access Line (a.k.a. *BellSouth SPA WATS Line*) services are terminated. Direct connections are those where the *BellSouth SWA* service is terminated at the same IC terminal location. Indirect connections are those where the *BellSouth SWA* service is terminated at a second IC terminal location in the same LATA, which is in turn connected to the first IC terminal location by facilities that can be used by the *BellSouth SWA* service to reach the first IC terminal location (i.e., the IC terminal location where the WATS Access Line (a.k.a. *BellSouth SPA WATS Line*) services are terminated). When more than one IC terminal location is involved in a LATA, the IC shall notify the Company in writing and shall report the locations of the involved IC terminal locations.
- C. For the initial month, the data that the IC reports as set forth in A. and B. preceding will be used by the Company to determine the rates and charges as set forth in D. following. For each subsequent month, the IC must update the report per A. and B. preceding for each LATA for the preceding monthly period. The report shall be delivered to the Company, at a location specified by the Company, no later than 15 days after the bill date shown on the WATS Access Line (a.k.a. *BellSouth SPA WATS Line*) services bill. If an updated report is required but is not received by the Company during the monthly period after the initial monthly period, the Company will assume there are no resold WATS Access Line (a.k.a. *BellSouth SPA WATS Line*) services associated with *BellSouth SWA* services in the LATA. The rate treatment set forth in D. following will not apply in these cases.
- D. When the IC reports *BellSouth SWA* services associated with the resale of WATS Access Line (a.k.a. *BellSouth SPA WATS Line*) services in a LATA as set forth in A., B. and C. preceding, and the Company verifies the reports are accurate, such *BellSouth SWA* services will be rated as follows:
  1. For line side *BellSouth SWA* services (i.e., *BellSouth SWA* FGA and *BellSouth SWA* LSBSA) in a LATA associated with the resale of WATS Access Line (a.k.a. *BellSouth SPA WATS Line*) services, the LATA access minutes used to determine the charges for *BellSouth SWA* Transport, Local Switching (LS1 and LS3) and Line Termination will be reduced by the total number of minutes each WATS Access Line (a.k.a. *BellSouth SPA WATS Line*) service reported by the IC as set forth in A., B. or C. preceding. However, the access minutes for the line side *BellSouth SWA* services in the LATA, adjusted as set forth in this or any other section of this Tariff, that are billed to an IC in a monthly period shall not be less than zero. The adjustment will be made to the involved IC account no later than either the next bill date, or the one subsequent to that, depending on when the report is received.
- E. When the IC notifies the Company that *BellSouth SWA* services is to be used in association with the resale of WATS Access Line (a.k.a. *BellSouth SPA WATS Line*) service, the notification automatically grants the Company the right to audit (1) the IC terminal locations to verify the use of facilities as reported in A., B. or C. preceding, and (2) all of the records, work papers and back up documentation for each report as set forth in A., B. or C. preceding. The Company also has the right to contact and review the records of other involved entities to verify the data the IC reports is accurate.

All of the records, work paper and backup documentation for each report furnished the Company as set forth in A., B. or C. preceding shall be available (for one year from the date of the report) during normal business hours at an IC location in the involved LATA, upon reasonable request by the Company, in order to permit a review by the Company auditor or outside auditor under contract to the Company. If the records, work papers and backup documentation are not provided or are insufficient or not in accordance with the provision of this paragraph and A., B. and C. preceding, the adjustments and rates as set forth in D. preceding shall not apply until the deficiencies are corrected and new reports as required in A., B. and C. preceding are delivered to the Company.
- F. When the IC reports line side *BellSouth SWA* services associated with the resale of WATS Access Line (a.k.a. *BellSouth SPA WATS Line*) service in a LATA, as set forth in A., B. or C. preceding, the regulations set forth in E3.7.D preceding shall apply.

**E6. BELLSOUTH SWA SERVICE**

**E 6.7 Rate Regulations (Cont'd)**

**E6.7.8 Measuring Access Minutes**

The Florida Assumed Average Intrastate Access Minutes are:

Two-Way		Originating	Terminating
<u>Originating</u>	<u>Terminating</u>	<u>Only</u>	<u>Only</u>
1629	1451	3080	3080

**E6.7.11 Message Unit Credit**

No Message Unit Credit is given on the access minutes that have been prorated as set forth in E6.7.3 of this intrastate tariff.

Message Unit Credit – Per Originating Feature Group A Access Minute \$0.0016

**E6.7.15 Information Surcharge**

The Information Surcharge is not applicable to the intrastate jurisdiction.

**E6.7.23 BellSouth Wavelength SWA Channel Service Components**

Wavelength SWA Channel Service Components are not applicable to the intrastate jurisdiction.

Transitional rates are not applicable to the intrastate jurisdiction.

**E6.8 Rates and Charges**

**E6.8.1 BellSouth SWA Transport**

**E6.8.1 (A)** BellSouth SWA Local Channel – Plan A and Plan B rates are not applicable to the intrastate jurisdiction.

<b>E6.8.1 (A) (e)</b> End office Base Private Network			NRC	MRC
Per Local Channel	USOC	TEFHK	\$ 18.43	\$ 4.75

**E6.8.1 (B)** BellSouth SWA Interoffice Channel – Plan A and Plan B rates are not applicable to the intrastate jurisdiction.

(D)

(D)

**E6. BELLSOUTH SWA SERVICE**

**E6.8 Rates and Charges (Cont'd)**

<b>E6.8.1(C)(2)a</b>	Dedicated Tandem Trunk Port per month per port	<u>Originating</u>	(D)
	USOC	3P03X	
	- per dedicated DS0/VG trunk port required	\$ 9.47	
	USOC	3P04X	
	- per dedicated DS1 trunk port required	\$ 139.98	(D)

**E6.8.1 (G) Optional Features**

**E6.8.1 (G) (6) Channelization**

**E6.8.1 (G) (6) (a) DS3 Channelization** – Plan A and Plan B rates are not applicable to the intrastate jurisdiction.

**E6.8.1 (H) Dedicated Network Access Lines (DNALs)**

**E6.8.1 (H) (1) DNAL Switched Local Channel**

<b>E6.8.1(H)(1)(a)</b>	Dedicated Network Access Lines (DNALs)	<u>MRC</u>
	DNAL Switched Local Channel	
	(a) Per DNAL Switched Local Channel for use with the BSEs	
	- Two wire USOC T6E2X	\$ 30.91
	- Four wire USOC T6E4X	\$ 49.81

**E6.8.1 (H) (1) (c) Per DNAL Switched Local Channel for use with SMDI and ISMDI 9.6 Kbps Digital Service does not apply to the intrastate jurisdiction.**

**E6.8.1(H)(2)(a)** Switched Interoffice Channel for use with the BSEs - SMDI, BCLID, Make Busy/Night Transfer and Queuing (Call Waiting Subelement Only)

<u>Mileage Band</u>	<u>USOC</u>	<u>Fixed</u>	<u>Per Mile</u>
Over 0 to 4	1L5XX	\$ 4.96	\$ 3.09
Over 4 to 8	1L5XX	\$ 6.67	\$ 3.09
Over 8 to 25	1L5XX	\$ 8.35	\$ 3.09
Over 25 to 50	1L5XX	\$ 10.05	\$ 3.09
Over 50	1L5XX	\$ 11.73	\$ 3.09

**E6.8.1 (H) (2) (c) Switched Interoffice Channel for use with SMDI and ISMDI 9.6 Kbps Digital Service does not apply to the intrastate jurisdiction.**

**E6.8.1 (I) BellSouth CCS7 Signaling Connections, CCS7 Signaling Terminations and CCS7 Access Arrangement Usage**

**E6.8.1 (I) (3) CCS7 Signaling Usage** is not applicable to the intrastate jurisdiction.

ISSUED: May 31, 2013  
BY: Marshall M. Criser III, President -FL  
Miami, Florida

EFFECTIVE: July 2, 2013

**E6. BELLSOUTH SWA SERVICE**

**E6.8 Rates and Charges (Cont't)**

**E6.8.1.1 Vintage Rates**

**E6.8.1.1 (A) General Regulations**

Term Pricing plan vintage rates are those rates that apply to existing services provided under a term pricing plan in the event that the Telephone Company initiates a rate increase. Vintage rates, as set forth following, are classified as vintage because the Telephone Company ensures that rates provided under the term pricing plan will not be increased by the Telephone Company above the term pricing plan rate in effect at the beginning of the Customers term pricing plan term.

**E6.8.1.1 (B)** The following rates apply to Switched Transport Services installed before July 2, 2013.

BellSouth Dedicated Ring - Self-healing Multi-nodal Alternate Route Topology Ring

RATE ELEMENT	USOC	Rates
SMARTRing IOC OC-192+ 12-36 Mo	1HS1C	\$450.00
SMARTRing IOC OC-192+ 37-60 Mo	1HS1C	\$400.00
SMARTRing IOC OC-192+ 61-96 Mo	1HS1C	\$380.00

BellSouth SWA Managed Shared Network Service

RATE ELEMENT	ZONE	USOC	Rates
MSNS DS1 IOC - 0-8 Miles 60 Mo	1	1L5MS	\$110.00
MSNS DS1 IOC - 0-8 Miles 60 Mo	2	1L5MS	\$130.00
MSNS DS1 IOC - 0-8 Miles 60 Mo	3	1L5MS	\$180.00
MSNS DS1 IOC - 9-25 Miles 60 Mo	1	1L5MS	\$200.00
MSNS DS1 IOC - 9-25 Miles 60 Mo	2	1L5MS	\$240.00
MSNS DS1 IOC - 9-25 Miles 60 Mo	3	1L5MS	\$300.00
MSNS DS1 IOC - 25+ Miles 60 Mo	1	1L5MS	\$115.00
MSNS DS1 IOC - 25+ Miles 60 Mo	2	1L5MS	\$126.50
MSNS DS1 IOC - 25+ Miles 60 Mo	3	1L5MS	\$138.00
MSNS DS1 IOM - 25+ Miles 60 Mo	1	1L5MS	\$5.70
MSNS DS1 IOM - 25+ Miles 60 Mo	2	1L5MS	\$6.60
MSNS DS0 IOC - 0-8 Miles 60 Mo		1L5MS	\$22.00
MSNS DS0 IOC - 9-25 Miles 60 Mo		1L5MS	\$38.00
MSNS DS0 IOC - 25+ Miles 60 Mo		1L5MS	\$20.00
MSNS DS0 IOM - 25+ Miles 60 Mo		1L5MS	\$1.40
MSNS DS1/DS0 Interface - Per Interface 60 Mo	1	OHS1S	\$35.00
MSNS DS1/DS0 Interface - Per Interface 60 Mo	2	OHS1S	\$39.00
MSNS DS1/DS0 Interface - Per Interface 60 Mo	3	OHS1S	\$52.00
MSNS DS1 Message Trunk Interface 60 Mo	1	OHS1M	\$100.00
MSNS DS1 Message Trunk Interface 60 Mo	2	OHS1M	\$120.00
MSNS DS1 Message Trunk Interface 60 Mo	3	OHS1M	\$140.00
MSNS DS0 - per line side connection 60 Mo		OHSOL	\$19.00
MSNS DS0 - per trunk side connection 60 Mo		OHSOT	\$19.00
MSNS - LC (5 DS3) 60 Mo	1	OHS3L	\$3,685.00

**E6. BELLSOUTH SWA SERVICE**

**E6.8 Rates and Charges (Cont'd)**

**E6.8.1.1 Vintage Rates**

**E6.8.1.1 (B)**

BellSouth SWA Managed Shared Network Service

BellSouth SWA Managed Shared Network Service

RATE ELEMENT	ZONE	USOC	Rates
MSNS - LC (6 DS3) 60 Mo	1	OHS3L	\$3,785.00
MSNS - LC (7 DS3) 60 Mo	1	OHS3L	\$3,885.00
MSNS - LC (8 DS3) 60 Mo	1	OHS3L	\$3,985.00
MSNS - LC (9 DS3) 60 Mo	1	OHS3L	\$4,085.00
MSNS - LC (10 DS3) 60 Mo	1	OHS3L	\$4,185.00
MSNS - LC (11 DS3) 60 Mo	1	OHS3L	4285.00
MSNS - LC (12 DS3) 60 Mo	1	OHS3L	4728.00
MSNS - LC (13 DS3) 60 Mo	1	OHS3L	5149.00
MSNS - LC (14 DS3) 60 Mo	1	OHS3L	5549.00
MSNS - LC (15 DS3) 60 Mo	1	OHS3L	5927.00
MSNS - LC (16 DS3) 60 Mo	1	OHS3L	6286.00
MSNS - LC (17 DS3) 60 Mo	1	OHS3L	6625.00
MSNS - LC (18 DS3) 60 Mo	1	OHS3L	6945.00
MSNS - LC (19 DS3) 60 Mo	1	OHS3L	7247.00
MSNS - LC (20 DS3) 60 Mo	1	OHS3L	7697.00
MSNS - LC (21 DS3) 60 Mo	1	OHS3L	8147.00
MSNS - LC (22 DS3) 60 Mo	1	OHS3L	8597.00
MSNS - LC (23 DS3) 60 Mo	1	OHS3L	9047.00
MSNS - LC (24 DS3) 60 Mo	1	OHS3L	9497.00
MSNS - LC (25 DS3) 60 Mo	1	OHS3L	9947.00
MSNS - LC (26 DS3) 60 Mo	1	OHS3L	10397.00
MSNS - LC (27 DS3) 60 Mo	1	OHS3L	10847.00
MSNS - LC (28 DS3) 60 Mo	1	OHS3L	11297.00
MSNS - LC (29 DS3) 60 Mo	1	OHS3L	11747.00
MSNS - LC (30 DS3) 60 Mo	1	OHS3L	12197.00

(N)  
 (M)

Material previously appear on this page now appears on Original Page 10.1 of this section.

**E6. BELLSOUTH SWA SERVICE**

**E6.8 Rates and Charges (Cont'd)**

**E6.8.2 Local Switching**

(D)  
 \_\_\_\_\_  
 (D)

<b>E6.8.2(B)</b>	Dedicated End Off Trunk Port Service		<u>Originating</u>
		USOC	3P02X
	Per dedicated DS1 trunk port required		\$ 139.98

**E6.8.2 (D) Common Switching (BellSouth SWA FG and BellSouth SWA Basic Serving Arrangement Customers)**

International Carrier Option FID INCO does not apply to the intrastate jurisdiction.

Carrier Identification Parameter (CIP) USOC NR4CD does not apply to the intrastate jurisdiction.

Cut-Through FID CTO does not apply to the intrastate jurisdiction.

**E6.8.2 (E) Basic Service Elements (BellSouth SWA Basic Serving Arrangement Customers Only)**

SMDI USOCs AVAS2, AVAS4, AVAS9 and AVAS6 are not applicable to the intrastate jurisdiction.

ISMDI USOCs AVBS1, AVBS2, AVBS4, AVBS9, AVBS6 and AVBSM are not applicable to the intrastate jurisdiction.

**E6.8.2 (J) BellSouth SWA 900 service NXX Activation Charge**

<b>E6.8.2(J)</b>	BellSouth SWA 900 service NXX Activation Charge		<u>First NRC</u>	<u>Add'l NRC</u>
	- Per each Telephone Company End Office Switching and Access Tandem in which translations required	USOC	<u>N9G1X</u>	<u>N9GAX</u>
			\$ 43.61	\$ 21.51

Material appearing on this page previously appeared on 3rd Revised Page 10 of this section

## E6. BELLSOUTH SWA SERVICE

### E6.8 Rates and Charges (Cont'd)

#### E6.8.4 Information Surcharge

The Information Surcharge is not applicable to the intrastate jurisdiction

#### E6.8.5 Inside Moves

USOCs NRBM1, NRBM2 and NRBM3 are not applicable to the intrastate jurisdiction.

#### E6.8.6 Changes of Network Channel Interface Codes

USOC RDG is not applicable to the intrastate jurisdiction.

#### E6.8.9 Transfer of Service

**E6.8.9 (B) Per Circuit** USOC NRBPC is not applicable to the intrastate jurisdiction.

E6.8.11 BellSouth SWA Toll Free Dialing Ten Digit Screening Service

(D)

(D)

**E6.8.12 BellSouth Local Number Portability Database Services** are not applicable to the intrastate jurisdiction.

#### E6.8.15 WATS Access Line (a.k.a. BellSouth SPA WATS Line) Service

A. Monthly Rate

1. Access Lines

	Monthly Rate	USOC
(a) 2-wire Out WATS (a.k.a. BellSouth SPA WATS Line) and BellSouth SWA 8XX Toll Free Dialing Ten Digit Screening Service <sup>1,2</sup>	\$38.00	X2W
(b) 2-wire DID or DID/DOD Access Service with BellSouth SWA Basic Serving Arrangement for use with WATS Access Lines (a.k.a. BellSouth SPA WATS Line). <sup>3</sup>	38.00	X2L

ISSUED: May 31, 2013

EFFECTIVE: July 2, 2013

BY: Marshall M. Criser III, President -FL  
Miami, Florida

### E6. BELLSOUTH SWA SERVICE

All Material has been deleted from the page listed below. These pages do not contain any information on Services or Products.

#### (DELETE)

Page	Revision	Cancels Revision
17	3	2
18	3	2
19	3	2
20	7	6
21	6	5
22	4	3
23	3	2
24	8	7
24.1	2	1
24.2	2	1
24.3	2	1
24.4	2	1
24.5	2	1
24.6	2	1
24.7	2	1
24.8	2	1
25	6	5
26	7	6
26.1	5	4
27	5	4
28	2	1
29	2	1
30	2	1
31	4	3
32	2	1
33	3	2
34	2	1
35	3	2
36	4	3
37	4	3
38	5	4
39	2	1
40	2	1
41	2	1
42	2	1



ISSUED: May 31, 2013

EFFECTIVE: July 2, 2013

BY: Marshall M. Criser III, President -FL  
Miami, Florida

**E6. BELLSOUTH SWA SERVICE  
(DELETE)**

Page	Revision	Cancels Revision
43	4	3
44	2	1
45	2	1
46	3	2
47	2	1
48	4	3
49	2	1
50	3	2
51	2	1
52	2	1
53	5	4
54	5	4
55	3	2
56	2	1
57	2	1
58	4	3
58.1	2	1
58.1.1	1	Original
58.1.2	1	Original
58.2	3	2
58.3	3	2
58.4	2	1
59	2	1
60	2	1
61	3	2
62	3	2
63	2	1
64	4	3
65	3	2
66	3	2
67	2	1
68	2	1
69	4	3
70	4	3
71	4	3
72	2	1
73	2	1
74	7	6

ISSUED: May 31, 2013

EFFECTIVE: July 2, 2013

BY: Marshall M. Criser III, President -FL  
Miami, Florida

**E6. BELLSOUTH SWA SERVICE  
(DELETED)**

Page	Revision	Cancels Revision
75	2	1
76	2	1
77	4	3
78	2	1
79	2	1
80	2	1
81	2	1
82	2	1
83	5	4
84	2	1
85	2	1
86	2	1
87	6	5
88	9	8
89	2	1
90	5	4
91	7	6
92	4	3
93	2	1
94	2	1
95	2	1
96	3	2
97	4	3
98	2	1
99	2	1
100	2	1
101	4	3
102	2	1
103	6	5
104	5	4
105	3	2
106	5	4
106.1	1	Original
107	6	5
107.1	2	1
107.2	2	1

ISSUED: May 31, 2013

EFFECTIVE: July 2, 2013

BY: Marshall M. Criser III, President -FL  
Miami, Florida

**E6. BELLSOUTH SWA SERVICE  
(DELETED)**

Page	Revision	Cancels Revision
107.3	3	2
108	3	2
109	7	6
110	6	5
111	4	3
112	3	2
113	2	1
114	3	2
115	9	8
116	6	5
116.1	3	2
116.1.1	2	1
116.2	4	3
116.3	4	3
116.4	2	1
116.5	1	Original
116.6	1	Original
116.7	1	Original
116.8	1	Original
116.9	1	Original
116.10	1	Original
116.11	1	Original
116.12	1	Original
116.13	1	Original
116.14	1	Original
116.15	1	Original
116.16	1	Original
116.17	1	Original
116.18	1	Original
116.19	1	Original
116.20	1	Original
116.21	1	Original
117	9	8
118	3	2
119	3	2
120	3	2
121	3	2
122	4	3

ISSUED: May 31, 2013

EFFECTIVE: July 2, 2013

BY: Marshall M. Criser III, President -FL

**E6. BELLSOUTH SWA SERVICE  
(DELETED)**

Page	Revision	Cancels Revision
123	3	2
124	3	2
125	2	1
126	2	1
127	2	1
128	2	1
129	3	2
130	4	3
131	6	5
132	4	3

## E7. DEDICATED ACCESS SERVICES

### CONTENTS

<b>E7.1</b>	<b>General</b>		1
E7.1.1	Channel Types		1
E7.1.2	Rate Categories		2
E7.1.3	Service Configurations		4
E7.1.4	Alternate Use		7
E7.1.5	Special Facilities Routing		7
E7.1.6	Design Layout Report		7
E7.1.7	Acceptance Testing		7
E7.1.8	Ordering Options and Conditions		8
E7.1.9	Jurisdictional Report Requirements		8
<b>E7.2</b>	<b>Service Description</b>		8
E7.2.1	Reserved for Future Use		10
E7.2.2	Telegraph Grade (a.k.a. BellSouth SPA Telegraph) Service		10
E7.2.3	Voice Grade (a.k.a. BellSouth SPA DS0 VG) Service		10
E7.2.4	Reserved for Future Use		17
E7.2.5	Digital Data Access (a.k.a. BellSouth SPA DS0 VG) Service		17
E7.2.6	High Capacity (a.k.a. BellSouth SPA DS0 Digital Data) Service		20
E7.2.7	Reserved for Future Use		23
E7.2.8	Reserved for Future Use		23
E7.2.9	Reserved for Future Use		23
E7.2.10	Reserved for Future Use		23
E7.2.11	Reserved for Future Use		23
E7.2.12	SMARTPath Service (a.k.a. BellSouth SPA Shared Ring)		23
E7.2.13	Reserved for Future Use	24.1	(T)
E7.2.14	Reserved for Future Use	24.1	(T)
E7.2.15	Derived Data Channel (a.k.a. BellSouth SPA Derived Data Channel) Service		26
E7.2.16	SMARTRing service (a.k.a. BellSouth Dedicated Ring)		27
E7.2.17	Reserved for Future Use		27.2
E7.2.18	BellSouth Metro Ethernet Service		27.3

## E7. DEDICATED ACCESS SERVICES

### CONTENTS

<b>E7.3 Channel Interface and Network Channel Codes</b>	<b>27.6</b>	
E7.3.1 Glossary of Channel Interface Codes and Options	27.6	
E7.3.2 Impedance	31	
E7.3.3 Digital Hierarchy and Channel Interface Codes	32	
E7.3.4 Service Designator/Network Channel Code Conversion Table	32	
<b>E7.4 Rate Regulations</b>	<b>33</b>	
E7.4.1 Types of Rates and Charges	33	
E7.4.2 Dedicated Access Service Capable of Using the Local Exchange Network	38	
E7.4.3 Reserved for Future Use	39	
E7.4.4 Minimum Periods	39	
E7.4.5 Moves	39	
E7.4.6 Mileage Measurement	40	
E7.4.7 Facility Hubs	41	
E7.4.8 Shared Use Analog and Digital High Capacity (a.k.a. BellSouth SPA DS0 Digital Data) Services	42	
E7.4.9 Reserved for Future Use	43	
E7.4.10 Reserved for Future Use	43	
E7.4.11 Reserved for Future Use	43	
E7.4.12 FlexServ Service (a.k.a. BellSouth SPA Customer Reconfiguration)	43	
E7.4.13 Derived Data Channel (a.k.a. BellSouth SPA Derived Data Channel) Service (DDCS)	47	
E7.4.14 SMARTRing service (a.k.a. BellSouth Dedicated Ring)	47	
E7.4.15 Zone Pricing	48	
E7.4.16 Reserved for Future Use	48	(T)
E7.4.17 SMARTPath Service (a.k.a. BellSouth SPA Shared Ring)	48.1	
E7.4.18 Reserved for Future Use	48.2	
E7.4.19 Reserved for Future Use	48.2	
E7.4.20 Reserved for Future Use	48.2	
E7.4.21 Reserved for Future Use	48.2	
E7.4.22 Reserved for Future Use	48.2	
E7.4.23 Reserved for Future Use	48.2	
E7.4.24 Reserved for Future Use	48.2	
E7.4.25 Reserved for Future Use	48.2	
E7.4.26 Reserved for Future Use	48.2	
E7.4.27 Reserved for Future Use	48.2	
E7.4.28 Reserved for Future Use	48.2	
E7.4.29 Reserved for Future Use	48.2	
E7.4.30 Reserved for Future Use	48.2	
E7.4.31 Reserved for Future Use	48.2	
E7.4.32 BellSouth Metro Ethernet service	48.3	

## E7. DEDICATED ACCESS SERVICES

### CONTENTS

<b>E7.5</b>	<b>Rates and Charges</b>	49	
E7.5.1	Reserved for Future Use	49	
E7.5.2	Telegraph Grade (a.k.a. BellSouth SPA Telegraph) Service	49	
E7.5.3	Voice Grade (a.k.a. BellSouth SPA DS0 VG) Service	49	
E7.5.4	Reserved for Future Use	54	
E7.5.5	Digital Data Access (a.k.a. BellSouth SPA DS0 Digital Data) Service	54	
E7.5.6	High Capacity (a.k.a. BellSouth SPA High Capacity) Service	59	
E7.5.7	Digital Data Access Service (Indiantown Telephone System)	65	
E7.5.8	Reserved for Future Use	68	
E7.5.9	Reserved for Future Use	69	
E7.5.10	Reserved for Future Use	69	
E7.5.11	Reserved for Future Use	69	
E7.5.12	Reconfiguration Charges	69	
E7.5.13	Transfer of Service	69	
E7.5.14	Reserved for Future Use	69	
E7.5.15	Derived Data Channel (a.k.a. BellSouth SPA Derived Data Channel) Service	71	
E7.5.16	BellSouth FlexServ Service (a.k.a. BellSouth SPA Customer Reconfiguration)	71	
E7.5.17	BellSouth SMARTPath Service (a.k.a. BellSouth SPA Shared Ring)	73	
E7.5.18	BellSouth SMARTRingService (a.k.a. BellSouth Dedicated Ring)	74	
E7.5.19	Reserved for Future Use	77	(T)
E7.5.20	Reserved for Future Use	78	
E7.5.21	Reserved for Future Use	78	
E7.5.22	BellSouth Metro Ethernet service	78	

## E7. DEDICATED ACCESS SERVICES

### E7.1 General

Dedicated Access Services provide a transmission path to directly connect an IC terminal location in a LATA to the End User's premises<sup>1</sup>; two IC terminal locations; an IC terminal location and a HUB; or a HUB and an End User's premises. Dedicated Access Services include all exchange access not utilizing Company end office switches. This type of Access Service is used, for example, by IC's for the provision of private line service. When the Company incurs costs as a result of an IC generated activity, defined as the relocation of an IC POP, Dedicated Access Services nonrecurring charges will be billed to the IC. Prorating of high capacity services among End Users will not be allowed.

The connections provided by Dedicated Access Services can be either analog or digital. Analog connections are differentiated by spectrum and bandwidth. Digital connections are differentiated by bit rate.

#### E7.1.1 Channel Types

There are six types of channels used to provide Dedicated Access Services. Each type has its own characteristics. All are subdivided by one or more of the following:

- Transmission specifications
- Bandwidth
- Speed (i.e., bit rate)
- Spectrum

Customers can order a basic channel and select from a list of available transmission parameters and channel interfaces, that they desire to meet specific communications requirements.

For purposes of ordering channels, each has been identified as a type of Dedicated Access Service. However, such identification is not intended to limit a customer's use of the channel, nor to imply that the channel is limited to a particular use.

Following is a brief description of each type of channel:

1. Telegraph Grade<sup>2</sup> (a.k.a. BellSouth SPA Telegraph) (TG) - a channel for the transmission of binary signals at rates of 0 to 75 baud or 0 to 150 baud. (C)
2. Voice Grade<sup>2</sup> (a.k.a. BellSouth SPA DS0 VG) (VG) - a channel for the transmission of analog signals within an approximate bandwidth of 300-3000 Hz. (C)
3. **(DELETED)**
4. Digital Data Access<sup>2</sup> (a.k.a. BellSouth SPA DS0 Digital Data) Service (DDAS) - a channel for the digital transmission of synchronous serial data at rates of 2.4, 4.8, 9.6, 19.2, 56.0 or 64.0 Kbps. (C)
5. High Capacity (a.k.a. BellSouth SPA High Capacity) (HC) - a channel for the transmission of isochronous serial digital data at rates of 1.544, 3.152, 6.312, or 44.736 Mbps.
6. Derived Data Channel<sup>2</sup> (a.k.a. BellSouth SPA Derived Data Channel) - a digital data channel derived from a two-wire local exchange facility that transmits voice and data signals simultaneously. (C)

Note 1: Company Centrex CO-like switches and other Company CO derived services are considered to be End User's premises for purposes of this Tariff.

Note 2: Effective June 30, 2021, this Service will no longer be available for purchase by new or existing customers. In addition, requests to move, add, change, or renew existing service arrangements will not be accepted. Following the expiration of a customer's existing term agreement, service will be provided on a month-to-month basis at the applicable Monthly rates until the service is discontinued. The Company currently plans to discontinue this service on or after June 30, 2024.

(N)  
|  
(N)



## E7. DEDICATED ACCESS SERVICES

### E7.1 General (Cont'd)

#### E7.1.1 Channel Types (Cont'd)

Detailed descriptions of each of the channel types are provided in E7.2 following.

The customer also has the option of ordering digital high capacity facilities (i.e., 1.544 Mbps, 3.152 Mbps, 6.312 Mbps, and 44.736 Mbps) to a Company Hub for channelization to individual channels of a lower capacity. Descriptions of the types of channelization available at the hubs, as well as the number of individual channels which may be derived from each type of facility are set forth in E7.2 following. Additionally, the customer may specify optional features for the individual channels derived from the facility to further tailor the channel to meet specific communications requirements. Descriptions of the optional features and functions available are also set forth in E7.2 following.

For example, a customer may order a 44.736 Mbps facility from a designated premises to a Company Hub for channelization to twenty-eight 1.544 Mbps channels. The 1.544 Mbps channels may be further channelized at the same or a different Hub to Voice Grade<sup>1</sup> (a.k.a. BellSouth SPA DS0 VG) channels or may be extended to other customer designated premises. Optional features may be added to either the 1.544 Mbps or the Voice Grade<sup>1</sup> (a.k.a. BellSouth SPA DS0 VG) channels.

#### E7.1.2 Rate Categories

The following basic rate categories apply to Dedicated Access Services:

- Local Channels (described in A. following)
- Interoffice Channel (described in B. following)
- Optional Features and Functions (described in C. following)
- SMARTRing<sup>®2</sup> service (a.k.a. BellSouth Dedicated Ring) (described in F. following)

These basic categories are shown in the diagram in E7.1.3.A.

The rate categories for SMARTPath<sup>®</sup> service are:

- SMARTPath<sup>®</sup> (a.k.a. BellSouth SPA DS1 Shared Ring) Area Connection (described in D. following)
- SMARTPath<sup>®</sup> (a.k.a. BellSouth SPA DS1 Shared Ring) Area Junction (described in E. following)

##### A. Local Channel

The Local Channel rate category provides for the communications path between a customer designated premises and the serving wire center of that premises. Included as part of the Local Channel is a standard channel interface arrangement which defines the technical characteristics associated with the type of facilities to which the access service is to be connected at the Point of Termination (POT) and the type of signaling capability, if any. The signaling capability itself is provided as an optional feature as set forth in C. following. One Local Channel charge applies per customer designated premises at which the channel is terminated. This charge will apply even if the customer premises and the serving wire center are co-located in a Company building. The Local Channel rate element is further designated as to whether the premises is an End User or an IC terminal location. A Hub Termination charge applies in addition to each Digital Data Access<sup>1</sup> (a.k.a. BellSouth SPA DS0 Digital Data) service Local Channel.

**Note 1:** Effective June 30, 2021, this Service will no longer be available for purchase by new or existing customers. In addition, requests to move, add, change, or renew existing service arrangements will not be accepted. Following the expiration of a customer's existing term agreement, service will be provided on a month-to-month basis at the applicable Monthly rates until the service is discontinued. The Company currently plans to discontinue this service on or after June 30, 2024.

**Note 2:** Effective on or after December 1, 2021, neither new nor existing customers will be permitted to purchase new SMARTRing Service (Service). In addition, (A) Service Payment Plans greater than 12-months in length will no longer be available; and (B) requests to move, add, change, upgrade, or downgrade existing service arrangements will not be accepted, with the following exceptions: (1) existing customers will be permitted to modify their existing Service and will be able to add new circuits to their existing Service, but will not be permitted to add new nodes in any locations; and (2) any such new circuits will be subject to the customer's existing term payment plan or term agreement for the Service to which they are added. Following the expiration of a customer's existing term agreement, Service will be provided on a month-to-month basis at the applicable Month-to-Month rates until the Service is discontinued.

Effective November 30, 2023, unless specified to the contrary in their existing Service agreements, existing customers may not renew Term Payment Plans or term agreements for Service. In addition, no move, add, or change orders of any type will be accepted.

## E7. DEDICATED ACCESS SERVICES

### E7.1 General (Cont'd)

#### E7.1.2 Rate Categories (Cont'd)

B. Interoffice Channel

The Interoffice Channel rate category provides for the transmission facilities between the serving wire centers associated with two customer designated premises, between a serving wire center associated with a customer designated premises and a Company Hub or between two Company Hubs. Interoffice Channel is portrayed in mileage bands. There are two rates that apply for each band, i.e., a flat rate per band and a rate per mile.

C. Optional Features and Functions

The Optional Features and Functions rate category provides for optional features and functions which may be added to a Dedicated Access Service to improve its quality or utility to meet specific communications requirements. These are not necessarily identifiable with specific equipment, but rather represent the end result in terms of performance characteristics which may be obtained. These characteristics may be obtained by using various combinations of equipment. Although the equipment necessary to perform a specified function may be installed at various locations along the path of the service, they will be charged for as a single rate element.

Examples of Optional Features and Functions that are available include, but are not limited to, the following:

- Signaling Capability
- Hubbing Functions
- Conditioning
- Transfer Arrangements
- FlexServ<sup>®</sup> service (a.k.a. BellSouth SPA Customer Reconfiguration)

A Hub is a Company designated serving wire center at which bridging or channelization functions are performed. The bridging functions performed are to connect three or more customer designated premises in a multipoint arrangement. The channelization functions are to channelize analog or digital facilities to individual services requiring a lower capacity. National Exchange Carrier Association Tariff FCC No. 4 identifies serving wire centers, Hub locations and the type of bridging or channelization functions available.

Descriptions for each of the available Optional Features and Functions are set forth in E7.2 following.

D. The SMARTPath<sup>®</sup> (a.k.a. BellSouth SPA DS1 Shared Ring) Area Connection provides for the connection at the designated premises where the customer gains access to SMARTPath<sup>®</sup> service (a.k.a. BellSouth SPA DS1 Shared Ring) and transport to a designated junction in the same SMARTPath<sup>®</sup> service (a.k.a. BellSouth SPA DS1 Shared Ring) area.

E. The SMARTPath<sup>®</sup> (a.k.a. BellSouth SPA DS1 Shared Ring) Area Junction provides for the connection between the SMARTPath<sup>®</sup> service (a.k.a. BellSouth SPA DS1 Shared Ring) network and (1) another customer designated premises, in the same SMARTPath<sup>®</sup> service (a.k.a. BellSouth SPA DS1 Shared Ring) Area or (2) a serving wire center in the same SMARTPath<sup>®</sup> service (a.k.a. BellSouth SPA DS1 Shared Ring) Area for connection to (a) DS1 Basic Channelization, FlexServ<sup>®</sup> service (a.k.a. BellSouth SPA Customer Reconfiguration) or DS3 service as provided in Section E7. of this Tariff, or (b) a SMARTPath<sup>®</sup> service (a.k.a. BellSouth SPA DS1 Shared Ring) Area Junction of another SMARTPath<sup>®</sup> service (a.k.a. BellSouth SPA DS1 Shared Ring) area in the same Metropolitan Area.

F. Self-healing Multi-nodal Alternate Route Topology Ring (SMARTRing<sup>®</sup> service [a.k.a. BellSouth Dedicated Ring]) (C)

1. Customer Node

Customer Nodes provide ring switching capabilities at customer designated locations other than Telephone Company Premises that are part of SMARTRing<sup>®</sup> service (a.k.a. BellSouth Dedicated Ring). This rate element offers OC-3, OC-3+, OC-12, OC-48, or OC-48+ network capacities. An OC-1 network capacity is available only in an Overlay Ring Arrangement riding the customer's host OC-12, OC-48, or OC-48+ SMARTRing<sup>®</sup> service (a.k.a. BellSouth Dedicated Ring) installed on or after June 3, 1994. A summary of the channel interfaces available with each node are specified in E7.2.11.A following.

2. Customer Channel Interface

A Customer Channel Interface provides DS1, DS3, STS-1 electrical channelization and/or OC-3 and/or OC-12 optical

**Note 1:** Effective on or after December 1, 2021, neither new nor existing customers will be permitted to purchase new SMARTRing Service (Service). In addition, (A) Service Payment Plans greater than 12-months in length will no longer be available; and (B) requests to move, add, change, upgrade, or downgrade existing service arrangements will not be accepted, with the following exceptions: (1) existing customers will be permitted to modify their existing Service and will be able to add new circuits to their existing Service, but will not be permitted to add new nodes in any locations; and (2) any such new circuits will be subject to the customer's existing term payment plan or term agreement for the Service to which they are added. Following the expiration of a customer's existing term agreement, Service will be provided on a month-to-month basis at the applicable Month-to-Month rates until the Service is discontinued. (N)

Effective November 30, 2023, unless specified to the contrary in their existing Service agreements, existing customers may not renew Term Payment Plans or term agreements for Service. In addition, no move, add, or change orders of any type will be accepted. (N)

## E7. DEDICATED ACCESS SERVICES

### E7.1 General (Cont'd)

#### E7.1.2 Rate Categories (Cont'd)

- F. Self-healing Multi-nodal Alternate Route Topology Ring (SMARTRing<sup>®I</sup> service [a.k.a. BellSouth Dedicated Ring]) (Cont'd) (C)
- 2 Customer Channel Interface (Cont'd)  
channelization that may take place at each Customer Node of SMARTRing<sup>®</sup> service (a.k.a. BellSouth Dedicated Ring). The Customer Channel Interface rate element applies for every interface capacity that originates or terminates at a Customer Node. A summary of the channel interfaces available with each node are specified in E7.2.16.A. following.
  3. Central Office Node  
Central Office Nodes provide ring switching capabilities at Telephone Company Central Offices that are a part of SMARTRing<sup>®</sup> service (a.k.a. BellSouth Dedicated Ring). This rate element offers OC-3, OC-3+, OC-12, OC-48, and OC-48+ network capacities. An OC-1 network capacity is available only in an Overlay Ring Arrangement riding the customer's host OC-12, OC-48 or OC-48+ SMARTRing<sup>®</sup> service (a.k.a. BellSouth Dedicated Ring) installed on or after June 3, 1994. A summary of the channel interfaces available with each node are specified in E7.2.16.A. following.
  4. Central Office Channel Interface  
A Central Office Channel Interface provides DS1, DS3, STS-1 electrical channelization and/or OC-3 and/or OC-12 optical channelization that may take place at each Central Office Node located on SMARTRing<sup>®</sup> service (a.k.a. BellSouth Dedicated Ring). The Central Office Channel Interface rate element applies for every interface capacity that originates or terminates at a Central Office Node. A summary of the channel interfaces available with each node are specified in E7.2.16.A. following. Customers with DS3 or STS-1 interfaces at the Customer Node electing to connect with DS1 services at a Central Office Node, must obtain a 28-DS1 Channel System.
  5. Local Channel  
The Local Channel rate category provides for the communications path between a Customer Node and the serving wire center of the premises where located. Charges for Local Channels apply as described in A. preceding. It is available with all capacities of SMARTRing<sup>®</sup> service (a.k.a. BellSouth Dedicated Ring) except OC-1.
  6. Alternate Central Office Channel  
The Alternate Central Office Channel provides for the communications path between a customer node and an alternate central office. It is available with all capacities of SMARTRing<sup>®</sup> service (a.k.a. BellSouth Dedicated Ring) except OC-1.
  7. Interoffice Channel  
The Interoffice Channel provides for the communications path between directly connected Telephone Company central offices located on a SMARTRing<sup>®</sup> service (a.k.a. BellSouth Dedicated Ring). It is available with all capacities of SMARTRing<sup>®</sup> service (a.k.a. BellSouth Dedicated Ring) except OC-1. This rate element does not apply where Central Office Nodes are adjacently connected in the same Central Office on the same SMARTRing<sup>®</sup> service (a.k.a. BellSouth Dedicated Ring) for the purpose of providing additional node capacity.
  - 8 Internodal Channel  
The Internodal Channel provides for the communications path between two directly connected Customer Nodes of a given SMARTRing<sup>®</sup> service (a.k.a. BellSouth Dedicated Ring) located (a) in the same Serving Wire Center area or (b) in the same Office Park/Campus Environment or contiguous property, located in contiguous Serving Wire Center areas. It is available with all capacities of SMARTRing<sup>®</sup> service (a.k.a. BellSouth Dedicated Ring) except OC-1. This rate element does not apply where Customer Nodes are adjacently connected in the same building on the same SMARTRing<sup>®</sup> service (a.k.a. BellSouth Dedicated Ring) for the purpose of providing additional node capacity.
  9. Channel Interface Capacity Reallocation  
Channel Interface Capacity Reallocation allows the customer to reallocate STS-1, DS3 capacity interfaces at each node subsequent to the initial service installation.
- Note 1:** Effective on or after December 1, 2021, neither new nor existing customers will be permitted to purchase new SMARTRing Service (Service). In addition, (A) Service Payment Plans greater than 12-months in length will no longer be available; and (B) requests to move, add, change, upgrade, or downgrade existing service arrangements will not be accepted, with the following exceptions: (1) existing customers will be permitted to modify their existing Service and will be able to add new circuits to their existing Service, but will not be permitted to add new nodes in any locations; and (2) any such new circuits will be subject to the customer's existing term payment plan or term agreement for the Service to which they are added. Following the expiration of a customer's existing term agreement, Service will be provided on a month-to-month basis at the applicable Month-to-Month rates until the Service is discontinued. (N)
- Effective November 30, 2023, unless specified to the contrary in their existing Service agreements, existing customers may not renew Term Payment Plans or term agreements for Service. In addition, no move, add, or change orders of any type will be accepted. (N)

## E7. DEDICATED ACCESS SERVICES

### E7.1 General (Cont'd)

#### E7.1.2 Rate Categories (Cont'd)

G. (DELETED)

#### H. Access Collocation Cross-Connects

Access Collocation Cross-Connects provide a means for customers to interconnect their Shared Use and Digital High Capacity (a.k.a. BellSouth SPA High Capacity) to Central Office Collocation arrangements within the same Central Office. Terms, conditions, and rates for Physical Access Collocation Cross-Connects and Virtual Access Collocation Cross-Connects are set forth in Section E13. of this Tariff.

(D)  
|  
(D)

## E7. DEDICATED ACCESS SERVICES

### E7.1 General (Cont'd)

#### E7.1.3 Service Configurations

There are three types of service configurations over which Dedicated Access Services are provided: two-point service, multipoint service and SmartRing<sup>®3</sup> service (a.k.a. BellSouth Dedicated Ring). (C)

A change from one Dedicated Access service configuration to another will be treated as a discontinuance of existing service and an installation of a new service as set forth in E5.6 preceding, except for FlexServ<sup>®</sup> service (a.k.a. BellSouth SPA Customer Reconfiguration) reconfigurations.

##### A. Two-Point Service

A two-point service connects two customer designated premises, either on a directly connected basis or through a hub where channelization functions are performed.

Applicable rate elements are:

- Local Channels
- Interoffice Channel (as applicable)
- Optional Features and Functions (when applicable)

The following diagram depicts a two-point Voice Grade<sup>2</sup> (a.k.a. BellSouth SPA DS0 VG) service connecting two customer designated premises located 15 miles apart. The service is provided with C-Type Conditioning.

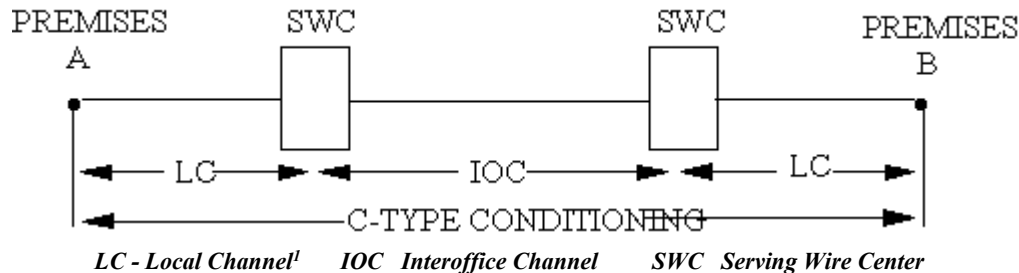

Applicable rate elements are:

- Local Channels<sup>1</sup> (2 applicable)
- Interoffice Channel (mileage band Over 8 to 25 miles)
- Interoffice Channel (mileage band Over 8 to 25 miles)
- C-Type conditioning Optional Feature

**Note 1:** Two Local Channels are applicable.

**Note 2:** Effective June 30, 2021, this Service will no longer be available for purchase by new or existing customers. In addition, requests to move, add, change, or renew existing service arrangements will not be accepted. Following the expiration of a customer's existing term agreement, service will be provided on a month-to-month basis at the applicable Monthly rates until the service is discontinued. The Company currently plans to discontinue this service on or after June 30, 2024.

**Note 3:** Effective on or after December 1, 2021, neither new nor existing customers will be permitted to purchase new SMARTRing Service (Service). In addition, (A) Service Payment Plans greater than 12-months in length will no longer be available; and (B) requests to move, add, change, upgrade, or downgrade existing service arrangements will not be accepted, with the following exceptions: (1) existing customers will be permitted to modify their existing Service and will be able to add new circuits to their existing Service, but will not be permitted to add new nodes in any locations; and (2) any such new circuits will be subject to the customer's existing term payment plan or term agreement for the Service to which they are added. Following the expiration of a customer's existing term agreement, Service will be provided on a month-to-month basis at the applicable Month-to-Month rates until the Service is discontinued. (N)

Effective November 30, 2023, unless specified to the contrary in their existing Service agreements, existing customers may not renew Term Payment Plans or term agreements for Service. In addition, no move, add, or change orders of any type will be accepted. (N)

## E7. DEDICATED ACCESS SERVICES

(T)

### E7.1 General (Cont'd)

#### E7.1.3 Service Configurations (Cont'd)

##### B. Multipoint Service

Multipoint service connects three or more designated premises through a Company Hub. There is no limitation on the number of mid-links available with multipoint service. However, when more than three mid-links are provided in tandem, the quality of the service may be degraded. A mid-link is a channel between hubs (i.e., bridging locations). Only certain types of Dedicated Access Service are provided as multipoint service. These are so designated in the Service Descriptions set forth in E7.2. following. Charges for Multipoint service will be billed to one customer.

Multipoint service utilizing a customized technical specifications package as set forth in E7.2. following will be provided when technically possible. If the Company determines that the requested characteristics for a multipoint service are not compatible, the customer will be advised and given the opportunity to change the order.

When ordering, the customer will specify the desired bridging Hub(s) selected from the Exchange Carrier Association Tariff F.C.C. No. 4. This tariff identifies the type(s) of bridging functions which are available and the serving wire centers at which they are available.

Applicable Rate Elements are:

- Local Channels (one per customer designated premises)
- Interoffice Channel (as applicable between each designated customer premises and the Hub and between Hubs)
- Bridging
- Additional Optional Features (when applicable)

## E7. DEDICATED ACCESS SERVICES

### E7.1 General (Cont'd)

#### E7.1.3 Service Configurations (Cont'd)

B. Multipoint Service (Cont'd)

Example: Voice Grade<sup>1</sup> (*a.k.a. BellSouth SPA DS0 VG*) multipoint connecting four customer premises via two customer specified bridging hubs. (C)

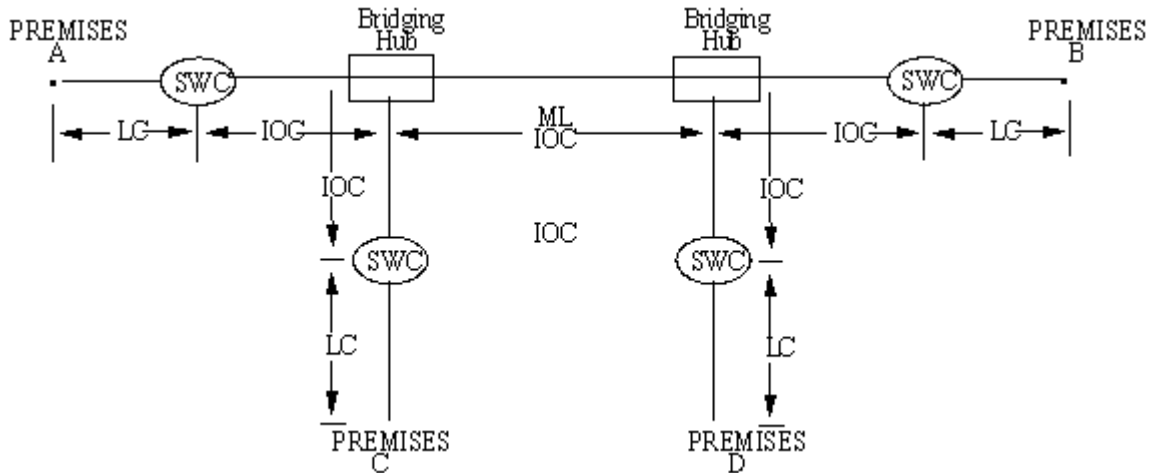

IOC - Interoffice Channel  
 B - Bridging  
 SWC - Serving Wire Center  
 LC - Local Channel

Applicable rate elements are:

- Local Channels (4 applicable)
- Interoffice Channel (5 sections, each from appropriate mileage band)
- Bridging Optional Feature (6 applicable, i.e., each bridge port)

Note 1: Effective June 30, 2021, this Service will no longer be available for purchase by new or existing customers. In addition, requests to move, add, change, or renew existing service arrangements will not be accepted. Following the expiration of a customer's existing term agreement, service will be provided on a month-to-month basis at the applicable Monthly rates until the service is discontinued. The Company currently plans to discontinue this service on or after June 30, 2024.

(N)  
 |  
 (N)

## E7. DEDICATED ACCESS SERVICES

### E7.1 General (Cont'd)

#### E7.1.3 Service Configurations (Cont'd)

- C. SMARTRing<sup>®</sup> service (a.k.a. BellSouth Dedicated Ring) (C)
1. The SMARTRing<sup>®</sup> service (a.k.a. BellSouth Dedicated Ring) configuration utilizes a multi-nodal ring architecture which is specified jointly by the Telephone Company and the customer. The minimum configuration provides dedicated DS3 and/or DS1 digital services and must include at least three nodes. The three nodes may all be Central Office Nodes in Telephone Company Central Offices, or the three nodes may be a Central Office Node in a Telephone Company Central Office, a Customer Node at a customer's designated location and the third node may be either a Central Office Node or a node at another customer designated location. Additional nodes for either arrangement may be any combination thereof. (D)  
The maximum number of nodes will be determined based on equipment capability. The nodes are connected by SMARTRing<sup>®</sup> service (a.k.a. BellSouth Dedicated Ring) Local Channels, Alternate Central Office Channels, Interoffice Channels and Internodal Channels as applicable. SMARTRing<sup>®</sup> service (a.k.a. BellSouth Dedicated Ring) may be connected to other DS3/DS1 services only at Central Office Nodes. With OC-12 SMARTRing<sup>®</sup> service (a.k.a. BellSouth Dedicated Ring) installed on or after June 3, 1994, and with OC-48 and OC-48+ SMARTRing<sup>®</sup> service (a.k.a. BellSouth Dedicated Ring) the customer may request an OC-1 and/or OC-3 Overlay Ring Arrangement riding the customer's host OC-12, OC-48, or OC-48+ SMARTRing<sup>®</sup> service (a.k.a. BellSouth Dedicated Ring). With OC-48 SMARTRing<sup>®</sup> service (a.k.a. BellSouth Dedicated Ring), the customer may request an OC-3+ and/or OC-12 Overlay Ring Arrangement riding the customer's host OC-48 SMARTRing<sup>®</sup> service (a.k.a. BellSouth Dedicated Ring). In an Overlay Ring Arrangement, node and channel configuration requirements apply to the host SMARTRing<sup>®</sup> service (a.k.a. BellSouth Dedicated Ring).
  2. Applicable rate elements for this service are:
    - a. Customer Node (at least one for configurations other than three Central Office Node arrangement)
    - b. Customer Channel Interface (one for each originating/terminating activated DS1, DS3, STS-1, OC-3, and/or OC-12 for each Customer Node)
    - c. Central Office Node (at least one for configurations other than three Central Office Node arrangement)
    - d. Central Office Channel Interface (one for each originating/terminating activated DS1, DS3, STS-1, OC-3 and/or OC-12 for each Central Office Node or one for each 28 DS1 Channel System and associated DS1 Channel Interfaces for each activated DS3)
    - e. Local Channel (at least one for each Customer Node which is directly connected to the serving wire center)
    - f. Alternate Central Office Channel (at least one for each Customer Node which is directly connected to an Alternate Central Office)
    - g. Internodal Channel (one for each path between two directly connected customer nodes)
    - h. Interoffice Channel (one for each path between each two directly connected Telephone Company Central Offices)
    - i. Channel Interface Capacity Reallocation (one per node per occurrence)

**Note 1:** Effective on or after December 1, 2021, neither new nor existing customers will be permitted to purchase new SMARTRing Service (Service). In addition, (A) Service Payment Plans greater than 12-months in length will no longer be available; and (B) requests to move, add, change, upgrade, or downgrade existing service arrangements will not be accepted, with the following exceptions: (1) existing customers will be permitted to modify their existing Service and will be able to add new circuits to their existing Service, but will not be permitted to add new nodes in any locations; and (2) any such new circuits will be subject to the customer's existing term payment plan or term agreement for the Service to which they are added. Following the expiration of a customer's existing term agreement, Service will be provided on a month-to-month basis at the applicable Month-to-Month rates until the Service is discontinued. (N)  
Effective November 30, 2023, unless specified to the contrary in their existing Service agreements, existing customers may not renew Term Payment Plans or term agreements for Service. In addition, no move, add, or change orders of any type will be accepted. (N)



## E7. DEDICATED ACCESS SERVICES

### E7.1 General (Cont'd)

#### E7.1.3 Service Configurations

C. SMARTRing<sup>®</sup> service (a.k.a. BellSouth Dedicated Ring) (Cont'd)

(C)

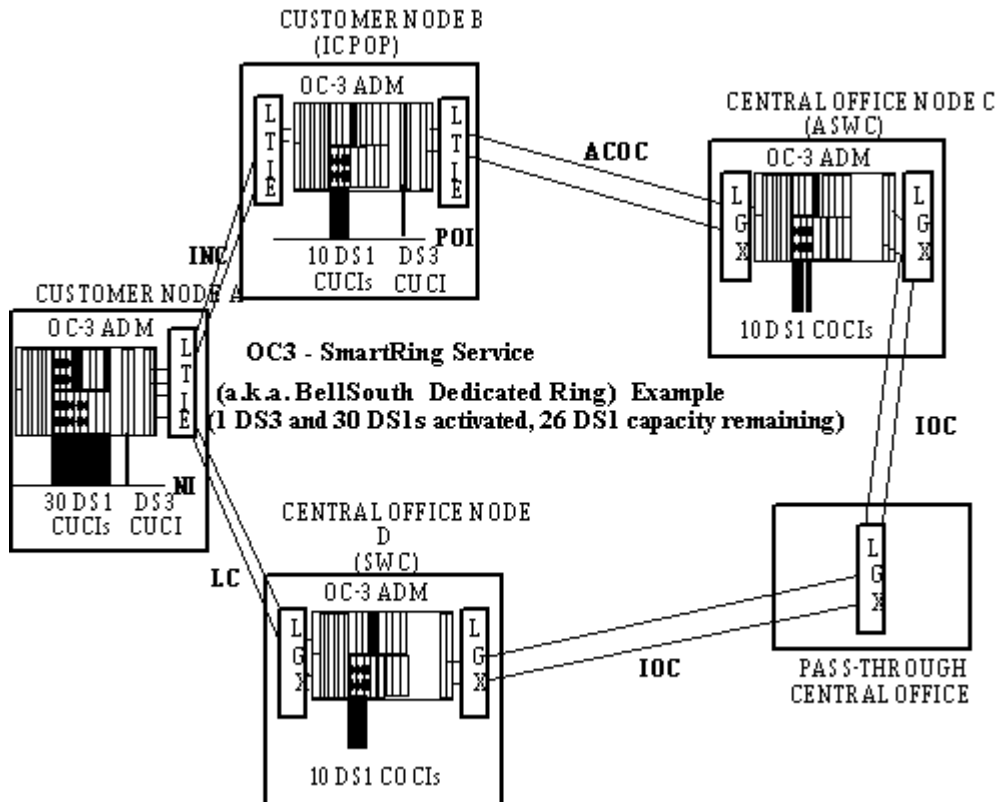

Example: SMARTRing<sup>®</sup> service (a.k.a. BellSouth Dedicated Ring) OC-3 capacity.

For this example the following rate elements are applicable:

(C)

- |                          |                                    |  |
|--------------------------|------------------------------------|--|
| - 2 Customer Nodes       | 1 Internodal Channel               | 2 DS3 Customer Channel Interfaces        |
| - 2 Central Office Nodes | 1 Alternate Central Office Channel | 40 DS1 Customer Channel Interfaces       |
| - 1 Local Channel        | 2 Interoffice Channels             | 20 DS1 Central Office Channel Interfaces |

**Note 1:** Effective on or after December 1, 2021, neither new nor existing customers will be permitted to purchase new SMARTRing Service (Service). In addition, (A) Service Payment Plans greater than 12-months in length will no longer be available; and (B) requests to move, add, change, upgrade, or downgrade existing service arrangements will not be accepted, with the following exceptions: (1) existing customers will be permitted to modify their existing Service and will be able to add new circuits to their existing Service, but will not be permitted to add new nodes in any locations; and (2) any such new circuits will be subject to the customer's existing term payment plan or term agreement for the Service to which they are added. Following the expiration of a customer's existing term agreement, Service will be provided on a month-to-month basis at the applicable Month-to-Month rates until the Service is discontinued.

(N)

Effective November 30, 2023, unless specified to the contrary in their existing Service agreements, existing customers may not renew Term Payment Plans or term agreements for Service. In addition, no move, add, or change orders of any type will be accepted.

(N)

## E7. DEDICATED ACCESS SERVICES

### E7.1 General (Cont'd)

#### E7.1.3 Service Configurations (Cont'd)

C. SMARTRing<sup>®/I</sup> service (a.k.a. BellSouth Dedicated Ring) (Cont'd)

(C)

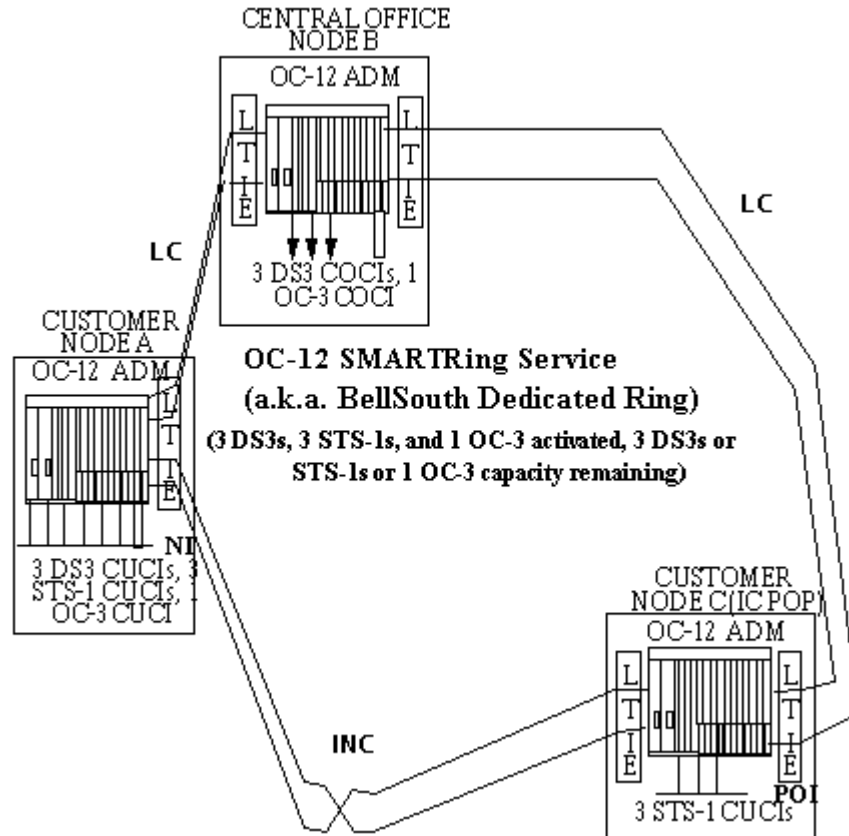

Example: SMARTRing<sup>®</sup> service (a.k.a. BellSouth Dedicated Ring) OC-12 capacity.

For this example the following rate elements are applicable:

(C)

- |                          |   |   |
|--------------------------|---|---|
| - 2 Customer Nodes       | 1 Internodal Channel                    | 6 STS 1 Customer Channel Interfaces     |
| - 1 Central Office Nodes | 3 DS3 Customer Channel Interfaces       | 1 OC 3 Customer Channel Interface       |
| - 2 Local Channels       | 3 DS3 Central Office Channel Interfaces | 1 OC 3 Central Office Channel Interface |

**Note 1:** Effective on or after December 1, 2021, neither new nor existing customers will be permitted to purchase new SMARTRing Service (Service). In addition, (A) Service Payment Plans greater than 12-months in length will no longer be available; and (B) requests to move, add, change, upgrade, or downgrade existing service arrangements will not be accepted, with the following exceptions: (1) existing customers will be permitted to modify their existing Service and will be able to add new circuits to their existing Service, but will not be permitted to add new nodes in any locations; and (2) any such new circuits will be subject to the customer's existing term payment plan or term agreement for the Service to which they are added. Following the expiration of a customer's existing term agreement, Service will be provided on a month-to-month basis at the applicable Month-to-Month rates until the Service is discontinued.

(N)

Effective November 30, 2023, unless specified to the contrary in their existing Service agreements, existing customers may not renew Term Payment Plans or term agreements for Service. In addition, no move, add, or change orders of any type will be accepted.

(N)

## E7. DEDICATED ACCESS SERVICES

### E7.1 General (Cont'd)

#### E7.1.3 Service Configurations (Cont'd)

C. SMARTRing<sup>®</sup> service (a.k.a. BellSouth Dedicated Ring) (Cont'd)

(C)

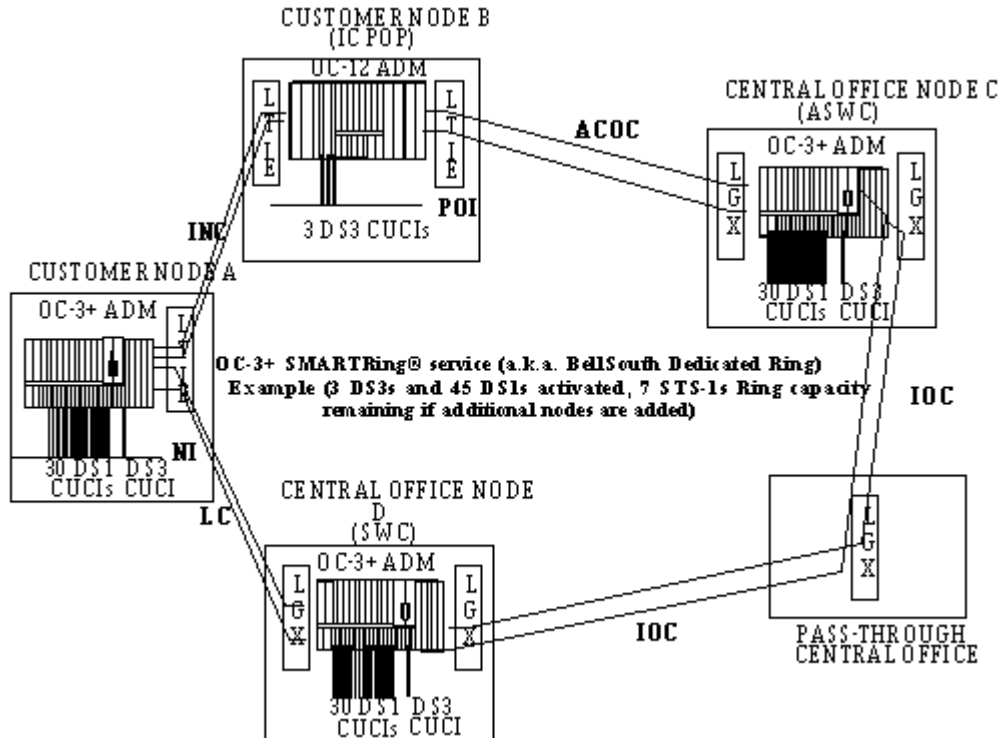

Example: SMARTRing<sup>®</sup> service (a.k.a. BellSouth Dedicated Ring) OC-3+ capacity.

For this example the following rate elements are applicable:

(C)

- 2 Customer Nodes      1 Alternate Central Office Channel      2 DS3 Central Office Channel Interfaces
- 2 Central Office Nodes      2 Interoffice Channels      30 DS1 Customer Channel Interfaces
- 1 Local Channel      4 DS3 Customer Channel Interfaces      60 DS1 Central Office Channel Interfaces
- 1 Internodal Channel

**Note 1:** Effective on or after December 1, 2021, neither new nor existing customers will be permitted to purchase new SMARTRing Service (Service). In addition, (A) Service Payment Plans greater than 12-months in length will no longer be available; and (B) requests to move, add, change, upgrade, or downgrade existing service arrangements will not be accepted, with the following exceptions: (1) existing customers will be permitted to modify their existing Service and will be able to add new circuits to their existing Service, but will not be permitted to add new nodes in any locations; and (2) any such new circuits will be subject to the customer's existing term payment plan or term agreement for the Service to which they are added. Following the expiration of a customer's existing term agreement, Service will be provided on a month-to-month basis at the applicable Month-to-Month rates until the Service is discontinued.

(N)

Effective November 30, 2023, unless specified to the contrary in their existing Service agreements, existing customers may not renew Term Payment Plans or term agreements for Service. In addition, no move, add, or change orders of any type will be accepted.

(N)

## E7. DEDICATED ACCESS SERVICES

### E7.1 General (Cont'd)

#### E7.1.3 Service Configurations (Cont'd)

##### C. SMARTRing<sup>®</sup> service (a.k.a. BellSouth Dedicated Ring) (Cont'd)

(C)

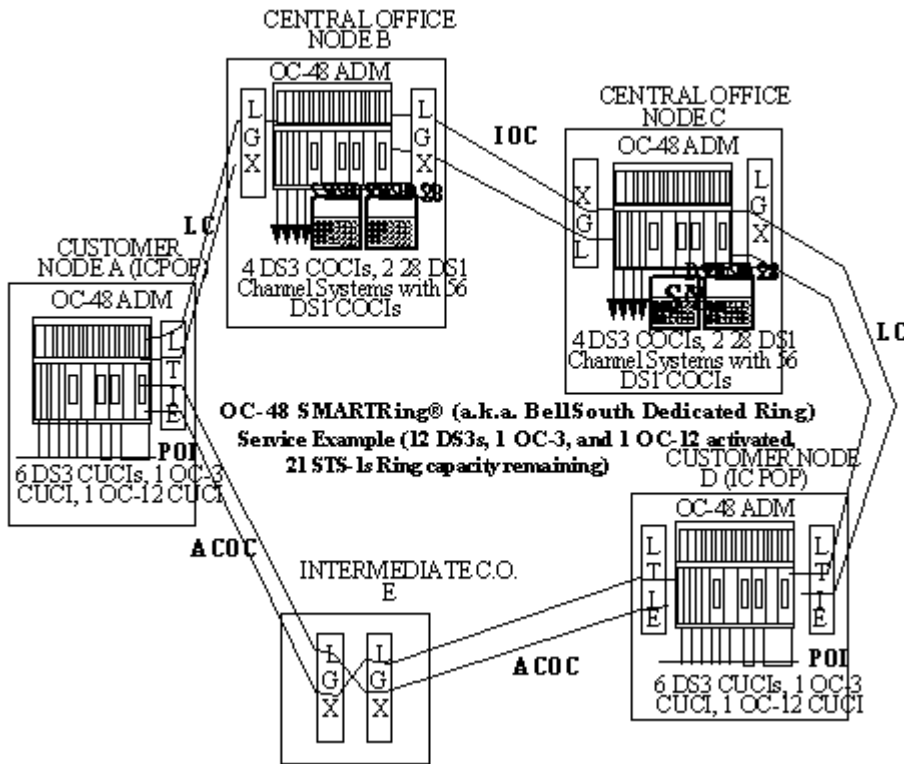

Example: SMARTRing<sup>®</sup> service (a.k.a. BellSouth Dedicated Ring) OC-48 capacity.

For this example the following rate elements are applicable:

(C)

- |                          |   |   |
|--------------------------|---|---|
| - 2 Customer Nodes       | 2 Alternate Central Office Channels     | 112 DS1 Central Office Channel Interfaces |
| - 2 Central Office Nodes | 12 DS3 Customer Channel Interfaces      | 2 OC 3 Customer Channel Interfaces        |
| - 2 Local Channels       | 8 DS3 Central Office Channel Interfaces | 2 OC 12 Customer Channel Interfaces       |
| - 1 Interoffice Channel  | 4 28 DS1 Channel Systems (DS3)          |   |

**Note 1:** Effective on or after December 1, 2021, neither new nor existing customers will be permitted to purchase new SMARTRing Service (Service). In addition, (A) Service Payment Plans greater than 12-months in length will no longer be available; and (B) requests to move, add, change, upgrade, or downgrade existing service arrangements will not be accepted, with the following exceptions: (1) existing customers will be permitted to modify their existing Service and will be able to add new circuits to their existing Service, but will not be permitted to add new nodes in any locations; and (2) any such new circuits will be subject to the customer's existing term payment plan or term agreement for the Service to which they are added. Following the expiration of a customer's existing term agreement, Service will be provided on a month-to-month basis at the applicable Month-to-Month rates until the Service is discontinued.

(N)

Effective November 30, 2023, unless specified to the contrary in their existing Service agreements, existing customers may not renew Term Payment Plans or term agreements for Service. In addition, no move, add, or change orders of any type will be accepted.

(N)

## E7. DEDICATED ACCESS SERVICES

### E7.1 General (Cont'd)

#### E7.1.3 Service Configurations (Cont'd)

##### C. SMARTRing<sup>®</sup> service (a.k.a. BellSouth Dedicated Ring) (Cont'd)

(C)

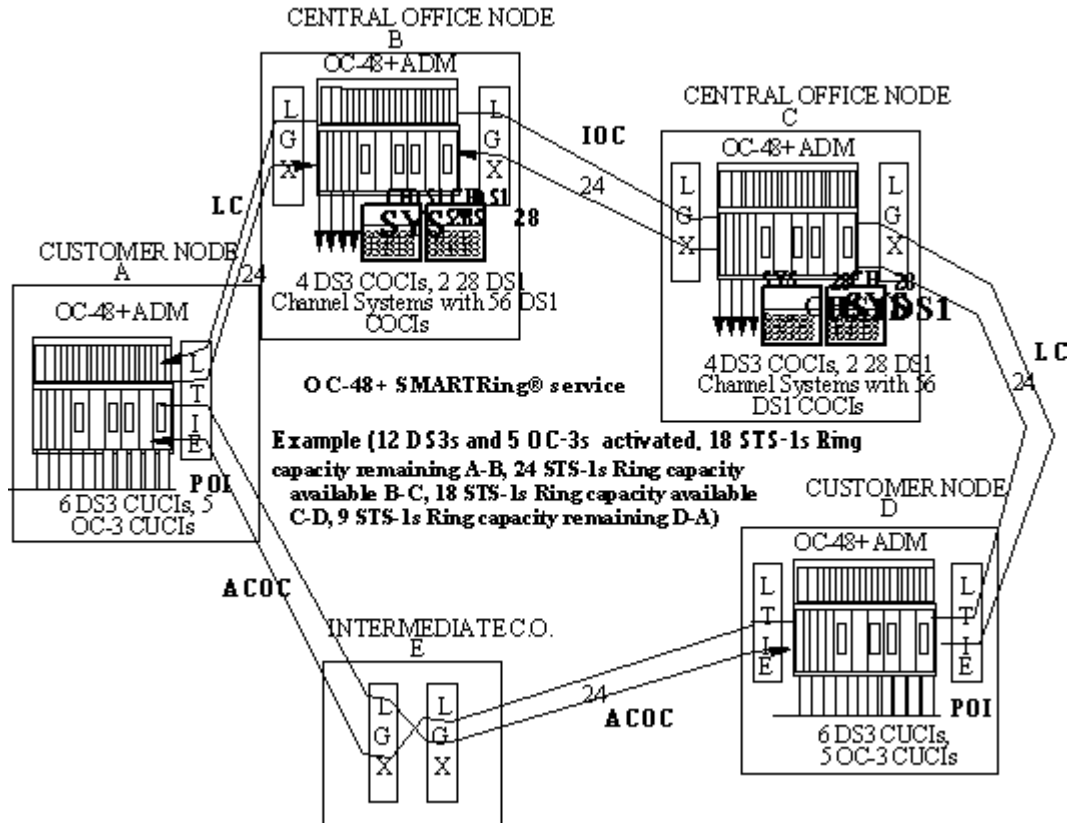

Example: SMARTRing<sup>®</sup> service (a.k.a. BellSouth Dedicated Ring) service OC-48+ capacity.

For this example the following rate elements are applicable:

(C)

- 2 Customer Nodes      2 Alternate Central Office Channels      4 28 DS1 Channel Systems (DS3)
- 2 Central Office Nodes      12 DS3 Customer Channel Interfaces      112 DS1 Central Office Channel Interfaces
- 2 Local Channels      8 DS3 Central Office Channel Interfaces      10 OC 3 Customer Channel Interfaces
- 1 Interoffice Channel

**Note 1:** Effective on or after December 1, 2021, neither new nor existing customers will be permitted to purchase new SMARTRing Service (Service). In addition, (A) Service Payment Plans greater than 12-months in length will no longer be available; and (B) requests to move, add, change, upgrade, or downgrade existing service arrangements will not be accepted, with the following exceptions: (1) existing customers will be permitted to modify their existing Service and will be able to add new circuits to their existing Service, but will not be permitted to add new nodes in any locations; and (2) any such new circuits will be subject to the customer's existing term payment plan or term agreement for the Service to which they are added. Following the expiration of a customer's existing term agreement, Service will be provided on a month-to-month basis at the applicable Month-to-Month rates until the Service is discontinued.

(N)

Effective November 30, 2023, unless specified to the contrary in their existing Service agreements, existing customers may not renew Term Payment Plans or term agreements for Service. In addition, no move, add, or change orders of any type will be accepted.

(N)

## E7. DEDICATED ACCESS SERVICES

### E7.1 General (Cont'd)

#### E7.1.4 Alternate Use

Alternate Use occurs when a service is arranged by the Company so that the End User can select different types of transmission at different times. The End User may use a service in any privately beneficial manner. However, where technical or engineering changes are required to effectuate an alternate use, the Company will make such special arrangements available on an individual case basis.

The arrangement required to transfer the service from one operation to the other (i.e., the transfer relay and control leads) will be rated and provided on an individual case basis and filed in Section E12., Specialized Service or Arrangements. The End User will pay the stated tariff rates for the Access Service rate elements for the service ordered (i.e., Local Channels, Interoffice Channel (as applicable) and Optional Features and Functions (if any)).

#### E7.1.5 Special Facilities Routing

A customer may request that the facilities used to provide Dedicated Access Services be specially routed. The regulations, rates and charges or Special Facilities Routing (i.e., Avoidance, Diversity and Cable Only) are set forth in Section E11.

#### E7.1.6 Design Layout Report

At the request of the customer, the Company will provide the make-up of the facilities and services provided under this Tariff as Dedicated Access Services to aid the customer in designing its overall service. This information will be provided in the form of a Design Layout Report. The Design Layout Report will be provided to the customer at no charge, and will be reissued whenever these facilities are materially changed.

#### E7.1.7 Acceptance Testing

At no additional charge, the Company will, at the customer's request, cooperatively test, at the time of installation, the following parameters:

- A. For Voice Grade<sup>1</sup> (*a.k.a. BellSouth SPA DS0 VG*) services, acceptance tests will include tests for loss, 3-tone slope, DC continuity, operational signaling, C-notched noise and C-message noise when these parameters are applicable and specified in the order for service. Additionally, for Voice Grade<sup>1</sup> (*a.k.a. BellSouth SPA DS0 VG*) services, a balance (improved loss) test will be made if the customer has ordered the improved return loss optional feature. (C)
- B. For digital services (i.e., Digital Data<sup>1</sup> (*a.k.a. BellSouth SPA DS0 Digital Data*), and High Capacity (*a.k.a. BellSouth SPA High Capacity*)), acceptance tests will include tests for the parameters applicable to the service as specified in the order for service. (C)

Note 1: Effective June 30, 2021, this Service will no longer be available for purchase by new or existing customers. In addition, requests to move, add, change, or renew existing service arrangements will not be accepted. Following the expiration of a customer's existing term agreement, service will be provided on a month-to-month basis at the applicable Monthly rates until the service is discontinued. The Company currently plans to discontinue this service on or after June 30, 2024.

(N)  
|  
(N)

## E7. DEDICATED ACCESS SERVICES

### E7.1 General (Cont'd)

#### E7.1.7 Acceptance Testing (Cont'd)

- B. For digital services (i.e., Digital Data<sup>1</sup> (a.k.a. BellSouth SPA DS0 Digital Data), and High Capacity (a.k.a. BellSouth SPA High Capacity), acceptance tests will include tests for the parameters applicable to the service as specified in the order for service. (Cont'd)

In addition to the preceding tests, Additional Cooperative Acceptance Testing for Voice Grade<sup>1</sup> (a.k.a. BellSouth SPA DS0 VG) service to test other parameters, as described in E13.3.5.B., is available at the customer's request. All test results will be made available to the customer upon request.

- C. If acceptance tests are not started within 30 minutes after the scheduled appointment time for such tests, as negotiated between the Company and the IC, additional charges may apply to the IC, as set forth in Section E13.

#### E7.1.8 Ordering Options and Conditions

The options and conditions for access orders are set forth in detail in Section E5. Also included in that section are other charges which may be associated with ordering Dedicated Access Services (e.g., Service Date Change Charges, Cancellation Charges, etc.).

#### E7.1.9 Jurisdictional Report Requirements

An IC or End User must order Dedicated Access Services for either interstate or intrastate use. Dedicated Access Services connecting to an interstate facility, either directly or through a customer provided switch, must be ordered as interstate Special Access (a.k.a. BellSouth SPA) service in accordance with the applicable rules and regulations of the BellSouth Telecommunications, Inc. Tariff F.C.C. No. 1.

### E7.2 Service Description

For the purpose of ordering, there are six categories of Dedicated Access Services. These are:

(C)

1. Telegraph Grade<sup>1</sup> (a.k.a. BellSouth SPA Telegraph) (TG)
2. Voice Grade<sup>1</sup> (a.k.a. BellSouth SPA DS0 VG) (VG)
3. Digital Data Access<sup>1</sup> (a.k.a. BellSouth SPA DS0 Digital Data) service (DDAS)
4. High Capacity (a.k.a. BellSouth SPA High Capacity) (HC)
5. Self-Healing Rings (SMARTRing<sup>2</sup> service (a.k.a. BellSouth Dedicated Ring)
6. Derived Data Channel<sup>1</sup> (a.k.a. BellSouth SPA Derived Data Channel) service

Each service consists of a basic channel to which a technical specifications package (predefined), channel interface(s) and, when desired, optional features and functions are added to construct the service desired. Each of the components of the service are described in this section. Terms, conditions, and rates for Physical Collocation Cross-Connects and Virtual Access Collocation Cross-Connects are set forth in Section E13. of this Tariff for those services that are permitted to connect directly to a carrier's collocation space.

**Note 1:** Effective June 30, 2021, this Service will no longer be available for purchase by new or existing customers. In addition, requests to move, add, change, or renew existing service arrangements will not be accepted. Following the expiration of a customer's existing term agreement, service will be provided on a month-to-month basis at the applicable Monthly rates until the service is discontinued. The Company currently plans to discontinue this service on or after June 30, 2024.

**Note 2:** Effective on or after December 1, 2021, neither new nor existing customers will be permitted to purchase new SMARTRing Service (Service). In addition, (A) Service Payment Plans greater than 12-months in length will no longer be available; and (B) requests to move, add, change, upgrade, or downgrade existing service arrangements will not be accepted, with the following exceptions: (1) existing customers will be permitted to modify their existing Service and will be able to add new circuits to their existing Service, but will not be permitted to add new nodes in any locations; and (2) any such new circuits will be subject to the customer's existing term payment plan or term agreement for the Service to which they are added. Following the expiration of a customer's existing term agreement, Service will be provided on a month-to-month basis at the applicable Month-to-Month rates until the Service is discontinued.

(N)

Effective November 30, 2023, unless specified to the contrary in their existing Service agreements, existing customers may not renew Term Payment Plans or term agreements for Service. In addition, no move, add, or change orders of any type will be accepted.

(N)

## E7. DEDICATED ACCESS SERVICES

### E7.2 Service Description (Cont'd)

The channel description specifies the characteristics of the basic channel and indicates whether the channel is provided between customer designated premises or between a customer designated premises and a Company hub where bridging and/or channelization functions are performed.

Information pertaining to the technical specifications packages indicates the transmission parameters that are available with each package. This information is displayed in a matrix found in each service description (e.g., VG matrix in E7.2.3.B. following) with the transmission parameters listed down the left side and the packages listed across the top. Each package is identified by a code, e.g., VG1. The first two letters of the code indicate the category of Dedicated Access Services to which the parameters are applicable. These two-letter codes are shown preceding in parentheses following the category of Dedicated Access Services. The number "1" following the two-letter code indicates the technical specifications package for a service. A numeric or alpha-numeric designation following the two letter code indicates the specific predefined package. When appropriate, the Technical Reference which contains detailed specifications for the parameters is shown following the matrix.

Channel interfaces at each point of termination on a two-point service may be symmetrical or asymmetrical. On a multipoint service they may also be symmetrical or asymmetrical. However, communications can only be provided between points of termination with compatible channel interfaces. Only certain channel interfaces are compatible. These are set forth in a combination format.

Only certain channel interface combinations are available with the predefined technical specifications packages. These are delineated in the Technical References set forth herein.

The optional features and functions available with each type of Dedicated Access Services are described in this section. The optional features and functions information also indicates with which technical specifications packages they are available. Such information is displayed in a matrix with the optional feature or function listed down the left side and the technical specifications package listed across the top.

The Company will maintain existing transmission specifications on services installed prior to the effective date of this Tariff, except that the existing services with performance specifications exceeding the standard listed in this provision will be maintained at the performance levels specified in this Tariff.

All services installed after the effective date of this Tariff will conform to the transmission specification standards contained in this Tariff or in the following Technical References for such category of service:

Telegraph Grade <sup>1</sup> (a.k.a. BellSouth SPA Telegraph)	TR-NPL-000336	(C)
Voice Grade <sup>1</sup> (a.k.a. BellSouth SPA DSO VG)	TR-NPL-000335	(C)
Digital Data <sup>1</sup> (a.k.a. BellSouth SPA DSO Digital Data)	TR-NPL-000341	(C)
For 2.4, 4.8,9.6 and 56.0 Kbps	BellCore PUB 62310	
For 19.2 Kbps	INC. BULLETIN CB-INC-100	
For 64.0 Kbps	AT&T PUB 62310	
High Capacity (a.k.a. BellSouth SPA High Capacity)	TA-TSY-000342 TR-NPL-000054	
<b>(DELETED)</b>		
Derived Data Channel <sup>1</sup> (a.k.a. BellSouth SPA Derived Data Channel) Service	BellSouth TR-73548 BellSouth TR-73548, Addendum 1	(C)

Note 1: Effective June 30, 2021, this Service will no longer be available for purchase by new or existing customers. In addition, requests to move, add, change, or renew existing service arrangements will not be accepted. Following the expiration of a customer's existing term agreement, service will be provided on a month-to-month basis at the applicable Monthly rates until the service is discontinued. The Company currently plans to discontinue this service on or after June 30, 2024.



## E7. DEDICATED ACCESS SERVICES

### E7.2 Service Description (Cont'd)

#### E7.2.1 Reserved for Future Use

#### E7.2.2 Telegraph Grade<sup>2</sup> (a.k.a. BellSouth SPA Telegraph) Service

(C)

##### A. Basic Channel Description

A Telegraph Grade (a.k.a. BellSouth SPA Telegraph) channel is an unconditioned channel capable of transmitting binary signals at rates of 0-75 baud or 0-150 baud. This channel is furnished for half-duplex or duplex operation. Telegraph Grade (a.k.a. BellSouth SPA Telegraph) channels are provided between customer designated premises or between a customer designated premises and a Company Hub. Telegraph Grade service is not available for additions, new installations or moves of service.

##### B. Technical Specifications Packages

Parameter	TG Matrix	
	1	2
Telegraph Distortion	X	X

The technical specifications are delineated in Technical Reference TR-NPL-000336.

##### C. Channel Interfaces

Compatible channel interfaces are set forth in Technical Reference TR-NPL-000336.

##### D. Optional Features and Functions

###### 1. Telegraph Bridging (two-wire and four-wire)

The following table shows the technical specifications packages with which the optional features and functions are available.

	Available with Technical Specifications Package TG-	
	1	2
Telegraph Bridging	X	X

#### E7.2.3 Voice Grade (a.k.a. BellSouth SPA DS0 VG) Service<sup>1, 2</sup>

(C)

##### A. Basic Channel Description

A Voice Grade (a.k.a. BellSouth SPA DS0 VG) channel is a channel which provides voice frequency transmission capability in the normal frequency range of 300 to 3000 Hz and may be terminated two-wire or four-wire. Voice Grade (a.k.a. BellSouth SPA DS0 VG) channels are provided between customer designated premises or between a customer designated premises and a Company Hub.

Voice Grade (a.k.a. BellSouth SPA DS0 VG) channels are classified as Voice Grade/Voice or Voice Grade/Data depending on the suitability of the technical specification package requested by the customer. Voice Grade (a.k.a. BellSouth SPA DS0 VG) technical specification packages 1, 2, 3, 4, 5, 7, 8, 9, 11 and 12 are suitable for Voice Grade/Voice. Technical specification packages 6 and 10 are suitable for Voice Grade/Data service.

**Note 1:** Effective September 30, 2017, Voice Grade (a.k.a. BellSouth SPA DS0 VG) service in the Kings Point, Florida Telephone Company wire center is no longer available.

**Note 2:** Effective June 30, 2021, this Service will no longer be available for purchase by new or existing customers. In addition, requests to move, add, change, or renew existing service arrangements will not be accepted. Following the expiration of a customer's existing term agreement, service will be provided on a month-to-month basis at the applicable Monthly rates until the service is discontinued. The Company currently plans to discontinue this service on or after June 30, 2024.

(N)

(N)

## E7. DEDICATED ACCESS SERVICES

### E7.2 Service Description (Cont'd)

#### E7.2.3 Voice Grade (a.k.a. BellSouth SPA DS0 VG) Service<sup>2,3</sup> (Cont'd)

(C)

##### B. Technical Specifications Packages

Parameter	VG Matrix												
	1	2	3	4	5	6	7	8	9	10	11	12	
Attenuation Distortion	X	X	X	X	X	X	X	X	X	X	X	X	X
C-Message Noise	X	X	X	X	X	X	X	X	X	X	X	X	X
Echo Control	X	X	X		X		X	X			X	X	
Envelope Delay													
Distortion						X	X	X	X	X	X	X	X
Frequency Shift						X	X	X	X	X	X	X	X
Impulse Noise					X	X	X	X	X	X	X	X	X
Intermodulation													
Distortion						X	X	X	X	X	X	X	X
Loss Deviation	X	X	X	X	X	X	X	X	X	X	X	X	X
Phase Jitter						X	X	X	X	X	X	X	X
Signal-to-C													
Message Noise				X									
Signal-to-C													
Notch Noise					X	X	X	X	X	X	X	X	X

The technical specifications for these parameters are delineated in Technical Reference TR-NPL-000335 and associated Addendum.

##### C. Channel Interfaces<sup>1</sup>

The following channel interfaces for Voice Grade (a.k.a. BellSouth SPA DS0 VG) service do not require signaling capability: DA, DB, DD, DE, DS, NO, PR and TF.

**Note 1:** Channel Interface Codes are found in E7.3.1 following.

**Note 2:** Effective September 30, 2017, Voice Grade (a.k.a. BellSouth SPA DS0 VG) service in the Kings Point, Florida Telephone Company wire center is no longer available.

**Note 3:** Effective June 30, 2021, this Service will no longer be available for purchase by new or existing customers. In addition, requests to move, add, change, or renew existing service arrangements will not be accepted. Following the expiration of a customer's existing term agreement, service will be provided on a month-to-month basis at the applicable Monthly rates until the service is discontinued. The Company currently plans to discontinue this service on or after June 30, 2024.

(N)  
 |  
 (N)

## E7. DEDICATED ACCESS SERVICES

### E7.2 Service Description (Cont'd)

#### E7.2.3 Voice Grade (a.k.a. BellSouth SPA DS0 VG) Service<sup>5, 6</sup> (Cont'd)

(C)

C. Channel Interfaces<sup>1</sup>(Cont'd)

The following channel interfaces for Voice Grade (a.k.a. BellSouth SPA DS0 VG) service require signaling capability: AB, AC, CT, DX, EA, EB, EC, EX, GO, GS, LA, LB, LC, LO, LR, LS, RV and SF.

Compatible channel interfaces are set forth in Technical Reference TR-NPL-000054 and Associated Addendum.

D. Optional Features and Functions

1. Central Office Bridging Capability

- a. Voice Bridging<sup>2</sup> (two-wire and four-wire)
- b. Data Bridging<sup>3</sup> (two-wire and four-wire)
- c. Telephoto Bridging<sup>4</sup> (two-wire and four-wire)
- d. Dataphone<sup>®</sup> Select-A-Station Bridging with sequential arrangement ports or addressable arrangement ports
- e. Telemetry and Alarm Bridging  
- Split Band, Active Bridging

2. Conditioning

Conditioning provides more specific transmission characteristics for Voice Grade (a.k.a. BellSouth SPA DS0 VG) services. C-Type conditioning controls attenuation distortion and envelope delay distortion. Sealing Current helps maintain continuity on dry metallic<sup>6</sup> loops.

(C)

In addition, a customer may desire that either the attenuation distortion or the envelope delay distortion, or both, be improved to more stringent specifications than those provided for C-Type conditioning. In such cases the customer has the option of ordering Improved Attenuation Distortion and/or Improved Envelope Delay Distortion.

For two-point services, the parameters apply to each service. For multipoint services, the parameters apply to each mid link or end link. C-Type conditioning and D-Conditioning may be combined on the same service.

a. C-Type Conditioning

C-Type Conditioning is provided for the additional control of attenuation distortion and envelope delay distortion on data services. The attenuation distortion and envelope delay distortion specifications for C-Type Conditioning are:

**Note 1:** Channel Interface Codes are found in E7.3.1 following.

**Note 2:** Voice Bridging is intended for use with VG2, 5, and 12, however, it may be used on VG6 and VG10 at a customer's request.

**Note 3:** Data Bridging is intended for use with VG6 and VG10, however, it may be used on VG2, 5, and 12 at a customer's request.

**Note 4:** Telephoto Bridging is intended for use on VG-11.

**Note 5:** Effective September 30, 2017, Voice Grade (a.k.a. BellSouth SPA DSO VG) service in the Kings Point, Florida Telephone Company wire center is no longer available.

**Note 6:** Effective June 30, 2021, this Service will no longer be available for purchase by new or existing customers. In addition, requests to move, add, change, or renew existing service arrangements will not be accepted. Following the expiration of a customer's existing term agreement, service will be provided on a month-to-month basis at the applicable Monthly rates until the service is discontinued. The Company currently plans to discontinue this service on or after June 30, 2024.

(N)

(N)

## E7. DEDICATED ACCESS SERVICES

### E7.2 Service Description (Cont'd)

#### E7.2.3 Voice Grade (a.k.a. BellSouth SPA DS0 VG) Service<sup>1, 2</sup> (Cont'd)

(C)

D. Optional Features and Functions (Cont'd)

2. Conditioning (Cont'd)

a. C-Type Conditioning (Cont'd)

Attenuation Distortion (Frequency Response) Relative to 1004 Hz

Frequency Range (Hz)	Variation (dB)
504 - 2804	-1.0 to + 3.0
304 - 3004	- 2.0 to + 6.0

Envelope Delay Distortion

Frequency Range (Hz)	Variation (micro-seconds)
1004 - 2604	Less Than 501
604 - 2604	Less Than 1501
504 - 2804	Less Than 3001

b. Improved Attenuation Distortion

Improved attenuation distortion is provided for additional control of attenuation distortion. The improved attenuation distortion specifications are:

Attenuation Distortion (Frequency Response) Relative to 1004 Hz

Frequency Range (Hz)	Variation (dB)
404-2804	-1.0 to +2.0
304-3004	-1.0 to +3.0
3004-3204	-2.0 to +6.0

c. Improved Envelope Delay Distortion

Improved envelope delay distortion is provided for additional control of envelope distortion. The improved envelope delay distortion specifications are:

Envelope Delay Distortion

Frequency Range (Hz)	Variation (micro-seconds)
1001-2604	Less Than 101
604-2604	Less Than 301
504-2804	Less Than 3001

**Note 1:** Effective September 30, 2017, Voice Grade (a.k.a. BellSouth SPA DSO VG) service in the Kings Point, Florida Telephone Company wire center is no longer available.

**Note 2:** Effective June 30, 2021, this Service will no longer be available for purchase by new or existing customers. In addition, requests to move, add, change, or renew existing service arrangements will not be accepted. Following the expiration of a customer's existing term agreement, service will be provided on a month-to-month basis at the applicable Monthly rates until the service is discontinued. The Company currently plans to discontinue this service on or after June 30, 2024.

(N)  
 |  
 (N)

## E7. DEDICATED ACCESS SERVICES

### E7.2 Service Description (Cont'd)

#### E7.2.3 Voice Grade (a.k.a. BellSouth SPA DS0 VG) Service<sup>1, 2</sup> (Cont'd)

D. Optional Features and Functions (Cont'd)

2. Conditioning (Cont'd)

d. Sealing Current Conditioning

Sealing Current Conditioning is provided to help maintain continuity on dry metallic<sup>2</sup> loops. It is usually associated with four-wire DA or NO type channel interfaces.

3. Customer Specified Premises Receive Level

This option allows the customer to specify the receive level at the Point of Termination. The level must be within a specific range of effective four-wire transmission. The ranges are delineated in Technical Reference TR-NPL-000335.

4. Echo Control

a. Improved Return Loss

On Effective Two-Wire Transmission at Two-Wire Point of Termination: Provides for more stringent Echo Control specifications. In order for this option to be applicable, the transmission path must be four-wire at one POT and two-wire at the other POT. Placement of Company equipment may be required at the customer's premises with the two-wire POT. The Improved Return Loss parameters are delineated in Technical Reference TR-NPL-000335.

b. ELEPL 2 (Equal Level Echo Path Loss)

Specified at the Four-Wire Point of Termination and provides for more stringent Echo Control. In order for this option to be applicable, the interface must be two-wire at one Point of Termination (POT) and four-wire at the other POT. The ELEPL 2 parameters are delineated in Technical Reference TR-NPL-000335.

5. D-Conditioning

D-Conditioning provides transmission characteristics suitable for data communications. Specifically, D-Conditioning provides for the control of Signal to C-Notched Noise Ratio and intermodulation distortion. It is available for two-point services or multipoint services. This option is available for use with Technical Specification Packages VG6, VG7 and VG10 on Two-Point Multipoint Services. (However, it is not recommended for use with Multipoint.)

D-Conditioning transmission characteristics are described in Technical Reference TR-NPL-000335 under the name Data Capability.

The signal to C-Notched Noise Ratio and intermodulation distortion parameters for D-Conditioning are:

- Signal to C-Notched Noise Ratio is equal to or greater than 32dB

- Intermodulation distortion:

- Signal to second order modulation products (R2) is equal to or greater than 38dB

- Signal to third order modulation products (R3) is equal to or greater than 42dB

**Note 1:** Effective September 30, 2017, Voice Grade (a.k.a. BellSouth SPA DSO VG) service in the Kings Point, Florida Telephone Company wire center is no longer available.

**Note 2:** Effective June 30, 2021, this Service will no longer be available for purchase by new or existing customers. In addition, requests to move, add, change, or renew existing service arrangements will not be accepted. Following the expiration of a customer's existing term agreement, service will be provided on a month-to-month basis at the applicable Monthly rates until the service is discontinued. The Company currently plans to discontinue this service on or after June 30, 2024.

(C)

(C)

(N)

(N)

## E7. DEDICATED ACCESS SERVICES

### E7.2 Service Description (Cont'd)

#### E7.2.3 Voice Grade (a.k.a. BellSouth SPA DS0 VG) Service<sup>1,2</sup> (Cont'd)

(C)

D. Optional Features and Functions (Cont'd)

5. D-Conditioning (Cont'd)

When a service equipped with D-Conditioning and is used for voice communications, the quality of the voice transmission may not be satisfactory.

6. Telephoto Conditioning

Telephoto Conditioning provides transmission characteristics suitable for telephotographic communications. Specifically, Telephoto Conditioning is provided for the control of attenuation distortion and envelope delay distortion parameters for Telephoto Conditioning are:

**Attenuation Distortion  
(2204 Hz Reference)**

**Frequency Variation  
Range (Hz) (dB)**

304 - 3204 - 1.0 to + 2.5

504 - 3004 - 0.5 to + 1.5

**Envelope Delay Distortion**

**Frequency Variation  
Range (Hz) (mcs)**

1004 - 2604 Less Than 111

804 - 2804 Less Than 181

7. Signaling Capability

Signaling Capability provides for the process by which one customer premises alerts another customer premises on the same service with which it wishes to communicate.

8. Improved Termination

The Improved Termination option provides a fixed 600 ohm impedance, a variable level range and simplex reversal, when applicable, at the point of termination. Company equipment is required at the customer's premises when this option is ordered. The Improved Termination parameters are delineated in Technical Reference TR-NPL-000335.

9. Simplex Reversal

The Simplex Reversal option physically turns over the simplex DC path presented at the four-wire point of termination when LO, LS, GO, GS, & DX signaling is provided at the point of termination.

10. FlexServ Service (a.k.a. BellSouth SPA Customer Reconfiguration)

FlexServ service (a.k.a. BellSouth SPA Customer Reconfiguration) provides the customer the ability to monitor and reconfigure Voice Grade (a.k.a. BellSouth SPA DS0 VG) service provided by the Company. FlexServ service (a.k.a. BellSouth SPA Customer Reconfiguration) is described in E7.4.12 following. Charges for this feature are contained in E7.5.16. following.

**Note 1:** Effective September 30, 2017, Voice Grade (a.k.a. BellSouth SPA DSO VG) service in the Kings Point, Florida Telephone Company wire center is no longer available.

**Note 2:** Effective June 30, 2021, this Service will no longer be available for purchase by new or existing customers. In addition, requests to move, add, change, or renew existing service arrangements will not be accepted. Following the expiration of a customer's existing term agreement, service will be provided on a month-to-month basis at the applicable Monthly rates until the service is discontinued. The Company currently plans to discontinue this service on or after June 30, 2024.

(N)  
|  
(N)

## E7. DEDICATED ACCESS SERVICES

### E7.2 Service Description (Cont'd)

#### E7.2.3 Voice Grade (a.k.a. BellSouth SPA DS0 VG) Service<sup>1,2</sup> (Cont'd)

(C)

##### D. Optional Features and Functions (Cont'd)

The following table shows the technical specifications packages with which the optional features and functions are available.

	Available with Technical Specifications Package VG-											
	1	2	3	4	5	6	7	8	9	10	11	12
C-Type Conditioning					X	X	X	X	X	X		
Improved Attenuation Distortion					X	X	X	X	X	X		
Improved Envelope Delay Distortion					X	X	X	X	X	X		
Sealing Current Conditioning							X					
D-Conditioning						X	X			X		
Central Office Bridging		X			X	X				X	X	X
Customer Specified Premises Receive Level		X	X				X	X	X			
Echo Control Improved Return Loss			X	X			X					
ELEPL2	X	X	X		X		X					
FlexServ Service (a.k.a. BellSouth SPA Customer Reconfiguration)	X	X	X	X	X	X	X	X	X	X	X	X
Improved Termination	X	X	X	X	X	X	X	X	X	X	X	X
Simplex Reversal	X	X	X				X	X	X			
Signaling Capability	X	X	X				X	X	X			
Telephoto Conditioning											X	

**Note 1:** Effective September 30, 2017, Voice Grade (a.k.a. BellSouth SPA DSO VG) service in the Kings Point, Florida Telephone Company wire center is no longer available.

**Note 2:** Effective June 30, 2021, this Service will no longer be available for purchase by new or existing customers. In addition, requests to move, add, change, or renew existing service arrangements will not be accepted. Following the expiration of a customer's existing term agreement, service will be provided on a month-to-month basis at the applicable Monthly rates until the service is discontinued. The Company currently plans to discontinue this service on or after June 30, 2024.

(N)  
 |  
 (N)

## E7. DEDICATED ACCESS SERVICES

### E7.2 Service Description (Cont'd)

#### E7.2.3 Voice Grade (a.k.a. BellSouth SPA DS0 VG) Service<sup>1,2</sup> (Cont'd)

(C)

##### E. Four-Wire/Two-Wire Conversions

When a customer requests that an effective four-wire channel be terminated with a two-wire channel interface at the customer designated premises, a four-wire to two-wire conversion of the four-wire local channel is required. The rate for the conversion is included as part of the basic Local Channel rate.

#### E7.2.4 Reserved for Future Use

#### E7.2.5 Digital Data Access<sup>2</sup> (a.k.a. BellSouth SPA DS0 Digital Data) Service

(C)

##### A. Basic Channel Description

A Digital Data (a.k.a. BellSouth SPA DS0 Digital Data) channel is a channel for four-wire transmission of synchronous serial data at the rate of 2.4, 4.8, 9.6, 19.2, 56, or 64 Kbps. The actual bit rate is a function of the channel interface and channel selected by the customer. The channel provides a synchronous service with timing provided by the Company through the Company's facilities to the customer in the received bit stream. Digital Data (a.k.a. BellSouth SPA DS0 Digital Data) channels are only available via Company designated Digital Data (a.k.a. BellSouth SPA DS0 Digital Data) Hubs and are provided between customer designated premises or between a customer designated premises and a Company Digital Data (a.k.a. BellSouth SPA DS0 Digital Data) Hub.

A Hub Termination Charge applies per Digital Data (a.k.a. BellSouth SPA DS0 Digital Data) Local Channel. This rate element covers the Hub functions (e.g., Timing, Testing) for the service.

Secondary Channel Capability (SCC) is a derived companion digital transmission path that is independent of the primary data path and operates at a substantially lower bit rate. This derived channel allows the customer to perform network management functions during the normal operation of the network. This diagnostics channel utilizes a portion of a customer's previously unavailable data bit stream allowing for the ability to remotely control and test the network and peripheral devices without taking the network out of service. Special customer equipment is necessary to utilize the benefits of the Secondary Channel. Customers not wishing to utilize this capability will not be impacted. Due to transmission equipment restrictions. Secondary Channel cannot be provided on 56 Kbps circuits that require the installation of loop repeater equipment for provision of service. Secondary Channel Capability, also, cannot be provided on 64 Kbps circuits, since all of the available bit stream will be used by the customer.

The customer may provide the Channel Service Unit-type equipment or other Network Channel Terminating Equipment associated with the Digital Data (a.k.a. BellSouth SPA DS0 Digital Data) channel at the customer premises. The interim program for interconnection of such equipment is set forth in Technical Reference PUB AS No. 1.

**Note 1:** Effective September 30, 2017, Voice Grade (a.k.a. BellSouth SPA DSO VG) service in the Kings Point, Florida Telephone Company wire center is no longer available.

**Note 2:** Effective June 30, 2021, this Service will no longer be available for purchase by new or existing customers. In addition, requests to move, add, change, or renew existing service arrangements will not be accepted. Following the expiration of a customer's existing term agreement, service will be provided on a month-to-month basis at the applicable Monthly rates until the service is discontinued. The Company currently plans to discontinue this service on or after June 30, 2024.

(N)

(N)



## E7. DEDICATED ACCESS SERVICES

### E7.2 Service Description (Cont'd)

#### E7.2.5 Digital Data Access<sup>3</sup> (*a.k.a. BellSouth SPA DS0 Digital Data*) Service (Cont'd)

(C)

##### B. Technical Specifications Packages

Parameter	DA Matrix					
	1	2	3	4	5	6
Error-Free Seconds	X	X	X	X	X	X

The Company will provide a channel capable of meeting a monthly average performance equal to or greater than 99.875 percent error-free seconds<sup>1</sup> while the channel is in service, if it is measured through a CSU equivalent which is designed, manufactured, and maintained to conform with the interconnection specifications contained in Technical Reference PUB 62310.

Interface options and service objectives are as specified in Technical Reference TR-NPL-000341.

##### C. Channel Interfaces

The following channel interfaces (CIs) define the bit rates that are available for a Digital Data (*a.k.a. BellSouth SPA DS0 Digital Data*) channel:

CI	Bit Rate
DU-24(S) <sup>2</sup>	2.4 Kbps
DU-48(S) <sup>2</sup>	4.8 Kbps
DU-96(S) <sup>2</sup>	9.6 Kbps
DU-19(S) <sup>2</sup>	19.2 Kbps
DU-56(S) <sup>2</sup>	56.0 Kbps
DU-64	64.0 Kbps

Compatible channel interfaces are set forth in Technical Reference TR-NPL-000341.

##### D. Optional Features and Functions

1. Central Office Bridging Capability
2. Secondary Channel Capability
3. FlexServ<sup>®</sup> Service (*a.k.a. BellSouth SPA Customer Reconfiguration*)

FlexServ<sup>®</sup> service (*a.k.a. BellSouth SPA Customer Reconfiguration*) provides the customer the ability to monitor and reconfigure Digital Data Access (*a.k.a. BellSouth SPA DS0 Digital Data*) service provided by the Company. FlexServ<sup>®</sup> service (*a.k.a. BellSouth SPA Customer Reconfiguration*) is described in E7.4.12 following. Charges for this feature are contained in E7.5.16. following.

Note 1: This channel performance does not apply when the Data Over Voice Channel option is used.

Note 2: (S) is an additional BellSouth designation for use when the optional Secondary Channel feature is required.

Note 3: Effective June 30, 2021, this Service will no longer be available for purchase by new or existing customers. In addition, requests to move, add, change, or renew existing service arrangements will not be accepted. Following the expiration of a customer's existing term agreement, service will be provided on a month-to-month basis at the applicable Monthly rates until the service is discontinued. The Company currently plans to discontinue this service on or after June 30, 2024.

(N)  
 |  
 (N)

## E7. DEDICATED ACCESS SERVICES

### E7.2 Service Description (Cont'd)

#### E7.2.5 Digital Data Access<sup>1</sup> (*a.k.a. BellSouth SPA DS0 Digital Data*) Service (Cont'd)

(C)

- D. Optional Features and Functions (Cont'd)  
 4.

The following table shows the technical specifications packages with which the optional features and functions are available.

	Available with Technical Specifications Package DA-					
	1	2	3	4	5	6
Central Office Bridging Capability	X	X	X	X	X	
Secondary Channel Capability	X	X	X	X	X	
FlexServ <sup>®</sup> Service ( <i>a.k.a. BellSouth SPA Customer Reconfiguration</i> )	X	X	X	X	X	X

Note 1: Effective June 30, 2021, this Service will no longer be available for purchase by new or existing customers. In addition, requests to move, add, change, or renew existing service arrangements will not be accepted. Following the expiration of a customer's existing term agreement, service will be provided on a month-to-month basis at the applicable Monthly rates until the service is discontinued. The Company currently plans to discontinue this service on or after June 30, 2024.

(N)  
 |  
 (N)

## E7. DEDICATED ACCESS SERVICES

### E7.2 Service Description (Cont'd)

#### E7.2.6 High Capacity (*a.k.a. BellSouth SPA High Capacity*) Service

A. Basic Channel Description

A High Capacity (*a.k.a. BellSouth SPA High Capacity*) channel is a channel for the transmission of nominal 64.0 Kbps<sup>1, 2</sup> or 1.544, 3.152, 6.312, or 44.736 Mbps isochronous serial data. The actual bit rate is a function of the channel interface selected by the customer. High Capacity (*a.k.a. BellSouth SPA High Capacity*) channels are provided between customer designated premises or between a customer designated premises and a Company Hub. (C)

The customer may provide the Network Channel Terminating Equipment associated with the High Capacity (*a.k.a. BellSouth SPA High Capacity*) channel at the customer's premises. The interim program for interconnection of such equipment is set forth in Technical Reference PUB AS No. 1.

B. Technical Specifications Packages

Parameters	HC Matrix			
	0	1	1C	2 3
Error-Free Seconds		X		

A channel with technical specifications package HC1 will be capable of an error-free second performance of 98.75 percent over a continuous 24 hour period as measured at the 1.544 Mbps rate through a CSU equivalent which is designed to conform with the interconnection specifications contained in Technical Reference PUB 62411.

Further technical specifications are delineated in Technical Reference TA-TSY-000342.

C. Channel Interfaces

The following channel interfaces (CIs) define the bit rates that are available for a High Capacity (*a.k.a. BellSouth SPA High Capacity*) channel:

CI	Bit Rate
DS-15 <sup>2</sup>	1.544 Mbps (DS1)
DS-31	3.152 Mbps (DS1C)
DS-44	44.736 Mbps (DS3)
DS-63	6.312 Mbps (DS2)

Compatible channel interfaces are set forth in Technical Reference TR-TSY-000342.

Note 1: Available only as a cross connect (through connection) of two 2.4, 4.8, 9.6, 19.2, 56.0 or 64.0 Kbps channels of two 1.544 Mbps facilities to a Digital Data (*a.k.a. BellSouth SPA DSO Digital Data*) Hub(s). The customer must provide system and channel assignment data.

Note 2: Effective June 30, 2021, 64.0 Kbps will no longer be available for purchase by new or existing customers. In addition, requests to move, add, change, or renew existing service arrangements will not be accepted. Following the expiration of a customer's existing term agreement, service will be provided on a month-to-month basis at the applicable Monthly rates until the service is discontinued. The Company currently plans to discontinue this service on or after June 30, 2024. (N)

## E7. DEDICATED ACCESS SERVICES

### E7.2 Service Description (Cont'd)

#### E7.2.6 High Capacity (*a.k.a. BellSouth SPA High Capacity*) Service (Cont'd)

##### D. Optional Features and Functions

1.

2. Channelization

a. DS3 to DS1

An arrangement that channelizes a 44.736 Mbps channel to 28 DS1 channels.

b. DS2 to DS1

An arrangement that channelizes a 6.312 Mbps channel to four DS1 channels.

c. DS1C to DS1

An arrangement that channelizes a 3.152 Mbps channel to two DS1 channels

d. DS1 Basic Channelization System

An arrangement that channelizes a 1.544 Mbps channel to a maximum of twenty four 64 Kbps channels. A channel of this DS1 to the Hub can also be used for a Digital Data service. A DS1 Basic Channelization System requires a Central Office Channel Interface for each channel of lesser capacity.

e. DS0 Basic Channelization System<sup>1</sup>

An arrangement that channelizes a 64.0 Kbps channel to a subspeeds of up to twenty 2.4 Kbps, ten 4.8 Kbps, or five 9.6 Kbps channels. A DS0 Basic Channelization System requires a Central Office Channel Interface for each channel of lesser capacity.

(C)

3. Channel Interface

a. DS1 Level Central Office Channel Interface

An arrangement for the connection of DS1 (1.544 Mbps) channels of higher order DS3 (44.736 Mbps) services, in Company central office locations.

b. DS1 Level Customer Channel Interface

An arrangement for the connection of DS1 (1.544 Mbps) channels to higher order DS3 (44.736 Mbps) services, at customer locations.

c. DS0 Level Central Office Channel Interface<sup>1</sup>

An arrangement for the connection of VG/DS0 (2.4 - 64.0 Kbps) channels to higher order DS1 (1.544 Mbps) services, in Company central office locations.

(C)

Note 1: Effective June 30, 2021, this Service will no longer be available for purchase by new or existing customers. In addition, requests to move, add, change, or renew existing service arrangements will not be accepted. Following the expiration of a customer's existing term agreement, service will be provided on a month-to-month basis at the applicable Monthly rates until the service is discontinued. The Company currently plans to discontinue this service on or after June 30, 2024.

(N)

(N)

## E7. DEDICATED ACCESS SERVICES

### E7.2 Service Description (Cont'd)

#### E7.2.6 High Capacity (a.k.a. BellSouth SPA High Capacity) Service (Cont'd)

##### D. Optional Features and Functions (Cont'd)

##### 3. Channel Interface (Cont'd)

##### d. Subrate Level Central Office Channel Interface<sup>2</sup>

An arrangement for the connection of subrate (2.4 - 9.6 Kbps) channels to higher order DS0 (64.0 Kbps) services, in Company central office locations. (C)

##### 4. Clear Channel Capability

a. Clear Channel Capability (CCC) is an arrangement that alters a DS1/1.544 Mbps signal with unconstrained information bits, to meet pulse density requirements outlined in TR-NPL-000054 and TA-TSY-000342. This will allow a customer to transport an all zero octet over a DS1/1.544 Mbps High Capacity (a.k.a. **BellSouth SPA DS1**) channel, providing an available combined maximum 1.536 Mbps data rate. This arrangement requires the customer signal at the channel interface to conform to Bipolar with 8 Zero Substitution (B8ZS) line code as described in TR-NPL-000054 and TA-TSY-000342.

b. CCC is provided on DS1/1.544 Mbps High Capacity (a.k.a. **BellSouth SPA DS1**) channels between two customer designated premises, or between a customer designated premises and a Company Hub location, and is subject to the availability of facilities. This optional feature may be ordered at the same time the DS1/1.544 Mbps High Capacity (a.k.a. **BellSouth SPA DS1**) channel is ordered, or it may be ordered as an additional feature of an existing channel.

c. When providing CCC via a DS3/44.736 Mbps High Capacity (a.k.a. **BellSouth SPA DS3**) channel, that DS3 channel must be designated, in Company records, as having Clear Channel Capability prior to the provisioning of a DS1/1.544 Mbps High Capacity (a.k.a. **BellSouth SPA DS1**) channel with CCC. Customers must agree to out-of-service periods required to add this feature to; 1) an existing DS1/1.544 Mbps High Capacity (a.k.a. **BellSouth SPA DS3**) channel or 2) a DS3/44.736 Mbps High Capacity (a.k.a. **BellSouth SPA DS3**) channel which transports a DS1/1.544 Mbps High Capacity (a.k.a. **BellSouth SPA DS1**) channel, to be optioned for B8ZS.

##### 5. FlexServ<sup>®</sup> Service (a.k.a. BellSouth SPA Customer Reconfiguration)

FlexServ<sup>®</sup> service (a.k.a. **BellSouth SPA Customer Reconfiguration**) provides the customer the ability to monitor and reconfigure High Capacity (a.k.a. **BellSouth SPA High Capacity**) service provided by the Company. FlexServ<sup>®</sup> service (a.k.a. **BellSouth SPA Customer Reconfiguration**) is described in E7.4.12 following. Charges for this feature are contained in E7.5.16. following.

The following table shows the technical specifications packages with which the optional features and functions are available.

Available With Technical  
 Specifications Package HC-  
 0 1 1C 2 3

Channelization:				
DS3 to DS1				X
DS2 to DS1			X	
DS1C to DS1		X		
DS1 Basic Channelization System	X			
DS0 Basic Channelization System <sup>1,2</sup>	X			
Clear Channel Capability		X		
FlexServ <sup>®</sup> Service (a.k.a. <b>BellSouth SPA Customer Reconfiguration</b> )	X	X		

Note 1: Available only on 64 Kbps DDAS (a.k.a. **BellSouth SPA DS0 Digital Data**) service or on a DS1 (1.544 Mbps) channel with Clear Channel Capability to a Company Hub. (C)

Note 2: Effective June 30, 2021, this Service will no longer be available for purchase by new or existing customers. In addition, requests to move, add, change, or renew existing service arrangements will not be accepted. Following the expiration of a customer's existing term agreement, service will be provided on a month-to-month basis at the applicable Monthly rates until the service is discontinued. The Company currently plans to discontinue this service on or after June 30, 2024. (N)

Material appearing on this page previously appeared on page(s) 23 of this section.

<sup>®</sup>Registered Service Mark of BellSouth Corporation

## E7. DEDICATED ACCESS SERVICES

### E7.2 Service Description (Cont'd)

#### E7.2.7 Reserved for Future Use

#### E7.2.8 Reserved for Future Use

#### E7.2.9 Reserved for Future Use

#### E7.2.10 Reserved for Future Use

#### E7.2.11 Reserved for Future Use

#### E7.2.12 SMARTPath<sup>®</sup> Service (a.k.a. BellSouth SPA Shared Ring)

##### A. Service Description

SMARTPath<sup>®</sup> service (a.k.a. BellSouth SPA Shared Ring) is a shared high capacity network service capable of providing a 1.544 Mbps transport link with high performance and reliability parameters and a level of redundancy/diversity designed to limit a single event from interrupting service. This service is available only in those locations within specified SMARTPath<sup>®</sup> service (a.k.a. BellSouth SPA Shared Ring) Areas which the Company determines can be incorporated into the SMARTPath<sup>®</sup> service (a.k.a. BellSouth SPA Shared Ring) network enabling the Company to provide the specified level of performance and reliability. For locations where a customer requests SMARTPath<sup>®</sup> service (a.k.a. BellSouth SPA Shared Ring) and facilities are not available, special construction charges will apply as set forth in Section E14. following. SMARTPath<sup>®</sup> service (a.k.a. BellSouth SPA Shared Ring) Areas are identified in the NATIONAL EXCHANGE CARRIER (NECA) TARIFF F.C.C. No.4.

SMARTPath<sup>®</sup> service (a.k.a. BellSouth SPA Shared Ring) provides a transport link between a customer designated premises where the network is accessed and (1) another customer designated premises, in the same SMARTPath<sup>®</sup> service (a.k.a. BellSouth SPA Shared Ring) Area or (2) a serving wire center in the same SMARTPath<sup>®</sup> service (a.k.a. BellSouth SPA Shared Ring) Area for connection to (a) DS1 Basic Channelization, FlexServ<sup>®</sup> service (a.k.a. BellSouth SPA Customer Reconfiguration), SmartRing<sup>®</sup> service (a.k.a. BellSouth Dedicated Ring), or DS3 service as provided in Section E7. of this Tariff, BellSouth Virtual Expanded Interconnection Services under Section E20. of this Tariff, or (b) a SMARTPath<sup>®</sup> service (a.k.a. BellSouth SPA Shared Ring) Area Junction of another SMARTPath<sup>®</sup> service (a.k.a. BellSouth SPA Shared Ring) area in the same Metropolitan Area. (C)

**Note 1:** Effective on or after December 1, 2021, neither new nor existing customers will be permitted to purchase new SMARTRing Service (Service). In addition, (A) Service Payment Plans greater than 12-months in length will no longer be available; and (B) requests to move, add, change, upgrade, or downgrade existing service arrangements will not be accepted, with the following exceptions: (1) existing customers will be permitted to modify their existing Service and will be able to add new circuits to their existing Service, but will not be permitted to add new nodes in any locations; and (2) any such new circuits will be subject to the customer's existing term payment plan or term agreement for the Service to which they are added. Following the expiration of a customer's existing term agreement, Service will be provided on a month-to-month basis at the applicable Month-to-Month rates until the Service is discontinued. (N)

Effective November 30, 2023, unless specified to the contrary in their existing Service agreements, existing customers may not renew Term Payment Plans or term agreements for Service. In addition, no move, add, or change orders of any type will be accepted. (N)

## E7. DEDICATED ACCESS SERVICES

### E7.2 Service Description (Cont'd)

#### E7.2.12 SMARTPath® Service (a.k.a. BellSouth SPA Shared Ring) (Cont'd)

##### A. Service Description (Cont'd)

The technical specifications and standard network interfaces for SMARTPath® service (a.k.a. BellSouth SPA Shared Ring) are contained in BellSouth Telecommunications, Inc. Technical Reference Publication 73575. This publication is available from BellSouth Services Documentation Operations, North W5A1, 3535 Colonnade Parkway, Birmingham, Alabama 35243.

DS1s carried over Synchronous Optical Network (SONET) transport systems can incur phase transients as a result of pointer adjustments. In some instances timing problems could surface in customer's equipment with Stratum 3 or better clocks. This may result in the customer's clock disqualifying its synchronization reference, generating an alarm and/or selecting an alternate reference or entering holdover. To insure proper operation, channelized DS1 circuits must comply with Bellcore Technical Advisory, TA-NWT-000436, Digital Synchronization Network Plan, and ANSI T1.101-1994. When timing is taken from a Company transported DS1, the customer's equipment must be capable of accommodating SONET pointer adjustments.

##### B. Performance Objectives

ANSI T1.403-1989 Extended SuperFrame Format (ESF) is required on all circuits in order to assure performance objectives. The performance objectives for SMARTPath® service (a.k.a. BellSouth SPA Shared Ring) are as follows:

1. Meet or exceed 99.99 percent Circuit Availability on a monthly basis. This objective applies except where a customer's equipment is disconnected and/or inoperative.
2. Meet or exceed 99.95 percent Error Free Seconds on a monthly basis.
3. Meet or exceed .009 percent Severely Errored Seconds on a monthly basis.

##### C. Performance Guarantee

The performance guarantee for SMARTPath® service (a.k.a. BellSouth SPA Shared Ring) is as follows:

1. Service Continuity - in the event of primary facility failure, service is guaranteed to switch to an alternate facility path in sixty (60) seconds or less. Failure to meet this guarantee will result in a credit as described in E2.4.4.B.7. preceding, where the trouble is in the network.

(M)

Material previously appearing on this page now appears on page(s) 24.1 of this section.

\* Registered Service Mark of BellSouth Corporation

BELLSOUTH  
TELECOMMUNICATIONS  
FLORIDA  
ISSUED: October 10, 2014  
BY: Joe York, President -FL  
Jacksonville, Florida

ACCESS SERVICES TARIFF

Second Revised Page 24.1  
Cancels First Revised Page 24.1

EFFECTIVE: October 11, 2014

**E7. DEDICATED ACCESS SERVICES**

**E7.2 Service Description (Cont'd)**

**E7.2.13 Reserved for Future Use**

**E7.2.14 Reserved for Future Use**

(T)  
(T)  
(D)

\_\_\_\_\_

(D)

\* Service Mark of BellSouth Corporation



BELLSOUTH  
TELECOMMUNICATIONS, INC.  
FLORIDA  
ISSUED: November 30, 2001  
BY: Joseph P. Lacher, President -FL  
Miami, Florida

ACCESS SERVICES TARIFF

Third Revised Page 25  
Cancels Second Revised Page 25

EFFECTIVE: December 30, 2001

**E7. DEDICATED ACCESS SERVICES**

**E7.2 Service Description (Cont'd)**

**E7.2.14 (DELETED)**

(D)

## E7. DEDICATED ACCESS SERVICES

### E7.2 Service Description (Cont'd)

#### E7.2.14 (DELETED)

#### E7.2.15 Derived Data Channel<sup>1</sup> (a.k.a. BellSouth SPA Derived Data Channel) Service (C)

##### A. Basic Service Description

Derived Data Channel (a.k.a. BellSouth SPA Derived Data Channel) service (DDCS) provides full-duplex asynchronous or synchronous data transmission utilizing data over voice and subrate<sup>1</sup> multiplexing technology. DDCS (a.k.a. BellSouth SPA Derived Data Channel) provides simultaneous data and voice transmissions over the customer's existing two-wire local exchange facility. A derived data channel is provided between the customer's premises and the customer's serving wire center. (C)

At the customer's serving wire center the data/voice terminating equipment provides subrate<sup>1</sup> multiplexing into a standard DS0-B interface for a group composed of a maximum of twenty derived data channels. The customer's derived data channel must be associated with a DS0-B interface. This association requires coordination between the subscriber of the derived data channel and the subscriber of the DS0-B interface. An interoffice channel is provided for interconnection of the subrate<sup>1</sup> multiplexed DS0-B interface to the serving wire center of a customer designated premises. (C)

DDCS (a.k.a. BellSouth SPA Derived Data Channel) is provided subject to the availability of appropriate network facilities and equipment and subject to the transmission limitations of the facilities and equipment used by the Company. (C)

The customer will be responsible for selecting his own Customer Premises Equipment (CPE). CPE must be compatible with the Company provided terminating equipment at the serving wire center.

##### B. Channel Interfaces

The following channel interface (CI) is available for DDCS (a.k.a. BellSouth SPA Derived Data Channel).

CI	Bit Rate	
2DV5.BA	2.4 Kbps, Digital Data Over Voice <sup>1</sup>	(C)

Note 1: Effective June 30, 2021, this Service will no longer be available for purchase by new or existing customers. In addition, requests to move, add, change, or renew existing service arrangements will not be accepted. Following the expiration of a customer's existing term agreement, service will be provided on a month-to-month basis at the applicable Monthly rates until the service is discontinued. The Company currently plans to discontinue this service on or after June 30, 2024. (N)

## E7. DEDICATED ACCESS SERVICES

### E7.2 Service Description (Cont'd)

#### E7.2.15 Derived Data Channel<sup>(2)</sup> (a.k.a. BellSouth SPA Derived Data Channel) Service (Cont'd)

##### B. Channel Interfaces (Cont'd)

The following channel interface (CI) is available for DDCS (a.k.a. BellSouth SPA Derived Data Channel). (Cont'd)  
Compatible channel interface specifications are contained in BellSouth Technical Reference Publication 73548 for data/voice multiplexing equipment and BellSouth Technical Reference 73548, Addendum 1, for the DS0-B interface. These publications are available from the Information Exchange Manager, BellSouth Telecommunications, Inc., Documentations Operations, North W5A1, 3535 Colonnade Parkway, Birmingham, Alabama 35243.

#### E7.2.16 SMARTRing<sup>(3)</sup> service (a.k.a. BellSouth Dedicated Ring)

##### A. Self-healing Multi-nodal Alternate Route Topology Ring

1. SMARTRing<sup>(3)</sup> service (a.k.a. BellSouth Dedicated Ring) is a dedicated, high capacity, network designed to provide increased reliability and functionality via a self-healing ring topology between multiple customer designated locations and Telephone Company Central Offices where facilities can be made available as determined by the Company. This network consists of fiber routed through local, alternate central office, internodal and/or interoffice channel facilities that transmit DS1, DS3, STS-1, OC-3, OC-12, OC-48 and/or 1000 Mbps channel services simultaneously over primary and alternate paths between customer designated locations and Telephone Company Central Offices. This ring topology will continually monitor DS1, DS3, STS-1, OC-3, OC-12, OC-48 and/or 1000 Mbps service quality, detect any failure within the system, and automatically self-heal around a point of failure to ensure the flow of DS1, DS3, STS-1, OC-3, OC-12, OC-48 and/or 1000 Mbps services between locations within the network.
2. SMARTRing<sup>(3)</sup> service (a.k.a. BellSouth Dedicated Ring) is available at OC-1, OC-3, OC-3+ OC-12, OC-48, OC-48+, OC-192 and OC-192+ capacities.
3. OC-1 SMARTRing<sup>(3)</sup> service (a.k.a. BellSouth Dedicated Ring) is available only in Overlay Ring Arrangements riding the customer's host OC-12, OC-48, or OC-48+ SMARTRing<sup>(3)</sup> service (a.k.a. BellSouth Dedicated Ring). The OC-1 SMARTRing<sup>(3)</sup> service (a.k.a. BellSouth Dedicated Ring) shares the transport of its host SMARTRing<sup>(3)</sup> service (a.k.a. BellSouth Dedicated Ring). OC-1 SMARTRing<sup>(3)</sup> service (a.k.a. BellSouth Dedicated Ring) provides an equivalent capacity of 28 DS1s or one STS-1. When an OC-1 SMARTRing<sup>(3)</sup> service (a.k.a. BellSouth Dedicated Ring) overlays an OC-12, OC-48, or OC-48+ SMARTRing<sup>(3)</sup> service (a.k.a. BellSouth Dedicated Ring), an OC-1 channel interface is required.
4. OC-3 SMARTRing<sup>(3)</sup> service (a.k.a. BellSouth Dedicated Ring) is available as an individual service or in an Overlay Ring Arrangement riding the customer's host OC-12, OC-48, OC-48+, OC-192 or OC-192+ SMARTRing<sup>(3)</sup> service (a.k.a. BellSouth Dedicated Ring). OC-3 SMARTRing<sup>(3)</sup> service (a.k.a. BellSouth Dedicated Ring) provides an equivalent capacity of 3 DS3s, or any combination thereof not to exceed an OC-3 capacity. Channel Interface Reallocation allows the customer to reallocate STS-1, DS3 and/or DS1 capacities to OC-3 nodes subsequent to the initial configuration of an OC03 ring.
5. OC-3+ SMARTRing<sup>(3)</sup> service (a.k.a. BellSouth Dedicated Ring) is available as an individual service, or in combination with OC-12 SMARTRing<sup>(3)</sup> service (a.k.a. BellSouth Dedicated Ring), or in an Overlay Ring Arrangement riding the customer's host OC-48, OC-192 or OC-192+ SMARTRing<sup>(3)</sup> service (a.k.a. BellSouth Dedicated Ring). OC-3+ SMARTRing<sup>(3)</sup> service (a.k.a. BellSouth Dedicated Ring) provides an equivalent OC-3 capacity, not to exceed 3 DS3s at each node, with a maximum ring capacity of 12 DS3s, not to exceed an OC-12 ring capacity.

**Note 1:** Effective July 10, 2015, the Company will accept only disconnect order for OC-3+ SMARTRing service (a.k.a. BellSouth SPA Dedicated Ring), including orders associated with existing service. Move, add or change orders will no longer be accepted. (M)  
(C)

**Note 2:** Effective June 30, 2021, this Service will no longer be available for purchase by new or existing customers. In addition, requests to move, add, change, or renew existing service arrangements will not be accepted. Following the expiration of a customer's existing term agreement, service will be provided on a month-to-month basis at the applicable Monthly rates until the service is discontinued. The Company currently plans to discontinue this service on or after June 30, 2024. (C)

**Note 3:** Effective on or after December 1, 2021, neither new nor existing customers will be permitted to purchase new SMARTRing Service (Service). In addition, (A) Service Payment Plans greater than 12-months in length will no longer be available; and (B) requests to move, add, change, upgrade, or downgrade existing service arrangements will not be accepted, with the following exceptions: (1) existing customers will be permitted to modify their existing Service and will be able to add new circuits to their existing Service, but will not be permitted to add new nodes in any locations; and (2) any such new circuits will be subject to the customer's existing term payment plan or term agreement for the Service to which they are added. Following the expiration of a customer's existing term agreement, Service will be provided on a month-to-month basis at the applicable Month-to-Month rates until the Service is discontinued. (N)

Effective November 30, 2023, unless specified to the contrary in their existing Service agreements, existing customers may not renew Term Payment Plans or term agreements for Service. In addition, no move, add, or change orders of any type will be accepted. (N)

## E7. DEDICATED ACCESS SERVICES

### E7.2 Service Description (Cont'd)

#### E7.2.16 SMARTRing<sup>®</sup> service (a.k.a. BellSouth Dedicated Ring) (Cont'd)

6. When a customer orders OC-3+ SMARTRing<sup>®</sup> service (a.k.a. BellSouth Dedicated Ring) in combination with OC-12 SMARTRing<sup>®</sup> service (a.k.a. BellSouth Dedicated Ring), capacity and channel interface availability at each Customer Node and Central Office Node location is determined by the size node ordered by the customer. (M)
7. OC-12 SMARTRing<sup>®</sup> service (a.k.a. BellSouth Dedicated Ring) is available as an individual service, or in combination with OC-3+ SMARTRing<sup>®</sup> service (a.k.a. BellSouth Dedicated Ring), or in an Overlay Ring Arrangement riding the customer's host OC-48, OC-48+, OC-192 or OC-192+ SMARTRing<sup>®</sup> service (a.k.a. BellSouth Dedicated Ring). OC-12 SMARTRing<sup>®</sup> service (a.k.a. BellSouth Dedicated Ring) provides an equivalent capacity of 12 DS3s. (M)
8. OC-48 SMARTRing<sup>®</sup> service (a.k.a. BellSouth Dedicated Ring) is available as an individual service, or in an Overlay Ring Arrangement riding the customer's host OC-192 or OC-192+ SMARTRing<sup>®</sup> service (a.k.a. BellSouth Dedicated Ring), or with overlaying rings in capacities of OC-1, OC-3, OC-3+ and/or OC-12. OC-48 SMARTRing<sup>®</sup> service (a.k.a. BellSouth Dedicated Ring) provides an equivalent capacity of 48 DS3s. (M)
9. OC 48+ SMARTRing<sup>®</sup> service (a.k.a. BellSouth Dedicated Ring) is available as an individual bi directional service, or in an Overlay Ring Arrangement riding the customer's host OC-192 SMARTRing<sup>®</sup> service (a.k.a. BellSouth Dedicated Ring), or with overlaying rings in capacities of OC 1, and/or OC 3. It provides equivalent capacity of 24 DS3s between consecutive node locations on the ring. The maximum capacity of the OC 48+ SMARTRing<sup>®</sup> service (a.k.a. BellSouth Dedicated Ring) is determined by the number of Customer and Central Office nodes on the ring.
10. OC-192 SMARTRing<sup>®</sup> service (a.k.a. BellSouth Dedicated Ring) is available as an individual service, or with overlaying rings in capacities of OC-3, OC-3+, OC-12, OC-48 and /or OC-48+. OC-192 SMARTRing<sup>®</sup> service (a.k.a. BellSouth Dedicated Ring) provides an equivalent capacity of 192 DS3s.
11. OC-192+ SMARTRing<sup>®</sup> service (a.k.a. BellSouth Dedicated Ring) is available as an individual bi-directional service, or with overlaying rings in capacities of OC-3, OC-3+, OC-12 and /or OC-48. It provides equivalent capacity of 96 DS3s between consecutive node locations on the ring. The maximum capacity of the OC-192+ SMARTRing<sup>®</sup> service (a.k.a. BellSouth Dedicated Ring) is determined by the number of Customer and Central Office nodes on the ring.

**Note 1:** Effective on or after December 1, 2021, neither new nor existing customers will be permitted to purchase new SMARTRing Service (Service). In addition, (A) Service Payment Plans greater than 12-months in length will no longer be available; and (B) requests to move, add, change, upgrade, or downgrade existing service arrangements will not be accepted, with the following exceptions: (1) existing customers will be permitted to modify their existing Service and will be able to add new circuits to their existing Service, but will not be permitted to add new nodes in any locations; and (2) any such new circuits will be subject to the customer's existing term payment plan or term agreement for the Service to which they are added. Following the expiration of a customer's existing term agreement, Service will be provided on a month-to-month basis at the applicable Month-to-Month rates until the Service is discontinued. Effective November 30, 2023, unless specified to the contrary in their existing Service agreements, existing customers may not renew Term Payment Plans or term agreements for Service. In addition, no move, add, or change orders of any type will be accepted. (N)

## E7. DEDICATED ACCESS SERVICES

### E7.2 Service Description (Cont'd)

#### E7.2.16 SMARTRing<sup>7</sup> service (a.k.a. BellSouth Dedicated Ring) (Cont'd)

(C)

A. Self-healing Multi-nodal Alternate Route Topology Ring (Cont'd)

12. SMARTRing service (a.k.a. BellSouth Dedicated Ring) Channel Interfaces are available as follows:

Channel Interfaces	Nodes							
	OC-1	OC-3	OC-3+	OC-12	OC-48	OC-48+	OC-192	OC-192+
DS1	Yes	Yes	Yes	No <sup>1</sup>	No <sup>1</sup>	No <sup>1</sup>	No <sup>1</sup>	No <sup>1</sup>
DS3	No	Yes	Yes	Yes	Yes	Yes	Yes	Yes
STS-1	Yes	Yes	Yes	Yes	Yes	Yes	Yes	Yes
OC-1 <sup>2</sup>	No	No	No	Yes	Yes	Yes	Yes	Yes
OC-3	No	No	No	Yes	Yes	Yes	Yes	Yes
OC-12	No	No	No	No	Yes	Yes	Yes	Yes
28 DS1 Channel System (DS3)	No	Yes	Yes	Yes	Yes	Yes	Yes	Yes
28 DS1 Channel System (STS-1)	No	Yes	Yes	Yes	Yes	Yes	Yes	Yes
1000 Mbps	No	No	No	No	Yes <sup>3</sup>	Yes <sup>3</sup>	Yes	Yes
100 Mbps BellSouth Metro Ethernet <sup>6</sup> Backbone <sup>4</sup>	No	No	No	Yes	Yes	Yes	Yes	Yes
1000 Mbps BellSouth Metro Ethernet <sup>6</sup> Backbone	No	No	No	No	Yes	Yes	Yes	Yes
Fractional 1000 Mbps at 150 Mbps, 300 Mbps or 450 Mbps BellSouth Metro Ethernet <sup>6</sup> Backbone <sup>5</sup>	No	Yes	Yes	Yes	Yes	Yes	Yes	Yes
Fractional 1000 Mbps at 600 Mbps BellSouth Metro Ethernet <sup>6</sup> Backbone <sup>5</sup>	No	No	No	No	Yes	Yes	Yes	Yes

**Note 1:** DS1 interfaces are available via OC-1, OC-3, and OC-3+ Overlay Ring Arrangements or 28 DS1 Channel Systems only.

**Note 2:** OC-1 interfaces are only available for use with OC-1 Overlay Ring Arrangements.

**Note 3:** 1000 Mbps interfaces are only available for rings installed after October 30, 2003. 1000 Mbps transport channel interfaces do not contain any monitoring capability above the physical layer.

**Note 4:** 100 Mbps BellSouth Metro Ethernet Backbone interfaces are further defined regarding the number of STS-1s utilized in conjunction with the interface.

**Note 5:** Interfaces are available based on equipment capability.

**Note 6:** Effective on or after August 22, 2021, this Service will no longer be available for purchase by new or existing customers. In addition, requests to move, add, change, or renew existing service arrangements will not be accepted. Following the expiration of a customer's existing term agreement, service will be provided on a month-to-month basis at the applicable Monthly rates until the service is discontinued. The Company currently plans to discontinue this service on or after March 31, 2023.

**Note 7:** Effective on or after December 1, 2021, neither new nor existing customers will be permitted to purchase new SMARTRing Service (Service). In addition, (A) Service Payment Plans greater than 12-months in length will no longer be available; and (B) requests to move, add, change, upgrade, or downgrade existing service arrangements will not be accepted, with the following exceptions: (1) existing customers will be permitted to modify their existing Service and will be able to add new circuits to their existing Service, but will not be permitted to add new nodes in any locations; and (2) any such new circuits will be subject to the customer's existing term payment plan or term agreement for the Service to which they are added. Following the expiration of a customer's existing term agreement, Service will be provided on a month-to-month basis at the applicable Month-to-Month rates until the Service is discontinued.

(N)

Effective November 30, 2023, unless specified to the contrary in their existing Service agreements, existing customers may not renew Term Payment Plans or term agreements for Service. In addition, no move, add, or change orders of any type will be accepted.

(N)

## E7. DEDICATED ACCESS SERVICES

### E7.2 Service Description (Cont'd)

#### E7.2.16 SMARTRing<sup>1</sup> service (a.k.a. BellSouth Dedicated Ring) (Cont'd)

(C)

A. Self-healing Multi-nodal Alternate Route Topology Ring (Cont'd)

13. SMARTRing service (a.k.a. BellSouth Dedicated Ring) Overlay Ring Arrangements are available as follows:

Overlaying SMARTRing service (a.k.a. BellSouth Dedicated Ring)	Host SMARTRing service (a.k.a. BellSouth Dedicated Ring)				
	OC-12	OC-48	OC-48+	OC-192	OC-192+
OC-1	X	X	X	X	X
OC-3	X	X	X	X	X
OC-3+		X	X	X	X
OC-12		X	X	X	X
OC-48				X	X
OC-48+					X

14. SMARTRing service (a.k.a. BellSouth Dedicated Ring) is connectible at Telephone Company Central Offices to any 44.736 Mbps and/or 1.544 Mbps services as provided in Section E7. of this Tariff. Rates and charges for such other services are as set forth in the applicable sections of this tariff for such other services.

15. Shared Network Arrangements will not be provided with SMARTRing service (a.k.a. BellSouth Dedicated Ring) at the ring level. Shared Network Arrangements as defined in E2.6 preceding apply to DS1 channel interfaces only.

The customer must provide suitable floor space, controlled environment, and source of non-switched suitable power to support this service.

16. Where the customer provides two separate entrance facility cable routes for SMARTRing service (a.k.a. BellSouth Dedicated Ring), the primary and alternate entrance facilities will be separate and will enter the customer node over such different routes. When the customer requests a connection at a Customer Node via two local channels and Telephone Company facilities do not exist for the second Local Channel, the Telephone Company may provide an equivalent second Local Channel via an existing alternate route. When facilities become available for the second Local Channel, the Telephone Company may rearrange the alternate route at any time.

**Note 1:** Effective on or after December 1, 2021, neither new nor existing customers will be permitted to purchase new SMARTRing Service (Service). In addition, (A) Service Payment Plans greater than 12-months in length will no longer be available; and (B) requests to move, add, change, upgrade, or downgrade existing service arrangements will not be accepted, with the following exceptions: (1) existing customers will be permitted to modify their existing Service and will be able to add new circuits to their existing Service, but will not be permitted to add new nodes in any locations; and (2) any such new circuits will be subject to the customer's existing term payment plan or term agreement for the Service to which they are added. Following the expiration of a customer's existing term agreement, Service will be provided on a month-to-month basis at the applicable Month-to-Month rates until the Service is discontinued.

(N)

Effective November 30, 2023, unless specified to the contrary in their existing Service agreements, existing customers may not renew Term Payment Plans or term agreements for Service. In addition, no move, add, or change orders of any type will be accepted.

(N)

## E7. DEDICATED ACCESS SERVICES

### E7.2 Service Description (Cont'd)

#### E7.2.16 SMARTRing<sup>1</sup> service (a.k.a. BellSouth Dedicated Ring) (Cont'd)

(C)

##### A. Self-healing Multi-nodal Alternate Route Topology Ring (Cont'd)

17. When the distance between nodes on a SMARTRing service (a.k.a. BellSouth SPA Dedicated Ring) is such that optical signal regeneration is required, then regeneration equipment will be provided at no additional charge to the customer to assure proper operation of the service. In some cases regeneration will be provided via SONET Add/Drop equipment called a Regeneration Node. A Regeneration Node does not contain the capability to add or drop services. Accordingly, FlexServ service (a.k.a. BellSouth SPA Customer Reconfiguration) Customer Network Management may not be ordered with a Regeneration Node, however, a customer may monitor a Regeneration Node via the FlexServ service (a.k.a. BellSouth SPA Customer Reconfiguration) Customer Network Management Surveillance option when a customer has established surveillance for a ring. Regeneration Node Surveillance is provided as a part of the charges associated with the customer's ring level FlexServ service (a.k.a. BellSouth SPA Customer Reconfiguration) Customer Network Management Surveillance. Regeneration Node and Regeneration Node Surveillance, as applicable, will appear on a customer's records as non-rated USOC(s), as follows:

Regeneration Node, all ring capacities, non-rated SHNRD

Regeneration Node Surveillance, all ring capacities, non-rated SHNRS

18. Effective February 16, 2007, Shared Node Interconnection is available, based on equipment capability, whereby two SMARTRing service arrangements belonging to the same customer may share a node in a central office that is common to both rings. Shared Node Interconnection capability is available based on equipment capability. With Shared Node Interconnection, one of the rings (i.e., the larger capacity ring) is considered the Primary Ring and the other ring is considered the Secondary Ring. Primary Rings may be an OC-12, OC-48 or an OC-192 ring. A Secondary Ring is always a lower capacity ring than that of the Primary Ring. The various Shared Node Interconnection service arrangements that are available are as follows:

Shared Node Interconnection_Primary Ring Capacity	Shared Node Interconnection			
	<u>Secondary Ring Capacity Available For Use With Primary Rings</u>			
	OC-3	OC-12	OC-48	OC-48+
OC-12	X			
OC-48	X	X		
OC-192	X	X	X	X

With Shared Node Interconnection, the Primary Ring shall have a Central Office Node and the Secondary Ring shall have a Shared Node Interconnection Central Office Node in the central office associated with the ring interconnection. For the Secondary Ring, a Shared Node Interconnection Central Office Node is considered toward meeting the three node minimum requirement for the Secondary Ring. This shared node will utilize capacity of the Primary Ring node, based on the size of the Secondary Ring, and will count toward the capacity the customer has available at the location. Should the customer require more capacity at a shared node central office location than is available on the Primary Ring node, then additional billable service components will be required.

Only one Shared Node Interconnection arrangement is available for an individual Central Office Node on a Primary Ring.

Reconfiguration is not allowed at central office nodes that are configured for Shared Node Interconnection.

**Note 1:** Effective on or after December 1, 2021, neither new nor existing customers will be permitted to purchase new SMARTRing Service (Service). In addition, (A) Service Payment Plans greater than 12-months in length will no longer be available; and (B) requests to move, add, change, upgrade, or downgrade existing service arrangements will not be accepted, with the following exceptions: (1) existing customers will be permitted to modify their existing Service and will be able to add new circuits to their existing Service, but will not be permitted to add new nodes in any locations; and (2) any such new circuits will be subject to the customer's existing term payment plan or term agreement for the Service to which they are added. Following the expiration of a customer's existing term agreement, Service will be provided on a month-to-month basis at the applicable Month-to-Month rates until the Service is discontinued.

(N)

Effective November 30, 2023, unless specified to the contrary in their existing Service agreements, existing customers may not renew Term Payment Plans or term agreements for Service. In addition, no move, add, or change orders of any type will be accepted.

(N)

## E7. DEDICATED ACCESS SERVICES

### E7.2 Service Description (Cont'd)

#### E7.2.16 SMARTRing<sup>1</sup> service (a.k.a. BellSouth Dedicated Ring) (Cont'd)

(C)

##### B. Technical Specifications Packages

1. The compatibility requirements, technical specifications, and generic requirements for SMARTRing service (a.k.a. Bellsouth Dedicated Ring) terminated at the customers designated locations are referenced in Technical Reference ANSI T1.404-1994, ANSI T1.403-1989 and ANSI T1.105-1991.
2. DS3 interface combinations and technical specifications are referenced in Bellcore TR-INS-000342.
3. DS1 interface combinations and technical specifications are referenced in Bellcore TR-NPL-000054.
4. STS-1, OC-1, OC-3, and OC-12 interface combinations and technical specifications are referenced in BellSouth Telecommunications, Inc. Technical Reference TR-73582.
5. These self-healing multi-nodal DS3 high capacity (a.k.a. BellSouth SPA DS3) service channels have a long term performance objective of 99.5 percent error-free seconds and a severely errored second (SES) objective of less than 0.009 percent SES when the circuit is available. Self-healing multi-nodal DS1 high capacity (a.k.a. BellSouth SPA DS1) service channels have a long term performance objective of 99.95 percent error-free seconds.

#### E7.2.17 Reserved for Future Use

**Note 1:** Effective on or after December 1, 2021, neither new nor existing customers will be permitted to purchase new SMARTRing Service (Service). In addition, (A) Service Payment Plans greater than 12-months in length will no longer be available; and (B) requests to move, add, change, upgrade, or downgrade existing service arrangements will not be accepted, with the following exceptions: (1) existing customers will be permitted to modify their existing Service and will be able to add new circuits to their existing Service, but will not be permitted to add new nodes in any locations; and (2) any such new circuits will be subject to the customer's existing term payment plan or term agreement for the Service to which they are added. Following the expiration of a customer's existing term agreement, Service will be provided on a month-to-month basis at the applicable Month-to-Month rates until the Service is discontinued.

(N)

Effective November 30, 2023, unless specified to the contrary in their existing Service agreements, existing customers may not renew Term Payment Plans or term agreements for Service. In addition, no move, add, or change orders of any type will be accepted.

(N)



## E7. SPECIAL ACCESS (A.K.A. BELLSOUTH SPA) SERVICE

### E7.2 Service Descriptions (Cont'd)

#### E7.2.18 BellSouth Metro Ethernet Service<sup>2</sup>

(C)

- A. BellSouth Metro Ethernet service is a high-speed packet transport that is based on Ethernet transmission parameters. BellSouth Metro Ethernet service provides various transport capabilities that range from 2 Mbps through 1 Gbps with capabilities for basic, premium, and virtual arrangements that may be used to meet individual customer needs.
- B. BellSouth Metro Ethernet service signals meet IEEE 802.3, 802.3u, or 802.3z standards. BellSouth Metro Ethernet service also uses 802.1Q VLAN tagging and stacking for certain service configurations contained herein. Technical requirements for interfaces with customer premises equipment (CPE) are contained in ANSI/IEEE 802.3-2002 Specifications.
- C. BellSouth Metro Ethernet service interface specifications are set forth in BellSouth Technical Reference TR-73632. Technical limitations associated with provisioning 2 Mbps, 4 Mbps and 8 Mbps BellSouth Metro Ethernet Connections based upon distance from the customer's premises to serving wire center and equipment configurations exist and are also set forth in TR-73632.
- D. The rates and charges set forth in E7.5.22 following for BellSouth Metro Ethernet service provide for the furnishing of service in certain metropolitan areas where suitable Company facilities are available. In locations where BellSouth Metro Ethernet service is not available, special construction charges may apply.
- E. A LAN (local area network) is a communications network spanning a limited geographical area. A LAN connects computers and other peripheral equipment for data communications purposes within a building or campus environment.
- F. A VLAN (virtual local area network) is a logical grouping of Metro Ethernet connections that allows data transmission between such connections to occur as if all connections are on the same physical LAN.
- G. Metro Ethernet is a service where Local Area Networks (LANs) send bi-directional Ethernet traffic to other LANs on an Ethernet Wide Area Network (WAN). Ethernet is one of the most widely deployed LAN/WAN standards. BellSouth Metro Ethernet service supports IEEE Standard 802.3, 802.3u and 802.3z transmission standards.
- H. A Metro Ethernet Customer Network is defined as the set of interconnected Metro Ethernet connections assigned to the same VLAN within the BellSouth core network. Premium Connections that include the Q-Forwarding optional feature described in O. following and Virtual Connections that include the VLAN Aggregation optional feature described in P. following may be part of more than one Metro Ethernet Customer Network.
- I. A Basic BellSouth Metro Ethernet service Connection provides 2 Mbps, 4 Mbps, 8 Mbps, 10 Mbps, 100 Mbps and 1 Gbps Ethernet capabilities that are a part of a BellSouth Metro Ethernet service network within a metropolitan area. Basic BellSouth Metro Ethernet service is a best effort service with service capabilities that are affected by overall traffic on the Basic BellSouth Metro Ethernet service network and is suitable for data transmission only.

A Basic BellSouth Metro Ethernet service connection operating at any of these speeds is capable of interconnecting with other Basic BellSouth Metro Ethernet service Connections that are operating at any of these speeds in the same metropolitan area.

A Basic BellSouth Metro Ethernet service connection provides data channel transport that connects customer premises<sup>1</sup> that are 10 miles or less in distance from the BellSouth Metro Ethernet service wire center associated with the Basic BellSouth Metro Ethernet service Connection. Customer locations<sup>1</sup> greater than 10 miles from the Basic BellSouth Metro Ethernet service wire center also require BellSouth Metro Ethernet service Additional Mileage charges.

**Note 1:** And as alternatively set forth in E7.4.32.A.5. *and* 6. Following

**Note 2:** Effective on or after August 22, 2021, this Service will no longer be available for purchase by new or existing customers. In addition, requests to move, add, change, or renew existing service arrangements will not be accepted. Following the expiration of a customer's existing term agreement, service will be provided on a month-to-month basis at the applicable Monthly rates until the service is discontinued. The Company currently plans to discontinue this service on or after March 31, 2023.

(N)  
|  
(N)

## E7. SPECIAL ACCESS (A.K.A. BELLSOUTH SPA) SERVICE

### E7.2 Service Descriptions (Cont'd)

#### E7.2.18 BellSouth Metro Ethernet Service (Cont'd)<sup>3</sup>

(C)

- J.** A Premium BellSouth Metro Ethernet service Connection provides 2 Mbps, 4 Mbps, 8 Mbps, 10 Mbps, 20 Mbps, 50 Mbps, 100 Mbps, 250 Mbps, 500 Mbps and 900 Mbps Ethernet capabilities that are a part of a BellSouth Metro Ethernet service network within a metropolitan area. Premium BellSouth Metro Ethernet service provides the ability to order Ethernet Service with improved service characteristics to meet customer needs regarding the assurance of bandwidth availability.

Premium BellSouth Metro Ethernet service provides customer capabilities to assure service characteristics via ordering a Committed Bandwidth (CBW). A CBW is the minimum bandwidth across the BellSouth Metro Ethernet service network within a metropolitan area between a customer's Premium BellSouth Metro Ethernet service locations.

Premium BellSouth Metro Ethernet service Connections are available with "Fixed" and "Burst" capabilities unless specified otherwise<sup>1</sup>. With the Fixed arrangement, Premium BellSouth Metro Ethernet service Connections will have the bandwidth ordered (e.g., 10 Mbps) available across the BellSouth Metro Ethernet service network. With the Burst arrangement, Premium BellSouth Metro Ethernet service Connections will have the ability to send burst of data above their CBW rate, if network capacity *and facilities are* available. For example, a 10 Mbps, a 20 Mbps and a 50 Mbps Connection may Burst up to 100 Mbps, while a 100 Mbps, a 250 Mbps and a 500 Mbps Connection may Burst up to 1 Gbps.

A Premium BellSouth Metro Ethernet service Connection operating at any of these speeds is capable of interconnecting with other Premium BellSouth Metro Ethernet service Connections that are operating at any of these speeds in the same metropolitan area.

A Premium BellSouth Metro Ethernet service Connection provides data channel transport that connects customer premises<sup>2</sup> that are 10 miles or less in distance from the BellSouth Metro Ethernet service wire center associated with the Premium BellSouth Metro Ethernet service Connection. Customer locations<sup>2</sup> greater than 10 miles from the Premium BellSouth Metro Ethernet service wire center also require BellSouth Metro Ethernet service Additional Mileage charges.

**Note 1:** Premium Connections at 2 Mbps, 4 Mbps, 8 Mbps and 900 Mbps are available only as Fixed arrangements (i.e., "Burst" capability is not available).

**Note 2:** And is alternatively set forth in E7.4.32.A.5. and 6. following.

**Note 3:** Effective on or after August 22, 2021, this Service will no longer be available for purchase by new or existing customers. In addition, requests to move, add, change, or renew existing service arrangements will not be accepted. Following the expiration of a customer's existing term agreement, service will be provided on a month-to-month basis at the applicable Monthly rates until the service is discontinued. The Company currently plans to discontinue this service on or after March 31, 2023.

(N)  
|  
(N)

## E7. SPECIAL ACCESS (A.K.A. BELLSOUTH SPA) SERVICE

### E7.2 Service Descriptions (Cont'd)

#### E7.2.18 BellSouth Metro Ethernet Service (Cont'd)<sup>2</sup>

(C)

K.

- L. A Virtual BellSouth Metro Ethernet Service Connection provides 2 Mbps, 4 Mbps, 8 Mbps, 10 Mbps, 20 Mbps, 50 Mbps, 80 Mbps, 100 Mbps, 200 Mbps, 300 Mbps, 450 Mbps, 600 Mbps, 750 Mbps and 900 Mbps Ethernet capabilities that are a part of a BellSouth Metro Ethernet Service network within a metropolitan area. Virtual BellSouth Metro Ethernet Service provides the ability to order Ethernet Service where a single customer connection can support multiple applications with varying Quality of Service (QoS) features and Classes of Service.

Virtual BellSouth Metro Ethernet Service provides customer capabilities to support different Classes of Service (CoS) (i.e., Real-Time, Interactive, Business Critical and Best Effort as described in E7.2.18.T) over the same Connection and offers customers increased flexibility to match bandwidth to their real needs for voice/data/video applications on each Connection. The customer orders the percentage of their Virtual BellSouth Metro Ethernet Service Connection bandwidth that will be allocated for each class of service.

For each Virtual Connection, the customer's bandwidth will be limited to the fixed speed associated with each CoS level specified in the CoS profile selected for the Virtual Connection.

A Virtual BellSouth Metro Ethernet Service Connection operating at any of these speeds is capable of interconnecting with other Virtual BellSouth Metro Ethernet Service Connections that are operating at any of these speeds in the same metropolitan area.

A Virtual BellSouth Metro Ethernet Service Connection provides data channel transport that connects customer premises<sup>1</sup> that are 10 miles or less in distance from the BellSouth Metro Ethernet Service wire center associated with the Virtual BellSouth Metro Ethernet Service Connection. Customer locations<sup>1</sup> greater than 10 miles from the Virtual BellSouth Metro Ethernet Service wire center also require BellSouth Metro Ethernet Service Additional Mileage charges.

**Note 1:** And as alternatively set forth in E7.4.32.A.5. *and* 6. following.

**Note 2:** Effective on or after August 22, 2021, this Service will no longer be available for purchase by new or existing customers. In addition, requests to move, add, change, or renew existing service arrangements will not be accepted. Following the expiration of a customer's existing term agreement, service will be provided on a month-to-month basis at the applicable Monthly rates until the service is discontinued. The Company currently plans to discontinue this service on or after March 31, 2023.

(N)

(N)

## E7. SPECIAL ACCESS (A.K.A. BELLSOUTH SPA) SERVICE

### E7.2 Service Descriptions (Cont'd)

#### E7.2.18 BellSouth Metro Ethernet Service (Cont'd)<sup>2</sup>

(C)

- M.** BellSouth Metro Ethernet service Additional Mileage charges associated with a BellSouth Metro Ethernet service Connection apply when the total distance from the customer premises<sup>1</sup> to the BellSouth Metro Ethernet service wire center associated with the service serving the customer premises<sup>1</sup> is greater than 10 miles in length. The additional mileage is measured in airline miles from the customer premises<sup>1</sup> to the BellSouth Metro Ethernet service wire center associated with the BellSouth Metro Ethernet service. Fractions of miles will be considered as a whole mile.

BellSouth Metro Ethernet service Additional Mileage charges apply to Basic, Premium and Virtual BellSouth Metro Ethernet service based on the service's speed and the total distance associated with the data channel. The BellSouth Metro Ethernet service Additional Mileage Charge is based on the mileage band the total data channel mileage falls into. For example, a data channel that is 30 miles in length would be charged the additional mileage rate for the greater than 25 mile through 35 mile band.

- N.** Priority Plus is an optional feature available to customers with Premium BellSouth Metro Ethernet service. Priority Plus provides the customer with the ability to prioritize their traffic in accordance with a predefined hardware queue model approach. With this option, customers will assign priority values to their data and higher-priority data will be transmitted first. Priority Plus service traffic is limited to a small subset of the total Committed Bandwidth (CBW) traffic and is marked for expedited handling within the Metro Ethernet Service. Customers that desire Priority Plus must establish it for all of their Premium BellSouth Metro Ethernet service Connections within that Metro Ethernet Customer Network.

- O.** Q-Forwarding is an optional feature available to customers with Premium BellSouth Metro Ethernet service. Q-Forwarding provides VLAN aggregation across a common physical connection. This feature supports customer aggregation of traffic from multiple Metro Ethernet Customer Networks (referred to as VLANS). This aggregated traffic can be transported back to a central location and across a common Metro Ethernet Service Connection (referred to as the "aggregation" connection). Q-Forwarding utilizes IEEE 802.1Q VLAN Tagging procedures.

While Q-Forwarding is available with BellSouth Premium Metro Ethernet Connections at 2 Mbps, 4 Mbps and 8 Mbps, this feature is subject to technical limitations set forth in Technical Reference 73632 when used with these speed connections.

With Q-Forwarding, special technical considerations set forth in Technical Reference 73632 must be taken into account to determine the customer's CBW across their BellSouth Metro Ethernet Network.

The Q-Forwarding Service Establishment Charge is a charge to provision a Premium Metro Ethernet Connection with the Q-Forwarding feature and identify it as an "aggregation" connection.

The Q-Forwarding Network Assignment Charge is a charge to provision each Metro Ethernet Customer Network to the Q-Forwarding "aggregation" connection. The Q-Forwarding Network Assignment Charge applies for each VLAN connected to the Q-Forwarding "aggregation" connection.

- P.** VLAN Aggregation is an optional feature available to customers with Virtual BellSouth Metro Ethernet Service. VLAN Aggregation provides VLAN aggregation across a common physical connection. This feature supports customer aggregation of traffic from multiple Metro Ethernet Customer Networks (referred to as VLANS) comprised of Virtual Connections. This aggregated traffic can be transported back to a central location and across a common Virtual Metro Ethernet Service Connection (referred to as the "aggregation" connection). VLAN Aggregation utilizes IEEE 802.1Q VLAN Tagging procedures.

While VLAN Aggregation is available with BellSouth Virtual Metro Ethernet Connections at 2 Mbps, 4 Mbps and 8 Mbps, this feature is subject to technical limitations set forth in Technical Reference 73632 when used with these speed connections.

The VLAN Aggregation Service Establishment Charge is a charge to provision a Virtual Metro Ethernet Connection with this feature and identify it as an "aggregation" connection.

The VLAN Aggregation Network Assignment Charge is a charge to provision each Virtual Ethernet Customer Network to the "aggregation" connection. The VLAN Aggregation Network Assignment Charge applies for each VLAN connected to the "aggregation" connection.

**Note 1:** And as alternatively set forth in E7.4.32.A.5. following.

**Note 2:** Effective on or after August 22, 2021, this Service will no longer be available for purchase by new or existing customers. In addition, requests to move, add, change, or renew existing service arrangements will not be accepted. Following the expiration of a customer's existing term agreement, service will be provided on a month-to-month basis at the applicable Monthly rates until the service is discontinued. The Company currently plans to discontinue this service on or after March 31, 2023.

(N)  
|  
(N)

## E7. SPECIAL ACCESS (A.K.A. BELLSOUTH SPA) SERVICE

### E7.2 Service Descriptions (Cont'd)

#### E7.2.18 BellSouth Metro Ethernet Service (Cont'd)<sup>1</sup>

(C)

- Q. Customer Network Management (CNM)** - Metro Ethernet Reporting is an optional feature available to customers with Premium or Virtual BellSouth Metro Ethernet service. **CNM** - Metro Ethernet Reporting provides customers a view into their BellSouth Metro Ethernet service network via the use of a web interface and security card. **CNM** - Metro Ethernet Reporting provides alarm surveillance, service level agreement reporting and performance reporting for the various network components that comprise the customer's BellSouth Metro Ethernet service network. This feature is only available to customers purchasing Premium or Virtual BellSouth Metro Ethernet service.

Customers who subscribe to **CNM** - Metro Ethernet Reporting must monitor their entire BellSouth Metro Ethernet Network. The **CNM** - Metro Ethernet Reporting Charge is applicable for each Premium or Virtual Metro Ethernet Service Connection.

The **CNM** - Metro Ethernet Reporting Service Establishment Charge is a nonrecurring charge that applies to initially establish a new Metro Ethernet Service customer account. A customer with an existing **CNM** - Metro Ethernet Reporting customer account from another BellSouth jurisdiction may re-use that customer account.

All customers purchasing **CNM** - Metro Ethernet Reporting must have a web interface that will allow the customer to access and monitor their network via the web. Each web interface provides for one concurrent access. Additional concurrent accesses will require additional web interfaces. An initial web interface (Web Interface Charge - First) is provided with the initial establishment of a customer account. A monthly charge and a nonrecurring charge are applicable for each additional web interface requested for a customer account (Web Interface Charge – Each Additional).

A security card is required to access a web interface. Each security card can only be used for a single concurrent access and can be associated with only one web interface. A Security Card Charge will apply for the initial and additional cards requested and for the issuance of additional cards to replace lost, damaged or expired cards. A nonrecurring charge is applicable per security card requested.

- R.** BellSouth Metro Ethernet service Customer networks comprised of Premium Connections or Virtual Connections with **CNM** - Metro Ethernet Reporting are provided Service Level Agreements (SLAs) for the Company's repair and performance commitments for this service. Credits are provided for missed commitments on such service. The specific SLA commitments and credits applicable are set forth in E7.4.32.C. following for Premium Connections and in Section E7.4.32.D. for Virtual Connections.
- S.** Subsequent to its initial installation, a customer may request to reconfigure or change a BellSouth Metro Ethernet service Connection. The Service Reconfiguration Charge or System Reconfiguration Charge will be the nonrecurring charge applicable for such a request; the appropriate nonrecurring charge will be based upon the reconfiguration or change requested, as specifically described and set forth in E7.4.32 following.
- T.** For each Virtual BellSouth Metro Ethernet Connection the customer must decide the mix of applications that will be supported on that Connection, the CoS mix that Virtual Connection must support, and the percentage of bandwidth to be assigned for each CoS (i.e., build a CoS profile for each Virtual Connection). The customer's bandwidth will be limited to the fixed speed associated with each CoS level. Therefore, total bandwidth available to support transmission of a specific CoS will depend upon the size of the customer's Connection and the specific CoS percentage the customer selected for that Connection.

A customer may request a single CoS or up to four CoS to build the CoS Profile for a Virtual Connection. The customer determines the percentage bandwidth each CoS selected should be of the total Virtual Connection's bandwidth. The sum of the percentages for each CoS selected for a Virtual Connection must equal 100%. Additionally, the combined CoS bandwidth percentages selected in a customer's CoS Profile for Real-Time CoS plus Interactive CoS may not exceed 50%, except where the customer selects the 70% Real-Time CoS bandwidth percentage and has no Interactive traffic.

A customer may select different CoS profiles for different Virtual Connections that share the same network VLAN, or Virtual Connection network arrangement. However, technical limitations exist as discussed in TR-73632 that limit the total number of different CoS profiles that can be utilized in a single Virtual Connection network arrangement.

**Note 1:** Effective on or after August 22, 2021, this Service will no longer be available for purchase by new or existing customers. In addition, requests to move, add, change, or renew existing service arrangements will not be accepted. Following the expiration of a customer's existing term agreement, service will be provided on a month-to-month basis at the applicable Monthly rates until the service is discontinued. The Company currently plans to discontinue this service on or after March 31, 2023.

(N)  
|  
(N)

## E7. SPECIAL ACCESS (A.K.A. BELLSOUTH SPA) SERVICE

### E7.2 Service Descriptions (Cont'd)

#### E7.2.18 BellSouth Metro Ethernet Service (Cont'd)<sup>2</sup>

(C)

T. (Cont'd)

The CoS and percentage bandwidth selected for a Virtual Connection will define the applications that can be supported and its Quality of Service (QoS) attributes such as traffic priority, latency, packet loss rate, etc. QoS attributes are defined for each CoS. Each Virtual Connection will support Ethernet traffic representing one or more applications and CoS. Virtual Connections support the four following CoS:

- Real-Time<sup>1</sup>: This CoS supports VoIP applications. The Real-Time CoS is supported by a low latency queue. The Low Latency Queuing (LLQ) feature in the Ethernet network is used for support of the Real-Time CoS.
- Interactive<sup>1</sup>: This CoS supports interactive Video applications. The Interactive CoS is policed to a maximum bandwidth.
- Business Critical: This CoS supports mission-critical business data applications. These applications tend to be data specific and may include medical imaging, electronic funds transfer, medical records transfer, etc.
- Best Effort: This CoS is the default CoS for all other traffic that is not defined as Business Critical, Real-Time or Interactive. Traffic that does not match the other CoS will be mapped as Best Effort. Traffic with the Best Effort CoS will have the lowest priority on the network and will support lower priority data applications, such as email and file transfer protocol (FTP).

Each customer packet from a Virtual Connection will be classified and assigned to a specific CoS by methods identified in TR-73632.

**Note 1:** The combined CoS bandwidth percentages selected in a customer's Virtual Connection CoS profile for Real-Time CoS plus Interactive CoS may not exceed 50%, except where the customer selects the 70% Real-Time CoS bandwidth percentage and has no Interactive traffic.

**Note 2:** Effective on or after August 22, 2021, this Service will no longer be available for purchase by new or existing customers. In addition, requests to move, add, change, or renew existing service arrangements will not be accepted. Following the expiration of a customer's existing term agreement, service will be provided on a month-to-month basis at the applicable Monthly rates until the service is discontinued. The Company currently plans to discontinue this service on or after March 31, 2023.

(N)  
|  
(N)

## E7. SPECIAL ACCESS (A.K.A. BELLSOUTH SPA) SERVICE

### E7.2 Service Descriptions (Cont'd)

#### E7.2.18 BellSouth Metro Ethernet Service (Cont'd)<sup>2</sup>

(C)

- U. Automatic Protection Switching (APS) is an optional feature available, except as specified otherwise herein, to customers with a Basic, Premium or Virtual BellSouth Metro Ethernet Service Connection of 10 Mbps or higher<sup>1</sup>. The APS feature provides customers with the option of having data channel (i.e., facilities from the customer premises to the BellSouth Metro Ethernet Service wire center) survivability through the use of a secondary transport path that is diverse from the path provided with their primary Metro Ethernet Connection. This secondary transport path (i.e., data channel) is provided for a specific Metro Ethernet Connection (i.e., the primary) with the selection of the APS feature which then provides the customer with complete path protection. However, APS is not available for a 2 Mbps, 4 Mbps or 8 Mbps Connection.

With APS, the primary Metro Ethernet Connection's data channel is monitored for threshold violations or path failures with a fail-over to the secondary data channel path provided via the APS feature. The APS data channel is checked periodically to ensure its availability if a failure of the primary Metro Ethernet Connection's data channel occurs.

APS may be ordered as a structurally diverse transport path (Structural Protection) or a route diverse transport path (Route Protection).

Structural Protection APS is defined as the APS facility and the primary Metro Ethernet Connection facility being in separate sheaths in separate structures located along the same route (e.g., underground/underground, buried/underground, aerial/underground, aerial/buried, buried/buried, and aerial/aerial), or along different routes at the Telephone Company's discretion

Route Protection APS is defined as the APS facility being in a separate sheath within alternate underground, aerial or direct buried structures that are run along separate physical paths from the facilities associated with the primary Metro Ethernet Connection. No precise distance separation is specified between the paths; although the separation is sufficient to preclude one disruptive event from affecting both routes.

The APS feature is billed based upon the actual total route miles in a customer's specific Structural Protection APS or Route Protection APS design as determined by the Telephone Company. The term "route miles" is defined for this application to be the actual physical distance or length (not airline mileage), rounded up to the next whole mile, of the unique APS facility designed for each individual customer premises. Total route miles are measured between the customer premises and its serving wire center, plus route miles between the serving wire center and any intermittent wire centers in the path designed to reach the BellSouth Metro Ethernet wire center associated with the primary Metro Ethernet Connection (i.e., the wire center where the BellSouth Metro Ethernet switching equipment is located).

The APS rate element provides the alternate data channel transport and APS equipment in the BellSouth Metro Ethernet Service wire center associated with the primary Metro Ethernet Connection. Actual total route mileage for the customer's APS design is determined from a Service Inquiry. The route mileage determined from this Telephone Company Service Inquiry is used for billing purposes and is the sole determinant of such mileage (i.e., not subject to dispute).

- V. BellSouth Metro Ethernet Service Independent Company (ICO) Trunk Connection

Provides interconnection between BellSouth's Ethernet network and the Ethernet network of an Independent Telephone Company. A BellSouth Metro Ethernet Service ICO Trunk Connection provides data channel transport for connections that are 10 airline miles or less in distance from the BellSouth Metro Ethernet Service ICO Trunk Connection wire center to the meet-point with the Independent Company. Meet-point locations greater than 10 airline miles from the BellSouth Metro Ethernet Service ICO Trunk Connection wire center also require BellSouth Metro Ethernet Service ICO Trunk Additional Mileage charges.

- W. BellSouth Metro Ethernet Service Independent Company (ICO) Trunk Additional Mileage Charges

Additional mileage charges associated with a BellSouth Metro Ethernet Service ICO Trunk Connection apply when the total distance from the BellSouth Metro Ethernet Service ICO Trunk Connection wire center to the meet-point with the Independent Company is greater than 10 miles in length. The additional mileage is measured in airline miles from the BellSouth Metro Ethernet Service wire center associated with the BellSouth Metro Ethernet Service ICO Trunk Connection to the Independent Company meet-point. Fractions of miles will be considered as a whole mile.

**Note 1:** Automatic Protection Switching (APS) is not available for a 2 Mbps, 4 Mbps or 8 Mbps Basic, Premium or Virtual Connection.

**Note 2:** Effective on or after August 22, 2021, this Service will no longer be available for purchase by new or existing customers. In addition, requests to move, add, change, or renew existing service arrangements will not be accepted. Following the expiration of a customer's existing term agreement, service will be provided on a month-to-month basis at the applicable Monthly rates until the service is discontinued. The Company currently plans to discontinue this service on or after March 31, 2023.

(N)  
|  
(N)

## E7. SPECIAL ACCESS (A.K.A. BELLSOUTH SPA) SERVICE

### E7.2 Service Descriptions (Cont'd)

#### E7.2.18 BellSouth Metro Ethernet Service (Cont'd)<sup>1</sup>

(C)

##### X. Migration to AT&T Switched Ethernet Service<sup>SM</sup>

Customers subscribing to BellSouth Metro Ethernet Service may migrate to AT&T Switched Ethernet Service provided by the Company without incurring termination charges, subject to the following conditions:

- The new AT&T Switched Ethernet Service and the existing BellSouth Metro Ethernet Service must be billed to the same customer of record at the same customer locations.
- The customer's existing service must have been in place for at least 12 months.
- The minimum term for the new service must be at least 12 months and must be equal to or greater than the number of months remaining in the customer's existing Transport Payment Plan (TPP) term.
- The speed (capacity/bandwidth) of the new service must be equal to or greater than that of the existing service.
- The customer must issue a disconnect order for the replaced BellSouth Metro Ethernet Service to be effective within 90 days after the AT&T Switched Ethernet Service installation date. The disconnect and new orders must be coordinated through the Company.
- If overlapping service is required, the period will be limited to not more than 90 days and billing will apply to both services during the time both services are available.

Note 1: Effective on or after August 22, 2021, this Service will no longer be available for purchase by new or existing customers. In addition, requests to move, add, change, or renew existing service arrangements will not be accepted. Following the expiration of a customer's existing term agreement, service will be provided on a month-to-month basis at the applicable Monthly rates until the service is discontinued. The Company currently plans to discontinue this service on or after March 31, 2023.

(N)  
|  
(N)



## E7. DEDICATED ACCESS SERVICES

### E7.3 Channel Interface and Network Channel Codes

This section explains the Channel Interface codes and Network Channel codes that the customer must specify when ordering Dedicated Access Service. Included is an example which explains the specific characters of the code, a glossary of Channel Interface codes, impedance levels, and Network Channel codes. Compatible Channel Interface codes are contained in the services respective Technical Reference Publications as indicated in E7.2.

Example: If the customer specifies a LB Network Channel Code and a 2LC8 Channel Interface at the customer's premises, the following is being requested:

LB = Voice Grade<sup>1</sup> (a.k.a. BellSouth SPA DS0 VG) Channel with a Predefined Technical Specification Package (1) (C)

2 = Number of physical wires at customer premises

LC = Facility interface for Type C Signaling

8 = Variable impedance level

#### E7.3.1 Glossary of Channel Interface Codes and Options

Code - Option	Definition	
AB -	Accepts 20 Hz ringing signal at customer's point of termination	
AC -	Accepts 20 Hz ringing signal at the customer's point of termination	
CS -	Digital hierarchy interface at Digital Crossconnect System (DCS)	
- EA	E & M Signaling	
- GO	Ground Start Loop Signaling-Open End	
- GS	Ground Start Loop Signaling-Closed End	
- LO	Loop Start Loop Signaling-Open End	
- LS	Loop Start Loop Signaling-Closed End	
- NO	Transmission Only - No Signaling	
- R	(DS0) Customer Reconfigurable Voice Grade Service <sup>1</sup>	(C)
- 10R	DS1 to DS0 Customer Reconfigurable <sup>1</sup>	(C)
	<b>(DELETED)</b>	(D)
- 10	DS1 to DS0 <sup>1</sup>	(C)

Note 1: Effective June 30, 2021, this Service will no longer be available for purchase by new or existing customers. In addition, requests to move, add, change, or renew existing service arrangements will not be accepted. Following the expiration of a customer's existing term agreement, service will be provided on a month-to-month basis at the applicable Monthly rates until the service is discontinued. The Company currently plans to discontinue this service on or after June 30, 2024. (N)

## E7. DEDICATED ACCESS SERVICES<sup>1</sup>

### E7.3 Channel Interface and Network Channel Codes (Cont'd)

#### E7.3.1 Glossary of Channel Interface Codes and Options (Cont'd)

Code - Option	Definition
- 11R	DS1 to DS1 Customer Reconfigurable
- 11	DS1 to DS1
- SP	Resistive Type: Split Path Operation for Data Polling Conference Type
- CF	Resistive Type: Split Path Operation for Symmetrical Voice Conference Type
- BC	CO Bridging: Broadcast for Broadcast Conference Type
CT -	Centrex Tie Trunk Termination
DA -	Data stream in VF frequency band at customer's point of termination
DB -	Data stream in VF frequency band at customer's point of termination
- 10	VF for TG1 and TG2
- 43	VF for 43 Telegraph <sup>2</sup> Carrier type signals, TG1 and TG2
DD -	Dataphone <sup>®</sup> Select-A-Station (and TABS) interface at customer's point of termination
DE -	Dataphone <sup>®</sup> Select-A-Station (and TABS) interface at the customer's end user's point of termination
DS -	Digital hierarchy interface
- 1K	1.544 Mbps (DS1) ANSI Extended Superframe (ESF) format
- 1S	1.544 Mbps (DS1) ANSI Extended Superframe (ESF) format and B8ZS Clear Channel Capability
- 15	1.544 Mbps (DS1) Superframe (SF) format
- 15B	1.544 Mbps (DS1) Superframe (SF) format and B8ZS Clear Channel Capability
- 15E	8-bit PCM encoded in one 64 Kbps of the DS1 signal
- 15F	8-bit PCM encoded in two 64 Kbps of the DS1 signal
- 15G	8-bit PCM encoded in three 64 Kbps of the DS1 signal
- 15H	14/11-bit PCM encoded in six 64 Kbps of the DS1 signal
- 15J	1.544 Mbps format per PUB 41451 (only available to U.S. Govt. agencies)
- 31	3.152 Mbps (DS1C)
- 31L	3.152 Mbps (DS1C) with SF signaling
- 44	44.736 Mbps (DS3)

**Note 1:** Text is shown as new due to reissue of all Tariff Sections. No changes in rates or regulations were made with this Filing.

**Note 2:** Effective June 30, 2021, this Service will no longer be available for purchase by new or existing customers. In addition, requests to move, add, change, or renew existing service arrangements will not be accepted. Following the expiration of a customer's existing term agreement, service will be provided on a month-to-month basis at the applicable Monthly rates until the service is discontinued. The Company currently plans to discontinue this service on or after June 30, 2024.

(C)

(N)

(N)

## E7. DEDICATED ACCESS SERVICES<sup>1</sup>

### E7.3 Channel Interface and Network Channel Codes (Cont'd)

#### E7.3.1 Glossary of Channel Interface Codes and Options (Cont'd)

Code - Option	Definition
- 44L	44.736 Mbps (DS3) with SF signaling
- 63	6.312 Mbps (DS2)
- 63L	6.312 Mbps (DS2) with SF signaling
DU -	Digital access interface
- 19(S) <sup>2</sup>	19.2 Kbps <sup>3</sup>
- 24(S) <sup>2</sup>	2.4 Kbps <sup>3</sup>
- 48(S) <sup>2</sup>	4.8 Kbps <sup>3</sup>
- 56(S) <sup>2</sup>	56.0 Kbps <sup>3</sup>
- 64	64.0 Kbps <sup>3</sup>
- 96(S) <sup>2</sup>	9.6 Kbps <sup>3</sup>
- 1KN	DS1 (1.544 Mbps) ANSI Extended Superframe (ESF) Format per TR-NPL-000054 without line power
- 1SN	DS1 (1.544 Mbps) ANSI Extended Superframe (ESF) Format per TR-NPL-000054, with B8ZS Clear Channel Capability and without line power
- A	DS1 (1.544 Mbps) free-framing format per PUB 41451 with line power (only available to U. S. Govt. agencies)
- AN	DS1 (1.544 Mbps) free-framing format per PUB 41451 without line power (only available to U. S. Govt. agencies)
- BN	DS1 (1.544 Mbps) Superframe (SF) Format per TR-NPL-000054 without line power
- DN	DS1 (1.544 Mbps) Superframe (SF) Format per TR-NPL-000054, with B8ZS Clear Channel Capability and without line power.
- SN	1.544 Mbps (DS1) ANSI Extended Superframe (ESF) format and B8ZS Clear Channel Capability
DV -	Data and Voice Multiplexing
- BC	Digital Data Over Voice, 9.6 Kbps <sup>3</sup>
DX -	Duplex signaling interface at customer's point of termination
EA - E	Type I, E&M Lead Signaling. Customer at POT or end user at POT originates one E Lead.
EA - M	Type I E&M Lead Signaling. Customer at POT or end user at POT originated on M Lead.

(C)  
 |  
 (C)

(C)

**Note 1:** Text is shown as new due to reissue of all Tariff Sections. No changes in rates or regulations were made with this Filing.

**Note 2:** (S) is an additional BellSouth designation for use when the optional Secondary Channel feature is required.

**Note 3:** Effective June 30, 2021, this Service will no longer be available for purchase by new or existing customers. In addition, requests to move, add, change, or renew existing service arrangements will not be accepted. Following the expiration of a customer's existing term agreement, service will be provided on a month-to-month basis at the applicable Monthly rates until the service is discontinued. The Company currently plans to discontinue this service on or after June 30, 2024.

(N)  
 |  
 (N)

EFFECTIVE: July 15, 1996

## E7. DEDICATED ACCESS SERVICES<sup>1</sup>

(N)

### E7.3 Channel Interface and Network Channel Codes (Cont'd)

#### E7.3.1 Glossary of Channel Interface Codes and Options (Cont'd)

Code - Option	Definition
EB - E	Type II, E&M Lead Signaling. Customer at POT or end user at POT originates on E Lead.
EB - M	Type II E&M Lead Signaling. Customer at POT or customer's end user at POT originates on M Lead.
EC -	Type III, E&M signaling at customer POT.
EX - A	Tandem channel unit signaling for loop start or ground start and customer supplies open end (dial tone, etc.) functions.
- B	Tandem channel unit signaling for loop start or ground start and customer supplies closed end (dial pulsing, etc.) functions.
GO -	Ground start loop signaling - open end function by customer or customer's end user
GS -	Ground start loop signaling - closed end function by customer or customer's end user
- C	Centrex foreign exchange termination
- M	For terminating in central office located answering service concentrator
LA -	End user loop start loop signaling - Type A OPS registered port open end
LB -	End user loop start loop signaling - Type B OPS registered port open end
LC -	End user loop start loop signaling - Type C OPS registered port open end
LO -	Loop start loop signaling - open end function by customer or customer's end user
LR -	20 Hz automatic ringdown interface at customer with Company provided PLAR
LS -	Loop start loop signaling - closed end function by customer or customer's end user
- M	For terminating in central office located answering service concentrator
NO -	No signaling interface, transmission only
PR -	Protective relaying <sup>2</sup>
RV - O	Reverse battery signaling, one way operation, originate by customer

**Note 1:** Text is shown as new due to reissue of all Tariff Sections. No changes in rates or regulations were made with this Filing.

**Note 2:** Available only for the transmission of audio tone protective relaying signals used in the protection of electric power systems during fault conditions.

## E7. DEDICATED ACCESS SERVICES

### E7.3 Channel Interface and Network Channel Codes (Cont'd)

#### E7.3.1 Glossary of Channel Interface Codes and Options (Cont'd)

Code - Option	Definition	
- T	Reverse battery signaling, one way operation, terminate function by customer or customer's end user	
SF -	Single frequency signaling within VF band at either customer POT or customer's end user POT	(C)
TF -	Telephotograph <sup>2</sup> interface	(C)
TT -	Telegraph <sup>2</sup> /teletypewriter interface at either customer POT or customer's end user POT	(C)
- 2	20.0 milliamperes	
- 3	3.0 milliamperes	
- 6	62.5 milliamperes	
	<b>(DELETED)</b>	
	<b>(DELETED)</b>	

#### E7.3.2 Impedance

The nominal reference impedance with which the channel will be terminated for the purpose of evaluating transmission performance:

Value (ohms)	Code(s)
110	0
150	1
600	2
900	3 <sup>1</sup>
135	5
75	6
124	7
Variable	8
100	9

Note 1: For those interface codes with a 4-wire transmission path at the customer designated POT, rather than a standard 900 ohm impedance, the code (3) denotes a customer provided transmission equipment termination. Such terminations were provided to customers in accordance with the FCC Docket No. 20099 Settlement Agreement.

Note 2: Effective June 30, 2021, this Service will no longer be available for purchase by new or existing customers. In addition, requests to move, add, change, or renew existing service arrangements will not be accepted. Following the expiration of a customer's existing term agreement, service will be provided on a month-to-month basis at the applicable Monthly rates until the service is discontinued. The Company currently plans to discontinue this service on or after June 30, 2024.

(N)  
 |  
 (N)

**E7. DEDICATED ACCESS SERVICES<sup>1</sup>**

(N)

**E7.3 Channel Interface and Network Channel Codes (Cont'd)**

**E7.3.3 Digital Hierarchy Channel Interface Codes (4DS)**

Customers selecting the channelized four-wire DS-1 or higher facility interface option at the customer designated premises will be requested to provide subsequent system and channel assignment data. The various digital bit rates in the digital hierarchy employ the channel interface code 4DS9, 4DS0 or 4DS6 plus the speed options indicated following:

Interface Code and Speed Option	Nominal Bit Rate (Mbps)	Digital Hierarchy Level
4DS9-15	1.544	DS1
4DS9-31	3.152	DS1C
4DS0-63	6.312	DS2
4DS6-44	44.736	DS3

**E7.3.4 Service Designator/Network Channel Code Conversion Table**

The purpose of this table is to show the relationship between the service designator codes (e.g. VG2, DA1, etc.,) and the network channel codes that are used for various administrative purposes.

Service Designator Code	Network Channel Code
TG1	NW
TG2	NY
VG1	LB
VG2	LC
VG3	LD
VG4	LE
VG5	LF
VG6	LG
VG7	LH
VG8	LJ
VG9	LK
VG10	LN
VG11	LP
VG12	LR
TV3	TZ
DA1	XA
DA2	XB
DA3	XG

**Note 1:** Text is shown as new due to reissue of all Tariff Sections. No changes in rates or regulations were made with this Filing.

## E7. DEDICATED ACCESS SERVICES

(T)

### E7.3 Channel Interface and Network Channel Codes (Cont'd)

#### E7.3.4 Service Designator/Network Channel Code Conversion Table (Cont'd)

Service Designator Code	Network Channel Code
DA4	XH
DA5	XE
DA6	YN
HC0	HS
HC1	HC
HC1C	HD
HC2	HE
HC3	HF
HC14T	HK-A
HC16T	HK-B

### E7.4 Rate Regulations

This section contains the specific regulations governing the rates and charges that apply for Dedicated Access Services.

#### E7.4.1 Types of Rates and Charges

- A. There are *two* types of rates and charges. These are monthly rates and nonrecurring charges. The rates and charges are described as follows:

(C)

##### Monthly Rates

Monthly rates are flat recurring charges that apply each month or fraction thereof that a Dedicated Access Service is provided. Minimum periods are specified in E5.2.5.

## E7. DEDICATED ACCESS SERVICES

### E7.4 Rate Regulations (Cont'd)

#### E7.4.1 Types of Rates and Charges (Cont'd)

##### A. (Cont'd)

Digital Data Access<sup>3</sup> Service and Derived Data Channel<sup>3</sup> (a.k.a. BellSouth SPA Derived Data Channel) service are offered under two contract plans. Contract plan rates are available in payment periods from twenty-four to forty-two months<sup>2</sup> and in payment periods from forty-three to sixty months<sup>2</sup> under conditions specified in the Channel Services Payment Plan in E2.4 of this Tariff. (These payment periods are an exception to those listed in E2.4 of this Tariff.) Termination Liability charges will not apply for customer requests for moves of service under CSPP subject to the provisions set forth in E2.4.9.A.11. of this Tariff. However, a Termination Liability Charge is applicable at the date of termination if the customer terminates or disconnects the service prior to fulfilling the period of the contract plan except as specified in 2. following. The Termination Liability Charge is determined by multiplying the contracted monthly rate times the number of months in the contract plan, less the contracted monthly rate times the number of months the service has been installed, **multiplied by a factor. The factor is fifty percent (50%) for contracts that have been in effect twelve months (12) or less, or twenty percent (20%) for contracts that have been in effect longer than twelve months (12).** An example is provided in 1. following.

The following list identifies the individual Dedicated Access Services provided under Section E7. of this Tariff which are eligible for credit of nonrecurring charges under "Service Installation Guarantee" found in E2.4.10 of this Tariff. Customers with these services are not eligible for the Service Installation Guarantee when the requested installation, move or rearrangement service order interval is four days or less as measured from the Application Date of the order.

- Voice Grade<sup>3</sup> (a.k.a. BellSouth SPA DS0 VG),
- Digital Data Access<sup>3</sup> (a.k.a. BellSouth SPA Derived Data Channel) service<sup>1</sup>,
- High Capacity (a.k.a. BellSouth SPA High Capacity) service
- SMARTPath service (a.k.a. BellSouth SPA Shared Ring)

Provided, however, that the following services are not eligible for such credit.

- FlexServ service (a.k.a. BellSouth SPA Customer Reconfiguration)
- BellSouth Metro Ethernet<sup>4</sup> service

1. A customer subscribes to Digital Data Access<sup>3</sup> (a.k.a. BellSouth SPA DS0 Digital Data) service using the twenty-four to forty-two month payment plan. The contract plan period is for thirty months. The subscriber terminates the service after twelve months. The total liability charge is thirty months times the monthly rate. The amount is then reduced to reflect the number of months the subscriber has had the service, which in this example is twelve months. Therefore, the Termination Liability Charge is **fifty percent (50%) of this amount** calculated as follows:  
$$\text{Termination Liability Charge} = .50 \times [(30 \text{ months} \times \text{monthly rate}) - (12 \text{ months} \times \text{monthly rate})]$$
2. A Termination Liability Charge will not be applicable at the date of termination if the customer terminates or disconnects the service prior to fulfilling the period of the contract plan for customer requested changes to a higher order of service covered by the Channel Services Payment Plan as specified in E2.4.9.A.4.b. of this Tariff, or customer requested changes to services not covered by the Channel Services Plan that are offered by the Company under a contract payment plan provided that the applicable conditions set forth in E2.4.9.A.4.b. of this Tariff are satisfied.

**Note 1:** The Data Over Voice Channel optional feature is not eligible for such credit.

**Note 2:** Effective March 23, 2019, Customers may not: Convert, renew, or establish CSPPs for Derived Data Channel Service, Digital Data Access Service.

**Note 3:** Effective June 30, 2021, this Service will no longer be available for purchase by new or existing customers. In addition, requests to move, add, change, or renew existing service arrangements will not be accepted. Following the expiration of a customer's existing term agreement, service will be provided on a month-to-month basis at the applicable Monthly rates until the service is discontinued. The Company currently plans to discontinue this service on or after June 30, 2024.

**Note 4:** Effective on or after August 22, 2021, this Service will no longer be available for purchase by new or existing customers. In addition, requests to move, add, change, or renew existing service arrangements will not be accepted. Following the expiration of a customer's existing term agreement, service will be provided on a month-to-month basis at the applicable Monthly rates until the service is discontinued. The Company currently plans to discontinue this service on or after March 31, 2023.

(C)

(N)  
|  
(N)



## E7. DEDICATED ACCESS SERVICES

### E7.4 Rate Regulations (Cont'd)

#### E7.4.1 Types of Rates and Charges (Cont'd)

A. (Cont'd)

Contract rates are available for 1.544 Mbps High Capacity (a.k.a. BellSouth SPA High Capacity) service for variable periods, with rates based on lengths of 36 months<sup>2,3</sup>, 60 months<sup>2,3</sup>, or 84 months<sup>1,2,3</sup> under conditions specified in the Channel Service Payment Plan in E2.4 of this Tariff. A Termination Liability Charge is applicable at the date of termination. The applicable charge will be equal to fifty percent of the following: the number of months remaining in the contract times the monthly contract rate. However, Termination Liability charges will not apply for customer requests for moves of service under CSPP subject to the provisions set forth in E2.4.9.A.11. preceding. (C)

Rates applicable to a month-to-month payment option are subject to Company initiated changes.

B. Nonrecurring Charges

Nonrecurring charges are one-time charges that apply for specific work activity (i.e., installation or change to an existing service). The types of nonrecurring charges that apply for Dedicated Access Services are: installation of service, installation of optional features and functions, and service rearrangements.

**Note 1:** Effective March 23, 2019, Customers may not: (1) Establish CSPPs greater than 36 months for High Capacity Service, and (2) Convert or renew CSPPs for High Capacity Service.

**Note 2:** Effective November 1, 2022, customers may not establish new term plans of greater than 24 months for High Capacity Service Channel Service Payment Plans.

**Note 3:** Effective March 17, 2024, customers may not establish new term plans of greater than month-to-month for High Capacity Service Channel Service Payment Plans. (N)

## E7. DEDICATED ACCESS SERVICES

### E7.4 Rate Regulations (Cont'd)

#### E7.4.1 Types of Rates and Charges (Cont'd)

##### B. Nonrecurring Charges (Cont'd)

###### 1. Installation of Service

###### a. Local Channels

Nonrecurring charges apply to each Local Channel on each Dedicated Access Service installed. When one service is ordered and installed, it is billed at the First Service Installed rate. When more than one of the same type of service, between the same locations, for the same customer is ordered and installed at the same time, one at each location is billed at the First Service Installed Rate and the others are billed at the Additional Service Installed rate. If additional services are installed at a later date, then the First Service Installed rate and the Additional Service rate would apply to those services regardless of what service already existed.

###### b. Interoffice Channel Mileage

The nonrecurring charge for the Interoffice Channel mileage will be applied each time the Interoffice Channel rate element is applicable.

The nonrecurring charges for the Installation of Services are set forth in E7.5 following as nonrecurring charges for the Local Channel Rate Element and the Interoffice Channel Rate Element.

###### 2. Installation of Optional Features and Functions

Nonrecurring charges apply for the installation of some of the optional features and functions available with Dedicated Access Services. The Initial nonrecurring charge applies if the feature or function is installed coincident with the primary service. The Subsequent nonrecurring charge applies if the feature or function is installed after the installation of the primary service.

One nonrecurring charge is applicable to bridging.

First and Additional nonrecurring charges are applicable to activate each individual Central Office Channel Interface of a DS1 or DS0 Basic Channelization System<sup>1</sup>, and are in addition to the nonrecurring charges for the DS1 or DS0 Basic Channelization System<sup>1</sup>. A "First" Central Office Channel Interface nonrecurring charge is applicable to the first Central Office Channel Interface installed coincident with the installation of a DS1 or DS0 Basic Channelization System<sup>1</sup>, per service request. An "Additional" nonrecurring charge applies for each additional Central Office Channel Interface, of the same type, ordered and installed at the same location, for the same customer, at the same time, on the same order request. Future requests for a Central Office Channel Interface(s) on an existing DS1 or DS0 Basic Channelization System<sup>1</sup> will be treated as new requests and will require "First" and "Additional" Central Office Channel Interface nonrecurring charge application, in addition to any other applicable charge(s).

One nonrecurring charge is applicable for each individual DS1 level Central Office or Customer channel interface and is in addition to any other applicable charge(s).

The nonrecurring charges for the installation of optional features and functions are set forth in E7.5 following as nonrecurring charges for optional features and functions associated with the specific services.

Note 1: Effective June 30, 2021, this Service will no longer be available for purchase by new or existing customers. In addition, requests to move, add, change, or renew existing service arrangements will not be accepted. Following the expiration of a customer's existing term agreement, service will be provided on a month-to-month basis at the applicable Monthly rates until the service is discontinued. The Company currently plans to discontinue this service on or after June 30, 2024.

(C)  
|  
(C)

(C)

(N)  
|  
(N)

## E7. DEDICATED ACCESS SERVICES

### E7.4 Rate Regulations (Cont'd)

#### E7.4.1 Types of Rates and Charges (Cont'd)

##### B. Nonrecurring Charges (Cont'd)

##### 3. Service Rearrangements

Service rearrangements are changes to existing (installed) services which do not result in either a change in the minimum period requirements as set forth in E5.2.5.E. or a change in the physical location of the point of the termination at a customer designated premises. Changes which result in the establishment of new minimum period obligations are treated as disconnects and starts. Changes in the physical location of the point of the termination are treated as moves and are described and charged for as set forth in E7.4.5 following. A change which results from a transfer of service is described and charged as set forth in 4. and E7.5.13 following.

The charge to the customer for the service rearrangement is dependent on whether the change is administrative only in nature or involves actual physical change to the service.

Administrative changes, identified as follows, will be made without charge(s) to the customer. Such changes require the continued provision and billing of the Dedicated Access Service to the same entity (i.e., customer remains responsible for all outstanding indebtedness for the Dedicated Access Service). Administrative changes are as follows:

- Change of customer name (i.e., the customer of record does not change but rather the customer of record changes its name -- e.g., AT&T-Long Lines to AT&T-Communications),
- Change of customer or customer's end user premises address when the change of address is to a result of a physical relocation of equipment,
- Change in billing data (name, address, or contact name or telephone number. The customer of record does not change).
- ~H~Change of customer circuit identification,
- Change of billing account number,
- Change of customer test line number,
- Change of customer or customer's end user contact name or telephone number, and
- Change of jurisdiction.

All other service rearrangements, including physical changes to existing services, will be charged for as follows:

- If the change involves the addition of other customer designated premises to an existing multipoint service, the nonrecurring charge for the Local Channel rate element will apply. The charge(s) will apply only for the location(s) that is being added.
- If the change involves the addition of an optional feature or function which has a separate nonrecurring charge, that nonrecurring charge will apply.
- If the change involves changing the type of signaling on a Voice Grade<sup>1</sup> (a.k.a. BellSouth SPA DS0 VG) service, a charge equal to the Voice Grade<sup>1</sup> (a.k.a. BellSouth SPA DS0 VG) Local Channel rate element nonrecurring charge will apply. The charge will apply per service termination affected.

(C)  
(C)

Note 1: Effective June 30, 2021, this Service will no longer be available for purchase by new or existing customers. In addition, requests to move, add, change, or renew existing service arrangements will not be accepted. Following the expiration of a customer's existing term agreement, service will be provided on a month-to-month basis at the applicable Monthly rates until the service is discontinued. The Company currently plans to discontinue this service on or after June 30, 2024.

(N)  
|  
(N)

## E7. DEDICATED ACCESS SERVICES

### E7.4 Rate Regulations (Cont'd)

#### E7.4.1 Types of Rates and Charges (Cont'd)

##### B. Nonrecurring Charges (Cont'd)

##### 3. Service Rearrangements (Cont'd)

- If the change involves changing a customer's 1.544 Mbps high capacity service, as described in E7.2.9, to SMARTPath service (a.k.a. BellSouth SPA Shared Ring), the change will be considered a disconnect of the existing service and full nonrecurring charges apply for the SMARTPath service (a.k.a. BellSouth SPA Shared Ring). If the existing 1.544 Mbps high capacity service is provided under a Channel Services Payment Plan (CSPP) agreement, a change to SMARTPath service (a.k.a. BellSouth SPA Shared Ring) under CSPP will be considered an upgrade and termination liability charges will not apply.

- If the change involves changing (reconfiguring) an existing BellSouth Metro Ethernet<sup>1</sup> service Connection, appropriate charges provided in E7.4.32. (C)

- If the change involves the addition of a DS3 Network Interface Unit (NIU) to a SMARTRing<sup>2</sup> service (a.k.a. BellSouth SPA Dedicated Ring) the rates and charges shown in E13.3.25. (C)

- For all other changes, including a change of the customer of record involving no physical changes to the service provided or the addition of optional features without separate nonrecurring charges, a charge equal to a Local Channel rate element nonrecurring charge will apply. Only one such charge will apply per service, per change.

##### 4. Transfer of Service

When a change in billing data (e.g., name, address, contact name, or telephone number) is requested in association with a change in the customer of record, transfer of service charges, as set forth in E7.5.13. Charges are applied on a Billing Account Number (BAN) and per circuit basis.

#### E7.4.2 Dedicated Access Services Capable of Using the Local Exchange Network

##### A. General

When a Dedicated Access Line, intraLATA interexchange private line or Private Bypass facility is connected to a device capable of interconnecting the Dedicated Access line, intraLATA interexchange private line or Private Bypass facility to the Local Exchange Network, the Exchange Service Rate associated with that device (e.g., the PBX trunk in the case of a PBX) will be rated as Message or Measured Service as specified in the Local Exchange Company's General Subscriber Service Tariff.

##### B. Application of Measured or Message Service

Application of Measured or Message exchange service charges for services existing on the effective date of this Tariff will commence March 16, 1986, unless the certification process described in E7.4.2.C. following is met on or before February 8, 1986. For new Dedicated Access services, intraLATA interexchange private line or Private Bypass facilities ordered on or after the effective date of this Tariff and terminating for an end user at the same address at which a PBX trunk or other similar exchange service is also provided, that exchange service will automatically be rated on a Measured or Message basis unless the certification process described in C. following is met. Measured or Message service rates will be applied at the discretion of the Local Exchange Company for exchange services not certified by the process described in E7.4.2.C.

**Note 1:** Per Filing T20210063, effective on or after August 22, 2021, this Service will no longer be available for purchase by new or existing customers. In addition, requests to move, add, change, or renew existing service arrangements will not be accepted. Following the expiration of a customer's existing term agreement, service will be provided on a month-to-month basis at the applicable Monthly rates until the service is discontinued. The Company currently plans to discontinue this service on or after March 31, 2023. (N)

**Note 2:** Effective on or after December 1, 2021, neither new nor existing customers will be permitted to purchase new SMARTRing Service (Service). In addition, (A) Service Payment Plans greater than 12-months in length will no longer be available; and (B) requests to move, add, change, upgrade, or downgrade existing service arrangements will not be accepted, with the following exceptions: (1) existing customers will be permitted to modify their existing Service and will be able to add new circuits to their existing Service, but will not be permitted to add new nodes in any locations; and (2) any such new circuits will be subject to the customer's existing term payment plan or term agreement for the Service to which they are added. Following the expiration of a customer's existing term agreement, Service will be provided on a month-to-month basis at the applicable Month-to-Month rates until the Service is discontinued. (N)

Effective November 30, 2023, unless specified to the contrary in their existing Service agreements, existing customers may not renew Term Payment Plans or term agreements for Service. In addition, no move, add, or change orders of any type will be accepted. (N)

## E7. DEDICATED ACCESS SERVICES

### E7.4 Rate Regulations (Cont'd)

#### E7.4.2 Dedicated Access Services Capable of Using the Local Exchange Network (Cont'd)

C. Certification Process

The certification will be in the form of a written notification to the Company certifying that calls are not completed into the Local Exchange Network over the Dedicated Access line, intraLATA interexchange private line or Bypass Facility. The notification may be provided (1) on or before February 8, 1986, for service existing on the effective date, (2) at the time new service is ordered or (3) at such time the Dedicated Access service, intraLATA interexchange private line or Bypass Facility is reterminated to a device not capable of interconnecting to the local exchange network. If a written certification is not received at the time an order for service is placed, message/measured exchange service will apply. Exempt status will become effective on the date certification is received by the Company.

D. Change of Status

The Company will cease billing message/measured exchange service rates when certification that the service has become exempt as set forth in C., preceding is received.

#### E7.4.3 Reserved for Future Use

#### E7.4.4 Minimum Periods

The minimum service periods are specified in E5.2.6 of this Tariff, except for SMARTPath service (a.k.a. BellSouth SPA Shared Ring), BellSouth Metro Ethernet<sup>1</sup> service and SmartRing<sup>2</sup> service (a.k.a. BellSouth Dedicated Ring) whose minimum service period is 4 months. (C)

The minimum service period for High Capacity ICB (a.k.a. BellSouth SPA High Capacity) services is specified in the Individual Case Basis Filing.

#### E7.4.5 Moves

A move involves a change in the physical location of one of the following:

- The Point of Termination at the customer's premises
- The customer's premises

The charges for the move are dependent on whether the move is to a new location within the same building or to a different building.

A. Moves Within the Same Building

When the move is to a new location within the same building, the charge for the move will be an amount equal to one half of the nonrecurring (i.e., installation) charge for the service termination affected. There will be no change in the minimum period requirements.

**Note 1:** Per Filing T20210063, effective on or after August 22, 2021, this Service will no longer be available for purchase by new or existing customers. In addition, requests to move, add, change, or renew existing service arrangements will not be accepted. Following the expiration of a customer's existing term agreement, service will be provided on a month-to-month basis at the applicable Monthly rates until the service is discontinued. The Company currently plans to discontinue this service on or after March 31, 2023. (N)

**Note 2:** Effective on or after December 1, 2021, neither new nor existing customers will be permitted to purchase new SMARTRing Service (Service). In addition, (A) Service Payment Plans greater than 12-months in length will no longer be available; and (B) requests to move, add, change, upgrade, or downgrade existing service arrangements will not be accepted, with the following exceptions: (1) existing customers will be permitted to modify their existing Service and will be able to add new circuits to their existing Service, but will not be permitted to add new nodes in any locations; and (2) any such new circuits will be subject to the customer's existing term payment plan or term agreement for the Service to which they are added. Following the expiration of a customer's existing term agreement, Service will be provided on a month-to-month basis at the applicable Month-to-Month rates until the Service is discontinued. (N)

Effective November 30, 2023, unless specified to the contrary in their existing Service agreements, existing customers may not renew Term Payment Plans or term agreements for Service. In addition, no move, add, or change orders of any type will be accepted. (N)

ISSUED: July 1, 1996

EFFECTIVE: July 15, 1996

BY: Joseph P. Lacher, President - FL  
Miami, Florida

## E7. DEDICATED ACCESS SERVICES<sup>1</sup>

(N)

### E7.4 Rate Regulations (Cont'd)

#### E7.4.5 Moves (Cont'd)

##### B. Moves to a Different Building

Moves to a different building (customer premises) in a wire center serving area different than the customer's existing serving wire center serving area, other than addressed in C. following, will be treated as a discontinuance and start of service and all associated nonrecurring charges will apply. Service will not be available simultaneously at both the original and new locations. New minimum period requirements may be established for the rearranged services in accordance with the regulations for the service. The customer will also remain responsible for satisfying all outstanding minimum period charges for the discontinued service. When the move involves a multipoint service, the nonrecurring charge will apply per rate element affected.

Moves to a Company-provided EIS interconnection arrangement, where the customer's and interconnector's existing wire center is the same, will be treated as a service move rather than a discontinuance and start of service. Cross connect rates, nonrecurring charges, and optional feature and function charges as contained in Section E20. following, will apply. In addition, service reconfiguration charges are applicable per customer request and per circuit moved as contained in E7.5.12 following. Individual services will not be available simultaneously at both the original premises location and new wire center interconnection space. Additional cooperative end-to-end testing is available and will be conducted by the Company when requested at rates and charges contained in E13.3.5 following. New minimum period requirements may be established for the rearranged services in accordance with the regulations for a service. The customer will remain responsible for satisfying all outstanding minimum period charges for the original service locations. When the move involves a multipoint service, the nonrecurring charge will apply per rate element affected.

Moves to a different building (customer premises) in the customer's existing serving wire center serving area will be treated as a service move rather than a discontinuance and start of service. Nonrecurring charges for the new local channel will apply as well as any optional feature and function charges for that local channel. In addition, service reconfiguration charges are applicable per customer request and circuit moved as contained in E7.5.12 following. Service will not be available simultaneously at both the original and new customer locations. Additional cooperative end-to-end testing is available and will be conducted by the Company at a customer's request at rates and charges contained in E13.3.5 following. New minimum period requirements may be established for the rearranged services in accordance with the regulations for a service. The customer will also remain responsible for satisfying all outstanding minimum period charges for the original service locations. When the move involves a multipoint service, the nonrecurring charge will apply per rate element affected.

##### C. Moves of Service(s) under CSPP

Customer requests for moves of service under CSPP, other than inside moves, will be subject to the conditions stated in E2.4.9.A.8. preceding.

#### E7.4.6 Mileage Measurement

The mileage to be used to determine the monthly rate for the Interoffice Channel is calculated on the airline distance between the locations involved, i.e., the serving wire centers associated with two customer designated premises, a serving wire center associated with a customer designated premises and a Company Hub, and a serving wire center associated with a customer designated premises, or two Company Hubs. The serving wire center associated with a customer designated premises is the serving wire center from which the customer designated premises would normally obtain dial tone.

**Note 1:** Text is shown as new due to reissue of all Tariff Sections. No changes in rates or regulations were made with this Filing.

## E7. DEDICATED ACCESS SERVICES

### E7.4 Rate Regulations (Cont'd)

#### E7.4.6 Mileage Measurement (Cont'd)

Mileage is shown in E7.5 following in terms of mileage bands. To determine the rate to be billed, first compute the mileage using the V&H coordinates method, as set forth in the National Exchange Carrier Association Tariff FCC. No. 4, then find the band into which the computed mileage falls and apply the rates shown for that band. When the calculation results in a fraction of a mile, always round up to the next whole mile before determining the mileage band and applying the rates.

When Hubs are involved, mileage is computed and rates applied separately for each section of the Interoffice Channel, i.e., customer designated premises serving wire center to Hub, Hub to Hub and/or Hub or customer designated premises serving wire center. However, when any service is routed through a Hub for purposes other than customer specified bridging or channelization (e.g., the Company chooses to so route for test access purposes), rates will be applied only to the distance calculated between the serving wire centers associated with the IC or End User designated premises. For the purpose of applying multipoint charges, the bridging or hubbing locations are determined by that combination of airline distances connecting the serving wire center which will produce the lowest interoffice mileage charges.

SMARTRing<sup>®</sup> service (a.k.a. BellSouth Dedicated Ring) Local Channel, Alternate Central Office Channel and Internodal Channel rates are also distance sensitive. They are measured per quarter airline mile or fraction thereof from the customer's designated premises to the Serving Wire Center, Alternate Central Office, or other Customer Nodes. V&H coordinates are derived for each customer location through the use of longitude and latitude measurements. Using the V&H coordinate method as set forth in the NATIONAL EXCHANGE CARRIER ASSOCIATION, INC. TARIFF FCC. No. 4, compute the mileage, convert to quarter miles, and multiply the appropriate per quarter mile rate by the distance involved. Any portion of a quarter mile will always round up to the next quarter mile before determining the mileage and applying the rate. (C)

The SMARTRing<sup>®</sup> service (a.k.a. BellSouth Dedicated Ring) Interoffice Channel mileage is calculated per quarter airline mile between two directly connected central office's on the ring. Interoffice Channel mileage is computed by using the V&H coordinates method as set forth in the NATIONAL EXCHANGE CARRIER ASSOCIATION, INC. TARIFF FCC. No. 4. To determine the rate to be billed, multiply the appropriate per quarter mile rate by the distance involved. Fractions of a quarter mile always round up to the next quarter mile before determining the mileage and applying the rate. (C)

#### E7.4.7 Facility Hubs

A customer has the option of ordering digital high capacity facilities (i.e., DS1, DS1C, DS2 or DS3) to a facility Hub for channelizing to individual services requiring lower capacity facilities (e.g., Voice<sup>1</sup>, etc.).

Different locations may be designated as Hubs for different facility capacities, e.g., channelization from digital to digital may occur at one location while channelization from digital to analog may occur at a different location. When ordering, the customer will specify the desired channelization Hub(s) selected from the National Exchange Carrier Association Tariff FCC. No. 4. This Tariff identifies the type(s) of channelization functions which are available and the serving wire centers at which they are available.

Some of the types of channelization available include the following:

- from higher to lower bit rate
- from digital to voice frequency channels

End to end services may be provided on channels of these facilities to a hub. The transmission performance for the end to end service provided between customer designated premises will be that of the lower capacity or bit rate. For example, when a 1.544 Mbps facility is channelized to voice frequency channels, the transmission performance of the channelized services will be Voice Grade<sup>1</sup> (a.k.a. BellSouth SPA DS0 VG), not High Capacity (a.k.a. BellSouth SPA High Capacity).

**Note 1:** Effective June 30, 2021, this Service will no longer be available for purchase by new or existing customers. In addition, requests to move, add, change, or renew existing service arrangements will not be accepted. Following the expiration of a customer's existing term agreement, service will be provided on a month-to-month basis at the applicable Monthly rates until the service is discontinued. The Company currently plans to discontinue this service on or after June 30, 2024.

**Note 2:** Effective on or after December 1, 2021, neither new nor existing customers will be permitted to purchase new SMARTRing Service (Service). In addition, (A) Service Payment Plans greater than 12-months in length will no longer be available; and (B) requests to move, add, change, upgrade, or downgrade existing service arrangements will not be accepted, with the following exceptions: (1) existing customers will be permitted to modify their existing Service and will be able to add new circuits to their existing Service, but will not be permitted to add new nodes in any locations; and (2) any such new circuits will be subject to the customer's existing term payment plan or term agreement for the Service to which they are added. Following the expiration of a customer's existing term agreement, Service will be provided on a month-to-month basis at the applicable Month-to-Month rates until the Service is discontinued. (N)

Effective November 30, 2023, unless specified to the contrary in their existing Service agreements, existing customers may not renew Term Payment Plans or term agreements for Service. In addition, no move, add, or change orders of any type will be accepted. (N)

## E7. DEDICATED ACCESS SERVICES

### E7.4 Rate Regulations (Cont'd)

#### E7.4.7 Facility Hubs (Cont'd)

The Company will commence billing the monthly rate for the facility to the Hub on the date specified by the customer on the service order. Individual services utilizing these facilities may be installed coincident with the installation of the facility to the Hub or may be ordered and/or installed at a later date, at the option of the customer. The customer will be billed for a digital Local Channel, Interoffice Channel (when applicable) and the Basic Channelization System at the time the facility is installed. DS1 and DS0 Basic Channelization Systems<sup>1</sup> require a Central Office Channel Interface for activation of each lesser capacity channel. DS3 to DS1 channelization arrangements, for transport of intrastate DS1 service high capacity channels via LightGate (a.k.a. BellSouth SPA Point to Point Network) and SMARTRing<sup>2</sup> services (a.k.a. BellSouth Dedicated Ring), require a DS1 channel interface for activation of each DS1 channel. Individual service rates (by service type) will apply for a Local Channel and additional Interoffice Channel and Central Office Channel Interface(s) (as required) for each channelized service. These will be billed to the customer as each individual service is installed. (C)

Cascading channelization occurs when a digital channel is channelized to provide channels with a lesser capacity and one of the lesser capacity channels is further channelized. For example, a High Capacity (a.k.a. BellSouth SPA High Capacity) facility is channelized to individual Voice Grade<sup>1</sup> (a.k.a. BellSouth SPA DS0 VG) channels.

When cascading channelization is performed, whether in the same or a different Hub, a charge for the additional Basic Channelization System and Central Office Channel Interface(s) also applies. A DS1 Basic Channelization System and DDAS<sup>1</sup> (a.k.a. BellSouth SPA DS0 Digital Data) Central Office Channel Interface are required for high speed or low speed DDAS<sup>1</sup> (a.k.a. BellSouth SPA DS0 Digital Data) activations when channelized from a DS1 (1.544 Mbps) channel. A DS0 Basic Channelization System<sup>1</sup> and Subrate Central Office Channel Interface<sup>1</sup> are required for subrate<sup>1</sup> activations of 2.4, 4.8 and 9.6 Kbps when channelized from a DS0<sup>1</sup> (64 Kbps) channel. When cascading channelization is performed at different Hubbing locations, Interoffice Channel charges also apply between the Hubs.

#### E7.4.8 Shared Use Analog and Digital High Capacity (a.k.a. BellSouth SPA High Capacity) Services

Shared use occurs when Dedicated Access Services and BellSouth SWA are provided over the same High Capacity (a.k.a. BellSouth SPA High Capacity) facility through a common interface. The facility will be ordered and rated as Dedicated Access Services (i.e., Local Channel, Interoffice Channel, as appropriate, and Basic Channelization System and Central Office Interface(s), if applicable) until such time as the customer chooses to use a portion of the available capacity for providing BellSouth SWA as set forth in E5.2.8 of this Tariff. As each individual channel is activated for BellSouth SWA, the Dedicated Access Local Channel rates, Interoffice Channel rates, and Basic Channelization System rates, if applicable, will be reduced accordingly. For SMARTPath service (a.k.a. BellSouth SPA Shared Ring) the rates will be reduced by 1/48th for each BellSouth SWA VG Circuit. The customer must place an order for each individual Switched or Dedicated Access Service utilizing the Shared Use Facilities and specify the channel assignment for each such service. BellSouth SWA rates and charges as set forth in E6.8 of this Tariff will apply for each channel of the shared use facility that is used to provide BellSouth SWA. Where Dedicated Access Service is provided utilizing a channel(s) of the shared use facility to the Hub, High Capacity (a.k.a. BellSouth SPA High Capacity) rates and charges will apply for the facility to the Hub as set forth preceding and individual service rates and charges will apply from the Hub to the customer designated premises. The rates and charges that will apply to the portion from the Hub to the customer designated premises will be dependent on the specific type of Dedicated Access Service that is provided (e.g., Voice Grade<sup>1</sup> (a.k.a. BellSouth SPA DS0 VG), Digital Data Access<sup>1</sup> (a.k.a. BellSouth SPA DS0 Digital Data) service, etc.). The applicable rates and charges will include a Local Channel and Interoffice Channel, if applicable.

Access Collocation Cross-Connects provide a means for customers to interconnect their BellSouth Shared Use and Digital High Capacity (a.k.a. BellSouth SPA High Capacity) services to Central Office Collocation arrangements within the same Central Office. Terms, conditions, and rates for Physical Access Collocation Cross-Connects and Virtual Access Collocation Cross-Connects are set forth in Section E13. of this Tariff.

**Note 1:** Effective June 30, 2021, this Service will no longer be available for purchase by new or existing customers. In addition, requests to move, add, change, or renew existing service arrangements will not be accepted. Following the expiration of a customer's existing term agreement, service will be provided on a month-to-month basis at the applicable Monthly rates until the service is discontinued. The Company currently plans to discontinue this service on or after June 30, 2024. (M)

**Note 2:** Effective on or after December 1, 2021, neither new nor existing customers will be permitted to purchase new SMARTRing Service (Service). In addition, (A) Service Payment Plans greater than 12-months in length will no longer be available; and (B) requests to move, add, change, upgrade, or downgrade existing service arrangements will not be accepted, with the following exceptions: (1) existing customers will be permitted to modify their existing Service and will be able to add new circuits to their existing Service, but will not be permitted to add new nodes in any locations; and (2) any such new circuits will be subject to the customer's existing term payment plan or term agreement for the Service to which they are added. Following the expiration of a customer's existing term agreement, Service will be provided on a month-to-month basis at the applicable Month-to-Month rates until the Service is discontinued. (N)

Effective November 30, 2023, unless specified to the contrary in their existing Service agreements, existing customers may not renew Term Payment Plans or term agreements for Service. In addition, no move, add, or change orders of any type will be accepted. (N)



## E7. DEDICATED ACCESS SERVICES

### E7.4 Rate Regulations (Cont'd)

#### E7.4.8 Shared Use Analog and Digital High Capacity (a.k.a. BellSouth SPA High Capacity) Services (Cont'd)

The capability exists for a customer to utilize all or part of a SMARTRing<sup>2</sup> service (a.k.a. BellSouth Dedicated Ring) to transport switched access provided the SMARTRing<sup>2</sup> service (a.k.a. BellSouth Dedicated Ring) channel interface transporting the BellSouth SWA service does not have FlexServ service (a.k.a. BellSouth SPA Customer Reconfiguration) capability. The customer must place an order for each individual BellSouth SWA Channel provided over Dedicated Access service Shared Use Facilities and specify the channel assignment for each such service. The switched traffic would enter and exit the SMARTRing<sup>2</sup> service (a.k.a. BellSouth Dedicated Ring) at Customer and Central Office Nodes on that network. When this occurs, ratcheting of Dedicated Access rate elements (i.e. Nodes, Channel Interfaces, Local Channels, Alternate Central Office Channels, Internodal Channels, or Interoffice Channels) will be based on the number of voice grade<sup>1</sup> (a.k.a. BellSouth SPA DS0 VG) equivalent trunks/lines of that rate element used for BellSouth SWA access. (M) (C)

Reduction factors will be developed to reduce the charges on system level billing as well as the billing on individual DS1, DS3, STS-1, OC-3, and/or OC-12 Channel Interfaces. For ratcheting purposes, the system level charges include Customer Nodes, Central Office Nodes, Local Channels, Alternate Central Office Channels, Internodal Channels, and Interoffice Channels as appropriate to make up a customer's SMARTRing<sup>2</sup> service (a.k.a. BellSouth Dedicated Ring). Individual OC-1, OC-3 and OC-12 Channel Interfaces used in Overlay Ring Arrangements will be ratcheted as system level charges. The system reduction factor will apply to the system level charges. (C)

The system reduction factor will be derived by dividing the number of activated BellSouth SWA access circuits by the voice grade<sup>1</sup> (a.k.a. BellSouth SPA DS0 VG) channel equivalent capacity of the self-healing ring. An OC-1 SMARTRing<sup>2</sup> service (a.k.a. BellSouth Dedicated Ring) has 672 voice grade<sup>1</sup> (a.k.a. BellSouth SPA DS0 VG) equivalent channels. An OC-3 SMARTRing<sup>2</sup> service (a.k.a. BellSouth Dedicated Ring) has 2,016 voice grade<sup>1</sup> (a.k.a. BellSouth SPA DS0 VG) equivalent channels. An OC-3+ or OC-12 SMARTRing<sup>2</sup> service (a.k.a. BellSouth Dedicated Ring) has 8,064 voice grade<sup>1</sup> equivalent channels. An OC-48 SMARTRing<sup>2</sup> service (a.k.a. BellSouth Dedicated Ring) or OC-48+ SMARTRing<sup>2</sup> service (a.k.a. BellSouth Dedicated Ring) with 48 or less activated DS3s has 32,256 voice grade<sup>1</sup> (a.k.a. BellSouth SPA DS0 VG) equivalent channels. However, when an OC-48+ SMARTRing<sup>2</sup> service (a.k.a. BellSouth Dedicated Ring) is used to transport BellSouth SWA service, and more than 48 equivalent DS3s are activated on the service, the factor will be based upon the actual number of activated DS3s times 672 DS0s. A factor for individual DS3 channel interfaces and 28 DS1 channel systems, will be derived by dividing the number of activated BellSouth SWA access circuits associated with the DS3 channel by the voice grade<sup>1</sup> (a.k.a. BellSouth SPA DS0 VG) equivalent capacity of the DS3 channel. A DS3 has 672 voice grade<sup>1</sup> (a.k.a. BellSouth SPA DS0 VG) equivalent channels. For DS1 channel interfaces, a factor is derived by dividing the number of BellSouth SWA access circuits associated with the DS1 channel by the voice grade<sup>1</sup> (a.k.a. BellSouth SPA DS0 VG) equivalent capacity of the DS1 channel, which is 24. Each reduction factor is rounded to four decimal places and then multiplied against the respective monthly charges to determine the reduction amount. (C)

BellSouth SWA rates and charges as set forth in E6.8 preceding will apply for each channel of the shared use facility that is used to provide BellSouth SWA.

Where Dedicated Access service is provided utilizing a channel(s) of the shared use facility to the Hub, Wideband Analog<sup>1</sup> (a.k.a. BellSouth SPA Wideband Analog) or High Capacity (a.k.a. BellSouth SPA High Capacity) rates and charges will apply for the portion of the facility ordered as Dedicated Access to the Hub as set forth preceding and individual service rates and charges will apply from the Hub to the customer designated premises for the Dedicated Access services ordered. The rates and charges that will apply to the portion from the Hub to the customer designated premises will be dependent on the specific type of Dedicated Access service that is provided (e.g., Voice Grade<sup>1</sup> (a.k.a. BellSouth SPA DS0 VG), Telegraph<sup>1</sup> (a.k.a. BellSouth SPA Telegraph), etc.). The applicable rates and charges will include a local channel, interoffice channel, if applicable. Rates and charges for optional features and functions associated with the service, if any, will apply as set forth in E7.5 following.

**Note 1:** Effective June 30, 2021, this Service will no longer be available for purchase by new or existing customers. In addition, requests to move, add, change, or renew existing service arrangements will not be accepted. Following the expiration of a customer's existing term agreement, service will be provided on a month-to-month basis at the applicable Monthly rates until the service is discontinued. The Company currently plans to discontinue this service on or after June 30, 2024.

**Note 2:** Effective on or after December 1, 2021, neither new nor existing customers will be permitted to purchase new SMARTRing Service (Service). In addition, (A) Service Payment Plans greater than 12-months in length will no longer be available; and (B) requests to move, add, change, upgrade, or downgrade existing service arrangements will not be accepted, with the following exceptions: (1) existing customers will be permitted to modify their existing Service and will be able to add new circuits to their existing Service, but will not be permitted to add new nodes in any locations; and (2) any such new circuits will be subject to the customer's existing term payment plan or term agreement for the Service to which they are added. Following the expiration of a customer's existing term agreement, Service will be provided on a month-to-month basis at the applicable Month-to-Month rates until the Service is discontinued. (N)

Effective November 30, 2023, unless specified to the contrary in their existing Service agreements, existing customers may not renew Term Payment Plans or term agreements for Service. In addition, no move, add, or change orders of any type will be accepted. (N)

## E7. DEDICATED ACCESS SERVICES (T)

### E7.4 Rate Regulations (Cont'd)

#### E7.4.9 Reserved for Future Use

#### E7.4.10 Reserved for Future Use

#### E7.4.11 Reserved for Future Use

#### E7.4.12 FlexServ® Service (a.k.a. BellSouth SPA Customer Reconfiguration) (T)

##### A. General

FlexServ® service (a.k.a. BellSouth SPA Customer Reconfiguration) is an optional feature that enables the customer to monitor and reconfigure his Voice Grade (a.k.a. BellSouth SPA DS0 VG), DDAS (a.k.a. BellSouth SPA DS0 Digital Data), and High Capacity (a.k.a. BellSouth SPA High Capacity) dedicated access services without the direct intervention of Company personnel. (T)

##### 1. Basic FlexServ® Service (a.k.a. BellSouth SPA Customer Reconfiguration) (T)

Basic FlexServ® service (a.k.a. BellSouth SPA Customer Reconfiguration) includes monitoring and reconfiguration of the customer's private line services equipped with FlexServ® service (a.k.a. BellSouth SPA Customer Reconfiguration). (T)

Monitoring consists of unsolicited signals of major and minor facility alarms. These alarms include carrier group alarms, out of service alarms, bit error rate, bipolar violations, slip errors, errored seconds, out-of-frame alarms and invalid connections. Invalid connections are connections between special access services with incompatible signals or between services without FlexServ® service (a.k.a. BellSouth SPA Customer Reconfiguration). Customer requests for such connections will be denied. The Company shall not be responsible for service interruptions, troubles, loss of customer data, or any other losses resulting from attempted invalid connections. (T)

Reconfiguration provides the customer with the ability to direct the Company to connect or disconnect circuits equipped with FlexServ® service (a.k.a. BellSouth SPA Customer Reconfiguration) options to or from each others of like kind at a central office or central offices where the customer has purchased FlexServ® service (a.k.a. BellSouth SPA Customer Reconfiguration). Such connections and disconnections may be performed immediately or at a future time prescribed by the customer and are performed without direct interaction by Company personnel. (T)

The customer is responsible for providing the terminal equipment required for access to FlexServ® service (a.k.a. BellSouth SPA Customer Reconfiguration). (T)

The customer may transmit reconfiguration directions to or receive monitoring information from the Company over a switched service or a private line service. There are several types of access to the service listed in the General Subscriber Service Tariff from which the customer may choose. The type of access chosen will indicate the type of service the customer must provide to a Company location. Each FlexServ® service (a.k.a. BellSouth SPA Customer Reconfiguration) customer must purchase at least one type of access. (T)

Outside of the Company exchange or region, the customer must provide service from his terminal location to the designated Company location from which he may receive monitoring information or transmit reconfiguration directions. (T)

With the customer's initial order for basic FlexServ® service (a.k.a. BellSouth SPA Customer Reconfiguration), the Company provides the capability for "User Access" for monitoring and reconfiguration signals. One customer identification code with password security is included with such access. (T)

## E7. DEDICATED ACCESS SERVICES

### E7.4 Rate Regulations (Cont'd)

#### E7.4.12 FlexServ Service (a.k.a. BellSouth SPA Customer Reconfiguration) (Cont'd)

##### A. General (Cont'd)

##### 1. Basic FlexServ Service (a.k.a. BellSouth SPA Customer Reconfiguration) (Cont'd)

With the customer's initial order, the Company provides one customer training class for up to five (5) persons. The class length of this initial training is two consecutive eight hour days. These training classes are conducted at a designated Company location. Transportation, lodging and food for the attendees will be the responsibility of the customer. If the customer desires for the initial training to be conducted on his premises, then the customer is responsible for the transportation, lodging and food for the trainer. In addition, the customer is responsible for having the appropriate equipment on his premises.

Reconfiguration and monitoring are not available during the performance of routine maintenance of the Company's facilities and equipment used to provide FlexServ service (a.k.a. BellSouth SPA Customer Reconfiguration).

The Local and Interoffice Channels, which are terminated into FlexServ service (a.k.a. BellSouth SPA Customer Reconfiguration) are subject to all regulations and charges contained in their respective sections of this Tariff in addition to those contained herein.

Different switching options may be available in the same central office. If customers desire more than one switching option in the same central office and facilities are available, a channel connection is required for each FlexServ service (a.k.a. BellSouth SPA Customer Reconfiguration) switching option connected.

FlexServ service (a.k.a. BellSouth SPA Customer Reconfiguration) is furnished only in serving wire centers where facilities are available.

##### 2. Customer Circuits

There are *three* types of channel connections, which can be connected to FlexServ service (a.k.a. BellSouth SPA Customer Reconfiguration) - DS0 (Single channel), DS1 (1.544 Mbps) *and* DS3 (44.736 Mbps) *digital circuits*.

DS0 Channel Connections - There are two types of DS0 channel connections - Voice Grade (a.k.a. BellSouth SPA DS0 VG) and Digital (a.k.a. BellSouth SPA DS0 Digital Data). Both types of DS0 connections will be switched at a DS0 level.

DS1 Channel Connections - There are two types of connections available for a customer desiring to terminate a DS1 circuit - DS0 switching and DS1 switching. For example, if a customer needs to be able to monitor or reconfigure the 24 DS0 circuits riding on the DS1 channel, then the customer would purchase a DS1 channel connection with DS0 switching. If the customer does not need access to the individual DS0 circuits, then the customer would purchase a DS1 channel connection with DS1 switching. *A monitoring only option (i.e., surveillance) is also provided for DS1 channel connections. This option may also be used for terminating SWA DS1 channels.*

DS3 Channel Connections (Monitoring Only) - There are two types of connections available for terminating a DS3 circuit - DS1 and DS3. This option provides for termination of SWA and SPA DS3 channels for monitoring purposes only (i.e., surveillance). If the customer needs monitoring for 28 DS1 circuits, then the customer would purchase a DS3 channel connection at DS1 level. The customer would purchase a DS3 channel connection at DS3 level if the customer wants to monitor the entire DS3 circuit.

##### 3. FlexServ Service (a.k.a. BellSouth SPA Customer Reconfiguration) Options

a. Additional Concurrent User Access: This option provides the customer the ability to establish additional concurrent connections to the Company for the communication of monitoring and reconfiguration signals. One additional customer identification code is provided with each additional User Access. For each Additional Concurrent User Access ordered, the customer must also order an additional Management Terminal Interface from the General Subscriber Service Tariff.

b. Additional User Identification Codes: This option provides customer identification codes in addition to that provided with each User Access. If the customer has a Dial Access to FlexServ service (a.k.a. BellSouth SPA Customer Reconfiguration), then the customer must also order an additional Security Card from the General Subscriber Service Tariff.

## E7. DEDICATED ACCESS SERVICES (T)

### E7.4 Rate Regulations (Cont'd)

#### E7.4.12 FlexServ® Service (a.k.a. BellSouth SPA Customer Reconfiguration) (Cont'd) (T)

##### A. General (Cont'd)

##### 3. FlexServ® Service Options (Cont'd)

- c. Additional Customer Training: This option provides one eight hour day of customer training in addition to that included with basic FlexServ® service (a.k.a. BellSouth SPA Customer Reconfiguration). These training classes are conducted at a designated Company location. All other terms that apply for the initial training apply for the subsequent training. (T)
  - d. Multipoint Bridging: Multipoint Bridging is a capability which permits the cross connection of multiple channels equipped with FlexServ® service (a.k.a. BellSouth SPA Customer Reconfiguration). (T)
    - (1) Multipoint Bridging, sometimes referred to as "DMB", is an option on voice grade service that allows the customer the capability to perform reconfigurations that cross-connect or bridge three or more channels in the FlexServ® service (a.k.a. BellSouth SPA Customer Reconfiguration) arrangement into one conferencing arrangement. (T)
    - (2) Multipoint Junction Unit option gives the customer the ability to bridge one master and four patron legs for use with Digital Data Access (a.k.a. BellSouth SPA DS0 Digital Data) service. If more than one MJU is required. One of the four patron legs must be used to connect to the master leg of another MJU. The customer is responsible for this connection. The MJU feature is only offered in a unit of five channel connections (one master and four legs). (T)
  - e. Substrate Reconfiguration Capability is an option that provides the customer the ability to control all ports of a substrate multiplexer within a FlexServ® service (a.k.a. BellSouth SPA Customer Reconfiguration) arrangement. This control includes both the DS0B channel and DS0A legs. The speeds for substrates are 2.4, 4.8, and 9.6 Kbps (does not include 19.2 Kbps). The customer has the responsibility to establish a substrate system using previously acquired DS0 ports. (T)
  - f. Reconfigurations by Company Personnel: The customer may request that Company personnel intervene to perform reconfigurations that the customer could otherwise perform without the direct intervention of Company personnel. (T)
4. Shared FlexServ® Service (a.k.a. BellSouth SPA Customer Reconfiguration) Arrangement (T)
- Multiple customers may include circuits with the FlexServ® service (a.k.a. BellSouth SPA Customer Reconfiguration) option in the same FlexServ® service (a.k.a. BellSouth SPA Customer Reconfiguration) arrangement, provided all customers designate in writing the same party to serve as their agent. (A FlexServ® service (a.k.a. BellSouth SPA Customer Reconfiguration) arrangement consists of all dedicated access services with FlexServ® service (a.k.a. BellSouth SPA Customer Reconfiguration) that can be monitored and reconfigured through the same User Access.) (T)
- The agent will be authorized to represent each of those customers in all transactions and communications with the Company regarding the shared FlexServ® service (a.k.a. BellSouth SPA Customer Reconfiguration) arrangement or circuits included in that arrangement including reconfigurations, monitoring, ordering of additional dedicated access services and FlexServ® service (a.k.a. BellSouth SPA Customer Reconfiguration) options in the arrangement, and removal of dedicated access services from the arrangement. The Company will not process any customer orders or requests affecting that arrangement of circuits included in that arrangement except those submitted to the Company by the agent. (T)

## E7. DEDICATED ACCESS SERVICES

### E7.4 Rate Regulations (Cont'd)

#### E7.4.12 FlexServ Service (a.k.a. BellSouth SPA Customer Reconfiguration) (Cont'd)

##### A. General (Cont'd)

##### 4. Shared FlexServ Service (a.k.a. BellSouth SPA Customer Reconfiguration) Arrangement (Cont'd)

The Company will not be liable for any loss to any of the customers in a shared FlexServ service (a.k.a. BellSouth SPA Customer Reconfiguration) arrangement caused directly or indirectly by actions of the agent or another customer in the shared arrangement. Each customer in the shared arrangement and the agent indemnify the Company for the costs of any and all claims arising directly or indirectly out of the actions of the agent or another customer in the shared arrangement, including, but not limited to, the cost of defending against such claims.

Any customer in a shared FlexServ service (a.k.a. BellSouth SPA Customer Reconfiguration) arrangement must give the Company 30 days prior written notice of his intent to revoke an agent's authority or to remove his dedicated access services from a shared arrangement. Such notice shall not be effective unless it provides the Company with specific and sufficient directions regarding treatment of the customer's dedicated access services upon revocation of the agent's authority or removal from the shared arrangement.

##### 5. Access Collocation Cross-Connects

Access Collocation Cross-Connects provide a means for customers to interconnect their FlexServ service (a.k.a. BellSouth SPA Customer Reconfiguration) to Central Office Collocation arrangements within the same Central Office. Terms, conditions, and rates for Physical Access Collocation Cross-Connects and Virtual Access Collocation Cross-Connects are set forth in Section E13. of this Tariff.

##### B. Application of Rates

##### 1. Basic FlexServ Service (a.k.a. BellSouth SPA Customer Reconfiguration)

##### a. Connection of Dedicated Access Services to Reconfiguration and Alarm Monitoring Capability.

A DS0/DS1/DS3 nonrecurring Connection Charge and a recurring monthly rate is required for each entrance and exit of a dedicated access channel to reconfiguration and monitoring capability.

Charges for Access to FlexServ service (a.k.a. BellSouth SPA Customer Reconfiguration) are contained in E7.5.16 following.

##### 2. FlexServ Service (a.k.a. BellSouth SPA Customer Reconfiguration) Options

##### a. Additional Concurrent User Access

For each Additional Concurrent User Access a nonrecurring charge and a recurring monthly rate applies.

##### b. Additional User Identification Codes

A nonrecurring charge applies for each additional ID requested.

##### c. Additional Customer Training

Any additional training will incur a nonrecurring charge for each eight (8) hour day of training.

##### d. Multipoint Bridging

##### Multipoint Bridging (DMB)

There will be a nonrecurring charge and a monthly rate for each DS0 or equivalent that is equipped with this capability.

##### Multipoint Junction Unit

A nonrecurring charge and a monthly rate applies for each DS0 or equivalent that is equipped with this capability.

This option must be purchased in groups of 5 because a unit has the capacity of 5 DS0 or equivalent channel connections.

##### e. Subrate Reconfiguration

There will be a nonrecurring charge for each DS0 equipped DS0B and a nonrecurring charge and a monthly rate will apply for each set of DS0As. The DS0A rates apply in sets of five for 9.6 Kbps, in sets of ten for 4.8 Kbps, and in sets of twenty for 2.4 Kbps. (M)

##### f. Reconfigurations by the Company Personnel

A nonrecurring charge is applicable on each occasion, when the customer requests Company personnel to perform a reconfiguration or a series of reconfigurations in order to set up point-to-point or multipoint connections, to provide a status report or to establish a conference. (M)

## E7. DEDICATED ACCESS SERVICES

### E7.4 Rate Regulations (Cont'd)

#### E7.4.12 FlexServ Service (a.k.a. BellSouth SPA Customer Reconfiguration) (Cont'd)

- B. Application of Rates (Cont'd)
2. FlexServ Service (a.k.a. BellSouth SPA Customer Reconfiguration) Options (Cont'd)

3. Contract Plans

Contract rates for FlexServ service (a.k.a. BellSouth SPA Customer Reconfiguration) are available in E7.5.16 under conditions specified in the Channel Services Payment Plan in E2.4 of this Tariff.

Termination Liability is applicable at the date of termination. The applicable charge will be fifty percent (50%) for contracts that have been in effect twelve months (12) or less, or twenty percent (20%) for contracts that have been in effect longer than twelve months (12). Termination Liability will not apply for customer requests for moves of service under CSPP subject to the provisions set forth in E2.4.9.A.8 preceding.

#### E7.4.13 Derived Data Channel<sup>1</sup> Service (DDCS) (a.k.a. BellSouth SPA Derived Data Channel)

- A. Application of Rates

The derived data channel charges provide the central office data/voice multiplexing capability. The customer must also subscribe to a compatible two-wire local exchange line (e.g., business exchange line, ESSX service, Digital ESSX service, MultiServ service, MultiServ PLUS service, or BellSouth Centrex service main station line). This two-wire exchange line and its associated rates and charges are in addition to the derived data channel rates and charges.

The DS0-B interface charge is applicable for each group of a maximum of twenty multiplexed derived data channels. Each of the twenty channels in a DS0-B interface channel group operates at a bit rate of 2.4 Kbps. The interoffice channel is required when the customer's serving wire center and the serving wire center of the customer's terminating premises are not the same.

#### E7.4.14 SMARTRing<sup>2</sup> service (a.k.a. BellSouth Dedicated Ring)

- A. Self-healing Multi-nodal Alternate Route Topology Ring

1. Monthly rates and charges as specified in E7.5.18 following apply for each SMARTRing service (a.k.a. BellSouth Dedicated Ring). Customers must specify network capacity at the time of the initial order. In an Overlay Ring Arrangement where a customer's overlaying SMARTRing service (a.k.a. BellSouth Dedicated Ring) rides the customer's host SMARTRing service (a.k.a. BellSouth Dedicated Ring), the overlay ring will share the transport of the host ring between common node locations. Rate categories at OC-3, OC-3+, OC-12, OC-24, OC-48, OC-48+, OC-192 and OC-192+ capacity levels include Customer Nodes, Central Office Nodes, Local Channels, Alternate Central Office Channels, Interoffice Channels and Internodal Channels. OC-24 SMARTRing service (a.k.a. BellSouth Dedicated Ring) is only available to existing CSPP customers or under month-to-month arrangements. Rate categories for OC-1 SMARTRing service (a.k.a. BellSouth Dedicated Ring) include Customer Nodes and Central Office Nodes. Channel Interfaces are required at each node on the network and must be associated with a SMARTRing service (a.k.a. BellSouth Dedicated Ring). An OC-1 Overlay Ring Arrangement requires an OC-1 Channel Interface at each node involved. An OC-3 Overlay Ring Arrangement requires an OC-3 Channel Interface at each node involved. An OC-3+ or OC-12 Overlay Ring Arrangement requires an OC-12 Channel Interface at each node involved. An OC-48 or OC-48+ Overlay Ring Arrangement requires an OC-48 Channel Interface at each node involved. In Overlay Ring Arrangements, the customer must order a Channel Interface for each entry to or exit from the host ring. In all other situations, the number of Channel Interfaces ordered will depend on whether the customer desires a working interface, or a working interface and a protection interface. The quantity of channel interfaces ordered may not exceed the capacity ordered. When a 28 DS1 Channel System is utilized to activate DS1 channels, the appropriate number of DS1 Channel Interfaces are required in lieu of an originating or terminating DS3 or STS-1 Channel Interface.

**Note 1:** Effective June 30, 2021, this Service will no longer be available for purchase by new or existing customers. In addition, requests to move, add, change, or renew existing service arrangements will not be accepted. Following the expiration of a customer's existing term agreement, service will be provided on a month-to-month basis at the applicable Monthly rates until the service is discontinued. The Company currently plans to discontinue this service on or after June 30, 2024.

**Note 2:** Effective on or after December 1, 2021, neither new nor existing customers will be permitted to purchase new SMARTRing Service (Service). In addition, (A) Service Payment Plans greater than 12-months in length will no longer be available; and (B) requests to move, add, change, upgrade, or downgrade existing service arrangements will not be accepted, with the following exceptions: (1) existing customers will be permitted to modify their existing Service and will be able to add new circuits to their existing Service, but will not be permitted to add new nodes in any locations; and (2) any such new circuits will be subject to the customer's existing term payment plan or term agreement for the Service to which they are added. Following the expiration of a customer's existing term agreement, Service will be provided on a month-to-month basis at the applicable Month-to-Month rates until the Service is discontinued.

Effective November 30, 2023, unless specified to the contrary in their existing Service agreements, existing customers may not renew Term Payment Plans or term agreements for Service. In addition, no move, add, or change orders of any type will be accepted.

## E7. DEDICATED ACCESS SERVICES

### E7.4 Rate Regulations (Cont'd)

#### E7.4.14 SMARTRing<sup>®</sup> service (a.k.a. BellSouth Dedicated Ring) (Cont'd)

(C)

- A. Self-healing Multi-nodal Alternate Route Topology Ring (Cont'd)
  2. Nonrecurring charges for Local, Alternate Central Office, Interoffice and Internodal Channels apply for each channel for month-to-month customers. Nonrecurring charges are not applicable when the ring level rate elements and channel interfaces are ordered under TPP arrangements. SMARTRing<sup>®</sup> service (a.k.a. BellSouth Dedicated Ring) ring level rate elements are defined as following: Local Channel, Interoffice Channel, Internodal Channel, Alternate Central Office Channel, Customer Node and Central Office Node. Nonrecurring charges do apply for the Channel Interface Reallocation rate element and the SMARTRing<sup>®</sup> service (a.k.a. BellSouth Dedicated Ring) rearrangement rate elements (Surveillance and Reconfiguration) for CSPP and TPP customers. When the customer requests two separate routes and the routing is provided as described in E7.2.16.A preceding, charges apply for the Local Channels and any Interoffice Channels on the requested route. Recurring charges for Local, Alternate Central Office, Interoffice and Internodal Channels apply for each quarter air mile increment of the channel. Fractions of a quarter mile will always round up to the next quarter air mile before determining the mileage and applying the rate. For channels which are less than one quarter mile, a minimum charge of one quarter mile applies.
  3. For Internodal Channels, charges apply as appropriate either for the same wire center area or contiguous serving wire center areas, as specified in E7.5 18.A.4.
  4. Nonrecurring charges for Customer Nodes and Central Office Nodes apply per node for month-to-month customers and are based upon the capacity of the ring configuration. Nonrecurring charges are not applicable when the preceding rate elements are ordered under TPP arrangements. Recurring rates for Customer and Central Office Nodes apply per node and are also based upon the capacity of the ring configuration.
  5. When the customer orders an OC-1 SMARTRing<sup>®</sup> service (a.k.a. BellSouth Dedicated Ring) Overlay Ring Arrangement riding the customer's host OC-12, OC-48, or OC-48+ SMARTRing<sup>®</sup> service (a.k.a. BellSouth Dedicated Ring), recurring charges apply per OC-1 Customer Node and/or OC-1 Central Office Node, in addition to the recurring and nonrecurring charges for associated Channel Interfaces.
  6. When the customer orders an OC-3 SMARTRing<sup>®</sup> service (a.k.a. BellSouth Dedicated Ring) service Overlay Ring Arrangement riding the customer's host OC-12, OC-48, OC-48+, OC-192 or OC-192+ SMARTRing<sup>®</sup> service (a.k.a. BellSouth Dedicated Ring), recurring charges apply per OC-3 Customer Node and/or OC-3 Central Office Node, in addition to the recurring and nonrecurring charges for associated Channel Interfaces. Nonrecurring charges only apply for month-to-month customers.
  7. When the customer orders an OC-3+ or OC-12 Overlay Ring Arrangement riding the customer's host OC-48, OC-48+, OC-192 or OC-192+ SMARTRing<sup>®</sup> service (a.k.a. BellSouth Dedicated Ring), recurring charges apply per OC-3+ and/or OC-12 Customer Node and/or per OC-3+ and/or OC-12 Central Office Node, in addition to the charges for associated Channel Interfaces. Nonrecurring charges only apply for month-to-month customers.
  8. In all Overlay Ring Arrangements, the number of OC-1, OC-3, and/or OC-12 Channel Interfaces required will be based upon the characteristics of the overlaying ring.
  9. The rates for Customer Channel Interfaces apply for each origination and for each termination of an activated DS1, DS3, STS-1, OC-3, OC-12, OC-48 and/or 1000 Mbps at the Customer Node. For interfaces ordered on a month-to-month basis the nonrecurring charge applies per interface. For interfaces ordered under CSPP, nonrecurring charges are established on a per order basis for the first DS1, DS3, STS-1, OC-3 and/or OC-12 which originates or terminates at a Customer Node and for each additional DS1, DS3, STS-1, OC-3, and/or OC-12 which originates or terminates at the same Customer Node. For interfaces ordered under TPP, there are no nonrecurring charges associated with the installation. The recurring rate applies on a per Customer Node basis for each origination and for each termination of an activated DS3 and/or DS1 at a Customer Node.

**Note 1:** Effective on or after December 1, 2021, neither new nor existing customers will be permitted to purchase new SMARTRing Service (Service). In addition, (A) Service Payment Plans greater than 12-months in length will no longer be available; and (B) requests to move, add, change, upgrade, or downgrade existing service arrangements will not be accepted, with the following exceptions: (1) existing customers will be permitted to modify their existing Service and will be able to add new circuits to their existing Service, but will not be permitted to add new nodes in any locations; and (2) any such new circuits will be subject to the customer's existing term payment plan or term agreement for the Service to which they are added. Following the expiration of a customer's existing term agreement, Service will be provided on a month-to-month basis at the applicable Month-to-Month rates until the Service is discontinued.

(M)

(N)

Effective November 30, 2023, unless specified to the contrary in their existing Service agreements, existing customers may not renew Term Payment Plans or term agreements for Service. In addition, no move, add, or change orders of any type will be accepted.

(N)

## E7. DEDICATED ACCESS SERVICES

### E7.4 Rate Regulations (Cont'd)

#### E7.4.14 SMARTRing<sup>1</sup> service (a.k.a. BellSouth Dedicated Ring) (Cont'd)

- (C)
- A. Self-healing Multi-nodal Alternate Route Topology Ring (Cont'd)
10. In addition, OC-12 and or OC-48 customers with DS3 and/or STS-1 interfaces at the Customer Node electing to connect with DS1 services at a Central Office Node, must obtain a 28 DS1 Channel System and the appropriate number of DS1 Channel Interfaces in lieu of a DS3 or STS-1 Channel Interface. A maximum of 28 DS1 Channel Interfaces can be activated for each 28 DS1 Channel System utilized. For service ordered under CSPP, nonrecurring charges are established on a per order basis for the first 28 DS1 Channel System and for each additional 28 DS1 Channel System at that same Central Office Node. Nonrecurring charges are also established for the first DS1 Channel Interface which originates/terminates in a 28 DS1 Channel System and each additional DS1 Channel Interface which originates/terminates in that same DS1 Channel System. For DS1 Channel Systems ordered under TPP, nonrecurring charges do not apply. For DS1 Channel Systems ordered on a month-to-month basis, nonrecurring charges apply. The recurring rate applies for each 28 DS1 Channel System and each DS1 Channel Interface activated per Central Office Node. (M1)
11. A nonrecurring charge applies for SMARTRing service (a.k.a. BellSouth Dedicated Ring) Surveillance, one for each Customer Node and each Central Office Node, per SMARTRing service (a.k.a. BellSouth Dedicated Ring) rearranged. A nonrecurring charge applies for Reconfiguration, one per reconfiguration of each STS-1 group at each node where such reconfiguration capability is desired. These rate elements apply when the Customer adds FlexServ service (a.k.a. BellSouth SPA Customer Reconfiguration) to an existing SMARTRing service (a.k.a. BellSouth Dedicated Ring) as set forth in E7.2.16.A preceding. Reconfiguration is not available with 100 Mbps and 1000 Mbps BellSouth Metro Ethernet Backbone interfaces.
12. For CSPP customers, first and additional nonrecurring charges will be applied when ordering the same rate element between the same locations with the same installation date. First and additional nonrecurring charges are not applicable under TPP arrangements.
13. SMARTRing service (a.k.a. BellSouth Dedicated Ring) purchased prior to August 23, 1996, is available under several CSPP arrangements: Plan A (24-48 Months<sup>1</sup>), Plan B (49-72 Months<sup>1</sup>) or Plan C (73-96 Months<sup>1</sup>). Renewals of existing SMARTRing service (a.k.a. BellSouth Dedicated Ring) or purchases of new SMARTRing service (a.k.a. BellSouth Dedicated Ring) on or after August 23, 1996, will only be available under TPP arrangements. In order to accommodate more flexible customer situations, SMARTRing service (a.k.a. BellSouth Dedicated Ring) is available under several TPP arrangements: Plan A (12-36 Months<sup>1</sup>), Plan B (37-60 Months<sup>1</sup>) or Plan C (61-96 Months<sup>1</sup>). Month-to-month arrangements (with a minimum of four months) are available for SMARTRing service (a.k.a. BellSouth Dedicated Ring). (C)
14. CSPP and TPP arrangements are provided under the terms and conditions specified in E2.4.9 preceding, except as modified following. For all payment plans, the following regulations apply:
- a. SMARTRing service (a.k.a. BellSouth Dedicated Ring), whether initially or subsequently ordered in conjunction with BellSouth Dedicated Ring, must be provided under the same TPP payment plan with the same service period and both services are to be coterminous.
- b. All rate elements, for a given SMARTRing service (a.k.a. BellSouth Dedicated Ring), whether initially or subsequently ordered, must be provided under the same payment plan with the same service period and are coterminous upon disconnect of the SMARTRing service (a.k.a. BellSouth Dedicated Ring). However, Channel Interfaces, except those utilized to interface an overlaying ring with its host ring, may be provided under a month-to-month arrangement which is equal to or less than the payment plan for the associated SMARTRing service (a.k.a. BellSouth Dedicated Ring). Customers with Channel Interfaces provided under a CSPP payment period which began prior to August 22, 1994, may convert those Channel Interfaces to a month-to-month or payment plan arrangement which is equal to or less than the payment plan for the associated SMARTRing service (a.k.a. BellSouth Dedicated Ring), at the current rates and charges. (M2)
- Note 1:** Effective on or after December 1, 2021, neither new nor existing customers will be permitted to purchase new SMARTRing Service (Service). In addition, (A) Service Payment Plans greater than 12-months in length will no longer be available; and (B) requests to move, add, change, upgrade, or downgrade existing service arrangements will not be accepted, with the following exceptions: (1) existing customers will be permitted to modify their existing Service and will be able to add new circuits to their existing Service, but will not be permitted to add new nodes in any locations; and (2) any such new circuits will be subject to the customer's existing term payment plan or term agreement for the Service to which they are added. Following the expiration of a customer's existing term agreement, Service will be provided on a month-to-month basis at the applicable Month-to-Month rates until the Service is discontinued. (N)
- Effective November 30, 2023, unless specified to the contrary in their existing Service agreements, existing customers may not renew Term Payment Plans or term agreements for Service. In addition, no move, add, or change orders of any type will be accepted. (N)

M1 Material appearing on this page previously appeared on page(s) 47.1 of this section.

M2 Material previously appearing on this page now appears on page(s) 47.3 of this section.



## E7. DEDICATED ACCESS SERVICES

### E7.4 Rate Regulations (Cont'd)

#### E7.4.14 SMARTRing<sup>®</sup> service (a.k.a. BellSouth Dedicated Ring) (Cont'd)

- A. Self-healing Multi-nodal Alternate Route Topology Ring (Cont'd)
14. (Cont'd)
- c. In a shared network arrangement, where the host subscriber and the connecting service user subscribes to services under CSPP or TPP arrangements, the payment periods for directly associated channelized rate elements must be equal to or less than the payment periods for the host service, or the service user must order those rate elements under month-to-month payment terms. Where the host subscriber receives services under month-to-month payment terms, a connecting user must also receive directly associated channelized rate elements under month-to-month payment terms. (M)
15. The rates applicable to a month-to-month payment plan are subject to Telephone Company initiated charges. (M)
16. For CSPP customers, a termination liability charge will be applicable if services are disconnected prior to the end of the chosen service period. The applicable charge is equal to the number of months remaining in the rate stabilized service period times 60 percent of the monthly rates for SMARTRing service (a.k.a. BellSouth Dedicated Ring) which includes all Nodes, Channel Interfaces, Local Channels, Alternate Central Office Channels, Internodal Channels and/or Interoffice Channels provided under the CSPP arrangement. (M)
- Termination liability charges for SMARTRing service (a.k.a. BellSouth Dedicated Ring) TPP customers are applicable as specified in E2.4.9.C preceding. (M)
17. When a service period under an existing CSPP or TPP arrangement is completed and a customer elects to revert to a month-to-month payment option, no minimum period is applicable. (M)
18. The TPP customer of record will have a 60 day grace period after which month-to-month rates will apply. (M)
19. Customers may upgrade from a lower capacity SMARTRing<sup>®</sup> service (a.k.a. BellSouth Dedicated Ring) to a higher capacity SMARTRing<sup>®</sup> service (a.k.a. BellSouth Dedicated Ring) without incurring any termination charges if the following conditions are met:
- a. the order for the upgraded SMARTRing<sup>®</sup> service (a.k.a. BellSouth Dedicated Ring) and the order for the disconnect of the existing SMARTRing<sup>®</sup> service (a.k.a. BellSouth Dedicated Ring) are received by the Telephone Company at the same time,
- b. the new SMARTRing<sup>®</sup> service (a.k.a. BellSouth Dedicated Ring) is provided between the same customer and Central Office locations as the discontinued SMARTRing<sup>®</sup> service (a.k.a. BellSouth Dedicated Ring),
- c. the number of Channel Interfaces activated under the new capacity SMARTRing<sup>®</sup> service (a.k.a. BellSouth Dedicated Ring) is greater than the number of Channel Interfaces activated under the existing capacity SMARTRing<sup>®</sup> service (a.k.a. BellSouth Dedicated Ring).
- d. the expiration date of the new SMARTRing<sup>®</sup> service (a.k.a. BellSouth Dedicated Ring) payment plan is subsequent to the payment plan of the ring being discontinued.
20. Customers may also upgrade existing SMARTRing<sup>®</sup> service (a.k.a. BellSouth Dedicated Ring) to a new SMARTRing<sup>®</sup> service (a.k.a. BellSouth Dedicated Ring) of the same capacity without incurring a termination liability charge, if the customer is concurrently ordering a new capability which cannot be provisioned with the existing SMARTRing<sup>®</sup> service (a.k.a. BellSouth Dedicated Ring) and if the conditions set forth in 19. preceding are met.
21. Ring level billing is defined as billing for the following rate elements: Local Channel, Interoffice Channel, Internodal Channel Alternate Central Office Channel, Customer Node and Central Office Node. Billing for Customer Channel Interfaces and Central Office Channel Interfaces recurring and nonrecurring charges will be effective upon activation to the SMARTRing<sup>®</sup> service (a.k.a. BellSouth Dedicated Ring).
22. If the Service Establishment Date extends beyond one year from the customer's order date due to Telephone Company reasons, the preceding conversion provisions apply. If the Service Establishment Date extends beyond one year from the customer's order date for other reasons, the preceding conversion provisions do not apply and billing for all recurring and nonrecurring charges will be effective with the Service Establishment Date.

**Note 1:** Effective on or after December 1, 2021, neither new nor existing customers will be permitted to purchase new SMARTRing Service (Service). In addition, (A) Service Payment Plans greater than 12-months in length will no longer be available; and (B) requests to move, add, change, upgrade, or downgrade existing service arrangements will not be accepted, with the following exceptions: (1) existing customers will be permitted to modify their existing Service and will be able to add new circuits to their existing Service, but will not be permitted to add new nodes in any locations; and (2) any such new circuits will be subject to the customer's existing term payment plan or term agreement for the Service to which they are added. Following the expiration of a customer's existing term agreement, Service will be provided on a month-to-month basis at the applicable Month-to-Month rates until the Service is discontinued. (N)

Effective November 30, 2023, unless specified to the contrary in their existing Service agreements, existing customers may not renew Term Payment Plans or term agreements for Service. In addition, no move, add, or change orders of any type will be accepted. (N)

## E7. DEDICATED ACCESS SERVICES

### E7.4 Rate Regulations (Cont'd)

#### E7.4.15 Zone Pricing

- A. High Capacity (a.k.a. BellSouth SPA DS1) service (1.544 Mbps) is organized into three pricing zones. Rate levels for the Local Channel, Interoffice Channels and DS1 Basic Channelization will be billed in accordance with the pricing zone assignment of the serving wire center. The pricing zone assignment for each Company serving wire center is specified in the National Exchange Carrier Association (NECA) Tariff F.C.C. No. 4. Interoffice Channels, which terminate in offices in different zones will carry the higher rate. When interoffice channels are provided by more than one Telephone Company, this Company's portion of the circuit will be billed at the Zone Rate of this Company's central office, and the other Telephone Company's portion of that circuit will be billed in accordance with that Company's tariff, pursuant to E2.4.8. Channelization rates will be determined by the location of the channelization arrangement.

(D)

#### E7.4.16 Reserved for Future Use

(T)

(D)

## E7. DEDICATED ACCESS SERVICES

### E7.4 Rate Regulations (Cont'd)

#### E7.4.16 (DELETED)

#### E7.4.17 SMARTPath Service (a.k.a. BellSouth SPA Shared Ring)

##### A. Application of Rates

Monthly rates and charges as specified in E7.5.17 apply for each SMARTPath service (a.k.a. BellSouth SPA Shared Ring). The transport provided within a SMARTPath service (a.k.a. BellSouth SPA Shared Ring) Area is provided at 1.544 Mbps. Rate categories include a SMARTPath service (a.k.a. BellSouth SPA Shared Ring) Area Connection, and a SMARTPath service (a.k.a. BellSouth SPA Shared Ring) Area Junction.

The SMARTPath service (a.k.a. BellSouth SPA Shared Ring) Area Connection rate element provides for the connection at the designated premises where the customer gains access to SMARTPath service (a.k.a. BellSouth SPA Shared Ring) and transport to a designated junction on the network. The SMARTPath service (a.k.a. BellSouth SPA Shared Ring) Area Junction rate element provides for the connection between the SMARTPath service (a.k.a. BellSouth SPA Shared Ring) network and (1) another customer designated premises, in the same SMARTPath service (a.k.a. BellSouth SPA Shared Ring) Area or (2) a serving wire center in the same SMARTPath service (a.k.a. BellSouth SPA Shared Ring) Area for connection to (a) DS1 Basic Channelization, FlexServ service (a.k.a. BellSouth SPA Customer Reconfiguration), Virtual Expanded Interconnection Services under Section E20. SMARTRing<sup>2</sup> service (a.k.a. BellSouth Dedicated Ring or DS3 service as provided in Section E7, or (b) a SMARTPath service (a.k.a. BellSouth SPA Shared Ring) Area Junction of another SMARTPath service (a.k.a. BellSouth SPA Shared Ring) area in the same Metropolitan Area. (C)

Recurring and nonrecurring charges apply for each SMARTPath service (a.k.a. BellSouth SPA Shared Ring) Area Connection and SMARTPath service (a.k.a. BellSouth SPA Shared Ring) Area Junction.

SMARTPath service (a.k.a. BellSouth SPA Shared Ring) is available under several payment plans: Month-to-month (with a 4 month minimum), Plan A (24-48 Months)<sup>1</sup>, or Plan B (49-72 Months)<sup>1</sup>. Plan A and Plan B are provided under conditions specified in the Channel Services Payment Plan (CSPP) E2.4.9.A.

The rates applicable to a month-to-month payment plan are subject to Company initiated changes. Rates stabilized under CSPP are exempt from Company initiated increases, however, decreases for any rate element will automatically flow through to the customer.

A SMARTPath service (a.k.a. BellSouth SPA Shared Ring) performance credit, as specified in E2.4.4.B will apply.

A termination liability charge will be applicable if services provided under a CSPP arrangement are disconnected prior to the end of the chosen service period. The termination charge is equal to the applicable rate per rate element for the current contract multiplied by the difference in months between the time the CSPP contract has been in effect and the minimum contract length multiplied times a factor. The factor is 50 percent for contracts that have been in effect twelve months or less, or 20 percent for contracts that have been in effect longer than twelve months.

**Note 1:** Effective March 23, 2019, Customers may not convert, renew, or establish CSPPs longer than 36 months for SMARTPath Service.

**Note 2:** Effective on or after December 1, 2021, neither new nor existing customers will be permitted to purchase new SMARTRing Service (Service). In addition, (A) Service Payment Plans greater than 12-months in length will no longer be available; and (B) requests to move, add, change, upgrade, or downgrade existing service arrangements will not be accepted, with the following exceptions: (1) existing customers will be permitted to modify their existing Service and will be able to add new circuits to their existing Service, but will not be permitted to add new nodes in any locations; and (2) any such new circuits will be subject to the customer's existing term payment plan or term agreement for the Service to which they are added. Following the expiration of a customer's existing term agreement, Service will be provided on a month-to-month basis at the applicable Month-to-Month rates until the Service is discontinued. (N)

Effective November 30, 2023, unless specified to the contrary in their existing Service agreements, existing customers may not renew Term Payment Plans or term agreements for Service. In addition, no move, add, or change orders of any type will be accepted. (N)

FLORIDA  
ISSUED: February 4, 2005  
BY: Joseph P. Lacher, President -FL  
Miami, Florida

EFFECTIVE: March 7, 2005

## **E7. SPECIAL ACCESS (A.K.A. BELLSOUTH SPA) SERVICE**

### **E7.4 Rate Regulations (Cont'd)**

<b>E7.4.18 Reserved For Future Use</b>	(N)
<b>E7.4.19 Reserved For Future Use</b>	(N)
<b>E7.4.20 Reserved For Future Use</b>	(N)
<b>E7.4.21 Reserved For Future Use</b>	(N)
<b>E7.4.22 Reserved For Future Use</b>	(N)
<b>E7.4.23 Reserved For Future Use</b>	(N)
<b>E7.4.24 Reserved For Future Use</b>	(N)
<b>E7.4.25 Reserved For Future Use</b>	(N)
<b>E7.4.26 Reserved For Future Use</b>	(N)
<b>E7.4.27 Reserved For Future Use</b>	(N)
<b>E7.4.28 Reserved For Future Use</b>	(N)
<b>E7.4.29 Reserved For Future Use</b>	(N)
<b>E7.4.30 Reserved For Future Use</b>	(N)
<b>E7.4.31 Reserved For Future Use</b>	(N)

## E7. SPECIAL ACCESS (A.K.A. BELLSOUTH SPA) SERVICE

### E7.4 Rate Regulations (Cont'd)

#### E7.4.32 BellSouth Metro Ethernet Service<sup>1</sup>

(C)

##### A. General

1. The minimum service period for BellSouth Metro Ethernet service is four (4) months.
2. Suspension of BellSouth Metro Ethernet service is not allowed.
3. BellSouth Metro Ethernet service is available 24 hours per day, 7 days per week, except for preventive maintenance.

Due to the nature of BellSouth Metro Ethernet service it will be necessary to perform preventive maintenance and software updates. This will mean that BellSouth Metro Ethernet service will be unavailable during the period of time when preventive maintenance is being performed. This could result in the service being unavailable during the period between 1:00 AM and 5:00 AM Eastern Time on Sundays and Wednesdays. However, the Company reserves the right to perform maintenance at any time at its discretion that it believes such maintenance is necessary. The Company will make a reasonable effort to provide notice to those customers likely to be affected by such maintenance work.

4. Obligations of customer and Company:
  - (a) The Company is not responsible for the installation, operation or maintenance of any equipment provided by the customer.
  - (b) The customer is responsible for the provision and maintenance of all customer provided equipment and to insure that the operating characteristics of this equipment is comparable with and does not interfere with the service offered by the Company.
  - (c) At the BellSouth Metro Ethernet service Connection point the customer's signals must conform to IEEE Standards 802.3, 802.3u or 802.3z. To meet end-to-end delay requirements contained in these aforementioned standards, the customer may be required to provide additional equipment.
5. In some cases, the Company and another Incumbent Local Exchange Company (ILEC) may agree to jointly provide a customer Metro Ethernet Service. The rates and charges for the BellSouth Metro Ethernet service Connection are applicable for such connectivity; charges for BellSouth Metro Ethernet Additional Mileage are also applicable when the mileage from the BellSouth/ILEC meet-point to the BellSouth Metro Ethernet wire center associated with the service is over ten (10) miles. The Company is only responsible for the ordering, provisioning, maintaining and billing of such service up to the meet-point (i.e., demarcation point with the ILEC). BellSouth Metro Ethernet service SLA credits shall only be applicable for the portion of the service provided within the territory of the Company; such credits are appropriate only for missed commitments determined to be the fault of the Company.

Note 1: Effective on or after August 22, 2021, this Service will no longer be available for purchase by new or existing customers. In addition, requests to move, add, change, or renew existing service arrangements will not be accepted. Following the expiration of a customer's existing term agreement, service will be provided on a month-to-month basis at the applicable Monthly rates until the service is discontinued. The Company currently plans to discontinue this service on or after March 31, 2023.

(N)  
|  
(N)

## E7. SPECIAL ACCESS (A.K.A. BELLSOUTH SPA) SERVICE

### E7.4 Rate Regulations (Cont'd)

#### E7.4.32 BellSouth Metro Ethernet Service<sup>1</sup>

##### A. General (Cont'd)

6. Basic, Premium and Virtual BellSouth Metro Ethernet Service Connections of 10 Mbps or higher may alternatively be provided to a customer premises over the customer's SMARTRing<sup>2</sup> service (a.k.a. BellSouth SPA Dedicated Ring). (C)  
The customer is required to purchase the appropriate SMARTRing<sup>2</sup> service (a.k.a. BellSouth SPA Dedicated Ring) BellSouth Metro Ethernet Backbone interfaces that are a bandwidth equal to the bandwidth of the BellSouth Metro Ethernet Service backbone transport that is standard for the specific type and speed of BellSouth Metro Ethernet Service Connection serving that customer premises. (A chart is provided herein which sets forth the backbone bandwidth of each type and speed of BellSouth Metro Ethernet Service Connection.) Standard BellSouth Metro Ethernet Service features are available on such alternative arrangements, with the exception that Automatic Protection Switching is not available. (C)  
For such applications using SMARTRing<sup>2</sup> service (a.k.a. BellSouth SPA Dedicated Ring) as alternate transport, the BellSouth Metro Ethernet Service Connection will provide data channel transport to connect the termination of the SMARTRing<sup>2</sup> service (a.k.a. BellSouth SPA Dedicated Ring) at the central office node, to the BellSouth Metro Ethernet Service wire center associated with the BellSouth Metro Ethernet Service Connection (i.e., the central office of the Metro Ethernet Service switch). (C)  
When the SMARTRing<sup>2</sup> service (a.k.a. BellSouth SPA Dedicated Ring) central office node is located greater than 10 miles from the BellSouth Metro Ethernet Service wire center, BellSouth Metro Ethernet Service Additional Mileage charges will also be applicable. (C)  
For BellSouth Metro Ethernet Service Connections utilizing the customer's LightGate service or SMARTRing<sup>2</sup> service as alternate transport, the committed bandwidth for select speeds will be as shown in BellSouth Technical Reference TR-73632. (C)

Metro Ethernet Connection	Metro Ethernet Backbone Bandwidth
Basic 10 Mbps	100 Mbps (1 STS-1)
Basic 100 Mbps	100 Mbps (3 STS-1)
Basic 1000 Mbps	1000 Mbps
Premium 10, 20, 50 Mbps (Fixed)	100 Mbps (1 STS-1)
Premium 10, 20, 50 Mbps (Burst)	100 Mbps (3 STS-1)
Premium 100Mbps (Fixed)	Fractional 1000 Mbps at 150 Mbps
Premium 250 Mbps (Fixed)	Fractional 1000 Mbps at 300 Mbps
Premium 500 Mbps (Fixed)	Fractional 1000 Mbps at 600 Mbps
Premium 100, 250, 500 Mbps (Burst)	1000 Mbps
Virtual 10, 20, 50 Mbps	100 Mbps (1 STS-1)
Virtual 80 Mbps	100 Mbps (3 STS-1)
Virtual 100 Mbps	Fractional 1000 Mbps at 150 Mbps
Virtual 200, 300 Mbps	Fractional 1000 Mbps at 300 Mbps
Virtual 450 Mbps	Fractional 1000 Mbps at 450 Mbps
Virtual 600 Mbps	Fractional 1000 Mbps at 600 Mbps
Virtual 750, 900 Mbps	1000 Mbps

7. In some cases, the Telephone Company and an Independent Telephone Company (ICO) may agree to jointly provide a customer Metro Ethernet Service. The rates and charges for the BellSouth Metro Ethernet Service Connection are applicable for such connectivity; charges for BellSouth Metro Ethernet Additional Mileage are also applicable when the mileage from the BellSouth/ICO meet-point to the BellSouth Metro Ethernet wire center associated with the service is over 10 miles. The Telephone Company is only responsible for the ordering, provisioning, maintaining and billing of such service up to the meet-point (i.e., demarcation point with the ICO). BellSouth Metro Ethernet Service SLA credits shall only be applicable for the portion of the service provided within the territory of the Telephone Company; such credits are appropriate only for missed commitments determined to be the fault of the Telephone Company.

**Note 1:** Effective on or after August 22, 2021, this Service will no longer be available for purchase by new or existing customers. In addition, requests to move, add, change, or renew existing service arrangements will not be accepted. Following the expiration of a customer's existing term agreement, service will be provided on a month-to-month basis at the applicable Monthly rates until the service is discontinued. The Company currently plans to discontinue this service on or after March 31, 2023.

**Note 2:** Effective on or after December 1, 2021, neither new nor existing customers will be permitted to purchase new SMARTRing Service (Service). In addition, (A) Service Payment Plans greater than 12-months in length will no longer be available; and (B) requests to move, add, change, upgrade, or downgrade existing service arrangements will not be accepted, with the following exceptions: (1) existing customers will be permitted to modify their existing Service and will be able to add new circuits to their existing Service, but will not be permitted to add new nodes in any locations; and (2) any such new circuits will be subject to the customer's existing term payment plan or term agreement for the Service to which they are added. Following the expiration of a customer's existing term agreement, Service will be provided on a month-to-month basis at the applicable Month-to-Month rates until the Service is discontinued. (N)

Effective November 30, 2023, unless specified to the contrary in their existing Service agreements, existing customers may not renew Term Payment Plans or term agreements for Service. In addition, no move, add, or change orders of any type will be accepted. (N)

## E7. SPECIAL ACCESS (A.K.A. BELLSOUTH SPA) SERVICE

### E7.4 Rate Regulations (Cont'd)

#### E7.4.32 BellSouth Metro Ethernet Service (Cont'd)<sup>1</sup>

(C)

##### B. Rate Categories and Regulations

1. The following rate categories apply for BellSouth Metro Ethernet service. Applicable rates and charges are provided in E7.5.22 following.
  - (a) Basic BellSouth Metro Ethernet service Connection
  - (b) Premium BellSouth Metro Ethernet service Connection
  - (c) **(DELETE)**
  - (d) Virtual BellSouth Metro Ethernet service Connection
  - (e) BellSouth Metro Ethernet service Additional Mileage Charges
  - (f) Priority Plus Feature
  - (g) Q-Forwarding Feature
  - (h) VLAN Aggregation Feature
  - (i) **CNM** - Metro Ethernet Reporting Feature
  - (j) Class of Service (CoS) Profile
  - (k) Automatic Protection Switching Feature
  - (l) Service Reconfiguration Charge
  - (m) System Reconfiguration Charge
2. BellSouth Metro Ethernet service is available under month-to-month rates as provided in E7.5.22.A. following or under the optional Transport Payment Plan (TPP) (as described in E2.4.9.C. of this Tariff) to receive the TPP rates provided in E7.5.22.B. following.
3. BellSouth Metro Ethernet service Connections are provided utilizing various Ethernet equipment configurations referred to herein as "physical service types". The physical service type of each BellSouth Metro Ethernet Connection is provided in the chart in 5. following.
4. A hierarchy of the various BellSouth Metro Ethernet service Connections by capability (i.e., basic, premium and virtual) and speed is provided in the chart in 5. following. This chart provides a higher order of service ranking that is utilized to determine the appropriate nonrecurring charges for service reconfiguration requests. This ranking is also utilized to determine if termination liability is applicable for specific reconfiguration requests if the service is under a TPP term commitment.

**Note 1:** Effective on or after August 22, 2021, this Service will no longer be available for purchase by new or existing customers. In addition, requests to move, add, change, or renew existing service arrangements will not be accepted. Following the expiration of a customer's existing term agreement, service will be provided on a month-to-month basis at the applicable Monthly rates until the service is discontinued. The Company currently plans to discontinue this service on or after March 31, 2023.

(N)  
|  
(N)

## E7. SPECIAL ACCESS (A.K.A. BELLSOUTH SPA) SERVICE

### E7.4 Rate Regulations (Cont'd)

#### E7.4.32 BellSouth Metro Ethernet Service (Cont'd)<sup>3</sup>

(C)

##### B. Rate Categories and Regulations (Cont'd)

5. The following informational chart provides the physical service type of each BellSouth Metro Ethernet Connection and provides the other BellSouth Metro Ethernet Connections which are considered to be a higher order of service (BellSouth Metro Ethernet service hierarchy).

Metro Ethernet Connection (Mbps):	Physical Service Type:	Higher Order of Service (Mbps):
- Basic 2	Basic 0	Basic 4,8,10,100,1000; Premium <sup>1</sup> 2, 4, 8,10,20,50,100,250,500; Virtual 2,4,8,10,20,50,80,100,200,300,450,600,750,900
- Basic 4	Basic 0	Basic 8,10,100,1000; Premium <sup>1</sup> 4, 8,10,20,50,100,250,500; Virtual 4,8,10,20,50,80,100,200,300,450,600,750,900
- Basic 8	Basic 0	Basic 10,100,1000; Premium <sup>1</sup> 8,10,20,50,100,250,500; Virtual 8,10,20,50,80,100,200,300,450,600,750,900
- Basic 10	Basic I	Basic 100,1000; Premium <sup>1</sup> 10,20,50,100,250,500,900 <sup>2</sup> ; Virtual 10,20,50,80,100,200,300,450,600,750,900
- Basic 100	Basic II	Basic 1000; Premium <sup>1</sup> 100,250,500,900 <sup>2</sup> ; Virtual 80,100,200,300,450,600,750,900
- Basic 1000	Basic III	Premium <sup>1</sup> 500,900 <sup>2</sup> ; Virtual 450,600,750,900
- Premium 2	Premium 0	Basic 100,1000; Premium <sup>1</sup> 4,8,10,20,50,100,250,500; Virtual 2,4,8,10,20,50,80,100,200,300,450,600,750,900
- Premium 4	Premium 0	Basic 100,1000; Premium <sup>1</sup> 8,10,20,50,100,250,500; Virtual 4,8,10,20,50,80,100,200,300,450,600,750,900
- Premium 8	Premium 0	Basic 100,1000; Premium <sup>1</sup> 10,20,50,100,250,500; Virtual 8,10,20,50,80,100,200,300,450,600,750,900
- Premium <sup>1</sup> 10	Premium I	Basic 1000; Premium <sup>1</sup> 20,50,100,250,500,900 <sup>2</sup> ; Virtual 10,20,50,80,100,200,300,450,600,750,900
- Premium <sup>1</sup> 20	Premium I	Basic 1000; Premium <sup>1</sup> 50,100,250,500,900 <sup>2</sup> ; Virtual 20,50,80,100,200,300,450,600,750,900
- Premium <sup>1</sup> 50	Premium I	Premium <sup>1</sup> 100,250,500,900 <sup>2</sup> ; Virtual 50,80,100,200,300,450,600,750,900
- Premium <sup>1</sup> 100	Premium II	Premium <sup>1</sup> 250,500,900 <sup>2</sup> ; Virtual 100,200,300,450,600,750,900
- Premium <sup>1</sup> 250	Premium II	Premium <sup>1</sup> 500,900 <sup>2</sup> ; Virtual 300,450,600,750,900
- Premium <sup>1</sup> 500	Premium II	Premium 900 <sup>2</sup> ; Virtual 450,600,750,900
- Premium 900 <sup>2</sup>	Premium II	Virtual 900
- Virtual 2	Virtual 0	Basic 100,1000; Premium <sup>1</sup> 10,20,50,100,250,500; Virtual 4,8,10,20,50,80,100,200,300,450,600,750,900
- Virtual 4	Virtual 0	Basic 100,1000; Premium <sup>1</sup> 10,20,50,100,250,500; Virtual 8,10,20,50,80,100,200,300,450,600,750,900
- Virtual 8	Virtual 0	Basic 100,1000; Premium <sup>1</sup> 10,20,50,100,250,500; Virtual 10,20,50,80,100,200,300,450,600,750,900
- Virtual 10	Virtual I	Basic 1000; Premium <sup>1</sup> 20,50,100,250,500,900 <sup>2</sup> ; Virtual 20,50,80,100,200,300,450,600,750,900
- Virtual 20	Virtual I	Basic 1000; Premium <sup>1</sup> 50,100,250,500,900 <sup>2</sup> ; Virtual 50,80,100,200,300,450,600,750,900
- Virtual 50	Virtual II	Basic 1000; Premium <sup>1</sup> 100,250,500,900 <sup>2</sup> ; Virtual 80,100,200,300,450,600,750,900
- Virtual 80	Virtual II	Basic 1000; Premium <sup>1</sup> 100,250,500,900 <sup>2</sup> ; Virtual 100,200,300,450,600,750,900
- Virtual 100	Virtual II	Premium <sup>1</sup> 250,500,900 <sup>2</sup> ; Virtual 200,300,450,600,750,900
- Virtual 200	Virtual II	Premium <sup>1</sup> 500,900 <sup>2</sup> ; Virtual 300,450,600,750,900
- Virtual 300	Virtual II	Premium <sup>1</sup> 500,900 <sup>2</sup> ; Virtual 450,600,750,900
- Virtual 450	Virtual II	Premium 900 <sup>2</sup> ; Virtual 600,750,900
- Virtual 600	Virtual II	Premium 900 <sup>2</sup> ; Virtual 750,900
- Virtual 750	Virtual II	Premium 900 <sup>2</sup> ; Virtual 900
- Virtual 900	Virtual II	None offered at this time

Note in the above chart that the reference to Basic 1000 Mbps refers to Basic 1 Gbps.

**Note 1:** Fixed Mode or Burst Mode.

**Note 2:** Premium 900 Mbps only available as Fixed Mode.

**Note 3:** Effective on or after August 22, 2021, this Service will no longer be available for purchase by new or existing customers. In addition, requests to move, add, change, or renew existing service arrangements will not be accepted. Following the expiration of a customer's existing term agreement, service will be provided on a month-to-month basis at the applicable Monthly rates until the service is discontinued. The Company currently plans to discontinue this service on or after March 31, 2023.

(N)  
|  
(N)



## E7. SPECIAL ACCESS (A.K.A. BELLSOUTH SPA) SERVICE

### E7.4 Rate Regulations (Cont'd)

#### E7.4.32 BellSouth Metro Ethernet Service (Cont'd)<sup>1</sup>

(C)

##### B. Rate Categories and Regulations (Cont'd)

6. A BellSouth Metro Ethernet reconfiguration nonrecurring charge is applicable for a customer request to reconfigure (rearrange) an existing BellSouth Metro Ethernet Connection. The appropriate reconfiguration charge is dependent upon the physical work required to fulfill the request and applies in lieu of other nonrecurring charges.  
A Service Reconfiguration Charge is applicable for requests where the work required is a minor change that does not involve changing the physical service type. The Service Reconfiguration Charge is applicable for a request to change an existing connection to a different connection that is the same physical service type *that is a lower order of service*, is applicable for a request to change a Premium connection from fixed mode to burst mode (and vice versa) and is applicable for a request to change a Premium connection to add or delete the Priority Plus feature. The Service Reconfiguration Charge is also applicable for changing an existing Virtual connection CoS Profile.  
A System Reconfiguration Charge is applicable for requests where the work required involves changing to a different physical service type or involves major support system changes. The System Reconfiguration Charge is applicable for requests to change an existing connection to a different connection that is a different physical service type *that is a lower order of service*, to change the network channel terminating equipment (NCTE) interface option from optical to electrical (or vice-versa), and to change the premises powering options from AC power to DC power (or vice-versa).
7. **(DELETED)**

Note 1: Effective on or after August 22, 2021, this Service will no longer be available for purchase by new or existing customers. In addition, requests to move, add, change, or renew existing service arrangements will not be accepted. Following the expiration of a customer's existing term agreement, service will be provided on a month-to-month basis at the applicable Monthly rates until the service is discontinued. The Company currently plans to discontinue this service on or after March 31, 2023.

(N)  
|  
(N)

## E7. SPECIAL ACCESS (A.K.A. BELLSOUTH SPA) SERVICE

### E7.4 Rate Regulations (Cont'd)

#### E7.4.32 BellSouth Metro Ethernet Service (Cont'd)<sup>2</sup>

(C)

##### B. Rate Categories and Regulations (Cont'd)

8. A Premium BellSouth Metro Ethernet Connection-Fixed Mode and Premium BellSouth Metro Ethernet Connection-Burst Mode of the same speed are considered to be the same order of service and same physical service type. A Service Reconfiguration Charge is applicable for a customer request to reconfigure a Premium BellSouth Metro Ethernet Connection from Fixed Mode to Burst Mode (at the same speed), or vice versa; this nonrecurring charge is in lieu of the nonrecurring charge for the new connection. Such a change is not treated as a disconnect and there will be no change in the minimum period requirements.

A Virtual BellSouth Metro Ethernet Connection request to modify its CoS Profile is not considered as a request to change the order of service or physical service type. A Service Reconfiguration Charge is applicable for such requests.

9. Except as specified in 8. preceding, a BellSouth Metro Ethernet Connection not shown as a higher order of service in the hierarchy chart in 5. preceding for a given BellSouth Metro Ethernet Connection is considered to be a lower order of service. A reconfiguration charge is applicable for a customer request to change an existing BellSouth Metro Ethernet Connection to a different BellSouth Metro Ethernet Connection that is a lower order of service; the appropriate reconfiguration charge is applicable in lieu of the standard nonrecurring charge for the lower order of service connection. A Service Reconfiguration Charge is applicable when the lower order of service connection is the same physical service type; a System Reconfiguration Charge is applicable when the lower order of service is a different physical service type. New minimum period requirements are established for the lower order of service connection.

10. A System Reconfiguration Charge is applicable for a customer request to change the premises powering option (AC power to DC power) or NCTE signaling interface option (optical to electrical, or vice-versa) on an existing BellSouth Metro Ethernet Connection. Such a change is not treated as a disconnect and there will be no change in the minimum period requirements.

11. A move of a BellSouth Metro Ethernet service will be as follows (in accordance with E7.4.5 preceding and, if applicable, E2.4.9.C.5. of this Tariff).

When the move is to a new location within the same building, the charge for the move will be an amount equal to one-half of the Connection nonrecurring charge. There will be no change in the minimum period requirements.

When the move is to a new location in a different building that is within the same serving wire center, the charge for the move will be the nonrecurring charge for the BellSouth Metro Ethernet service Connection. New minimum period requirements will be established.<sup>1</sup>

When the move is to a new location in a different building that is not in the same serving wire center, the request is treated as a discontinuance and start of service and all associated BellSouth Metro Ethernet service nonrecurring charges will apply. New minimum period requirements will be established.<sup>1</sup>

**Note 1:** Such moves of Metro Ethernet Service with Automatic Protection Switching (APS) shall additionally incur the full nonrecurring charge for establishing the APS feature at the new premises (as a new APS design will be required). The APS monthly recurring charge may change as appropriate based upon the actual route mileage associated with the new premises' APS design.

**Note 2:** Effective on or after August 22, 2021, this Service will no longer be available for purchase by new or existing customers. In addition, requests to move, add, change, or renew existing service arrangements will not be accepted. Following the expiration of a customer's existing term agreement, service will be provided on a month-to-month basis at the applicable Monthly rates until the service is discontinued. The Company currently plans to discontinue this service on or after March 31, 2023.

(N)  
|  
(N)

## E7. SPECIAL ACCESS (A.K.A. BELLSOUTH SPA) SERVICE

### E7.4 Rate Regulations (Cont'd)

#### E7.4.32 BellSouth Metro Ethernet Service (Cont'd)<sup>2</sup>

(C)

##### C. Service Level Agreement for Premium BellSouth Metro Ethernet service

Customer networks with Premium BellSouth Metro Ethernet service and *CNM* - Metro Ethernet Reporting are provided Service Level Agreements (SLAs) as summarized herein E7.4.32.C. BellSouth Metro Ethernet Service SLAs outlined herein specify the Company's repair and performance commitments for *CNM* - Metro Ethernet Reporting customers with Premium Metro Ethernet Connections. Details of the technical measurements and performance results methodologies for each commitment are provided in BellSouth Technical Reference TR-73632.

In accordance with E7.4.32.C.3.(c) following, credits are available for missed commitments to customers purchasing Premium BellSouth Metro Ethernet service with the *CNM* - Metro Ethernet Reporting feature. Credits only apply for portions of service provided by the Company.

The following service measurements will outline the service levels the Telephone Company will deliver to *CNM* - Metro Ethernet Reporting customers with Premium Metro Ethernet Connections:

##### Repair Commitment:

- BellSouth Metro Ethernet service Time-to-Repair<sup>1</sup>

##### Network Service Level Commitments:

- BellSouth Metro Ethernet service Core Network Availability
- BellSouth Metro Ethernet service Core Network Latency

The Repair Commitment is measured on a per occurrence basis for each BellSouth Metro Ethernet Connection. A Fault Report is produced thru the *CNM* - Metro Ethernet Reporting system that aids identification of potential outage durations upon which credits may be requested.

The Network Service Level Commitments are measured on the monthly performance of the Metro Ethernet core network during a specific calendar month. An SLA Report is produced thru the *CNM* - Metro Ethernet Reporting system that provides details of missed Network Service Level Commitments upon which credits may be requested based upon a specific calendar month's performance results.

The Company's performance measurement data for the Repair Commitment and Network Service Level Commitments will be collected and calculated utilizing the Company's internal processes as set forth in BellSouth Technical Reference TR-73632. The Company's calculation of its performance shall be the sole determinate of the Company's obligation to provide a credit for a missed performance commitment.

##### 1. SLA Definitions

##### BellSouth Metro Ethernet service Time to Repair

- BellSouth Metro Ethernet service Time-To-Repair measures the outage duration on a customer's BellSouth Metro Ethernet Connection. This measure will require the customer to report the problem to the BellSouth repair center.
- The repair interval will start with the time the trouble ticket is created and end when the fault is re-mediated. The Service Level Commitment measurement will be based on each individual trouble ticket for a customer's connection. Time for scheduled maintenance windows (as set forth in E7.4.32.A.3. preceding) does not count towards SLA threshold.

##### BellSouth Metro Ethernet service Network Availability

- BellSouth Metro Ethernet service Network Availability measures the percentage of time during a calendar month that the customer's service is unavailable on the core network. The core network is defined as being from the Ethernet switch serving the customer's A-end to the Ethernet switch serving the customer's B-end. Customer networks that do not span more than one switch in the core network are not eligible for the Network Availability SLA, and one will not be provided.
- This Service Level Commitment will be calculated by measuring and summing the outage for each core network component used by the customer, divided by the total number of components, times the total service time for a particular calendar month. Excluded from the outage time and service time are scheduled maintenance windows (as set forth in E7.4.32.A.3. preceding) and time the network was unavailable due to circumstances outside the Company's control (as set forth in E7.4.32.C.3.(b) following).

**Note 1:** SLA not applicable if missed due to SMARTRing service (a.k.a BellSouth SPA Dedicated Ring) outage where BellSouth Metro Ethernet is using SMARTRing service (a.k.a BellSouth SPA Dedicated Ring) as alternate transport.

**Note 2:** Effective on or after August 22, 2021, this Service will no longer be available for purchase by new or existing customers. In addition, requests to move, add, change, or renew existing service arrangements will not be accepted. Following the expiration of a customer's existing term agreement, service will be provided on a month-to-month basis at the applicable Monthly rates until the service is discontinued. The Company currently plans to discontinue this service on or after March 31, 2023.

(N)

(N)

## E7. SPECIAL ACCESS (A.K.A. BELLSOUTH SPA) SERVICE

### E7.4 Rate Regulations (Cont'd)

#### E7.4.32 BellSouth Metro Ethernet Service (Cont'd)<sup>2</sup>

(C)

##### C. Service Level Agreement for Premium BellSouth Metro Ethernet service<sup>1</sup> (Cont'd)

###### 1. SLA Definitions (Cont'd)

BellSouth Metro Ethernet service Network Latency

- BellSouth Metro Ethernet service Network Latency measures average one-way delay in milliseconds within the core network. The core network is defined as being from the Ethernet switch serving the customer's A-end to the Ethernet switch serving the customer's B-end. Customer networks that do not span more than one switch in the core network are not eligible for the Network Latency SLA, and one will not be provided.
- This Service Level Commitment will be calculated by averaging the measured latency of simulated traffic within the Metro Ethernet Customer Network (i.e., between each pair of connections) during a calendar month.

###### 2. The Company's Service Level Commitments for Premium BellSouth Metro Ethernet service are as follows:

- BellSouth Metro Ethernet service Time-To-Repair – 4 hours or less
- BellSouth Metro Ethernet service Network Availability – 99.9% or higher
- BellSouth Metro Ethernet service Network Latency – 55 milliseconds or less

###### 3. SLA Restrictions

- (a) The Company will implement SLA provisioning restrictions that will define customer network design requirements and limitations to BellSouth's commitment to meet Service Levels for BellSouth Metro Ethernet service. The customer network design requirements are as follows:
  - A customer must subscribe to the Metro Ethernet Premium Service with *CNM* - Metro Ethernet Reporting to receive credits for missed Service Level Commitments.
  - Credits are not provided for partial month service.
  - A customer's account must be current to receive a credit.
- (b) SLA Credits do not apply when any stated objective is not met because the Company does not have control over the circumstances causing the objective to be missed. Situations over which the Company does not have control include, but are not limited to, the following:
  - any act, any omission or negligence on the part of the customer, any other customer or any third party, or of any other entity providing a portion of the service,
  - labor difficulties, governmental orders, civil commotions, acts of civil or military authority, embargoes, epidemics, declared National Emergencies, criminal actions against the Company, war, terrorist acts, riots, insurrections, fires, explosions, nuclear accidents, power blackouts, acts of God (including, but not limited to, earthquakes, floods or unusually severe weather) or other circumstances beyond the Company's control,
  - the customer's premises equipment, and
  - unavailability of the customer's facilities and/or equipment including customer-provided power and environmental conditions for BellSouth-owned and operated equipment located on the customer's premises.
- (c) The Customer must request a credit within one month of the Company missing a BellSouth Metro Ethernet service Level Commitment. A customer request for a Network Service Level SLA credit must be submitted on a standard request form issued by the Company that includes the month the SLA commitment was missed, accurate identification of the affected circuit, and the observed measurement of the specific SLA that was missed. A customer request for a Repair SLA credit must be submitted on a standard request form issued by the Company that includes the month the SLA commitment was missed, accurate identification of the affected circuit, and the trouble ticket number of the repair request. The Company will investigate customer requests for any SLA credits to determine the cause of any performance failures reported by the customer. The Company will investigate the customer's request over a period of up to 45 calendar days. The 45-day period will begin when the customer makes the request for credit with their BellSouth Sales Representative. SLA credits will be provided to the customer if the Company determines that the Company had control over the circumstances causing the failure.

**Note 1:** Details of the technical measurements and performance results methodologies for each Commitment are provided in BellSouth Technical Reference TR-73632.

**Note 2:** Effective on or after August 22, 2021, this Service will no longer be available for purchase by new or existing customers. In addition, requests to move, add, change, or renew existing service arrangements will not be accepted. Following the expiration of a customer's existing term agreement, service will be provided on a month-to-month basis at the applicable Monthly rates until the service is discontinued. The Company currently plans to discontinue this service on or after March 31, 2023.

(N)  
|  
(N)

## E7. SPECIAL ACCESS (A.K.A. BELLSOUTH SPA) SERVICE

### E7.4 Rate Regulations (Cont'd)

#### E7.4.32 BellSouth Metro Ethernet Service (Cont'd)<sup>4</sup>

(C)

##### C. Service Level Agreement for Premium BellSouth Metro Ethernet service<sup>1</sup> (Cont'd)

##### 4. SLA Credits for Premium Connections with *CNM* - Metro Ethernet Reporting

The following credits will apply when the Company misses a Service Level Commitment (each credit is described in (a) thru (c) following):

BellSouth Metro Ethernet service Time-To-Repair:

- 0 to 4 hours per incident: No Credit
- Over 4 hours to 24 hours per incident: A credit equal to 3/30 of the monthly recurring charges for all the rate elements<sup>2</sup> associated with the affected Metro Ethernet Connection
- Each additional 24-hour period, per incident: Credit an additional amount equal to 3/30 of the monthly recurring charges for all the rate elements<sup>2</sup> associated with the affected Metro Ethernet Connection

BellSouth Metro Ethernet service Network Availability:

- A credit equal to 3/30 of the monthly recurring charges for all the rate elements<sup>2</sup> associated with the affected Metro Ethernet Connection.

BellSouth Metro Ethernet service Network Latency:

- A credit equal to 3/30 of the monthly recurring charges for all the rate elements<sup>2</sup> associated with the affected Metro Ethernet Connection.

The SLA credit amount will be determined by applying the credits outlined preceding to the rate elements or total billed revenues specified following.

The total credits issued for all SLAs for a specific BellSouth Metro Ethernet service Connection during a single bill period may not exceed the total monthly recurring charges billed for all the rate elements associated with that BellSouth Metro Ethernet service Connection. Credits are not provided for partial month service.

- (a) BellSouth Metro Ethernet service Time-To-Repair Credit – The Service Level Commitment measurement will be based on each individual trouble ticket for a customer's connection. Multiple trouble tickets on the same day for the same customer connection will only be eligible for one time-to-repair credit. The SLA credit will apply to the monthly recurring charges for all the rate elements<sup>2</sup> associated with the affected Metro Ethernet Connection.
- (b) BellSouth Metro Ethernet service Network Availability Credit<sup>3</sup> – The Service Level commitment measurement will be based on a specific calendar month's performance. The credit will apply for each BellSouth Metro Ethernet service connection that does not meet the availability commitment. The SLA credit will apply to the monthly recurring charges for all the rate elements<sup>2</sup> associated with the affected Metro Ethernet Connection.
- (c) BellSouth Metro Ethernet service Latency Credit<sup>3</sup> – The Service Level commitment measurement will be based on a specific calendar month's performance. The credit will apply for each BellSouth Metro Ethernet service connection that does not meet the latency commitment. The SLA credit will apply to the monthly recurring charges for all the rate elements<sup>2</sup> associated with the affected Metro Ethernet Connection.

**Note 1:** Details of the technical measurements and performance results methodologies for each Commitment are provided in BellSouth Technical Reference TR-73632.

**Note 2:** Specifically, rate elements for the Metro Ethernet Connection, Additional Mileage and Features.

**Note 3:** BellSouth Metro Ethernet networks that do not span more than one switch in the core network are not eligible for credits under this SLA.

**Note 4:** Effective on or after August 22, 2021, this Service will no longer be available for purchase by new or existing customers. In addition, requests to move, add, change, or renew existing service arrangements will not be accepted. Following the expiration of a customer's existing term agreement, service will be provided on a month-to-month basis at the applicable Monthly rates until the service is discontinued. The Company currently plans to discontinue this service on or after March 31, 2023.

(N)  
|  
(N)

## E7. SPECIAL ACCESS (A.K.A. BELLSOUTH SPA) SERVICE

### E7.4 Rate Regulations (Cont'd)

#### E7.4.32 BellSouth Metro Ethernet Service (Cont'd)<sup>4</sup>

(C)

##### D. Service Level Agreement for Virtual BellSouth Metro Ethernet service

Customer networks with Virtual BellSouth Metro Ethernet Service and *CNM* - Metro Ethernet Reporting are provided Service Level Agreements (SLAs) as summarized herein E7.4.32.D. BellSouth Metro Ethernet Service SLAs outlined herein specify the Telephone Company's repair and performance commitments for *CNM* - Metro Ethernet Reporting customers with Virtual Metro Ethernet Connections. SLAs will be applied on a per Class of Service (CoS) basis for Virtual Connections; traffic representing the different CoS (i.e., Best Effort, Business Critical, Real-Time and Interactive) transported across the same Virtual Connection will have different SLAs. Details of the technical measurements and performance results methodologies for each commitment are provided in BellSouth Technical Reference TR-73632.

In accordance with E7.4.32.D.3.(c) following, credits are available for missed commitments to customers purchasing Virtual BellSouth Metro Ethernet Service with the Metro Ethernet Reporting feature. Credits only apply for portions of service provided by the Telephone Company.

The following service measurements will outline the service levels the Telephone Company will deliver to *CNM* - Metro Ethernet Reporting customers with Virtual Metro Ethernet Connections:

##### Repair Commitment:

- BellSouth Metro Ethernet service Time-to-Repair<sup>1</sup>

##### Network Service Level Commitments:

- BellSouth Metro Ethernet service Core Network Availability
- BellSouth Metro Ethernet service Core Network Latency<sup>2</sup>
- BellSouth Metro Ethernet service Core Network Jitter<sup>2,3</sup>
- BellSouth Metro Ethernet service Core Network Packet Delivery<sup>2</sup>

The Repair Commitment is measured on a per occurrence basis for each BellSouth Metro Ethernet Connection for all CoS. A Fault Report is produced thru the *CNM* - Metro Ethernet Reporting system that aids identification of potential outage durations upon which credits may be requested.

The Network Service Level Commitments are measured on the monthly performance of the Metro Ethernet core network during a specific calendar month by CoS. An SLA Report is produced thru the *CNM* - Metro Ethernet Reporting system that provides details of missed Network Service Level Commitments by CoS upon which credits may be requested based upon a specific calendar month's performance results.

The Company's performance measurement data for the Repair Commitment and Network Service Level Commitments will be collected and calculated utilizing the Company's internal processes as set forth in BellSouth Technical Reference TR-73632. The Company's calculation of its performance shall be the sole determinate of the Company's obligation to provide a credit for a missed performance commitment.

**Note 1:** SLA not applicable if missed due to SMARTRing service (a.k.a BellSouth SPA Dedicated Ring) outage where BellSouth Metro Ethernet is using SMARTRing service (a.k.a BellSouth SPA Dedicated Ring) as alternate transport.

**Note 2:** SLA not applicable for Best Effort CoS.

**Note 3:** SLA not applicable for Business Critical CoS.

**Note 4:** Effective on or after August 22, 2021, this Service will no longer be available for purchase by new or existing customers. In addition, requests to move, add, change, or renew existing service arrangements will not be accepted. Following the expiration of a customer's existing term agreement, service will be provided on a month-to-month basis at the applicable Monthly rates until the service is discontinued. The Company currently plans to discontinue this service on or after March 31, 2023.

(N)

(N)

## E7. SPECIAL ACCESS (A.K.A. BELLSOUTH SPA) SERVICE

### E7.4 Rate Regulations (Cont'd)

#### E7.4.32 BellSouth Metro Ethernet Service (Cont'd)<sup>2</sup>

(C)

##### D. Service Level Agreement for Virtual BellSouth Metro Ethernet service<sup>1</sup> (Cont'd)

###### 1. SLA Definitions

###### BellSouth Metro Ethernet service Time to Repair

- BellSouth Metro Ethernet Service Time-To-Repair measures the outage duration on a customer's BellSouth Metro Ethernet Connection for all CoS. This measure will require the customer to report the problem to the BellSouth repair center.
- The repair interval will start with the time the trouble ticket is created and end when the fault is re-mediated. The Service Level Commitment measurement will be based on each individual trouble ticket for a customer's connection. Time for scheduled maintenance windows (as set forth in E7.4.32.A.3.) does not count towards SLA threshold.

###### BellSouth Metro Ethernet service Network Availability

- BellSouth Metro Ethernet Service Network Availability measures the percentage of time by CoS during a calendar month that the customer's service is unavailable on the core network. The core network is defined as being from the Ethernet switch serving the customer's A-end to the Ethernet switch serving the customer's B-end. Customer networks that do not span more than one switch in the core network are not eligible for the Network Availability SLA, and one will not be provided.
- This Service Level Commitment will be calculated by CoS by measuring and summing the outage for each core network component used by the customer, divided by the total number of components, times the total service time for a particular calendar month. Excluded from the outage time and service time are scheduled maintenance windows (as set forth in E7.4.32.A.3.) and time the network was unavailable due to circumstances outside the Telephone Company's control (as set forth in E7.4.32.D.3.(b)).

###### BellSouth Metro Ethernet service Network Latency

- BellSouth Metro Ethernet Service Network Latency measures average one-way delay in milliseconds within the core network. The core network is defined as being from the Ethernet switch serving the customer's A-end to the Ethernet switch serving the customer's B-end. Customer networks that do not span more than one switch in the core network are not eligible for the Network Latency SLA, and one will not be provided.
- This Service Level Commitment will be calculated for each CoS (except the Best Effort CoS) by averaging the measured latency of simulated traffic for each eligible CoS within the Metro Ethernet Customer Network (i.e., between each pair of connections) during a calendar month.

###### BellSouth Metro Ethernet service Network Jitter

- BellSouth Metro Ethernet Service Jitter measures the average variability, measured in time (milliseconds) between the actual packet transmission rate and the expected packet transmission rate within the core network for Interactive and Real-Time CoS. The core network is defined as being from the Ethernet switch serving the customer's A-end to the Ethernet switch serving the customer's B-end.
- This Service Level Commitment will be calculated for the Interactive CoS and Real-Time CoS by averaging the measured jitter of simulated traffic for each of the customer's eligible CoS queue within the Metro Ethernet Customer Network (i.e., between each pair of connections) during a calendar month.

###### BellSouth Metro Ethernet service Packet Delivery

- BellSouth Metro Ethernet Service Network Packet Delivery measures the percentage of packets conforming to the committed bandwidth profile that are delivered across the core network, without being dropped or lost as a result of a fault within the Virtual Ethernet network. The core network is defined as being from the Ethernet switch serving the customer's A-end to the Ethernet switch serving the customer's B-end.
- This Service Level Commitment will be calculated for each CoS (except the Best Effort CoS) by averaging the measured packet delivery of simulated traffic for eligible CoS within the Metro Ethernet Customer Network (i.e., between each pair of connections) during a calendar month.

**Note 1:** Details of the technical measurements and performance results methodologies for each commitment are provided in BellSouth Technical Reference TR-73632.

**Note 2:** Effective on or after August 22, 2021, this Service will no longer be available for purchase by new or existing customers. In addition, requests to move, add, change, or renew existing service arrangements will not be accepted. Following the expiration of a customer's existing term agreement, service will be provided on a month-to-month basis at the applicable Monthly rates until the service is discontinued. The Company currently plans to discontinue this service on or after March 31, 2023.

(N)  
|  
(N)

## E7. SPECIAL ACCESS (A.K.A. BELLSOUTH SPA) SERVICE

### E7.4 Rate Regulations (Cont'd)

#### E7.4.32 BellSouth Metro Ethernet Service (Cont'd)<sup>2</sup>

(C)

**D.** Service Level Agreement for Virtual BellSouth Metro Ethernet service<sup>1</sup> (Cont'd)

2. The Telephone Company's Service Level Commitments for Virtual BellSouth Metro Ethernet service are as follows:

Time to Repair

- Best Effort CoS: 4 hours or less
- Business Critical CoS: 4 hours or less
- Interactive CoS: 4 hours or less
- Real-Time CoS: 4 hours or less

Network Availability

- Best Effort CoS: 99.500% or greater
- Business Critical CoS: 99.995% or greater
- Interactive CoS: 99.995% or greater
- Real-Time CoS: 99.995% or greater

Latency (one-way)

- Best Effort CoS: Not Applicable
- Business Critical CoS: 15 milliseconds or less
- Interactive CoS: 5 milliseconds or less
- Real-Time CoS: 5 milliseconds or less

Jitter

- Best Effort CoS: Not Applicable
- Business Critical CoS: Not Applicable
- Interactive CoS: 1 millisecond or less
- Real-Time CoS: 1 millisecond or less

Packet Delivery

- Best Effort CoS: Not Applicable
- Business Critical CoS: 99.900% or greater
- Interactive CoS: 99.950% or greater
- Real-Time CoS: 99.995% or greater

**Note 1:** Details of the technical measurements and performance results methodologies for each commitment are provided in BellSouth Technical Reference TR-73632.

**Note 2:** Effective on or after August 22, 2021, this Service will no longer be available for purchase by new or existing customers. In addition, requests to move, add, change, or renew existing service arrangements will not be accepted. Following the expiration of a customer's existing term agreement, service will be provided on a month-to-month basis at the applicable Monthly rates until the service is discontinued. The Company currently plans to discontinue this service on or after March 31, 2023.

(N)  
|  
(N)



## E7. SPECIAL ACCESS (A.K.A. BELLSOUTH SPA) SERVICE

### E7.4 Rate Regulations (Cont'd)

#### E7.4.32 BellSouth Metro Ethernet Service (Cont'd)<sup>2</sup>

(C)

**D.** Service Level Agreement for Virtual BellSouth Metro Ethernet service<sup>1</sup> (Cont'd)

**3.** SLA Restrictions

- (a) The Telephone Company will implement SLA provisioning restrictions that will define customer network design requirements and limitations to BellSouth's commitment to meet Service Levels for BellSouth Metro Ethernet Service. The customer network design requirements are as follows:
- A customer must subscribe to the Metro Ethernet Virtual Service with *CNM* - Metro Ethernet Reporting to receive credits for missed Service Level Commitments.
  - Credits are not provided for partial month service.
  - A customer's account must be current to receive a credit.
- (b) SLA Credits do not apply when any stated objective is not met because the Telephone Company does not have control over the circumstances causing the objective to be missed. Situations over which the Telephone Company does not have control include, but are not limited to, the following:
- any act, any omission or negligence on the part of the customer, any other customer or any third party, or of any other entity providing a portion of the service,
  - labor difficulties, governmental orders, civil commotions, acts of civil or military authority, embargoes, epidemics, declared National Emergencies, criminal actions against the Telephone Company, war, terrorist acts, riots, insurrections, fires, explosions, nuclear accidents, power blackouts, acts of God (including, but not limited to, earthquakes, floods or unusually severe weather) or other circumstances beyond the Telephone Company's control,
  - the customer's premises equipment, and
  - unavailability of the customer's facilities and/or equipment including customer-provided power and environmental conditions for BellSouth-owned and operated equipment located on the customer's premises.
- (c) The Customer must request a credit within one month of the Telephone Company missing a BellSouth Metro Ethernet Service Level Commitment. A customer request for a Network Service Level SLA credit must be submitted on a standard request form issued by the Company that includes the month the SLA commitment was missed, accurate identification of the affected circuit, and the observed measurement of the specific SLA that was missed. A customer request for a Repair SLA credit must be submitted on a standard request form issued by the Company that includes the month the SLA commitment was missed, accurate identification of the affected circuit, and the trouble ticket number of the repair request. The Telephone Company will investigate customer requests for any SLA credits to determine the cause of any performance failures reported by the customer. The Telephone Company will investigate the customer's request over a period of up to 45 calendar days. The 45-day period will begin when the customer makes the request for credit with their BellSouth Sales Representative. SLA credits will be provided to the customer if the Company determines that the Telephone Company had control over the circumstances causing the failure.

**Note 1:** Details of the technical measurements and performance results methodologies for each commitment are provided in BellSouth Technical Reference TR-73632.

**Note 2:** Effective on or after August 22, 2021, this Service will no longer be available for purchase by new or existing customers. In addition, requests to move, add, change, or renew existing service arrangements will not be accepted. Following the expiration of a customer's existing term agreement, service will be provided on a month-to-month basis at the applicable Monthly rates until the service is discontinued. The Company currently plans to discontinue this service on or after March 31, 2023.

(N)  
|  
(N)

## E7. SPECIAL ACCESS (A.K.A. BELLSOUTH SPA) SERVICE

### E7.4 Rate Regulations (Cont'd)

#### E7.4.32 BellSouth Metro Ethernet Service (Cont'd)<sup>3</sup>

(C)

**D.** Service Level Agreement for Virtual BellSouth Metro Ethernet service<sup>1</sup> (Cont'd)

**4.** SLA Credits for Virtual Connections with *CNM* - Metro Ethernet Reporting (Cont'd)

The following credits will apply when the Telephone Company misses a Service Level Commitment on any single CoS (each credit is described in (a) thru (e) following). A maximum of one credit will be applied monthly per Connection for an SLA not met for any CoS that is supported by the customer's CoS profile (i.e., a maximum of one credit is applicable for an SLA even if missed for multiple CoS).

BellSouth Metro Ethernet service Time-To-Repair:

- 0 to 4 hours per incident: No Credit
- Over 4 hours to 24 hours per incident: A credit equal to 3/30 of the monthly recurring charges for all the rate elements<sup>2</sup> associated with the affected Metro Ethernet Connection
- Each additional 24-hour period, per incident: Credit an additional amount equal to 3/30 of the monthly recurring charges for all the rate elements<sup>2</sup> associated with the affected Metro Ethernet Connection

BellSouth Metro Ethernet service Network Availability: A credit equal to 3/30 of the monthly recurring charges for all the rate elements<sup>2</sup> associated with the affected Metro Ethernet Connection

BellSouth Metro Ethernet service Latency: A credit equal to 3/30 of the monthly recurring charges for all the rate elements<sup>2</sup> associated with the affected Metro Ethernet Connection.

BellSouth Metro Ethernet service Jitter: A credit equal to 3/30 of the monthly recurring charges for all the rate elements<sup>2</sup> associated with the affected Metro Ethernet Connection.

BellSouth Metro Ethernet service Packet Delivery: A credit equal to 3/30 of the monthly recurring charges for all the rate elements<sup>2</sup> associated with the affected Metro Ethernet Connection.

**Note 1:** Details of the technical measurements and performance results methodologies for each commitment are provided in BellSouth Technical Reference TR-73632.

**Note 2:** Specifically, rate elements for the Metro Ethernet Connection, Additional Mileage and Features.

**Note 3:** Effective on or after August 22, 2021, this Service will no longer be available for purchase by new or existing customers. In addition, requests to move, add, change, or renew existing service arrangements will not be accepted. Following the expiration of a customer's existing term agreement, service will be provided on a month-to-month basis at the applicable Monthly rates until the service is discontinued. The Company currently plans to discontinue this service on or after March 31, 2023.

(N)  
|  
(N)

## E7. SPECIAL ACCESS (A.K.A. BELLSOUTH SPA) SERVICE

### E7.4 Rate Regulations (Cont'd)

#### E7.4.32 BellSouth Metro Ethernet Service (Cont'd)<sup>4</sup>

(C)

**D.** Service Level Agreement for Virtual BellSouth Metro Ethernet service<sup>1</sup> (Cont'd)

**4.** SLA Credits for Virtual Connections with *CNM* - Metro Ethernet Reporting (Cont'd)

The SLA credit amount will be determined by applying the credits outlined preceding to the rate elements or total billed revenues specified following:

The total credits issued for all SLAs for a specific BellSouth Metro Ethernet service Connection during a single bill period may not exceed the total monthly recurring charges billed for all the rate elements associated with that BellSouth Metro Ethernet service Connection. Credits are not provided for partial month service.

- (a) BellSouth Metro Ethernet Service Time-To-Repair Credit – The Service Level Commitment measurement will be based on each individual trouble ticket for a customer's connection. Multiple trouble tickets on the same day for the same customer connection will only be eligible for one time-to-repair credit. The SLA credit will apply to the monthly recurring charges for all the rate elements<sup>2</sup> associated with the affected Metro Ethernet Connection
- (b) BellSouth Metro Ethernet Service Network Availability Credit<sup>3</sup> – The Service Level Commitment measurement will be based on a specific calendar month's performance. The credit will apply for each BellSouth Metro Ethernet Service Connection that does not meet the availability commitment. The SLA credit will apply to the monthly recurring charges for all the rate elements<sup>2</sup> associated with the affected Metro Ethernet Connection.
- (c) BellSouth Metro Ethernet Service Latency Credit<sup>3</sup> – The Service Level Commitment measurement will be based on a specific calendar month's performance. The credit will apply for each BellSouth Metro Ethernet Service Connection that does not meet the latency Commitment for any eligible CoS. The SLA credit will apply to the monthly recurring charges for all the rate elements<sup>2</sup> associated with the affected Metro Ethernet Connection.
- (d) BellSouth Metro Ethernet Service Jitter Credit<sup>3</sup> – The Service Level Commitment measurement will be based on a specific calendar month's performance. The credit will apply for each BellSouth Metro Ethernet Service Connection that does not meet the jitter Commitment for any eligible CoS. The SLA credit will apply to the monthly recurring charges for all the rate elements<sup>2</sup> associated with the affected Metro Ethernet Connection.
- (e) BellSouth Metro Ethernet Service Packet Delivery Credit<sup>3</sup> – The Service Level Commitment measurement will be based on a specific calendar month's performance. The credit will apply for each BellSouth Metro Ethernet Service Connection that does not meet the packet delivery commitment for any eligible CoS. The SLA credit will apply to the monthly recurring charges for all the rate elements<sup>2</sup> associated with the affected Metro Ethernet Connection.

**Note 1:** Details of the technical measurements and performance results methodologies for each commitment are provided in BellSouth Technical Reference TR-73632.

**Note 2:** Specifically, rate elements for the Metro Ethernet Connection, Additional Mileage and Features.

**Note 3:** BellSouth Metro Ethernet networks that do not span more than one switch in the core network are not eligible for credits under this SLA.

**Note 4:** Effective on or after August 22, 2021, this Service will no longer be available for purchase by new or existing customers. In addition, requests to move, add, change, or renew existing service arrangements will not be accepted. Following the expiration of a customer's existing term agreement, service will be provided on a month-to-month basis at the applicable Monthly rates until the service is discontinued. The Company currently plans to discontinue this service on or after March 31, 2023.

(N)  
|  
(N)

## E7. DEDICATED ACCESS SERVICES

### E7.5 Rates and Charges

#### E7.5.1 Reserved for Future Use

#### E7.5.2 Telegraph Grade (a.k.a. BellSouth® SPA Telegraph) Service<sup>1, 2</sup>

(C)

##### A. Local Channel

##### 1. Per Point of Termination

		Monthly Rate	Nonrecurring Charge		USOC
			First	Additional	
(a)	Two-Wire	\$29.04	\$-	\$-	T6E2X
(b)	Four-Wire	58.08	-	-	T6E4X

##### B. Interoffice Channel

##### 1. Mileage Bands

		Fixed Monthly Charge	Monthly Charge Per Mile	Nonrecurring Charge Per Channel	USOC
(a)	0 mile	\$-	\$-	\$-	1L5XX
(b)	1 thru 8 miles	47.03	2.73	-	1L5XX
(c)	9 thru 25 miles	47.03	2.64	-	1L5XX
(d)	Over 25 miles	47.03	2.56	-	1L5XX

##### C. Optional Features and Functions

##### 1. Telegraph Bridging, Two-Wire and Four-Wire

		Monthly Rate	Nonrecurring Charge	USOC
(a)	Two-Wire, per port	\$2.64	\$-	BCNT2
(b)	Four-Wire, per port	2.64	-	BCNT4

**Note 1:** Telegraph Grade (a.k.a. BellSouth® SPA Telegraph) service is not available for additions, new installations or moves of service.

**Note 2:** Effective June 30, 2021, this Service will no longer be available for purchase by new or existing customers. In addition, requests to move, add, change, or renew existing service arrangements will not be accepted. Following the expiration of a customer's existing term agreement, service will be provided on a month-to-month basis at the applicable Monthly rates until the service is discontinued. The Company currently plans to discontinue this service on or after June 30, 2024.

(N)

(N)

**E7. DEDICATED ACCESS SERVICES**

**E7.5 Rates and Charges (Cont'd)**

**E7.5.3 Voice Grade<sup>2</sup> (a.k.a. BellSouth<sup>®</sup> SPA DS0 VG) Service**

(C)

**A. Local Channel**

1. Per Point of Termination

a. Voice Grade (a.k.a. BellSouth<sup>®</sup> SPA DS0 VG)

(1) Voice

		Monthly Rate	Nonrecurring Charge		USOC
			First	Additional	
(a)	Two-Wire	<i>\$49.50</i>	<i>\$297.00</i>	<i>\$110.00</i>	<b>T6E2X</b>
(b)	Four-Wire	<i>74.25</i>	<i>302.50</i>	<i>115.50</i>	<b>T6E4X</b>
(2)	Data				
(a)	Two-Wire	<i>57.75</i>	<i>324.50</i>	<i>132.00</i>	<b>T6E2X</b>
(b)	Four-Wire	<i>74.25</i>	<i>330.00</i>	<i>137.50</i>	<b>T6E4X</b>
(3)	Loop Facilities not required <sup>1</sup>				
(a)	Two-Wire	<i>11.55</i>	<i>148.50</i>	<i>78.10</i>	<b>EUC2N</b>
(b)	Four-Wire	<i>11.55</i>	<i>148.50</i>	<i>78.10</i>	<b>EUC4N</b>

**B. Interoffice Channel**

1. Mileage Bands

	Fixed Monthly Charge	Monthly Charge Per Mile	Nonrecurring Charge Per Channel	USOC	
					(a)
(b)	1 thru 8 miles	<i>57.75</i>	<i>3.22</i>	<i>95.70</i>	<b>1L5XX</b>
(c)	9 thru 25 miles	<i>57.75</i>	<i>3.22</i>	<i>95.70</i>	<b>1L5XX</b>
(d)	Over 25 miles	<i>57.75</i>	<i>3.22</i>	<i>95.70</i>	<b>1L5XX</b>

**Note 1:** For connections to Company Centrex CO-like switches and equipment considered to be customer premises.

**Note 2:** Effective June 30, 2021, this Service will no longer be available for purchase by new or existing customers. In addition, requests to move, add, change, or renew existing service arrangements will not be accepted. Following the expiration of a customer's existing term agreement, service will be provided on a month-to-month basis at the applicable Monthly rates until the service is discontinued. The Company currently plans to discontinue this service on or after June 30, 2024.

(N)  
 |  
 (N)

## E7. DEDICATED ACCESS SERVICES

### E7.5 Rates and Charges (Cont'd)

#### E7.5.3 Voice Grade<sup>1</sup> (a.k.a. BellSouth<sup>®</sup> SPA DS0 VG) Service (Cont'd)

(C)

##### C. Optional Features and Functions

##### 1. Bridging

##### a. Voice Bridging, Two-Wire/Four-Wire

##### (1) Per port

	<b>Monthly Rate</b>	<b>Nonrecurring Charge</b>	<b>USOC</b>
(a) Two-Wire	<i>\$11.55</i>	<i>\$37.40</i>	<b>BCNV2</b>
(b) Four-Wire	<i>11.55</i>	<i>37.40</i>	<b>BCNV4</b>
b. Data Bridging, Two-Wire/Four-Wire			
(1) Per port			
(a) Two-Wire	<i>16.50</i>	<i>40.70</i>	<b>BCND2</b>
(b) Four-Wire	<i>16.50</i>	<i>40.70</i>	<b>BCND4</b>
c. Telephoto Bridging, Two-Wire/Four-Wire			
(1) Per port			
(a) Two-Wire	<i>11.55</i>	<i>37.40</i>	<b>BCNF2</b>
(b) Four-Wire	<i>11.55</i>	<i>37.40</i>	<b>BCNF4</b>
d. Dataphone <sup>®</sup> Select-A-Station Bridging - Primary Data Station Selector			
(1) Sequential Arrangement			
(a) Common Equipment	<i>188.93</i>	<i>264.00</i>	<b>DXNPS</b>
(2) Addressable Arrangement			
(a) Common Equipment	<i>266.64</i>	<i>297.00</i>	<b>DXNPA</b>
(3) Channel Connections			
(a) Per two-wire connection	<i>3.63</i>	<i>40.70</i>	<b>DXNP2</b>
(b) Per four-wire connection	<i>16.67</i>	<i>44.00</i>	<b>DXNP4</b>
e. Dataphone <sup>®</sup> Select-A-Station Bridging - Secondary Data Station Selector			
(1) Sequential Arrangement			
(a) Common Equipment	<i>188.93</i>	<i>264.00</i>	<b>DXNSS</b>

Note 1: Effective June 30, 2021, this Service will no longer be available for purchase by new or existing customers. In addition, requests to move, add, change, or renew existing service arrangements will not be accepted. Following the expiration of a customer's existing term agreement, service will be provided on a month-to-month basis at the applicable Monthly rates until the service is discontinued. The Company currently plans to discontinue this service on or after June 30, 2024.

(N)  
 |  
 (N)

## E7. DEDICATED ACCESS SERVICES

### E7.5 Rates and Charges (Cont'd)

#### E7.5.3 Voice Grade<sup>1</sup> (A.K.A. BellSouth<sup>®</sup> SPA DS0 VG) Service (Cont'd)

(C)

##### C. Optional Features and Functions (Cont'd)

##### 1. Bridging (Cont'd)

##### e. Dataphone<sup>®</sup> Select-A-Station Bridging - Secondary Data Station Selector (Cont'd)

##### (2) Addressable Arrangement

	<b>Monthly Rate</b>	<b>Nonrecurring Charge</b>	<b>USOC</b>
(a) Common Equipment	<i>\$266.64</i>	<i>\$297.00</i>	<b>DXNSA</b>
(3) Channel Connections			
(a) Per two-wire connection	<i>3.63</i>	<i>40.70</i>	<b>DXNS2</b>
(b) Per four-wire connection	<i>16.67</i>	<i>44.00</i>	<b>DXNS4</b>
f. Telemetry and Alarm Bridging - Split Band, Active Bridging			
(1) Common Equipment, per central office			
(a) First bridging shelf, capacity of 48 two-wire connections	<i>69.65</i>	<i>380.00</i>	<b>DXQC1</b>
(b) Additional bridging shelf, capacity of 56 two-wire connections installed subsequent to the first bridging shelf	<i>67.65</i>	<i>345.00</i>	<b>DXQC2</b>
(c) Additional bridging shelf, capacity of 56 two-wire connections installed at the same time as the first bridging shelf	<i>23.25</i>	<i>215.00</i>	<b>XW8</b>
(2) Channel connections, per channel connected			
(a) Remote station channel connection	<i>1.40</i>	<i>37.00</i>	<b>DXQRX</b>
(b) Mid-link channel connection, first channel	<i>5.60</i>	<i>49.00</i>	<b>DXQM1</b>
(c) Mid-link channel connection, subsequent channels	<i>4.85</i>	<i>49.00</i>	<b>DXQMS</b>

Note 1: Effective June 30, 2021, this Service will no longer be available for purchase by new or existing customers. In addition, requests to move, add, change, or renew existing service arrangements will not be accepted. Following the expiration of a customer's existing term agreement, service will be provided on a month-to-month basis at the applicable Monthly rates until the service is discontinued. The Company currently plans to discontinue this service on or after June 30, 2024.

(N)  
 |  
 (N)

**E7. DEDICATED ACCESS SERVICES**

**E7.5 Rates and Charges (Cont'd)**

**E7.5.3 Voice Grade<sup>3</sup> (a.k.a. BellSouth<sup>®</sup> SPA DS0 VG) Service (Cont'd)**

(C)

C. Optional Features and Functions (Cont'd)

2. Conditioning, Per Point of Termination

		Monthly	Nonrecurring Charge		
		Rate	Initial	Subsequent	
(a)	C-Type	<i>\$1.65</i>	<i>\$17.60</i>	<i>\$94.60</i>	<b>USOC X1CPT</b>
(b)	Improved Attenuation Distortion	<i>139.02</i>	<i>85.80</i>	<i>176.00</i>	<b>UHW</b>
(c)	Improved Envelope Delay Distortion	<i>193.53</i>	<i>85.80</i>	<i>176.00</i>	<b>UHY</b>
(d)	Sealing Current	<i>.58</i>	<i>37.40</i>	<i>104.50</i>	<b>1HBPT</b>
3.	Echo Control for Effective Two-Wire Service Per Point of Termination				
(a)	Improved Return Loss At the Two-Wire Point of Termination	<i>25.00</i>	<i>7.70</i>	<i>308.00</i>	<b>1RL2W</b>
(b)	ELEPL2 At the Four-Wire Point of Termination	<i>25.00</i>	<i>7.70</i>	<i>308.00</i>	<b>UHZ</b>
4.	Customer Specified Receive Level				
(a)	Per two-wire Point of Termination	<i>27.48</i>	<i>4.40</i>	<i>79.20</i>	<b>RLS</b>
5.	D-Conditioning				
(a)	Per Point of Termination	<i>.50</i>	<i>11.00</i>	<i>341.00</i>	<b>XDCPT</b>
6.	Telephoto Capability				
(a)	Per Point of Termination	<i>3.63</i>	<i>4.40</i>	<i>302.50</i>	<b>XTCPT</b>
7.	Signaling Capability, per Point of Termination				
(a)	Loop <sup>1</sup>	<i>4.87</i>	<i>17.60</i>	<i>319.00</i>	<b>XSS++</b>
(b)	Single Frequency	<i>9.49</i>	<i>25.30</i>	<i>324.50</i>	<b>XSSSF</b>
(c)	E&M <sup>2</sup>	<i>15.68</i>	<i>27.50</i>	<i>330.00</i>	<b>XSS++</b>

**Note 1:** In lieu of ++ substitute LO or LS as appropriate.

**Note 2:** In lieu of ++ substitute EA, EB, EC, or CT as appropriate.

**Note 3:** Effective June 30, 2021, this Service will no longer be available for purchase by new or existing customers. In addition, requests to move, add, change, or renew existing service arrangements will not be accepted. Following the expiration of a customer's existing term agreement, service will be provided on a month-to-month basis at the applicable Monthly rates until the service is discontinued. The Company currently plans to discontinue this service on or after June 30, 2024.

(N)

(N)



## E7. DEDICATED ACCESS SERVICES

### E7.5 Rates and Charges (Cont'd)

#### E7.5.3 Voice Grade<sup>4</sup> (a.k.a. BellSouth<sup>®</sup> SPA DS0 VG) Service (Cont'd)

(C)

##### C. Optional Features and Functions (Cont'd)

##### 7. Signaling Capability, per Point of Termination

	Monthly Rate	Nonrecurring Charge		USOC
		Initial	Subsequent	
(d) Ground <sup>1</sup>	\$3.96	\$12.10	\$313.50	XSS++
(e) Type C	3.96	17.60	319.00	XSSLC
(f) Other <sup>2</sup>	9.49	20.90	324.50	XSS++
8. Improved Termination				
(a) Per Point of Termination	3.63	4.40	308.00	UGD
9. Simplex Reversal				
(a) Per Point of Termination	-	4.40	95.70	UGJ

#### E7.5.4 Reserved For Future Use

#### E7.5.5 Digital Data Access (a.k.a. BellSouth<sup>®</sup> SPA DS0 Digital Data) Service<sup>3, 4</sup>

(C)

##### A. Local Channel

##### 1. Per Point of Termination

	Monthly Rate	Nonrecurring Charge		USOC
		First	Additional	
(a) 2.4 Kbps	\$55.00	\$350.00	\$99.00	T6ECS
(b) 4.8 Kbps	55.00	350.00	99.00	T6ECS
(c) 9.6 Kbps	55.00	350.00	99.00	T6ECS

**Note 1:** In lieu of ++ substitute GO or GS as appropriate.

**Note 2:** In lieu of ++ substitute LA, LB, LR, RV, DX, DY, EX, AB or AC as appropriate.

**Note 3:** Rates and charges for BellSouth.

**Note 4:** Effective June 30, 2021, this Service will no longer be available for purchase by new or existing customers. In addition, requests to move, add, change, or renew existing service arrangements will not be accepted. Following the expiration of a customer's existing term agreement, service will be provided on a month-to-month basis at the applicable Monthly rates until the service is discontinued. The Company currently plans to discontinue this service on or after June 30, 2024.

(N)

(N)

## E7. DEDICATED ACCESS SERVICES

### E7.5 Rates and Charges (Cont'd)

#### E7.5.5 Digital Data Access (a.k.a. BellSouth SPA DS0 Digital Data) Service<sup>1,3</sup> (Cont'd)

(C)

A. Local Channel (Cont'd)

1. Per Point of Termination (Cont'd)

	Monthly Rate	Nonrecurring Charge		USOC
		First	Additional	
(d) 19.2 Kbps	\$55.00	\$350.00	\$99.00	T6ECS
(e) 56.0 Kbps	75.00	350.00	99.00	T6ECS
(f) 64.0 Kbps	75.00	350.00	99.00	T6ECS
2. Hub Termination, Per Local Channel				
(a) 2.4 Kbps	11.00	57.00	48.00	TUTA4
(b) 4.8 Kbps	11.00	57.00	48.00	TUTB4
(c) 9.6 Kbps	11.00	57.00	48.00	TUTC4
(d) 19.2 Kbps	11.00	57.00	48.00	TUTE4
(e) 56.0 Kbps	30.00	57.00	48.00	TUTD4
(f) 64.0 Kbps	30.00	57.00	48.00	TUTF4

3. Local Channel Contract Rates Per Point of Termination

	Nonrecurring Charge First	Add'l	24 to	43 to	USOC
			42	60	
			Months <sup>2</sup>	Months <sup>2</sup>	
(a) 2.4 Kbps	\$350.00	\$99.00	\$49.00	\$47.00	T6ECS
(b) 4.8 Kbps	350.00	99.00	49.00	47.00	T6ECS
(c) 9.6 Kbps	350.00	99.00	49.00	47.00	T6ECS
(d) 19.2 Kbps	350.00	99.00	49.00	47.00	T6ECS
(e) 56.0 Kbps	350.00	99.00	65.00	60.00	T6ECS
(f) 64.0 Kbps	350.00	99.00	65.00	60.00	T6ECS
4. Contract Rates for Hub Termination, Per Local Channel					
(a) 2.4 Kbps	57.00	48.00	9.75	9.50	TUTA4
(b) 4.8 Kbps	57.00	48.00	9.75	9.50	TUTB4
(c) 9.6 Kbps	57.00	48.00	9.75	9.50	TUTC4
(d) 19.2 Kbps	57.00	48.00	9.75	9.50	TUTE4
(e) 56.0 Kbps	57.00	48.00	28.00	26.00	TUTD4

**Note 1:** Rates and charges for BellSouth.

**Note 2:** Effective March 23, 2019, Customers may not convert, renew or establish CSPPs for Digital Data Access Service.

**Note 3:** Effective June 30, 2021, this Service will no longer be available for purchase by new or existing customers. In addition, requests to move, add, change, or renew existing service arrangements will not be accepted. Following the expiration of a customer's existing term agreement, service will be provided on a month-to-month basis at the applicable Monthly rates until the service is discontinued. The Company currently plans to discontinue this service on or after June 30, 2024.

(N)  
 |  
 (N)

**E7. DEDICATED ACCESS SERVICES**

**E7.5 Rates and Charges (Cont'd)**

**E7.5.5 Digital Data Access (a.k.a. BellSouth SPA DS0 Digital Data) Service<sup>1,3</sup> (Cont'd)**

(C)

A. Local Channel (Cont'd)

4. Contract Rates for Hub Termination, Per Local Channel (Cont'd)

Nonrecurring Charge		24 to 42 Months <sup>2</sup>	43 to 60 Months <sup>2</sup>	USOC
First	Add'l			
\$57.00	\$48.00	\$28.00	\$26.00	TUTF4

B. Interoffice Channel

1. 2.4 Kbps

**Mileage Bands**

- (a) 0 mile
- (b) 1 thru 8 miles
- (c) 9 thru 25 miles
- (d) Over 25 miles

Fixed Monthly Rate	Monthly Rate Per Mile	Nonrecurring Charge Per Channel	USOC
\$-	\$-	\$-	1L5XX
20.00	2.05	36.00	1L5XX
20.00	2.00	36.00	1L5XX
20.00	1.95	36.00	1L5XX

2. 4.8 Kbps

**Mileage Bands**

- (a) 0 mile
- (b) 1 thru 8 miles
- (c) 9 thru 25 miles
- (d) Over 25 miles

-	-	-	1L5XX
20.00	2.05	36.00	1L5XX
20.00	2.00	36.00	1L5XX
20.00	1.95	36.00	1L5XX

3. 9.6 Kbps

**Mileage Bands**

- (a) 0 mile
- (b) 1 thru 8 miles

-	-	-	1L5XX
20.00	2.05	36.00	1L5XX

**Note 1:** Rates and charges for BellSouth.

**Note 2:** Effective March 23, 2019, Customers may not convert, renew or establish CSPPs for Digital Data Access Service.

**Note 3:** Effective June 30, 2021, this Service will no longer be available for purchase by new or existing customers. In addition, requests to move, add, change, or renew existing service arrangements will not be accepted. Following the expiration of a customer's existing term agreement, service will be provided on a month-to-month basis at the applicable Monthly rates until the service is discontinued. The Company currently plans to discontinue this service on or after June 30, 2024.

(N)  
 |  
 (N)

**E7. DEDICATED ACCESS SERVICES**

**E7.5 Rates and Charges (Cont'd)**

**E7.5.5 Digital Data Access (a.k.a. BellSouth SPA DS0 Digital Data) Service<sup>1,2</sup> (Cont'd)**

(C)(T)

**B. Interoffice Channel (Cont'd)**

3. 9.6 Kbps (Cont'd)

		Fixed Monthly Rate	Monthly Rate Per Mile	Nonrecurring Charge Per Channel	USOC
(c)	9 thru 25 miles	\$20.00	\$2.00	\$36.00	1L5XX
(d)	Over 25 miles	20.00	1.95	36.00	1L5XX

4. 19.2 Kbps

**Mileage Bands**

(a)	0 mile	-	-	-	1L5XX
(b)	1 thru 8 miles	20.00	2.05	36.00	1L5XX
(c)	9 thru 25 miles	20.00	2.00	36.00	1L5XX
(d)	Over 25 miles	20.00	1.95	36.00	1L5XX

5. 56 Kbps

**Mileage Bands**

(a)	0 mile	-	-	-	1L5XX
(b)	1 thru 8 miles	40.00	4.10	36.00	1L5XX
(c)	9 thru 25 miles	40.00	4.00	36.00	1L5XX
(d)	Over 25 miles	40.00	3.90	36.00	1L5XX

6. 64 Kbps

**Mileage Bands**

(a)	0 mile	-	-	-	1L5XX
(b)	1 thru 8 miles	40.00	4.10	36.00	1L5XX
(c)	9 thru 25 miles	40.00	4.00	36.00	1L5XX
(d)	Over 25 miles	40.00	3.90	36.00	1L5XX

**Note 1:** Rates and charges for BellSouth.

**Note 2:** Effective June 30, 2021, this Service will no longer be available for purchase by new or existing customers. In addition, requests to move, add, change, or renew existing service arrangements will not be accepted. Following the expiration of a customer's existing term agreement, service will be provided on a month-to-month basis at the applicable Monthly rates until the service is discontinued. The Company currently plans to discontinue this service on or after June 30, 2024.

(N)  
 |  
 (N)

**E7. DEDICATED ACCESS SERVICES**

**E7.5 Rates and Charges (Cont'd)**

**E7.5.5 Digital Data Access (a.k.a. BellSouth SPA DS0 Digital Data) Service<sup>1, 5</sup> (Cont'd)**

(C)

**B. Interoffice Channel (Cont'd)**

7. 2.4, 4.8, 9.6 and 19.2 Kbps (Contract Rates)

**Mileage Bands**

	Nonrecurring Charge Per Channel	Fixed Monthly Rate		Monthly Rate Per Mile		USOC
		24 to 42 Months <sup>4</sup>	43 to 60 Months <sup>4</sup>	24 to 42 Months <sup>4</sup>	43 to 60 Months <sup>4</sup>	
(a) 0 mile	\$-	\$-	\$-	\$-	\$-	1L5XX
(b) 1 thru 8 miles	36.00	19.50	19.00	1.90	1.75	1L5XX
(c) 9 thru 25 miles	36.00	19.50	19.00	1.85	1.70	1L5XX
(d) Over 25 miles	36.00	19.50	19.00	1.80	1.65	1L5XX

8. 56.0 and 64.0 Kbps (Contract Rates)

**Mileage Bands**

(a) 0 mile	-	-	-	-	-	1L5XX
(b) 1 thru 8 miles	36.00	36.00	34.00	3.80	3.50	1L5XX
(c) 9 thru 25 miles	36.00	36.00	34.00	3.70	3.40	1L5XX
(d) Over 25 miles	36.00	36.00	34.00	3.60	3.30	1L5XX

**C. Optional Features and Functions**

1. Bridging<sup>2,3</sup>

	Rate	Monthly Nonrecurring Charge	USOC
(a) Per port (2.4, 4.8, 9.6, 19.2, 56.0 Kbps)	\$15.00	\$20.00	BCNDA

2. Digital Data Secondary Channel Capability, per Local Channel<sup>2,3</sup>

	Monthly Rate	Nonrecurring Charge	USOC
(a) Each	\$15.00	Initial \$- Subsequent \$235.00	SFS

**Note 1:** Rates and charges for BellSouth.

**Note 2:** Not available at all service locations.

**Note 3:** This option is not available with 64.0 Kbps.

**Note 4:** Effective March 23, 2019, Customers may not convert, renew or establish CSPPs for Digital Data Access Service.

**Note 5:** Effective June 30, 2021, this Service will no longer be available for purchase by new or existing customers. In addition, requests to move, add, change, or renew existing service arrangements will not be accepted. Following the expiration of a customer's existing term agreement, service will be provided on a month-to-month basis at the applicable Monthly rates until the service is discontinued. The Company currently plans to discontinue this service on or after June 30, 2024.

(N)  
 |  
 (N)

**E7. DEDICATED ACCESS SERVICES**

**E7.5 Rates and Charges (Cont'd)**

**E7.5.5 Digital Data Access (a.k.a. BellSouth SPA DS0 Digital Data) Service<sup>1,5</sup> (Cont'd)**

(C)

C. Optional Features and Functions (Cont'd)

3. Contract Rates For Bridging<sup>2,3</sup>

		<b>Nonrecurring</b>	<b>24 to</b>	<b>43 to</b>	
		<b>Charge</b>	<b>42</b>	<b>60</b>	
	(a) Per port (2.4, 4.8, 9.6, 19.2, 56.0 Kbps)	<b>\$20.00</b>	<b>Months<sup>4</sup></b>	<b>Months<sup>4</sup></b>	<b>USOC</b>
4.	Contract Rates for Digital Data Secondary Channel, per Local Channel <sup>2,3</sup>		<b>\$13.00</b>	<b>\$12.00</b>	<b>BCNDA</b>

		<b>Nonrecurring</b>	<b>24 to</b>	<b>43 to</b>	
		<b>Charge</b>	<b>42</b>	<b>60</b>	
	(a) Each	<b>Initial</b>	<b>Months<sup>4</sup></b>	<b>Months<sup>4</sup></b>	<b>USOC</b>
		<b>\$-</b>	<b>\$14.00</b>	<b>\$13.00</b>	<b>SFS</b>
		<b>Subsequent</b>			
		<b>\$235.00</b>			

**Note 1:** Rates and charges for BellSouth..

**Note 2:** Not available at all service locations.

**Note 3:** This option is not available with 64.0 Kbps.

**Note 4:** Effective March 23, 2019, Customers may not convert, renew or establish CSPPs for Digital Data Access Service.

**Note 5:** Effective June 30, 2021, this Service will no longer be available for purchase by new or existing customers. In addition, requests to move, add, change, or renew existing service arrangements will not be accepted. Following the expiration of a customer's existing term agreement, service will be provided on a month-to-month basis at the applicable Monthly rates until the service is discontinued. The Company currently plans to discontinue this service on or after June 30, 2024.

(N)  
 |  
 (N)

## E7. DEDICATED ACCESS SERVICES

### E7.5 Rates and Charges (Cont'd)

#### E7.5.6 High Capacity (a.k.a. BellSouth SPA High Capacity) Service

##### A. Local Channel

##### 1. Per Point of Termination

		Monthly Rate			Nonrecurring Charge		USOC
		Rate Zone 1	Rate Zone 2	Rate Zone 3	First	Additional	
(a)	1.544 Mbps	\$145.00	\$145.00	\$145.00	\$745.00	\$335.00	TMECS
(b)	3.152 Mbps <sup>1</sup>	-	-	-	-	-	1XA++
(c)	6.312 Mbps <sup>1</sup>	-	-	-	-	-	1X6++
(d)	44.736 Mbps <sup>1</sup>	-	-	-	-	-	1X8++

##### 2. 1.544 Mbps Contract Rates

		Nonrecurring Charge			USOC
		First	Additional		
(a)	Per Point of Termination <sup>2</sup>	\$745.00	\$335.00		-
		Monthly Rate			USOC
		24 to 48 Months <sup>3, 4, 5</sup>	49 to 72 Months <sup>3, 4</sup>	73 to 96 Months <sup>3, 4</sup>	
(b)	Rate Zone 1	\$138.00	\$136.00	\$134.00	TMECS
(c)	Rate Zone 2	138.00	136.00	134.00	TMECS
(d)	Rate Zone 3	138.00	136.00	134.00	TMECS

**Note 1:** ICB rates and charges apply.

**Note 2:** Contract lengths are flexible to allow customer choice of payment period per E2.4.9.

**Note 3:** Effective March 23, 2019, Customers may not: (1) Establish CSPPs greater than 36 months for High Capacity Service, and (2) Convert or renew CSPPs for High Capacity Service.

**Note 4:** Effective November 1, 2022, customers may not establish new term plans of greater than 24 months for High Capacity Service Channel Service Payment Plans.

**Note 5:** Effective March 17, 2024, customers may not establish new term plans of greater than month-to-month for High Capacity Service Channel Service Payment Plans.

(N)

**E7. DEDICATED ACCESS SERVICES**

**E7.5 Rates and Charges (Cont'd)**

**E7.5.6 High Capacity (a.k.a. BellSouth SPA High Capacity) Service (Cont'd)**

**B. Interoffice Channel**

1. 1.544 Mbps

**Mileage Bands**

	Fixed Monthly			Monthly Rate			Nonrecurring Charge	USOC
	Rate			Per Mile				
	Rate	Rate	Rate	Rate	Rate	Rate		
	<b>Zone 1</b>	<b>Zone 2</b>	<b>Zone 3</b>	<b>Zone 1</b>	<b>Zone 2</b>	<b>Zone 3</b>	<b>Per Channel</b>	
(a) 0 mile	\$-	\$-	\$-	\$-	\$-	\$-	\$-	1L5XX
(b) 1 thru 8 miles	64.35	64.35	64.35	26.00	26.00	26.00	200.00	1L5XX
(c) 9 thru 25 miles	64.35	64.35	64.35	25.00	25.00	25.00	200.00	1L5XX
(d) Over 25 miles	64.35	64.35	64.35	24.00	24.00	24.00	200.00	1L5XX

2. 1.544 Mbps

**Mileage Bands**

- a. Contract Rates<sup>1</sup>

- (1) Per Channel, 0 Mile

	Nonrecurring Charge	Fixed				USOC
		Monthly Charge	24 to 48 Months <sup>2,3,4</sup>	49 to 72 Months <sup>2,3</sup>	73 to 96 Months <sup>2,3</sup>	
(a) Rate Zone 1	\$-	\$-	\$-	\$-	1L5XX	
(b) Rate Zone 2	200.00	59.75	-	-	1L5XX	
(c) Rate Zone 3	200.00	59.75	-	-	1L5XX	
(2) Per Channel, 1 thru 8 miles						
(a) Rate Zone 1	200.00	59.75	20.00	18.00	16.00	1L5XX
(b) Rate Zone 2	200.00	59.75	20.00	18.00	16.00	1L5XX
(c) Rate Zone 3	200.00	59.75	20.00	18.00	16.00	1L5XX
(3) Per Channel, 9 thru 25 miles						
(a) Rate Zone 1	200.00	59.75	19.00	17.00	15.00	1L5XX
(b) Rate Zone 2	200.00	59.75	19.00	17.00	15.00	1L5XX
(c) Rate Zone 3	200.00	59.75	19.00	17.00	15.00	1L5XX
(4) Per Channel, Over 25 Miles						
(a) Rate Zone 1	200.00	59.75	18.00	16.00	14.00	1L5XX
(b) Rate Zone 2	200.00	59.75	18.00	16.00	14.00	1L5XX
(c) Rate Zone 3	200.00	59.75	18.00	16.00	14.00	1L5XX

**Note 1:** Contract lengths are flexible to allow customer choice of payment period per E2.4.9.

**Note 2:** Effective March 23, 2019, Customers may not: (1) Establish CSPPs greater than 36 months for High Capacity Service, and (2) Convert or renew CSPPs for High Capacity Service.

**Note 3:** Effective November 1, 2022, customers may not establish new term plans of greater than 24 months for High Capacity Service Channel Service Payment Plans.

**Note 4:** Effective March 17, 2024, customers may not establish new term plans of greater than month-to-month for High Capacity Service Channel Service Payment Plans.

(N)



FLORIDA  
ISSUED: November 16, 2001  
BY: Joseph P. Lacher, President -FL  
Miami, Florida

EFFECTIVE: December 17, 2001

**E7. DEDICATED ACCESS SERVICES**

**E7.5 Rates and Charges (Cont'd)**

**E7.5.6 High Capacity (a.k.a. BellSouth SPA High Capacity) Service (Cont'd)**

**B. Interoffice Channel (Cont'd)**

3. 3.152 Mbps<sup>1</sup> (M)(T)  
Mileage Bands (M)

	Fixed Monthly Rate	Monthly Rate Per Mile	Nonrecurring Charge Per Channel	USOC	
(a) 0 mile	\$-	\$-	\$-	1L5XX	(M)
(b) 1 thru 8 miles	-	-	-	1L5XX	(M)
(c) 9 thru 25 miles	-	-	-	1L5XX	(M)
(d) Over 25 miles	-	-	-	1L5XX	(M)

4. 6.312 Mbps<sup>1</sup>  
Mileage Bands

	Fixed Monthly Rate	Monthly Rate Per Mile	Nonrecurring Charge Per Channel	USOC	
(a) 0 mile	\$-	\$-	\$-	1L5XX	
(b) 1 thru 8 miles	-	-	-	1L5XX	
(c) 9 thru 25 miles	-	-	-	1L5XX	
(d) Over 25 miles	-	-	-	1L5XX	

5. 44.736 Mbps<sup>1</sup>  
Mileage Bands
- |                     |   |   |   |       |  |
|---------------------|---|---|---|-------|--|
| (a) 0 mile          | - | - | - | 1L5XX |  |
| (b) 1 thru 8 miles  | - | - | - | 1L5XX |  |
| (c) 9 thru 25 miles | - | - | - | 1L5XX |  |
| (d) Over 25 miles   | - | - | - | 1L5XX |  |

(M)

**Note 1:** ICB rates and charges apply.

**E7. DEDICATED ACCESS SERVICES**

**E7.5 Rates and Charges (Cont'd)**

**E7.5.6 High Capacity (a.k.a. BellSouth SPA High Capacity) Service (Cont'd)**

C. Optional Features and Functions

1. Channelization

a. DS3 Channelization

(1) DS3 to DS1

(a) Per arrangement<sup>1</sup>

b. DS2 Channelization

(1) DS2 to DS1

(a) Per arrangement<sup>1</sup>

c. DS1C Channelization

(1) DS1C to DS1

(a) Per arrangement<sup>2</sup>

d. DS1 Channelization

(1) DS1 Basic Channelization System (DS1 to VG/DS0)

(a) Per System

e. DS0 Channelization<sup>4</sup>

(1) DS0 Basic Channelization System (DS0 to Subrate)  
 (Per System)

(a) Maximum of 20, 2.4 Kbps services  
 (b) Maximum of 10, 4.8 Kbps services  
 (c) Maximum of 5, 9.6 Kbps services

2. Channel Interfaces (Per Interface)

a. Sub-DS3 Interfaces

(1) DS1 Level Central Office Channel Interface<sup>1</sup>

(a) Asynchronous  
 (b) Synchronous

(2) DS1 Level Customer Channel Interface<sup>1</sup>

(a) Asynchronous  
 (b) Synchronous

**Monthly Nonrecurring**

Rate	Charge	USOC
\$-	\$-	MXB++

-	-	MXD++
---	---	-------

-	-	MXH++
---	---	-------

**Monthly Rate**

Rate	Rate	Rate	Nonrecurring	USOC
Zone 1	Zone 2	Zone 3	Charge	
\$210.00	\$210.00	\$210.00	\$135.00	MQ1

**Monthly Nonrecurring**

Rate	Charge	USOC
\$120.00	\$135.00	QSU24
120.00	135.00	QSU48
120.00	135.00	QSU96

(C)

Nonrecurring	Month To	24 to 48	49 to 72	73 to 96	USOC
Charge	Month	Months <sup>3,4,5,6</sup>	Months <sup>3,4</sup>	Months <sup>3,4</sup>	
\$155.00	\$12.00	\$8.00	\$7.00	\$6.00	1D3CA
130.00	36.00	31.00	28.00	25.00	1D3CS
295.00	17.00	13.00	13.00	13.00	1D3DA
245.00	45.00	36.00	33.00	30.00	1D3DS

**Note 1:** Contract rates are flexible to allow customer choice of payment period per E2.4.9

**Note 2:** An additional Local Channel charge will apply whenever the spare line is provided as a leg to the customer premises. This feature may not be available with lines utilizing the Clear Channel Capability line code (B8ZS).

**Note 3:** Effective March 23, 2019, Customers may not: (1) Establish CSPPs greater than 36 months for High Capacity Service, and (2) Convert or renew CSPPs for High Capacity Service.

**Note 4:** Effective June 30, 2021, this Service will no longer be available for purchase by new or existing customers. In addition, requests to move, add, change, or renew existing service arrangements will not be accepted. Following the expiration of a customer's existing term agreement, service will be provided on a month-to-month basis at the applicable Monthly rates until the service is discontinued. The Company currently plans to discontinue this service on or after June 30, 2024.

**Note 5:** Effective November 1, 2022, customers may not establish new term plans of greater than 24 months for High Capacity Service Channel Service Payment Plans.

**Note 6:** Effective March 17, 2024, customers may not establish new term plans of greater than month-to-month for High Capacity Service Channel Service Payment Plans.

(N)

## E7. DEDICATED ACCESS SERVICES

### E7.5 Rates and Charges (Cont'd)

#### E7.5.6 High Capacity (a.k.a. BellSouth® SPA High Capacity) Service (Cont'd)

C. Optional Features and Functions (Cont'd)

2. Channel Interfaces (Per Interface) (Cont'd)

b. Sub-DS1 Interfaces

(1) VG/DS0 Level Central Office Channel Interface<sup>1</sup>

	Nonrecurring Charge		Month to Month	USOC	
	First	Each Additional			
(a) BellSouth® SWA	\$ 0.00	\$ 0.00	\$ 0.00	1D1SW	
(b) Telegraph <sup>2</sup> (BellSouth® SPA Telegraph)	7.00	6.00	5.00	1D1TE	(C)
(c) Voice <sup>2</sup> (BellSouth® SPA DSO VG)	7.00	6.00	9.00	1D1VG	(C)
(d) DDAS <sup>2</sup> (BellSouth® SPA DSO Digital Data)	7.00	6.00	13.00	1D1DD	(C)
c. Sub-DS0 Interfaces <sup>2</sup> (C)					
(1) Subrate Central Office Channel Interface <sup>1</sup>					
(a) Subrate (2.4, 4.8, & 9.6 Kbps)	7.00	6.00	13.00	1DOSR	

4. Clear Channel Capability is furnished on a per DS1 service channel basis.

Per DS1/1.544 Mbps High Capacity Channel optioned as:

(a) Superframe Format (SF)	-	-	655.00	CCOSF
(b) Extended Superframe Format (ESF)	-	-	655.00	CCOEF

**Note 1:** Contract rates are flexible to allow customer choice of payment period per E2.4.9.

**Note 2:** Effective June 30, 2021, this Service will no longer be available for purchase by new or existing customers. In addition, requests to move, add, change, or renew existing service arrangements will not be accepted. Following the expiration of a customer's existing term agreement, service will be provided on a month-to-month basis at the applicable Monthly rates until the service is discontinued. The Company currently plans to discontinue this service on or after June 30, 2024.

(N)  
 |  
 (N)

BELLSOUTH  
TELECOMMUNICATIONS  
FLORIDA

ACCESS SERVICES TARIFF

Second Revised Page 65  
Cancels First Revised Page 65

ISSUED: June 21, 2012  
BY: Marshall M. Criser III, President -FL  
Miami, Florida

EFFECTIVE: June 22, 2012

## **E7. DEDICATED ACCESS SERVICES**

### **E7.5 Rates and Charges (Cont'd)**

(DELETE)

(D)

BELLSOUTH  
TELECOMMUNICATIONS  
FLORIDA

ACCESS SERVICES TARIFF

Second Revised Page 66  
Cancels First Revised Page 66

ISSUED: June 21, 2012  
BY: Marshall M. Criser III, President -FL  
Miami, Florida

EFFECTIVE: June 22, 2012

## **E7. DEDICATED ACCESS SERVICES**

### **E7.5 Rates and Charges (Cont'd)**

(DELETE)

(D)

BELLSOUTH  
TELECOMMUNICATIONS  
FLORIDA

ACCESS SERVICES TARIFF

Second Revised Page 67  
Cancels First Revised Page 67

ISSUED: June 21, 2012

EFFECTIVE: June 22, 2012

BY: Marshall M. Criser III, President -FL  
Miami, Florida

## **E7. DEDICATED ACCESS SERVICES**

### **E7.5 Rates and Charges (Cont'd)**

(DELETE)

(D)

ISSUED: June 21, 2012  
BY: Marshall M. Criser III, President -FL  
Miami, Florida

EFFECTIVE: June 22, 2012

## **E7. DEDICATED ACCESS SERVICES**

### **E7.5 Rates and Charges (Cont'd)**

**(DELETE)**

(D)

**E7.5.7 Reserved for Future Use**

(C)

(D)

## E7. DEDICATED ACCESS SERVICES

### E7.5 Rates and Charges (Cont'd)

#### E7.5.9 Reserved for Future Use

#### E7.5.10 Reserved for Future Use

#### E7.5.11 Reserved for Future Use

#### E7.5.12 Reconfiguration Charges

##### A. Rates and Charges

(1) Per Customer Request for Voice Grade <sup>1</sup> (a.k.a. BellSouth <sup>®</sup> SPA DS0 VG) reconfiguration			(C)
	<b>Nonrecurring</b>		
	<b>Charge</b>	<b>USOC</b>	
(a) Each	<b>\$33.00</b>	<b>PR1VM</b>	
(b) Per Voice Grade <sup>1</sup> (a.k.a. BellSouth <sup>®</sup> SPA DS0 VG) circuit reconfigured	<b>23.00</b>	<b>PR1VR</b>	(C)
(2) Per Customer Request for DDAS <sup>1</sup> (a.k.a. BellSouth <sup>®</sup> SPA DS0 Digital Data) reconfiguration			(C)
(a) Each	<b>33.00</b>	<b>PR1DM</b>	
(b) Per DDAS <sup>1</sup> (a.k.a. BellSouth <sup>®</sup> SPA DS0 Digital Data) circuit reconfigured	<b>23.00</b>	<b>PR1DR</b>	(C)
(3) Per Customer Request for DS1 reconfiguration			
(a) Each	<b>52.00</b>	<b>PR11M</b>	
(b) Per DS1 circuit reconfigured	<b>33.00</b>	<b>PR11R</b>	

#### E7.5.13 Transfer of Service

##### A. Transfer of Service

##### 1. Dedicated Access Circuits

(a) Per Billing Account Number	<b>50.00</b>	<b>NRBPA</b>	
(b) Per circuit	<b>6.00</b>	<b>NRBPC</b>	

#### E7.5.14 (DELETED)

Note 1: Effective June 30, 2021, this Service will no longer be available for purchase by new or existing customers. In addition, requests to move, add, change, or renew existing service arrangements will not be accepted. Following the expiration of a customer's existing term agreement, service will be provided on a month-to-month basis at the applicable Monthly rates until the service is discontinued. The Company currently plans to discontinue this service on or after June 30, 2024.

(N)  
 |  
 (N)



BELLSOUTH  
TELECOMMUNICATIONS, INC.  
FLORIDA

ISSUED: November 30, 2001

BY: Joseph P. Lacher, President -FL  
Miami, Florida

ACCESS SERVICES TARIFF

Third Revised Page 70  
Cancels Second Revised Page 70

EFFECTIVE: December 30, 2001

## **E7. DEDICATED ACCESS SERVICES**

### **E7.5 Rates and Charges (Cont'd)**

**E7.5.14 (DELETED)**

(D)

**E7. DEDICATED ACCESS SERVICES**

**E7.5 Rates and Charges (Cont'd)**

**E7.5.14 (DELETED)**

**E7.5.15 Derived Data Channel<sup>2</sup> (a.k.a. BellSouth SPA Derived Data Channel) Service**

(C)

**A. Local Channel**

1. Derived Data Channel (a.k.a. BellSouth SPA Derived Data Channel)

	<b>Nonrecurring Charge</b>	<b>Month to Month</b>	<b>24 to 42 Months<sup>1</sup></b>	<b>43 to 60 Months<sup>1</sup></b>	<b>USOC</b>
(a) Per channel at 2.4 Kbps	<b>\$460.00</b>	<b>\$17.00</b>	<b>\$13.50</b>	<b>\$11.00</b>	<b>DAXPC</b>
2. DS0-B Interface					
(a) Per group of twenty channels at 2.4 Kbps each	<b>330.00</b>	<b>70.00</b>	<b>65.00</b>	<b>62.00</b>	<b>DAXP1</b>

**B. Interoffice Channel**

1. Per group of twenty channels at 2.4 Kbps each

(a) Fixed	<b>95.00</b>	<b>25.00</b>	<b>23.00</b>	<b>22.00</b>	<b>DAXPF</b>
(b) Per mile	<b>-</b>	<b>2.05</b>	<b>1.90</b>	<b>1.75</b>	<b>DAXPM</b>

**Note 1:** Effective March 23, 2019, Customers may not convert, renew or establish CSPPs for Derived Data Channel Service.

**Note 2:** Effective June 30, 2021, this Service will no longer be available for purchase by new or existing customers. In addition, requests to move, add, change, or renew existing service arrangements will not be accepted. Following the expiration of a customer's existing term agreement, service will be provided on a month-to-month basis at the applicable Monthly rates until the service is discontinued. The Company currently plans to discontinue this service on or after June 30, 2024.

(N)  
 |  
 (N)

**E7. DEDICATED ACCESS SERVICES**

**E7.5 Rates and Charges (Cont'd)**

**E7.5.16 FlexServ Service (a.k.a. BellSouth SPA Customer Reconfiguration)**

**A. Basic FlexServ service (a.k.a. BellSouth SPA Customer Reconfiguration)**

**1. DS0 Channel Connections**

	Nonrecurring Charge	Month To Month	24 to 48 Months	49 to 72 Months	73 to 96 Months	USOC
(a) Voice Grade Type, per DS0 channel	\$35.00	\$14.90	\$13.70	\$12.70	\$11.90	DSLVA
(b) Digital Type, per DS0 channel	35.00	8.50	7.80	7.25	6.80	DSLDA

**2. DS1 Channel Connections**

(a) DS0 Switching, per DS1 channel	125.00	110.00	100.00	92.00	85.00	DSL1A
(b) DS1 Switching, per DS1 channel	125.00	65.00	60.00	55.00	52.00	DSL1B
(c) Surveillance - DS1 Level per DS1 channel	125.00	65.00	60.00	55.00	52.00	DSL1S (N)

**3. DS3 Channel Connections**

(a) Surveillance - DS1 Level, per DS3 channel	125.00	375.00	345.00	320.00	300.00	DSL3S (N)
(b) Surveillance - DS3 Level, per DS3 channel	125.00	150.00	138.00	128.00	120.00	DSL3T (N)

**B. FlexServ service (a.k.a. BellSouth SPA Customer Reconfiguration) Options**

**1. Multipoint Bridging**

(a) Voice Grade Connections, per bridging leg	20.00	5.00	4.50	4.40	4.30	FSSFMM
(b) Multipoint Junction Unit, per 2.4, 4.8, 9.6 or 56 Kbps channel <sup>1</sup>	15.00	6.00	5.25	5.00	4.75	FSSFJ
(c) Multipoint Junction Unit, per 19.2 Kbps channel <sup>1</sup>	15.00	9.45	8.90	8.40	7.90	FSSF9

**2. Subrate Reconfiguration Capability**

	Nonrecurring Charge	Month To Month	24 to 48 Months	49 to 72 Months	73 to 96 Months	USOC
(a) Per DS0 equipped (DS0B)	\$45.00					DSL5B
(b) 9.6 Kbps, per DS0A requires 5	\$5.00	\$8.75	\$8.15	\$7.60	\$7.20	DSL59
(c) 4.8 Kbps, per DS0A requires 10	5.00	7.40	6.80	6.30	5.95	DSL54

**Note 1:** Must purchase in units of five.

**E7. DEDICATED ACCESS SERVICES**

**E7.5 Rates and Charges (Cont'd)**

**E7.5.16 FlexServ Service (a.k.a. BellSouth SPA Customer Reconfiguration) (Cont'd)**

**B. FlexServ service (a.k.a. BellSouth SPA Customer Reconfiguration) Options (Cont'd)**

2. Subrate Reconfiguration Capability (Cont'd)

	Nonrecurring Charge	Month To Month	24 to 48 Months	49 to 72 Months	73 to 96 Months	USOC
(d) 2.4 Kbps, per DS0A requires 20	\$5.00	\$7.00	\$6.45	\$5.95	\$5.60	USOC DSLS2
3. Additional Concurrent User Access						
(a) Per Additional User Access	125.00	68.00	60.00	57.00	54.00	FSSFU
4. Additional User Identification Codes						
(a) Per Additional Code						Nonrecurring Charge \$3.00 USOC FSSFA
5. Additional Customer Training						
(a) Per eight hour day of training after initial installation				450.00		FSSFT
6. Reconfiguration by Company Personnel						
(a) Request for Company to perform reconfiguration activity				25.00		FSSRA

**E7.5.17 SMARTPath Service (a.k.a. BellSouth SPA Shared Ring)**

**A. SMARTPath service (a.k.a. BellSouth SPA Shared Ring) Area Connection**

1. 1.544 Mbps

	Nonrecurring Charge First	Nonrecurring Charge Add'l	Month to Month	Plan A 24 to 48 Months	Plan B 49 to 72 Months	USOC
(a) Per SMARTPath service (a.k.a. BellSouth SPA Shared Ring) Area Connection	\$430.00	\$140.00	\$420.00	\$295.00	\$280.00	TMJ1A

**B. SMARTPath service (a.k.a. BellSouth SPA Shared Ring) Area Junction**

1. 1.544 Mbps

(a) Per Customer Designated Premises	430.00	140.00	138.00	90.00	70.00	TMJ1B
(b) Per Serving Wire Center Connection	430.00	140.00	70.00	35.00	30.00	TMJ1C

## E7. DEDICATED ACCESS SERVICES

### E7.5 Rates and Charges (Cont'd)

#### E7.5.18 SmartRing<sup>®</sup> service (a.k.a BellSouth Dedicated Ring)

A. Self-healing Multi-nodal Alternate Route Topology Ring - Month-to-Month

1. Local Channel (All capacities except OC-1)

	Month-to-Month	Nonrecurring Charge	USOC
(a) Per Local Channel	-	\$410.00	1HVXX
(b) Per Quarter Air Mile	\$95.00	-	1HVXX
2. Alternate Central Office (All capacities except OC-1)			
(a) Per Alternate C.O. Channel	-	465.00	1HAXX
(b) Per Quarter Air Mile	1,500.00	-	1HAXX
3. Interoffice Channel (All capacities except OC-1)			
(a) Per Channel, except OC-192 and OC-192+ Capacity	-	155.00	1HXFX
(b) Fixed, OC-3 Capacity	50.00	-	1HXFX
(c) Fixed, OC-3+, OC-12, OC-48 or OC-48+ Capacity	175.00	-	1HXFX
(d) Fixed, OC-192 or OC-192+ Capacity	600.00	300.00	1HXFX
(e) Per Quarter Air Mile, OC-3 Capacity	45.00	-	1HXFX
(f) Per Quarter Air Mile, OC-3+, OC-12, OC-48 or OC-48+ Capacity	55.00	-	1HXFX
(g) Per Quarter Air Mile, OC-192 or OC-192+ Capacity	55.00	-	1HXFX
4. Internodal Channel (All capacities except OC-1)			
(a) Per Internodal Channel, Same Wire Center Area, Per Quarter Air Mile	3,000.00	435.00	1HNXX
(b) Per Internodal Channel, Same Office Park/Campus Environment in Contiguous Serving Wire Center Areas, Per Quarter Air Mile	3,500.00	435.00	1HNZX
5. Customer Node (Per Customer Node)			
(a) OC-1 Capacity	800.00	430.00	SHNC4
(b) OC-3 Capacity	2,200.00	485.00	SHNC3
(c) OC-3+ Capacity	3,000.00	485.00	SHNN5
(d) OC-12 Capacity	3,400.00	485.00	SHNC1
(e) OC-48 Capacity	5,800.00	485.00	SHNN8
(f) OC-48+ Capacity	6,500.00	485.00	SHNN9
(g) OC-192 Capacity	25,000.00	640.00	SHNN6
(h) OC-192+ Capacity	25,000.00	640.00	SHNN2

**Note 1:** Effective on or after December 1, 2021, neither new nor existing customers will be permitted to purchase new SMARTRing Service (Service). In addition, (A) Service Payment Plans greater than 12-months in length will no longer be available; and (B) requests to move, add, change, upgrade, or downgrade existing service arrangements will not be accepted, with the following exceptions: (1) existing customers will be permitted to modify their existing Service and will be able to add new circuits to their existing Service, but will not be permitted to add new nodes in any locations; and (2) any such new circuits will be subject to the customer's existing term payment plan or term agreement for the Service to which they are added. Following the expiration of a customer's existing term agreement, Service will be provided on a month-to-month basis at the applicable Month-to-Month rates until the Service is discontinued.

Effective November 30, 2023, unless specified to the contrary in their existing Service agreements, existing customers may not renew Term Payment Plans or term agreements for Service. In addition, no move, add, or change orders of any type will be accepted.

## E7. SPECIAL ACCESS (A.K.A. BELLSOUTH SPA) SERVICE

### E7.5 Rates and Charges (Cont'd)

#### E7.5.18 SMARTRing<sup>2</sup> service (a.k.a. BellSouth Dedicated Ring)

(C)

##### A. Self-healing Multi-nodal Alternate Route Topology Ring - Month-to-Month (Cont'd)

##### 6. Customer Channel Interface (Per Customer Node)

	Month-to-Month	Nonrecurring Charge	USOC	
(a) Per DS1	35.00	240.00	SHNBB	(M)
(b) Per DS3	170.00	110.00	SHNZT	(M)
(c) Per STS-1	220.00	110.00	SHN13	(M)
(d) Per OC-1	100.00	115.00	SHN1C	(M)
(e) Per OC-3, 2-Fiber	240.00	110.00	SHN1D	(M)
(f) Per OC-3, 4-Fiber	475.00	110.00	SHN15	(M)
(g) Per OC-12, 2-Fiber	715.00	115.00	SHN1F	(M)
(h) Per OC-12, 4-Fiber	1,430.00	115.00	SHN19	(M)
(i) Per OC-48, 2-Fiber	1,600.00	640.00	SHN1A	(M)
(j) Per OC-48, 4-Fiber	3,200.00	640.00	SHN1B	(M)
(k) Per 1000 Mbps	740.00	540.00	SHN1K	(M)
(l) Per 100 Mbps (1 STS-1) BellSouth Metro Ethernet <sup>1</sup> Backbone	500.00	800.00	SHN1J	(M)
(m) Per 100 Mbps (3 STS-1) BellSouth Metro Ethernet <sup>1</sup> Backbone	540.00	800.00	SHN33	(M)
(n) Per 1000 Mbps BellSouth Metro Ethernet <sup>1</sup> Backbone	740.00	850.00	SHN34	(M)
(o) Per Fractional 1000 Mbps Metro Ethernet <sup>1</sup> Backbone				
- 150 Mbps (3 STS-1)	\$560.00	\$850.00	SHN35	
- 300 Mbps (6 STS-1)	600.00	850.00	SHN36	
- 450 Mbps (9 STS-1)	640.00	850.00	SHN37	
- 600 Mbps (12 STS-1)	700.00	850.00	SHN38	

**Note 1:** Effective on or after August 22, 2021, this Service will no longer be available for purchase by new or existing customers. In addition, requests to move, add, change, or renew existing service arrangements will not be accepted. Following the expiration of a customer's existing term agreement, service will be provided on a month-to-month basis at the applicable Monthly rates until the service is discontinued. The Company currently plans to discontinue this service on or after March 31, 2023.

**Note 2:** Effective on or after December 1, 2021, neither new nor existing customers will be permitted to purchase new SMARTRing Service (Service). In addition, (A) Service Payment Plans greater than 12-months in length will no longer be available; and (B) requests to move, add, change, upgrade, or downgrade existing service arrangements will not be accepted, with the following exceptions: (1) existing customers will be permitted to modify their existing Service and will be able to add new circuits to their existing Service, but will not be permitted to add new nodes in any locations; and (2) any such new circuits will be subject to the customer's existing term payment plan or term agreement for the Service to which they are added. Following the expiration of a customer's existing term agreement, Service will be provided on a month-to-month basis at the applicable Month-to-Month rates until the Service is discontinued.

(N)

Effective November 30, 2023, unless specified to the contrary in their existing Service agreements, existing customers may not renew Term Payment Plans or term agreements for Service. In addition, no move, add, or change orders of any type will be accepted.

(N)

## E7. DEDICATED ACCESS SERVICES

### E7.5 Rates and Charges (Cont'd)

#### E7.5.18 SMARTRing<sup>1</sup> service (a.k.a. BellSouth Dedicated Ring) (Cont'd)

(C)

##### A. Self-healing Multi-nodal Alternate Route Topology Ring - Month-to-Month (Cont'd)

	Month-to-Month	Nonrecurring Charge	USOC
7. Central Office Node (Per Central Office Node)			
(a) OC-1 Capacity	\$600.00	\$425.00	SHNH4
(b) OC-3 Capacity	1,400.00	485.00	SHNH3
(c) OC-3+ Capacity	2,500.00	485.00	SHNH5
(d) OC-12 Capacity	2,600.00	485.00	SHNH1
(e) OC-48 Capacity	5,400.00	485.00	SHNH8
(f) OC-48+ Capacity	6,100.00	485.00	SHNH9
(g) OC-192 Capacity	25,000.00	640.00	SHNH7
(h) OC-192+ Capacity	25,000.00	640.00	SHNH6
(i) OC-3 Shared Node Interconnection	980.00	550.00	SHNHE
(j) OC-12 Shared Node Interconnection	1,820.00	550.00	SHNHE
(k) OC-48 Shared Node Interconnection	3,400.00	550.00	SHNHE
(l) OC-48+ Shared Node Interconnection	3,840.00	550.00	SHNHE

**Note 1:** Effective on or after December 1, 2021, neither new nor existing customers will be permitted to purchase new SMARTRing Service (Service). In addition, (A) Service Payment Plans greater than 12-months in length will no longer be available; and (B) requests to move, add, change, upgrade, or downgrade existing service arrangements will not be accepted, with the following exceptions: (1) existing customers will be permitted to modify their existing Service and will be able to add new circuits to their existing Service, but will not be permitted to add new nodes in any locations; and (2) any such new circuits will be subject to the customer's existing term payment plan or term agreement for the Service to which they are added. Following the expiration of a customer's existing term agreement, Service will be provided on a month-to-month basis at the applicable Month-to-Month rates until the Service is discontinued.

(N)

Effective November 30, 2023, unless specified to the contrary in their existing Service agreements, existing customers may not renew Term Payment Plans or term agreements for Service. In addition, no move, add, or change orders of any type will be accepted.

(N)

## E7. DEDICATED ACCESS SERVICES

### E7.5 Rates and Charges (Cont'd)

#### E7.5.18 SMARTRing<sup>2</sup> service (a.k.a BellSouth Dedicated Ring)

(C)

- A. Self-healing Multi-nodal Alternate Route Topology Ring - Month-to-Month  
8. Central Office Channel Interface (Per Central Office Node)

	Month-to-Month	Nonrecurring Charge	USOC
(a) Per DS1	\$35.00	\$100.00	SHNCB
(b) Per DS3	115.00	155.00	SHNYT
(c) Per STS-1	150.00	160.00	SHNO2
(d) Per OC-1	100.00	170.00	SHNCC
(e) Per OC-3, 2-Fiber	240.00	105.00	SHNCD
(f) Per OC-3, 4-Fiber	425.00	105.00	SHNO4
(g) Per OC-12, 2-Fiber	640.00	105.00	SHNCF
(h) Per OC-12, 4-Fiber	1,280.00	105.00	SHNC9
(i) Per OC-48, 2-Fiber	1,600.00	640.00	SHNCJ
(j) Per OC-48, 4-Fiber	3,200.00	640.00	SHNCK
(k) Per 28 DS1 Channel System - DS3	650.00	130.00	SHNW8
(l) Per 28 DS1 Channel System - STS-1	750.00	130.00	SHNCS
(m) Per DS1 on 28 DS1 Channel System - DS3	12.00	130.00	SHNCA
(n) Per DS1 on 28 DS1 Channel System - STS-1	40.00	82.00	SHNCG
(o) Per 1000 Mbps	740.00	400.00	SHNCW
(p) Per 100 Mbps (1 STS-1) BellSouth Metro Ethernet <sup>1</sup> Backbone	500.00	800.00	SHNOJ
(q) Per 100 Mbps (3 STS-1) BellSouth Metro Ethernet <sup>1</sup> Backbone	540.00	800.00	SHNCX
(r) Per 1000 Mbps BellSouth Metro Ethernet <sup>1</sup> Backbone	740.00	850.00	SHNC5
(s) Per Fractional 1000 Mbps Metro Ethernet <sup>1</sup> Backbone			
- 150 Mbps (3 STS-1)	560.00	850.00	SHND5
- 300 Mbps (6 STS-1)	600.00	850.00	SHND6
- 450 Mbps (9 STS-1)	640.00	850.00	SHND7
- 600 Mbps (12 STS-1)	700.00	850.00	SHND8

**Note 1:** Effective on or after August 22, 2021, this Service will no longer be available for purchase by new or existing customers. In addition, requests to move, add, change, or renew existing service arrangements will not be accepted. Following the expiration of a customer's existing term agreement, service will be provided on a month-to-month basis at the applicable Monthly rates until the service is discontinued. The Company currently plans to discontinue this service on or after March 31, 2023.

**Note 2:** Effective on or after December 1, 2021, neither new nor existing customers will be permitted to purchase new SMARTRing Service (Service). In addition, (A) Service Payment Plans greater than 12-months in length will no longer be available; and (B) requests to move, add, change, upgrade, or downgrade existing service arrangements will not be accepted, with the following exceptions: (1) existing customers will be permitted to modify their existing Service and will be able to add new circuits to their existing Service, but will not be permitted to add new nodes in any locations; and (2) any such new circuits will be subject to the customer's existing term payment plan or term agreement for the Service to which they are added. Following the expiration of a customer's existing term agreement, Service will be provided on a month-to-month basis at the applicable Month-to-Month rates until the Service is discontinued.

(N)

Effective November 30, 2023, unless specified to the contrary in their existing Service agreements, existing customers may not renew Term Payment Plans or term agreements for Service. In addition, no move, add, or change orders of any type will be accepted.

(N)



## E7. DEDICATED ACCESS SERVICES

### E7.5 Rates and Charges (Cont'd)

#### E7.5.18 SmartRing<sup>1</sup> service (a.k.a BellSouth Dedicated Ring)

**B.** Self-healing Multi-nodal Alternate Route Topology Ring - Transport Payment Plan

1. Local Channel (All capacities except OC-1)

		Per Month Rates			
		A	B	C	
		12-36	37-60	61-96	USOC
		Months <sup>1</sup>	Months <sup>1</sup>	Months <sup>1</sup>	
	(a) Per Quarter Air Mile	\$85.00	\$75.00	\$70.00	1HVXX
2.	Alternate Central Office (All capacities except OC-1)				
	(a) Per Quarter Air Mile	400.00	250.00	200.00	1HAXX
3.	Interoffice Channel (All capacities except OC-1)				
	(a) Fixed, OC-3 Capacity	40.00	35.00	30.00	1HXFX
	(b) Fixed, OC-3+, OC-12, OC-48 or OC-48+ Capacity	155.00	140.00	130.00	1HXFX
	(c) Fixed, OC-192 or OC-192+ Capacity	450.00	400.00	380.00	1HXFX
	(d) Per Quarter Air Mile, OC-3 Capacity	35.00	25.00	20.00	1HXFX
	(e) Per Quarter Air Mile, OC-3+, OC-12, OC-48 or OC-48+ Capacity	40.00	33.00	25.00	1HXFX
	(f) Per Quarter Air Mile, OC-192 or OC-192+ Capacity	40.00	33.00	25.00	1HXFX
4.	Internodal Channel (All capacities except OC-1)				
	(a) Per Internodal Channel, Same Wire Center Area, Per Quarter Air Mile	690.00	415.00	345.00	1HNXX
	(b) Per Internodal Channel, Same Office Park/Campus Environment in Contiguous Serving Wire Center Areas, Per Quarter Air Mile	780.00	465.00	390.00	1HNZX
5.	Customer Node (Per Customer Node)				
	(a) OC-1 Capacity	400.00	350.00	300.00	SHNC4
	(b) OC-3 Capacity	1,100.00	1,000.00	900.00	SHNC3
	(c) OC-3+ Capacity	2,050.00	1,750.00	1,500.00	SHNN5
	(d) OC-12 Capacity	2,200.00	2,000.00	1,750.00	SHNC1
	(e) OC-48 Capacity	4,900.00	4,500.00	3,900.00	SHNN8
	(f) OC-48+ Capacity	4,900.00	4,500.00	3,900.00	SHNN9
	(g) OC-192 Capacity	9,375.00	8,250.00	7,300.00	SHNN6
	(h) OC-192+ Capacity	9,375.00	8,250.00	7,300.00	SHNN2

**Note 1:** Effective on or after December 1, 2021, neither new nor existing customers will be permitted to purchase new SMARTRing Service (Service). In addition, (A) Service Payment Plans greater than 12-months in length will no longer be available; and (B) requests to move, add, change, upgrade, or downgrade existing service arrangements will not be accepted, with the following exceptions: (1) existing customers will be permitted to modify their existing Service and will be able to add new circuits to their existing Service, but will not be permitted to add new nodes in any locations; and (2) any such new circuits will be subject to the customer's existing term payment plan or term agreement for the Service to which they are added. Following the expiration of a customer's existing term agreement, Service will be provided on a month-to-month basis at the applicable Month-to-Month rates until the Service is discontinued.

Effective November 30, 2023, unless specified to the contrary in their existing Service agreements, existing customers may not renew Term Payment Plans or term agreements for Service. In addition, no move, add, or change orders of any type will be accepted.

## E7. DEDICATED ACCESS SERVICES

### E7.5 Rates and Charges (Cont'd)

#### E7.5.18 SMARTRing<sup>2</sup> service (a.k.a BellSouth Dedicated Ring)

- B. Self-healing Multi-nodal Alternate Route Topology Ring - Transport Payment Plan (Cont'd)  
6. Customer Channel Interface (Per Customer Node)

		Per Month Rates			
		A	B	C	
		12-36	37-60	61-96	
		Months <sup>2</sup>	Months <sup>2</sup>	Months <sup>2</sup>	USOC
(a)	Per DS1	\$34.00	\$27.00	\$21.00	SHNBB
(b)	Per DS3	135.00	130.00	125.00	SHNZT
(c)	Per STS-1	170.00	150.00	140.00	SHN13
(d)	Per OC-1	90.00	80.00	75.00	SHN1C
(e)	Per OC-3, 2-Fiber	190.00	175.00	160.00	SHN1D
(f)	Per OC-3, 4-Fiber	380.00	350.00	320.00	SHN15
(g)	Per OC-12, 2-Fiber	570.00	525.00	480.00	SHN1F
(h)	Per OC-12, 4-Fiber	1,140.00	1,050.00	960.00	SHN19
(i)	Per OC-48, 2-Fiber	1,325.00	1,215.00	1,050.00	SHN1A
(j)	Per OC-48, 4-Fiber	2,650.00	2,430.00	2,100.00	SHN1B
(k)	Per 1000 Mbps	520.00	475.00	425.00	SHN1K
(l)	Per 100 Mbps (1 STS-1) BellSouth Metro Ethernet <sup>1</sup> Backbone	175.00	155.00	140.00	SHN1J
(m)	Per 100 Mbps (3 STS-1) BellSouth Metro Ethernet <sup>1</sup> Backbone	210.00	190.00	170.00	SHN33
(n)	Per 1000 Mbps BellSouth Metro Ethernet <sup>1</sup> Backbone	520.00	475.00	425.00	SHN34
(o)	Per Fractional 1000 Mbps Metro Ethernet <sup>1</sup> Backbone				
	- 150 Mbps (3 STS-1)	230.00	210.00	190.00	SHN35
	- 300 Mbps (3 STS-1)	300.00	280.00	260.00	SHN36
	- 450 Mbps (3 STS-1)	340.00	310.00	290.00	SHN37
	- 650 Mbps (3 STS-1)	380.00	340.00	320.00	SHN38
7.	Central Office Node (Per Central Office Node)				
(a)	OC-1 Capacity	400.00	350.00	300.00	SHNH4
(b)	OC-3 Capacity	1,100.00	1,000.00	900.00	SHNH3
(c)	OC-3+ Capacity	2,050.00	1,750.00	1,500.00	SHNH5
(d)	OC-12 Capacity	2,200.00	2,000.00	1,750.00	SHNH1
(e)	OC-48 Capacity	4,900.00	4,500.00	3,900.00	SHNH8
(f)	OC-48+ Capacity	4,900.00	4,500.00	3,900.00	SHNH9
(g)	OC-192 Capacity	9,375.00	8,250.00	7,300.00	SHNH7
(h)	OC-192+ Capacity	9,375.00	8,250.00	7,300.00	SHNH6
(i)	OC-3 Shared Node Interconnection	690.00	630.00	570.00	SHNHE
(j)	OC-12 Shared Node Interconnection	1,390.00	1,260.00	1,100.00	SHNHE
(k)	OC-48 Shared Node Interconnection	2,880.00	2,840.00	2,460.00	SHNHE
(l)	OC-48+ Shared Node Interconnection	2,880.00	2,840.00	2,460.00	SHNHE

**Note 1:** Effective on or after August 22, 2021, this Service will no longer be available for purchase by new or existing customers. In addition, requests to move, add, change, or renew existing service arrangements will not be accepted. Following the expiration of a customer's existing term agreement, service will be provided on a month-to-month basis at the applicable Monthly rates until the service is discontinued. The Company currently plans to discontinue this service on or after March 31, 2023.

**Note 2:** Effective on or after December 1, 2021, neither new nor existing customers will be permitted to purchase new SMARTRing Service (Service). In addition, (A) Service Payment Plans greater than 12-months in length will no longer be available; and (B) requests to move, add, change, upgrade, or downgrade existing service arrangements will not be accepted, with the following exceptions: (1) existing customers will be permitted to modify their existing Service and will be able to add new circuits to their existing Service, but will not be permitted to add new nodes in any locations; and (2) any such new circuits will be subject to the customer's existing term payment plan or term agreement for the Service to which they are added. Following the expiration of a customer's existing term agreement, Service will be provided on a month-to-month basis at the applicable Month-to-Month rates until the Service is discontinued.

Effective November 30, 2023, unless specified to the contrary in their existing Service agreements, existing customers may not renew Term Payment Plans or term agreements for Service. In addition, no move, add, or change orders of any type will be accepted.

**E7. DEDICATED ACCESS SERVICES**

**E7.5 Rates and Charges (Cont'd)**

**E7.5.18 SMARTRing<sup>1</sup> service (a.k.a BellSouth Dedicated Ring)**

- B.** Self-healing Multi-nodal Alternate Route Topology Ring - Transport Payment Plan (Cont'd)  
 8. Central Office Channel Interface (Per Central Office Node)

		Per Month Rates			
		A	B	C	
		12-36	37-60	61-96	
		Months <sup>1</sup>	Months <sup>1</sup>	Months <sup>1</sup>	USOC
(a)	Per DS1	\$30.00	\$25.00	\$20.00	SHNCB
(b)	Per DS3	85.00	80.00	75.00	SHNYT
(c)	Per STS-1	105.00	100.00	90.00	SHNO2
(d)	Per OC-1	90.00	80.00	75.00	SHNCC
(e)	Per OC-3, 2-Fiber	190.00	175.00	160.00	SHNCD
(f)	Per OC-3, 4-Fiber	330.00	300.00	270.00	SHNO4
(g)	Per OC-12, 2-Fiber	495.00	450.00	405.00	SHNCF
(h)	Per OC-12, 4-Fiber	990.00	900.00	810.00	SHNC9
(i)	Per OC-48, 2-Fiber	1,325.00	1,215.00	1,050.00	SHNCJ
(j)	Per OC-48, 4-Fiber	2,650.00	2,430.00	2,100.00	SHNCK
(k)	Per 28 DS1 Channel System - DS3	550.00	500.00	450.00	SHNW8
(l)	Per 28 DS1 Channel System - STS-1	650.00	600.00	575.00	SHNCS
(m)	Per DS1 on 28 DS1 Channel System - DS3	12.00	9.00	7.00	SHNCA
(n)	Per DS1 on 28 DS1 Channel System - STS-1	35.00	30.00	25.00	SHNCG
(o)	Per 1000 Mbps	520.00	475.00	425.00	SHNCW
(p)	Per 100 Mbps (1 STS-1) BellSouth Metro Ethernet Backbone	175.00	155.00	140.00	SHNOJ
(q)	Per 100 Mbps (3 STS-1) BellSouth Metro Ethernet Backbone	210.00	190.00	170.00	SHNCX
(r)	Per 1000 Mbps BellSouth Metro Ethernet Backbone	520.00	475.00	425.00	SHNC5
(s)	Per Fractional 1000 Mbps Metro Ethernet Backbone				
	- 150 Mbps (3 STS-1)	230.00	210.00	190.00	SHND5
	- 300 Mbps (6 STS-1)	300.00	280.00	260.00	SHND6
	- 450 Mbps (9 STS-1)	340.00	310.00	290.00	SHND7
	- 600 Mbps (12 STS-1)	380.00	340.00	320.00	SHND8

- C.** Self-healing Multi-nodal Alternate Route Topology Ring  
 1. Channel Interface Reallocation

		Nonrecurring Charge	USOC
(a)	Per Node, Per Occurrence	\$250.00	SHRBC

**Note 1:** Effective on or after December 1, 2021, neither new nor existing customers will be permitted to purchase new SMARTRing Service (Service). In addition, (A) Service Payment Plans greater than 12-months in length will no longer be available; and (B) requests to move, add, change, upgrade, or downgrade existing service arrangements will not be accepted, with the following exceptions: (1) existing customers will be permitted to modify their existing Service and will be able to add new circuits to their existing Service, but will not be permitted to add new nodes in any locations; and (2) any such new circuits will be subject to the customer's existing term payment plan or term agreement for the Service to which they are added. Following the expiration of a customer's existing term agreement, Service will be provided on a month-to-month basis at the applicable Month-to-Month rates until the Service is discontinued.

Effective November 30, 2023, unless specified to the contrary in their existing Service agreements, existing customers may not renew Term Payment Plans or term agreements for Service. In addition, no move, add, or change orders of any type will be accepted.

BELLSOUTH  
TELECOMMUNICATIONS  
FLORIDA  
ISSUED: October 10, 2014  
BY: Joe York, President -FL  
Jacksonville, Florida

ACCESS SERVICES TARIFF

First Revised Page 77  
Cancels Original Page 77

EFFECTIVE: October 11, 2014

**E7. DEDICATED ACCESS SERVICES**

**E7.5 Rates and Charges (Cont'd)**

E7.5.19 Reserve for Future Use

(T)

**E7. SPECIAL ACCESS (A.K.A. BELLSOUTH SPA) SERVICE**

**E7.5 Rates and Charges (Cont'd)**

**E7.5.20 Reserved For Future Use**

**E7.5.21 Reserved For Future Use**

**E7.5.22 BellSouth Metro Ethernet Service<sup>1</sup>**

**A. Rates and charges for month-to-month service**

**1. Basic BellSouth Metro Ethernet Service Arrangements**

	<b>Nonrecurring Charge</b>	<b>Month to Month</b>	<b>USOC</b>
(a) 2 Mbps Basic Connection - Per Connection	\$ 950.00	\$ 668.25	MTEBO
(b) 4 Mbps Basic Connection - Per Connection	950.00	695.25	MTEB1
(c) 8 Mbps Basic Connection - Per Connection	950.00	810.00	MTEB2
(d) 10 Mbps Basic Connection - Per Connection	900.00	918.00	MTEBA
(e) 100 Mbps Basic Connection - Per Connection	900.00	1,768.50	MTEBB
(f) 1 Gbps Basic Connection - Per Connection	1,000.00	3,847.50	MTEBC

**2. Premium BellSouth Metro Ethernet Service Arrangements**

(a) 2 Mbps Premium Connection - Per Connection, Fixed Mode	950.00	739.80	MTEPO
(b) 4 Mbps Premium Connection - Per Connection, Fixed Mode	950.00	777.60	MTEP1
(c) 8 Mbps Premium Connection - Per Connection, Fixed Mode	950.00	896.40	MTEP2
(d) 10 Mbps Premium Connection - Per Connection, Fixed Mode	900.00	1,220.40	MTEP3
- Per Connection, Burst Mode	900.00	1,529.55	MTEE3
(e) 20 Mbps Premium Connection - Per Connection, Fixed Mode	900.00	1,522.80	MTEP4
- Per Connection, Burst Mode	900.00	1,711.80	MTEE4
(f) 50 Mbps Premium Connection - Per Connection, Fixed Mode	900.00	2,008.80	MTEP5
- Per Connection, Burst Mode	900.00	2,085.75	MTEE5
(g) 100 Mbps Premium Connection - Per Connection, Fixed Mode	1,000.00	2,430.00	MTEP6
- Per Connection, Burst Mode	1,000.00	2,724.30	MTEE6
(h) 250 Mbps Premium Connection - Per Connection, Fixed Mode	1,000.00	3,034.80	MTEP7
- Per Connection, Burst Mode	1,000.00	3,260.25	MTEE7
(i) 500 Mbps Premium Connection - Per Connection, Fixed Mode	1,000.00	4,039.20	MTEP8
- Per Connection, Burst Mode	1,000.00	4,182.30	MTEE8
(j) 900 Mbps Premium Connection - Per Connection, Fixed Mode	1,500.00	5,988.60	MTEP9

**3.**

**Note 1:** Effective on or after August 22, 2021, this Service will no longer be available for purchase by new or existing customers. In addition, requests to move, add, change, or renew existing service arrangements will not be accepted. Following the expiration of a customer's existing term agreement, service will be provided on a month-to-month basis at the applicable Monthly rates until the service is discontinued. The Company currently plans to discontinue this service on or after March 31, 2023.

**E7. SPECIAL ACCESS (A.K.A. BELLSOUTH SPA) SERVICE**

**E7.5 Rates and Charges (Cont'd)**

**E7.5.22 BellSouth Metro Ethernet Service (Cont'd)<sup>2</sup>**

**A. Rates and charges for month-to-month service (Cont'd)**

**4. Virtual BellSouth Metro Ethernet Service Arrangements<sup>1</sup>**

**(a) 2 Mbps Virtual Connection**

	<b>Nonrecurring Charge</b>	<b>Month to Month</b>	<b>USOC</b>	
- Per Connection	\$ 1,000.00	\$ 523.80	MTEVO	(1)
<b>(b) 4 Mbps Virtual Connection</b>				
- Per Connection	1,000.00	561.60	MTEV1	
<b>(c) 8 Mbps Virtual Connection</b>				
- Per Connection	1,000.00	680.40	MTEV2	
<b>(d) 10 Mbps Virtual Connection</b>				
- Per Connection	1,000.00	1,004.40	MTEV3	
<b>(e) 20 Mbps Virtual Connection</b>				
- Per Connection	1,000.00	1,306.80	MTEV4	
<b>(f) 50 Mbps Virtual Connection</b>				
- Per Connection	1,000.00	1,792.80	MTEV5	
<b>(g) 80 Mbps Virtual Connection</b>				
- Per Connection	1,000.00	2,003.40	MTEV6	
<b>(h) 100 Mbps Virtual Connection</b>				
- Per Connection	1,500.00	2,214.00	MTEV7	
<b>(i) 200 Mbps Virtual Connection</b>				
- Per Connection	1,500.00	2,818.80	MTEV8	
<b>(j) 300 Mbps Virtual Connection</b>				
- Per Connection	1,500.00	3,180.60	MTEV9	
<b>(k) 450 Mbps Virtual Connection</b>				
- Per Connection	1,500.00	3,823.20	MTEVA	
<b>(l) 600 Mbps Virtual Connection</b>				
- Per Connection	1,750.00	4,541.40	MTEVB	
<b>(m) 750 Mbps Virtual Connection</b>				
- Per Connection	1,750.00	5,292.00	MTEVC	
<b>(n) 900 Mbps Virtual Connection</b>				
- Per Connection	2,000.00	5,772.60	MTEVD	(1)

**5. BellSouth Metro Ethernet Service Independent Company (ICO) Trunk Arrangements**

<b>(a) ICO Trunk Connection</b>				
- Per VLAN Connection	1,300.00	1,046.25	MTEGC	(1)

**Note 1:** Each Virtual Connection requires the establishment of a Class of Service (CoS) profile.

**Note 2:** Effective on or after August 22, 2021, this Service will no longer be available for purchase by new or existing customers. In addition, requests to move, add, change, or renew existing service arrangements will not be accepted. Following the expiration of a customer's existing term agreement, service will be provided on a month-to-month basis at the applicable Monthly rates until the service is discontinued. The Company currently plans to discontinue this service on or after March 31, 2023.

**E7. SPECIAL ACCESS (A.K.A. BELLSOUTH SPA) SERVICE**

**E7.5 Rates and Charges (Cont'd)**

**E7.5.22 BellSouth Metro Ethernet Service (Cont'd)<sup>1</sup>**

**A. Rates and charges for month-to-month service (Cont'd)**

**6. BellSouth Metro Ethernet Service Additional Mileage**

- (a) BellSouth Metro Ethernet Service Additional Mileage:  
 BellSouth Metro Ethernet Service arrangements greater than  
 10 miles through 25 airline miles

	<b>Month to Month</b>	<b>USOC</b>	
- Per 2 – 9 Mbps Connection	\$ 432.00	MTEMO	(1)
- Per 10 – 99 Mbps Connection	449.55	MTEMA	
- Per 100 – 499 Mbps Connection	558.90	MTEMB	
- Per 500 Mbps – 1 Gbps Connection	680.40	MTEMC	

- (b) BellSouth Metro Ethernet Service Additional Mileage:  
 BellSouth Metro Ethernet Service arrangements greater than  
 25 miles through 35 airline miles

- Per 2 – 9 Mbps Connection	708.75	MTEMD	
- Per 10 – 99 Mbps Connection	753.30	MTEME	
- Per 100 – 499 Mbps Connection	947.70	MTEMF	
- Per 500 Mbps – 1 Gbps Connection	1,129.95	MTEMG	

- (c) BellSouth Metro Ethernet Service Additional Mileage:  
 BellSouth Metro Ethernet Service arrangements greater than  
 35 miles through 50 airline miles

- Per 2 – 9 Mbps Connection	1,080.00	MTEMH	
- Per 10 – 99 Mbps Connection	1,178.55	MTEMJ	
- Per 100 – 499 Mbps Connection	1,470.15	MTEMK	
- Per 500 Mbps – 1 Gbps Connection	1,773.90	MTEML	(1)

**7. BellSouth Metro Ethernet Service Independent Company (ICO) Trunk Additional Mileage Charges**

- (a) BellSouth Metro Ethernet Service ICO Trunk Additional Mileage:  
 BellSouth Metro Ethernet Service ICO Trunk arrangements greater than  
 10 miles through 25 airline miles  
 - per VLAN Connection

229.50 MTEM1

(1)

- (b) BellSouth Metro Ethernet Service ICO Trunk Additional Mileage:  
 BellSouth Metro Ethernet Service ICO Trunk arrangements greater than  
 25 miles through 35 airline miles  
 - per VLAN Connection

567.00 MTEM2

(1)

- (c) BellSouth Metro Ethernet Service ICO Trunk Additional Mileage:  
 BellSouth Metro Ethernet Service ICO Trunk arrangements greater than  
 35 miles through 50 airline miles  
 - per VLAN Connection

911.25 MTEM3

(1)

**Note 1:** Effective on or after August 22, 2021, this Service will no longer be available for purchase by new or existing customers. In addition, requests to move, add, change, or renew existing service arrangements will not be accepted. Following the expiration of a customer's existing term agreement, service will be provided on a month-to-month basis at the applicable Monthly rates until the service is discontinued. The Company currently plans to discontinue this service on or after March 31, 2023.

**E7. SPECIAL ACCESS (A.K.A. BELLSOUTH SPA) SERVICE**

**E7.5 Rates and Charges (Cont'd)**

**E7.5.22 BellSouth Metro Ethernet Service (Cont'd)<sup>2</sup>**

(C)

A. Rates and charges for month-to-month service (Cont'd)

4. Virtual BellSouth Metro Ethernet Service Arrangements<sup>1</sup>

(a) 2 Mbps Virtual Connection

- Per Connection

Nonrecurring Charge	Month to Month	USOC
\$ 1,000.00	\$ 388.00	MTEVO

(b) 4 Mbps Virtual Connection

- Per Connection

1,000.00	416.00	MTEV1
----------	--------	-------

(c) 8 Mbps Virtual Connection

- Per Connection

1,000.00	504.00	MTEV2
----------	--------	-------

(d) 10 Mbps Virtual Connection

- Per Connection

1,000.00	744.00	MTEV3
----------	--------	-------

(e) 20 Mbps Virtual Connection

- Per Connection

1,000.00	968.00	MTEV4
----------	--------	-------

(f) 50 Mbps Virtual Connection

- Per Connection

1,000.00	1,328.00	MTEV5
----------	----------	-------

(g) 80 Mbps Virtual Connection

- Per Connection

1,000.00	1,484.00	MTEV6
----------	----------	-------

(h) 100 Mbps Virtual Connection

- Per Connection

1,500.00	1,640.00	MTEV7
----------	----------	-------

(i) 200 Mbps Virtual Connection

- Per Connection

1,500.00	2,088.00	MTEV8
----------	----------	-------

(j) 300 Mbps Virtual Connection

- Per Connection

1,500.00	2,356.00	MTEV9
----------	----------	-------

(k) 450 Mbps Virtual Connection

- Per Connection

1,500.00	2,832.00	MTEVA
----------	----------	-------

(l) 600 Mbps Virtual Connection

- Per Connection

1,750.00	3,364.00	MTEVB
----------	----------	-------

(m) 750 Mbps Virtual Connection

- Per Connection

1,750.00	3,920.00	MTEVC
----------	----------	-------

(n) 900 Mbps Virtual Connection

- Per Connection

2,000.00	4,276.00	MTEVD
----------	----------	-------

5. BellSouth Metro Ethernet Service Independent Company (ICO) Trunk Arrangements

(a) ICO Trunk Connection

- Per VLAN Connection

1,300.00	775.00	MTEGC
----------	--------	-------

**Note 1:** Each Virtual Connection requires the establishment of a Class of Service (CoS) profile.

**Note 2:** Effective on or after August 22, 2021, this Service will no longer be available for purchase by new or existing customers. In addition, requests to move, add, change, or renew existing service arrangements will not be accepted. Following the expiration of a customer's existing term agreement, service will be provided on a month-to-month basis at the applicable Monthly rates until the service is discontinued. The Company currently plans to discontinue this service on or after March 31, 2023.

(N)  
 |  
 (N)



## E7. SPECIAL ACCESS (A.K.A. BELLSOUTH SPA) SERVICE

### E7.5 Rates and Charges (Cont'd)

#### E7.5.22 BellSouth Metro Ethernet Service (Cont'd)<sup>1</sup>

(C)

##### A. Rates and charges for month-to-month service (Cont'd)

##### 6. BellSouth Metro Ethernet Service Additional Mileage

- (a) BellSouth Metro Ethernet Service Additional Mileage:  
 BellSouth Metro Ethernet Service arrangements greater than  
 10 miles through 25 airline miles

	Month to Month	USOC
- Per 2 – 9 Mbps Connection	\$ 320.00	MTEMO
- Per 10 – 99 Mbps Connection	333.00	MTEMA
- Per 100 – 499 Mbps Connection	414.00	MTEMB
- Per 500 Mbps – 1 Gbps Connection	504.00	MTEMC

- (b) BellSouth Metro Ethernet Service Additional Mileage:  
 BellSouth Metro Ethernet Service arrangements greater than  
 25 miles through 35 airline miles

- Per 2 – 9 Mbps Connection	525.00	MTEMD
- Per 10 – 99 Mbps Connection	558.00	MTEME
- Per 100 – 499 Mbps Connection	702.00	MTEMF
- Per 500 Mbps – 1 Gbps Connection	837.00	MTEMG

- (c) BellSouth Metro Ethernet Service Additional Mileage:  
 BellSouth Metro Ethernet Service arrangements greater than  
 35 miles through 50 airline miles

- Per 2 – 9 Mbps Connection	800.00	MTEMH
- Per 10 – 99 Mbps Connection	873.00	MTEMJ
- Per 100 – 499 Mbps Connection	1,089.00	MTEMK
- Per 500 Mbps – 1 Gbps Connection	1,314.00	MTEML

##### 7. BellSouth Metro Ethernet Service Independent Company (ICO) Trunk Additional Mileage Charges

- (a) BellSouth Metro Ethernet Service ICO Trunk Additional Mileage:  
 BellSouth Metro Ethernet Service ICO Trunk arrangements greater than  
 10 miles through 25 airline miles  
 - per VLAN Connection

170.00 MTEM1

- (b) BellSouth Metro Ethernet Service ICO Trunk Additional Mileage:  
 BellSouth Metro Ethernet Service ICO Trunk arrangements greater than  
 25 miles through 35 airline miles  
 - per VLAN Connection

420.00 MTEM2

- (c) BellSouth Metro Ethernet Service ICO Trunk Additional Mileage:  
 BellSouth Metro Ethernet Service ICO Trunk arrangements greater than  
 35 miles through 50 airline miles  
 - per VLAN Connection

675.00 MTEM3

**Note 1:** Effective on or after August 22, 2021, this Service will no longer be available for purchase by new or existing customers. In addition, requests to move, add, change, or renew existing service arrangements will not be accepted. Following the expiration of a customer's existing term agreement, service will be provided on a month-to-month basis at the applicable Monthly rates until the service is discontinued. The Company currently plans to discontinue this service on or after March 31, 2023.

(N)

(N)

**E7. SPECIAL ACCESS (A.K.A. BELLSOUTH SPA) SERVICE**

**E7.5 Rates and Charges (Cont'd)**

**E7.5.22 BellSouth Metro Ethernet Service (Cont'd)<sup>4</sup>**

**A. Rates and charges for month-to-month service (Cont'd)**

**8. Priority Plus Feature<sup>1</sup>**

	<b>Nonrecurring Charge</b>	<b>Month to Month</b>	<b>USOC MTEP</b>	
- Per Connection	\$ -	\$ 162.00		(1)
<b>9. Q-Forwarding Feature<sup>1</sup></b>				
(a) Q-Forwarding Service Establishment Charge - Per Connection	400.00	-	MTEQF	
(b) Q-Forwarding Network Assignment Charge - Per Network, Per Connection	-	108.00	MTEQN	(1)
<b>10. VLAN Aggregation Feature<sup>2</sup></b>				
(a) VLAN Aggregation Service Establishment Charge - Per Connection	400.00	-	MTEQE	
(b) VLAN Aggregation Network Assignment Charge - Per VLAN, Per Connection	-	108.00	MTEQV	(1)
<b>11. CNM - Metro Ethernet Reporting Feature<sup>3</sup></b>				
(a) CNM - Metro Ethernet Reporting, Service Establishment Charge - Per Customer Account	225.00	-	MTERE	
(b) CNM - Metro Ethernet Reporting Charge - Per Connection	-	13.50	MTERC	(1)
(c) CNM - Metro Ethernet Reporting, Web Interface Charge - First	-	-	MTER1	
- Each Additional	65.00	27.00	MTERW	(1)
(d) CNM - Metro Ethernet Reporting, Security Card - Each	200.00	-	MTERS	

**Note 1:** Optional feature only available with a Premium Connection.

**Note 2:** Optional feature only available with a Virtual Connection.

**Note 3:** Optional feature only available with a Premium or Virtual Connection.

**Note 4:** Effective on or after August 22, 2021, this Service will no longer be available for purchase by new or existing customers. In addition, requests to move, add, change, or renew existing service arrangements will not be accepted. Following the expiration of a customer's existing term agreement, service will be provided on a month-to-month basis at the applicable Monthly rates until the service is discontinued. The Company currently plans to discontinue this service on or after March 31, 2023.

**E7. SPECIAL ACCESS (A.K.A. BELLSOUTH SPA) SERVICE**

**E7.5 Rates and Charges (Cont'd)**

**E7.5.22 BellSouth Metro Ethernet Service (Cont'd)<sup>3</sup>**

**A. Rates and charges for month-to-month service (Cont'd)**

**12. Class of Service (CoS) Profile<sup>1</sup>**

**(a) Real-Time CoS<sup>2</sup>**

	<b>Month to Month</b>	<b>USOC</b>
- 10%	\$ 72.90	MTETF
- 20%	145.80	MTETG
- 25%	182.25	MTETH
- 30%	218.70	MTETJ
- 35%	255.15	MTETK
- 40%	291.60	MTETL
- 50%	364.50	MTETM
- 70%	510.30	MTETO

**(b) Interactive CoS<sup>2</sup>**

- 10%	60.75	MTEVF
- 20%	121.50	MTEVG
- 25%	151.20	MTEVH
- 30%	182.25	MTEVJ
- 35%	211.95	MTEVK
- 40%	243.00	MTEVL
- 50%	303.75	MTEVM

**Note 1:** Each Virtual Connection requires the designation of a CoS profile with desired percentages of each CoS selected. The sum of the percentages for all CoS selected for a Virtual Connection must sum to 100%.

**Note 2:** The combined CoS bandwidth percentages selected in a customer's Virtual Connection CoS profile for Real-Time CoS plus Interactive CoS may not exceed 50%, except where the customer selects the 70% Real-Time CoS bandwidth percentage and has no Interactive traffic.

**Note 3:** Effective on or after August 22, 2021, this Service will no longer be available for purchase by new or existing customers. In addition, requests to move, add, change, or renew existing service arrangements will not be accepted. Following the expiration of a customer's existing term agreement, service will be provided on a month-to-month basis at the applicable Monthly rates until the service is discontinued. The Company currently plans to discontinue this service on or after March 31, 2023.

(1)

**E7. SPECIAL ACCESS (A.K.A. BELLSOUTH SPA) SERVICE**

**E7.5 Rates and Charges (Cont'd)**

**E7.5.22 BellSouth Metro Ethernet Service (Cont'd)<sup>2</sup>**

**A. Rates and charges for month-to-month service (Cont'd)**

**12. Class of Service (CoS) Profile<sup>1</sup> (Cont'd)**

**(c) Business Critical CoS**

	<b>Month to Month</b>	<b>USOC</b>
- 10%	\$ 36.45	MTEPF
- 20%	72.90	MTEPG
- 25%	90.45	MTEPH
- 30%	109.35	MTEPJ
- 35%	126.90	MTEPK
- 40%	145.80	MTEPL
- 50%	182.25	MTEPM
- 60%	218.70	MTEPN
- 75%	272.70	MTEPP
- 90%	328.05	MTEPQ
- 100%	364.50	MTEPR

**(d) Best Effort CoS**

- 10%	12.15	MTEBF
- 20%	24.30	MTEBG
- 25%	29.70	MTEBH
- 30%	36.45	MTEBJ
- 35%	41.85	MTEBK
- 40%	48.60	MTEBL
- 50%	60.75	MTEBM
- 60%	72.90	MTEBN
- 75%	90.45	MTEBP
- 90%	109.35	MTEBQ

**Note 1:** Each Virtual Connection requires the designation of a CoS profile with desired percentages of each CoS selected. The sum of the percentages for all CoS selected for a Virtual Connection must sum to 100%.

**Note 2:** Effective on or after August 22, 2021, this Service will no longer be available for purchase by new or existing customers. In addition, requests to move, add, change, or renew existing service arrangements will not be accepted. Following the expiration of a customer's existing term agreement, service will be provided on a month-to-month basis at the applicable Monthly rates until the service is discontinued. The Company currently plans to discontinue this service on or after March 31, 2023.

**E7. SPECIAL ACCESS (A.K.A. BELLSOUTH SPA) SERVICE**

**E7.5 Rates and Charges (Cont'd)**

**E7.5.22 BellSouth Metro Ethernet Service (Cont'd)<sup>3</sup>**

**A. Rates and charges for month-to-month service (Cont'd)**

**13. Automatic Protection Switching (APS) Feature<sup>1</sup>:** Selected to provide automatic protection switching in conjunction with a Basic, Premium or Virtual BellSouth Metro Ethernet Connection of 10 Mbps or higher. Applicable APS rate element based upon type of APS selected and actual total route miles<sup>2</sup> (rounded up to next whole mile) based upon a customer-specific design as determined by the Telephone Company.

(a) Structural Protection

	<b>Nonrecurring Charge</b>	<b>Month to Month</b>	<b>USOC</b>
- Per APS Arrangement of less than 10 route miles	\$ 1000.00	\$ 2,565.00	MTEAO
- Per APS Arrangement of 10 through 25 route miles	1500.00	2,895.75	MTEA1
- Per APS Arrangement of greater than 25 through 35 route miles	2000.00	3,300.75	MTEA2
- Per APS Arrangement of greater than 35 through 50 route miles	2500.00	3,915.00	MTEA3

(b) Route Protection

- Per APS Arrangement of less than 10 route miles	1500.00	3,132.00	MTEA5
- Per APS Arrangement of 10 through 25 route miles	2000.00	3,523.50	MTEA6
- Per APS Arrangement of greater than 25 through 35 route miles	2500.00	4,002.75	MTEA7
- Per APS Arrangement of greater than 35 through 50 route miles	3000.00	4,637.25	MTEA8

**14. Optical Termination Charge:** An electrical termination on the customer premises is standard for 2, 4 and 8 Mbps Basic, Premium and Virtual Connections. Therefore, an Optical Termination Charge applies when an optional optical termination is requested and provided for a 2, 4 or 8 Mbps Connection.

(a) Per Optical Termination

- Per Connection	-	40.50	MTEO1
------------------	---	-------	-------

**15. Service Reconfiguration Charge**

(a) Per Request

- Per Connection	200.00	-	MTESR
------------------	--------	---	-------

**16. System Reconfiguration Charge**

(a) Per Request

- Per Connection	900.00	-	MTESY
------------------	--------	---	-------

**Note 1:** Optional feature only available with a Basic, Premium or Virtual Connection of 10 Mbps or higher. (APS is not available for a 2 Mbps, 4 Mbps or 8 Mbps Basic, Premium or Virtual Connection).

**Note 2:** Per definition of route mileage provided in E7.2.18U preceding.

**Note 3:** Effective on or after August 22, 2021, this Service will no longer be available for purchase by new or existing customers. In addition, requests to move, add, change, or renew existing service arrangements will not be accepted. Following the expiration of a customer's existing term agreement, service will be provided on a month-to-month basis at the applicable Monthly rates until the service is discontinued. The Company currently plans to discontinue this service on or after March 31, 2023.

## E7. SPECIAL ACCESS (A.K.A. BELLSOUTH SPA) SERVICE

### E7.5 Rates and Charges (Cont'd)

#### E7.5.22 BellSouth Metro Ethernet Service (Cont'd)<sup>1</sup>

(C)

##### B. Rates and charges for Transport Payment Plan

##### 1. Basic BellSouth Metro Ethernet Service Arrangements

##### (a) 2 Mbps Basic Connection

	Nonrecurring Charge	Transport Payment Plan Rates			USOC
		A 12-36 Mos	B 37-60 Mos	C 61-96 Mos	
- Per Connection	\$ -	\$ 380.00	\$ 360.00	\$ 345.00	MTEBO
(b) 4 Mbps Basic Connection					
- Per Connection	-	500.00	415.00	395.00	MTEB1
(c) 8 Mbps Basic Connection					
- Per Connection	-	540.00	475.00	450.00	MTEB2
(d) 10 Mbps Basic Connection					
- Per Connection	-	630.00	599.00	550.00	MTEBA
(e) 100 Mbps Basic Connection					
- Per Connection	-	1,180.00	1,121.00	1,065.00	MTEBB
(f) 1 Gbps Basic Connection					
- Per Connection	-	2,565.00	2,437.00	2,315.00	MTEBC

##### 2. Premium BellSouth Metro Ethernet Service Arrangements

(a) 2 Mbps Premium Connection					
- Per Connection, Fixed Mode	-	500.00	435.00	415.00	MTEPO
(b) 4 Mbps Premium Connection					
- Per Connection, Fixed Mode	-	540.00	470.00	445.00	MTEP1
(c) 8 Mbps Premium Connection					
- Per Connection, Fixed Mode	-	640.00	510.00	485.00	MTEP2
(d) 10 Mbps Premium Connection					
- Per Connection, Fixed Mode	-	720.00	684.00	650.00	MTEP3
- Per Connection, Burst Mode	-	900.00	855.00	812.00	MTEE3
(e) 20 Mbps Premium Connection					
- Per Connection, Fixed Mode	-	904.00	859.00	816.00	MTEP4
- Per Connection, Burst Mode	-	1,013.00	962.00	914.00	MTEE4
(f) 50 Mbps Premium Connection					
- Per Connection, Fixed Mode	-	1,192.00	1,132.00	1,075.00	MTEP5
- Per Connection, Burst Mode	-	1,238.00	1,176.00	1,117.00	MTEE5
(g) 100 Mbps Premium Connection					
- Per Connection, Fixed Mode	-	1,440.00	1,368.00	1,300.00	MTEP6
- Per Connection, Burst Mode	-	1,613.00	1,532.00	1,455.00	MTEE6
(h) 250 Mbps Premium Connection					
- Per Connection, Fixed Mode	-	1,800.00	1,710.00	1,625.00	MTEP7
- Per Connection, Burst Mode	-	1,935.00	1,838.00	1,746.00	MTEE7
(i) 500 Mbps Premium Connection					
- Per Connection, Fixed Mode	-	2,392.00	2,272.00	2,158.00	MTEP8
- Per Connection, Burst Mode	-	2,475.00	2,351.00	2,233.00	MTEE8
(j) 900 Mbps Premium Connection					
- Per Connection, Fixed Mode	-	3,700.00	3,532.00	3,356.00	MTEP9

##### 3.

**Note 1:** Effective on or after August 22, 2021, this Service will no longer be available for purchase by new or existing customers. In addition, requests to move, add, change, or renew existing service arrangements will not be accepted. Following the expiration of a customer's existing term agreement, service will be provided on a month-to-month basis at the applicable Monthly rates until the service is discontinued. The Company currently plans to discontinue this service on or after March 31, 2023.

(N)  
|  
(N)

**E7. SPECIAL ACCESS (A.K.A. BELLSOUTH SPA) SERVICE**

**E7.5 Rates and Charges (Cont'd)**

**E7.5.22 BellSouth Metro Ethernet Service (Cont'd)<sup>2</sup>**

(C)

**B. Rates and charges for Transport Payment Plan (Cont'd)**

4. Virtual BellSouth Metro Ethernet Service Arrangements<sup>1</sup>

(a) 2 Mbps Virtual Connection

	Nonrecurring Charge	Transport Payment Plan Rates			USOC
		A 12-36 Mos	B 37-60 Mos	C 61-96 Mos	
- Per Connection	\$ -	\$ 340.00	\$ 321.00	\$ 305.00	MTEVO
(b) 4 Mbps Virtual Connection					
- Per Connection	-	380.00	359.00	341.00	MTEV1
(c) 8 Mbps Virtual Connection					
- Per Connection	-	480.00	454.00	431.00	MTEV2
(d) 10 Mbps Virtual Connection					
- Per Connection	-	560.00	529.00	503.00	MTEV3
(e) 20 Mbps Virtual Connection					
- Per Connection	-	744.00	703.00	668.00	MTEV4
(f) 50 Mbps Virtual Connection					
- Per Connection	-	1,032.00	975.00	926.00	MTEV5
(g) 80 Mbps Virtual Connection					
- Per Connection	-	1,156.00	1,092.00	1,038.00	MTEV6
(h) 100 Mbps Virtual Connection					
- Per Connection	-	1,280.00	1,210.00	1,149.00	MTEV7
(i) 200 Mbps Virtual Connection					
- Per Connection	-	1,640.00	1,550.00	1,472.00	MTEV8
(j) 300 Mbps Virtual Connection					
- Per Connection	-	1,936.00	1,830.00	1,738.00	MTEV9
(k) 450 Mbps Virtual Connection					
- Per Connection	-	2,232.00	2,109.00	2,004.00	MTEVA
(l) 600 Mbps Virtual Connection					
- Per Connection	-	2,660.00	2,514.00	2,388.00	MTEVB
(m) 750 Mbps Virtual Connection					
- Per Connection	-	3,104.00	2,933.00	2,787.00	MTEVC
(n) 900 Mbps Virtual Connection					
- Per Connection	-	3,540.00	3,345.00	3,178.00	MTEVD

5. BellSouth Metro Ethernet Service Independent Company (ICO) Trunk Arrangements

(a) ICO Trunk Connection  
 - Per VLAN Connection

-	500.00	450.00	405.00	MTEGC
---	--------	--------	--------	-------

**Note 1:** Each Virtual Connection requires the establishment of a Class of Service (CoS) profile.

**Note 2:** Effective on or after August 22, 2021, this Service will no longer be available for purchase by new or existing customers. In addition, requests to move, add, change, or renew existing service arrangements will not be accepted. Following the expiration of a customer's existing term agreement, service will be provided on a month-to-month basis at the applicable Monthly rates until the service is discontinued. The Company currently plans to discontinue this service on or after March 31, 2023.

(N)  
 |  
 (N)

**E7. SPECIAL ACCESS (A.K.A. BELLSOUTH SPA) SERVICE**

**E7.5 Rates and Charges (Cont'd)**

**E7.5.22 BellSouth Metro Ethernet Service (Cont'd)<sup>1</sup>**

(C)

**B. Rates and charges for Transport Payment Plan (Cont'd)**

**6. BellSouth Metro Ethernet Service Additional Mileage**

- (a) BellSouth Metro Ethernet Service Additional Mileage:  
 BellSouth Metro Ethernet Service arrangements greater than  
 10 miles through 25 airline miles

Nonrecurring Charge	Transport Payment Plan Rates			USOC
	A	B	C	
	12-36 Mos	37-60 Mos	61-96 Mos	
- Per 2 – 9 Mbps Connection	\$ - \$ 320.00	\$ 320.00	\$ 320.00	MTEMO
- Per 10 – 99 Mbps Connection	- 333.00	333.00	333.00	MTEMA
- Per 100 – 499 Mbps Connection	- 414.00	414.00	414.00	MTEMB
- Per 500 Mbps – 1 Gbps Connection	- 504.00	504.00	504.00	MTEMC

- (b) BellSouth Metro Ethernet Service Additional Mileage:  
 BellSouth Metro Ethernet Service arrangements greater than  
 25 miles through 35 airline miles

- Per 2 – 9 Mbps Connection	- 525.00	525.00	525.00	MTEMD
- Per 10 – 99 Mbps Connection	- 558.00	558.00	558.00	MTEME
- Per 100 – 499 Mbps Connection	- 702.00	702.00	702.00	MTEMF
- Per 500 Mbps – 1 Gbps Connection	- 837.00	837.00	837.00	MTEMG

- (c) BellSouth Metro Ethernet Service Additional Mileage:  
 BellSouth Metro Ethernet Service arrangements greater than  
 35 miles through 50 airline miles

- Per 2 – 9 Mbps Connection	- 800.00	800.00	800.00	MTEMH
- Per 10 – 99 Mbps Connection	- 873.00	873.00	873.00	MTEMJ
- Per 100 – 499 Mbps Connection	- 1,089.00	1,089.00	1,089.00	MTEMK
- Per 500 Mbps – 1 Gbps Connection	- 1,314.00	1,314.00	1,314.00	MTEML

**7. BellSouth Metro Ethernet Service Independent Company (ICO) Trunk Additional Mileage Charges**

- (a) BellSouth Metro Ethernet Service ICO Trunk Additional Mileage:  
 BellSouth Metro Ethernet Service ICO Trunk arrangements greater than  
 10 miles through 25 airline miles  
 - per VLAN Connection

- per VLAN Connection	- 170.00	170.00	170.00	MTEM1
-----------------------	----------	--------	--------	-------

- (b) BellSouth Metro Ethernet Service ICO Trunk Additional Mileage:  
 BellSouth Metro Ethernet Service ICO Trunk arrangements greater than  
 25 miles through 35 airline miles  
 - per VLAN Connection

- per VLAN Connection	- 420.00	420.00	420.00	MTEM2
-----------------------	----------	--------	--------	-------

- (c) BellSouth Metro Ethernet Service ICO Trunk Additional Mileage:  
 BellSouth Metro Ethernet Service ICO Trunk arrangements greater than  
 35 miles through 50 airline miles  
 - per VLAN Connection

- per VLAN Connection	- 675.00	675.00	675.00	MTEM3
-----------------------	----------	--------	--------	-------

**Note 1:** Effective on or after August 22, 2021, this Service will no longer be available for purchase by new or existing customers. In addition, requests to move, add, change, or renew existing service arrangements will not be accepted. Following the expiration of a customer's existing term agreement, service will be provided on a month-to-month basis at the applicable Monthly rates until the service is discontinued. The Company currently plans to discontinue this service on or after March 31, 2023.

(N)  
 |  
 (N)



**E7. SPECIAL ACCESS (A.K.A. BELLSOUTH SPA) SERVICE**

**E7.5 Rates and Charges (Cont'd)**

**E7.5.22 BellSouth Metro Ethernet Service (Cont'd)<sup>4</sup>**

(C)

**B. Rates and charges for Transport Payment Plan (Cont'd)**

**8. Priority Plus Feature<sup>1</sup>**

	<b>Transport Payment Plan Rates</b>				
	<b>A</b>	<b>B</b>	<b>C</b>		
	<b>12-36</b>	<b>37-60</b>	<b>61-96</b>		
	<b>Nonrecurring</b>	<b>Nonrecurring</b>	<b>Nonrecurring</b>		
	<b>Charge<sup>2</sup></b>	<b>Charge<sup>2</sup></b>	<b>Charge<sup>2</sup></b>		
	<b>Mos</b>	<b>Mos</b>	<b>Mos</b>		
- Per Connection	\$ -	\$ 95.00	\$ 85.00	\$ 80.00	USOC MTEQP

**9. Q-Forwarding Feature<sup>1</sup>**

**(a) Q-Forwarding Service Establishment Charge**

- Per Connection	<b>Nonrecurring Charge<sup>2</sup></b>	<b>\$400.00</b>	<b>USOC</b> <b>MTEQF</b>
------------------	--	-----------------	-----------------------------

**(b) Q-Forwarding Network Assignment Charge**

	<b>Transport Payment Plan Rates</b>				
	<b>A</b>	<b>B</b>	<b>C</b>		
	<b>12-36</b>	<b>37-60</b>	<b>61-96</b>		
	<b>Nonrecurring</b>	<b>Nonrecurring</b>	<b>Nonrecurring</b>		
	<b>Charge<sup>2</sup></b>	<b>Charge<sup>2</sup></b>	<b>Charge<sup>2</sup></b>		
	<b>Mos</b>	<b>Mos</b>	<b>Mos</b>		
- Per Network, Per Connection	\$ -	\$ 65.00	\$ 60.00	\$ 55.00	USOC MTEQN

**10. VLAN Aggregation Feature<sup>3</sup>**

**(a) VLAN Aggregation Service Establishment Charge**

- Per Connection	<b>Nonrecurring Charge<sup>2</sup></b>	<b>\$400.00</b>	<b>USOC</b> <b>MTEQE</b>
------------------	--	-----------------	-----------------------------

**(b) VLAN Aggregation Network Assignment Charge**

	<b>Transport Payment Plan Rates</b>				
	<b>A</b>	<b>B</b>	<b>C</b>		
	<b>12-36</b>	<b>37-60</b>	<b>61-96</b>		
	<b>Nonrecurring</b>	<b>Nonrecurring</b>	<b>Nonrecurring</b>		
	<b>Charge<sup>2</sup></b>	<b>Charge<sup>2</sup></b>	<b>Charge<sup>2</sup></b>		
	<b>Mos</b>	<b>Mos</b>	<b>Mos</b>		
- Per VLAN, Per Connection	\$ -	\$ 65.00	\$ 60.00	\$ 55.00	USOC MTEQV

**Note 1:** Optional feature only available with a Premium Connection.

**Note 2:** This nonrecurring charge is applicable to service under a TPP arrangement.

**Note 3:** Optional feature only available with a Virtual Connection.

**Note 4:** Effective on or after August 22, 2021, this Service will no longer be available for purchase by new or existing customers. In addition, requests to move, add, change, or renew existing service arrangements will not be accepted. Following the expiration of a customer's existing term agreement, service will be provided on a month-to-month basis at the applicable Monthly rates until the service is discontinued. The Company currently plans to discontinue this service on or after March 31, 2023.

(N)  
 |  
 (N)

**E7. SPECIAL ACCESS (A.K.A. BELLSOUTH SPA) SERVICE**

**E7.5 Rates and Charges (Cont'd)**

**E7.5.22 BellSouth Metro Ethernet Service (Cont'd)<sup>3</sup>**

(C)

**B. Rates and charges for Transport Payment Plan (Cont'd)**

**II. CNM - Metro Ethernet Reporting Feature<sup>1</sup>**

- (a) CNM - Metro Ethernet Reporting, Service Establishment Charge

**Nonrecurring Charge<sup>2</sup>**      **USOC**  
 \$ 225.00      **MTERE**

- Per Customer Account

- (b) CNM - Metro Ethernet Reporting Charge

**Transport Payment Plan Rates**

	<b>A</b>	<b>B</b>	<b>C</b>		
<b>Nonrecurring Charge<sup>2</sup></b>	<b>12-36</b>	<b>37-60</b>	<b>61-96</b>	<b>USOC</b>	
	<b>Mos</b>	<b>Mos</b>	<b>Mos</b>		
- Per Connection	\$ -	\$ 8.00	\$ 6.00	\$ 5.00	<b>MTERC</b>

- (c) CNM - Metro Ethernet Reporting, Web Interface Charge

- First

-      -      -      -      **MTER1**

- Each Additional

65.00      18.00      15.00      13.00      **MTERW**

- (d) CNM - Metro Ethernet Reporting, Security Card

**Nonrecurring Charge<sup>2</sup>**      **USOC**  
 \$ 200.00      **MTERS**

- Each

**Note 1:** Optional feature only available with a Premium or Virtual Connection.

**Note 2:** This nonrecurring charge is applicable to service under a TPP arrangement.

**Note 3:** Effective on or after August 22, 2021, this Service will no longer be available for purchase by new or existing customers. In addition, requests to move, add, change, or renew existing service arrangements will not be accepted. Following the expiration of a customer's existing term agreement, service will be provided on a month-to-month basis at the applicable Monthly rates until the service is discontinued. The Company currently plans to discontinue this service on or after March 31, 2023.

(N)

(N)

**E7. SPECIAL ACCESS (A.K.A. BELLSOUTH SPA) SERVICE**

**E7.5 Rates and Charges (Cont'd)**

**E7.5.22 BellSouth Metro Ethernet Service (Cont'd)<sup>4</sup>**

(C)

**B. Rates and charges for Transport Payment Plan (Cont'd)**

**12. Class of Service (CoS) Profile<sup>1</sup>**

(a) Real-Time CoS<sup>2</sup>

	Transport Payment Plan Rates				USOC
	Nonrecurring Charge <sup>3</sup>	A 12-36 Mos	B 37-60 Mos	C 61-96 Mos	
- 10%	\$ -	\$ 54.00	\$ 54.00	\$ 54.00	MTETF
- 20%	-	108.00	108.00	108.00	MTETG
- 25%	-	135.00	135.00	135.00	MTETH
- 30%	-	162.00	162.00	162.00	MTETJ
- 35%	-	189.00	189.00	189.00	MTETK
- 40%	-	216.00	216.00	216.00	MTETL
- 50%	-	270.00	270.00	270.00	MTETM
- 70%	-	378.00	378.00	378.00	MTETO

(b) Interactive CoS<sup>2</sup>

- 10%	-	45.00	45.00	45.00	MTEVF
- 20%	-	90.00	90.00	90.00	MTEVG
- 25%	-	112.00	112.00	112.00	MTEVH
- 30%	-	135.00	135.00	135.00	MTEVJ
- 35%	-	157.00	157.00	157.00	MTEVK
- 40%	-	180.00	180.00	180.00	MTEVL
- 50%	-	225.00	225.00	225.00	MTEVM

**Note 1:** Each Virtual Connection requires the designation of a CoS profile with desired percentages of each CoS selected. The sum of the percentages for all CoS selected for a Virtual Connection must sum to 100%..

**Note 2:** The combined CoS bandwidth percentages selected in a customer's Virtual Connection CoS profile for Real-Time CoS plus Interactive CoS may not exceed 50%, except where the customer selects the 70% Real-Time CoS bandwidth percentage and has no Interactive traffic.

**Note 3:** This nonrecurring charge is applicable to service under a TPP Arrangement.

**Note 4:** Effective on or after August 22, 2021, this Service will no longer be available for purchase by new or existing customers. In addition, requests to move, add, change, or renew existing service arrangements will not be accepted. Following the expiration of a customer's existing term agreement, service will be provided on a month-to-month basis at the applicable Monthly rates until the service is discontinued. The Company currently plans to discontinue this service on or after March 31, 2023.

(N)

(N)

**E7. SPECIAL ACCESS (A.K.A. BELLSOUTH SPA) SERVICE**

**E7.5 Rates and Charges (Cont'd)**

**E7.5.22 BellSouth Metro Ethernet Service (Cont'd)<sup>3</sup>**

(C)

**B. Rates and charges for Transport Payment Plan (Cont'd)**

**12. Class of Service (CoS) Profile<sup>1</sup> (Cont'd)**

(c) Business Critical CoS

	Transport Payment Plan Rates				USOC
	Nonrecurring Charge <sup>2</sup>	A	B	C	
		12-36 Mos	37-60 Mos	61-96 Mos	
- 10%	\$ -	\$ 27.00	\$ 27.00	\$ 27.00	MTEPF
- 20%	-	54.00	54.00	54.00	MTEPG
- 25%	-	67.00	67.00	67.00	MTEPH
- 30%	-	81.00	81.00	81.00	MTEPJ
- 35%	-	94.00	94.00	94.00	MTEPK
- 40%	-	108.00	108.00	108.00	MTEPL
- 50%	-	135.00	135.00	135.00	MTEPM
- 60%	-	162.00	162.00	162.00	MTEPN
- 75%	-	202.00	202.00	202.00	MTEPP
- 90%	-	243.00	243.00	243.00	MTEPQ
- 100%	-	270.00	270.00	270.00	MTEPR

(d) Best Effort CoS

- 10%	-	9.00	9.00	9.00	MTEBF
- 20%	-	18.00	18.00	18.00	MTEBG
- 25%	-	22.00	22.00	22.00	MTEBH
- 30%	-	27.00	27.00	27.00	MTEBJ
- 35%	-	31.00	31.00	31.00	MTEBK
- 40%	-	36.00	36.00	36.00	MTEBL
- 50%	-	45.00	45.00	45.00	MTEBM
- 60%	-	54.00	54.00	54.00	MTEBN
- 75%	-	67.00	67.00	67.00	MTEBP
- 90%	-	81.00	81.00	81.00	MTEBQ

**Note 1:** Each Virtual Connection requires the designation of a CoS profile with desired percentages of each CoS selected. The sum of the percentages for all CoS selected for a Virtual Connection must sum to 100%..

**Note 2:** This nonrecurring charge is applicable to service under a TPP Arrangement.

**Note 3:** Effective on or after August 22, 2021, this Service will no longer be available for purchase by new or existing customers. In addition, requests to move, add, change, or renew existing service arrangements will not be accepted. Following the expiration of a customer's existing term agreement, service will be provided on a month-to-month basis at the applicable Monthly rates until the service is discontinued. The Company currently plans to discontinue this service on or after March 31, 2023.

(N)  
 |  
 (N)

**E7. SPECIAL ACCESS (A.K.A. BELLSOUTH SPA) SERVICE**

**E7.5 Rates and Charges (Cont'd)**

**E7.5.22 BellSouth Metro Ethernet Service (Cont'd)<sup>4</sup>**

(C)

**B. Rates and charges for Transport Payment Plan (Cont'd)**

**13. Automatic Protection Switching (APS) Feature<sup>1</sup>:** Selected to provide automatic protection switching in conjunction with a Basic, Premium or Virtual BellSouth Metro Ethernet Connection of 10 Mbps or higher. Applicable APS rate element based upon type of APS selected and actual total route miles<sup>2</sup> (rounded up to next whole mile) based upon a customer-specific design as determined by the Telephone Company.

(a) Structural Protection

	<b>Transport Payment Plan Rates</b>				<b>USOC</b>
	<b>Nonrecurring Charge<sup>3</sup></b>	<b>A 12-36 Mos</b>	<b>B 37-60 Mos</b>	<b>C 61-96 Mos</b>	
- Per APS Arrangement of less than 10 route miles	\$ -	\$ 1250.00	\$ 1092.00	\$ 935.00	MTEAO
- Per APS Arrangement of 10 through 25 route miles	-	1496.00	1301.00	1126.00	MTEA1
- Per APS Arrangement of greater than 25 through 35 route miles	-	1798.00	1679.00	1530.00	MTEA2
- Per APS Arrangement of greater than 35 through 50 route miles	-	2452.00	2376.00	2134.00	MTEA3

(b) Route Protection

- Per APS Arrangement of less than 10 route miles	-	1470.00	1285.00	1100.00	MTEA5
- Per APS Arrangement of 10 through 25 route miles	-	1760.00	1530.00	1325.00	MTEA6
- Per APS Arrangement of greater than 25 through 35 route miles	-	2115.00	1975.00	1800.00	MTEA7
- Per APS Arrangement of greater than 35 through 50 route miles	-	2885.00	2795.00	2510.00	MTEA8

**14. Optical Termination Charge:** An electrical termination on the customer premises is standard for 2, 4 and 8 Mbps Basic, Premium and Virtual Connections. Therefore, an Optical Termination Charge applies when an optional optical termination is requested and provided for a 2, 4 or 8 Mbps Connection.

(a) Per Optical Termination

- Per Connection	-	30.00	30.00	30.00	MTEO1
------------------	---	-------	-------	-------	-------

**15. Service Reconfiguration Charge**

(a) Per Request

- Per Connection			<b>Nonrecurring Charge<sup>3</sup></b>	<b>USOC</b>
			<b>\$ 200.00</b>	<b>MTESR</b>

**16. System Reconfiguration Charge**

(a) Per Request

- Per Connection			<b>900.00</b>	<b>MTESY</b>
------------------	--	--	---------------	--------------

**Note 1:** Optional feature only available with a Basic, Premium or Virtual Connection.

**Note 2:** Per definition of route mileage provided in E7.2.18U preceding.

**Note 3:** This nonrecurring charge is applicable to service under a TPP arrangement.

**Note 4:** Effective on or after August 22, 2021, this Service will no longer be available for purchase by new or existing customers. In addition, requests to move, add, change, or renew existing service arrangements will not be accepted. Following the expiration of a customer's existing term agreement, service will be provided on a month-to-month basis at the applicable Monthly rates until the service is discontinued. The Company currently plans to discontinue this service on or after March 31, 2023.

(N)  
 |  
 (N)

BELLSOUTH  
TELECOMMUNICATIONS, INC.  
FLORIDA

ISSUED: October 8, 2008

BY: Marshall M. Criser III, President -FL  
Miami, Florida

Second Revised Page 1  
Cancels First Revised Page 1

EFFECTIVE: October 29, 2008

**E8. (DELETED)**

(D)

CONTENTS

BELLSOUTH  
TELECOMMUNICATIONS, INC.  
FLORIDA

ISSUED: October 8, 2008

BY: Marshall M. Criser III, President -FL  
Miami, Florida

First Revised Page 2  
Cancels Original Page 2

EFFECTIVE: October 29, 2008

**E8. (DELETED)**

(D)

CONTENTS

BELLSOUTH  
TELECOMMUNICATIONS, INC.  
FLORIDA

ACCESS SERVICES TARIFF

Third Revised Page 1  
Cancels Second Revised Page 1

ISSUED: October 8, 2008

EFFECTIVE: October 29, 2008

BY: Marshall M. Criser III, President -FL  
Miami, Florida

**E8. (DELETED)**

(D)



BELLSOUTH  
TELECOMMUNICATIONS, INC.  
FLORIDA

ACCESS SERVICES TARIFF

Third Revised Page 2  
Cancels Second Revised Page 2

ISSUED: October 8, 2008

EFFECTIVE: October 29, 2008

BY: Marshall M. Criser III, President -FL  
Miami, Florida

**E8. (DELETED)**

(D)

BELLSOUTH  
TELECOMMUNICATIONS, INC.  
FLORIDA

ISSUED: October 8, 2008

BY: Marshall M. Criser III, President -FL  
Miami, Florida

ACCESS SERVICES TARIFF

Second Revised Page 3  
Cancels First Revised Page 3

EFFECTIVE: October 29, 2008

**E8. (DELETED)**

(D)

BELLSOUTH  
TELECOMMUNICATIONS, INC.  
FLORIDA

ACCESS SERVICES TARIFF

First Revised Page 4  
Cancels Original Page 4

ISSUED: October 8, 2008

EFFECTIVE: October 29, 2008

BY: Marshall M. Criser III, President -FL  
Miami, Florida

**E8. (DELETED)**

(D)

BELLSOUTH  
TELECOMMUNICATIONS, INC.  
FLORIDA

ACCESS SERVICES TARIFF

First Revised Page 5  
Cancels Original Page 5

ISSUED: October 8, 2008

EFFECTIVE: October 29, 2008

BY: Marshall M. Criser III, President -FL  
Miami, Florida

**E8. (DELETED)**

(D)

BELLSOUTH  
TELECOMMUNICATIONS, INC.  
FLORIDA

ACCESS SERVICES TARIFF

First Revised Page 6  
Cancels Original Page 6

ISSUED: October 8, 2008

EFFECTIVE: October 29, 2008

BY: Marshall M. Criser III, President -FL  
Miami, Florida

**E8. (DELETED)**

(D)

BELLSOUTH  
TELECOMMUNICATIONS, INC.  
FLORIDA

ISSUED: October 8, 2008

BY: Marshall M. Criser III, President -FL  
Miami, Florida

ACCESS SERVICES TARIFF

First Revised Page 7  
Cancels Original Page 7

EFFECTIVE: October 29, 2008

**E8. (DELETED)**

(D)

BELLSOUTH  
TELECOMMUNICATIONS, INC.  
FLORIDA

ACCESS SERVICES TARIFF

First Revised Page 8  
Cancels Original Page 8

ISSUED: October 8, 2008

EFFECTIVE: October 29, 2008

BY: Marshall M. Criser III, President -FL  
Miami, Florida

**E8. (DELETED)**

(D)

BELLSOUTH  
TELECOMMUNICATIONS, INC.  
FLORIDA  
ISSUED: October 8, 2008  
BY: Marshall M. Criser III, President -FL  
Miami, Florida

ACCESS SERVICES TARIFF

Third Revised Page 9  
Cancels Second Revised Page 9

EFFECTIVE: October 29, 2008

**E8. (DELETED)**

(D)



BELLSOUTH  
TELECOMMUNICATIONS, INC.  
FLORIDA

ISSUED: October 8, 2008

BY: Marshall M. Criser III, President -FL  
Miami, Florida

ACCESS SERVICES TARIFF

Third Revised Page 10  
Cancels Second Revised Page 10

EFFECTIVE: October 29, 2008

**E8. (DELETED)**

(D)

BELLSOUTH  
TELECOMMUNICATIONS, INC.

FLORIDA

ISSUED: October 8, 2008

BY: Marshall M. Criser III, President -FL  
Miami, Florida

ACCESS SERVICES TARIFF

First Revised Page 11  
Cancels Original Page 11

EFFECTIVE: October 29, 2008

**E8. (DELETED)**

(D)

BELLSOUTH  
TELECOMMUNICATIONS, INC.  
FLORIDA  
ISSUED: October 8, 2008  
BY: Marshall M. Criser III, President -FL  
Miami, Florida

ACCESS SERVICES TARIFF

First Revised Page 12  
Cancels Original Page 12

EFFECTIVE: October 29, 2008

**E8. (DELETED)**

(D)

BELLSOUTH  
TELECOMMUNICATIONS, INC.  
FLORIDA  
ISSUED: October 8, 2008  
BY: Marshall M. Criser III, President -FL  
Miami, Florida

ACCESS SERVICES TARIFF

First Revised Page 13  
Cancels Original Page 13

EFFECTIVE: October 29, 2008

**E8. (DELETED)**

(D)

BELLSOUTH  
TELECOMMUNICATIONS, INC.  
FLORIDA

ACCESS SERVICES TARIFF

Second Revised Page 14  
Cancels First Revised Page 14

ISSUED: October 8, 2008

EFFECTIVE: October 29, 2008

BY: Marshall M. Criser III, President -FL  
Miami, Florida

**E8. (DELETED)**

(D)

BELLSOUTH  
TELECOMMUNICATIONS, INC.  
FLORIDA

ACCESS SERVICES TARIFF

Second Revised Page 15  
Cancels First Revised Page 15

ISSUED: October 8, 2008

EFFECTIVE: October 29, 2008

BY: Marshall M. Criser III, President -FL  
Miami, Florida

**E8. (DELETED)**

(D)

BELLSOUTH  
TELECOMMUNICATIONS, INC.  
FLORIDA

ISSUED: October 8, 2008

BY: Marshall M. Criser III, President -FL  
Miami, Florida

ACCESS SERVICES TARIFF

Second Revised Page 16  
Cancels First Revised Page 16

EFFECTIVE: October 29, 2008

**E8. (DELETED)**

(D)

BELLSOUTH  
TELECOMMUNICATIONS, INC.  
FLORIDA

ISSUED: October 8, 2008

BY: Marshall M. Criser III, President -FL  
Miami, Florida

ACCESS SERVICES TARIFF

Third Revised Page 17  
Cancels Second Revised Page 17

EFFECTIVE: October 29, 2008

**E8. (DELETED)**

(D)



BELLSOUTH  
TELECOMMUNICATIONS, INC.  
FLORIDA

ISSUED: October 8, 2008

BY: Marshall M. Criser III, President -FL  
Miami, Florida

ACCESS SERVICES TARIFF

Second Revised Page 18  
Cancels First Revised Page 18

EFFECTIVE: October 29, 2008

**E8. (DELETED)**

(D)

BELLSOUTH  
TELECOMMUNICATIONS, INC.  
FLORIDA

ACCESS SERVICES TARIFF

Second Revised Page 19  
Cancels First Revised Page 19

ISSUED: October 8, 2008

EFFECTIVE: October 29, 2008

BY: Marshall M. Criser III, President -FL  
Miami, Florida

**E8. (DELETED)**

(D)

BELLSOUTH  
TELECOMMUNICATIONS, INC.  
FLORIDA

ISSUED: October 8, 2008

BY: Marshall M. Criser III, President -FL  
Miami, Florida

ACCESS SERVICES TARIFF

Second Revised Page 20  
Cancels First Revised Page 20

EFFECTIVE: October 29, 2008

**E8. (DELETED)**

(D)

BELLSOUTH  
TELECOMMUNICATIONS, INC.  
FLORIDA  
ISSUED: October 8, 2008  
BY: Marshall M. Criser III, President -FL  
Miami, Florida

ACCESS SERVICES TARIFF

Third Revised Page 21  
Cancels Second Revised Page 21

EFFECTIVE: October 29, 2008

**E8. (DELETED)**

(D)

BELLSOUTH  
TELECOMMUNICATIONS, INC.  
FLORIDA

ISSUED: October 8, 2008

BY: Marshall M. Criser III, President -FL  
Miami, Florida

ACCESS SERVICES TARIFF

Second Revised Page 22  
Cancels First Revised Page 22

EFFECTIVE: October 29, 2008

**E8. (DELETED)**

(D)

BELLSOUTH  
TELECOMMUNICATIONS, INC.  
FLORIDA

ACCESS SERVICES TARIFF

Third Revised Page 23  
Cancels Second Revised Page 23

ISSUED: October 8, 2008

EFFECTIVE: October 29, 2008

BY: Marshall M. Criser III, President -FL  
Miami, Florida

**E8. (DELETED)**

(D)

BELLSOUTH  
TELECOMMUNICATIONS, INC.  
FLORIDA

ISSUED: October 8, 2008

BY: Marshall M. Criser III, President -FL  
Miami, Florida

ACCESS SERVICES TARIFF

Third Revised Page 24  
Cancels Second Revised Page 24

EFFECTIVE: October 29, 2008

**E8. (DELETED)**

(D)

BELLSOUTH  
TELECOMMUNICATIONS, INC.  
FLORIDA

ACCESS SERVICES TARIFF

Second Revised Page 25  
Cancels First Revised Page 25

ISSUED: October 8, 2008

EFFECTIVE: October 29, 2008

BY: Marshall M. Criser III, President -FL  
Miami, Florida

**E8. (DELETED)**

(D)



BELLSOUTH  
TELECOMMUNICATIONS, INC.  
FLORIDA

ACCESS SERVICES TARIFF

First Revised Page 26  
Cancels Original Page 26

ISSUED: October 8, 2008

EFFECTIVE: October 29, 2008

BY: Marshall M. Criser III, President -FL  
Miami, Florida

**E8. (DELETED)**

(D)

BELLSOUTH  
TELECOMMUNICATIONS, INC.  
FLORIDA

ACCESS SERVICES TARIFF

Second Revised Page 27  
Cancels First Revised Page 27

ISSUED: October 8, 2008

EFFECTIVE: October 29, 2008

BY: Marshall M. Criser III, President -FL  
Miami, Florida

**E8. (DELETED)**

(D)

BELLSOUTH  
TELECOMMUNICATIONS, INC.  
FLORIDA

ISSUED: October 8, 2008

BY: Marshall M. Criser III, President -FL  
Miami, Florida

ACCESS SERVICES TARIFF

Third Revised Page 28  
Cancels Second Revised Page 28

EFFECTIVE: October 29, 2008

**E8. (DELETED)**

(D)

BELLSOUTH  
TELECOMMUNICATIONS, INC.  
FLORIDA

ISSUED: October 8, 2008

BY: Marshall M. Criser III, President -FL  
Miami, Florida

ACCESS SERVICES TARIFF

Third Revised Page 29  
Cancels Second Revised Page 29

EFFECTIVE: October 29, 2008

**E8. (DELETED)**

(D)

BELLSOUTH  
TELECOMMUNICATIONS, INC.  
FLORIDA  
ISSUED: October 8, 2008  
BY: Marshall M. Criser III, President -FL  
Miami, Florida

ACCESS SERVICES TARIFF

First Revised Page 30  
Cancels Original Page 30

EFFECTIVE: October 29, 2008

**E8. (DELETED)**

(D)

BELLSOUTH  
TELECOMMUNICATIONS, INC.  
FLORIDA

ACCESS SERVICES TARIFF

First Revised Page 31  
Cancels Original Page 31

ISSUED: October 8, 2008

EFFECTIVE: October 29, 2008

BY: Marshall M. Criser III, President -FL  
Miami, Florida

**E8. (DELETED)**

(D)

BELLSOUTH  
TELECOMMUNICATIONS, INC.  
FLORIDA

ISSUED: October 8, 2008

BY: Marshall M. Criser III, President -FL  
Miami, Florida

ACCESS SERVICES TARIFF

First Revised Page 32  
Cancels Original Page 32

EFFECTIVE: October 29, 2008

**E8. (DELETED)**

(D)

BELLSOUTH  
TELECOMMUNICATIONS, INC.  
FLORIDA  
ISSUED: October 8, 2008  
BY: Marshall M. Criser III, President -FL  
Miami, Florida

ACCESS SERVICES TARIFF

First Revised Page 33  
Cancels Original Page 33

EFFECTIVE: October 29, 2008

**E8. (DELETED)**

(D)



BELLSOUTH  
TELECOMMUNICATIONS, INC.  
FLORIDA

ISSUED: October 8, 2008

BY: Marshall M. Criser III, President -FL  
Miami, Florida

ACCESS SERVICES TARIFF

First Revised Page 34  
Cancels Original Page 34

EFFECTIVE: October 29, 2008

**E8. (DELETED)**

(D)

BELLSOUTH  
TELECOMMUNICATIONS, INC.  
FLORIDA

ACCESS SERVICES TARIFF

Second Revised Page 35  
Cancels First Revised Page 35

ISSUED: October 8, 2008

EFFECTIVE: October 29, 2008

BY: Marshall M. Criser III, President -FL  
Miami, Florida

**E8. (DELETED)**

(D)

BELLSOUTH  
TELECOMMUNICATIONS, INC.  
FLORIDA  
ISSUED: October 8, 2008  
BY: Marshall M. Criser III, President -FL  
Miami, Florida

ACCESS SERVICES TARIFF

Second Revised Page 36  
Cancels First Revised Page 36

EFFECTIVE: October 29, 2008

**E8. (DELETED)**

(D)

BELLSOUTH  
TELECOMMUNICATIONS, INC.  
FLORIDA

ISSUED: October 8, 2008

BY: Marshall M. Criser III, President -FL  
Miami, Florida

ACCESS SERVICES TARIFF

Second Revised Page 37  
Cancels First Revised Page 37

EFFECTIVE: October 29, 2008

**E8. (DELETED)**

(D)

BELLSOUTH  
TELECOMMUNICATIONS, INC.  
FLORIDA

ISSUED: October 8, 2008

BY: Marshall M. Criser III, President -FL  
Miami, Florida

ACCESS SERVICES TARIFF

Second Revised Page 38  
Cancels First Revised Page 38

EFFECTIVE: October 29, 2008

**E8 (DELETED)**

(D)

BELLSOUTH  
TELECOMMUNICATIONS, INC.  
FLORIDA

ISSUED: October 8, 2008

BY: Marshall M. Criser III, President -FL  
Miami, Florida

ACCESS SERVICES TARIFF

Second Revised Page 39  
Cancels First Revised Page 39

EFFECTIVE: October 29, 2008

**E8. (DELETED)**

(D)

BELLSOUTH  
TELECOMMUNICATIONS, INC.  
FLORIDA

ACCESS SERVICES TARIFF

Second Revised Page 40  
Cancels First Revised Page 40

ISSUED: October 8, 2008

EFFECTIVE: October 29, 2008

BY: Marshall M. Criser III, President -FL  
Miami, Florida

**E8. (DELETED)**

(D)

BELLSOUTH  
TELECOMMUNICATIONS, INC.  
FLORIDA

ISSUED: October 8, 2008

BY: Marshall M. Criser III, President -FL  
Miami, Florida

ACCESS SERVICES TARIFF

Second Revised Page 41  
Cancels First Revised Page 41

EFFECTIVE: October 29, 2008

**E8. (DELETED)**

(D)



BELLSOUTH  
TELECOMMUNICATIONS, INC.  
FLORIDA  
ISSUED: October 8, 2008  
BY: Marshall M. Criser III, President -FL  
Miami, Florida

ACCESS SERVICES TARIFF

Second Revised Page 42  
Cancels First Revised Page 42

EFFECTIVE: October 29, 2008

**E8. (DELETED)**

(D)

BELLSOUTH  
TELECOMMUNICATIONS, INC.  
FLORIDA

ACCESS SERVICES TARIFF

First Revised Page 43  
Cancels Original Page 43

ISSUED: October 8, 2008

EFFECTIVE: October 29, 2008

BY: Marshall M. Criser III, President -FL  
Miami, Florida

**E8. (DELETED)**

(D)

BELLSOUTH  
TELECOMMUNICATIONS, INC.  
FLORIDA

ACCESS SERVICES TARIFF

First Revised Page 44  
Cancels Original Page 44

ISSUED: October 8, 2008

EFFECTIVE: October 29, 2008

BY: Marshall M. Criser III, President -FL  
Miami, Florida

**E8. (DELETED)**

(D)

BELLSOUTH  
TELECOMMUNICATIONS, INC.  
FLORIDA

ISSUED: October 8, 2008

BY: Marshall M. Criser III, President -FL  
Miami, Florida

ACCESS SERVICES TARIFF

First Revised Page 45  
Cancels Original Page 45

EFFECTIVE: October 29, 2008

**E8. (DELETED)**

(D)

BELLSOUTH  
TELECOMMUNICATIONS, INC.  
FLORIDA

ISSUED: October 8, 2008

BY: Marshall M. Criser III, President -FL  
Miami, Florida

ACCESS SERVICES TARIFF

First Revised Page 46  
Cancels Original Page 46

EFFECTIVE: October 29, 2008

**E8. (DELETED)**

(D)

BELLSOUTH  
TELECOMMUNICATIONS, INC.  
FLORIDA

ISSUED: October 8, 2008

BY: Marshall M. Criser III, President -FL  
Miami, Florida

ACCESS SERVICES TARIFF

Second Revised Page 47  
Cancels First Revised Page 47

EFFECTIVE: October 29, 2008

**E8. (DELETED)**

(D)

BELLSOUTH  
TELECOMMUNICATIONS, INC.  
FLORIDA  
ISSUED: October 8, 2008  
BY: Marshall M. Criser III, President -FL  
Miami, Florida

ACCESS SERVICES TARIFF

Second Revised Page 48  
Cancels First Revised Page 48

EFFECTIVE: October 29, 2008

**E8. (DELETED)**

(D)

BELLSOUTH  
TELECOMMUNICATIONS, INC.  
FLORIDA

ACCESS SERVICES TARIFF

First Revised Page 49  
Cancels Original Page 49

ISSUED: October 8, 2008

EFFECTIVE: October 29, 2008

BY: Marshall M. Criser III, President -FL  
Miami, Florida

**E8. (DELETED)**

(D)



BELLSOUTH  
TELECOMMUNICATIONS, INC.  
FLORIDA

ISSUED: October 8, 2008

BY: Marshall M. Criser III, President -FL  
Miami, Florida

ACCESS SERVICES TARIFF

Third Revised Page 50  
Cancels Second Revised Page 50

EFFECTIVE: October 29, 2008

**E8. (DELETED)**

(D)

BELLSOUTH  
TELECOMMUNICATIONS, INC.  
FLORIDA

ACCESS SERVICES TARIFF

Third Revised Page 51  
Cancels Second Revised Page 51

ISSUED: October 8, 2008

EFFECTIVE: October 29, 2008

BY: Marshall M. Criser III, President -FL  
Miami, Florida

**E8. (DELETED)**

(D)

BELLSOUTH  
TELECOMMUNICATIONS, INC.  
FLORIDA

ACCESS SERVICES TARIFF

First Revised Page 52  
Cancels Original Page 52

ISSUED: October 8, 2008

EFFECTIVE: October 29, 2008

BY: Marshall M. Criser III, President -FL  
Miami, Florida

**E8. (DELETED)**

(D)

BELLSOUTH  
TELECOMMUNICATIONS, INC.  
FLORIDA

ACCESS SERVICES TARIFF

First Revised Page 53  
Cancels Original Page 53

ISSUED: October 8, 2008

EFFECTIVE: October 29, 2008

BY: Marshall M. Criser III, President -FL  
Miami, Florida

**E8. (DELETED)**

(D)

## E9. BELLSOUTH DIRECTORY ASSISTANCE ACCESS SERVICE

### CONTENTS

<b>E9.1</b>	<b>General Description</b>	1	
E9.1.1	Provision of Service	1	
<b>E9.2</b>	<b>Undertaking of the Company</b>	1	
E9.2.1	Number Provision	1	
E9.2.2	Access Locations and Call Transport	1	
<b>E9.3</b>	<b>Obligations of the IC</b>	5	
E9.3.1	Ordering Requirements	5	
E9.3.2	End User Requirements	5	
<b>E9.4</b>	<b>Payment Arrangements</b>	5	
E9.4.1	Minimum Periods and Minimum Monthly Charge	5	
E9.4.2	Reserved For Future Use	6	
E9.4.3	Cancellation of a Special Order	6	
E9.4.4	Changes to Special Orders	6	
E9.4.5	Moves	6	
E9.4.6	BellSouth Directory Assistance Access Service Rearrangements	6	
E9.4.7	Credit Allowance for BellSouth Directory Assistance Access Service	6	
<b>E9.5</b>	<b>Rate Regulations and Charges</b>	7	
E9.5.1	Rate Regulations	7	
E9.5.2	Rate Categories	7	
E9.5.3	Rates and charges	8	
<b>E9.6</b>	<b>BellSouth DA Flat Rated Trunks</b>	9	(N)
E9.6.1	General Description	9	(N)
E9.6.2	Rates And Charges	9	(N)

## E9. BELLSOUTH DIRECTORY ASSISTANCE ACCESS SERVICE

### E9.1 General Description

#### E9.1.1 Provision of Service

- A. The Company will provide automated *BellSouth* Directory Assistance Access service to an IC from *BellSouth* Directory Assistance *Access* service locations. (C)
- B. *BellSouth* Directory Assistance Access service provides: (1) automated *BellSouth* Directory Assistance Access service to *BellSouth* Directory Assistance *Access* service locations; (2) the use of *BellSouth* Directory Assistance *Access* service equipment; and (3) *BellSouth* Directory Assistance *Access* when required to provide telephone numbers or a report that a number is non-published. (C)  
(C)  
(C)

### E9.2 Undertaking of the Company

#### E9.2.1 Number Provision

- A. Automated Directory Assistance service, when furnished a city, state and name, will provide or attempt to provide the telephone number listed in the Company Directory Assistance records associated with the name given at the rates and charges as set forth in Section E9.5. The Company's contact with the IC's end user shall be limited to that effort necessary to process an IC's end user's request for a telephone number. The Company will not transfer, forward or redial an IC's end user call to any other location for any purpose other than provision of automated *BellSouth* Directory Assistance Access service. (C)  
(T)  
(C)
- B. A maximum of three (3) requests for telephone numbers will be accepted per call to the automated *BellSouth* Directory Assistance *Access* service. (C)  
(C)
- C. A telephone number which is not listed in automated *BellSouth* Directory Assistance *Access* records will not be available to the IC's end user. (C)

#### E9.2.2 Access Locations and Call Transport

- A. The Company will specify the *BellSouth* Directory Assistance Access service location which provides the automated *BellSouth* Directory Assistance Access service for each Numbering Plan Area Code (NPA). The *BellSouth* Directory Assistance *Access* service locations are as shown in National Exchange Carrier Association Tariff FCC No. 4. (C)  
(C)  
When it becomes necessary, as determined by the Company, to change a *BellSouth* Directory Assistance *Access* service location, the Company will notify the involved ICs six months prior to the change. For such changes, the regulations as set forth in Section E2.1.7 apply. (T)
- B. Automated *BellSouth* Directory Assistance Access service will be provided between the IC terminal location and the *BellSouth* Directory Assistance *Access* service location by the Company at rates and charges as set forth in Section E9.5 and as follows: (C)  
(T)
  - 1. *BellSouth* Directory Assistance Access service
    - a. Each *BellSouth* Directory Assistance Access service will consist of the following:
      - (1) An Interface Group equipped with an available Premises Interface Code at the IC terminal location.
      - (2) Directory Transport between the IC terminal location serving wire center and the *BellSouth* Directory Assistance *Access* service location.

ISSUED: February 14, 1997  
BY: Joseph P. Lacher, President -FL  
Miami, Florida

EFFECTIVE: March 1, 1997

## E9. BELLSOUTH DIRECTORY ASSISTANCE ACCESS SERVICE (T)

### E9.2 Undertaking of the Company (Cont'd)

#### E9.2.2 Access Locations and Call Transport (Cont'd)

B. *BellSouth* Directory Assistance Access service will be provided between the IC terminal location and the *BellSouth* Directory Assistance *Access* service location by the Company at rates and charges as set forth in E9.5 following and as follows: (Cont'd) (T)

1. *BellSouth* Directory Assistance Access service (Cont'd) (T)

b. When required by the Company, a separate *BellSouth* Directory Assistance Access service trunk group will be provided for *BellSouth* Directory Assistance Access service for each NPA. Separate trunk groups will be required when the Company notifies the IC that the mechanized search of its data base and its mechanized operator practices require a mechanized identification of the NPA code for which the IC's end user desires Directory Assistance information. (T)

2. Interface Group and Premises Interface Code

a. Each *BellSouth* Directory Assistance Access service will consist of a *BellSouth SWA* service equipped with one of the following *BellSouth SWA* service Premises Interface Codes as described in E6.1.3.A. preceding: (T)

4DS9-15	6EA2-E	4RV2-0
2RV3-0	6EA2-M	
4DS6-44	4SF3	

Except as set forth in E9.4.1.A. following, the Interface Groups and Premises Interface Codes provided under a Special Order for *BellSouth* Directory Assistance Access service are subject to the order conditions as set forth in Section E5. preceding. For purposes of applying the order regulations, a *BellSouth* Directory Assistance *Access* service location is considered to be an IC's end user serving wire center. (T)

3. Directory Transport

a. Directory Transport provides the transmission facilities and transport termination between the IC terminal location and the *BellSouth* Directory Assistance *Access* service location. (T)

b. Directory Transport is a two-way voice frequency transmission path composed of *BellSouth SWA* Transport facilities as set forth in E6.1.3 preceding. The two-way voice frequency path transports calls in the terminating direction (from the IC terminal location to the *BellSouth* Directory Assistance *Access* service location). The voice frequency transmission path may be comprised of any configuration of plant capable of and typically used in the telecommunications industry for the transmission of voice and associated telephone signals within the frequency band width of approximately 300 to 3000 Hz. (T)

c. Directory Transport facilities are specified by the IC and include the following rate categories. These rate categories are further defined in Section E6., *BellSouth SWA* service. (T)

(1) Switched Local Channel must be specified by the IC. This facility is used in the transport of the *BellSouth Directory Assistance Access* service call from the IC's premises to the Company's Serving Wire Center (SWC). The Switched Local Channel is assessed a monthly rate based on capacity. (T)

## E9. BELLSOUTH DIRECTORY ASSISTANCE ACCESS SERVICE

### E9.2 Undertaking of the Company (Cont'd)

#### E9.2.2 Access Locations and Call Transport (Cont'd)

- B. BellSouth Directory Assistance Access service will be provided between the IC terminal location and the BellSouth Directory Assistance Access service location by the Company at rates and charges as set forth in E9.5 following and as follows: (Cont'd)

3. Directory Transport (Cont'd)

- c. Directory Transport facilities are specified by the IC and include the following rate categories. These rate categories are further defined in Section E6. *of this Tariff*, BellSouth SWA service. (Cont'd)

- (2) Switched Interoffice Channel, either Common or Dedicated must be specified by the IC.

Switched Dedicated Interoffice Channels (SW DIOC) are used for the transport of the BellSouth Directory Assistance Access service call to the BellSouth Directory Assistance Access location without utilizing a Company Access Tandem Switch or for the transport of the call to the Access Tandem where *an* Access Tandem *is utilized*. The SW DIOC is assessed a monthly rate, per mile, based on the capacity ordered by the IC.

Where a Company Access Tandem is utilized, Switched Common Interoffice Channels (SW CIOC) are used for the transport of the BellSouth Directory Assistance Access service call from the Company Access Tandem Switch *to the BellSouth Directory Assistance Access Location*. The SW CIOC charge is assessed on a per call basis.

For BellSouth SWA Common Transport, the DS3 to DS1 Multiplexer element is applicable. This element provides for use of DS3 to DS1 multiplexer equipment between the Company Access Tandem switch and the BellSouth Directory Assistance Access Location.

- (3) Access Tandem Switching provides for the function of the Access Tandem when routing the call from the IC's SWC to the BellSouth Directory Assistance Access location through the Access Tandem. A rate per call will be assessed for each BellSouth Directory Assistance Access call that traverses the Access Tandem.

- d. As specified by the IC, BellSouth Directory Assistance Access service is to be routed directly to a BellSouth Directory Assistance Access service location or through an access tandem switch appropriately equipped for BellSouth Directory Assistance Access measurement and served by BellSouth Directory Assistance Access trunks to the BellSouth Directory Assistance Access location when such an access tandem switch is available in combination with BellSouth SWA FGB, BellSouth SWA FGD or BellSouth SWA TSBSA as a separate BellSouth Directory Assistance Access service Trunk Group. The combination of BellSouth SWA FGB, BellSouth SWA FGD or BellSouth SWA TSBSA service with BellSouth Directory Assistance Access service will only be provided at such available and appropriately equipped access tandem switches. All BellSouth Directory Assistance Access calls routed via this combination to the access tandem will be completed to the BellSouth Directory Assistance Access location and subject to the charges set forth in E9.5 following. If the IC does not want BellSouth Directory Assistance Access calls completed to the BellSouth Directory Assistance Access location via this combination, the IC may block the call.

(D)  
(D)  
(D)

- e. When Directory Transport is provided, multifrequency address signaling is required with wink start-start pulsing signals provided. The IC shall address each call to the BellSouth Directory Assistance Access service location using NPA+555+1212 or when required by the Company, 555-1212. Only NPA codes handled by the BellSouth Directory Assistance Access service location will be processed.

- f. Directory Transport is provided with one of the BellSouth SWA Transport Interface Groups as set forth in Section E6. preceding.

4. Special Facilities Routing

An IC may request that BellSouth Directory Assistance Access service be provided via Special Facilities Routing. The regulations, rates and charges for Special Routing (Avoidance, Diversity and Cable Only) are as set forth in Section E11. *of this Tariff*.



ISSUED: December 19, 2013

EFFECTIVE: December 20, 2013

BY: Marshall M. Criser III, President -FL  
Miami, Florida

## E9. BELLSOUTH DIRECTORY ASSISTANCE ACCESS SERVICE

### E9.2 Undertaking of the Company (Cont'd)

#### E9.2.2 Access Locations and Call Transport (Cont'd)

- B.** *BellSouth* Directory Assistance Access service will be provided between the IC terminal location and the *BellSouth* Directory Assistance *Access* service location by the Company at rates and charges as set forth in E9.5 following and as follows: (Cont'd)

5. Design Layout Report

The Company will provide to the IC the makeup of the facilities and services provided under this section as *BellSouth* Directory Assistance Access service. This information will be provided in the form of a Design Layout Report similar to that as set forth in E6.1.5. Design Layout Reports for *BellSouth* Directory Assistance Access service will be provided only when specifically requested by the IC. The Design Layout Report will be provided to the IC at no charge and will be reissued or updated whenever the facilities provided for the IC's use are materially changed.

6. Transmission Specifications

*BellSouth* Directory Assistance Access service is provided with either Type A, B or C Transmission specifications. The specifications associated with these parameters are guaranteed to the *BellSouth* Directory Assistance Access location, whether routed directly or via an access tandem. Type C Transmission Specification is provided with Interface Group 1 when routed directly to a *BellSouth* Directory Assistance Access service location. Type B Transmission Specification is provided with Interface Groups 2, 6 and/or 9 when routed direct to a *BellSouth* Directory Assistance Access service location. Type A Transmission Specification is provided with Interface Groups 2, 6 and/or 9 when routed via an access tandem switch.

When *BellSouth* Directory Assistance Access service is provided with *BellSouth SWA FGD* or *BellSouth SWA* TSBSA 3 service, Type A Transmission Specification is provided. When *BellSouth* Directory Assistance Access service is provided with *BellSouth SWA FGB* or *BellSouth SWA* TSBSA 1 service, Type B Transmission Specification is provided for Interface Groups 2, 6 and 9 and Type C Transmission Specification is provided for Interface Group 1.

Type A, B and C Transmission Specifications are set forth in E6.4.1 preceding.

7. Acceptance Testing and Testing Capabilities

The acceptance testing and testing capabilities for *BellSouth* Directory Assistance Access service traffic routed through an access tandem are the same as those for the associated *BellSouth SWA FGD* or *BellSouth SWA* TSBSA 3 end office switching. The acceptance testing for *BellSouth* Directory Assistance Access service traffic routed directly to or routed in a separate trunk group through an access tandem to the *BellSouth* Directory Assistance Access service location will be as set forth in E6.1.6 preceding. The testing capabilities for *BellSouth* Directory Assistance Access service traffic routed directly to the *BellSouth* Directory Assistance Access service location, or routed in a separate trunk group through an access tandem to the *BellSouth* Directory Assistance Access service location will be as set forth for cooperative scheduled testing or manual scheduled testing in Section E13. following.

- C.** Trunk-side switching is provided at the *BellSouth* Directory Assistance Access service location. The *BellSouth* Directory Assistance Access service location will provide trunk answer and disconnect supervisory signaling.

(D)  
(D)

(D)

## E9. BELLSOUTH DIRECTORY ASSISTANCE ACCESS SERVICE

### E9.2 Undertaking of the Company (Cont'd)

#### E9.2.2 Access Locations and Call Transport (Cont'd)

- D. The Company will distribute the calls received over the automated *BellSouth* Directory Assistance Access services using the *BellSouth Directory Assistance Access* service location equipment. (C)  
(D)
- E. In the event that the telephone number is unavailable to automated *BellSouth* Directory Assistance *Access*, no credit applies for the charge for the call to automated *BellSouth Directory Assistance Access*. When the *BellSouth Directory Assistance Access* service location or *BellSouth Directory Assistance Access* service equipment or terminals are out of service due to a Company equipment failure, or an incorrect number is provided, a credit as set forth in Section E9.4.7 will apply. (C)  
(C)  
(C)  
(T)
- F. *Automated BellSouth* Directory Assistance Access service may be provided, at the option of the IC, for interstate and intrastate communications. When the IC requests such mixed access, the intrastate *BellSouth Directory Assistance Access* service charges will be determined by the Company as set forth in Section E2.3.15. (C)  
(T)

### E9.3 Obligations of the IC

#### E9.3.1 Ordering Requirements

- A. The IC shall determine and order the capacity and interface type of *BellSouth* Directory Assistance Access services it needs except when provided over existing *BellSouth SWA FGA*, *BellSouth SWA FGB*, *BellSouth SWA FGD*, *BellSouth SWA LSBSA* or *BellSouth SWA TSBSA* Transport facilities, as specified in Section E9.2.2.B.3 for automated *BellSouth Directory Assistance Access* service. (C)  
(C)
- B. The IC facilities at the IC terminal location shall provide the necessary on-hook and off-hook supervision. (C)
- C. When requested by the Company, the IC shall order a separate trunk group for automated *BellSouth Directory Assistance Access* service for each NPA. The conditions when the IC will be requested to order separate trunk groups for each NPA are set forth in Section E9.2.2.B. (C)  
(T)

#### E9.3.2 End User Requirements

- A. When the IC bills its end users, the IC shall be responsible for all contacts and arrangements with its end users concerning the provision and maintenance of, and the billing and collecting of charges for, automated *BellSouth* Directory Assistance Access service furnished to its end users. When the Company bills the IC's end users at the request of the IC, contacts and arrangements with the IC's end users concerning the billing and collecting of charges will be as set forth in Section E8.2. (C)  
(T)
- B. The IC understands that automated *BellSouth* Directory Assistance *Access* service will respond to only three (3) telephone number requests per call and will not transfer, forward or redial the call to another location for any purpose other than the provision of automated *BellSouth* Directory Assistance Access service. (C)  
(C)

### E9.4 Payment Arrangements

#### E9.4.1 Minimum Periods and Minimum Monthly Charge

- A. The minimum period for which automated *BellSouth* Directory Assistance Access service is provided and for which charges apply is one month. (C)

## E9. BELLSOUTH DIRECTORY ASSISTANCE ACCESS SERVICE

### E9.4 Payment Arrangements (Cont'd)

#### E9.4.1 Minimum Periods and Minimum Monthly Charge (Cont'd)

- B. Automated *BellSouth* Directory Assistance Access service is subject to a minimum monthly charge if *BellSouth SWA* Dedicated Transport is utilized. If *BellSouth SWA* Common Transport is ordered for automated *BellSouth Directory Assistance* Access service, the minimum monthly charge for *BellSouth Directory Assistance* Access service calls is the charge as set forth in Section E9.5 for the actual usage for the month. (C)  
(C)  
(T)

#### E9.4.2 Reserved for Future Use

#### E9.4.3 Cancellation of a Special Order

- A. When an IC cancels a Special Order for automated *BellSouth* Directory Assistance Access service after the order date but prior to the start of service, the appropriate charges as set forth in Section E5. for *BellSouth SWA* services apply for the automated *BellSouth Directory Assistance* Access service cancelled. (C)  
(D)  
(C)

#### E9.4.4 Changes to Special Orders

When an IC requests changes to a pending order for automated *BellSouth* Directory Assistance Access service, such changes will be undertaken if they can be accommodated by the Company. The appropriate charges as set forth in Section E5 for *BellSouth SWA* services apply for the automated *BellSouth Directory Assistance* Access service changed. (C)  
(C)

#### E9.4.5 Moves

A move involves a change in the physical location of the point of termination at the IC terminal location or the IC terminal location. Moves will be treated as set forth in Section 6 of FCC Tariff No. 1 and all associated nonrecurring charges will apply. Minimum period requirements will be established at the new location as set forth in Section 6 of FCC Tariff No. 1. The IC will also remain responsible for satisfying all outstanding minimum period charges for the discontinued service. (T)  
(T)

#### E9.4.6 BellSouth Directory Assistance Access Service Rearrangements

Nonrecurring charges apply for service rearrangements are as set forth in Section 6 of Tariff FCC No. 1. The service Rearrangement Charges are as set forth in Section 6 of Tariff FCC No. 1 for the type of change provided by the Company. (T)  
(T)

#### E9.4.7 Credit Allowance for BellSouth Directory Assistance Access Service

- A. When the *BellSouth* Directory Assistance Access service location or *BellSouth Directory Assistance Access* equipment or terminals are out of service due to a Company equipment failure or an incorrect number is provided and an IC's end user's automated *BellSouth Directory Assistance Access* call has been connected to a automated *BellSouth Directory Assistance Access* service, a credit allowance for a call connected to the automated *BellSouth Directory Assistance Access* service equal to the rate for a *BellSouth Directory Assistance* Access service call as set forth in Section E9.5 will be applied to the IC's charges. (D)  
(C)  
(C)  
(C)

## E9. BELLSOUTH DIRECTORY ASSISTANCE ACCESS SERVICE

### E9.4 Payment Arrangements (Cont'd)

#### E9.4.7 Credit Allowance for BellSouth Directory Assistance Access Service (Cont'd)

- B. In addition to the credit as set forth in A. preceding, when a automated *BellSouth* Directory Assistance *Access* service provides an incorrect number for a call and the IC reports such occurrences to the Company, a credit allowance for such automated *BellSouth Directory Assistance Access* call will apply. When the IC reports such a call and the number requested, the number provided and the reason the number provided is incorrect, the number of calls for which a credit will apply will be developed by the Company in cooperation with the IC. The credit allowance is equal to the amounts charged for *BellSouth Directory Assistance Access* service call as set forth in Section E9.5. (C)  
(D)  
(C)  
(D)  
(T)
- C. When automated *BellSouth* Directory Assistance *Access* call is not completed due to the failure of automated *BellSouth Directory Assistance Access* service to *BellSouth Directory Assistance Access* locations, automated *BellSouth Directory Assistance Access* equipment or *BellSouth Directory Assistance Access* operator activities, a credit allowance for the *BellSouth SWA* service portion in the originating LATA of such automated *BellSouth Directory Assistance Access* call will apply. When the IC reports such a call and number dialed, time of the call and the date of the call, the number of calls for which a credit will apply will be developed by the Company in cooperation with the IC. The credit allowance is equal to the amounts charged for *BellSouth Directory Assistance Access* service call as set forth in Section E9.5. (C)  
(C)  
(C)  
(D)  
(D)  
(T)

### E9.5 Rate Regulations and Charges

#### E9.5.1 Rate Regulations

- A. The *BellSouth* Directory Assistance Access service call charge, as set forth in Section E9.5.3, applies for each call to automated *BellSouth Directory Assistance Access* service. A call is a call which has been connected to automated *BellSouth Directory Assistance Access* service. No charge applies if the automated *BellSouth Directory Assistance* service is unable to find the requested telephone number. The number of calls will be accumulated by Company measuring equipment. A credit for the provision of an incorrect telephone number will be applied as set forth in Section E9.4.7. (T)  
(C)  
|  
(C)

#### E9.5.2 Rate Categories

- A. There are three (3) rate categories which apply to *BellSouth* Directory Assistance Access service: (T)  
(C)  
(C)  
(C)  
(C)
- Directory Transport
  - *BellSouth* Directory Assistance *Access* service Call
  - *BellSouth* Directory Assistance *Access* Interconnection
- Additionally, nonrecurring charges may be applicable as specified in Section E9.5.3. (T)
1. Directory Transport  
The Directory Transport rate category provides for the transport facilities and termination between the IC's premises and the *BellSouth Directory Assistance Access* location. These rate elements are defined in Section E9.2.2.B.3. (C)
  2. *BellSouth* Directory Assistance *Access* service Call  
The automated *BellSouth* Directory Assistance *Access* service Call rate category provides for the use of the Company automated *BellSouth Directory Assistance Access* service and *BellSouth Directory Assistance Access* equipment. (C)  
(C)

ISSUED: August 5, 2005  
BY: Marshall M. Criser III, President -FL  
Miami, Florida

EFFECTIVE: September 4, 2005

## E9. BELLSOUTH DIRECTORY ASSISTANCE ACCESS SERVICE

### E9.5 Rate Regulations and Charges (Cont'd)

#### E9.5.2 Rate Categories (Cont'd)

- A. There are three (3) rate categories which apply to BellSouth Directory Assistance Access service: (Cont'd)
3. BellSouth Directory Assistance Access Interconnection  
The BellSouth Directory Assistance Access Interconnection rate category provides for switching capability and network functions not assigned to other BellSouth Directory Assistance Access service rate categories. This charge is assessed to all ICs and is applied on a per BellSouth Directory Assistance Access call basis.
- B. Nonrecurring charges will apply for the installation of Directory Transport facilities, service rearrangements or features as defined in E9.2.2 preceding.

#### E9.5.3 Rates and Charges

A. Rates and charges

1. BellSouth Directory Assistance Access

	Rate	USOC	
(a) Each	\$ .25	NA	
2. Directory Transport			
(a) Switched Local Channel <sup>1</sup>	-	NA	
(b) BellSouth SWA Dedicated Transport <sup>1</sup>	-	NA	
(c) BellSouth SWA Common Transport per BellSouth Directory Assistance Access Service Call <sup>2</sup>	.000100	NA	(T)
(d) BellSouth SWA Common Transport per BellSouth Directory Assistance Access Service Call Mile <sup>3</sup>	.000013	NA	(T)
(e) Access Tandem Switching per BellSouth Directory Assistance Access Service Call	.000183	NA	
(f) BellSouth Directory Assistance Access Interconnection per BellSouth Directory Assistance Access Service Call	-	NA	
(g) DS3 to DS1 Multiplexer per DA Access Service Call	.000060	NA	
(h) Installation <sup>2</sup>	-	NA	

**Note 1:** Nonrecurring and monthly rates are as specified for BellSouth SWA Transport in E6.8.1 of this Tariff.

**Note 2:** Nonrecurring rates are as specified for BellSouth SWA Transport in E6.8.1 of this Tariff.

**Note 3:** These charges also apply to the BellSouth SWA Common Transport IP Option. (N)

ISSUED: January 3, 2003  
BY: Joseph P. Lacher, President -FL  
Miami, Florida

EFFECTIVE: January 18, 2003

## E9. BELLSOUTH DIRECTORY ASSISTANCE ACCESS SERVICE

### E9.6 BellSouth Flat Rated DA Trunks

#### E9.6.1 General Description

BellSouth Flat Rated DA Trunks provide the means to *interconnect a customer's high capacity facility or facilities (e.g., DS1, MegaLink®, LightGate®, SmartPath® or SMARTRing®) at a DS1 level to the network* location of their directory assistance provider. (C)

- A. BellSouth Flat Rated DA Trunks have the same transmission specifications as do BellSouth SWA FGD trunks, as described in E6.2.4 of this tariff.
- B. BellSouth Flat Rated DA Trunks are made available in the following types:
  - Type 1: *Supports* bi-directional transport of customer calls using CCS7 signaling to provide call return, (C)
  - Type 2: *Supports* unidirectional transport of customer calls using CCS7 signaling, and (C)
  - Type 3: *Supports* unidirectional transport of customer calls using MF signaling. (C)
- C. Rates and charges for BellSouth Flat Rated DA Trunks are as detailed in *E9.6.3*, following. (T)

#### E9.6.2 Service Requirements

- A. BellSouth Flat Rated DA Trunks must be interconnected with a customer's high capacity facility or facilities (i.e., DS1, MegaLink®, LightGate®, SmartPath® or SMARTRing®) at a DS1 level in order that BellSouth Flat Rated DA Trunks function properly. Any combination of twenty-four (24) Flat Rated DA Trunk Types 1, 2 and 3 can be ordered to meet this requirement. If the customer requires more than twenty-four (24) Flat Rated DA Trunks, additional trunks must be ordered in increments of twenty-four (24). (N)
- B. The Telephone Company will specify network locations from which BellSouth Flat Rated DA Trunks are made available as shown in NATIONAL EXCHANGE CARRIER ASSOCIATION, INC. TARIFF F.C.C. No.4. (N)
- C. When ordering BellSouth Flat Rated DA Trunks, the customer must submit to the Telephone Company a Connecting Facility Assignment (CFA) identifying which and/or what part of the customer's high capacity facility and/or facilities are to be interconnected to the Telephone Company's BellSouth Flat Rated DA Trunks. Any subsequent change of Connecting Facilities Assignment (CFA) affecting interconnection with BellSouth Flat Rated DA Trunks must also be submitted to the Telephone Company. (N)

#### E9.6.3 Rates and Charges

- A. The following rates apply to BellSouth Flat Rated DA Trunks.
  - 1. Flat Rated DA Trunks

	Monthly Rate	— Nonrecurring Charges —		USOC	
		First Trunk Installed	Each Add'l Trunk		
(a) Type 1	\$ 6.00	\$ 24.00	\$ 20.00	WDAT1	(R)
(b) Type 2	6.00	24.00	20.00	WDAT2	(R)
(c) Type 3	6.00	24.00	20.00	WDAT3	(R)

EFFECTIVE: July 15, 1996

**E10. LATA CONFIGURATIONS<sup>1</sup>**

(N)

CONTENTS

<b>E10.1</b>	<b>Reserved for Future Use</b>	1
<b>E10.2</b>	<b>Reserved for Future Use</b>	1
<b>E10.3</b>	<b>Equal Access Exchange Areas (EAEA), LATA and Market Areas</b>	1
E10.3.1	LATA and Market Area Configurations	1
E10.3.2	Equal Access Exchange Areas (EAEA)	1
<b>E10.4</b>	<b>Reserved for Future Use</b>	11
<b>E10.5</b>	<b>Reserved for Future Use</b>	11

**Note 1:** Text is shown as new due to reissue of all Tariff Sections. No changes in rates or regulations were made with this filing.

EFFECTIVE: July 15, 1996

## E10. LATA CONFIGURATIONS<sup>1</sup>

(N)

### E10.1 Reserved for Future Use

### E10.2 Reserved for Future Use

### E10.3 Equal Access Exchange Areas (EAEA), LATAs and Market Areas

#### E10.3.1 LATA and Market Area Configurations

A LATA or Market Area is a geographical area in which Access Service is provided.

#### E10.3.2 Equal Access Exchange Areas (EAEA)

EAEAs are geographical areas, configured based on 1987 planned toll center/access tandem areas, in which the Company is responsible for providing equal access to both carriers and end users in the most economically efficient manner. In an EAEA, ICs and resellers may have one or more point of presence so long as any additional costs incurred by the Company in providing such alternate or additional point of presence be paid by the party choosing such location. (FPSC order 13750, Docket 820537-TP October 5, 1984)

A primary point of connection will be provided by the Company in each EAEA.

EAEA's and the exchanges contained therein are listed below:

#### A. Crestview EAEA (Pensacola LATA)

Primary Point of Connection:

EXCHANGE	COMPANY
Baker	CENTEL
Crestview	CENTEL
DeFuniak Springs	CENTEL
Freeport	CENTEL
Glendale	CENTEL
Laurel Hill	Floral
Paxton	Floral
Ponce de Leon	CENTEL

#### B. Ft. Walton Beach EAEA (Pensacola LATA)

Primary Point of Connection:

Destin	CENTEL
Ft. Walton Beach	CENTEL
Santa Rosa Beach	CENTEL
Sea Grove Beach	CENTEL
Shalimar	CENTEL
Valpariso	CENTEL

**Note 1:** Text is shown as new due to reissue of all Tariff Sections. No changes in rates or regulations were made with this filing.



EFFECTIVE: July 15, 1996

**E10. LATA CONFIGURATIONS<sup>1</sup>**

(N)

**E10.3 Equal Access Exchange Areas (EAEA), LATAs and Market Areas (Cont'd)**

**E10.3.2 Equal Access Exchange Areas (EAEA) (Cont'd)**

**C. Tallahassee EAEA (Tallahassee Market Area)**

Primary Point of Connection:

Cherry Lake	CENTEL
Crawfordville	CENTEL
Greenville	CENTEL
Keaton Beach	Gulf
Lee	CENTEL
Madison	CENTEL
Monticello	CENTEL
Panacea	CENTEL
Perry	Gulf
Sopchoppy	CENTEL
St. Marks	CENTEL
Tallahassee	CENTEL

**D. Marianna EAEA (Panama City LATA)**

Primary Point of Connection:

Grand Ridge	CENTEL
Greenwood	CENTEL
Marianna	CENTEL
Malone	CENTEL
Sneads	CENTEL

**E. Live Oak EAEA (Jacksonville LATA)**

Primary Point of Connection:

Alachua	ALLTEL
Branford	ALLTEL
Dowling Park	ALLTEL
Fla. Sheriffs Boys' Ranch	ALLTEL
Fort White	ALLTEL
High Springs	ALLTEL
Jasper	ALLTEL
Jennings	ALLTEL
Lake Butler	ALLTEL
Live Oak	ALLTEL

**Note 1:** Text is shown as new due to reissue of all Tariff Sections. No changes in rates or regulations were made with this filing.

EFFECTIVE: July 15, 1996

## E10. LATA CONFIGURATIONS<sup>1</sup>

(N)

### E10.3 Equal Access Exchange Areas (EAEA), LATAs and Market Areas (Cont'd)

#### E10.3.2 Equal Access Exchange Areas (EAEA) (Cont'd)

##### E. Live Oak EAEA (Jacksonville LATA) (Cont'd)

Luraville	ALLTEL
Mayo	ALLTEL
Raiford	ALLTEL
Wellborn	ALLTEL
White Springs	ALLTEL

##### F. Tampa EAEA (Tampa Market Area)

###### Primary Point of Connection:

Bartow	General
Bradenton	General
Clearwater	General
Englewood	General
Frostproof	General
Haines City	General
Hudson	General
Indian Lakes	General
Lake Wales	General
Lakeland	General
Mulberry	General
Myakka	General
New Port Richey	General
North Port	General
Palmetto	General
Plant City	General
Polk City	General
Sarasota	General
St. Petersburg	General
Tampa	General
Tarpon Springs	General
Venice	General
Winter Haven	General
Zephyrhills	General

**Note 1:** Text is shown as new due to reissue of all Tariff Sections. No changes in rates or regulations were made with this filing.

EFFECTIVE: July 15, 1996

## E10. LATA CONFIGURATIONS<sup>1</sup>

(N)

### E10.3 Equal Access Exchange Areas (EAEA), LATAs and Market Areas (Cont'd)

#### E10.3.2 Equal Access Exchange Areas (EAEA) (Cont'd)

G. Quincy EAEA (Panama City LATA)

Primary Point of Connection:

Greensboro	Quincy
Gretna	Quincy
Quincy	Quincy

H. Atmore EAEA (Mobile, Alabama, LATA)

Primary Point of Connection:

Century	BellSouth
Walnut Hill	Frontier Communications of the South, Inc.

I. Avon Park EAEA (Ft. Myers Market Area)

Primary Point of Connection:

Arcadia	United
Avon Park	United
Bowling Green	United
Ft. Meade	United
Lake Placid	United
Okeechobee	United
Sebring	United
Spring Lake	United
Wauchula	United
Zolfo Springs	United

J. Fort Myers EAEA (Fort Myers Market Area)

Primary Point of Connection:

Boca Grande	United
Bonita Springs	United
Cape Coral	United
Cape Haze	United
Clewiston	United
Everglades	United
Ft. Myers	United
Ft. Myers Beach	United
Immokalee	United

**Note 1:** Text is shown as new due to reissue of all Tariff Sections. No changes in rates or regulations were made with this filing.

EFFECTIVE: July 15, 1996

**E10. LATA CONFIGURATIONS<sup>1</sup>**

(N)

**E10.3 Equal Access Exchange Areas (EAEA), LATAs and Market Areas (Cont'd)**

**E10.3.2 Equal Access Exchange Areas (EAEA) (Cont'd)**

**J. Fort Myers EAEA (Fort Myers Market Area) (Cont'd)**

La Belle	United
Lehigh Acres	United
Marco Island	United
Moore Haven	United
Naples	United
North Fort Myers	United
North Naples	United
Pine Island	United
Port Charlotte	United
Punta Gorda	United
Sanibel-Captiva	United

**K. Lake Buena Vista EAEA (Orlando LATA)**

Primary Point of Connection:

Lake Buena Vista	Vista-United
------------------	--------------

**L. Winter Park EAEA (Orlando LATA)**

Primary Point of Connection:

Apopka	United
Kenansville	United
Kissimmee	United
Monteverde	United
Orange City	United
Reedy Creek	United
Saint Cloud	United
West Kissimmee	United
Windermere	United
Winter Garden	United
Winter Park	United

**M. Ocala EAEA (Gainesville LATA)**

Primary Point of Connection:

Astor	United
Bellview	United
Bushnell	United

**Note 1:** Text is shown as new due to reissue of all Tariff Sections. No changes in rates or regulations were made with this filing.

EFFECTIVE: July 15, 1996

**E10. LATA CONFIGURATIONS<sup>1</sup>**

(N)

**E10.3 Equal Access Exchange Areas (EAEA), LATAs and Market Areas (Cont'd)**

**E10.3.2 Equal Access Exchange Areas (EAEA) (Cont'd)**

**M. Ocala EAEA (Gainesville LATA) (Cont'd)**

Clermont	United
Dade City	United
Eustis	United
Forest	United
Groveland	United
Howey-In-The-Hills	United
Lady Lake	United
Leesburg	United
Mount Dora	United
Ocala	United
Oklawaha	United
Salt Springs	United
San Antonio	United
Silver Springs Shores	United
Tavares	United
Umatilla	United
Wildwood	United
Williston	United
Beverly Hills	United
Crystal River	United
Homosassa Springs	United
Inverness	United
Trilacoochee	United

**N. Port St. Joe EAEA (Panama City LATA)**

**Primary Point of Connection:**

Alligator Point	St. Joseph Telephone
Altha	St. Joseph Telephone
Apalachicola	St. Joseph Telephone
Blountstown	St. Joseph Telephone
Bristol	St. Joseph Telephone
Carrabelle	St. Joseph Telephone
Chattahoochee	St. Joseph Telephone

**Note 1:** Text is shown as new due to reissue of all Tariff Sections. No changes in rates or regulations were made with this filing.

EFFECTIVE: July 15, 1996

**E10. LATA CONFIGURATIONS<sup>1</sup>**

(N)

**E10.3 Equal Access Exchange Areas (EAEA), LATAs and Market Areas (Cont'd)**

**E10.3.2 Equal Access Exchange Areas (EAEA) (Cont'd)**

**N. Port St. Joe EAEA (Panama City LATA) (Cont'd)**

East Point	St. Joseph Telephone
Hosford	St. Joseph Telephone
Port St. Joe	St. Joseph Telephone
The Beaches	St. Joseph Telephone
Tyndall AFB	St. Joseph Telephone
Wewahitchka	St. Joseph Telephone

**O. Pensacola EAEA (Pensacola LATA)**

Primary Point of Connection:

Cantonment	BellSouth
Gulf Breeze	BellSouth
Holley-Navarre	BellSouth
Jay	BellSouth
Milton	BellSouth
Molino	Frontier Communications of the South, Inc.
Munson	BellSouth
Pace	BellSouth
Pensacola	BellSouth

**P. Panama City EAEA (Panama City LATA)**

Primary Point of Connection:

Alford	CENTEL
Bonifay	CENTEL
Chipley	BellSouth
Cottondale	CENTEL
Graceville	BellSouth
Havana	BellSouth
Lynn Haven	BellSouth
Panama City	BellSouth
Panama City Beach	BellSouth
Reynolds Hill	CENTEL
Sunny Hills	BellSouth
Vernon	BellSouth

**Note 1:** Text is shown as new due to reissue of all Tariff Sections. No changes in rates or regulations were made with this filing.

EFFECTIVE: July 15, 1996

**E10. LATA CONFIGURATIONS<sup>1</sup>**

(N)

**E10.3 Equal Access Exchange Areas (EAEA), LATAs and Market Areas (Cont'd)**

**E10.3.2 Equal Access Exchange Areas (EAEA) (Cont'd)**

**P. Panama City EAEA (Panama City LATA) (Cont'd)**

Westville CENTEL  
Youngstown-Fountain BellSouth

**Q. Gainesville EAEA (Gainesville LATA)**

Primary Point of Connection:

Archer BellSouth  
Bronson BellSouth  
Brooker ALLTEL  
Brooksville BellSouth  
Cedar Key BellSouth  
Chiefland BellSouth  
Citra ALLTEL  
Cross City BellSouth  
Dunnellon BellSouth  
Gainesville BellSouth  
Hawthorne BellSouth  
Keystone Heights BellSouth  
McIntosh ALLTEL  
Melrose ALLTEL  
Micanopy BellSouth  
Newberry BellSouth  
Old Town BellSouth  
Orange Springs ALLTEL  
Trenton BellSouth  
Waldo ALLTEL  
Weekiwachee Springs BellSouth  
Yankeetown BellSouth

**R. Daytona Beach EAEA (Daytona Beach LATA)**

Primary Point of Connection:

Bunnell BellSouth  
Daytona BellSouth  
Deland BellSouth  
Deleon Springs BellSouth

**Note 1:** Text is shown as new due to reissue of all Tariff Sections. No changes in rates or regulations were made with this filing.

EFFECTIVE: July 15, 1996

## E10. LATA CONFIGURATIONS<sup>1</sup>

(N)

### E10.3 Equal Access Exchange Areas (EAEA), LATAs and Market Areas (Cont'd)

#### E10.3.2 Equal Access Exchange Areas (EAEA) (Cont'd)

##### R. Daytona Beach EAEA (Daytona Beach LATA) (Cont'd)

Flagler Beach	BellSouth
New Smyrna Beach	BellSouth
Oak Hill	BellSouth
Palm Coast	BellSouth
Pierson	BellSouth

##### S. Jacksonville EAEA (Jacksonville LATA)

###### Primary Point of Connection:

Baldwin	BellSouth
Callahan	ALLTEL
Crescent City	ALLTEL
Fernandina Beach	BellSouth
Florahome	ALLTEL
Fort George	BellSouth
Green Cove Springs	BellSouth
Hastings	ALLTEL
Hilliard	ALLTEL
Interlachen	ALLTEL
Jacksonville	BellSouth
Jacksonville Beach	BellSouth
Julington	BellSouth
Kingsley Lake	Centel
Lake City	BellSouth
Lawtey	Centel
Maccleenny	Northeast Florida
Maxville	BellSouth
Middleburg	BellSouth
Orange Park	BellSouth
Palatka	BellSouth
Pomona Park	BellSouth
Ponte Vedra Beach	BellSouth
Sanderson	Northeast Florida
St. Augustine	BellSouth

Note 1: Text is shown as new due to reissue of all Tariff Sections. No changes in rates or regulations were made with this filing.



ISSUED: July 1, 1996  
BY: Joseph P. Lacher, President -FL  
Miami, Florida

EFFECTIVE: July 15, 1996

**E10. LATA CONFIGURATIONS<sup>1</sup>**

(N)

**E10.3 Equal Access Exchange Areas (EAEA), LATAs and Market Areas (Cont'd)**

**E10.3.2 Equal Access Exchange Areas (EAEA) (Cont'd)**

**S. Jacksonville EAEA (Jacksonville LATA) (Cont'd)**

Starke	Centel
Welaka	BellSouth
Yulee	BellSouth

**T. Orlando EAEA (Orlando LATA)**

**Primary Point of Connection:**

Cocoa	BellSouth
Cocoa Beach	BellSouth
DeBary	BellSouth
East Orange	BellSouth
Eau Gallie	BellSouth
Geneva	BellSouth
Melbourne	BellSouth
Orlando	BellSouth
Oviedo	BellSouth
Sanford	BellSouth
Titusville	BellSouth

**U. West Palm Beach EAEA (Southeast LATA)**

**Primary Point of Connection:**

Belle Glade	BellSouth
Boca Raton	BellSouth
Boynton Beach	BellSouth
Delray Beach	BellSouth
Fort Pierce	BellSouth
Hobe Sound	BellSouth
Indiantown	Indiantown
Jensen Beach	BellSouth
Jupiter	BellSouth
Pahokee	BellSouth
Port St. Lucie	BellSouth
Sebastian	BellSouth
Stuart	BellSouth
Vero Beach	BellSouth
West Palm Beach	BellSouth

**Note 1:** Text is shown as new due to reissue of all Tariff Sections. No changes in rates or regulations were made with this filing.

FLORIDA  
ISSUED: July 1, 1996  
BY: Joseph P. Lacher, President -FL  
Miami, Florida

EFFECTIVE: July 15, 1996

## E10. LATA CONFIGURATIONS<sup>1</sup>

(N)

### E10.3 Equal Access Exchange Areas (EAEA), LATAs and Market Areas (Cont'd)

#### E10.3.2 Equal Access Exchange Areas (EAEA) (Cont'd)

##### V. Ojus EAEA (Southeast LATA)

###### Primary Point of Connection:

Big Pine Key	BellSouth
Coral Springs	BellSouth
Deerfield Beach	BellSouth
Ft. Lauderdale	BellSouth
Hollywood	BellSouth
Homestead	BellSouth
Islamorada	BellSouth
Key Largo	BellSouth
Key West	BellSouth
Marathon	BellSouth
Miami	BellSouth
North Dade	BellSouth
North Key Largo	BellSouth
Perrine	BellSouth
Pompano Beach	BellSouth
Sugarloaf Key	BellSouth

### E10.4 Reserved for Future Use

### E10.5 Reserved for Future Use

Material formerly appearing on this page may now be found in the NATIONAL EXCHANGE CARRIER ASSOCIATION, INC. TARIFF F.C.C. NO. 4.

**Note 1:** Text is shown as new due to reissue of all Tariff Sections. No changes in rates or regulations were made with this filing.

EFFECTIVE: July 15, 1996

**E11. SPECIAL FACILITIES ROUTING OF ACCESS SERVICES<sup>1</sup>**

(N)

CONTENTS

	New Page	Old Page
<b>E11.1 Description of Special Facilities Routing of Access Services</b>	1	1
E11.1.1 General	1	1
<b>E11.2 Rates and Charges for Special Facilities Routing of Access Services</b>	1	1
E11.2.1 Diversity	1	1
E11.2.2 Avoidance	2	1
E11.2.3 Diversity and Avoidance Combined	2	1
E11.2.4 Cable-Only Facilities	2	1

**Note 1:** Text is shown as new due to reissue of all Tariff Sections. No changes in rates or regulations were made with this filing.

FLORIDA

ISSUED: February 14, 1997

EFFECTIVE: March 1, 1997

BY: Joseph P. Lacher, President -FL  
Miami, Florida

## E11. Special Facilities Routing of Access Services (T)

### E11.1 Description of Special Facilities Routing of Access Services

#### E11.1.1 General

- A. The services provided under this Tariff are provided over such routes and facilities as the Company may elect. Special Facilities Routing is involved, when, in order to comply with requirements specified by the IC, the Company provides *BellSouth SWA* service or Dedicated Access Service in a manner which includes one or more of the following conditions: (T)
1. Diversity  
Where two or more services must be provided over not more than two different physical routes.
  2. Avoidance  
Where a service must be provided on a route which avoids specified geographical locations.
  3. Cable-Only Facilities  
Certain Voice Grade services are provided on Cable-Only Facilities to meet the particular needs of an IC. Service is provided subject to the availability of cable-only facilities. In the event of service failure, restoration will be made through the use of any available facilities as selected by the Company.
- B. Avoidance and Diversity are available on *BellSouth SWA* service as set forth in Section E6. preceding, and Narrowband, Voice Grade (*a.k.a. BellSouth SPA DSO VG*) and Wideband Analog (*a.k.a. BellSouth SPA Wideband Analog*) services as set forth in Section E7. preceding. Cable-Only Facilities are available for *BellSouth SWA* service as set forth in Section E6. preceding and Voice Grade Dedicated Access (*a.k.a. BellSouth SPA DSO VG*) services as set forth in Section E7. preceding. (T)
- C. In order to avoid the compromise of special routing information, the Company will provide the required routing information for each specially routed service to only the ordering IC. If requested by the IC, this information will be provided when service is installed and prior to any subsequent changes in routing.
- D. The rates and charges for Special Facilities Routing of Access Services as set forth in E11.2 following are in addition to all other rates and charges that may be applicable for services provided under other sections of this Tariff.

### E11.2 Rates and Charges for Special Facilities Routing of Access Services

The rates and charges for Special Facilities Routing of Access Services are as follows:

#### E11.2.1 Diversity

For each service provided in accordance with E11.1.1.A.1 preceding, the rates and charges will be developed on an individual case basis and filed following: (USOC SYD++)

FLORIDA  
ISSUED: July 1, 1996  
BY: Joseph P. Lacher, President - FL  
Miami, Florida

EFFECTIVE: July 15, 1996

## **E11. Special Facilities Routing of Access Services<sup>1</sup>**

(N)

### **E11.2 Rates and Charges for Special Facilities Routing of Access Services (Cont'd)**

#### **E11.2.2 Avoidance**

For each service provided in accordance with E11.1.1.A.2 preceding, the rates and charges will be developed on an individual case basis and filed following: (USOC SYA++)

#### **E11.2.3 Diversity and Avoidance Combined**

For each service provided in accordance with E11.1.1.A.1 and E11.1.1.A.2. preceding, combined, the rates and charges will be developed on an individual case basis and filed following: (USOC SYB++)

#### **E11.2.4 Cable-Only Facilities**

For each service provided in accordance with E11.1.1.A.3. preceding, the rates and charges will be developed on an individual case basis and filed following: (USOC SYC++)

**Note 1:** Text is shown as new due to reissue of all Tariff Sections. No changes in rates or regulations were made with this filing.

**E12. SPECIALIZED SERVICE OR ARRANGEMENTS<sup>1</sup>**

(N)

CONTENTS

	New Page	Old Page
<b>E12.1 General</b>	1	1
E12.1.1 Provision of Specialized Service or Arrangements	1	1
<b>E12.2 Application of Move Charges</b>	1	1
<b>E12.3 Contract Service Arrangements</b>	1	1
E12.3.1 General	1	1

Note 1: Text is shown as new due to reissue of all Tariff Sections. No changes in rates or regulations were made with this filing.

FLORIDA

ISSUED: July 1, 1996

BY: Joseph P. Lacher, President - FL  
Miami, Florida

EFFECTIVE: July 15, 1996

## E12. SPECIALIZED SERVICE OR ARRANGEMENTS<sup>1</sup>

(N)

### E12.1 General

#### E12.1.1 Provision of Specilized Service or Arrangements

Specialized service or arrangements may be provided by the Company, at the request of an IC, on an individual case basis if such service or arrangements meet the following criteria:

- A. The requested service or arrangements are not offered under other sections of this Tariff.
- B. The facilities utilized to provide the requested service or arrangements are of a type normally used by the Company in furnishing its other services.
- C. The requested service or arrangements are provided within a LATA.
- D. The requested service or arrangements are compatible with other Company services, facilities, and its engineering and maintenance practices.
- E. This offering is subject to the availability of the necessary Company personnel and capital resources.

### E12.2 Application of Move Charges

- A. When service without a maximum termination liability charge associated with it is moved to a different building, the nonrecurring charge applies; when moved to a new location in the same building, a charge of one-half the nonrecurring charge applies.
- B. When service with a maximum termination liability charge associated with it is moved and is reinstalled at a new location, the customer may elect:
  1. to pay the unexpired portion of the maximum termination liability charge for the service, if any, with the application of a nonrecurring charge and the establishment of a new maximum termination liability charge for such service at the new location, or
  2. to continue service subject to the unexpired portion of the maximum termination liability charge, if any, and pay the estimated costs of moving such service, provided that the customer requests these charges be quoted prior to ordering the service move. Charges for moving such service will be based on estimated costs attributable to the move.
- C. Move charges include the estimated costs of removal, restoration of services or facilities necessitated by the move, transportation, storage, reinstallation, engineering, labor, supervision, materials, administration, and any other specific items of cost directly attributable to the move.

### E12.3 Contract Service Arrangements

#### E12.3.1 General

- A. When economically practicable, customer specific contract service arrangements may be furnished in lieu of existing tariff offerings provided there is reasonable potential for uneconomic bypass of the Company's services. Uneconomic bypass occurs when an alternative service arrangement is utilized, in lieu of Company services, at prices below the Company's rates but above the Company's incremental costs.

**Note 1:** Text is shown as new due to reissue of all Tariff Sections. No changes in rates or regulations were made with this filing.

EFFECTIVE: July 15, 1996

## E12. SPECIALIZED SERVICE OR ARRANGEMENTS <sup>1</sup>

(N)

### E12.3 Contract Service Arrangements (Cont'd)

#### E12.3.1 General (Cont'd)

- B. Rates, Charges, Terms and additional regulations, if applicable, for the contract service arrangements will be developed on an individual case basis, and will include all relevant costs, plus an appropriate level of contribution.
- C. Costs for the contract service arrangements may include one or more of the following items:
  - 1. Labor, engineering and materials.
  - 2. Operating expenses, e.g. maintenance, administration, etc.
  - 3. Return on investment
  - 4. Taxes
  - 5. Depreciation
  - 6. Any other identifiable associated cost.
- D. Unless otherwise specified, the regulations for contract service arrangements are in addition to the applicable regulations and rates specified in other sections of this Tariff.
- E. Services specified in the following Sections only of this Tariff are available through contract service arrangements:
  - Section E6 - Dedicated Access Line Service Only
  - Section E7
- F. Contract Service Arrangements are furnished by the Company to a subscriber only for communications in which the subscriber has a direct interest and shall not be used for any purpose for which a payment or other compensation shall be received by him from any other person, firm, or corporation for such use, or in the collection, transmission or delivery of any communication for others. Contract Service Arrangements will not be offered to Interexchange Carriers (IC's) or other parties for the purposes of resale and/or shared use.
- G. The subscriber and the Company may elect to enter into an agreement where certain rates and/or charges for contract service arrangements are applicable for a fixed period of time. The Company will continue to offer such contract service arrangements without change in the applicable rates and/or charges unless mutual consent has been reached between the Company and the customer to undertake such changes. The Florida Public Service Commission will not adjust contract service arrangement rates and/or charges during this period. At the completion of this period, the agreement may be renewed at the option of the Company and the subscriber. Revised rates and/or charges may apply to any renewed agreement.

Note 1: Text is shown as new due to reissue of all Tariff Sections. No changes in rates or regulations were made with this filing.



## E13. ADDITIONAL ENGINEERING, ADDITIONAL LABOR AND MISCELLANEOUS CHARGES

### CONTENTS

<b>E13.1</b>	<b>Additional Engineering</b>	1
E13.1.1	Charges For Additional Engineering	1
E13.1.2	Reserved for Future Use	1
<b>E13.2</b>	<b>Additional Labor</b>	1
E13.2.1	Overtime Installation	1
E13.2.2	Overtime Repair	2
E13.2.3	Stand By	2
E13.2.4	Testing and Maintenance with Other Telephone Companies	2
E13.2.5	Other Labor	2
E13.2.6	Charges for Additional Labor	2
<b>E13.3</b>	<b>Miscellaneous Services</b>	3
E13.3.1	Trouble Location Charges (TLC)	3
E13.3.2	Restoration Priority (Obsoleted, See Section E113.)	4
E13.3.3	BellSouth Equal Access Subscription	4
E13.3.4	Standard Jacks - Registration Program	9
E13.3.5	Testing Services	13
E13.3.6	Provision of Access Service Billing Information	21
E13.3.7	Protective Connecting Arrangements	22
E13.3.8	Controller Arrangement	22
E13.3.9	Telecommunications Service Priority (TSP) System	23
E13.3.10	BellSouth Administrative Management Service	26
E13.3.11	(DELETED)	31 (D)
E13.3.12	BellSouth 8XX Toll Free Dialing Number Administration Service	35

BELLSOUTH  
TELECOMMUNICATIONS, INC.  
FLORIDA

ACCESS SERVICES TARIFF

Sixth Revised Page 2  
Cancels Fifth Revised Page 2

ISSUED: February 15, 2008  
BY: Marshall M. Criser III, President -FL  
Miami, Florida

EFFECTIVE: February 18, 2008

**E13. ADDITIONAL ENGINEERING, ADDITIONAL LABOR AND  
MISCELLANEOUS CHARGES**

CONTENTS

**E13.3 Miscellaneous Services (Cont'd)**

E13.3.13	BellSouth Billing Name and Address for ANI Service	39	
E13.3.14	Reserved for Future Use	40	(T)
E13.3.15	(DELETED)	42	(D)
E13.3.16	(DELETED)	45	(D)
E13.3.17	(DELETED)	46	(D)
E13.3.18	Reserved for Future Use	48	
E13.3.19	Reserved for Future Use	48	
E13.3.20	Reserved for Future Use	48	
E13.3.21	Reserved for Future Use	48	
E13.3.22	Reserved for Future Use	48	
E13.3.23	Physical Access Collocation Cross-Connect Service	48	
E13.3.24	Virtual Access Collocation Cross-Connect Service	50	
E13.3.25	DS3 Network Interface Unit With Loop Back Capability	52	

All AT&T and BellSouth marks contained herein and as set forth in the trademarks and service marks section of the BellSouth Tariff are owned by AT&T Intellectual Property or AT&T affiliated companies.

ISSUED: August 22, 2013  
BY: Marshall M. Criser III, President -FL  
Miami, Florida

EFFECTIVE: August 23, 2013

## E13. ADDITIONAL ENGINEERING, ADDITIONAL LABOR AND MISCELLANEOUS CHARGES

### E13.1 Additional Engineering

In this section normally scheduled working hours are an employee's scheduled work period in any given calendar day (e.g. 7:00 am to 4:00 pm) for the application of rates based on working hours.

- A. Additional Engineering will be provided by the Company at the request of the IC or End User only when:
  - 1. An IC or End User requests additional technical information after the Company has already provided the technical information normally included on the Design Layout Report (DLR) as set forth in E6.1.5 and E7.1.6 preceding.
  - 2. Additional engineering time is incurred by the Company to engineer an IC's or End User's request for a customized service as set forth in E7.2 preceding.
- B. The Company will notify the IC or End User that additional engineering charges, as set forth in E13.1.1 following, will apply before any additional engineering is undertaken. These charges apply per Company employee performing billable work at the IC or End User's request. The sum of the time is used to determine the number of 30-minute increments to be billed. Only one initial increment is to be billed per request.

#### E13.1.1 Charges For Additional Engineering

- A. The charges for additional engineering are as follows:
  - 1. Additional engineering periods.

	<b>First Half Hour Or Fraction Thereof</b>	<b>Each Additional Half Hour Or Fraction Thereof</b>	<b>USOC</b>
(a) Basic time, normally scheduled work hours	\$66.00	\$39.79	AEH
(b) Overtime, outside of normally scheduled work hours	73.41	47.20	AEH

#### E13.1.2 Reserved for Future Use

### E13.2 Additional Labor

In this section Normal Business Day is Monday – Friday, 8 am – 5 pm,

All charges apply per technician,

Holidays will be defined as: New Year's Day, Memorial Day, Independence Day, Labor Day, Thanksgiving Day and Christmas Day

Additional labor is that labor requested by the IC or End User on a given service and agreed to by the Company as set forth in E13.2.1 through E13.2.5 following. The Company will notify the IC or End User that additional labor charges as set forth in E13.2.6 following will apply before any additional labor is undertaken. The labor charges apply per Company employee performing billable work at the IC or End User's request. The sum of the time is used to determine the number of 30-minute increments to be billed. Only one initial increment is to be billed per request. A request for additional labor by a Company employee at a time not consecutive with the employee's scheduled work period is subject to a minimum charge of three hours. Payment for Additional Labor charges associated with *BellSouth SWA* Service is the responsibility of the IC. Payment of Additional Labor charges associated with Dedicated Access Service is the responsibility of the End User, unless the Additional Labor charge is the result of an IC initiated activity.

#### E13.2.1 Overtime Installation

Work related efforts of the Company performed outside a Normal Business Day.

(N)  
|  
(N)

(C)

ISSUED: August 22, 2013  
BY: Marshall M. Criser III, President -FL  
Miami, Florida

EFFECTIVE: August 23, 2013

## E13. ADDITIONAL ENGINEERING, ADDITIONAL LABOR AND MISCELLANEOUS CHARGES<sup>1</sup>

### E13.2 Additional Labor (Cont'd)

#### E13.2.3 Stand By

Stand by includes all time in excess of one-half (1/2) hour during which Company personnel stand by to make cooperative tests with an IC to verify facility repair on a given service. (D)

#### E13.2.4 Testing and Maintenance with Other Telephone Companies

Additional testing, maintenance or repair of facilities which connect to facilities of other telephone companies, which is in addition to normal effort required to test, maintain or repair facilities provided solely by the Company.

#### E13.2.5 Other Labor

Other Labor is that additional labor not included in E13.2.1 through E13.2.4 preceding, and labor incurred to accommodate a specific IC or end user request that involves only labor which is not covered by any other section of this Tariff.

#### E13.2.6 Charges for Additional Labor

##### A. Additional Labor Periods

##### 1. Installation or Repair

		First Half Hour Or Fraction Thereof	Each Additional Half Hour Or Fraction Thereof	USOC
(a)	Overtime, work related efforts of the Company performed outside a Normal Business day and on Saturdays.	\$29.31	\$3.10	ALH
(b)	Premium time, Work related efforts of the Company performed on Sundays and Holidays.	32.42	6.21	ALH
2. Standby <sup>2</sup>				
(a)	Basic time, Work related efforts of the Company performed during a Normal Business Day.	-	17.91	ALT
(b)	Overtime, Work related efforts of the Company performed outside a Normal Business Day and on Saturdays.	-	21.01	ALT
(c)	Premium time, Work related efforts of the Company performed on Sundays and Holidays.	-	24.12	ALT
3. Other Labor (or Testing and Maintenance with other telephone companies)				

**Note 1:** Text is shown as new due to reissue of all Tariff Sections. No changes in rates or regulations were made with this filing.

**Note 2:** For Standby testing, the rate for the "First Half Hour or Fraction Thereof" is to be applied to the first billable half hour.

**E13. ADDITIONAL ENGINEERING, ADDITIONAL LABOR AND  
 MISCELLANEOUS CHARGES**

**E13.2 Additional Labor (Cont'd)**

**E13.2.6 Charges for Additional Labor (Cont'd)**

**A. Additional Labor Periods (Cont'd)**

**3. Other Labor (or Testing and Maintenance with other telephone companies) (Cont'd)**

	<b>First Half Hour Or Fraction Thereof</b>	<b>Each Additional Half Hour Or Fraction Thereof</b>	<b>USOC</b>
(a) Basic time, Work related efforts of the Company performed during a Normal Business Day.	<b>\$44.12</b>	<b>\$17.91</b>	<b>ALK</b>
(b) Overtime, Work related efforts of the Company performed outside a Normal Business Day and on Saturdays.	<b>47.22</b>	<b>21.01</b>	<b>ALK</b>
(c) Premium time, Work related efforts of the Company performed on Sundays and Holidays.	<b>50.33</b>	<b>24.12</b>	<b>ALK</b>

**E13.3 Miscellaneous Services**

**E13.3.1 Trouble Location Charges (TLC) / Maintenance of Service**

The charges for Trouble Location Charges (TLC)/Maintenance of Service are deregulated. Terms and conditions are located in the AT&T Interstate Access Guidebook.

(N)  
|  
(N)

***DELETED***

(D)

***DELETED***

(D)

## E13. ADDITIONAL ENGINEERING, ADDITIONAL LABOR AND MISCELLANEOUS CHARGES

### E13.3 Miscellaneous Services (Cont'd)

*DELETED*

*DELETED*

(D)  
|  
(D)

#### E13.3.2 Restoration Priority (Obsoleted, See Section E113.)

#### E13.3.3 BellSouth Equal Access Subscription

##### A. Description

##### 1. BellSouth Equal Access Subscription

BellSouth Equal Access Subscription is a procedure whereby an end user for Telephone Exchange Service lines and/or trunks or the location provider or its authorized agent of pay telephones may select and designate to the Company an IC to access for IntraLATA toll calls without dialing an access code. The end user or location provider or its authorized agent may designate an IC for intraLATA toll, a different IC for interLATA toll, or the same IC for both. This IC is referred to as the end user's or pay telephone location provider's or its authorized agent's preferred IC and is defined by a unique Carrier Identification Code (CIC) shown on the customer service record.

Should a customer wish to use other services of the same or another IC, it will be necessary for the customer to dial the necessary access code(s) to reach that IC's other service(s).

For independent pay phone providers subscribing to SMARTLine® service, the IC designated as the preferred IC for 0+ intraLATA toll traffic may direct the routing of 1+ intraLATA toll calls either to itself or another IC (transport carrier), without dialing of an access code, subject to provisions set forth following. The option chosen by the IC will apply to all pay telephones provided from all end offices subtending an access tandem which are subscribed to that IC.

The IC shall submit an order for all end offices subtending an access tandem indicating whether 1+ intraLATA toll traffic from its subscribed pay telephones shall be routed to itself (as direct IC) or to another IC (as transport carrier). Recordings with alternate dialing instructions are not acceptable. If calls are to be routed to a transport IC, the 0+ IC must provide written authorization certifying that the order is being submitted pursuant to an agreement with the transport carrier. Only one transport carrier may be indicated for each access tandem.

If the IC designated as the primary IC for 0+ intraLATA toll traffic does not submit an order designating the transport carrier for 1+ intraLATA toll traffic for pay telephones at all end offices subtending an access tandem, the 1+ intraLATA toll traffic for that office will continue to be routed to the Company as of September 1, 1995, or until the subscribed 0+ carrier is ready to handle the 1+ IntraLATA toll sent-paid traffic, or makes arrangements with another IC to handle the traffic.

## E13. ADDITIONAL ENGINEERING, ADDITIONAL LABOR AND MISCELLANEOUS CHARGES

### E13.3 Miscellaneous Services (Cont'd)

#### E13.3.3 BellSouth Equal Access Subscription (Cont'd)

**B. Verification of Choice of IC**

ICs must request verification of choice from their customers/*subscribers*. All letters of agency, recordings, or other evidence of *verification* shall be maintained by the IC for a *minimum period of two years after obtaining such verification*. (C)

**1. Verification of Orders**

No IC (*submitting carrier*) shall submit to the Company a primary or preferred interexchange carrier (PIC) change order unless and until the order has first been confirmed in accordance with one of the following procedures: (C)

a. The IC has obtained the customer's written *or electronically signed* authorization *and/or verification* to submit the order that explains what occurs when a PIC is changed and confirms: (C)

- the customer's billing name and address and each telephone number to be covered by the PIC change order;
- the decision to change the PIC to the IC; and
- the customer's understanding of the PIC change fee; or

b. The IC has obtained the customer's electronic authorization, placed from the telephone number(s) on which the PIC is to be changed, to submit the order that confirms the information described in a. preceding to confirm the authorization; or

c. An appropriately qualified independent third party has obtained the customer's oral authorization to submit the PIC change order that confirms and includes appropriate verification data (e.g., the customer's date of birth or social security number); or (T)

An appropriately qualified independent third party must operate in a location physically separate from the IC and may not be owned, managed, controlled, or directed by the soliciting IC, nor can it receive financial incentives to *confirm* IC changes. (T)

d. Such other verification procedures as may be specified by the Florida Public Service Commission in rules or regulations which are consistent with rules promulgated by the Federal Communications Commission pursuant to 47 United States Code Section 258, *revision released August 25, 2000 and effective November 28, 2000*. (C)

2. The IC must submit a PIC change order, no more than 60 days after obtaining the written or electronically signed authorization. (N)

## E13. ADDITIONAL ENGINEERING, ADDITIONAL LABOR AND MISCELLANEOUS CHARGES

### E13.3 Miscellaneous Services (Cont'd)

#### E13.3.3 BellSouth Equal Access Subscription (Cont'd)

- C. Discrepancy *in* Subscription (C)  
(DELETED) (D)
1. Definitions: (N)
- a. Authorized carrier is defined as any carrier that submits a change, on behalf of an end user or location provider or its authorized agent, in the selection of a primary or preferred interexchange carrier (PIC) with authorization verified. (N)
- b. Unauthorized carrier is defined as any carrier that submits a change on behalf of an end user or location provider or its authorized agent, in the selection of a primary or preferred interexchange carrier (PIC) but fails to verify authorization. (N)
- c. Unauthorized change is a change in an end user or location provider or authorized agent's selection of a primary or preferred interexchange carrier (PIC) that was made without verification. (N)
2. When the Company is informed by an end user or location provider or its authorized agent of an alleged unauthorized change, the Company shall notify both the authorized and alleged unauthorized carrier of the incident. The Company shall direct the end user or location provider or its authorized agent to the relevant governmental agency, when an alleged unauthorized change is reported, for determination of fault. (N)
- In accordance with FCC Slamming Liability Rules, FCC Docket 94-129, the relevant governmental agency, in this instance the Florida Public Service Commission, will determine whether an unauthorized change occurred and resolution shall be handled directly with the authorized carrier, the unauthorized carrier and the end user, location provider or its authorized agent. (N)
3. When two or more IC orders are received for an end user or pay telephone line, the order with the latest application date determines customer choice.
- ICs involved in changes will be notified by the weekly activity report via paper format or mechanized interface in Network Operations Form (NOF) format.
4. **The alleged unauthorized carrier** will be assessed the subscription change charge as specified in E. following, **when an alleged unauthorized change has been reported by** the end user or pay telephone location provider or its authorized agent. (C)
- D. BellSouth Equal Access Subscription Charge Application
1. New end users or location providers or its authorized agent of pay telephones, will be asked to select a preferred IC for intraLATA at the time they place an order with the Company for Telephone Exchange Service. There will be no charge for this initial selection. The nonrecurring charge for all other changes is as set forth in E. following.
- A subscription charge will apply for each intraLATA PIC change submitted, except as provided in 1. preceding. The applicable subscription charge for each interLATA PIC change submitted is as set forth in the BellSouth Telecommunications, Inc. Tariff FCC No. 1, Section 13.3.3, for Southern Bell Telephone and Telegraph Company. If intraLATA and interLATA subscription changes are submitted simultaneously for the same carrier, the intraLATA subscription charge will be as set forth in E.2 following.



## E13. ADDITIONAL ENGINEERING, ADDITIONAL LABOR AND MISCELLANEOUS CHARGES

### E13.3 Miscellaneous Services (Cont'd)

#### E13.3.3 BellSouth Equal Access Subscription (Cont'd)

##### D. BellSouth Equal Access Subscription Charge Application (Cont'd)

1. On-Line Transfer Service is available to ICs participating in intraLATA Subscription for the purpose of assisting ICs and customers in the establishment of the end user's or pay telephone location provider's or its authorized agent's account. (C)  
***This service is not applicable when the end user initiates a request via the internet.*** Once the end user or location provider or its authorized agent selects a preferred IC, the Company representative will provide the end user or location provider or its authorized agent with the preferred IC's 800 telephone number. If the preferred IC participates in On-Line Transfer Service the end user or location provider or its authorized agent will have the option of being transferred directly to the preferred IC.
  - a. On-Line Transfer Service is available in all states within the Company's operating territory. On-Line Transfer Service may be ordered through a service agreement submitted to the Company. The service must be ordered on a state basis.
  - b. On-Line transfer cannot be offered and will not be available to end user's or pay telephone location provider's or its authorized agent's when the end user or location provider or its authorized agent has selected a preferred IC for intraLATA subscription, and a preferred IC for interLATA subscription and the preferred ICs are not the same IC, and both ICs participate in the On-Line transfer service.  
Furthermore, when the Telephone Company uses third party verification to confirm its selection as local or intraLATA toll service provider, On-Line Transfer service will not be available.
  - c. The Company representative will make one attempt to transfer the end user or location provider or its authorized agent of pay telephones to the preferred intraLATA IC. When the transfer is completed and the Company's representative receives one audible ring, the representative will disconnect from the call. If a busy line or circuit busy is encountered, the end user or pay telephone location provider or its authorized agent will be instructed to dial the preferred IntraLATA IC's 800 telephone number, previously provided, at a later time.  
The preferred IC will be billed applicable charges for the transfer as provided in E.3, following.
  - d. The preferred IC must comply with the following guidelines:
    - (1) The preferred IC must provide a dedicated 800 number for the end user or location provider or its authorized agent transfer.
    - (2) On-Line Transfer Service calls must be processed on a first priority basis, i.e., 95 percent of all calls transferred must be answered by the preferred IC within 30 seconds.
    - (3) The preferred IC must process transferred calls within six minutes.
  - e. The preferred IC must provide notification thirty days prior to discontinuance of this service.
2. If an IC elects to discontinue BellSouth SWA FGD or BellSouth SWA TSBSA 3 service in an equal access end office, (T)  
the IC is obligated to contact, in writing, all end users or location providers or its authorized agent of pay telephones, who have selected, the canceling IC as their primary IC. The IC must inform the end user or pay telephone location provider or its authorized agent that they are canceling their BellSouth SWA FGD or BellSouth SWA TSBSA 3 service; request that the end user or location provider or its authorized agent select a new IC; and state that the canceling IC will pay the change charge as provided in E., following.

**E13. ADDITIONAL ENGINEERING, ADDITIONAL LABOR AND  
 MISCELLANEOUS CHARGES**

**E13.3 Miscellaneous Services (Cont'd)**

**E13.3.3 BellSouth Equal Access Subscription (Cont'd)**

**D. BellSouth Equal Access Subscription Charge Application (Cont'd)**

**2. (Cont'd)**

For a period of two years from the date of BellSouth SWA FGD or BellSouth SWA TSBSA 3 discontinuance, the IC discontinuing service will be responsible for paying the change charge for any of its designated end users or pay telephone location providers or its authorized agents.

3. At the option of the IC, the nonrecurring charge for a change in Subscription, as provided in E. following, may be billed to the IC, instead of the end user or location provider or its authorized agent, when the change order is submitted to the Company via the Customer Account Record Exchange (CARE) interface. (T)

The option for the IC to be billed the PIC change charge instead of the end user or location provider or its authorized agent is not available for orders placed via the Company's Residence/Business/Coin Service Centers or the Equal Access Service Center.

**E. The nonrecurring charge for a change in IntraLATA Subscription; and the charges for On-Line Transfer Service are as follows:**

1. Subscription change when not performed simultaneously with interLATA PIC change to the same carrier, per line or trunk

	Nonrecurring Charge	USOC	
(a) billed to end user or pay telephone location provider or its authorized agent	\$1.78	EAJCP	(T)
(b) billed to IC	1.78	EAJCP	(T)
(c) alleged unauthorized change	1.78	EAJXB	(T)

2. Subscription change when performed simultaneously with interLATA PIC change to the same carrier, per line or trunk

(a) billed to end user or pay telephone location provider or its authorized agent	.54	EAJCP	(T)
(b) billed to IC	.54	EAJCP	(T)

3. On-Line Transfer Service

	Monthly Rate	Nonrecurring Charge	USOC
(a) service establishment charge	\$-	\$891.00	OLT
(b) per month, per IC	500.00	-	OLT

## E13. ADDITIONAL ENGINEERING, ADDITIONAL LABOR AND MISCELLANEOUS CHARGES

### E13.3 Miscellaneous Services (Cont'd)

#### E13.3.3 BellSouth Equal Access Subscription

F. (DELETED)

(D)

#### E13.3.4 Standard Jacks - Registration Program

A. Provision of Standard Jacks

Standard jacks are provided by each company to connect Registered Equipment to those services that are subject to the Registration Program as set forth in Technical Reference Publication AS No. 1. The use of jacks is covered in Part 68 of the FCC's Rules and Regulations. Specific jacks are described in the document on file with the FCC entitled "Descriptions of Standard Registration Program Connection Configurations Supplementing Configurations Described in Subpart F of Part 68 of the FCC's Rules and Regulations".

B. Use of Standard Jacks

These jacks are used to terminate services provided by each company. Other Services or Facilities provided by the Company or by others may also be terminated in any spare capacity of the arrangements remaining after installation without additional charge for the use of such capacity.

C. Rates and Charges

The nonrecurring charges which include installation for standard jacks and their typical uses are set forth following:

1. Standard Voice Jacks

a. Miniature six position jacks for connection of terminal equipment as follows:

- (1) Single line telephone set surface or flush mounted.

**Nonrecurring  
Charge**

**USOC  
RJ11C**

- (a) Each

- (2) Single line telephone sets wall mounted.

**E13. ADDITIONAL ENGINEERING, ADDITIONAL LABOR AND MISCELLANEOUS CHARGES<sup>1</sup>**

(N)

**E13.3 Miscellaneous Services (Cont'd)**

**E13.3.4 Standard Jacks - Registration Program (Cont'd)**

**C. Rates and Charges (Cont'd)**

**1. Standard Voice Jacks (Cont'd)**

**a. Miniature six position jacks for connection of terminal equipment as follows: (Cont'd)**

**(2) Single line telephone sets wall mounted. (Cont'd)**

	Nonrecurring Charge	USOC
(a) Each	\$-	RJ11W
(3) Two-line nonkey telephone sets surface or flush mounted.		
(a) Each	-	RJ14C
(4) Single line 4-wire exchange, T/R, T1/R1.		
(a) Each	-	RJ1DC
(5) Two-line nonkey telephone sets wall mounted.		
(a) Each	-	RJ14W
(6) Special single line equipment for use in hospital critical care areas.		
(a) Each	6.47	RJ17C
(7) 9DB single line data equipment with mode indication and mode indication common leads. This jack is normally used in association with a series jack. <sup>2</sup>		
(a) Each	-	RJ16X
(8) Three-line nonkey telephone sets and ancillary devices.		
(a) Each	2.50	RJ25C
(9) Single-line nonkey telephone and ancillary devices connected directly to central office lines where there is a requirement for make-busy.		
(a) Portable wall mounted equipment, each	6.74	RJ18W
(b) All other, each	6.54	RJ18C
(10) For connection of two Access Services with provisions for testing each service with a standard single line telephone set. <sup>3</sup>		
(a) Each	-	RJ14X
b. 50 Position Miniature Ribbon Jacks for connection of multiline terminating equipment and channel derivation devices as follows:		
(1) For connection to 2-wire tie trunks E&M type I signaling. (12 line capacity)		
(a) Each	71.75	RJ2EX

**Note 1:** Text is shown as new due to reissue of all Tariff Sections. No changes in rates or regulations were made with this filing.

**Note 2:** Not suitable for use as a Network Interface.

**Note 3:** The Company will wire the lines to the jack in the sequence designated by the IC or end user.

**E13. ADDITIONAL ENGINEERING, ADDITIONAL LABOR AND  
 MISCELLANEOUS CHARGES<sup>1</sup>**

(N)

**E13.3 Miscellaneous Services (Cont'd)**

**E13.3.4 Standard Jacks - Registration Program (Cont'd)**

**C. Rates and Charges (Cont'd)**

**1. Standard Voice Jacks (Cont'd)**

**b. 50 Position Miniature Ribbon Jacks for connection of multiline terminating equipment and channel derivation devices as follows: (Cont'd)**

(2) For connection to 4-wire tie trunks E&M type I signaling. (8 line capacity)

(a) Each

<b>Nonrecurring Charge</b>	<b>USOC</b>
<b>\$71.75</b>	<b>RJ2GX</b>

(3) For connection to 2-wire tie trunks E&M type II signaling. (8 line capacity)

(a) Each

71.75	RJ2FX
-------	-------

(4) For connection to 4-wire tie trunks E&M type II signaling. (6 line capacity)

(a) Each

71.75	RJ2HX
-------	-------

(5) For connection to off-premises station lines. (25 line capacity)

(a) Each

71.75	RJ21X
-------	-------

(6) For use with series devices such as toll restrictors. (12 line capacity)<sup>2</sup>

(a) Each

19.82	RJ71C
-------	-------

(7) For connection of up to 12 line 4-wire exchange, T/R, T1/R1.

(a) Each

71.75	RJ2DX
-------	-------

(8) For connection of two 12 line nonkey telephone and ancillary devices connected directly to central office lines where there is a requirement for make-busy.

(a) Each

16.97	RJ2MB
-------	-------

**c. Series Jacks for connection of terminal equipment as follows:<sup>2</sup>**

(1) Single line alarm reporting devices.

(a) Each

23.25	RJ31X
-------	-------

(2) Series ancillary devices such as automatic dialers. Single line sets with exclusion.

(a) Each

10.25	RJ32X
-------	-------

(3) Two-line telephone sets with exclusion on one line.

(a) Each

10.25	RJ37X
-------	-------

(4) Miniature Eight-Position Series Jack for connection of alarm reporting devices.

(a) Each

10.25	RJ38X
-------	-------

**d. Weatherproof Jack used at locations such as boats and marinas.**

(1) For use with single line telephone sets.

**Note 1:** Text is shown as new due to reissue of all Tariff Sections. No changes in rates or regulations were made with this filing.

**Note 2:** Not suitable for use as a Network Interface.

EFFECTIVE: July 15, 1996

**E13. ADDITIONAL ENGINEERING, ADDITIONAL LABOR AND MISCELLANEOUS CHARGES<sup>1</sup>**

(N)

**E13.3 Miscellaneous Services (Cont'd)**

**E13.3.4 Standard Jacks - Registration Program (Cont'd)**

**C. Rates and Charges (Cont'd)**

**1. Standard Voice Jacks (Cont'd)**

**d. Weatherproof Jack used at locations such as boats and marinas. (Cont'd)**

(1) For use with single line telephone sets. (Cont'd)

(a) Each

<b>Nonrecurring Charge</b>	<b>USOC</b>
<b>\$25.50</b>	<b>RJ15C</b>

**e. Miniature Eight-Position Jack.**

(1) For connection of four line nonkey telephone sets, ancillary devices and key telephone systems.

(a) Each

<b>8.06</b>	<b>RJ61X</b>
-------------	--------------

**2. Standard Data Jacks**

(a) Universal Data Jack for use in connecting fixed loss loop (FLL) and programmed (P) types of data equipment. (1 line capacity)

<b>65.50</b>	<b>RJ41S</b>
--------------	--------------

(b) Programmed Data Jack for use in connecting programmed data equipment. (1 line capacity)

<b>55.25</b>	<b>RJ45S</b>
--------------	--------------

(c) Multiple Line Universal Data Jack for use in connecting fixed loss loop (FLL) and programmed (P) types of data equipment. This jack will terminate up to eight lines. The selection of this jack requires the use of the equipment listed in (d) and (e) following.

<b>176.25</b>	<b>RJ26X</b>
---------------	--------------

(d) Multiple Line Universal Data Jack Circuit Cards. For use with RJ26X. One circuit card per circuit required.

<b>45.00</b>	<b>RJ26S</b>
--------------	--------------

(e) Multiple Line Universal Data Jack Mounting options. For use with RJ26X. One required per RJ26X.

<b>-</b>	<b>NA</b>
----------	-----------

(f) Wall Mounting with cover.

<b>41.90</b>	<b>RJM3X</b>
--------------	--------------

(g) Rack Mounting (19 inch or 23 inch)

<b>270.98</b>	<b>RJM4X</b>
---------------	--------------

(h) Miniature Eight-Position Keyed Jack for connection of local area data channels and/or Digital Access Services.

<b>8.06</b>	<b>RJ48S</b>
-------------	--------------

(i) Miniature Eight-Position Keyed Jack for connection of Access Services to Programmed Data Terminal Equipment equipped with make busy levels.

<b>20.63</b>	<b>RJ4MB</b>
--------------	--------------

(j) Miniature Fifty-Position Ribbon Jack for connection of local area data channels and/or Digital Data Access Services.<sup>2</sup>

<b>16.97</b>	<b>RJ48T</b>
--------------	--------------

**Note 1:** Text is shown as new due to reissue of all Tariff Sections. No changes in rates or regulations were made with this filing.

**Note 2:** Not suitable for use as a Network Interface.

ISSUED: July 1, 1996  
BY: Joseph P. Lacher, President - FL  
Miami, Florida

EFFECTIVE: July 15, 1996

**E13. ADDITIONAL ENGINEERING, ADDITIONAL LABOR AND MISCELLANEOUS CHARGES<sup>1</sup>**

(N)

**E13.3 Miscellaneous Services (Cont'd)**

**E13.3.4 Standard Jacks - Registration Program (Cont'd)**

**C. Rates and Charges (Cont'd)**

**2. Standard Data Jacks (Cont'd)**

	<b>Nonrecurring Charge</b>	<b>USOC</b>
(k) Multiple Line Programmed Data Jack for use in connecting Programmed data equipment.	<b>\$190.75</b>	<b>RJ45M</b>
(l) Multiple Line Universal Data Jack for use in Programmed (P) types of data equipment. This jack will terminate up to eight lines.	<b>190.75</b>	<b>RJ41M</b>
(m) Miniature Fifty-Position Ribbon Jack for use in connecting Programmed (P) types of equipment.	<b>57.00</b>	<b>RJ27X</b>
<b>3. Standard Digital Jacks</b>		
(a) Miniature Eight-Position Jack for connection of 1.544 Mbps Digital Services.	<b>7.96</b>	<b>RJ48C</b>
(b) Miniature Fifty-Position Ribbon Jack for connection of 1.544 Mbps Digital Services.	<b>16.97</b>	<b>RJ48M</b>
(c) Miniature Fifty-Position Ribbon Jack for connection of up to twelve four wire 1.544 Mbps digital lines. <sup>2</sup>	<b>19.82</b>	<b>RJ48H</b>
(d) Miniature Eight-Position Jack with Shorting Bars for connection of 1.544 Mbps Digital Services.	<b>8.27</b>	<b>RJ48X</b>
<b>4. Standard Non-Registration Jacks</b>		
(a) Single Private Line for connection of two/four wire T/R; T/R, T1/R1, TEK/TEK. Eight-Position Keyed Jack with/without loop back.	<b>8.06</b>	<b>JM8</b>

**E13.3.5 Testing Services**

- A.** The Company will, in addition to any IC or End User requested acceptance testing, perform such tests as it believes necessary to insure that the access services ordered by an IC or End User are functioning properly prior to turning over such access services to the IC or End User. In addition, the Company, as part of the ongoing work to maintain the continued satisfactory performance of the access services ordered by the IC or End User, may perform periodic tests.

**Note 1:** Text is shown as new due to reissue of all Tariff Sections. No changes in rates or regulations were made with this filing.

**Note 2:** Not suitable for use as a Network Interface.

## E13. ADDITIONAL ENGINEERING, ADDITIONAL LABOR AND MISCELLANEOUS CHARGES (T)

### E13.3 Miscellaneous Services (Cont'd)

#### E13.3.5 Testing Services (Cont'd)

##### A. (Cont'd)

Testing Services offered under this section of the Tariff are optional and subject to rates and charges as set forth in E13.3.5.F following. Payment for *BellSouth SWA* testing is the responsibility of the IC. Payment for Dedicated Access testing is the responsibility of the End User. Other testing services provided by the Company in association with Access Services are furnished at no additional charge. These other testing services are described in E6.1.6 and E7.1.7 preceding. preceding. (T)

##### B. Testing services are normally provided by Company personnel at Company locations. However, provisions are made in D.6. and E.2. following for an IC or End User to request Company personnel to perform testing services at the IC terminal location or the End User's premises.

Testing charges which are time sensitive apply per Company employee performing billable work at the IC's or End User's request. The sum of the time is used to determine the number of 30-minute increments to be billed. Only one initial increment is to be billed per request. A request for additional labor by a Company employee at a time not consecutive with the employee's scheduled work period is subject to a minimum charge of three hours.

##### C. The offering of Testing Services under this section of the Tariff is made subject to the availability of the necessary qualified personnel and test equipment at the various test locations mentioned in D., E., and F. following:

##### D. *BellSouth SWA* Service (T)

###### 1. Categories of Tests (T)

Testing Services for *BellSouth SWA* are comprised of (a) tests which are performed during the installation of a *BellSouth SWA* Service, and (b) tests which are performed after acceptance of such access services by an IC, i.e., in-service tests. These in-service tests may be further divided into two broad categories of tests: scheduled and nonscheduled. (T)

###### a. Scheduled Tests (T)

Scheduled tests are those tests performed by the Company on a regular basis, e.g., monthly, which result in the measurement of *BellSouth SWA* Service. Scheduled tests may be done on an automatic basis (no Company or IC technician(s) involved), on a cooperative basis (Company technician(s) involved at Company office(s) and IC technician(s) involved at the IC's terminal location(s)), or on a manual basis (Company technician(s) involved at Company office(s) and at the IC's terminal location(s)). (T)

###### b. Nonscheduled Tests (T)

Nonscheduled tests are performed by the Company "on demand", which result in the measurement of *BellSouth SWA* Services. Nonscheduled tests may involve Company technicians at Company offices and at the IC's terminal location. (T)

###### 2. Additional Cooperative Acceptance Testing

a. Additional Cooperative Acceptance Testing (ACAT) of *BellSouth SWA* Service involves the Company provision of a technician at its office(s) and the IC provision of a technician at its terminal location(s), with suitable test equipment to perform the required tests. (T)

(M)



ISSUED: December 19, 2013

EFFECTIVE: December 20, 2013

BY: Marshall M. Criser III, President -FL  
Miami, Florida

## E13. ADDITIONAL ENGINEERING, ADDITIONAL LABOR AND MISCELLANEOUS CHARGES

### E13.3 Miscellaneous Services (Cont'd)

#### E13.3.5 Testing Services (Cont'd)

##### D. *BellSouth SWA* Service (Cont'd)

2. Additional Cooperative Acceptance Testing (Cont'd)
  - b. Additional Cooperative Acceptance Tests may, for example, consist of the following tests:
    - Impulse Noise
    - Phase Jitter
    - Signal To C-Notched Noise Ratio
    - Intermodulation (Nonlinear) Distortion
    - Frequency Shift (Offset)
    - Envelope Delay Distortion
    - Dial Pulse Percent Break
3. Automatic Scheduled Testing
  - a. Automatic Scheduled Testing (AST) of *BellSouth SWA* services (*BellSouth SWA FGD* and *BellSouth SWA TSBSA 3*), where the IC provides remote office test lines and 105 test lines with associated responders or their functional equivalent, will consist of monthly loss and C-message or C-notched noise tests. (D)  
  
However, the IC may specify a greater number of tests. In addition to the loss and noise tests, the IC may also order, at additional charges, gain-slope and balance testing.
  - b. The Company will provide a monthly AST report that lists the test results for each trunk tested.<sup>1</sup>
4. Cooperative Scheduled Testing
  - a. Cooperative Scheduled Testing (CST) of *BellSouth SWA* services (*BellSouth SWA FGD* and *BellSouth SWA TSBSA 3* and *BellSouth Directory Assistance* Access Service not routed through an access tandem), where the Company provides a technician at its office(s) and the IC provides a technician at its terminal location(s) with suitable test equipment to perform the required tests, will consist of quarterly loss and C-message or C-notched noise tests. However, the IC may specify a greater number of tests. In addition to the loss and noise tests, the IC may also order, at additional charges, gain-slope and balance testing. (D)
  - b. The Company will provide, on a quarterly basis, a CST report that lists the test results for each trunk tested.<sup>2</sup>
5. Manual Scheduled Testing
  - a. Manual Scheduled Testing (MST) of *BellSouth SWA* services (*BellSouth SWA FGB*, *BellSouth SWA FGD*, *BellSouth SWA TSBSA 1*, *BellSouth SWA TSBSA 3* and *BellSouth Directory Assistance* Access Service not routed through an access tandem), where the Company provides a technician at its office(s) and at the IC's terminal location, will consist of quarterly loss and C-message or C-notched noise tests. However, the IC may specify a greater number of tests. In addition to the loss and noise tests, the IC may also order, at additional charges, gain-slope and balance testing.

**Note 1:** Trunk test failures requiring IC participation for trouble resolution will be provided to the IC on an as-occurs basis.

ISSUED: February 14, 1997  
BY: Joseph P. Lacher, President -FL  
Miami, Florida

EFFECTIVE: March 1, 1997

## E13. ADDITIONAL ENGINEERING, ADDITIONAL LABOR AND MISCELLANEOUS CHARGES

### E13.3 Miscellaneous Services (Cont'd)

#### E13.3.5 Testing Services (Cont'd)

##### D. *BellSouth SWA* Service (Cont'd)

##### 5. Manual Scheduled Testing (Cont'd)

- b. The Company will provide, on a quarterly basis, an MST report that lists the test results for each trunk tested.<sup>1</sup>

##### 6. Nonscheduled Testing

- a. Nonscheduled Testing (NST) of Switched Access Services is where:

- (1) The IC provides remote office test lines and 105 test lines with associated responders or their functional equivalent ("automatic testing"), or
- (2) The Company provides a technician at its office(s) and the IC provides a technician at its terminal location(s), with suitable test equipment to perform the required tests ("cooperative testing"), or
- (3) The Company provides a technician at its office(s) and/or at the IC's terminal location(s) with suitable test equipment to perform the required tests ("manual testing").

- b. Nonscheduled Tests, may consist of any tests, e.g., loss, noise, slope, envelope delay,<sup>2</sup> or balance which the IC may require.

##### 7. Obligations of the IC

- a. The IC shall provide the Remote Office Test Line priming data to the Company, as appropriate, to support AST as set forth in 3. preceding or NST as set forth in 6. preceding.
- b. The IC shall make the facilities to be tested available to the Company at times mutually agreed upon.
- c. Access to the test lines for *BellSouth SWA FGD* or *BellSouth SWA* TSBSA3 service should follow protocols recommended in Technical Reference TR-NPL-00258.

##### E. Dedicated Access Service

The Company will, at the request of an IC or End User, provide assistance in performing specific tests requested by the IC or End User.

##### 1. Additional Cooperative Acceptance Testing (ACAT)

When an IC provides a technician at its terminal location or its End User's premises, with suitable test equipment to perform the required tests, the Company will provide a technician at its office for the purpose of conducting Additional Cooperative Acceptance Testing on voice grade services. At the IC's or End User's request, the Company will provide a technician at the IC terminal location or at the End User's premises. These tests may, e.g., consist of the following:

- a. VG1 through VG 5 : Attenuation Distortion, C-Message Noise and Echo Control

**Note 1:** Trunk test failures requiring IC participation for trouble resolution will be provided to the IC on an as-occurs basis.

**Note 2:** Envelop delay tests are not available with Automatic Testing.

**E13. ADDITIONAL ENGINEERING, ADDITIONAL LABOR AND MISCELLANEOUS CHARGES**

**E13.3 Miscellaneous Services (Cont'd)**

**E13.3.5 Testing Services (Cont'd)**

**E. Dedicated Access Service (Cont'd)**

1. Additional Cooperative Acceptance Testing (ACAT) (Cont'd)
  - b. VG6 through VG 12: Attenuation Distortion, C-Message Noise, Echo Control Impulse Noise, Phase Jitter, Intermodulation Distortion, Envelope Delay Distortion and Frequency Shift.
2. Nonscheduled Testing (NST)
 

When an IC provides a technician at its terminal location and/or the End User provides a technician at its premises, with suitable test equipment to perform the required tests, the Company will provide a technician at its office for the purpose of conducting Nonscheduled Testing. At the IC's or End User's request, the Company will provide a technician at the IC terminal location or at the End User's premises. Nonscheduled Tests, may consist of any tests, e.g., loss, noise, slope, envelope delay, which the IC or End User may require.
3. Obligation of the IC and End User
 

When the IC or End User subscribes to Testing Service as set forth in this section, the IC or End User shall make the facilities to be tested available to the Company at times mutually agreed upon.

**F. Rates and Charges**

1. **BellSouth SWA**
  - a. Additional Cooperative Acceptance Testing
    - (1) Testing Periods

	<b>First Half Hour Or Fraction Thereof</b>	<b>Each Additional Half Hour Or Fraction Thereof</b>	<b>USOC</b>
(a) Basic Time ( normally scheduled working hours.)	\$43.75	\$17.54	UBCX+
(b) Overtime (Outside normally scheduled working hours on a scheduled work day.)	47.02	20.81	UBCX+
(c) Premium Time, outside scheduled work day.	50.29	24.08	UBCX+

b. Automatic Scheduled Testing (AST)

AST requires a minimum yearly contract for twelve 1004 Hz Loss Tests and twelve C-Message or C-Notched Noise Tests per circuit. However, at the IC's option, a greater number of tests may be contracted for. As illustrated in the following example, billing for each test ordered will be spread over a twelve month period. Optional tests, as set forth in (2) following, may be contracted for at additional charges. Sixty (60) days notice is required when a request for a greater number of tests or additional tests is made subsequent to the initial order.

**E13. ADDITIONAL ENGINEERING, ADDITIONAL LABOR AND MISCELLANEOUS CHARGES**

**E13.3 Miscellaneous Services (Cont'd)**

**E13.3.5 Testing Services (Cont'd)**

**F. Rates and Charges (Cont'd)**

**1. BellSouth SWA (Cont'd)**

**b. Automatic Scheduled Testing (AST) (Cont'd)**

(1) To first point of switching, Basic Tests<sup>1</sup> per test ordered, per year

	Monthly Rate	USOC
(a) 1004 Hz Loss, per circuit	\$.06	UBGX+
(b) C-Message Noise, per circuit	.06	UBGX+
(c) C-Notched Noise, per circuit	.06	UBGX+
(2) To first point of switching, Optional Tests, per test ordered, per year		
(a) Return Loss (Balance), per circuit	.06	UBGX+
(b) Gain-Slope, per circuit	.06	UBGX+

Example - At a minimum, an IC would schedule 12 1004 Hz Loss Tests and 12 C-Message Noise Tests or 12 1004 Hz Loss Tests and 12 C-Notched Noise Tests, for a total of 24 Basic Tests per circuit per year. The charges would be computed on a monthly basis as follows:

Min. Basic Tests Per Year (24) x Mo. Rate Per Test (\$.06) = Min. Mo. Charge (\$1.44)

**c. Cooperative Scheduled Testing (CST)**

CST requires a minimum yearly contract for four 1004 Hz Loss Tests and four C-Message or C-Notched Noise Tests per circuit. However, at the IC's option, a greater number of tests may be contracted for. As illustrated in the following example, each test ordered will be billed to the IC on a monthly basis over a twelve month period. Optional tests, as set forth in (2) following may be contracted for at additional charges. Sixty (60) days notice is required when a request for a greater number of tests or additional tests is made subsequent to the initial order.

(1) To first point of switching, Basic Tests<sup>1</sup> per test ordered, per year

(a) 1004 Hz Loss, per circuit	.34	UBSX+
(b) C-Message Noise, per circuit	.25	UBSX+
(c) C-Notched Noise, per circuit	.25	UBSX+
(2) To first point of switching, Optional Tests, per test ordered, per year		
(a) Return Loss (Balance), per circuit	.55	UBSX+
(b) Gain-Slope, per circuit	.34	UBSX+

Example - At a minimum an IC would schedule 4 1004 Hz Loss Tests and 4 C-Message Noise Tests or 4 1004 Hz Loss Tests and 4 C-Notched Noise Tests for a total of 8 Basic Tests per circuit per year. The charges would be computed on a monthly basis as follows:

**Note 1:** Subject to a one year minimum contract period and annually thereafter.

**E13. ADDITIONAL ENGINEERING, ADDITIONAL LABOR AND  
 MISCELLANEOUS CHARGES**

**E13.3 Miscellaneous Services (Cont'd)**

**E13.3.5 Testing Services (Cont'd)**

**F. Rates and Charges (Cont'd)**

**1. BellSouth SWA (Cont'd)**

**c. Cooperative Scheduled Testing (CST) (Cont'd)**

(2) To first point of switching, Optional Tests, per test ordered, per year (Cont'd)

$$4 \times .34 = 1.36$$

$$+ 4 \times .25 = 1.00$$

Total equals \$2.36 per month, per circuit.

**d. Manual Scheduled Testing (MST)**

MST requires a minimum yearly contract for four 1004 Hz Loss Tests and four C-Message, or C-Notched Noise Tests per circuit. However, at the IC's option a greater number of tests may be contracted for. As illustrated in the following example, each test ordered will be billed to the IC on a monthly basis over a twelve month period. Optional tests, as set forth in (2) following, may be contracted for at additional charges. Sixty (60) days notice is required when a request for a greater number of tests or additional tests is made subsequent to the initial order.

(1) To first point of switching, Basic Tests<sup>1</sup> per test ordered, per year

	Monthly Rate	USOC
(a) 1004 Hz Loss, per circuit	\$ .90	UBMX+
(b) C-Message Noise, per circuit	.59	UBMX+
(c) C-Notched Noise, per circuit	.59	UBMX+
(2) To first point of switching, Optional Tests, per test ordered, per year		
(a) Return Loss (Balance), per circuit	1.20	UBMX+
(b) Gain-Slope, per circuit	.90	UBMX+
Example - See 1.c. preceding.		

**e. Nonscheduled Testing (NST)**

(1) Automatic Testing, to first point of switching, per test performed:

	Rate	USOC
(a) 1004 Hz Loss	\$12.44	USCX+
(b) C-Message Noise	12.44	USCX+
(c) Return Loss (Balance)	12.44	USCX+
(d) Gain-Slope	12.44	USCX+
(e) C-Notched Noise	12.44	USCX+

**Note 1:** Subject to a one year minimum contract period and annually thereafter.

**E13. ADDITIONAL ENGINEERING, ADDITIONAL LABOR AND  
MISCELLANEOUS CHARGES**

**E13.3 Miscellaneous Services (Cont'd)**

**E13.3.5 Testing Services (Cont'd)**

**F. Rates and Charges (Cont'd)**

**1. BellSouth SWA (Cont'd)**

**e. Nonscheduled Testing (NST) (Cont'd)**

**(2) Cooperative Testing, Testing Periods**

	<b>First Half Hour Or Fraction Thereof</b>	<b>Each Additional Half Hour Or Fraction Thereof</b>	<b>USOC</b>
(a) Basic time, normally scheduled working hours	\$43.75	\$17.54	USSX+
(b) Overtime, outside normally scheduled working hours on a scheduled work day	47.02	20.81	USSX+
(c) Premium time, outside scheduled work day	50.29	24.08	USSX+
<b>(3) Manual Testing, Testing Periods</b>			
(a) Basic time, normally scheduled working hours	43.93	17.72	USMX+
(b) Overtime, outside normally scheduled working hours on a scheduled work day	47.12	20.91	USMX+
(c) Premium time, outside scheduled work day	50.31	24.10	USMX+

**2. Dedicated Access Services**

**a. Additional Cooperative Acceptance Testing (ACAT)**

**(1) Applies to the following tests:**

VG1 through 5 : Attenuation Distortion, C-Message Noise and Echo Control

VG6 through 12: Attenuation Distortion, C-Message Noise, Echo Control Impulse Noise, Phase Jitter, Intermodulation Distortion, Envelope Delay Distortion and Frequency Shift

Testing Periods

(a) Basic time, Work related efforts of the Telephone Company performed during a Normal Business Day.	44.12	17.91	SNTX+
(b) Overtime, Work related efforts of the Telephone Company performed outside a Normal Business Day and on Saturdays.	47.22	21.01	SNTX+
(c) Premium time, Work related efforts of the Telephone Copmany performed on Sundays and Holidays.	50.33	24.12	SNTX+

**b. Nonscheduled Testing (NST)**

**(1) Testing Periods**

(C)  
|  
(C)

ISSUED: August 22, 2013  
BY: Marshall M. Criser III, President -FL  
Miami, Florida

EFFECTIVE: August 23, 2013

**E13. ADDITIONAL ENGINEERING, ADDITIONAL LABOR AND  
MISCELLANEOUS CHARGES<sup>1</sup>**

**E13.3 Miscellaneous Services (Cont'd)**

**E13.3.5 Testing Services (Cont'd)**

- F. Rates and Charges (Cont'd)
  - 2. Dedicated Access Services (Cont'd)
    - b. Nonscheduled Testing (NST) (Cont'd)
      - (1) Testing Periods (Cont'd)

	<b>First Half Hour Or Fraction Thereof</b>	<b>Each Additional Half Hour Or Fraction Thereof</b>	<b>USOC</b>
(a) Basic time Work related efforts of the Telephone Company performed during a Normal Business Day.	\$44.12	\$17.91	SNOX+
(b) Overtime Work related efforts of the Telephone Company performed outside a Normal Business Day and on Saturdays.	47.22	21.01	SNOX+
(c) Premium time Work related efforts of the Telephone Company performed on Sundays and Holidays.	50.33	24.12	SNOX+

(C)  
|  
(C)

**E13.3.6 Provision of Access Service Billing Information**

- A. The IC or End User will receive monthly access bills in a standard paper format at no additional charge.
- B. At the option of the IC or End User, and for an additional charge, billing detail may be provided on magnetic tape or microfiche, or transmitted to the IC's or End User's premises by data transmission.
- C. Rates and charges for microfiche and for data transmission (including the period of time to implement the transmission of such material) will be determined on an individual case basis (ICB).
- D. The IC or End User may, for additional charges, request additional copies of the access bill, and/or the IC or End User service record (CSR). These copies may be provided in standard paper format or microfiche format.
- E. A maximum of eight additional paper copies of the access bill may be requested and all copies will be sent to the IC's or End User's billing address. Rates for paper copies are on a per page basis.
- F. A maximum of 99 copies of the access bill will be provided in microfiche format. Unless otherwise specified by the IC or End User, microfiche copies will be sent to the IC's or End User's billing address.
- G. Only one copy of the magnetic tape will be provided. The magnetic tape will be provided by the Company without requiring the IC or End User to return previously supplied tapes.
- H. A Service Establishment Charge for additional paper copies and for magnetic tape applies on a per request basis. Any change in the original request will be considered a new request and a Service Establishment Charge will apply.

**Note 1:** Text is shown as new due to reissue of all Tariff Sections. No changes in rates or regulations were made with this filing.

<sup>®</sup> Registered Service Mark of BellSouth Intellectual Property Corporation

**E13. ADDITIONAL ENGINEERING, ADDITIONAL LABOR AND MISCELLANEOUS CHARGES<sup>1</sup>**

(N)

**E13.3 Miscellaneous Services (Cont'd)**

**E13.3.6 Provision of Access Service Billing Information (Cont'd)**

- I. Unless otherwise specified by the IC or End User, paper copies or magnetic tape will be sent via U.S. Mail service. However, at the IC's or End User's request, the IC or End User or the IC's or End User's representative may pick up the paper copies or tape at a location designated by the Company.
- J. The IC or End User may deem it necessary to request the Company resend the access service billing information. Such a request, when not the result of Company error, will be subject to the same rates and charges as the original request. These are set forth in K. following.
- K. The following rates are applicable for the provision of Access Service Billing Information:
  1. Provision of Standard Billing Detail and/or Information in magnetic tape format

	Service Establishment Charge	Monthly Rate	USOC
(a) Per request <sup>2</sup>	\$-	\$-	NA
(b) Per Tape <sup>2</sup>	-	-	NA
(c) Per record <sup>2</sup>	-	-	NA
2. Data transmission to an IC terminal location of Billing Detail and/or Information			
(a) Per record transmitted <sup>2</sup>	-	-	NA
3. Additional copies of IC monthly bill or service and features record in standard paper or microfiche format			
(a) Per page <sup>2</sup>	-	-	NA
(b) Per microfiche record <sup>2</sup>	-	-	NA

**E13.3.7 Protective Connecting Arrangements**

- A. See each company's Local and/or General Subscriber Service Tariff for Rates and Regulations.

**E13.3.8 Controller Arrangement**

- A. This arrangement enables the IC to control up to 48 transfer functions at a Company central office via a CPE remote keyboard terminal capable of either 300 or 1200 bps operation. Included as part of the Controller Arrangement is a dial-up data station located at the Company Central Office to provide access to the Controller Arrangement. The dial-up data station consists of a 212A DATAPHONE data set and an appropriate Company provided channel.
  1. The Controller Arrangement must be located in the same Company central office as the transfer functions which it controls.

	Monthly Rate	USOC
(a) Controller Arrangement, <sup>2</sup> each	\$-	XTDDU

**Note 1:** Text is shown as new due to reissue of all Tariff Sections. No changes in rates or regulations were made with this filing.

**Note 2:** Rates and charges based on individual cases will apply.



## E13. ADDITIONAL ENGINEERING, ADDITIONAL LABOR AND MISCELLANEOUS CHARGES<sup>1</sup>

### E13.3 Miscellaneous Services (Cont'd)

#### E13.3.9 Telecommunications Service Priority (TSP) System

##### A. Service Description

1. The Telecommunications Service Priority (TSP) System is a structured coding scheme that prescribes the order in which National Security Emergency Preparedness (NSEP) telecommunications services are installed or restored. TSP service is limited to qualifying state and local governments, the federal government, foreign governments and certain private industry telecommunications services. The Company can only accept orders for TSP service from holders of valid TSP Authorization Codes. TSP Authorization Codes are administered by The Manager, National Communications System (TSP Program Office), Washington, D.C. 20305-2010. The TSP System was developed to support the requirements of the U. S. Government and applies only to NSEP telecommunications services to which the Company is able to apply priority treatment. It requires and authorizes priority action by the Company.
2. Conditions of emergency or crises that cause invocation of NSEP treatment can only be declared by authorized officials of the Federal Government or other officials (Federal or non-Federal) specified by the Manager – Office of Emergency Communications (OEC) on behalf of the Executive Office of the President of the United States. (T)  
(T)

##### B. Service Limitations

1. Priority installation and/or restoration of NSEP telecommunications services shall be provided in accordance with Part 64.401, Appendix A, of the Federal Communications Commission's Rules and Regulations.  
In addition, TSP System service shall be provided in accordance with the guidelines set forth in "Telecommunications Service Priority (TSP) System for National Security Emergency Preparedness (NSEP) Service User Manual" (OEC manual 3-1-1 dated July 9, 1990) and "Telecommunications Service Priority (TSP) System for National Security Emergency Preparedness (NSEP) Service Vendor Handbook" (OEC manual 3-1-2 dated July 9, 1990). (T)  
(T)
2. The customer for the TSP System service must also be the same customer for the underlying Access Service with which it is associated.
3. The Company will arrange for the installation and/or restoration of TSP System service upon receipt of the proper certification as specified in 1. preceding.
4. It is the responsibility of the TSP user to provide the TSP Authority Code to the Company with each service request.
5. When performing Priority Installation or Priority Restoration (repair) on TSP-designated services in compliance with the Rules and Regulations cited in 1. preceding, the Company may not be in a position to notify the customer regarding additional labor charges if additional labor is required. The customer recognizes that quoting charges and obtaining permission to proceed with the installation or restoration of service may cause unnecessary delays and grants the Company the right to quote charges after the installation or restoration has been completed.

**Note 1:** Text is shown as new due to reissue of all Tariff Sections. No changes in rates or regulations were made with this filing.

ISSUED: September 20, 2013

EFFECTIVE: September 21, 2013

BY: Marshall M. Criser III, President -FL  
Miami, Florida

## E13. ADDITIONAL ENGINEERING, ADDITIONAL LABOR AND MISCELLANEOUS CHARGES<sup>1</sup>

### E13.3 Miscellaneous Services (Cont'd)

#### E13.3.9 Telecommunications Service Priority (TSP) System (Cont'd)

##### C. Rules and Regulations

1. Under certain conditions, it may be necessary to preempt one or more customer services with a lower (or no) restoration priority in order to install or restore NSEP telecommunications service(s). If preemption is necessary and if circumstances permit, the Company will make every reasonable effort to notify the preempted customer of the action to be taken. Credit allowance for service preemption will adhere to the provisions appearing in E2.5 of this Tariff.
2. No charge applies when a TSP designation is discontinued.
3. With the exception of credit information, a customer obtaining TSP System service acknowledges and consents to the provision of certain customer service details by the Company to the Federal Government to allow for the proper maintenance and administration of the TSP System. That information includes but is not necessarily limited to:
  - Confirmation of completed TSP service orders directly to the Manager, Office of Emergency Communications (OEC); (T)
  - Verification of installation and/or restoration priority level assignment(s) with the Manager, OEC; (T)
  - Reconciliation of TSP service information with the Manager, OEC, or the customer (prime service vendor). (T)

##### D. Definitions

###### Office of Emergency Communications (OEC) (T)

The OEC is established under the Executive Office of the President of the United States and is responsible for the day-to-day operations of the TSP System. This includes maintaining a twenty-four hour point-of-contact to handle emergency provisioning requests, assigning priority levels and Authorization Codes and maintaining data on TSP assignments. (T)

###### National Security Emergency Preparedness (NSEP) Services

NSEP services are telecommunications services that are used to maintain a state of readiness or to respond to and manage any events or crises (local, national or international) which causes or could cause injury or harm to the population, damage to or loss of property, or degrade or threaten the NSEP posture of the United States.

###### Prime Vendor

The service vendor from whom the service user or its authorized agent orders service.

###### Priority Installation (PI)

Provisioning, on a priority basis, of a new TSP service authorized as so urgent that it must be provided earlier than the Company's standard provisioning interval.

###### Priority Restoration (PR)

Restoration, on a priority basis, of an existing TSP service for which any interruption would have serious adverse impact on the supported NSEP function.

**Note 1:** Text is shown as new due to reissue of all Tariff Sections. No changes in rates or regulations were made with this filing.

**E13. ADDITIONAL ENGINEERING, ADDITIONAL LABOR AND MISCELLANEOUS CHARGES<sup>1</sup>**

(N)

**E13.3 Miscellaneous Services (Cont'd)**

**E13.3.9 Telecommunications Service Priority (TSP) System (Cont'd)**

**D. Definitions (Cont'd)**

**Subcontractor**

The service vendor from whom the prime vendor obtains service for the completion of the prime vendor's end-to-end service.

**Telecommunications Service Priority (TSP) System**

TSP is a structured coding scheme that establishes the order in which NSEP services are to be installed or restored in the event of an emergency. The TSP System was developed to ensure priority treatment of the nation's most important telecommunications services.

**TSP Authorization Code**

A twelve character code that identifies an NSEP TSP service and denotes the order in which that service is to be provisioned (installed) and/or restored.

**E. TSP Rate Categories**

1. There are two basic rate categories which apply to TSP System service:

- a. Priority Installation
- b. Priority Restoration
  - Level Implementation
  - Level Change
  - Maintenance/Administration

2. Certain activities associated with the TSP System are included in the rate elements as follows:

- a. Priority Installation includes order coordination.
- b. Priority Restoration includes system development, verification and confirmation.

**F. Rates and Charges**

1. The following rates and charges are in addition to all other rates and charges that may be applicable for other services furnished in conjunction with TSP service:

- a. Priority Installation (PI)<sup>2</sup>
  - (1) Per circuit

	Nonrecurring Charge	Monthly Rate	USOC
(a) Prime vendor	\$83.00	\$-	P1APX
(b) Subcontractor	83.00	-	P1ASX

b. Priority Restoration (PR)<sup>2</sup>, per circuit

**Note 1:** Text is shown as new due to reissue of all Tariff Sections. No changes in rates or regulations were made with this filing.

**Note 2:** TSP Authority Codes are not applicable to the Hub-to-Hub portion of a multipoint arrangement.

**E13. ADDITIONAL ENGINEERING, ADDITIONAL LABOR AND  
 MISCELLANEOUS CHARGES**

**E13.3 Miscellaneous Services (Cont'd)**

**E13.3.9 Telecommunications Service Priority (TSP) System (Cont'd)**

**F. Rates and Charges (Cont'd)**

1. The following rates and charges are in addition to all other rates and charges that may be applicable for other services furnished in conjunction with TSP service: (Cont'd)
  - b. Priority Restoration (PR)<sup>1</sup>, per circuit (Cont'd)
    - (1) Level Implementation

	Nonrecurring Charge	Monthly Rate	USOC
(a) Prime vendor	\$64.00	\$-	PR5PX
(b) Subcontractor	64.00	-	PR5SX
(2) Level Change			
(a) Prime vendor	64.00	-	PR8PX
(b) Subcontractor	64.00	-	PR8SX
(3) Administration/Maintenance			
(a) Prime vendor	-	3.00	PR9PX
(b) Subcontractor	-	3.00	PR9SX

**E13.3.10 BellSouth Administrative Management Service**

**A. Service Description**

**1. General**

BellSouth Administrative Management Service provides customers access to other Company network management products, and provides the customers greater control of and additional information about the network services they purchase from the Company. The features offered under Basic Service A are provided through the same system, Electronic Communications Gateway, that the Company utilizes for access to these features. The features offered under Basic Service B are being offered through the system utilized for the initial BellSouth Administrative Management Service offering.

Although most Operation Support Systems (OSS) are optional on a nominal business day, BellSouth Administrative Management Service will be provided on a twenty-four hour basis for continuous usage of those systems that are accessible twenty-four hours.

**2. Customer Access**

The customer, for the existing BellSouth Administrative Management service, will have access to the service through a customer provided VT100 terminal with a choice of up to 2400 bits per second (BPS) dial access or a dedicated 9600 bps private line. For the features offered through Basic Service A, the customer may choose to *access the Preferred Interexchange Carrier (PIC) Service* by utilizing a workstation *or Personal Computer*, and *either connecting via* a dial access (up to 19.2 bps) or a private line connection. *The Trouble Administration (TA) service may be accessed with a Personal Computer via the Public Internet or a private line connection.* If the customer of Basic Service A chooses a dial access, the purchase of a Security Card will be required for each dial access arrangement.

**Note 1:** TSP Authority Codes are not applicable to the Hub-to-Hub portion of a multipoint arrangement.

(C)

## E13. ADDITIONAL ENGINEERING, ADDITIONAL LABOR AND MISCELLANEOUS CHARGES

### E13.3 Miscellaneous Services (Cont'd)

#### E13.3.10 BellSouth Administrative Management Service (Cont'd)

A. Service Description (Cont'd)

2. Customer Access (Cont'd)

If the subscriber has purchased a Security Card in conjunction with another feature or service offered by the Company, that Security Card may also be used in conjunction with Basic Service A. It is up to the subscriber to notify the Company of an existing Security Card so the Company can ensure that the card is validated for multiple features and/or services.

3. Maintenance and Operation

Due to the nature of the hardware used to offer these services it may be necessary to perform preventive and routine maintenance on the system. At such times, the customers will be notified in advance as to the time and duration of these outages.

B. Regulations

1. Basis of Offering

BellSouth Administrative Management Service will be available where facilities are available.

Basic Service A will provide the customer the following capabilities.

- PIC Inquiry and Order (for BellSouth SWA FGD Customers)
- Trouble Administration on Access Service

Basic Service B will provide the customer the following capabilities.

- Product and Service Information
- Service Order Status on Access Service
- Billing Information on Access Service

The Company shall not be responsible if changes in any of the equipment, operations, or procedures of the Company utilized in the provision of these services render any facilities provided by a customer obsolete or require modification or alteration of such equipment or system or otherwise affect its use or performance.

The Company will assist the customer in resolving any installation or day to day channel service problems. However, the Company does not assume responsibility for the compatibility or suitability of the customer's equipment.

2. Provision of Service

Customer access to the existing BellSouth Administrative Management Service may be either BellSouth SWA (Dial) Service, a Private Line Service, *or Public Internet Service.*

(T)

FLORIDA

ISSUED: August 5, 2002

EFFECTIVE: August 20, 2002

BY: Joseph P. Lacher, President -FL  
Miami, Florida

## **E13. ADDITIONAL ENGINEERING, ADDITIONAL LABOR AND MISCELLANEOUS CHARGES**

### **E13.3 Miscellaneous Services (Cont'd)**

#### **E13.3.10 BellSouth Administrative Management Service (Cont'd)**

##### **B. Regulations (Cont'd)**

##### **2. Provision of Service (Cont'd)**

For dial/shared access, the customer will be required to provide a terminal, a modem, and dial tone at his premises. Provided the customer's premises resides in a Company LATA, the customer will dial a non-toll access number which furnishes access to BellSouth Administrative Management Service. If the customer's premises does not reside in a Company LATA, the customer must obtain an access line to a Company location from which the Company offers access to BellSouth Administrative Management Service. The BellSouth Administrative Management Service port will be assigned a seven-digit number to enable the customer to access this port. If the customer desires multiple telephone numbers to access BellSouth Administrative Management Service, an additional port charge will be required for each additional telephone number requested.

Dedicated access will be provided at speeds up to 9600 bps for customers wanting continuous access to the existing BellSouth Administrative Management Service. The customer will be required to provide at his premises a terminal and a modem and to obtain a dedicated data circuit to a location designated by the Company at which the Company provides access to BellSouth Administrative Management Service.

For the Basic Service A offering the customer will be required to provide a terminal, a modem, and a dial tone at his premises and obtain a Security Card for each dial access desired.

Dedicated Access will be provided for customers of Basic Service A desiring continuous access to this offering. Additionally, the customer of Basic Service A will be required to provide at his premises a terminal, a modem, and obtain a dedicated data circuit to a location designated by the Company at which the Company provides access to Basic Service A.

The customer will be responsible for installation, maintenance and testing of customer-provided terminal equipment.

##### **C. Explanation of Terms**

##### **BILLING INFORMATION ON ACCESS SERVICE**

The customer will have access to his records, whereby, he may gain information about his last and current bill amount and any payments or adjustments posted to date. He will also have access to his Customer Service record, which provides detailed information about his services provided by the Company.

##### **PIC INQUIRY AND ORDER**

This feature provides switched access customers (BellSouth SWA FGD) the ability to perform the following Prescribed Interexchange Carrier (PIC) functions.

- PIC Inquiry

(T)

- PIC Order

(T)

- **(DELETED)**

(D)

## E13. ADDITIONAL ENGINEERING, ADDITIONAL LABOR AND MISCELLANEOUS CHARGES

### E13.3 Miscellaneous Services (Cont'd)

#### E13.3.10 BellSouth Administrative Management Service (Cont'd)

C. Explanation of Terms (Cont'd)

- **(DELETED)**

(D)

PRODUCT AND SERVICE INFORMATION

This feature provides the following Central Office information: CLLI codes, switch type, V&H coordinates, network access lines, host information (if applicable), switch location, and equal access information.

SERVICE ORDER STATUS ON ACCESS SERVICE

The customer will have access to a mechanized interface for use when viewing order status information for Access Service.

TROUBLE ADMINISTRATION ON ACCESS SERVICE

This feature offers mechanized access for the customer to electronically perform the following functions.

- Enter Trouble Report
- Request Trouble Report Status
- Add Trouble Report Information
- Modify Trouble Report Attributes
- Verify Repair Completions
- Cancel Trouble Report
- Trouble Report Attribute Value Change

D. Application of Rates

1. Basic Service A

Basic Service A includes service establishment, multilevel security, network administration aids which includes a user's handbook for Customer Training, Port Access, User ID's and Features listed.

- PIC Inquiry and Order (for BellSouth SWA FGD Customers)
- Trouble Administration on Access Service

This Rate Element is offered at no charge.

2. Security Card

Dial customers of Basic Service A must order a Security Card. A nonrecurring charge will apply. This card provides the customer a unique password identification code, which will electronically change periodically, thereby providing a valuable layer of security. Should the customer require additional cards for reasons such as additional users or lost or damaged card, a non-recurring charge will apply for each additional card requested.

FLORIDA  
ISSUED: October 6, 1999  
BY: Joseph P. Lacher, President -FL  
Miami, Florida

EFFECTIVE: October 21, 1999

## E13. ADDITIONAL ENGINEERING, ADDITIONAL LABOR AND MISCELLANEOUS CHARGES

### E13.3 Miscellaneous Services (Cont'd)

#### E13.3.10 BellSouth Administrative Management Service (Cont'd)

##### D. Application of Rates (Cont'd)

##### 3. Basic Service B

Basic Service B includes **service establishment**, multilevel security and network administration aids, which includes a user's handbook for customer training. (C)

A non-recurring charge and a recurring rate will apply.

##### 4. User ID Charge

The User ID charge is a nonrecurring charge per customer for Basic Service B.

##### 5. Port Access

Port Access, which is required for each access capability for Basic Service B desired by the customer, includes a nonrecurring charge and a recurring rate.

Rates and charges for dial/shared port access is as set forth in E.5.(a) following.

Rates and charges for dedicated port access is as set forth in E.5.(b) following.

##### 6. Features

Access to the required background OSS will be provided via the normal control network at each System.

- For each feature described in E.3., following, a nonrecurring charge and a recurring rate applies.

- The PIC charges apply only for access to the system. This charge is in addition to all other appropriate PIC change charges as found in E13.3.3 preceding.

##### E. Rates and Charges

Basic Service A includes **service establishment**, multilevel security, and network administration aids which includes a user's handbook for Customer Training, Port Access and Features listed. (C)

- PIC Inquiry and Order (for BellSouth SWA FGD Customers only)

- Trouble Administration on Access Service

##### (1) Basic Service A

##### (a) Security Card - Initial and Subsequent

Basic Service B includes **service establishment**, multilevel security, and network administration aids, which includes a user's handbook for customer training. (C)

##### (2) Basic Service B

##### (a) Initial Setup

<b>Nonrecurring Charge</b>	<b>USOC</b>
<b>\$100.00</b>	<b>SCA1X</b>

<b>Nonrecurring Charge</b>	<b>Monthly Rate</b>	<b>USOC</b>
<b>\$715.75</b>	<b>\$55.00</b>	<b>AMSTB</b>



BELLSOUTH  
TELECOMMUNICATIONS, INC.  
FLORIDA

ACCESS SERVICES TARIFF

Fifth Revised Page 31  
Cancels Fourth Revised Page 31

ISSUED: February 15, 2008  
BY: Marshall M. Criser III, President -FL  
Miami, Florida

EFFECTIVE: February 18, 2008

**E13. ADDITIONAL ENGINEERING, ADDITIONAL LABOR AND  
MISCELLANEOUS CHARGES**

**E13.3 Miscellaneous Services (Cont'd)**

**E13.3.10 BellSouth Administrative Management Service (Cont'd)**

**E. Rates and Charges (Cont'd)**

**(3) Features per Subscribed System**

	<b>Nonrecurring Charge</b>	<b>Monthly Rate</b>	<b>USOC</b>
(a) Product and Service Information	<b>\$593.25</b>	<b>\$43.25</b>	<b>MBSPM</b>
(b) Service Order Status on Access Service	<b>306.45</b>	<b>29.35</b>	<b>MBSSM</b>
(c) Billing Information on Access Service	<b>305.45</b>	<b>34.75</b>	<b>MBSLM</b>
<b>(4) User ID's, per Customer</b>			
(a) First 15	<b>18.00</b>	<b>-</b>	<b>U1G1A</b>
(b) Each Additional set of 5	<b>18.00</b>	<b>-</b>	<b>U1GAA</b>
<b>(5) Port Access, per Access Capability</b>			
(a) Dial/Shared Access	<b>67.00</b>	<b>76.00</b>	<b>MDQ</b>
(b) Dedicated Access	<b>96.00</b>	<b>124.00</b>	<b>MD6</b>

**E13.3.11 (DELETED)**

(D)

BELLSOUTH  
TELECOMMUNICATIONS, INC.  
FLORIDA

ISSUED: February 15, 2008  
BY: Marshall M. Criser III, President -FL  
Miami, Florida

ACCESS SERVICES TARIFF

Sixth Revised Page 32  
Cancels Fifth Revised Page 32

EFFECTIVE: February 18, 2008

**E13. ADDITIONAL ENGINEERING, ADDITIONAL LABOR AND  
MISCELLANEOUS CHARGES**

**E13.3 Miscellaneous Services (Cont'd)**

**E13.3.11 (DELETED)**

(D)

BELLSOUTH  
TELECOMMUNICATIONS, INC.  
FLORIDA

ACCESS SERVICES TARIFF

Fifth Revised Page 33  
Cancels Fourth Revised Page 33

ISSUED: February 15, 2008  
BY: Marshall M. Criser III, President -FL  
Miami, Florida

EFFECTIVE: February 18, 2008

**E13. ADDITIONAL ENGINEERING, ADDITIONAL LABOR AND  
MISCELLANEOUS CHARGES**

**E13.3 Miscellaneous Services (Cont'd)**

**E13.3.11 (DELETED)**

(D)

BELLSOUTH  
TELECOMMUNICATIONS, INC.  
FLORIDA

ACCESS SERVICES TARIFF

First Revised Page 33.1  
Cancels Original Page 33.1

ISSUED: February 15, 2008  
BY: Marshall M. Criser III, President -FL  
Miami, Florida

EFFECTIVE: February 18, 2008

**E13. ADDITIONAL ENGINEERING, ADDITIONAL LABOR AND  
MISCELLANEOUS CHARGES**

**E13.3 Miscellaneous Services (Cont'd)**

**E13.3.11 (DELETED)**

(D)

BELLSOUTH  
TELECOMMUNICATIONS, INC.  
FLORIDA

ISSUED: February 15, 2008  
BY: Marshall M. Criser III, President -FL  
Miami, Florida

ACCESS SERVICES TARIFF

Fifth Revised Page 34  
Cancels Fourth Revised Page 34

EFFECTIVE: February 18, 2008

**E13. ADDITIONAL ENGINEERING, ADDITIONAL LABOR AND  
MISCELLANEOUS CHARGES**

**E13.3 Miscellaneous Services (Cont'd)**

**E13.3.11 (DELETED) (Cont'd)**

(D)

ISSUED: February 14, 1997  
BY: Joseph P. Lacher, President -FL  
Miami, Florida

EFFECTIVE: March 1, 1997

## E13. ADDITIONAL ENGINEERING, ADDITIONAL LABOR AND MISCELLANEOUS CHARGES

### E13.3 Miscellaneous Services (Cont'd)

#### E13.3.12 BellSouth 8XX Toll Free Dialing Number Administration Service

*BellSouth 8XX Toll Free Dialing Number Administration* service is a Company provided service associated with *BellSouth SWA 8XX Toll Free Dialing Ten Digit Screening* service which provides for the assignment and administration of ten digit 800 number(s), (i.e., 800+NXX+XXXX). *BellSouth SWA 8XX Toll Free Dialing Ten Digit Screening* service requires the customer's subscription to the basic *BellSouth 8XX Toll Free Dialing Number Administration* service, following, or as an alternative the provision of those services by other responsible organizations or through direct access by the customer to the Service Management System. Optional features may be subscribed to in the same manner.

The *BellSouth 8XX Toll Free Dialing Number Administration* service customer is responsible for making the necessary arrangements with *BellSouth SWA 8XX Toll Free Dialing Ten Digit Screening* service providers to accept the *BellSouth SWA 8XX Toll Free Dialing Ten Digit Screening service* or POTS number for transport.

*BellSouth 8XX Toll Free Dialing Number Administration* service does not include the provision of a facility over which to terminate the 800 calls (e.g., WATS Access Line (a.k.a. *BellSouth SPA WATS Line*), Common Line, etc.). Charges, as set forth following, will apply for each 800 number established with *BellSouth 8XX Toll Free Dialing Number Administration* service.

*BellSouth 8XX Toll Free Dialing Number Administration* service consists of the following basic service features, optional service features and optional Call Handling and Destination features.

#### A. Basic Service Features

##### 1. 800 Number Assignment and Administration

*BellSouth 8XX Toll Free Dialing Number Administration* service provides for the assignment of ten digit 800 number(s) (i.e., 800+NXX+XXXX) to the *BellSouth 8XX Toll Free Dialing 800 Number Administration* service customer. The Company will select the number(s) to be assigned to the *BellSouth 8XX Toll Free Dialing Number Administration* service customer unless the *BellSouth 8XX Toll Free Dialing Number Administration* service customer requests a specific 800 number. If the requested number is available, the Company will make a reasonable effort to comply with the *BellSouth 8XX Toll Free Dialing Number Administration* service customer's request for the specific 800 number, in accordance with the *BellSouth SWA 8XX Toll Free Dialing Ten Digit Screening* service Number Administration guidelines.

##### 2. IntraLATA and InterLATA Carrier Selection

The *BellSouth 8XX Toll Free Dialing Number Administration* service customer must designate the intraLATA carrier and/or the interLATA carrier(s), as applicable, that will transport the 800 number or POTS number. The *BellSouth 8XX Toll Free Dialing Number Administration* service customer is responsible for arranging for the transport service and delivery of the *BellSouth SWA 8XX Toll Free Dialing Ten Digit Screening* Service calls.

The selection of one interLATA carrier and one intraLATA carrier is provided at no additional charge with the initial order for service. As an optional feature, the customer may subscribe to the Multiple Carrier Routing feature for which multiple carriers may be selected.

##### 3. Area of Service

Area of Service is defined as the geographical area from which calls to a particular 800 number may be received. The standard area of service provided with *BellSouth SWA 8XX Toll Free Dialing Ten Digit Screening* service is the entire state. Customers may specify other levels of area of service with the Customized Area of Service feature.

The Area of Service will be limited to that geographical area(s) served by those access service providers (e.g., Exchange Telephone Companies) that offer ten digit screening of 800 calls and also participate in the *BellSouth SWA 8XX Toll Free Dialing Ten Digit Screening* Service Number Administration guidelines. The Area of Service may also be limited to certain geographical areas depending on the access serving arrangements ordered by the access service customer.

ISSUED: February 14, 1997  
BY: Joseph P. Lacher, President -FL  
Miami, Florida

EFFECTIVE: March 1, 1997

## E13. ADDITIONAL ENGINEERING, ADDITIONAL LABOR AND MISCELLANEOUS CHARGES (T)

### E13.3 Miscellaneous Services (Cont'd)

#### E13.3.12 BellSouth 8XX Toll Free Dialing Number Administration Service (Cont'd) (T)

##### A. Basic Service Features (Cont'd)

##### 3. Area of Service (Cont'd)

The *BellSouth SWA 8XX Toll Free Dialing Ten Digit Screening* service provider is responsible for ensuring that appropriate traffic capacity is provided to accept such 800 dialed calls (i.e., where *BellSouth SWA 8XX Toll Free Dialing Ten Digit Screening* service has been provisioned as set forth in E6.2.5 preceding) from within the portion of the defined Area of Service served by the Company. (T)

##### B. Optional Service Features

Various service options are available to the 800 Number Service customer as part of or in association with 800 Number Service.

##### 1. 800 Number Reservation

800 Number Reservation allows for an 800 Number Service customer to reserve 800 numbers in advance of placing an order for 800 Number Service. Reserved 800 number(s) will be maintained in a reserved status for a period not to exceed 60 calendar days from the date the ASR is received. The 800 Number Service customer may request activation of any or all of the reserved numbers during the 60 day period. Activation is accomplished when the number is placed in the working status, at which time the 800 Number Service customer is responsible for providing the ordering information described in E5.2.1 preceding for 800 Number Service.

Reserved 800 numbers for which an ASR to activate is not received during the 60 day period will be removed from the reserved status on the 61st day following the 800 Number Service customer's original reservation date.

Charges, as set forth following, will apply for each 800 number reserved.

##### 2. POTS Number Delivery

The 800 Number Service customer may specify whether the POTS number as opposed to the 800 number is desired. If requested, the terminating POTS number (NPA+NXX+XXXX) will be delivered in place of the dialed 800 number (800+NXX+XXXX). When the POTS number is to be forwarded, the 800 Number Service customer must provide to the Company the full ten digit POTS number to be associated with the 800 number and indicate to whom the POTS number is to be delivered.

##### 3. Customized Area of Service

The Customized Area of Service option provides for a unique customer defined geographic area from which calls to a particular 800 number may be received. The customer may define a specific area of service in terms of LATA(s), NPA(s) or combination thereof.

The Customized Area of Service will be limited to the geographical area(s) served by those access service providers (e.g., Exchange Telephone Companies) that offer *BellSouth SWA 8XX Toll Free Dialing Ten Digit Screening service* of 800 calls and also participate in the *BellSouth SWA 8XX Toll Free Dialing Ten Digit Screening* service Number Administration guidelines. The Area of Service may also be limited to certain geographical areas depending on the access serving arrangements ordered by the access service customer. (T)

The *BellSouth SWA 8XX Toll Free Dialing Ten Digit Screening* service provider is responsible for ensuring that appropriate traffic capacity is provided to accept such 800 dialed calls (i.e., where *BellSouth SWA 8XX Toll Free Dialing Ten Digit Screening* service has been provisioned as set forth in E6.2.5 preceding) from within the portion of the defined Area of Service served by the Company. (T)

ISSUED: February 14, 1997  
BY: Joseph P. Lacher, President -FL  
Miami, Florida

EFFECTIVE: March 1, 1997

## E13. ADDITIONAL ENGINEERING, ADDITIONAL LABOR AND MISCELLANEOUS CHARGES

### E13.3 Miscellaneous Services (Cont'd)

#### E13.3.12 BellSouth 8XX Toll Free Dialing Number Administration Service (Cont'd)

##### B. Optional Service Features (Cont'd)

###### 4. Multiple Carrier Routing

The Multiple Carrier Routing option allows the *BellSouth 8XX Toll Free Dialing Number Administration* service customer to specify the use of different carriers for transport of 800 number or POTS number traffic within an area of service.

##### C. Call Handling and Destination Features

A number of optional Call Handling and Destination features are available to the *BellSouth 8XX Toll Free Dialing Number Administration* service customer. The customer is responsible for insuring the compatibility of any combination of features selected. The optional features are as follows.

###### 1. Time of Day Routing

Time of Day Routing provides *BellSouth SWA 8XX Toll Free Dialing Ten Digit Screening* service subscribers with the ability to distribute calls to different locations based on the specific hour of day a call is placed. Customers may make selections in 15 minute increments but must account for a complete 24 hour period.

###### 2. Day of Week Routing

Day of Week Routing allows *BellSouth SWA 8XX Toll Free Dialing Ten Digit Screening* service subscribers to distribute calls to a number of answering locations based on the day of week a call is placed. Calls can be directed for a single day or in groups of days. However, the customer's specification must account for a seven day week.

###### 3. Specific Date Routing

Specific Date Routing provides *BellSouth SWA 8XX Toll Free Dialing Ten Digit Screening* service subscribers the capability of distributing 800 calls to different locations based on the specific date in the year the call is placed.

###### 4. Allocation By Percentage

This feature provides *BellSouth SWA 8XX Toll Free Dialing Ten Digit Screening* service subscribers the ability to distribute *BellSouth SWA 8XX Toll Free Dialing Ten Digit Screening* service calls to more than one location, by specifying the percentage of calls to be directed to each location. Distribution percentages may be selected in gradations as small as 1 percent for a total of 100 percent. This feature also provides *BellSouth SWA 8XX Toll Free Dialing Ten Digit Screening* service subscribers the ability to select multiple carriers to transport their 800 traffic based on percentage allocations.

###### 5. Ten Digit Node Routing

Ten Digit Node routing provides *BellSouth SWA 8XX Toll Free Dialing Ten Digit Screening* service subscribers the capability to route calls to preselected destinations based on the originating ten digit number(s). 800 calls from other than the preselected originating ten digit numbers will be blocked. This feature is available only where 10 digit ANI is provided.

##### D. *BellSouth SWA 8XX Toll Free Dialing Number Administration* Service Charges

###### 1. 800 Number Reservation Charge

A nonrecurring charge applies for the reservation of an 800 Number. There are two levels of nonrecurring charges. A nonrecurring 800 Number Reservation Charge applies for the first reserved 800 number submitted on an Access Service Request (ASR), and a separate nonrecurring 800 Number Reservation Charge applies for each additional reserved 800 number submitted on the same ASR.

###### 2. 800 Number Establishment Charge



**E13. ADDITIONAL ENGINEERING, ADDITIONAL LABOR AND MISCELLANEOUS CHARGES** (T)

**E13.3 Miscellaneous Services (Cont'd)**

**E13.3.12 BellSouth 8XX Toll Free Dialing Number Administration Service (Cont'd)** (T)

**D. BellSouth 8XX Toll Free Dialing Number Administration Service Charges (Cont'd)** (T)

**2. 800 Number Establishment Charge (Cont'd)**

800 numbers can be established for use with 800 number delivery or POTS number delivery. There are two levels of nonrecurring charges applicable to each. A nonrecurring 800 Number Establishment Charge applies for the first 800 number submitted on an Access Service Request (ASR), and a separate nonrecurring 800 Number Establishment Charge applies for each additional 800 number submitted on the same ASR.

**3. BellSouth 8XX Toll Free Dialing Number Administration Service Change Charge** (T)

An 800 Number Service Change Charge applies for changes associated with an 800 number, subsequent to the initial establishment of that 800 number. There are two levels of nonrecurring charges. A nonrecurring 800 Number Service Change Charge applies for the first 800 Number for which associated changes are being made affecting that number, submitted on an ASR. A separate nonrecurring 800 Number Service Change Charge applies for each additional 800 Number for which associated changes are being made affecting that number, submitted on the same ASR.

**4. Customized Area of Service**

Nonrecurring charges apply for the provision of the Customized Area of Service option. The charges are applied on a First and Additional basis. First and additional installation charge treatment is applied to Customized Area of Service requests submitted on the same or related ASRs. Related ASRs must be received on the same business day.

**5. Multiple Carrier Routing**

Nonrecurring charges apply for the provision of the Multiple Carrier Routing option. The charges are applied on a First and Additional basis. First and additional installation charge treatment is applied to Multiple Carrier requests submitted on the same or related ASRs. Related ASRs must be received on the same business day.

**6. Call Handling and Destination Features**

A nonrecurring charge is applicable for the provision of any combination of the Call Handling and Destination Features defined in C. preceding, requested on the same Access Service Request.

**7. Rates and Charges**

	Nonrecurring Charge		USOC
	First	Additional	
(a) Reservation Charge Per 800 number reserved	\$28.50	\$ .50	N8R1X
(b) Establishment Charge Per 800 number established with 800 number delivery	59.50	1.50	XOT
(c) Establishment Charge Per 800 number established with POTS number delivery	59.50	1.50	N8FTX
(d) Customized Area of Service Per 800 number	3.00	1.50	N8FCX
(e) Multiple InterLATA Carrier Routing Per carrier requested, per 800 number	3.50	2.00	N8FMX

**E13. ADDITIONAL ENGINEERING, ADDITIONAL LABOR AND MISCELLANEOUS CHARGES**

**E13.3 Miscellaneous Services (Cont'd)**

**E13.3.12 BellSouth 8XX Toll Free Dialing -Number Administration Service (Cont'd)**

**D. BellSouth 8XX Toll Free Dialing Number Administration Service Charges (Cont'd)**

**7. Rates and Charges (Cont'd)**

	<b>Nonrecurring Charge</b>	
	<b>First</b>	<b>Additional</b>
(f) Change Charge Per request	<b>\$43.50</b>	<b>\$.50</b>
		<b>USOC</b>
		<b>N8FAX</b>
		<b>Nonrecurring</b>
		<b>Charge</b>
(g) Call Handling and Destination Features Per 800 Number		<b>\$3.00</b>
		<b>USOC</b>
		<b>N8FDX</b>

**E13.3.13 BellSouth Billing Name and Address for ANI Service**

**A. BellSouth Billing Name and Address for ANI Service**

1. BellSouth Billing Name and Address for ANI service provides for end user billing name and address and associated information. It is available to ICs such as an Enhanced Service Provider (ESP), Operator Service Provider (OSP), Interexchange Carrier (IC) and any other provider of telecommunications services.
2. BellSouth Billing Name and Address for ANI service is available on those calls for which the ANI of the calling or billed party is provided to the Company. This includes 101XXXXX dialed calls and collect and third party billed calls. Information provided consists of the following:<sup>1</sup>
  - a. Billing name and street address of the subscriber (BNA)
  - b. Billing Telephone Number (BTN)
  - c. Working Telephone Number (WTN)
  - d. Terminal Number (TER)
  - e. IC Type Indicator (CTI)
  - f. IC Code
3. BellSouth Billing Name and Address for ANI service is ordered under terms and conditions as set forth in E5.2.1 preceding in order to establish an account.  
 For collect and third party billed calls, BellSouth Billing Name and Address for ANI service is not available on accounts of nonpublished/nonlisted end users who, by request to the Company (which request may be submitted at any time), have specified that such information not be released.
4. The IC may deem it necessary to request the Company resend the BellSouth Billing Name and Address for ANI information. Such a request, when not the result of Company error, will be subject to the same rates and charges as the original request.
5. Restrictions on use of BellSouth Billing Name and Address for ANI information:
  - a. The IC, or its authorized billing and collection agent, agrees not to publish any BellSouth Billing Name and Address for ANI information provided and to use such information for the sole purpose of rendering bills for its provision of services to its ICs.

Note 1: Effective July 30, 2016, Collect calls and Third Number billing are discontinued

(N)

## E13. ADDITIONAL ENGINEERING, ADDITIONAL LABOR AND MISCELLANEOUS CHARGES

### E13.3 Miscellaneous Services (Cont'd)

#### E13.3.13 BellSouth Billing Name and Address for ANI Service (Cont'd)

- A. BellSouth Billing Name and Address for ANI Service (Cont'd)
  - 5. Restrictions on use of BellSouth Billing Name and Address for ANI information: (Cont'd)
    - b. The IC, or its authorized billing and collection agent, may not permit anyone but its duly authorized employees to inspect or use BellSouth Billing Name and Address for ANI information.
    - c. The IC, or its authorized billing and collection agent, may not use the BellSouth Billing Name and Address for ANI information to publish and distribute, in any form, lists of the subscribers provided.
    - d. The IC, or its authorized billing and collection agent, shall not reproduce in any way copies of the BNA information furnished, other than as required internally for the rendering of bills for services provided.
  - 6. The Company will provide BellSouth Billing Name and Address for ANI data no later than ten (10) business days from the date of receipt of the IC's request. Availability of data may be delayed if errors exist in the request received from the IC.
- B. Rates and Charges
  - 1. BellSouth Billing Name and Address for ANI

<b>Nonrecurring</b>	
<b>Charge</b>	<b>USOC</b>
<b>\$.20</b>	<b>EAEBN</b>

(a) per record

#### E13.3.14 (DELETED)

(D)

BELLSOUTH  
TELECOMMUNICATIONS, INC.  
FLORIDA

ACCESS SERVICES TARIFF

Third Revised Page 41  
Cancels Second Revised Page 41

ISSUED: November 13, 2000  
BY: Joseph P. Lacher, President -FL  
Miami, Florida

EFFECTIVE: November 28, 2000

**E13. ADDITIONAL ENGINEERING, ADDITIONAL LABOR AND  
MISCELLANEOUS CHARGES**

**E13.3 Miscellaneous Services (Cont'd)**

**E13.3.14 (DELETED) Cont'd**

(D)

015 58 402

BELLSOUTH  
TELECOMMUNICATIONS, INC.  
FLORIDA

ISSUED: February 15, 2008  
BY: Marshall M. Criser III, President -FL  
Miami, Florida

ACCESS SERVICES TARIFF

Third Revised Page 42  
Cancels Second Revised Page 42

EFFECTIVE: February 18, 2008

**E13. ADDITIONAL ENGINEERING, ADDITIONAL LABOR AND  
MISCELLANEOUS CHARGES**

**E13.3 Miscellaneous Services (Cont'd)**

**E13.3.15 (DELETED)**

(D)

BELLSOUTH  
TELECOMMUNICATIONS, INC.  
FLORIDA

ACCESS SERVICES TARIFF

Second Revised Page 43  
Cancels First Revised Page 43

ISSUED: February 15, 2008  
BY: Marshall M. Criser III, President -FL  
Miami, Florida

EFFECTIVE: February 18, 2008

**E13. ADDITIONAL ENGINEERING, ADDITIONAL LABOR AND  
MISCELLANEOUS CHARGES**

**E13.3 Miscellaneous Services (Cont'd)**

**E13.3.15 (DELETED)**

(D)

BELLSOUTH  
TELECOMMUNICATIONS, INC.  
FLORIDA

ISSUED: February 15, 2008  
BY: Marshall M. Criser III, President -FL  
Miami, Florida

ACCESS SERVICES TARIFF

Third Revised Page 44  
Cancels Second Revised Page 44

EFFECTIVE: February 18, 2008

**E13. ADDITIONAL ENGINEERING, ADDITIONAL LABOR AND  
MISCELLANEOUS CHARGES**

**E13.3 Miscellaneous Services (Cont'd)**

**E13.3.15 (DELETED)**

(D)

BELLSOUTH  
TELECOMMUNICATIONS, INC.  
FLORIDA

ACCESS SERVICES TARIFF

Third Revised Page 45  
Cancels Second Revised Page 45

ISSUED: February 15, 2008  
BY: Marshall M. Criser III, President -FL  
Miami, Florida

EFFECTIVE: February 18, 2008

**E13. ADDITIONAL ENGINEERING, ADDITIONAL LABOR AND  
MISCELLANEOUS CHARGES**

**E13.3 Miscellaneous Services (Cont'd)**

**E13.3.15 (DELETED)**

(D)



BELLSOUTH  
TELECOMMUNICATIONS, INC.  
FLORIDA

ACCESS SERVICES TARIFF

Fourth Revised Page 46  
Cancels Third Revised Page 46

ISSUED: February 15, 2008  
BY: Marshall M. Criser III, President -FL  
Miami, Florida

EFFECTIVE: February 18, 2008

**E13. ADDITIONAL ENGINEERING, ADDITIONAL LABOR AND  
MISCELLANEOUS CHARGES**

**E13.3 Miscellaneous Services (Cont'd)**

**E13.3.16 (DELETED)**

(D)

BELLSOUTH  
TELECOMMUNICATIONS, INC.  
FLORIDA

ISSUED: February 15, 2008  
BY: Marshall M. Criser III, President -FL  
Miami, Florida

ACCESS SERVICES TARIFF

Second Revised Page 47  
Cancels First Revised Page 47

EFFECTIVE: February 18, 2008

**E13. ADDITIONAL ENGINEERING, ADDITIONAL LABOR AND  
MISCELLANEOUS CHARGES**

**E13.3 Miscellaneous Services (Cont'd)**

**E13.3.17 (DELETED)**

(D)

## E13. ADDITIONAL ENGINEERING, ADDITIONAL LABOR AND MISCELLANEOUS CHARGES

### E13.3 Miscellaneous Services (Cont'd)

E13.3.18 Reserved for Future Use

E13.3.19 Reserved for Future Use

E13.3.20 Reserved for Future Use

E13.3.21 Reserved for Future Use

E13.3.22 Reserved for Future Use

#### E13.3.23 Physical Access Collocation Cross-Connect Service

##### A. General Description

1. Physical Access Collocation Cross-Connects provide a one to one dedicated transmission path between the ordering customer's tariffed service offerings or transport equipment located in the Telephone Company Central Office and the ordering customer's own physical collocation arrangement or another telecommunication carrier's (collocator's) physical collocation arrangement in the same Telephone Company Central Office for all of the access services listed below, except the following:

- a. Exchange Access Frame Relay service (described in E21.1 of this Tariff)
- b. Exchange Access ATM service (described in E21.3 of this Tariff)
- c. BellSouth Metro Ethernet service (described in E7.2.18 of this Tariff)

The above-listed access services may only be requested between the ordering customer's tariffed service offerings or transport equipment located in the Telephone Company Central Office and the ordering customer's own physical collocation arrangement in the same Telephone Company Central Office.

2. Standards for performance monitoring of services which interconnect to the collocation arrangement will be driven by the particular service type and service specific requirements. The Telephone Company's obligation for monitoring ends at the demarcation point.
3. Physical Access Collocation Cross-Connects are flat rate, non-distance sensitive charges and will be applied on a per cross-connect ordered basis.
4. Physical Access Collocation Cross-Connects will be ordered on the same Access Service Request (ASR) as the service being cross-connected. All ASRs must be complete and accurate before the Company will initiate the provisioning process.
5. Nonrecurring charges are applicable for Physical Access Collocation Cross-Connect service.
6. The collocator may cross-connect at the DS0 level with the following Telephone Company access services:
  - a. Local Channels (described in E7.1.2.A of this Tariff) (N)
  - b. Optional Features and Functions (described in E7.1.2.C of this Tariff)
  - c. Exchange Access Frame Relay service (described in E21.1 of this Tariff)
7. The collocator may cross-connect at the DS1 level with the following Telephone Company access services:
  - a. DS1 Local and Interoffice Channels (described in E7.1.2 of this Tariff)
  - b. DS1 Basic Channelization System (described in E7.1.2 of this Tariff)
  - c. FlexServ (a.k.a. BellSouth SPA Customer Reconfiguration) Port in a Digital Cross-Connect System (described in E7.4.12 of this Tariff)
  - d. Shared Use Analog and Digital High Capacity (a.k.a. BellSouth SPA High Capacity) services (described in E7.4.12 of this Tariff)
  - e. SMARTRing (a.k.a. BellSouth Dedicated Ring) services (described in E7.2.16 of this Tariff)
  - f. BellSouth SWA service (described in E6.1.3 of this Tariff)
  - g. Exchange Access Frame Relay service (described in E21.1 of this Tariff) (D)
  - h. Exchange Access ATM service (described in E21.3 of this Tariff) (T)

## E13. ADDITIONAL ENGINEERING, ADDITIONAL LABOR AND MISCELLANEOUS CHARGES

### E13.3 Miscellaneous Services (Cont'd)

#### E13.3.23 Physical Access Collocation Cross-Connect Service (Cont'd)

##### A. General Description (Cont'd)

8. The collocator may cross-connect at the DS3 level with the following Telephone Company access services:
  - a. 28 DS1 Channelization System (described in E7.1.2 of this Tariff)
  - b. FlexServ (a.k.a. BellSouth SPA Customer Reconfiguration) Port in a Digital Cross-Connect System (described in E7.4.12 of this Tariff)
  - c. Shared Use Analog and Digital High Capacity (a.k.a. BellSouth SPA High Capacity) services (described in E7.4.8 of this Tariff)
  - d. SMARTRing (a.k.a. BellSouth Dedicated Ring) services (described in E7.2.16 of this Tariff)
  - e. BellSouth SWA service (described in E6.1.3 of this Tariff)
  - f. Exchange Access Frame Relay service (described in E21.1 of this Tariff) (T)
  - g. Exchange Access ATM service (described in E21.3 of this Tariff) (T)
9. The collocator may cross-connect at the fiber level with the following Telephone Company access services:
  - a. SMARTRing (a.k.a. BellSouth Dedicated Ring) service rate categories (described in E7.1.2.D of this Tariff)
  - b. Exchange Access Frame Relay service (described in E21.1 of this Tariff) (T)
  - c. Exchange Access ATM service (described in E21.3 of this Tariff) (T)
  - d. BellSouth Metro Ethernet service (described in E7.2.18 of this Tariff) (T)
  - e. AT&T Dedicated Ethernet (described in E30.2 of this Tariff) (N)
  - f. AT&T Switched Ethernet Service<sup>SM</sup> (described in E30.1 of this Tariff) (T)
10. The collocator may cross-connect at the Ethernet Cat-5 Cable level with the following Telephone Company access services:
  - a. BellSouth Metro Ethernet service (as described in E7.2.18 of this Tariff)
  - b. SMARTRing (a.k.a. BellSouth SPA Dedicated Ring) service rate categories (described in E7.1.2.D of this Tariff)

ISSUED: April 13, 2005  
BY: Joseph P. Lacher, President -FL  
Miami, Florida

EFFECTIVE: April 29, 2005

**E13. ADDITIONAL ENGINEERING, ADDITIONAL LABOR AND  
MISCELLANEOUS CHARGES**

**E13.3 Miscellaneous Services (Cont'd)**

**E13.3.23 Physical Access Collocation Cross-Connect Service (Cont'd)**

**B. Rates and Charges**

1. Special Access (a.k.a. BellSouth SPA), per Cross-Connect

	Nonrecurring Charges	Monthly Recurring Charges	USOC	
(a) 2-Wire	\$33.82	\$1.566	PE1P2	(N)
(b) 4-Wire	67.64	.3132	PE1P4	(N)
(c) Cat-5 Cable	135.28	9.13	PE1P8	(N)
(d) DS1	155.00	2.65	PE1P1	(N)
(e) DS3	155.00	27.83	PE1P3	(N)
(f) 2-Fiber	200.00	10.25	PE1F2	(N)
(g) 4-Fiber	400.00	20.50	PE1F4	(N)

2. Switched Access (a.k.a. BellSouth SPA), per Cross-Connect

(a) 2-Wire	33.82	.1566	PE1W2	(N)
(b) 4-Wire	67.64	.3132	PE1W4	(N)
(c) DS1	155.00	2.65	PE1W1	(N)
(d) DS3	155.00	27.83	PE1W3	(N)
(e) 2-Fiber	200.00	10.25	PE1WB	(N)
(f) 4-Fiber	400.00	20.50	PE1WF	(N)

## E13. ADDITIONAL ENGINEERING, ADDITIONAL LABOR AND MISCELLANEOUS SERVICES

### E13.3 Miscellaneous Services (Cont'd)

#### E13.3.24 Virtual Access Collocation Cross-Connect Service

##### A. General Description

1. Virtual Access Collocation Cross-Connects provide a one to one dedicated transmission path between the ordering customer's tariffed service offerings or transport equipment located in the Telephone Company Central Office and the ordering customer's own virtual collocation arrangement or another telecommunication carrier's (collocator's) virtual collocation arrangement in the same Telephone Company Central Office for all of the access services listed below, except the following:

- a. Exchange Access Frame Relay service (described in E21.1 of this Tariff)
- b. Exchange Access ATM service (described in E21.3 of this Tariff)
- c. BellSouth Metro Ethernet service (described in E7.2.18 of this Tariff)

The above list of access services may only be requested between the ordering customer's tariffed service offerings or transport equipment located in the Telephone Company Central Office and the ordering customer's own physical collocation arrangement in the same Telephone Company Central Office.

2. A monthly recurring charge applies for the Virtual Access Collocation Cross Connect element that consists of the cross connect panel, cable racks, bay framework, jumpers and other supporting hardware.
8. The Virtual Access Collocation Cross-Connect element is designated as BellSouth Switched Access (SWA) or Special Access (SPA), depending on the type of service to which it cross connects.
9. Virtual Access Collocation Cross-Connect service is flat rate, non-distance sensitive charges and will be applied on a per cross connect ordered basis.
10. Standards for performance monitoring of services which interconnect to the collocation arrangement will be driven by the particular service type and service specific requirements. The Telephone Company's obligation for monitoring ends at the demarcation point.
11. Virtual Access Collocation Cross-Connects will be ordered on the same Access Service Request (ASR) as the service being cross connected. All ASRs must be complete and accurate before the Company will initiate the provisioning process.
12. The collocator may cross connect at the DS0 level with the following Telephone Company access services:
  - d. Local Channels (described in E7.1.2.A of this Tariff)
  - e. Optional Features and Functions (described in E7.1.2.C of this Tariff)
  - f. Exchange Access Frame Relay service (described in E21.1 of this Tariff)
13. The collocator may cross-connect at the DS1 level with the following Telephone Company access services:
  - i. DS1 Local and Interoffice Channels (described in E7.1.2 of this Tariff)
  - j. DS1 Basic Channelization System (described in E7.1.2 of this Tariff)
  - k. FlexServ (a.k.a. BellSouth SPA Customer Reconfiguration) Port in a Digital Cross-Connect System (described in E7.4.12 of this Tariff)
  - l. Shared Use Analog and Digital High Capacity (a.k.a. BellSouth SPA High Capacity ) services (described in E7.4.8 of this Tariff)
  - m. SMARTRing (a.k.a. BellSouth Dedicated Ring) services (described in E7.2.16 of this Tariff)
  - n. BellSouth SWA service (described in E21.1 of this Tariff)
  - o. Exchange Access Frame Relay service (described in E21.1 of this Tariff) (D)
  - p. Exchange Access ATM service (described in E21.3 of this Tariff) (T)

## E13. ADDITIONAL ENGINEERING, ADDITIONAL LABOR AND MISCELLANEOUS SERVICES

### E13.3 Miscellaneous Services (Cont'd)

#### E13.3.24 Virtual Access Collocation Cross-Connect Service (Cont'd)

##### A. General Description (Cont'd)

9. The collocator may cross-connect at the DS3 level with the following Telephone Company access services:
  - g. 28 DS1 Channelization System (described in E7.1.2 of this Tariff)
  - h. FlexServ (a.k.a. BellSouth SPA Customer Reconfiguration) Port in a Digital Cross-Connect System (described in E7.4.12 of this Tariff)
  - i. Shared Use Analog and Digital High Capacity (a.k.a. BellSouth SPA High Capacity) services (described in E7.4.8 of this Tariff)
  - j. SMARTRing (a.k.a. BellSouth Dedicated Ring) services (described in E7.2.16 of this Tariff)
  - k. BellSouth SWA service (described in E6.1.3 of this Tariff)
  - l. Exchange Access Frame Relay service (described in E21.1 of this Tariff)
  - m. Exchange Access ATM service (described in E21.3 of this Tariff)
10. The collocator may cross-connect at the fiber level with the following Telephone Company access services:
  - f. SMARTRing (a.k.a. BellSouth Dedicated Ring) service rate categories (described in E7.1.2.D of this Tariff)
  - g. Exchange Access Frame Relay service (described in E21.1 of this Tariff)
  - h. Exchange Access ATM service (described in E21.3 of this Tariff)
  - i. BellSouth Metro Ethernet service (described in E7.2.18 of this Tariff)
  - j. AT&T Dedicated Ethernet (described in E30.2 of this Tariff)
  - k. AT&T Switched Ethernet Service<sup>SM</sup> (described in E30.1 of this Tariff)
11. The collocator may cross-connect at the Ethernet Cat-5 Cable level with the following Telephone Company access services:
  - a. BellSouth Metro Ethernet service (described in E7.2.18 of this Tariff)
  - c. SMARTRing (a.k.a. BellSouth SPA Dedicated Ring) service rate categories (described in E7.1.2.D of this Tariff)

(N)

ISSUED: June 23, 2009  
 BY: Marshall M. Criser III, President -FL  
 Miami, Florida

EFFECTIVE: July 28, 2009

**E13. ADDITIONAL ENGINEERING, ADDITIONAL LABOR AND MISCELLANEOUS SERVICES**

**E13.3 Miscellaneous Services (Cont'd)**

**E13.3.24 Virtual Access Collocation Cross-Connect Service (Cont'd)**

**B. Rates and Charges**

1. Special Access (a.k.a. BellSouth SPA), per Cross-Connect

	Nonrecurring Charges	Monthly Recurring Charges	USOC
(a) 2-Wire	\$24.68	\$.309	UEAC2
(b) 4-Wire	33.67	.619	UEAC4
(c) Cat-5 Cable	135.28	9.13	CNC8W
(d) DS1	155.00	7.50	CNC1X
(e) DS3	151.90	56.25	CND3X
(f) 2-Fiber	41.94	6.71	CNC2F
(g) 4-Fiber	64.53	6.71	CNC4F

2. Switched Access (a.k.a. BellSouth SWA), per Cross-Connect

(a) 2-Wire	24.68	.309	CNDS2
(b) 4-Wire	33.67	.619	CNDS4
(c) DS1	155.00	7.50	CNDS1
(d) DS3	151.90	56.25	CNDS3
(e) 2-Fiber	41.94	6.71	CNDSB
(f) 4-Fiber	64.53	6.71	CNDSF

(D)  
 (D)  
 (D)

(D)  
 (D)  
 (D)  
 (D)  
 (D)



EFFECTIVE: July 15, 1996

## E14. SPECIAL CONSTRUCTION<sup>1</sup>

(N)

### CONTENTS

	New Page	Old Page
<b>E14.1 Application</b>	1	1
E14.1.1 General	1	1
<b>E14.2 Regulations</b>	1	1
E14.2.1 Filing of Charges	1	1
E14.2.2 Ownership of Facilities	1	1
E14.2.3 Interval to Provide Facilities	1	1
E14.2.4 Special Construction Involving Both Interstate and Intrastate Facilities	1	1
E14.2.5 Payments for Special Construction	1	1
E14.2.6 Credit Allowance for Service Interruption	2	2
E14.2.7 Liabilities and Charges for Special Construction	2	2
E14.2.8 Deferral of Start of Service	4	5
E14.2.9 Definitions	5	5.1
<b>E14.3 Rates and Charges</b>	6	6

**Note 1:** Text is shown as new due to reissue of all Tariff Sections. No changes in rates or regulations were made with this filing.

EFFECTIVE: July 15, 1996

## **E14. Special Construction <sup>1</sup>**

(N)

### **E14.1 Application**

#### **E14.1.1 General**

- A. This Section contains regulations, rates, charges and liabilities applicable for the special construction of facilities provided by the Company, which are used to provide intrastate services offered under this Tariff.
- B. When special construction of facilities is required, the provisions of this section apply in addition to all regulations, rates and charges set forth in other sections of this Tariff.
- C. The term "customer", as used in this Tariff section only, refers to the party ordering the facilities that require Special Construction. A customer may be the IC or the End User.

### **E14.2 Regulations**

#### **E14.2.1 Filing of Charges**

- A. Rates, charges and liabilities for special construction to provide facilities will be filed in E14.3 following, if required.

#### **E14.2.2 Ownership of Facilities**

The Company, providing specially constructed facilities under the provisions of this Tariff, retains ownership of all such facilities.

#### **E14.2.3 Interval to Provide Facilities**

Based on available information and the type of service ordered, the Company will establish a completion date for the specially constructed facilities. If the scheduled completion date cannot be met due to circumstances beyond the control of the Company, a new completion date will be established and the customer will be notified.

#### **E14.2.4 Special Construction Involving Both Interstate and Intrastate Facilities**

When special construction involves facilities to be used to provide both interstate and intrastate service, charges for the portion of the construction used to provide intrastate service shall be in accordance with this Tariff. Charges for the portion of the construction used to provide interstate service shall be in accordance with the appropriate FCC Tariff.

#### **E14.2.5 Payments for Special Construction**

- A. Payment of Charges

**Note 1:** Text is shown as new due to reissue of all Tariff Sections. No changes in rates or regulations were made with this filing.

EFFECTIVE: July 15, 1996

## E14. Special Construction<sup>1</sup>

(N)

### E14.2 Regulations (Cont'd)

#### E14.2.5 Payments for Special Construction (Cont'd)

##### A. Payment of Charges (Cont'd)

All bills associated with special construction charges are due in accordance with the appropriate rate regulations in the Tariff under which service is being provided.

Regulations set forth in E2.4.1 shall apply.

##### B. Start/End of Billing

Billing of recurring charges for specially constructed facilities starts on the day after the facilities are made available for use. Billing accrues through and includes the day that the specially constructed facilities are discontinued.

#### E14.2.6 Credit Allowance for Service Interruptions

In the event of a service interruption involving a specially constructed facility, the customer shall receive a recurring monthly charge credit in accordance with the credit allowance provisions in E2.4.4 of this Tariff.

#### E14.2.7 Liabilities and Charges for Special Construction

##### A. General

This section describes the various charges and liabilities that may apply when the company provides special construction of facilities in accordance with an order for service. The customer must provide the Company with written approval of all liabilities and charges prior to the start of construction. If more than one condition requiring special construction is involved, charges for each condition apply (see B. following).

##### B. Conditions Requiring Special Construction

Special construction is required when 1) facilities are not available to meet an order for service, and 2) the Company constructs facilities, and 3) one or more of the following conditions exist:

1. The Company has no other planned use for the facilities requested;
2. The customer requests that service be furnished using a type of facility, or via a route, other than that which the Company would normally utilize in furnishing the requested service;
3. The customer requests the construction of more facilities than would normally be required to satisfy an order;
4. The customer requests that construction be advanced, resulting in added cost to the Company.

**Note 1:** Text is shown as new due to reissue of all Tariff Sections. No changes in rates or regulations were made with this filing.

## E14. Special Construction<sup>1</sup>

(N)

### E14.2 Regulations (Cont'd)

#### E14.2.7 Liabilities and Charges for Special Construction (Cont'd)

##### C. Development of Liabilities and Charges

Special Construction charges and liabilities will be developed based on estimated costs, except when actual costs are requested in writing prior to the start of special construction. In order to meet a scheduled service date when actual costs are requested, an initial special construction case may be prepared based on estimated costs. Such case will be revised when actual costs are available.

##### D. Types of Liabilities and Charges

Depending on the specifics associated with each individual case, one or more of the following special construction charges and/or liabilities may be applicable.

##### 1. Nonrecurring Charge for Special Construction of Facilities for Use for More Than One Month

When special construction of a facility is requested for use for more than one month, a nonrecurring charge will apply. This charge will be composed of several components as described following based on criteria listed in E14.2.7.B.

##### a. Case Preparation Charge Component

This component will always apply and covers the cost of administrative expenses associated with preparing a special construction case and making the associated Tariff filing.

##### b. Expediting Charge Component

This component may apply when a customer requests completion of the special construction on an expedited basis. The charge equals the difference in estimated cost between expedited and non-expedited construction.

##### c. Nonrecoverable Cost Component

This component may apply to specially constructed facilities for use for more than one month, and is equal to the present worth of the capital costs of the nonrecoverable facilities installed to provide service and will be calculated based on the average life of the facility.

##### d. Advancement Charge Component

This component may apply when the customer requests that planned construction be started and completed earlier than scheduled. The charge equals the difference in estimate cost between advanced and planned construction.

##### e. Lease Charge Component

This component may apply when the Company leases equipment in order to meet service requirements. The amount is equal to the net added cost to the Company caused by the lease.

**Note 1:** Text is shown as new due to reissue of all Tariff Sections. No changes in rates or regulations were made with this filing.

EFFECTIVE: July 15, 1996

## E14. Special Construction<sup>1</sup>

(N)

### E14.2 Regulations (Cont'd)

#### E14.2.7 Liabilities and Charges for Special Construction (Cont'd)

##### D. Types of Liabilities and Charges (Cont'd)

##### 1. Nonrecurring Charge for Special Construction of Facilities for Use for More Than One Month (Cont'd)

##### e. Lease Charge Component (Cont'd)

An optional payment arrangement may apply as specified in E. following for specially constructed facilities placed for use for more than one month.

##### 2. Nonrecurring Charge for Special Construction of Facilities for Use for Less Than One Month

Install the specially constructed facilities will apply, i.e., circuit engineering, shipping of equipment, equipment installation, line up, space rental, equipment removal, etc.

An optional payment arrangement, as described in E. following will not apply for specially constructed facilities placed for use for less than one month.

##### 3. Cancellation Charge

If a service order with which special construction is associated is cancelled prior to the start of service, a cancellation charge will apply. The charge will include all nonrecoverable costs incurred by the Company in association with the special construction up to and including the time of cancellation.

##### E. Optional Payment Arrangement

##### 1. Optional Payment Arrangement for Nonrecurring Charge

As an alternative to a lump sum payment of the entire nonrecurring charges as specified in D. preceding, an optional payment arrangement may be elected by the customer. This arrangement provides for amortizing all or a portion of the nonrecurring charge over a payment period, to be specified by the customer, not to exceed ten years, with any portion of the nonrecurring charge which is not amortized due and payable in an up-front lump sum amount. If the customer discontinues use of the specially constructed facilities prior to the end of the chosen payment period, the unpaid principle shall become due and payable in a lump sum.

The Company may reasonably require that the customer provide security for payment of the amount amortized, as a precondition to the customer's use of the Optional Payment Arrangement.

#### E14.2.8 Deferral of Start of Service

The Company may be requested to defer the start of service which will use specially constructed facilities subject to the provisions as set forth in the service Tariff under which the service is being provided. Requests for special construction deferral must be in writing and are subject to the following regulations:

##### A. Construction Has Not Begun

**Note 1:** Text is shown as new due to reissue of all Tariff Sections. No changes in rates or regulations were made with this filing.

EFFECTIVE: July 15, 1996

## E14. Special Construction<sup>1</sup>

(N)

### E14.2 Regulations (Cont'd)

#### E14.2.8 Deferral of Start of Service (Cont'd)

**A. Construction Has Not Begun (Cont'd)**

If the Company has not incurred any installation costs before receiving a request for deferral, no charge applies.

**B. Construction Has Begun**

If the construction of facilities has begun before the Company receives a request for deferral, charges will vary as follows:

**1. All Services Are Deferred**

When all services which will use specially constructed facilities are deferred, a charge based on the costs incurred by the Company during each month of the deferral will apply. Those costs include the recurring costs for that portion of the facilities already completed and any other costs associated with the deferral. The quotation charge and cost of any components of the nonrecurring charge which have been completed at the time of deferral will also apply.

**2. Some Services Are Deferred**

When some services which will use the specially constructed facilities are deferred, the special construction case will be completed and all special construction charges will apply.

**C. Construction Complete**

If the construction of facilities has been completed before the Company receives a request for deferral, all special construction charges will apply.

#### E14.2.9 Definitions

**ACTUAL COST**

The term "Actual Cost" denotes all costs charged against a specific case of special construction, including any appropriate taxes.

**AVERAGE ACCOUNT LIFE**

The term "Average Account Life" denotes the depreciation life prescribed by the Public Service Commission for each class of telephone plant.

**ESTIMATED COST**

The term "Estimated Cost" denotes all estimated costs that will be incurred in providing a specific case of special construction, including any appropriate taxes.

**Note 1:** Text is shown as new due to reissue of all Tariff Sections. No changes in rates or regulations were made with this filing.

ISSUED: July 1, 1996  
BY: Joseph P. Lacher, President - FL  
Miami, Florida

EFFECTIVE: July 15, 1996

## E14. Special Construction<sup>1</sup>

(N)

### E14.2 Regulations (Cont'd)

#### E14.2.9 Definitions (Cont'd)

##### FACILITIES

The term "Facilities" denotes any cable, poles, conduit, microwave or carrier equipment, wire center distribution frames, central office switching equipment, etc., utilized to provide intrastate services offered under the tariffs referenced by this Tariff.

##### INITIAL LIABILITY PERIOD

The term "Initial Liability Period" denotes the initial planning period during which the customer expects to place specially constructed facilities in service.

##### INSTALLED COST

The term "Installed Cost" denotes the total investment (estimated or actual) required by the Company to provide specially constructed facilities.

##### NET SALVAGE

The term "Net Salvage" denotes the estimated scrap, sale, or trade-in value, less the estimated cost of removal. Cost of removal includes the costs of demolishing, tearing down, or otherwise disposing of the material and any other applicable costs. Since the cost of removal may exceed salvage value, net salvage may be negative.

##### NONRECOVERABLE COST

The term "Nonrecoverable Cost" denotes the cost of specially constructed facilities for an individual customer for which the Company has no other planned use should the service be terminated.

(T)

##### NORMAL CONSTRUCTION

The term "Normal Construction" denotes all facilities the Company would normally use to provide service in the absence of a requirement for special construction.

##### NORMAL COST

The term "Normal Cost" denotes the estimated cost to provide services using normal construction.

##### PERMANENT FACILITIES

The term "Permanent Facilities" denotes facilities providing service for one month or more.

### E14.3 Rates and Charges

This section contains special construction charges to provide facilities constructed in accordance with this Tariff as required. Charges are developed on an individual case basis.

**Note 1:** Text is shown as new due to reissue of all Tariff Sections. No changes in rates or regulations were made with this filing.

**E15. RESERVED FOR FUTURE USE<sup>1</sup>**

(N)

CONTENTS

New	Old
Page	Page
1	1

**Note 1:** Text is shown as new due to reissue of all Tariff Sections. No changes in rates or regulations were made with this filing.



BELLSOUTH  
TELECOMMUNICATIONS, INC.  
FLORIDA  
ISSUED: July 1, 1996  
BY: Joseph P. Lacher, President - FL  
Miami, Florida

ACCESS SERVICE TARIFF

Original Page 1

EFFECTIVE: July 15, 1996

**E15. RESERVED FOR FUTURE USE<sup>1</sup>**

(N)

**Note 1:** Text is shown as new due to reissue of all Tariff Sections. No changes in rates or regulations were made with this filing.

ISSUED: February 14, 1997

EFFECTIVE: March 1, 1997

BY: Joseph P. Lacher, President -FL  
Miami, Florida

**E16. ACCESS SERVICE FOR LOCAL EXCHANGE COMPANIES COMPLETION OF  
INTRALATA-INTERCOMPANY LONG DISTANCE MTS AND WATS CALLS** (T)

CONTENTS

<b>E16.1</b>	<b>General</b>	1	
<b>E16.2</b>	<b>General Regulations</b>	1	
<b>E16.3</b>	<b>Rate Regulations</b>	2	
<b>E16.4</b>	<b>Rates and Charges</b>	5	(T)

## E16. ACCESS SERVICE FOR LOCAL EXCHANGE COMPANIES COMPLETION OF INTRALATA-INTERCOMPANY LONG DISTANCE MTS AND WATS CALLS

(T)

### E16.1 General

This section of the Access Service Tariff sets forth the procedures and charges for Local Exchange Companies (LECs) to render payment to other LECs for intraLATA-intercompany Long Distance Message Telecommunications Service (LDMTS) and Wide Area Telecommunications Service (WATS) calls that originate in one LEC's (originating LEC) certificated operating area and complete in another LEC's (terminating LEC) certificated operating area.

These procedures and charges are specific to the provision of the intercompany toll network in which facilities are jointly planned by the participating LECs based on the total usage and transport facilities of each LEC. Facilities that are ordered independently by any individual LEC from another LEC to accommodate a customer-specific request for service are done so through the general offerings made in the Access Service Tariff or the General Subscriber Service Tariff as follows:

*BellSouth SWA* Service is provided for in Section E6., Dedicated Access Service is provided for in Section E7., Billing and Collection Service is provided for in Section E8. and *BellSouth* Directory Assistance *Access Service* is provided for in Section E9. of the Company's Access Service Tariff. Provisions for ordering; special routing; specialized services or arrangements; and installation, repair and testing are provided for in Sections E5., E11., E12. and E13. respectively.

(T)

LDMTS is provided for in Section A18 and WATS is provided for in Section A19 of the LEC's General Subscriber Service Tariff or equivalent.

### E16.2 General Regulations

- A. The originating LEC shall be responsible for recording and rating the terminating minutes of use associated with each originated intraLATA-intercompany LDMTS/WATS call based on the terminating LEC's Access Service Tariff rates.
- B. The originating LEC will render payment to the terminating LEC and any intermediate LEC which provides switching and interoffice transport facilities for the completion of an intraLATA-intercompany LDMTS or WATS call.<sup>1</sup>
- C. Any intermediate LEC which provides switched transport facilities to or from the Access Tandem switch shall receive payment from the originating LEC or terminating LEC.<sup>1</sup>
- D. For *BellSouth SWA 8XX Toll Free Dialing Ten Digit Screening* services calls the originating LEC will be paid originating *BellSouth SWA* charges by the terminating LEC based upon the originating LEC Access Service Tariff rates. The terminating LEC will render payment to any intermediate LEC which provides switching and interoffice transport facilities for the completion of *BellSouth SWA 8XX Toll Free Dialing Ten Digit Screening* service calls.<sup>1</sup>
- E. The originating and terminating LEC shall determine the terminating busy hour minutes of capacity necessary to complete the intraLATA-intercompany LDMTS and WATS calls.
- F. When regulations from preceding sections are determined to apply as set forth in G and I following, where the term IC or Interexchange Carrier is written, substitute LEC to read as one and the same.
- G. The general regulations set forth in Sections E1, E2, E3, E4, E6.7.19, E8.2.1.G.6.(b), E10, and E14 apply to LEC originating and/or terminating intraLATA-intercompany LDMTS and WATS calls except for those listed in H. following.

(T)

**Note 1:** Intermediate companies may include those sharing in joint originating or terminating switching and/or interoffice transport facilities but not serving the originating or terminating customer.

ISSUED: February 14, 1997

EFFECTIVE: March 1, 1997

BY: Joseph P. Lacher, President -FL  
Miami, Florida

## E16. ACCESS SERVICE FOR LOCAL EXCHANGE COMPANIES COMPLETION OF INTRALATA-INTERCOMPANY LONG DISTANCE MTS AND WATS CALLS

(T)

### E16.2 General Regulations (Cont'd)

- H. The following tariff sections do not apply to LECs in the provision of intraLATA LDMTS/WATS services: E2.1.5, E2.1.9, E2.1.13, E2.3.6, E2.3.14, E2.3.15, E2.4.1.A, E2.4.1.D, E2.4.1.G, E2.4.1.H, E2.4.2, E2.4.3, E2.4.4, E2.4.5, E2.4.8, E2.7, E3.1.D, E3.3.A, E3.3.B, E3.3.C, E3.3.D, E3.3.E, E3.3.F, E3.4.A, E3.4.B, E3.4.C, E3.4.D, E3.4.F, E3.4.G, E3.4.H, E3.4.I, E3.6, E3.7.C, E3.7.D, E3.7.E, E3.7.F, E3.7.G, E3.8.A, E4.1.B, E4.1.C, E4.3, E4.4, E4.5.B, E4.5.D, E4.6.A, E5, E6, E7, E8, E9, E11, E12, E13.
- I. The services provided under this Tariff will include outside distribution network facilities. The facilities will be terminated at a place agreed upon by both the originating and terminating LECs.
- J. The originating LEC shall maintain and retain for a minimum of one year, complete, detailed and accurate records, workpapers and backup documentation in form and substance to evidence the payment rendered data provided to the terminating LEC. All of the records, workpapers and backup documentation shall be made available during normal business hours, at the location named in the report, upon reasonable request by the terminating LEC in order to permit a review by the terminating LEC Auditor or outside auditor under contract to the terminating LEC or an auditor of a state regulatory commission.

### E16.3 Rate Regulations

- A. The following rate categories apply to Access Service provided for completion of intraLATA-intercompany LDMTS and WATS calls which are independent of those for the preceding tariff sections. They are:
  - 1. Carrier Common Line Service, which provides for the use of LEC common subscriber plant for access to end users, and is rated per access minute, as shown in E16.4.A. following,
  - 2. Carrier Access Capacity, which is the busy hour minutes of capacity provided by the terminating LEC, is rated based on the busy hour minutes of capacity as of the billing date each month, as shown in E16.4.B. following,
  - 3. *BellSouth SWA* service, which provides for use of LEC common terminating, switching, and interoffice transport facilities, and is shown as a per access minute rate or a monthly flat rate, dependent upon the use of the LEC's interoffice transport facilities as well as the LEC's choice of billing and rendering payments to another LEC. Descriptions of these rate elements are in D. following.
- B. On collect, third number billed, and calling card calls not billed by the originating LEC, a charge for Bill Processing Service will be applicable. The rate for Bill Processing Service will be assessed through intercompany contractual agreements.
- C. The Access Tandem Switching rate category is designed to compensate an intermediate LEC for use of its Access Tandem switch for the completion of an traLATA-intercompany LDMTS/WATS call. The rate shown in E16.C.4. following will be paid by the originating LEC to each intermediate LEC whose Access Tandem switch is used for the intermediate transport of an intraLATA-intercompany LDMTS or WATS call. Access Tandem Switching provides for the function of switching traffic to or from the LEC end office switch(es). Access minutes of use will be utilized for calculation of the Access Tandem Switching charge and the charge is assessed on all minutes of use switched at the Access Tandem.

(T)

ISSUED: July 1, 1996  
BY: Joseph P. Lacher, President - FL  
Miami, Florida

EFFECTIVE: July 15, 1996

## E16. ACCESS SERVICE FOR LOCAL EXCHANGE COMPANIES COMPLETION OF INTRALATA-INTERCOMPANY LONG DISTANCE MTS AND WATS CALLS<sup>1</sup>

(N)

### E16.3 Rate Regulations (Cont'd)

D. The Switched Transport rate category is designed to compensate an intermediate LEC for use of its switched transport interoffice facilities for completion of an intraLATA-intercompany LDMTS/WATS call. Appropriate transport charges shown in E16.4.C following will be paid by the originating LEC to each intermediate LEC whose switched interoffice facilities are used for the intermediate transport of an intraLATA-intercompany LDMTS or WATS call. A per access minute rate or a monthly flat rate, dependent upon the use of the LEC's interoffice transport facilities will be utilized for calculation of the switched transport charges.

#### 1. MABC Local Channel

The MABC Local Channel provides a communications path between two or more intermediate LEC Access Tandems. The standard channel interface defines the technical characteristics associated with the facility. The MABC Local Channel is capable of carrying a combination of traffic types (e.g. Switched Access, IntraLATA LDMTS and WATS, InterLATA LDMTS, etc.).

The MABC Local Channel will be assessed a per minute of use charge or a flat monthly rate based upon the transport facility utilized between LECs and upon the LEC's choice of billing and rendering payment to the intermediate LEC.

The following Access Tandem to Access Tandem routes were analyzed, based on historical minutes of use. It was determined these routes will be rated at the following capacity level:

Access Tandem to Access Tandem Route:	Facility to be Rated:
Between Jacksonville and Live Oak	DS1
Between Panama City and Marianna	DS1
Between Pensacola and Ft. Walton Beach	DS1
Between Pensacola and Crestview (Floral Telephone Company and Frontier Communications)	DS1 Voice Grade - Four Wire
Between Orlando and Winter Park	DS3
Between Orlando and Lake Buena Vista	DS1
Between Panama City and Port St Joe	DS1
Between Gainesville and Ocala	DS3
Between Marianna and Port St. Joe	DS1
Between Winter Park and Lake Buena Vista	DS1

#### 2. MABC Interoffice Channel

The MABC Interoffice Channel provides a transmission facility and the facility termination at the LEC's end office switch and/or the LEC's Access Tandem switch. The Facility Termination applies for each MABC Interoffice Channel termination (i.e. at the LEC end office and/or at the Access Tandem). The MABC Interoffice Channel can be utilized by intermediate LECs for either Switched Common Transport or Switched Dedicated Transport facilities.

For Switched Dedicated Transport, the MABC Interoffice Channel is provisioned between two or more intermediate LEC's end office switch(es), or between the LEC's Access Tandem(s) and the LEC's end office switch(es) or Serving Wire Center(s).

**Note 1:** Text is shown as new due to reissue of all Tariff Sections. No changes in rates or regulations were made with this filing.

ISSUED: February 14, 1997

EFFECTIVE: March 1, 1997

BY: Joseph P. Lacher, President -FL  
Miami, Florida

## **E16. ACCESS SERVICE FOR LOCAL EXCHANGE COMPANIES COMPLETION OF INTRALATA-INTERCOMPANY LONG DISTANCE MTS AND WATS CALLS**

(T)

### **E16.3 Rate Regulations (Cont'd)**

#### **D. (Cont'd)**

##### **2. MABC Interoffice Channel (Cont'd)**

For Switched Common Transport, the MABC Interoffice Channel is provisioned between the intermediate LECs end office switch(es) by switching through one or more LEC's Access Tandem(s). For transport between the Access Tandem and the LEC end office, between the end office which serves as a host for a remote switching system or module (RSS or RSM) and RSS or RSM and for terminating FGA between the dial tone office and end office, the transport will be Switched Common Transport.

Mileage measurement, for Switched Common Transport and Switched Dedicated Transport facilities, will be calculated in accordance with E6.7.19, preceding.

##### **a. Dedicated MABC Interoffice Channel(s)**

The Dedicated MABC Interoffice Channel rate category consist of two rate elements (1) MABC Interoffice Facility and (2) the MABC Interoffice Facility Termination. The Dedicated MABC Interoffice Channel Facility is based on capacity (e.g. Voice Grade (VG), DS1 and/or DS3) and permits the transmission of calls in the originating and/or terminating direction.

The Dedicated MABC Interoffice Channel transmission charge is a monthly, per mile charge based on the capacity of the LEC facility, e.g. VG, DS1 and/or DS3.

The Facility Termination component of the Dedicated MABC Interoffice Channel provides equipment necessary for the termination of the Dedicated MABC Interoffice Channel facility. The MABC Facility Termination charge will apply for each facility termination of greater than zero miles. The MABC Interoffice Channel Facility Termination charge is assessed as a monthly rate. Each MABC Facility Termination charge will be rated at fifty percent of the flat monthly rate if the entire facility is not owned by one LEC.

##### **b. Common MABC Interoffice Channel**

The common MABC Interoffice Channel rate category is composed of switched transport facilities as determined by the LECs and permits the transmission of calls in the originating direction and/or the terminating direction. The MABC Common Interoffice Channel Facility charge will be assessed on a per minute of use, per mile charge on usage of greater than zero miles.

The Facility Termination component of the Common MABC Interoffice Channel provides equipment necessary for the termination of the Common MABC Interoffice Channel facility. The MABC Facility Termination for Common Interoffice Channels will be assessed on a per minute of use on the facility and will be rated at fifty percent of the usage rate if the entire facility is not owned by one LEC.

##### **3. MABC Interconnection**

The MABC Interconnection Charge will be assessed on all LEC originating and terminating minutes of use.

(M)

Material previously appearing on this page now appears on page(s) 5 of this section.

ISSUED: June 21, 2012  
BY: Marshall M. Criser III, President -FL  
Miami, Florida

EFFECTIVE: June 22, 2012

## E16. ACCESS SERVICE FOR LOCAL EXCHANGE COMPANIES COMPLETION OF INTRALATA-INTERCOMPANY LONG DISTANCE MTS AND WATS CALLS

### E16.4 Rates and Charges

A. The rate for Carrier Common Line Access is:

1. Per Originating Access Minute

	Rate	USOC
(a) BellSouth Telecommunications, Inc. - BellSouth SWA FGD and BellSouth SWA TSBSA 3	\$0.01061	NA

(D)

2. Per Terminating Access Minute

(a) BellSouth Telecommunications, Inc. - BellSouth SWA FGD and BellSouth SWA TSBSA 3	.02927	NA
---	--------	----

(D)

B. Carrier Access *Capacity*

1. Per busy hour minutes of capacity<sup>1</sup>

(a) BellSouth Telecommunications, Inc.	-	UCMB
--	---	------

(D)

**Note 1:** The toll (MTS - A18, OUTWATS - A19) rates of the Local Exchange Company where the collect, third party, and pay telephone calls originated will be billed. For an 800 service call, the terminating Local Exchange Company 800 service rates will be billed.

ISSUED: June 21, 2012  
BY: Marshall M. Criser III, President -FL  
Miami, Florida

EFFECTIVE: June 22, 2012

**E16. ACCESS SERVICE FOR LOCAL EXCHANGE COMPANIES COMPLETION OF  
INTRALATA-INTERCOMPANY LONG DISTANCE MTS AND WATS CALLS**

**E16.4 Rates and Charges (Cont'd)**

C. Switched Access Service

1. MABC Local Channel

	Monthly Rate	Rate Per Access Minute	USOC
(a) Voice Grade - Four Wire	\$45.24	\$.005027	NA
(b) DS1 - 1.544 Mbps	133.81	.000619	NA
(c) DS3 - 44.736 Mbps	2,100.00	.000347	NA

2. MABC Interoffice Channel

a. Dedicated Transport

(1) Voice Grade

	Monthly Rate	USOC
(a) Per Mile	\$1.90	NA
(b) Facility Termination	23.30	NA
(2) DS1 - 1.544 Mbps		
(a) Per Mile	16.75	NA
(b) Facility Termination	59.75	NA
(3) DS3 - 44.736 Mbps		
(a) Per Mile	175.00	NA
(b) Facility Termination	1,200.00	NA

3. MABC Interoffice Channel - Common Transport

	Rate Per Access Minute	USOC
(a) Per Mile	\$.00004	NA
(b) Facilities Termination	.00036	NA

4. Access Tandem Switching

(a) Per Access Minute	.00050	NA
-----------------------	--------	----

5. MABC Interconnection

(a) BellSouth Telecommunications, Inc.	.0180	NA
--	-------	----

(D)



ISSUED: June 21, 2012  
BY: Marshall M. Criser III, President -FL  
Miami, Florida

EFFECTIVE: June 22, 2012

**E16. ACCESS SERVICE FOR LOCAL EXCHANGE COMPANIES COMPLETION OF  
INTRALATA-INTERCOMPANY LONG DISTANCE MTS AND WATS CALLS**

**E16.4 Rates and Charges (Cont'd)**

C. Switched Access Service (Cont'd)

(D)

6. End Office

	<b>Rate</b>	<b>USOC</b>
(a) Local Switching - BellSouth Telecommunications, Inc. -per access minute	<b>\$0.00876</b>	<b>NA</b>

BELLSOUTH  
TELECOMMUNICATIONS, INC.  
FLORIDA  
ISSUED: July 1, 1996  
BY: Joseph P. Lacher, President - FL  
Miami, Florida

ACCESS SERVICE TARIFF

Original Page 1

EFFECTIVE: July 15, 1996

**E17. RESERVED FOR FUTURE USE<sup>1</sup>**

(N)

CONTENTS

New	Old
Page	Page
1	1

**Note 1:** Text is shown as new due to reissue of all Tariff Sections. No changes in rates or regulations were made with this filing.

BELLSOUTH  
TELECOMMUNICATIONS, INC.  
FLORIDA  
ISSUED: July 1, 1996  
BY: Joseph P. Lacher, President - FL  
Miami, Florida

ACCESS SERVICE TARIFF

Original Page 1

EFFECTIVE: July 15, 1996

**E17. RESERVED FOR FUTURE USE<sup>1</sup>**

(N)

**Note 1:** Text is shown as new due to reissue of all Tariff Sections. No changes in rates or regulations were made with this filing.

## E18. BELLSOUTH OPERATOR SERVICES ACCESS SERVICE

### CONTENTS

<b>E18.1</b>	<b>Reserved For Future Use</b>	1	(D)
<b>E18.2</b>	<b>Reserved For Future Use</b>	6	
<b>E18.3</b>	<b>BellSouth Operator Assistance Access Service</b>	8	(D)
E18.3.1	General Description	8	
E18.3.2	Operator Assistance Trunks (OA Trunks)	8	
E18.3.3	Obligations of the Customer	9	
E18.3.4	Rate Regulations and Payment Arrangements	9	
E18.3.5	Rates and Charges	12	
<b>E18.4</b>	<b>Reserved For Future Use</b>	12	
<b>E18.5</b>	<b>Reserved For Future Use</b>	12	

BELLSOUTH  
TELECOMMUNICATIONS  
FLORIDA  
ISSUED: April 20, 2017  
BY: Joe York, President -FL  
Jacksonville, Florida

ACCESS SERVICES TARIFF

Second Revised Page 1  
Cancels First Revised Page 1

EFFECTIVE: April 21, 2017

**E18. BELLSOUTH OPERATOR SERVICES ACCESS SERVICE**

**E18.1 Reserved For Future Use**

(D)

(D)

BELLSOUTH  
TELECOMMUNICATIONS  
FLORIDA  
ISSUED: April 20, 2017  
BY: Joe York, President -FL  
Jacksonville, Florida

ACCESS SERVICES TARIFF

Second Revised Page 2  
Cancels First Revised Page 2

EFFECTIVE: April 21, 2017

**E18. BELLSOUTH OPERATOR SERVICES ACCESS SERVICE**

**E18.1 Reserved For Future Use**

(D)

(D)

BELLSOUTH  
TELECOMMUNICATIONS  
FLORIDA  
ISSUED: April 20, 2017  
BY: Joe York, President -FL  
Jacksonville, Florida

ACCESS SERVICES TARIFF

Second Revised Page 3  
Cancels First Revised Page 3

EFFECTIVE: April 21, 2017

## **E18. BELLSOUTH OPERATOR SERVICES ACCESS SERVICE**

### **E18.1 Reserved For Future Use**

(D)

(D)

BELLSOUTH  
TELECOMMUNICATIONS  
FLORIDA  
ISSUED: April 20, 2017  
BY: Joe York, President -FL  
Jacksonville, Florida

ACCESS SERVICES TARIFF

Second Revised Page 4  
Cancels First Revised Page 4

EFFECTIVE: April 21, 2017

**E18. BELLSOUTH OPERATOR SERVICES ACCESS SERVICE**

**E18.1 Reserved For Future Use**

(D)

(D)



BELLSOUTH  
TELECOMMUNICATIONS  
FLORIDA  
ISSUED: April 20, 2017  
BY: Joe York, President -FL  
Jacksonville, Florida

ACCESS SERVICES TARIFF

Second Revised Page 5  
Cancels First Revised Page 5

EFFECTIVE: April 21, 2017

**E18. BELLSOUTH OPERATOR SERVICES ACCESS SERVICE**

**E18.1 Reserved For Future Use**

(D)

(D)

BELLSOUTH  
TELECOMMUNICATIONS  
FLORIDA  
ISSUED: April 20, 2017  
BY: Joe York, President -FL  
Jacksonville, Florida

ACCESS SERVICES TARIFF

Third Revised Page 6  
Cancels Second Revised Page 6

EFFECTIVE: April 21, 2017

## **E18. BELLSOUTH OPERATOR SERVICES ACCESS SERVICE**

### **E18.1 Reserved For Future Use**

(D)

### **E18.2 Reserved For Future Use**

(D)

BELLSOUTH  
TELECOMMUNICATIONS  
FLORIDA  
ISSUED: April 20, 2017  
BY: Joe York, President -FL  
Jacksonville, Florida

ACCESS SERVICES TARIFF

Fourth Revised Page 7  
Cancels Third Revised Page 7

EFFECTIVE: April 21, 2017

## **E18. BELLSOUTH OPERATOR SERVICES ACCESS SERVICE**

### **E18.2 Reserved For Future Use**

(D)

(D)

FLORIDA

ISSUED: May 1, 2003

EFFECTIVE: May 16, 2003

BY: Joseph P. Lacher, President -FL  
Miami, Florida

## E18. OPERATOR SERVICES ACCESS SERVICE

### E18.3 BellSouth Operator Assistance Access Service

#### E18.3.1 General Description

- A. BellSouth Operator Assistance Access Service (BellSouth OA Access Service) provides access to the BellSouth OA Access Service location(s) and the use of BellSouth OA Access Service equipment and operators, when required, to furnish operator assistance to end users on the customer's behalf, to obtain information for the customer's later use in billing for service provided by the Company to the customer's end users on the customer's behalf and for obtaining information for the customer's later use to potentially complete calls returned by the Company to the customer's location per the end user's request.
- B. BellSouth OA Access Service Locations  
The Company will specify the BellSouth OA Access Service location(s) which provide(s) the BellSouth OA Access Service as shown in NATIONAL EXCHANGE CARRIER ASSOCIATION, INC. TARIFF F.C.C. No. 4.  
When it becomes necessary, as determined by the Company, to change a BellSouth OA Access Service location, the Company will notify the involved customers six months prior to the change. For such changes, the regulations as set forth in E2.1.7 of this tariff apply.
- C. Pre-Requisites for BellSouth OA Access Service Provision  
Each BellSouth OA Access Service requires Company provided, customer and application dedicated Operator Assistance trunks (OA Trunks) interconnecting the customer's *high capacity facilities* to the BellSouth OA Access Service location(s), as described further in E18.3.2 following. In addition, the customer must have in place or must order from the Company Common Channel Signaling System Seven (CCS7) links interconnecting the customer's premises and the Company's CCS7 network, as described in E6.1.3 of this Tariff. Further, *customers who wish to utilize release link trunking technology must have in place Nortel DMS 250/500 switching equipment loaded with Nortel level UCS08 (or higher) and feature packages URLT 1, 2, 3 and 4.* (C)
- D. BellSouth OA Access Service "flow"  
When the customer routes an end user request for operator assistance to the BellSouth OA Access Service location via the facilities described in paragraphs A, and B preceding, the Company will optionally brand the call with the customer's name, serve the end user's request on the customer's behalf, obtain information needed for the customer to bill for the service provided, obtain information needed for the customer to complete the end user's call, if call completion is requested, and then will return the information obtained, as well as the call, if call completion is requested, to the customer location with an optional "thank you" branding message.
- E. Optional Branding Announcements  
At the customer's option, Branding Announcements are provided on both the front end and back end of each BellSouth OA Access Service call served. A front end recording will greet each customer end user call with a message of up to three (3) seconds duration which identifies the customer's service (for example, "(customer name)").  
Recording of initial Branding Announcements and changes thereto will be performed on an implementation schedule agreed to between the Company and the customer.  
The customer may request changes to the Branding Announcements currently being provided via BellSouth OA Access Service. The Company will implement such changes within thirty (30) days of receiving the customer's request at the rates and charges detailed for branding in E18.3.5 following.
- F. BellSouth OA Access Service will be provided at rates and charges as set forth in E18.3.5 following, except as provided for in E18.3.4.D. following.
- G. The minimum subscription period for which BellSouth OA Access Service is provided and for which charges apply is one (1) month.

#### E18.3.2 BellSouth Operator Assistance Trunks (OA Trunks)

- A. *BellSouth* Operator Assistance Trunks (OA Trunks) *provide the means to interconnect* the customer's *high capacity facility or facilities (e.g., DS1, BellSouth® MegaLink®, BellSouth® LightGate®, BellSouth® SMARTPath® or BellSouth® SMARTRing®)* at a DS1 level to the *network* location of its operator assistance provider. (C)
- B. *BellSouth* OA Trunks must be present in sufficient number to handle the customer's maximum forecasted call volume. (T)
- C. *BellSouth* OA Trunks have the same transmission specifications as do BellSouth SWA FGD trunks, as described in E6.2.4 of this tariff. (C)
- D. *BellSouth* OA Trunks *support bi-directional transport of customer calls using CCS7 signaling. Each BellSouth OA Trunk must be used exclusively for operator assistance calls because these trunks are not equipped to serve or route other call types.* (C)
- E. Rates and charges for *BellSouth* OA Trunks are as detailed in E18.3.5 following. (T)

FLORIDA

ISSUED: May 1, 2003

EFFECTIVE: May 16, 2003

BY: Joseph P. Lacher, President -FL  
Miami, Florida

## E18. OPERATOR SERVICES ACCESS SERVICE

### E18.3 BellSouth Operator Assistance Access Service (Cont'd)

#### E18.3.2 BellSouth Operator Assistance Trunks (OA Trunks) (Cont'd)

- F. BellSouth OA Trunks must be interconnected with a customer's high capacity facility or facilities (e.g., DS1, BellSouth® MegaLink®, BellSouth® LightGate®, BellSouth® SMARTPath® or BellSouth® SMARTRing®) at a DS1 level in order that BellSouth OA Trunks function properly. BellSouth OA Trunks can be ordered in increments of twenty-four (24) to meet this requirement, with a minimum order of twenty-four (24) BellSouth OA Trunks. Alternatively, customers may utilize a combination of BellSouth OA Trunks and Type 1 BellSouth Flat Rated DA Trunks (as described in E9.6 of this Tariff) to meet this twenty-four (24) trunk requirement. However, each trunk in such a combination must be designated for use to carry either operator assistance calls or directory assistance calls, but not both. (N)

#### E18.3.3 Obligations of the Customer

- A. The customer will cooperatively test with the Company at the time of BellSouth OA Access Service installation.
- B. The customer will provide the Company a forecast of their monthly automated and live operator handled OA Access Service calls.
- C. The customer must order *BellSouth* OA Trunks, as described in E18.3.2 preceding, *from* the Company. *BellSouth OA Trunks must be interconnected with a customer's high capacity facility or facilities (e.g., DS1, BellSouth® MegaLink®, BellSouth® LightGate®, BellSouth® SMARTPath® or BellSouth® SMARTRing®) at a DS1 level in order that BellSouth OA Trunks function properly. BellSouth OA Trunks can be ordered in increments of twenty-four(24) to meet this requirement, with minimum order of twenty-four (24) BellSouth OA Trunks. Alternatively, customers may utilize a combination of BellSouth OA Trunks and Type 1 BellSouth Flat Rated DA Trunks (as described in E9.6 of this Tariff) to meet this twenty-four (24) trunk requirement. However, each trunk in such a combination must be designated for use to carry either operator assistance calls or directory assistance calls, but not both, because OA Trunks and Flat Rated DA Trunks route operator assistance and directory assistance calls, respectively, to groups of Company operators trained and equipped to handle either operator assistance calls or directory assistance calls, but not both.* (C)
- D. (DELETED) (D)
- E. *Customers who wish to utilize Nortel release link trunking technology* must have in place *Nortel* DMS 250/500 switching equipment loaded with *Nortel* software release level UCS08 (or higher) and feature packages URLT 1, 2, 3 and 4. (C)
- F. The customer will deliver calls to the BellSouth OA Service location with industry standard CCS7 call detail.
- G. When opting for the BellSouth OA Access Service Savings Plan, the customer must select plan options for both automated and live operator handled calls.
- H. When opting for the BellSouth OA Access Service Savings Plan, the customer must deliver to the Company within the time frames specified for the plan options selected call volumes that meet or exceed the minimum amounts required for the plan options selected, subject to the regulations detailed in E18.3.4.D. following.

#### E18.3.4 Rate Regulations and Payment Arrangements

- A. Rates for BellSouth OA Access Service are as detailed in E18.3.5 following, except as described in D. and E. following.
- B. When opting for the BellSouth OA Access Service Savings Plan, in no event will the untimely installation or failure of customer equipment required to deliver calls to the BellSouth OA Access Service location relieve the customer of their commitment to deliver to the Company within the time frames specified for the plan options selected call volumes that meet or exceed the minimum amounts required for the plan options selected as detailed in D following.
- C. Service Credit for BellSouth OA Access Service  
A service credit equal to the amounts charged for the BellSouth OA Access Service and/or options as detailed in E18.3.5 or in E. following, if applicable, will apply to the customer's next bill when the Company has received from the customer within sixty (60) days of the occurrence a substantiated claim as follows:
1. A call(s) sent by the customer to the BellSouth OA Access Service location(s) was not answered because the BellSouth OA Access Service location(s) or Company equipment was out of service, or
  2. BellSouth OA Access Service provided no response, or
  3. A request(s) for call completion was not returned to the customer's premises due to failure of the Company's equipment or of the BellSouth OA Access Service.
- D. In the event that OA Access Service is terminated prior to the one (1) month minimum subscription period, usage equal to the customer's forecasted monthly call volume as described in E18.3.3.B. will be applied to the standard per call rates detailed in E18.3.5 to determine the usage portion of the customer's bill. (M)

Material previously appearing on this page now appears on page(s) 10 of this section.

® Registered Service Mark of BellSouth Intellectual Property Corporation  
® BellSouth is a registered trademark of BellSouth Intellectual Property Corporation

FLORIDA  
ISSUED: May 1, 2003  
BY: Joseph P. Lacher, President -FL  
Miami, Florida

EFFECTIVE: May 16, 2003

**E18. OPERATOR SERVICES ACCESS SERVICE**

**E18.3 BellSouth Operator Assistance Access Service (Cont'd)**

**E18.3.4 Rate Regulations and Payment Arrangements (Cont'd)**

- E. BellSouth OA Access Service Savings Plan (M)(T)
  - 1. The BellSouth OA Access Service Savings Plan provides BellSouth OA Access Service customers the option to receive a reduced rate per BellSouth OA Access Service call in exchange for their commitment to deliver specified minimum usage for all OA Access calls sent to the Company during a specified payment plan period. A BellSouth OA Access Service payment plan agreement is required to implement this option. (M)
  - 2. BellSouth OA Access Service Savings Plan subscriber rates are as detailed for each plan option in 13. following. (M)
  - 3. Application of BellSouth OA Access Service Savings Plan rates will commence with the first bill period following the plan option effective date, as agreed to, by and between the customer and the Company. (M)
  - 4. The minimum payment plan period of a BellSouth OA Access Service Savings Plan is twenty-four (24) months and the maximum payment plan period is forty-eight (48) months. (M)
  - 5. Except as indicated in 8., 9., 10., and 11. following, the customer must during the selected payment plan period(s) deliver BellSouth OA Access Service call usage greater than or equal to ninety-five percent (95%) of the minimum OA Access Service call usage required by the payment plan option(s) selected by the customer. (M)
  - 6. At the end of the selected payment plan period(s), if BellSouth OA Access Service per call usage is below ninety-five percent (95%) of the minimum OA Access Service call usage required by the customer's selected plan option(s), the customer will be billed back the difference between the billed plan rate and the standard rate for all calls billed during the payment plan period.
  - 7. At any time during the active option payment plan period an existing BellSouth OA Access Service Savings Plan customer may request an upgrade to a service option having a higher usage commitment and/or a longer payment plan period. A new BellSouth OA Access Service payment plan agreement is required to implement the change.
  - 8. An existing BellSouth OA Access Service Savings Plan customer may request termination of their plan participation. If participation in the customer's currently active plan is ended prior to the scheduled expiration of the payment plan period, back billing of the difference between the then active plan option rates and the standard rates will be applied to a percentage of the calls that have been billed since the initiation of the plan options as follows:

When Plan Option Is Terminated Prior to its Scheduled Expiration and Within __ Months of its Initiation Date	This is the Percentage of Calls to which Back Billing Applies
12 Months	100%
24 Months	90%
36 Months	75%
48 Months	45%

Example: A BellSouth OA Access Service Savings Plan customer who terminates their plan option after 12 months but before 24 months would be billed back on ninety percent (90%) of the calls billed under the plan.

- 9. A customer who terminates their BellSouth OA Access Service Savings Plan is eligible to initiate a new plan six (6) months from the termination date.
- 10. In the event of a merger or acquisition where some or all parties to the merger or acquisition have existing BellSouth OA Access Service Savings Plan options in place, each existing customer may continue their plan option to conclusion provided usage for each existing customer can be segregated from the whole and measured by the Company. Alternatively, the existing BellSouth OA Access Service Savings Plan options of each party to the merger or acquisition may be terminated without penalty provided a new BellSouth OA Access Service Savings Plan option is made effective for the merged or acquiring entity in which the usage commitment is greater than or equal to the sum of the usage commitments for each active plan option of each party to the merger or acquisition.
- 11. In the absence of or upon the expiration of an active BellSouth OA Access Service Plan option(s), the standard rates detailed in E18.3.5 apply.

## E18. OPERATOR SERVICES ACCESS SERVICE

### E18.3 BellSouth Operator Assistance Access Service (Cont'd)

#### E18.3.4 Rate Regulations and Payment Arrangements (Cont'd)

E. BellSouth OA Access Service Savings Plan (Cont'd)

12. Following are the rate schedules for the BellSouth OA Access Service Savings Plan options. When electing to participate in the BellSouth OA Access Service Savings Plan, the customer must choose both an automated and a live operator plan option (one option from each of the tables following) and must specify a payment plan period for each of the two options selected.

For Automated Calls:

Automated Call Plan Option	Call Usage Commitment <sup>1</sup>	Payment Plan Period	Rate Per Call
Option A	1 - 2,999,999	24 months	\$ 0.1675
	1 - 4,499,999	36 months	\$ 0.1650
	1 - 5,999,999	48 months	\$ 0.1600
Option B	3,000,000 - 11,999,999	24 months	\$ 0.1575
	4,500,000 - 17,999,999	36 months	\$ 0.1550
	6,000,000 - 23,999,999	48 months	\$ 0.1500
Option C	12,000,000 - 47,999,999	24 months	\$ 0.1475
	18,000,000 - 71,999,999	36 months	\$ 0.1450
	24,000,000 - 95,999,999	48 months	\$ 0.1400
Option D	48,000,000 - 99,999,999	24 months	\$ 0.1375
	72,000,000 - 149,999,999	36 months	\$ 0.1350
	96,000,000 - 199,999,999	48 months	\$ 0.1300
Option E	100,000,000 or Greater	24 months	\$ 0.1275
	150,000,000 or Greater	36 months	\$ 0.1250
	200,000,000 or Greater	48 months	\$ 0.1200

For Calls Handled by a Live Operator:

Live Operator Call Plan Option	Call Usage Commitment <sup>1</sup>	Payment Plan Period	Rate Per Call
Option A	1 - 2,999,999	24 months	\$ 0.1675
	1 - 4,499,999	36 months	\$ 0.1650
	1 - 5,999,999	48 months	\$ 0.1600
Option B	3,000,000 - 11,999,999	24 months	\$ 0.1575
	4,500,000 - 17,999,999	36 months	\$ 0.1550
	6,000,000 - 23,999,999	48 months	\$ 0.1500
Option C	12,000,000 or Greater	24 months	\$ 0.1475
	18,000,000 or Greater	36 months	\$ 0.1450
	24,000,000 or Greater	48 months	\$ 0.1400

(R)  
(R)  
(R)  
(R)  
(R)  
(R)  
(R)  
(R)  
(R)

**Note 1:** Commitment is for the total of Interstate and Intrastate Usage

**E18. OPERATOR SERVICES ACCESS SERVICE**

**E18.3 BellSouth Operator Assistance Access Service (Cont'd)**

**E18.3.5 Rates and Charges**

A. The following rates apply for BellSouth Operator Assistance Access Service

1. Professional Operator Assistance Services

	<b>Rate</b>	<b>Nonrecurring Charge</b>	<b>USOC</b>	
(a) Per Automated Call Assisted	\$ 0.18	-	NA	
(b) Per Live Operator Call Assisted	0.18	-	NA	(R)

2. Call Branding

(a) Per Branding Announcement Created or Changed	-	\$ 7,000.00	WOABA
(b) Per Platform Shelf Loaded	-	270.00	WOABP

3. Transport of Customer Calls

	<b>Nonrecurring Charges</b>			
	<b>Monthly Rate</b>	<b>First Trunk Installed</b>	<b>Each Add'l Trunk</b>	<b>USOC</b>
(a) Per BellSouth OA Trunk	\$ 6.00	\$ 24.00	\$ 20.00	WOATX

**E18.4 Reserved For Future Use**

**E18.5 Reserved For Future Use**



EFFECTIVE: July 15, 1996

**E19. RESERVED FOR FUTURE USE<sup>1</sup>**

(N)

CONTENTS

New Page	Old Page
1	1

**Note 1:** Text is shown as new due to reissue of all Tariff Sections. No changes in rates or regulations were made with this filing.

BELLSOUTH  
TELECOMMUNICATIONS, INC.  
FLORIDA  
ISSUED: July 1, 1996  
BY: Joseph P. Lacher, President - FL  
Miami, Florida

ACCESS SERVICE TARIFF

Original Page 1

EFFECTIVE: July 15, 1996

**E19. Reserved for Future Use<sup>1</sup>**

(N)

**Note 1:** Text is shown as new due to reissue of all Tariff Sections. No changes in rates or regulations were made with this filing.

BELLSOUTH  
TELECOMMUNICATIONS, INC.  
FLORIDA

ISSUED: April 13, 2005  
BY: Joseph P. Lacher, President -FL  
Miami, Florida

ACCESS SERVICES TARIFF

Second Revised Page 1  
Cancels First Revised Page 1

EFFECTIVE: April 29, 2005

**E20. EXPANDED INTERCONNECTION SERVICE (EIS)**

CONTENTS

<b>E20.1</b>	<b>Virtual Expanded Interconnection Service (VEIS)</b>	1	
E20.1.1	Service Description	1	
E20.1.2	Regulations	1	
E20.1.3	Limitations of Service	3	
E20.1.4	Provision of Service	4	
E20.1.5	Rate Regulations	9	
E20.1.6	Rates and Charges	11	
<b>E20.2</b>	<b>(DELETED)</b>	13	(D)

ISSUED: July 1, 1996  
BY: Joseph P. Lacher, President - FL  
Miami, Florida

EFFECTIVE: July 15, 1996

## **E20. Expanded Interconnection Service (EIS)<sup>1</sup>**

(N)

### **E20.1 Virtual Expanded Interconnection Service (VEIS)**

#### **E20.1.1 Service Description**

- A. Virtual Expanded Interconnection Service (VEIS) provides for central office interconnection of collocator-provided/Company leased transmission equipment to Company Switched and Dedicated Access Services. VEIS for Switched Access is provided at designated central offices, tandems, and remote nodes/switches (e.g., locations). Dedicated Access VEIS is available only at designated central offices. Under VEIS, a collocator provides fiber optic cable up to a Company-designated interconnection point outside of the location, such as a manhole.
- B. The collocator will provide the entrance fiber extending between the interconnection point and the VEIS arrangement location. The Company will lease the entrance fiber under the provisions E20.1.2.A. following, and will install the fiber into the location for connection to VEIS collocator-provided/Company leased transmission equipment. In addition, if multiple entry points are available, and the collocator so desires, multiple entry points will be provided to the collocator. A VEIS arrangement may interconnect with Company Switched Access DS0, DS1 and DS3 level and dedicated access DS0 and DS1 level high capacity services within the location.
- C. Microwave facilities, in lieu of fiber facilities, may be used for interconnection where they may reasonably be provided. Upon receipt of a request for microwave interconnection, the Company will negotiate the arrangements and file the appropriate rates and regulations for the service.
- D. VEIS will be made available subject to the availability of space and facilities in each Company location. The Company's central office, tandem and remote node switch site designations are listed in the National Exchange Carriers Association (NECA) Tariff F.C.C. No. 4.
- E. General regulations, rates, and charges applicable to all VEIS arrangements are contained in this Tariff.

#### **E20.1.2 Regulations**

- A. In order to ensure the compatibility of the transmission capabilities of the facilities and equipment used in the provision of VEIS, such equipment and facilities, including the entrance fiber, associated riser cable/fiber, terminal transmission equipment, plug-ins, software, unique tools and test equipment will be provided by the collocator. The collocator agrees to lease to the Company all the equipment and support structure components required to provision and maintain/repair VEIS on an ongoing basis, for the nominal sum of one dollar.
- B. The Company will designate the point of interconnection in proximity to the location building, which is normally an entrance manhole. The Company reserves the right to prohibit all equipment and facilities, other than cable, within its entrance manholes. No splicing will be permitted in the entrance manhole. The collocator must provide a length of underground fiber optic cable in the entrance manhole specified by the Company which is of sufficient length to be pulled through the conduit and into the cable vault splice locations. The collocator is responsible for placement of the fiber optic facility within the manhole and for the maintenance of the fiber optic cable(s). Before placing the fiber optic facility in the manhole, the collocator will contact the Company for instructions. The collocator agrees to comply with the Company's safety and security rules. Access to the manhole is covered by the terms and conditions specified by the Company.

**Note 1:** Text is shown as new due to reissue of all Tariff Sections. No changes in rates or regulations were made with this filing.

EFFECTIVE: July 15, 1996

## E20. Expanded Interconnection Service (EIS) <sup>1</sup>

(N)

### E20.1 Virtual Expanded Interconnection Service (VEIS) (Cont'd)

#### E20.1.2 Regulations (Cont'd)

- C. The Company will pull the collocator-provided/Company leased fiber cable from the interconnection point to the cable vault where the cable will be spliced to collocator-provided/Company leased fire retardant riser cable which the Company will install.
- D. The VEIS collocator must provide the terminating transmission equipment that the Company will lease and use pursuant to A. preceding to provision the VEIS arrangement. The equipment must comply with the Bellcore Network Equipment Building System (NEBS) General Equipment Requirements (TR-NWT-000063); National Electrical Code standards, and meet the minimum Operational System Modification for Intelligent Network Elements (OSMINE) requirements of coding for the TIRKS System. This minimum includes Human Equipment Catalog Item Group (HECIG), Equipment Catalog Item Group (ECIG) processing code, Human Equipment Catalog Item (HECI), Equipment Catalog Item (ECI) number, and Function Codes as required for provisioning. OSMINE requirements of coding are covered in BellCore Publication GR-485-CORE. Additionally, this equipment must comply with any local, state or federal statutory and/or regulatory requirements in effect at the time or subsequent to equipment installation.
- E. The collocator is responsible for providing the terminating transmission equipment, e.g., fiber optic terminals, channelization equipment, fiber terminating device. The VEIS collocator must also specify all software options for the transmission equipment and associated plug-ins. In addition, the collocator shall provide the following:
- all necessary plug-ins/circuit packs (both working and spare) including any required options that must be physically set on the plug-ins.
  - all unique tools and test equipment.
  - initial and subsequently added equipment should be sized and equipped to handle a minimum of 12 months forecasted growth.
  - rack mounted storage unit to house spare plug-ins, tools, and test equipment.
  - any desired equipment for remote monitoring and control.
  - fuse panel(s) with sufficient capacity for all VEIS transmission equipment.
  - network facility rack(s), i.e., relay racks, to mount all of the above referenced equipment and Company-provided interconnection panel(s).
- F. Any equipment provided under E. preceding shall be leased to the Company in accordance with A. preceding.
- G. Performance monitoring, alarm monitoring and software cross-connect control of all facilities and equipment used in provisioning a VEIS arrangement will be the responsibility of the VEIS collocator. The VEIS collocator will be responsible for initiating maintenance/repair requests for said facilities and equipment, pursuant to J. following.
- If the collocator desires the Company to provide the transport for monitoring and control functions, such transport will be ordered and billed pursuant to the applicable service tariff provisions.
- H. The Company will have responsibility for installation and maintenance/repair of the facilities used to provide VEIS from the point of interconnection up to the collocator's terminating equipment.
- I. The Company will designate a meet-point location within the VEIS site where the Company's switched and dedicated access services will be terminated for interconnection with the VEIS central office equipment.

**Note 1:** Text is shown as new due to reissue of all Tariff Sections. No changes in rates or regulations were made with this filing.

EFFECTIVE: July 15, 1996

## E20. Expanded Interconnection Service (EIS)<sup>1</sup>

(N)

### E20.1 Virtual Expanded Interconnection Service (VEIS) (Cont'd)

#### E20.1.2 Regulations (Cont'd)

- J. The Company will work cooperatively with the VEIS collocator to facilitate joint testing and related activities.
  - 1. The collocator will be responsible for notifying the Company of significant outages of any portion of its network, which could impact or degrade Company switches and services. The collocator will also provide, if possible, an estimated time for restoral.
  - 2. Troubles reported to or observed by the collocator should be tested and isolated by the collocator prior to reporting the trouble to the Company.
- K. All installation work performed on behalf of the collocator must be performed by the Company or a Company-authorized vendor. Authorization procedures may be obtained from the Company, upon request.

#### E20.1.3 Limitations of Service

The following provisions address VEIS interconnections to the Company network and service prohibitions for VEIS arrangements:

- A. Collocators who subscribe to VEIS will not have access to the Company building, except as provided in E20.1.4.H. following.
- B. A Company security escort will accompany the VEIS collocator at the interconnection point outside of the VEIS location. The security escort will be provided at the collocator's expense in accordance with charges described in E20.1.5.A.6. following.
- C. The Company will not interconnect facilities between two or more different collocators within the same central office.
- D. Collocators who subscribe to VEIS may not permit any other person or entity to use the allocated floor space.
- E. VEIS arrangements for Dedicated Access Services will be DS0 and/or DS1 electrical interconnections. VEIS arrangement for Switched Access Services will be DS1 and/or DS3 electrical interconnections.
- F. DS0 Access Service will be delivered to the VEIS arrangement via a DS0 equivalent interface. A DS0 equivalent interface is a DS1 interface using Company-provided DS0 to DS1 multiplexing in the same wire center as the VEIS arrangement.
- G. The VEIS collocator may interconnect at the DS3 level with the following Company Switched Access Services:
  - DS3 Switched Local Channel or Switched Interoffice Channel
  - Switched DS3 to DS1 Channelization Equipment
- H. The VEIS collocator may interconnect at the DS1 level with the following Company services:
  - DS1 Local channel or interoffice channel
  - DS1 Basic channelization system
  - DS1 Switched Local Channel or Switched Interoffice Channel
  - SMARTPath<sup>®</sup> Service
  - DS0 Switched Interoffice Channel

**Note 1:** Text is shown as new due to reissue of all Tariff Sections. No changes in rates or regulations were made with this filing.

<sup>1</sup> Service Mark of BellSouth Corporation

EFFECTIVE: July 15, 1996

## E20. Expanded Interconnection Service (EIS)<sup>1</sup>

(N)

### E20.1 Virtual Expanded Interconnection Service (VEIS) (Cont'd)

#### E20.1.3 Limitations of Service (Cont'd)

H. The VEIS collocator may interconnect at the DS1 level with the following Company services: (Cont'd)

- Switched DS1 to DS0 or analog Channelization Equipment
- Digital Data Access Service
- FlexServ® Channel Connection Service Port
- Voice Grade Access Service

#### E20.1.4 Provision of Service

##### A. Service Application

1. A collocator shall complete and provide to the Company a written application requesting a VEIS service arrangement and an Application Fee per request, per location. Details on the specific requirements of the requested VEIS arrangement, interconnect drawings, technical specifications, monitor and control design and other equipment related documentation, must be provided with the written application.
2. The Company will process applications for VEIS arrangements on a first-come, first-served basis by location as determined through the receipt of the Application Fee.
3. The Company will accept letters of agency in conjunction with an application for VEIS.
4. Upon receipt of the Application Fee, the Company will conduct the following design and planning activities:
  - a. engineering record search and review to determine availability of conduit, rack, floor space and multiple entry points.
  - b. determination of requirements of the requested VEIS design.
  - c. administrative activities required to process the application.
5. Once the Company has completed the design and planning activities, the collocator will be informed of the floor space and power requirements. At this time the Company will provide to the collocator a list of vendors certified to perform equipment installations.
6. A collocator shall have thirty (30) days from receipt of the information to place a firm order.
7. Interconnection space will be made available to each collocator in square foot increments. The collocator's interconnection floor space will be designed with additional interconnection floor space remaining between each VEIS arrangement until interconnection floor space is exhausted.

When a collocator with an existing VEIS arrangement in a given Company central office requests expansion of the current VEIS arrangement and if additional interconnection floor space is available adjacent to the existing arrangement, the Company will retain the contiguous interconnection floor space upon receipt of the Application for Service from the collocator. If contiguous interconnection floor space is not available the Company will design the interconnection floor space that is available pursuant to the Application for Service. Additional interconnection floor space will be made available, and will be contiguous with the collocator's other VEIS arrangements where feasible. Regulations regarding the retention of the interconnection floor space upon receipt of the Application for Service are shown as 6. preceding.

**Note 1:** Text is shown as new due to reissue of all Tariff Sections. No changes in rates or regulations were made with this filing.

ISSUED: July 1, 1996  
BY: Joseph P. Lacher, President - FL  
Miami, Florida

EFFECTIVE: July 15, 1996

## E20. Expanded Interconnection Service (EIS)<sup>1</sup>

(N)

### E20.1 Virtual Expanded Interconnection Service (VEIS) (Cont'd)

#### E20.1.4 Provision of Service (Cont'd)

##### A. Service Application (Cont'd)

8. The Company's engineering and other labor time associated with establishing VEIS arrangement will be billed under the provisions of E13.1.1 and E13.2.6 preceding.
9. The collocator will contract directly with its chosen certified vendor for installation. The Company will retain project management responsibility and authority related to the installation work done in the central office (i.e. decisions as to specific location of the equipment bay, termination panel appearance, assignments, etc.). Equipment installation includes, but is not limited to assembly, floor mounting, connecting power, connecting optical and metallic interfaces, connecting monitoring equipment, turn-up, acceptance testing, stenciling, updating central office records and any other task that may be required for compliance with Company installation standards as contained in TR-73503. The collocator and its chosen vendor will work in close cooperation with Company representatives having project management responsibility and will comply with the installation standards, specified in TR-73503.
10. A collocator agrees to meet with the Company on an as needed basis to review the design and work plans and schedules for the installation of the collocator-provided/Company leased terminating transmission equipment and facilities.

##### B. Service Activation

1. The Company will notify the collocator in writing upon completion of the cable installation work and prior to activating the VEIS arrangement.
2. The Company will provide the VEIS collocator with the circuit identification associated with the collocator-provided/Company leased terminating transmission equipment, as well as specific location of the equipment, e.g. VEIS location, bay location, shelf, etc., at the time of installation.
3. The Company will utilize existing test equipment, or the collocator-provided/Company leased unique test equipment, for acceptance and repair in cooperation with the VEIS collocator.

##### C. Training

If a collocator selects terminating transmission equipment hardware and/or software which is not currently in use in the Company location where VEIS will be provided, the collocator will be responsible for payment of the charges as set forth in E20.1.6.A.7. following, for any necessary training for Company personnel needed to install and repair said equipment. Additionally, the collocator will be responsible for payment of any applicable tuition fees associated with said training.

In the event that the collocator does not provide the necessary training to enable Company personnel to repair said equipment, the Company may call a certified vendor to make repairs of said equipment. The collocator will reimburse the Company for any charges submitted by the certified vendor for repair of said equipment. In addition, charges for security escort will apply as set forth in E20.1.6.A.6. following.

##### D. Inspections

**Note 1:** Text is shown as new due to reissue of all Tariff Sections. No changes in rates or regulations were made with this filing.



FLORIDA

ISSUED: July 1, 1996

EFFECTIVE: July 15, 1996

BY: Joseph P. Lacher, President - FL  
Miami, Florida

## **E20. Expanded Interconnection Service (EIS)<sup>1</sup>**

(N)

### **E20.1 Virtual Expanded Interconnection Service (VEIS) (Cont'd)**

#### **E20.1.4 Provision of Service (Cont'd)**

##### **D. Inspections (Cont'd)**

A VEIS collocator shall call to schedule a time to enter the VEIS location(s) for the purpose of inspecting the terminating transmission equipment dedicated for its use. A Company security escort will accompany the VEIS collocator during said inspections at the expense of the collocator. Security escort rates are as set forth in E20.1.6.A.6. following.

##### **E. Maintenance**

Except in emergency situations, the collocator-provided/Company leased fiber optic cable facilities and terminating transmission equipment will be maintained/repared only upon request of the VEIS collocator. In an emergency, the Company will use reasonable efforts to notify the collocator, but nevertheless may perform such maintenance/repair as deemed necessary without prior notification or request. When initiating maintenance/repair requests on VEIS equipment, the collocator must provide the Company with the associated circuit identifications and specific location of the equipment, as well as a detailed description of the trouble. Charges for maintenance/repair performed upon request from, or on behalf of, the VEIS collocator will be billed to the collocator on a time sensitive basis as described in Section E13. preceding. No charges will be assessed to the VEIS collocator for maintenance if said maintenance is required as a result of negligence or willful misconduct on the part of the Company, or from incidental damage resulting from Company activities. The collocator is responsible for providing equipment required for maintenance/repair spares under the terms of paragraph 20.1.2.E, preceding.

All maintenance/repair on VEIS terminating transmission equipment will be performed by the Company.

##### **F. Liability and Damages**

1. The Company reserves to itself, its successors and assigns, the right to utilize the space within its location(s) in such a manner as will best enable it to fulfill its own service requirements. The Company shall not be liable to the collocator for physical damage to the collocator-provided/Company leased facilities or equipment occupying a Company location unless caused by the negligence or willful misconduct of the Company. In such event, the liability of the Company shall be limited to the reasonable cost of repair/replacement of damaged facilities or equipment. The Company shall have no liability whatsoever to a collocator or customer of the collocator for lost revenues or profits occasioned by any interruption of the collocator's service or interference with the operation of the collocator-provided/Company leased facilities in a Company location(s).
2. The collocator shall indemnify, defend, and save harmless the Company from and against any and all losses, claims, demands, causes of action, and costs, including attorneys' fees, whether suffered, made, instituted, or asserted by the collocator or by any other party or person for damages to property and injury or death to persons, including payments made under any Workers' Compensation Law or under any plan for employees' disability and death benefits, which may arise out of or be caused by the installation, repair, use, or removal of a VEIS collocator-provided/Company leased equipment or facilities, or by their proximity to the equipment or facilities of another VEIS collocator occupying space in a Company location(s), or by any act or omission of the Company, its employees, agents, former or striking employees, or contractors, in connection therewith.

**Note 1:** Text is shown as new due to reissue of all Tariff Sections. No changes in rates or regulations were made with this filing.

## E20. Expanded Interconnection Service (EIS)<sup>1</sup>

(N)

### E20.1 Virtual Expanded Interconnection Service (VEIS) (Cont'd)

#### E20.1.4 Provision of Service (Cont'd)

##### F. Liability and Damages (Cont'd)

3. The collocator shall indemnify, defend, and save harmless the Company from and against any and all losses, claims, demands, causes of action, damages and costs, including but not limited to attorney's fees which may arise out of or be caused by the collocator's presence in the VEIS location and/or acts by the collocator, its employees, agents, or contractors. The collocator shall indemnify, defend, and save harmless the Company from and against any and all damages, costs and expense of relocating conduit systems, when such relocation is necessitated by the VEIS arrangement and/or by acts of the collocator, its employees, agents or contractors.
4. In no event shall the Company or any of its directors, officers or employees or agents be liable for any loss of profit or revenue by the collocator or for any loss of AC or DC power, HVAC interruptions, consequential, incidental, special, punitive or exemplary damages incurred or suffered by the collocator, even if the Company has been advised of the possibility of such loss or damage. The collocator shall indemnify, defend, and hold harmless the Company, its directors, officers and employees, servants, agents, affiliates and parents, from and against any and all claims, cost, expenses or liability arising out of the installation and operation of the collocator-provided/Company leased facilities and equipment within the location.
5. The collocator represents, warrants and covenants that it shall not cause or permit any other party to cause any environmental conditions in, at or affecting the VEIS location which violate any federal, state or local law, ordinance, rule or regulation. The collocator shall indemnify, defend, and hold harmless the Company from any and all liability, damage claim or cost of any kind, including reasonable attorney's fees, resulting from or arising out of any breach of the foregoing sentence.
6. The collocator shall be responsible for the actions of all persons under its control when working in a Company premises, or other point of interconnection outside of the VEIS location.
  - a. If the interconnection floor space or any part thereof shall be damaged by fire or other casualty, the Company shall give immediate notice thereof to the collocator and the provisions of this Tariff shall continue in full force and effect except as hereinafter set forth.
  - b. If the interconnection floor space is partially damaged or rendered partially unusable by fire or other casualty not caused by the collocator, the damages thereto shall be repaired by and at the expense of the Company. The interconnection floor space fee, until such repair shall be substantially completed, shall be reduced from the day following the casualty according to the portion of the interconnection space and/or associated cable and conduit spaces which are rendered unusable.
  - c. If the interconnection floor space, cable space, or conduit space is totally damaged or rendered wholly unusable by fire or other casualty not caused by the collocator, then the occupancy fees shall be paid up to the time of the casualty and thenceforth shall cease until the date when the space shall have been repaired and restored by the Company, subject to the Company's right to elect not to restore the same as hereinafter provided.

**Note 1:** Text is shown as new due to reissue of all Tariff Sections. No changes in rates or regulations were made with this filing.

EFFECTIVE: July 15, 1996

## E20. Expanded Interconnection Service (EIS)<sup>1</sup>

(N)

### E20.1 Virtual Expanded Interconnection Service (VEIS) (Cont'd)

#### E20.1.4 Provision of Service (Cont'd)

##### F. Liability and Damages (Cont'd)

6. The collocator shall be responsible for the actions of all persons under its control when working in a Company premises, or other point of interconnection outside of the VEIS location. (Cont'd)
  - d. If the interconnection floor space, cable space, or conduit space is rendered wholly unusable or if the building shall be so damaged that the Company shall decide to demolish it or not to rebuild it, then, in any of such events, the Company may elect to terminate service under this Tariff by written notice to the collocator given within ninety (90) days after such fire or casualty specifying a date for the cessation of service, which date shall not be more than sixty (60) days after the giving of such notice, and upon the date specified in such notice service under this Tariff shall cease and the VEIS arrangement with the collocator shall forthwith be terminated and the remaining collocator-provided/Company leased equipment removed and returned to the collocator without prejudice however to the Company's rights and remedies against the collocator under the Tariff provisions in effect prior to such termination, and any facility/equipment fees owing shall be paid up to such date and any payments of the fees made by the collocator which were on account of any period subsequent to such date shall be returned to the collocator. Unless the Company shall serve a termination notice as provided for herein, the Company shall make the repairs and restorations under the conditions of b. and c. preceding, with all reasonable expedition subject to delays due to adjustment of insurance claims, labor troubles and causes beyond the Company's reasonable control. After any such casualty, the collocator shall cooperate with the Company's restoration by agreeing to the Company removing from the interconnection floor space all of the salvageable inventory and movable equipment. The collocator's liability for VEIS fees shall resume upon reactivation of service after the Company has notified the collocator that the VEIS arrangement has been restored to a condition comparable to that existing prior to such casualty.

##### G. Confidential Information

The Company agrees to hold in confidence information provided to it by a collocator pursuant to this Tariff; and information known to the Company as a result of the interconnection of collocator-provided/Company leased equipment to Company facilities and services if such information is of a competitive nature. Similarly, the collocator agrees to hold in confidence information provided to it by the Company pursuant to this Tariff if such information is of a competitive nature. Neither party is obligated to hold in confidence information that:

- (1) was already known to the party free of any obligation to keep said information confidential;
- (2) was or becomes publicly available by other than unauthorized disclosure; or
- (3) was rightfully obtained from a third party not obligated to hold such information in confidence.

##### H. Title

This Tariff does not convey to a collocator any right, title or interest in the Company facility; interconnection space; cable space; cable racking; vault or conduit space used in the provisioning of a VEIS arrangement.

**Note 1:** Text is shown as new due to reissue of all Tariff Sections. No changes in rates or regulations were made with this filing.

ISSUED: July 1, 1996

EFFECTIVE: July 15, 1996

BY: Joseph P. Lacher, President - FL  
Miami, Florida

## E20. Expanded Interconnection Service (EIS)<sup>1</sup>

(N)

### E20.1 Virtual Expanded Interconnection Service (VEIS) (Cont'd)

#### E20.1.4 Provision of Service (Cont'd)

##### I. Force Majeure

The Company shall not be liable for any delay or failure in performance of any part of this Tariff to the extent that such failure or delay is caused by acts of God, acts of civil or military authority, government regulations, embargoes, epidemics, war, terrorist acts, riots, insurrections, fires, explosions, earthquakes, nuclear accidents, floods, strikes, power blackouts, volcanic action, other major environmental disturbances, unusually severe weather conditions, inability to secure products or services of other persons or transportation facilities, or acts or omissions of transportation common carriers or other causes beyond the control of the Company.

##### J. Security Arrangements

The collocator agrees to abide by all Company security practices for access to Company central offices.

#### E20.1.5 Rate Regulations

##### A. VEIS Elements

Regulations governing the application of VEIS rates and charges are described following. Rates and charges for each element are specified in E20.1.6 following.

##### 1. Application Fee

An Application Fee in the amount specified in E20.1.6.A.1 following must be submitted with the collocator's application for VEIS. The first-come, first-served policy of processing applications for VEIS arrangements will be determined based upon the order of receipt of applications for VEIS along with the Application Fee. The Application Fee will be used for design and planning activities which include an engineering record search for conduit, rack, and floor space availability, and a determination of requirements for the requested VEIS design.

An Application Fee is required with each VEIS arrangement application submitted per location. If more than one VEIS arrangement is ordered at the same location on the initial VEIS arrangement application, then only one Application Fee will apply. A subsequent application for an additional arrangement within the same location must be submitted with another Application Fee.

##### 2. Cable Installation Charge

The Cable Installation Charge applies for each VEIS cable ordered within a location. Cable installation involves activities associated with pulling the collocator-provided/Company leased fiber cable from the interconnection point to the VEIS terminating equipment or the vault, installing collocator-provided/Company leased fire retardant riser cable, and splicing the entrance fiber cable to the riser cable.

Payment of the Cable Installation Charge must be made prior to the Company commencing work on the VEIS arrangement work order. The Cable Installation Charge will not apply on subsequent VEIS arrangement orders within the same location for the same VEIS collocator if the collocator and Company jointly determine that sufficient cable facilities exist to accommodate the subsequent VEIS arrangement(s).

##### 3. Cable Support Structure

**Note 1:** Text is shown as new due to reissue of all Tariff Sections. No changes in rates or regulations were made with this filing.

## E20. EXPANDED INTERCONNECTION SERVICE (EIS) (T)

### E20.1 Virtual Expanded Interconnection Service (VEIS) (Cont'd)

#### E20.1.5 Rate Regulations (Cont'd)

##### A. VEIS Elements (Cont'd)

##### 3. Cable Support Structure (Cont'd)

The Cable Support Structure monthly recurring charge applies for the use of conduit from the point of interconnection to the cable vault or other central office entrance, and for entrance and riser cable rack space.

##### 4. Cross-Connect

A monthly recurring charge applies for the Cross-Connect elements which consist of the cross-connect panel, cable racks, bay framework and other supporting hardware.

The Cross-Connect element is designated as Switched Access or Dedicated Access depending on the type of service to which it cross connects. (T)

The Switched Access Cross-Connect elements are subject to the jurisdictional report requirements as set forth in E2.3.14 of this Tariff. (T)

*BellSouth Virtual Access Collocation Cross-Connect rates, terms, and conditions are as set forth in E13.3.24 of this Tariff.* (C)

##### 5. Floor Space

Floor Space consists of two recurring rate elements that apply as follows:

Per Square Foot - The Per Square Foot element applies for the floor space required to provision the VEIS arrangement and includes heat, ventilation, and air conditioning (HVAC), lighting, and AC power.

Per Ampere - The Per Ampere element consists of two separate -48 volts direct current feeds (A&B) with battery back-up and applies per ampere for the equipment maximum power requirement.

##### 6. Security Escort

A Security Escort is provided to a collocator whenever the collocator, or approved agent, desires access to the collocator-provided/Company leased terminal transmission equipment.

Charges for a Security Escort are assessed in half-hour increments as either Basic, Overtime or Premium Time charges. A request resulting in the dispatch of a Company employee at a time not consecutive with the employee's scheduled work period is subject to a minimum charge of three (3) hours.

##### 7. Training

When collocator-provided/Company leased equipment (hardware and/or software) is identical to that already in use in the Company location:

No training charges are applicable.

When collocator-provided/Company leased equipment (hardware and/or software) is not identical to that already in use in the Company location:

Charges as set forth in E20.1.6.A.7., following are applicable.

**E20. EXPANDED INTERCONNECTION SERVICE (EIS)**

**E20.1 Virtual Expanded Interconnection Service (VEIS) (Cont'd)**

**E20.1.5 Rate Regulations (Cont'd)**

**B. Access Service Elements**

The access service elements, as set forth in Section E3., Carrier Common Line Access Service; Section E6., Switched Access Service; Section E9., Directory Assistance Access Service; and E18., Operator Service Access Services ordered and/or working in association with DS0/DS1/DS3 Switched Cross-Connect Service will be billed to and paid by the customer of record for the service involved, unless the VEIS customer requests and/or agrees to be responsible for all charges.

For Switched Access Service line or trunk activation charges, see Section E6.8.1 preceding.

BellSouth Virtual Access Collocation Cross-Connect terms, rates, and conditions are as set forth in E13.3.24 of this Tariff. (N)

**E20.1.6 Rates and Charges**

**A. Virtual Expanded Interconnection Service (VEIS)**

1. Application Fee

	Monthly Rate	Nonrecurring Charge	USOC
(a) Per Location	\$-	\$2,848.30	EAF
2. Cable Installation Charge			
(a) Per Cable	-	2,750.00	ESPCX
3. Cable Support Structure			
(a) Per Cable	13.35	-	ESPSX
4. (DELETED)			
5. Floor Space			
	Monthly Rate	Nonrecurring Charge	USOC
(a) Per Square Foot	\$3.20	\$-	ESPVX
(b) Per Ampere	3.48	-	ESPAX

(D)

**E20. Expanded Interconnection Service (EIS) <sup>1</sup>**

(N)

**E20.1 Virtual Expanded Interconnection Service (VEIS) (Cont'd)**

**E20.1.6 Rates and Charges (Cont'd)**

**A. Virtual Expanded Interconnection Service (VEIS) (Cont'd)**

**6. Security Escort**

	<b>First Half Hour Or Fraction Thereof</b>	<b>Each Additional Half Hour Or Fraction Thereof</b>	<b>USOC</b>
(a) Basic Time, normally scheduled work hours	\$41.00	\$25.00	SPTBX
(b) Overtime, outside of normally scheduled working hours on a scheduled work day	48.00	30.00	SPTOX
(c) Premium Time, outside of scheduled work day	55.00	35.00	SPTPX

**7. Training, Per Trainee**

**(1) Living Expenses**

	<b>Nonrecurring Charge</b>	<b>USOC</b>
(a) Per Day	\$136.67	CTRLD
(2) Labor rate, First 1/2 hour and each additional 1/2 or fraction thereof		
(a) Basic Time	30.64	CTRLX
(b) Overtime	35.77	CTRLX
(c) Premium Time	40.90	CTRLX
(3) Air Fare/Travel Expense		
(a) Per Trip	555.00	CTRTA

**Note 1:** Text is shown as new due to reissue of all Tariff Sections. No changes in rates or regulations were made with this filing.

BELLSOUTH  
TELECOMMUNICATIONS, INC.

FLORIDA

ISSUED: April 13, 2005

BY: Joseph P. Lacher, President -FL  
Miami, Florida

ACCESS SERVICES TARIFF

Second Revised Page 13  
Cancels First Revised Page 13

EFFECTIVE: April 29, 2005

## **E20. EXPANDED INTERCONNECTION SERVICE (EIS)**

### **E20.2 (DELETED)**

(D)



BELLSOUTH  
TELECOMMUNICATIONS, INC.  
FLORIDA

ISSUED: April 13, 2005  
BY: Joseph P. Lacher, President -FL  
Miami, Florida

ACCESS SERVICES TARIFF

Second Revised Page 14  
Cancels First Revised Page 14

EFFECTIVE: April 29, 2005

**E20. EXPANDED INTERCONNECTION SERVICE (EIS)**

**E20.2 (DELETED) (Cont'd)**

(D)

BELLSOUTH  
TELECOMMUNICATIONS, INC.  
FLORIDA  
ISSUED: April 13, 2005  
BY: Joseph P. Lacher, President -FL

ACCESS SERVICES TARIFF

Second Revised Page 15  
Cancels First Revised Page 15

EFFECTIVE: April 29, 2005

**E20. EXPANDED INTERCONNECTION SERVICE (EIS)**

**E20.2 (DELETED) (Cont'd)**

(D)

BELLSOUTH  
TELECOMMUNICATIONS, INC.  
FLORIDA

ISSUED: April 13, 2005  
BY: Joseph P. Lacher, President -FL  
Miami, Florida

ACCESS SERVICES TARIFF

Second Revised Page 16  
Cancels First Revised Page 16

EFFECTIVE: April 29, 2005

**E20. EXPANDED INTERCONNECTION SERVICE (EIS)**

**E20.2 (DELETED) (Cont'd)**

(D)

BELLSOUTH  
TELECOMMUNICATIONS, INC.

FLORIDA

ISSUED: April 13, 2005

BY: Joseph P. Lacher, President -FL  
Miami, Florida

ACCESS SERVICES TARIFF

Second Revised Page 17  
Cancels First Revised Page 17

EFFECTIVE: April 29, 2005

**E20. EXPANDED INTERCONNECTION SERVICE (EIS)**

**E20.2 (DELETED) (Cont'd)**

(D)

BELLSOUTH  
TELECOMMUNICATIONS, INC.

FLORIDA

ISSUED: April 13, 2005

BY: Joseph P. Lacher, President -FL  
Miami, Florida

ACCESS SERVICES TARIFF

Second Revised Page 18  
Cancels First Revised Page 18

EFFECTIVE: April 29, 2005

**E20. EXPANDED INTERCONNECTION SERVICE (EIS)**

**E20.2 (DELETED) (Cont'd)**

(D)

BELLSOUTH  
TELECOMMUNICATIONS, INC.

FLORIDA

ISSUED: April 13, 2005

BY: Joseph P. Lacher, President -FL  
Miami, Florida

ACCESS SERVICES TARIFF

Second Revised Page 19  
Cancels First Revised Page 19

EFFECTIVE: April 29, 2005

## **E20. EXPANDED INTERCONNECTION SERVICE (EIS)**

### **E20.2 (DELETED) (Cont'd)**

(D)

BELLSOUTH  
TELECOMMUNICATIONS, INC.

FLORIDA

ISSUED: April 13, 2005

BY: Joseph P. Lacher, President -FL  
Miami, Florida

ACCESS SERVICES TARIFF

Second Revised Page 20  
Cancels First Revised Page 20

EFFECTIVE: April 29, 2005

**E20. EXPANDED INTERCONNECTION SERVICE (EIS)**

**E20.2 (DELETED) (Cont'd)**

(D)

BELLSOUTH  
TELECOMMUNICATIONS, INC.  
FLORIDA  
ISSUED: April 13, 2005  
BY: Joseph P. Lacher, President -FL  
Miami, Florida

ACCESS SERVICES TARIFF

First Revised Page 20.1  
Cancels Original Page 20.1  
EFFECTIVE: April 29, 2005

**E20. EXPANDED INTERCONNECTION SERVICE (EIS)**

**E20.2 (DELETED) (Cont'd)**

(D)



BELLSOUTH  
TELECOMMUNICATIONS, INC.

FLORIDA

ISSUED: April 13, 2005

BY: Joseph P. Lacher, President -FL  
Miami, Florida

ACCESS SERVICES TARIFF

Third Revised Page 21  
Cancels Second Revised Page 21

EFFECTIVE: April 29, 2005

## **E20. EXPANDED INTERCONNECTION SERVICE (EIS)**

### **E20.2 (DELETED) (Cont'd)**

(D)

BELLSOUTH  
TELECOMMUNICATIONS, INC.

FLORIDA

ISSUED: April 13, 2005

BY: Joseph P. Lacher, President -FL  
Miami, Florida

ACCESS SERVICES TARIFF

Second Revised Page 22  
Cancels First Revised Page 22

EFFECTIVE: April 29, 2005

## **E20. EXPANDED INTERCONNECTION SERVICE (EIS)**

### **E20.2 (DELETED) (Cont'd)**

(D)

BELLSOUTH  
TELECOMMUNICATIONS, INC.  
FLORIDA  
ISSUED: April 13, 2005  
BY: Joseph P. Lacher, President -FL  
Miami, Florida

ACCESS SERVICES TARIFF

Third Revised Page 23  
Cancels Second Revised Page 23

EFFECTIVE: April 29, 2005

**E20. EXPANDED INTERCONNECTION SERVICE (EIS)**

**E20.2 (DELETED) (Cont'd)**

(D)

BELLSOUTH  
TELECOMMUNICATIONS, INC.  
FLORIDA  
ISSUED: April 13, 2005  
BY: Joseph P. Lacher, President -FL  
Miami, Florida

ACCESS SERVICES TARIFF

Second Revised Page 24  
Cancels First Revised Page 24  
EFFECTIVE: April 29, 2005

**E20. EXPANDED INTERCONNECTION SERVICE (EIS)**

**E20.2 (DELETED) (Cont'd)**

(D)

BELLSOUTH  
TELECOMMUNICATIONS, INC.  
FLORIDA

ACCESS SERVICES TARIFF

Second Revised Page 25  
Cancels First Revised Page 25

ISSUED: April 13, 2005  
BY: Joseph P. Lacher, President -FL  
Miami, Florida

EFFECTIVE: April 29, 2005

**E20. EXPANDED INTERCONNECTION SERVICE (EIS)**

**E20.2 (DELETED) (Cont'd)**

(D)

BELLSOUTH  
TELECOMMUNICATIONS, INC.  
FLORIDA

ISSUED: April 13, 2005  
BY: Joseph P. Lacher, President -FL  
Miami, Florida

ACCESS SERVICES TARIFF

First Revised Page 25.1  
Cancels Original Page 25.1

EFFECTIVE: April 29, 2005

**E20. EXPANDED INTERCONNECTION SERVICE (EIS)**

**E20.2 (DELETED) (Cont'd)**

(D)

BELLSOUTH  
TELECOMMUNICATIONS, INC.  
FLORIDA

ISSUED: April 13, 2005  
BY: Joseph P. Lacher, President -FL  
Miami, Florida

ACCESS SERVICES TARIFF

Second Revised Page 26  
Cancels First Revised Page 26

EFFECTIVE: April 29, 2005

**E20. EXPANDED INTERCONNECTION SERVICE (EIS)**

**E20.2 (DELETED) (Cont'd)**

(D)

BELLSOUTH  
TELECOMMUNICATIONS, INC.  
FLORIDA  
ISSUED: April 13, 2005  
BY: Joseph P. Lacher, President -FL  
Miami, Florida

ACCESS SERVICES TARIFF

First Revised Page 27  
Cancels Original Page 27

EFFECTIVE: April 29, 2005

**E20. EXPANDED INTERCONNECTION SERVICE (EIS)**

**E20.2 (DELETED) (Cont'd)**

(D)



BELLSOUTH  
TELECOMMUNICATIONS, INC.  
FLORIDA

ACCESS SERVICES TARIFF

First Revised Page 28  
Cancels Original Page 28

ISSUED: April 13, 2005  
BY: Joseph P. Lacher, President -FL  
Miami, Florida

EFFECTIVE: April 29, 2005

## **E20. EXPANDED INTERCONNECTION SERVICE (EIS)**

### **E20.2 (DELETED) (Cont'd)**

(D)

BELLSOUTH  
TELECOMMUNICATIONS, INC.  
FLORIDA  
ISSUED: April 13, 2005  
BY: Joseph P. Lacher, President -FL  
Miami, Florida

ACCESS SERVICES TARIFF

Second Revised Page 29  
Cancels First Revised Page 29

EFFECTIVE: April 29, 2005

**E20. EXPANDED INTERCONNECTION SERVICE (EIS)**

**E20.2 (DELETED) (Cont'd)**

(D)

BELLSOUTH  
TELECOMMUNICATIONS, INC.  
FLORIDA

ACCESS SERVICES TARIFF

First Revised Page 30  
Cancels Original Page 30

ISSUED: April 13, 2005  
BY: Joseph P. Lacher, President -FL  
Miami, Florida

EFFECTIVE: April 29, 2005

## **E20. EXPANDED INTERCONNECTION SERVICE (EIS)**

### **E20.2 (DELETED) (Cont'd)**

(D)

BELLSOUTH  
TELECOMMUNICATIONS, INC.  
FLORIDA

ISSUED: April 13, 2005  
BY: Joseph P. Lacher, President -FL  
Miami, Florida

ACCESS SERVICES TARIFF

Second Revised Page 31  
Cancels First Revised Page 31

EFFECTIVE: April 29, 2005

## **E20. EXPANDED INTERCONNECTION SERVICE (EIS)**

### **E20.2 (DELETED) (Cont'd)**

(D)

BELLSOUTH  
TELECOMMUNICATIONS, INC.  
FLORIDA

ACCESS SERVICES TARIFF

Second Revised Page 32  
Cancels First Revised Page 32

ISSUED: April 13, 2005  
BY: Joseph P. Lacher, President -FL  
Miami, Florida

EFFECTIVE: April 29, 2005

**E20. EXPANDED INTERCONNECTION SERVICE (EIS)**

**E20.2 (DELETED) (Cont'd)**

(D)

BELLSOUTH  
TELECOMMUNICATIONS, INC.

FLORIDA

ISSUED: April 13, 2005

BY: Joseph P. Lacher, President -FL  
Miami, Florida

ACCESS SERVICES TARIFF

Second Revised Page 33  
Cancels First Revised Page 33

EFFECTIVE: April 29, 2005

## **E20. EXPANDED INTERCONNECTION SERVICE (EIS)**

### **E20.2 (DELETED) (Cont'd)**

(D)

BELLSOUTH  
TELECOMMUNICATIONS, INC.

FLORIDA

ISSUED: April 13, 2005

BY: Joseph P. Lacher, President -FL  
Miami, Florida

ACCESS SERVICES TARIFF

Second Revised Page 34  
Cancels First Revised Page 34

EFFECTIVE: April 29, 2005

## **E20. EXPANDED INTERCONNECTION SERVICE (EIS)**

### **E20.2 (DELETED) (Cont'd)**

(D)

BELLSOUTH  
TELECOMMUNICATIONS, INC.

FLORIDA

ISSUED: April 13, 2005

BY: Joseph P. Lacher, President -FL  
Miami, Florida

ACCESS SERVICES TARIFF

Second Revised Page 35  
Cancels First Revised Page 35

EFFECTIVE: April 29, 2005

## **E20. EXPANDED INTERCONNECTION SERVICE (EIS)**

### **E20.2 (DELETED) (Cont'd)**

(D)

All BellSouth marks contained herein and as set forth in the trademarks and servicemarks section of this Tariff are owned by BellSouth Intellectual Property Corporation.



## E21. FAST PACKET ACCESS SERVICE

### CONTENTS

<b>E21.1 Exchange Access Frame Relay Service (XAFRS) (a.k.a. BellSouth Exchange Access Frame Relay Service)</b>	1	
E21.1.1 Service Description	1	
E21.1.2 Rate Categories	2	
E21.1.3 Acceptance Testing	4	
E21.1.4 Ordering Options and Conditions	4	
E21.1.5 Rate Regulations	4	
E21.1.6 Rates and Charges	5.4	(T)
<b>E21.2 (Deleted)</b>	7	(T)
<b>E21.3 BellSouth Exchange Access Asynchronous Transfer Mode Service (XAATMS)</b>	12	
E21.3.1 Service Description	12	
E21.3.2 Rate Categories	14	
E21.3.3 Acceptance Testing	16	
E21.3.4 Ordering Options and Conditions	16	
E21.3.5 Rate Regulations	16	
E21.3.6 Rates and Charges	17	
<b>E21.4 Reserved For Future Use</b>	18	
<b>E21.5 Reserved For Future Use</b>	18	
<b>E21.6 BellSouth Network Visibility Service</b>	18	
E21.6.1 General	18	
E21.6.2 Rate Regulations	20	
E21.6.3 Rate Categories	21	
E21.6.4 Rates and Charges	22	

## E21. FAST PACKET ACCESS SERVICE

### E21.1 Exchange Access Frame Relay Service (XAFRS) (a.k.a. BellSouth Exchange Access Frame Relay Service)<sup>1</sup>

(C)

#### E21.1.1 Service Description

- A. Exchange Access Frame Relay Service (XAFRS) (a.k.a. BellSouth Exchange Access Frame Relay service) is a connection oriented packet-switched data service allowing for the interconnection of local area networks (LANs) or other compatible customer equipment. This service provides efficient throughput at various transmission speeds.

XAFRS (a.k.a. BellSouth Exchange Access Frame Relay service) allows for the transfer of variable length frames (packets). Frames are relayed by virtual connections; frames travel a fixed path through the network although bandwidth is not dedicated to each virtual connection.

This service uses Permanent Virtual Circuit (PVCs). A PVC is a logical channel from one XAFRS (a.k.a. BellSouth Exchange Access Frame Relay service) network interface to another XAFRS (a.k.a. BellSouth Exchange Access Frame Relay service) network interface. PVCs are end-to-end, bi-directional channels that are established either by the Company via the service provisioning process or by the customer using optional Customer Configuration Management Capability described in E21.1.2.A.2.c. following.

The XAFRS (a.k.a. BellSouth Exchange Access Frame Relay service) standard specifies an address field called the Data Link Connection Identifier (DLCI). The DLCI specifies a connection. A Standard PVC is created via the mapping of two Standard DLCIs; on an optional basis, features are available to allow the creation of Priority PVCs.

XAFRS (a.k.a. BellSouth Exchange Access Frame Relay service) is comprised of a network interface component plus optional features. Connection to XAFRS (a.k.a. BellSouth Exchange Access Frame Relay service) network interfaces may be accomplished through dedicated access. For intrastate dedicated access, rates, charges, and regulations for Special Access (a.k.a. BellSouth SPA) service are specified in Section E7. of this Tariff. Only non-channelized bandwidth may terminate on an XAFRS (a.k.a. BellSouth Exchange Access Frame Relay service) network interface.

There are two network interfaces available - a User Network Interface (UNI) and a Network-to-Network Interface (NNI).

The User Network Interface (UNI) is a standard interface used to connect the customer to the XAFRS (a.k.a. BellSouth Exchange Access Frame Relay service) network. It receives the data frame from the customer's network or device and verifies that the DLCI is valid before relaying the frame to the destination. The UNI is offered at transmission speeds of 56 Kbps, 64 Kbps, 1.536 Mbps, and 44.210 Mbps.

The Network-to-Network Interface (NNI) specifies how an XAFRS (a.k.a. BellSouth Exchange Access Frame Relay service) switch sends and receives data from another provider's Frame Relay switch. The NNI is offered at transmission speeds of 56 Kbps, 64 Kbps, 1.536 Mbps and 44.210 Mbps.

#### B. Technical Specifications

The provision of Exchange Access Frame Relay Service (XAFRS) (a.k.a. BellSouth Exchange Access Frame Relay service) requires the applicable network interface component. In addition, the customers may add optional features. Each of the components of the service are described in this Section.

All services installed after the effective date of this Tariff will conform to the transmission specification standards in the following references:

UNI Specifications for XAFRS (a.k.a. BellSouth Exchange Access Frame Relay service) are:

ANSI T1.617-1991, "Integrated Services Digital Network (ISDN) - Digital Subscriber Signaling System No. 1 (DSS1) - Signaling Specification for Frame Relay Service", American National Standards Institute, and ANSI T1.618-1991, "Integrated Services Digital Network (ISDN) - Core Aspects of Frame Relay Bearer Service", American National Standards Institute. This document is available from the American National Standards Institute, 11 West 42nd Street, New York, N.Y. 10036.

All UNI access facilities must be in conformance with ANSI standards T1.617-1991, T1.618-1991. These documents are available from the American National Standards Institute, 11 West 42nd Street, New York, New York 10036.

- Note 1:** Effective August 1, 2019, Exchange Access Frame Relay Service (XAFRS) will no longer be available to new Customers. Existing term plan Customers, as of August 1, 2019, may add, move, remove or change lines and/or locations for the duration of their current term plan agreements, but may not enter into any new term plan agreements. Upon expiration of any term plan agreement, service will continue on a month-to-month basis until the service is discontinued by the Telephone Company.

(N)

## E21. FAST PACKET ACCESS SERVICE

### E21.1 Exchange Access Frame Relay Service (XAFRS) (a.k.a. BellSouth Exchange Access Frame Relay Service)<sup>1</sup> (Cont'd)

(C)

#### E21.1.1 Service Description (Cont'd)

##### B. Technical Specifications (Cont'd)

Document No. 001-208966, "Frame Relay Specification with Extension Based on Proposed T1S1 Standards", Digital equipment Corporation, Northern Telecom, Inc., and StrataCom, Inc. This document is available from the Frame Relay Forum, 39355 California Street, Suite 307, Fremont, CA 94538.

NNI Specifications for XAFRS (a.k.a. BellSouth Exchange Access Frame Relay service) are:

Frame Relay Forum Document FRF.2, Frame Relay Network-to-Network Phase 1 Implementation Agreement. This document is available from the Frame Relay Forum, 39355 California Street, Suite 307, Fremont, CA 94538.

All NNI access facilities must be in conformance with ANSI standards and Telcordia Technical Reference TS-TSV-001370. This document is available from Telcordia Technologies, Direct Sales, 8 Corporate Place, PYA 3A-184, Piscataway, N.J. 08854

Performance specifications and service details for XAFRS (a.k.a. BellSouth Exchange Access Frame Relay service) are provided in:

BellSouth Technical Reference 73587, Frame Relay Service Interface and Performance Specifications. This document is available from BellSouth Telecommunications, Inc., Regional Documentation Coordinator, 20th Floor, 600 North 19th Street, Birmingham, AL 35203.

##### C. Interface Specifications

The following specifications are available with this service:

- Digital Packet (UNI)
- Digital Packet (NNI)

#### E21.1.2 Rate Categories

##### A. The following rate categories apply to XAFRS (a.k.a. BellSouth Exchange Access Frame Relay service) :

###### 1. Network Interface

This rate category provides for the customer's termination on the Fast Packet switch. The Network Interface rate category includes the packet switching function.

###### 2. Optional Features

The Optional Features rate category provides for optional features which may be added to XAFRS (a.k.a. BellSouth Exchange Access Frame Relay service) to improve its quality or utility to meet specific communications requirements.

###### a. DLCIs per UNI or NNI

This feature provides for the assignment of Data Link Channel Identifiers (DLCIs) per UNI or NNI. One DLCI is required per UNI or NNI. When any two DLCIs are mapped together, a PVC can be created.

One Initial DLCI is applicable when DLCIs are ordered at the same time as the installation of a UNI or NNI. Only one "Initial" DLCI (either one Initial Standard DLCI or one Initial Priority DLCI) is allowed per UNI or NNI. Additional DLCIs (beyond this initial DLCI) ordered with the installation of the UNI or NNI and any DLCIs ordered subsequent to the installation of the UNI or NNI are considered Additional DLCIs. A DLCI which is not a Priority DLCI, as discussed following, is referred to as a Standard DLCI.

Priority PVC capability allows a customer to differentiate specific PVCs with regard to the importance of the data within those PVCs as compared to other PVCs. In the case of contention or network congestion, the network will give precedence to the frames of a Priority PVC over frames of a Standard PVC. XAFRS (a.k.a. BellSouth Exchange Access Frame Relay service) allows the creation of Priority PVCs. Such a Priority PVC is formed by the mapping of two Priority DLCIs (as set forth in E21.1.6.B.1. following); these Priority DLCIs must have an associated CIR value of greater than zero. A request to convert an existing Standard PVC to a Priority PVC (or vice versa) shall be considered as a request to disconnect the existing DLCIs and as a request to connect the new DLCIs.

Individual DLCI charges are not applicable to the standard configurable DLCIs provided within a Configurable DLCI Bundle associated with optional Customer Configuration Management Capability described in E21.1.2.A.2.c. following. Configurable DLCIs are considered as additional standard DLCIs.

**Note 1:** Effective August 1, 2019, Exchange Access Frame Relay Service (XAFRS) will no longer be available to new Customers. Existing term plan Customers, as of August 1, 2019, may add, move, remove or change lines and/or locations for the duration of their current term plan agreements, but may not enter into any new term plan agreements. Upon expiration of any term plan agreement, service will continue on a month-to-month basis until the service is discontinued by the Telephone Company.

(N)

## E21. FAST PACKET ACCESS SERVICE

### E21.1 Exchange Access Frame Relay Service (XAFRS) (a.k.a. BellSouth Exchange Access Frame Relay Service)<sup>1</sup> (Cont'd) (C)

#### E21.1.2 Rate Categories (Cont'd)

- A. The following rate categories apply to XAFRS (a.k.a. BellSouth Exchange Access Frame Relay service): (Cont'd)
2. Optional Features (Cont'd)
- b. Committed Information Rate (CIR)

Committed Information Rate is a feature that enables the customer to select a sustained throughput under normal conditions. A CIR must be selected for each DLCI. A CIR selected with a value greater than zero has a separate charge from any DLCI charges. The CIR value selected cannot exceed the minimum transmission speed of the XAFRS Network Interface at either end of the PVC. (The Frame Relay network's burst capability and discard eligible feature are described in TR 73587.)

The CIR value of Priority DLCIs must be greater than zero.

**Note 1:** Effective August 1, 2019, Exchange Access Frame Relay Service (XAFRS) will no longer be available to new Customers. Existing term plan Customers, as of August 1, 2019, may add, move, remove or change lines and/or locations for the duration of their current term plan agreements, but may not enter into any new term plan agreements. Upon expiration of any term plan agreement, service will continue on a month-to-month basis until the service is discontinued by the Telephone Company. (N)

## E21. FAST PACKET ACCESS SERVICE

### E21.1 Exchange Access Frame Relay Service (XAFRS) (a.k.a. BellSouth Exchange Access Frame Relay Service)<sup>1</sup> (Cont'd)

(C)

#### E21.1.2 Rate Categories (Cont'd)

A. The following rate categories apply to XAFRS (a.k.a. BellSouth Exchange Access Frame Relay service); (Cont'd)

2. Optional Features (Cont'd)

c. Customer Configuration Management Capability

Configuration Management Capability is optionally available for an XAFRS customer to have the ability to add, change and delete PVCs for their XAFRS Network Interface themselves, without utilizing the standard ordering/provisioning process to request the Company to perform these functions. PVCs created thru the standard ordering/provisioning process by the Company are standard non-configurable PVCs and cannot be modified by the customer as described herein thru Customer Configuration Management Capability; the customer is billed the preceding DLCI and CIR rates and charges for standard non-configurable PVCs. PVCs created thru Customer Configuration Management Capability are referred to as configurable PVCs and may be created and modified by the customer as described herein; the customer is billed the charges described following for such configurable PVCs. A customer may choose to utilize one or both of these methods for establishing PVCs on a given XAFRS Network Interface.

Customer Configuration Management Capability is available only for XAFRS Network Interfaces equipped with Network Visibility Service (NVS) and is available only for the customer to add, modify or delete configurable PVCs formed between similarly equipped Frame Relay service with NVS and Customer Configuration Management Capability.

Customer Configuration Management Capability is established via the standard ordering/provisioning process on a per XAFRS Network Interface basis when a minimum of one Configurable DLCI Bundle is ordered.

DLCIs in a Configurable DLCI Bundle will be referred to as configurable DLCIs. Two configurable DLCIs mapped thru Customer Configuration Management Capability form a configurable PVC.

To utilize Customer Configuration Management Capability, each XAFRS Network Interface must have a minimum of one Configurable DLCI Bundle ordered by the customer. More than one Configurable DLCI Bundle may be ordered for a specific XAFRS Network Interface to establish the block, or total quantity, of configurable DLCIs available for that XAFRS Network Interface. The block of configurable DLCIs established are only for the use of that single XAFRS Network Interface may not be "shared" with other XAFRS Network Interfaces.

A monthly rate applies for each Configurable DLCI Bundle ordered and the rate varies based upon the quantity of configurable DLCIs included in each bundle. Each Configurable DLCI Bundle provides a specific quantity of standard configurable DLCIs, each with a maximum CIR of up to 64 Kbps per configurable DLCI. Customers will order the quantity and size bundles that will provide the total quantity or block of configurable DLCIs needed for an XAFRS Network Interface. The configurable DLCI block quantity is then the customer-established limit of the number of configurable DLCIs which the customer may manage on a specific XAFRS Network Interface. The block of configurable DLCIs selected for an XAFRS Network Interface may be increased or decreased as the customer's needs change. The Configurable DLCI Block Establishment/Change Charge is the nonrecurring charge applicable for initially ordering and provisioning the Configurable DLCI Bundle(s) to establish the configurable DLCI block and for making a subsequent request to change the block size (i.e., add or delete bundles).

The Configurable DLCI Block Establishment/Change Charge is a nonrecurring charge applicable to initially establish the block of configurable DLCIs for an XAFRS Network Interface. This charge is also applicable per subsequent request to change the size of the configurable DLCI block. Only one such nonrecurring charge applies per request regardless of how many Configurable DLCI Bundles are requested to initially establish the block or are requested subsequently to be added or deleted.

With Customer Configuration Management Capability, the customer will have the capability to add, change and/or delete configurable PVCs formed by the mapping of two configurable DLCIs. A PVC cannot be established between a configurable DLCI and a non-configurable DLCI thru either Customer Configuration Management Capability or thru the standard ordering/provisioning process. Customer Configuration Management Capability cannot be utilized to make changes to a non-configurable PVC, and the standard ordering/provisioning process cannot be utilized to create, modify or delete a configurable PVC.

**Note 1:** Effective August 1, 2019, Exchange Access Frame Relay Service (XAFRS) will no longer be available to new Customers. Existing term plan Customers, as of August 1, 2019, may add, move, remove or change lines and/or locations for the duration of their current term plan agreements, but may not enter into any new term plan agreements. Upon expiration of any term plan agreement, service will continue on a month-to-month basis until the service is discontinued by the Telephone Company.

(N)

## E21. FAST PACKET ACCESS SERVICE

### E21.1 Exchange Access Frame Relay Service (XAFRS) (a.k.a. BellSouth Exchange Access Frame Relay Service)<sup>1</sup> (Cont'd)

(C)

#### E21.1.2 Rate Categories (Cont'd)

- A. The following rate categories apply to XAFRS (a.k.a. BellSouth Exchange Access Frame Relay service): (Cont'd)
2. Optional Features (Cont'd)
  - c. Customer Configuration Management Capability (Cont'd)

As a current technical limitation Customer Configuration Management Capability cannot be utilized for Priority PVCs. Therefore, requests for such PVCs will have to be made thru the standard ordering/provisioning process for the Company to provision and will be subject to the preceding standard rates and charges for such features.

Customer Configuration Management Capability may only be utilized to create configurable PVCs between two Frame Relay services equipped with NVS and Customer Configuration Management Capability within the same LATA.

A customer may request that some or all of the standard DLCIs associated with an existing XAFRS Network Interface with Customer Configuration Management Capability be converted to Configurable DLCIs. Only standard DLCIs that are mapped to other Network Interfaces also equipped for Customer Configuration Management can be converted (subject to any limitations set forth herein on what types of PVCs are technically compatible with Customer Configuration Management Capability). The DLCI Conversion Charge is the nonrecurring charge applicable per standard DLCI requested to be converted to a configurable DLCI. Once converted to a configurable DLCI, that DLCI will be counted against the XAFRS Network Interface configurable DLCI block quantity; monthly rates for the standard DLCI and associated CIR will concurrently no longer apply.

A customer may request that some or all of the configurable DLCIs associated with an existing XAFRS Network Interface with Customer Configuration Management Capability be converted to standard DLCIs which the customer will no longer manage. Such requests will convert the configurable DLCI "as is" to a standard DLCI (i.e., standard additional DLCI with same CIR value). The DLCI Conversion Charge is the nonrecurring charge applicable per configurable DLCI requested to be converted to a standard DLCI. Once converted to a standard DLCI, that DLCI (and associated CIR) will begin billing the standard DLCI and CIR monthly rates and will concurrently no longer count against the configurable DLCI block quantity for that XAFRS Network Interface.

After the customer has established Customer Configuration Management Capability (by ordering Configurable DLCI Bundles to establish the configurable DLCI block for each XAFRS Network Interface) for their network, the customer will have access thru the NVS system to mechanically add, change and delete configurable PVCs between these XAFRS Network Interfaces.

A Customer Configuration Management service request is made thru NVS for a specific PVC activity (e.g., add configurable PVC, change CIR or endpoint on an existing configurable PVC, delete configurable PVC, etc.) involving Frame Relay services equipped with NVS and Customer Configuration Management Capability. Each Customer Configuration Management service request will be assigned a service request number to facilitate customer questions and to enable status and tracking.

A Customer Configuration Management service request will be provisioned within minutes; however a Cancellation Window of two hours is allowed after successful provisioning during which time the customer may submit a request thru NVS to cancel or "undo" the request before the change becomes permanent. The customer may specifically request to forgo (close) the Cancellation Window during which a particular service request may be cancelled and commit that NVS make the service request provisioning become permanent immediately. When the Cancellation Window expires without the customer canceling the service request or the customer foregoes/closes the Cancellation Window, the provisioned service request is made permanent and considered a completed transaction.

Customer Configuration Management Capability effectively provides the customer near real-time processing capability to allow them to manage the provisioning and change activities for configurable PVCs within their network. However, access to Customer Configuration Management Capability is not guaranteed for customer access and use twenty-four hours a day/seven days a week. Customer access may be periodically preempted for higher priority Company network management and maintenance activities. Customer inability to access the NVS/Customer Configuration Management systems during these periods will not be considered a service outage.

**Note 1:** Effective August 1, 2019, Exchange Access Frame Relay Service (XAFRS) will no longer be available to new Customers. Existing term plan Customers, as of August 1, 2019, may add, move, remove or change lines and/or locations for the duration of their current term plan agreements, but may not enter into any new term plan agreements. Upon expiration of any term plan agreement, service will continue on a month-to-month basis until the service is discontinued by the Telephone Company.

(N)

## E21. FAST PACKET ACCESS SERVICE

### E21.1 Exchange Access Frame Relay Service (XAFRS) (a.k.a. BellSouth Exchange Access Frame Relay Service)<sup>1</sup> (Cont'd)

(C)

#### E21.1.2 Rate Categories (Cont'd)

A. The following rate categories apply to XAFRS (a.k.a. BellSouth Exchange Access Frame Relay service): (Cont'd)

3. Feature Change Charge

In addition to any specific Optional Feature charges, a Feature Change Charge applies whenever a change is made (at the customer's request) to a single optional feature within a single network configuration on a single switch. Although multiple changes may be caused by such actions, only one Feature Change Charge will apply.

4. Transfer of Service

When a change to the customer of record is requested, transfer of service charges, as set forth in E21.1.6.C. following will apply. Charges are applied on a Billing Account Number (BAN).

Administrative changes, as identified following, will be made without charge(s) to the customer. Such changes require the continued provision and billing of the Access Service to the same entity. (i.e., customer remains responsible for all outstanding indebtedness for Access Service). Administrative changes are as follows:

- a. Change of customer name (i.e., the customer of record does not change but rather the customer of record changes its name — e.g., AT&T-Long Lines to AT&T-Communications),
- b. Change of customer or customer's end user premises address when the change of address is not a result of physical relocation of equipment,
- c. Change in billing data (name, address, or contract name or telephone number. The customer of record does not change),
- d. Change of customer circuit identification,
- e. Change of billing account number,
- f. Change of customer test line number,
- g. Change of customer or customer's end user contact name or telephone number, and
- h. Change of jurisdiction.

All other service arrangements, including physical changes to existing services, will be charged as follows:

If the change involves the addition of an optional feature which has a separate nonrecurring charge, that nonrecurring charge will apply.

**Note 1:** Effective August 1, 2019, Exchange Access Frame Relay Service (XAFRS) will no longer be available to new Customers. Existing term plan Customers, as of August 1, 2019, may add, move, remove or change lines and/or locations for the duration of their current term plan agreements, but may not enter into any new term plan agreements. Upon expiration of any term plan agreement, service will continue on a month-to-month basis until the service is discontinued by the Telephone Company.

(N)

## E21. FAST PACKET ACCESS SERVICE

### E21.1 Exchange Access Frame Relay Service (XAFRS) (a.k.a.. BellSouth Exchange Access Frame Relay Service)<sup>1</sup> (Cont'd)

(C)

#### E21.1.3 Acceptance Testing

At no additional charge, and at the customer's request, the Company will cooperatively test at the time of installation.

#### E21.1.4 Ordering Options and Conditions

The Access Order, as set forth in Section E5. preceding, is used in the provisioning of Exchange Access Frame Relay Service (XAFRS) (a.k.a. BellSouth Exchange Access Frame Relay service). Also included in that section are other charges which may be associated with ordering XAFRS (a.k.a. BellSouth Exchange Access Frame Relay service) (e.g., Service Date Change Charges, Cancellation Charges, etc.).

#### E21.1.5 Rate Regulations

- A. Rates and charges are specified in E21.1.6 following for XAFRS (a.k.a. BellSouth Exchange Access Frame Relay service). XAFRS (a.k.a. BellSouth Exchange Access Frame Relay service) is available under the Fast Packet Services Payment Plan (SPP) as specified in E2.4.9(B) preceding.
- B. Minimum Period of Service  
The minimum period is one month.
- C. Installation of Service  
Nonrecurring charges apply to each UNI or NNI on each XAFRS (a.k.a. BellSouth Exchange Access Frame Relay service) installed.  
Nonrecurring charges for the Network Interface elements are set forth in E21.1.6.A. following.
- D. Installation of Optional Features  
Nonrecurring charges apply to the installation of optional features as set forth in E21.1.6.B. following.
- E. Service Rearrangements  
Service rearrangements are changes to existing (installed) services which do not result in a change in the minimum period requirements as set forth in B. preceding. Changes which result in the establishment of new minimum period obligations are treated as disconnects and starts. A change which results from a transfer of service is described and charged as set forth in F. and E21.1.6.C. following.

**Note 1:** Effective August 1, 2019, Exchange Access Frame Relay Service (XAFRS) will no longer be available to new Customers. Existing term plan Customers, as of August 1, 2019, may add, move, remove or change lines and/or locations for the duration of their current term plan agreements, but may not enter into any new term plan agreements. Upon expiration of any term plan agreement, service will continue on a month-to-month basis until the service is discontinued by the Telephone Company.

(N)



## E21. FAST PACKET ACCESS SERVICE

### E21.1 Exchange Access Frame Relay Service (XAFRS) (a.k.a. BellSouth Exchange Access Frame Relay Service)<sup>1</sup> (Cont'd)

(C)

#### E21.1.5 Rate Regulations (Cont'd)

F. Transfer of Service

When a change in billing data (e.g., name, address, contract name, or telephone number) is requested in association with a change in the customer's record, transfer of service charges, as set forth in E21.1.6.C. following will apply. Charges are applied on a Billing Account Number (BAN).

G. Maintenance

In order to maintain the quality of XAFRS (a.k.a. BellSouth Exchange Access Frame Relay service), the Company reserves the right to perform preventive maintenance and software updates to the network. This could result in XAFRS (a.k.a. BellSouth Exchange Access Frame Relay service) being unavailable during the time period between 2:00 A.M. and 4:00 A.M. Eastern Time on any given Wednesday or Sunday morning. However, the Company only expects to utilize this maintenance window for any given switch on the average of once a quarter. In addition, the Company will make every reasonable effort to provide advance notice to those customers likely to be severely affected by such maintenance work. This maintenance window may be adjusted by the Company upon written notice to the customer.

**Note 1:** Effective August 1, 2019, Exchange Access Frame Relay Service (XAFRS) will no longer be available to new Customers. Existing term plan Customers, as of August 1, 2019, may add, move, remove or change lines and/or locations for the duration of their current term plan agreements, but may not enter into any new term plan agreements. Upon expiration of any term plan agreement, service will continue on a month-to-month basis until the service is discontinued by the Telephone Company.

(N)

## E21. FAST PACKET ACCESS SERVICE

### E21.1 Exchange Access Frame Relay Service (XAFRS) (a.k.a. BellSouth Exchange Access Frame Relay Service)<sup>1</sup> (Cont'd)

#### E21.1.5 Rate Regulations (Cont'd)

##### H. Service Level Agreements

Service Level Agreements (SLAs) provide the Company's service level commitments for specific aspects of its Frame Relay network's performance. SLAs are only provided for customers with at least ten Frame Relay UNIs and or NNIs. Such customers must also subscribe to Network Visibility Service (specifically NVS Fault Management, On Demand Statistics and Performance Reports) which is the primary monitoring and reporting tool used for determining performance results and missed commitments.

SLA commitments only apply for service wholly within Company territory; SLA commitments will not apply for service which is part of a jointly provided service.

1. SLA commitments are provided for Network Availability, Network Transit Delay and Frame Delivery Rate.
2. SLA credits are provided for missed commitments, except as specified otherwise in 3. and 4. following. An SLA report is provided through the NVS system that provides details of missed commitments upon which credits will be issued; the SLA report is available on a calendar month basis. Credits are automatically issued based upon the end-of-month SLA report; such credits shall only be issued once a month. The Company's calculation of its performance through the NVS system shall be the sole determinate of the Company's obligation to provide a credit for a missed performance commitment as set forth in this tariff.
3. SLA credits for missed commitments do not apply when any commitment is not met because the Company does not have control over the circumstances causing the commitment to be missed. Situations over which the Company does not have control can be defined as, but not limited to the following:
  - a. any act, any omission or negligence on the part of the customer, any other customer or any third party, or of any other entity providing a portion of the service,
  - b. labor difficulties, governmental orders, civil commotions, acts of civil or military authority, embargoes, epidemics, declared National Emergencies, criminal actions against the Company, war, terrorist acts, riots, insurrections, fires, explosions, nuclear accidents, power blackouts, acts of God (including, but not limited to, earthquakes, floods or unusually severe weather conditions) or other circumstances beyond the Company's control,
  - c. the customer's premises equipment,
  - d. unavailability of the customer's facilities and/or equipment, and
  - e. customer oversubscription of the UNI/NNI beyond 200% (i.e., the sum of the total CIR of all PVCs carried by any UNI or NNI may not be greater than 200% of the UNI/NNI Network Interface speed).
4. SLA credits for missed commitments do not apply for situations when the customer's service is out of operation as a result of scheduled maintenance windows as set forth in E21.1.5.G. preceding. Time from such maintenance activity does not count towards the time a service is considered as unavailable during a calendar month for purposes of measuring for the Network Availability SLA.
5. SLA Commitments

SLA commitments for the specific aspects of the Frame Relay network's performance set forth in 1. preceding are measured on a specific calendar month basis. The specific network performance commitments provided and how their performance is measured through the NVS system for a calendar month are as follows:

Network Availability Commitment: 99.9%

The Network Availability commitment is provided on the customer's total Frame Relay network. Network Availability will measure the percentage of time during a calendar month that the customer's Frame Relay network is available.

Network availability will be measured through the NVS system for the customer's total Frame Relay network and for each individual Frame Relay UNI/NNI for a whole calendar month.

For the purpose of measuring Network Availability, times during which a Frame Relay UNI/NNI is out of operation in association with maintenance windows (as set forth in E21.1.5.G. preceding) and in association with situations over which the Company does not have control (as set forth in E21.1.5.H.3. preceding) are counted as "available" time.

**Note 1:** Effective August 1, 2019, Exchange Access Frame Relay Service (XAFRS) will no longer be available to new Customers. Existing term plan Customers, as of August 1, 2019, may add, move, remove or change lines and/or locations for the duration of their current term plan agreements, but may not enter into any new term plan agreements. Upon expiration of any term plan agreement, service will continue on a month-to-month basis until the service is discontinued by the Telephone Company.

## E21. FAST PACKET ACCESS SERVICE

### E21.1 Exchange Access Frame Relay Service (XAFRS) (a.k.a. BellSouth Exchange Access Frame Relay Service)<sup>1</sup> (Cont'd)

#### E21.1.5 Rate Regulations (Cont'd)

##### H. Service Level Agreements (Cont'd)

##### 5. SLA Commitments (Cont'd)

SLA commitments for the specific aspects of the Frame Relay network's performance set forth in 1. preceding are measured on a specific calendar month basis. The specific network performance commitments provided and how their performance is measured through the NVS system for a calendar month are as follows: (Cont'd)

Network Availability Commitment: 99.9% (Cont'd)

**Total Frame Relay Network - Network Availability:** Network Availability for the customer's total network is calculated by subtracting the total unavailable time for all the Frame Relay UNI/NNIs in a specific total calendar month, from the total available time for all the Frame Relay UNI/NNIs in that specific total calendar month, and then dividing the difference by the total available time for all the Frame Relay UNI/NNIs in that specific total calendar month. If the resulting percentage is less than 99.9%, the commitment for Network Availability has been missed; the Network Availability SLA Credit will then be issued on any Frame Relay UNI/NNI whose specific individual Network Availability measurement is below 99.9%.

**Individual Frame Relay UNI/NNI - Network Availability:** Network Availability for an individual Frame Relay UNI/NNI is calculated by first subtracting the unavailable time from the total available time for a specific calendar month, and then dividing it by the total available time for that specific calendar month. If the Network Availability SLA commitment was missed on the customer's total network and the resulting percentage for a specific individual Frame Relay UNI/NNI is less than 99.9%, the Network Availability SLA Credit set forth in E21.1.5.H.6. following will then be issued on that specific individual Frame Relay UNI/NNI.

Network Transit Delay commitment: 60 milliseconds, one-way

The Network Transit Delay commitment is provided for each individual PVC within the customer's Frame Relay network.

Through the NVS System, Network Transit Delay will measure the average one-way transit time of a specific PVC's frames through the network within a specific calendar month. The transit time for each frame transmitted is measured from the originating Frame Relay UNI/NNI to the terminating Frame Relay UNI/NNI. The measurement for the Network Transit Delay commitment is the average transit time of a frame for a PVC, based upon all the frames transmitted for that PVC during that specific calendar month.

The average monthly Network Transit Delay for a PVC will be determined by dividing the sum of the actual transit time of each frame sent via the PVC that month by the total frames transmitted in that specific calendar month. If the resulting average transit time per frame for that PVC is greater than 60 milliseconds (one-way), the commitment has been missed for that PVC and the Network Transit Delay SLA Credit set forth in E21.1.5.H.6. following will then be issued on this Frame Relay PVC.

Frame Delivery Rate Commitment: 99.9%

The Frame Delivery Rate commitment is provided for each Frame Relay PVC that has a CIR of greater than 32 Kbps.

Through the NVS System, Frame Delivery Rate will measure the percentage of frames successfully delivered for a PVC. The Frame Delivery Rate measures the quantity of frames transmitted versus quantity of frames received during a specific calendar month between the two Frame Relay UNI/NNI's forming the PVC (i.e., the difference in frames transmitted versus received are considered "dropped").

The monthly Frame Delivery Rate for a qualifying PVC in a specific calendar month is determined by subtracting the total frames dropped from the total frames transmitted, divided by the total frames transmitted. If the resulting percentage representing the percent of frames delivered for that PVC is less than 99.9%, this commitment has been missed and the Frame Delivery Rate SLA Credit set forth in E21.1.5.H.6. following will then be issued on this Frame Relay PVC.

**Note 1:** Effective August 1, 2019, Exchange Access Frame Relay Service (XAFRS) will no longer be available to new Customers. Existing term plan Customers, as of August 1, 2019, may add, move, remove or change lines and/or locations for the duration of their current term plan agreements, but may not enter into any new term plan agreements. Upon expiration of any term plan agreement, service will continue on a month-to-month basis until the service is discontinued by the Telephone Company.

(C)

(N)

**E21. FAST PACKET ACCESS SERVICE**

**E21.1 Exchange Access Frame Relay Service (XAFRS) (a.k.a. BellSouth Exchange Access Frame Relay Service)<sup>1</sup> (Cont'd)**

(C)

**E21.1.5 Rate Regulations (Cont'd)**

**H. Service Level Agreements (Cont'd)**

**6. Credits for Missed SLA Commitments**

The following credits are provided for SLA performance commitments missed during a calendar month subject to the conditions outlined herein E21.1.5.H.

Total SLA credits issued for an individual Frame Relay UNI/NNI in a specific calendar month cannot exceed the total monthly recurring charges billed for that Frame Relay UNI/NNI (i.e., cannot exceed the sum of the monthly billing for the XAFRS Network Interface rate element plus any rate elements for features).

**Network Availability SLA Credit:**

This credit is appropriate when the Network Availability commitment for the customer's total network is missed; this credit is then applied per individual Frame Relay UNI/NNI that does not specifically meet the Network Availability commitment.

For each individual Frame Relay UNI/NNI not meeting this commitment for a specific calendar month, a credit equal to 1/30 of its monthly recurring charge for the XAFRS Network Interface rate element will be issued.

**Network Transit Delay SLA Credit:**

This credit is applied per individual Frame Relay PVC (i.e., a DLCI pair forming the PVC) that does not meet the Network Transit Delay commitment.

For each PVC not meeting this commitment for a specific calendar month, a credit equal to \$3.00 for the affected DLCI pair will be issued.

**Frame Delivery Rate SLA Credit:**

This credit is applied per individual Frame Relay PVC (i.e., a DLCI pair forming the PVC) that does not meet the Frame Delivery Rate commitment.

For each PVC not meeting this commitment for a specific calendar month, credits for the affected DLCI pair will be issued as follows:

. Recurring Charge Credit Per DLCI pair:	\$ 3.00
. Recurring CIR Credit per DLCI pair:	
0 Bps CIR	\$ 0.00
> 0 - 32 Kbps CIR	6.30
> 32 - 56 Kbps CIR	10.80
> 56 - 64 Kbps CIR	11.70
> 64 - 128 Kbps CIR	16.20
> 128 - 256 Kbps CIR	21.60
> 256 - 384 Kbps CIR	25.20
> 384 - 512 Kbps CIR	28.80
> 512 - 768 Kbps CIR	32.40
> 768 Kbps - 1.536 Mbps CIR	41.25
> 1.536 - 4 Mbps CIR	130.00
> 4 - 10 Mbps CIR	325.00
> 10 - 16 Mbps CIR	525.00
> 16 - 34 Mbps CIR	1,100.00
> 34 - 44.210 Mbps CIR	1,500.00

**Note 1:** Effective August 1, 2019, Exchange Access Frame Relay Service (XAFRS) will no longer be available to new Customers. Existing term plan Customers, as of August 1, 2019, may add, move, remove or change lines and/or locations for the duration of their current term plan agreements, but may not enter into any new term plan agreements. Upon expiration of any term plan agreement, service will continue on a month-to-month basis until the service is discontinued by the Telephone Company.

(N)

**E21. FAST PACKET ACCESS SERVICE**

**E21.1 Exchange Access Frame Relay Service (XAFRS) (a.k.a. BellSouth Exchange Access Frame Relay Service)<sup>5</sup> (Cont'd)**

(C)

**E21.1.6 Rates and Charges**

**A. Network Interface**

1. Per UNI

		Nonrecurring Charge	Month To Month	A 12 to 24 Mos. Plan	B 25 to 48 Mos. Plan	USOC
(a)	56 Kbps	\$300.00	\$62.00	\$49.00	\$44.00	XAFU5
(b)	64 Kbps	300.00	70.00	56.00	50.00	XAFU6
(c)	1.536 Mbps	410.00	441.00	351.00	210.00	XAFU1
(d)	44.210 Mbps	1,050.00	3,639.00	2,880.00	1,795.00	XAFU4
2. Per NNI						
(a)	56 Kbps	300.00	62.00	49.00	44.00	XAFN5
(b)	64 Kbps	300.00	70.00	56.00	50.00	XAFN6
(c)	1.536 Mbps	410.00	441.00	351.00	210.00	XAFN1
(d)	44.210 Mbps	1,050.00	3,639.00	2,880.00	1,795.00	XAFN4

**B. Optional Features**

1. DLCI<sup>1</sup>

		Nonrecurring Charge	Monthly Rate	USOC
(a)	Initial Standard DLCI <sup>2</sup>	\$-	\$-	XAFD1
(b)	Additional Standard DLCI	70.00	1.50	XAFD2
(c)	Initial Priority DLCI <sup>2,3</sup>	-	5.00	XAFP1
(d)	Additional Priority DLCI <sup>3</sup>	70.00	5.00	XAFP2

2. Committed Information Rate (CIR) (Per DLCI) cannot exceed the minimum transmission speed of the XAFRS Network Interface at either end of the PVC.<sup>4</sup>

(a)	0 Bps	-	-	XAFCA
(b)	1 thru 32 Kbps	-	6.30	XAFCB
(c)	33 thru 56 Kbps	-	10.80	XAFCC

**Note 1:** These DLCI charges are not applicable for configurable DLCIs provided as part of a Configurable DLCI Bundle associated with Customer Configuration Management Capability.

**Note 2:** One "Initial" DLCI is applicable when DLCIs are ordered at the same time as the installation of the Network Interface. Only one Initial DLCI (either one Initial Standard DLCI or one Initial Priority DLCI) is allowed per Network Interface. All other DLCI are considered Additional DLCIs.

**Note 3:** A Priority DLCI must have CIR with a value greater than 0.

**Note 4:** These CIR Charges are not applicable for configurable DLCIs provided within a Configurable DLCI Bundle (which include CIR of up to 64 Kbps per configurable DLCI) associated with Customer Configuration Management Capability.

**Note 5:** Effective August 1, 2019, Exchange Access Frame Relay Service (XAFRS) will no longer be available to new Customers. Existing term plan Customers, as of August 1, 2019, may add, move, remove or change lines and/or locations for the duration of their current term plan agreements, but may not enter into any new term plan agreements. Upon expiration of any term plan agreement, service will continue on a month-to-month basis until the service is discontinued by the Telephone Company.

(N)

**E21. FAST PACKET ACCESS SERVICE**

**E21.1 Exchange Access Frame Relay Service (XAFRS) (a.k.a. BellSouth Exchange Access Frame Relay Service)<sup>2</sup> (Cont'd)**

(C)

**E21.1.6 Rates and Charges (Cont'd)**

**B. Optional Features (Cont'd)**

**2. (Cont'd)<sup>1</sup>**

	Nonrecurring Charges	Monthly Rate	USOC
(d) 57 thru 64 Kbps	\$-	\$11.70	XAFCD
(e) 65 thru 128 Kbps	-	16.20	XAFCG
(f) 129 thru 256 Kbps	-	21.60	XAFCH
(g) 257 thru 384 Kbps	-	25.20	XAFCH
(h) 385 thru 512 Kbps	-	28.80	XAFCK
(i) 513 thru 768 Kbps	-	32.40	XAFCL
(j) 769 Kbps thru 1.536 Mbps	-	41.25	XAFCM
(k) 1.537 thru 4 Mbps	-	130.00	XAFCP
(l) 5 thru 10 Mbps	-	325.00	XAFDQ
(m) 11 thru 16 Mbps	-	525.00	XAFCR
(n) 17 thru 34 Mbps	-	1,100.00	XAFCT
(o) 35 thru 44.210 Mbps	-	1,500.00	XAFCU

3. Customer Configuration Management Capability - Rate elements following for Customer Configuration Management Capability are applicable for DLCIs and CIR associated with configurable PVCs provisioned by the customer; these rates and charges apply in lieu of those preceding for DLCI and CIR rate elements applicable for standard PVCs provisioned by the Company.

(a) Configurable DLCI Bundles - Each bundle provides the specified quantity of configurable DLCIs, with up to 64 Kbps CIR per DLCI. Multiple bundles may be selected to secure the total quantity, or block, of configurable DLCIs for an XAFRS Network Interface.

	Monthly Rate	USOC
- 2 DLCI Bundle	\$16.50	XAFKA
- 5 DLCI Bundle	41.00	XAFKB
- 15 DLCI Bundle	121.00	XAFKC
- 25 DLCI Bundle	197.00	XAFKD
- 35 DLCI Bundle	270.00	XAFKE
- 50 DLCI Bundle	373.00	XAFKF
- 100 DLCI Bundle	664.00	XAFKG
- 200 DLCI Bundle	1,162.00	XAFKH
- 300 DLCI Bundle	1,494.00	XAFKJ
- 400 DLCI Bundle	1,660.00	XAFKK

(b) Configurable DLCI Block Establishment/Change Charge - This nonrecurring charge is applicable to initially establish the block of configurable DLCIs for an XAFRS Network Interface. This charge is also applicable per subsequent request to change the size of the block of configurable DLCIs. Only one such nonrecurring charge applies per request regardless of how many Configurable DLCI Bundles are requested to initially establish the block or are requested subsequently to be added or deleted.

- Per Request 45.00 XAFKY

(c) DLCI Conversion Charge - This nonrecurring charge is applicable per standard DLCI requested to be converted to a configurable DLCI and per configurable DLCI requested to be converted to a standard DLCI.

- Per DLCI 16.00 XAFKZ

**Note 1:** These CIR Charges are not applicable for configurable DLCIs provided within a Configurable DLCI Bundle (which include CIR of up to 64 Kbps per configurable DLCI) associated with Customer Configuration Management Capability.

**Note 2:** Effective August 1, 2019, Exchange Access Frame Relay Service (XAFRS) will no longer be available to new Customers. Existing term plan Customers, as of August 1, 2019, may add, move, remove or change lines and/or locations for the duration of their current term plan agreements, but may not enter into any new term plan agreements. Upon expiration of any term plan agreement, service will continue on a month-to-month basis until the service is discontinued by the Telephone Company.

(N)

**E21. FAST PACKET ACCESS SERVICE**

**E21.1 Exchange Access Frame Relay Service (XAFRS) (a.k.a. BellSouth Exchange Access Frame Relay Service)<sup>1</sup> (Cont'd)**

(C)

**E21.1.6 Rates and Charges (Cont'd)**

**C. Service Modification**

**1. Feature Change Charge**

	Nonrecurring Charges	Monthly Rate	USOC
(a) Per Occurrence, Per Feature	\$50.00	-	XAFFC
<b>2. Transfer of Service</b>			
(a) Per Billing Account Number	65.00	-	XAFTF

**E21.2 (DELETED)**

**Note 1:** Effective August 1, 2019, Exchange Access Frame Relay Service (XAFRS) will no longer be available to new Customers. Existing term plan Customers, as of August 1, 2019, may add, move, remove or change lines and/or locations for the duration of their current term plan agreements, but may not enter into any new term plan agreements. Upon expiration of any term plan agreement, service will continue on a month-to-month basis until the service is discontinued by the Telephone Company.

(N)

BELLSOUTH  
TELECOMMUNICATIONS, INC.  
FLORIDA  
ISSUED: March 21, 2000 - -  
BY: Joseph P. Lacher, President -FL  
Miami, Florida

ACCESS SERVICES TARIFF

Third Revised Page 8  
Cancels Second Revised Page 8

EFFECTIVE: **APR 05 2000**

**E21. FAST PACKET ACCESS SERVICE**

**E21.2 (DELETED) (Cont'd)**

(D)



BELLSOUTH  
TELECOMMUNICATIONS, INC.  
FLORIDA  
ISSUED: March 21, 2000 - -  
BY: Joseph P. Lacher, President -FL  
Miami, Florida

ACCESS SERVICES TARIFF

Second Revised Page 9  
Cancels First Revised Page 9

EFFECTIVE:

**APR 05 2000**

**E21. FAST PACKET ACCESS SERVICE**

**E21.2 (DELETED) (Cont'd)**

(D)

BELLSOUTH  
TELECOMMUNICATIONS, INC.  
FLORIDA

ACCESS SERVICES TARIFF

Fourth Revised Page 10  
Cancels Third Revised Page 10

ISSUED: March 21, 2000  
BY: Joseph P. Lacher, President -FL  
Miami, Florida

EFFECTIVE: **APR 05 2000**

**E21. FAST PACKET ACCESS SERVICE**

**E21.2 (DELETED) (Cont'd)**

(D)

BELLSOUTH  
TELECOMMUNICATIONS, INC.  
FLORIDA  
ISSUED: March 21, 2000 - -  
BY: Joseph P. Lacher, President -FL  
Miami, Florida

ACCESS SERVICES TARIFF

Third Revised Page 11  
Cancels Second Revised Page 11

EFFECTIVE: **APR 05 2000**

**E21. FAST PACKET ACCESS SERVICE**

**E21.2 (DELETED) (Cont'd)**

(D)

## E21. FAST PACKET ACCESS SERVICE

### E21.3 BellSouth Exchange Access Asynchronous Transfer Mode Service (XAATMS)<sup>1</sup>

(C)

#### E21.3.1 Service Description

- A. BellSouth Exchange Access Asynchronous Transfer Mode (ATM) Service (XAATMS) is a connection-oriented data service based on ATM cell-based switching technology. BellSouth XAATMS allows for the interconnection of ATM compatible customer equipment by providing efficient throughput at high speeds of transmission. BellSouth XAATMS provides the switching of symmetrical duplex transmissions of fixed-length ATM cells (herein referred to as ATM cells).

A user network interface (UNI) is available with BellSouth XAATMS. The UNI is a standard interface used to connect the customer to the BellSouth XAATMS switch. It receives the ATM cells into the ATM switch and verifies that the addressing and traffic parameters are valid (according to BellSouth XAATMS technical specifications as referenced in B. following) before relaying the ATM cells to the specified destination. The UNI is offered at transmission speeds of 1.536 Mbps, 44.210 Mbps, 149.760 Mbps and 599.040 Mbps.

The rate structure for BellSouth XAATMS is comprised of a Network Interface rate element by transmission speed and rate elements for PVC Features (representing ATM traffic). Connection to BellSouth XAATMS network interfaces is accomplished through dedicated access. For intrastate dedicated access, rates, charges, and regulations for Special Access (a.k.a. BellSouth SPA) Services are specified in Section E7 preceding. Only non-channelized bandwidth may terminate on a BellSouth XAATMS network interface.

As BellSouth XAATMS is a connection oriented service, to transfer information a virtual connection must be set up between two network interfaces on a BellSouth XAATMS switch. BellSouth XAATMS supports ATM traffic via permanent virtual connections (PVCs). PVCs are bi-directional virtual channels that are established via the service provisioning process.

For BellSouth XAATMS, the logical path between a customer's premises and a network interface on the BellSouth XAATMS switch is referred to as an ATM PVC segment. The mapping together of two ATM PVC segments through the BellSouth XAATMS switch creates an ATM PVC. This ATM PVC is a logical channel representing the path from one premises associated with a BellSouth XAATMS network interface, through the BellSouth XAATMS switch, to a premises associated with a different network interface on the BellSouth XAATMS switch.

The following provides additional information on the terms used to describe the attributes of BellSouth XAATMS with respect to the PVC Feature Charges which apply for ATM PVC traffic. Information is provided regarding ATM PVC segment, ATM PVC service categories, ATM PVC traffic parameters, and ATM PVC segment bandwidth.

1. ATM PVC Segment

For BellSouth XAATMS, the ATM PVC segment defines the logical path between a customer's premises and the network interface on the BellSouth XAATMS switch. An ATM PVC segment must be provisioned by the Company via service order activity and remain in place until requested to be removed by the customer. For BellSouth XAATMS, two ATM PVC segments are mapped together through the BellSouth XAATMS switch to create an ATM PVC representing a virtual channel through the BellSouth XAATMS network.

2. ATM PVC Service Categories

ATM PVC service categories are established to support the service requirements of various categories of customer applications for ATM PVCs. Four ATM PVC service categories are available. The customer must specify the desired service category for each ATM PVC that is ordered. BellSouth XAATMS supports the following types of ATM PVC service categories:

- a. Constant Bit Rate (CBR): CBR allows for applications where an ATM PVC requires special network timing requirements (i.e., strict PVC cell loss, cell delay and cell delay variation performance). For example, a CBR ATM PVC would be utilized for applications requiring circuit emulation (i.e., a continuously operating logical channel) over BellSouth XAATMS at transmission speeds comparable to DS1 and DS3. Such applications would include private line like service or voice type service where delays in transmission cannot be tolerated. The customer specifies the bandwidth required for each CBR ATM PVC when it is ordered.
- b. Variable Bit Rate - Real Time (VBR-RT): VBR-RT allows for applications where an ATM PVC requires low cell delay variation. For example, VBR-RT would be utilized for applications such as variable bit rate video compression and packet voice and video, which are somewhat tolerant of delay. The customer specifies the bandwidth required for each VBR-RT ATM PVC when it is ordered.
- c. Variable Bit Rate - Non-Real Time (VBR-NRT): VBR-NRT allows for an ATM PVC that can tolerate larger cell delay variations than VBR-RT. For example, VBR-NRT would be utilized for applications such as data file transfers. The customer specifies the bandwidth required for each VBR-NRT ATM PVC when it is ordered.

**Note 1:** Effective August 1, 2019, BellSouth Exchange Access Asynchronous Transfer Mode Service (XAATMS) will no longer be available to new Customers. Existing term plan Customers, as of August 1, 2019, may add, move, remove or change lines and/or locations for the duration of their current term plan agreements, but may not enter into any new term plan agreements. Upon expiration of any term plan agreement, service will continue on a month-to-month basis until the service is discontinued by the Telephone Company.

(N)

## E21. FAST PACKET ACCESS SERVICE

### E21.3 BellSouth Exchange Access Asynchronous Transfer Mode Service (XAATMS)<sup>2</sup> (Cont'd)

#### E21.3.1 Service Description (Cont'd)

##### A. (Cont'd)

##### 2. PVC Service Categories (Cont'd)

- d. Unspecified Bit Rate (UBR): UBR allows for an ATM PVC where the user does not require one of the ATM PVC service categories described in (a) through (c) preceding. For example, UBR would be utilized where the customer seeks a low cost method of transporting bursty data for non-critical applications that can tolerate delay variations. The Company will attempt to deliver all ATM cells received via UBR ATM PVCs; however, network congestion may result in loss of ATM cells.

##### 3. ATM PVC Traffic Parameters

In accordance with the technical specifications for BellSouth XAATMS set forth in the technical publications referenced herein E21.3.1.B., each non-UBR type ATM PVC has a set of traffic parameters to describe the characteristics of the information being transmitted. Fixed values for these traffic parameters are derived from the ATM PVC bandwidth specified by the customer for each ATM PVC. These parameters are:

- a. Peak Cell Rate (PCR): The PCR, in cells per second, is an upper bound on the source traffic that can be submitted on a BellSouth XAATMS network interface. PCR is a traffic parameter considered for both CBR and VBR service categories.

PCR is the only traffic parameter considered for a CBR ATM PVC; the equivalent bandwidth per CBR ATM PVC equals the PCR, in cells per second, times 0.000424.

PCR is one of three traffic parameters considered for a VBR ATM PVC. For a VBR-RT PVC, PCR is 200 percent of the SCR described following. For VBR-NRT, PCR is 400 percent of the SCR described following.

- b. Sustainable Cell Rate (SCR): The SCR, in cells per second, is an upper bound on the conforming average cell rate of a BellSouth XAATMS network interface over time.

SCR is a traffic parameter considered only for a VBR ATM PVC. The equivalent bandwidth per VBR-RT ATM PVC is equal to the SCR, in cells per second, times 0.000512. The bandwidth per VBR-NRT ATM PVC is equal to the SCR, in cells per second, times 0.000804.

- c. Maximum Burst Size (MBS): MBS is the maximum number of consecutive cells that may be transmitted at the peak cell rate.

MBS is a traffic parameter considered only for a VBR ATM PVC. For a VBR-RT ATM PVC, the MBS is fixed at 32 cells. For a VBR-NRT ATM PVC, the MBS is fixed at 100 cells.

##### 4. ATM PVC Segment Bandwidth

An ATM PVC Segment Bandwidth Charge is applicable for each CBR or VBR ATM PVC segment. Such non-UBR ATM PVC equivalent bandwidth represents the BellSouth XAATMS network resources based on the ATM PVC's traffic parameters. The ATM PVC Segment Bandwidth Charge is derived by multiplying the ATM PVC segment's equivalent bandwidth (calculation following) by the appropriate ATM PVC Segment Bandwidth Charge (expressed in megabits or increments of 64 Kbps as described following).

The following calculations are applicable for determining non-UBR ATM PVC segment bandwidth based upon the ATM PVC category of service.

- a. CBR equivalent bandwidth is equal to the PCR (cells per second) times 0.000424. PCR is equal to increments of 64 Kbps of equivalent bandwidth times 150.943, or megabits of equivalent bandwidth times 2358.491.
- b. VBR-RT equivalent bandwidth is equal to the SCR (cells per second) times 0.000512. For VBR-RT service, the PCR is fixed at 200 percent of the SCR and the MBS is fixed at 32 cells. SCR is equal to increments of 64 Kbps of equivalent bandwidth times 125.000, or megabits of equivalent bandwidth times 1953.125.
- c. VBR-NRT equivalent bandwidth is equal to the SCR (cells per second) times 0.000804. For VBR-NRT service, the PCR is fixed at 400 percent of the SCR (unless specified otherwise by the customer<sup>1</sup>) and the MBS is fixed at 100 cells. SCR is equal to increments of 64 Kbps of equivalent bandwidth times 79.602, or megabits of equivalent bandwidth times 1243.781.

Note 1: VBR-NRT equivalent bandwidth, where the PCR to SCR ratio is specified by the customer, is determined using the formula in Section 1.3.4 of BellSouth Technical Reference 73585.

Note 2: Effective August 1, 2019, BellSouth Exchange Access Asynchronous Transfer Mode Service (XAATMS) will no longer be available to new Customers. Existing term plan Customers, as of August 1, 2019, may add, move, remove or change lines and/or locations for the duration of their current term plan agreements, but may not enter into any new term plan agreements. Upon expiration of any term plan agreement, service will continue on a month-to-month basis until the service is discontinued by the Telephone Company.

All AT&T and BellSouth marks contained herein and as set forth in the trademarks and service marks section of the BellSouth Tariff are owned by AT&T Intellectual Property or AT&T affiliated companies.

**E21. FAST PACKET ACCESS SERVICE**

**E21.3 BELLSOUTH EXCHANGE ACCESS ASYNCHRONOUS TRANSFER MODE SERVICE (XAATMS)<sup>3</sup> (Cont'd)**

(C)

**E21.3.1 Service Description (Cont'd)**

A. (Cont'd)

4. ATM PVC Segment Bandwidth (Cont'd)

Where the result from the ATM PVC segment equivalent bandwidth calculation is greater than 1.536 Mbps, the value is expressed in units of megabits and (if a fraction of a megabit) is rounded up to the next whole megabit. This bandwidth is multiplied by the Per Megabit Bandwidth Charge.

Where the result from the ATM PVC segment equivalent bandwidth calculation is less than or equal to 1.536 Mbps, that number should be divided by .064 Mbps to arrive at a quantity of 64 Kbps increments. If the resulting number is not a whole number, it is rounded up to the next whole number and represents the number of 64 Kbps increments that should be utilized in the derivation of the PVC Segment Bandwidth Charge. This bandwidth is multiplied by the Per Increment of 64 Kbps Bandwidth Charge.

The following table illustrates the ATM PVC segment equivalent bandwidth calculation for each non-UBR type ATM PVC with 1 megabit of bandwidth.

ATM PVC Service Category	Equivalent Bandwidth	Traffic Parameters		
		Peak Cell Rate <sup>1</sup>	Sustainable Cell Rate <sup>1</sup>	Maximum Burst Size <sup>2</sup>
CBR	1 Megabit	2,358	N/A	N/A
VBR-RT	1 Megabit	3,906	1,953	32
VBR-NRT	1 Megabit	4,975	1,244	100

B. Technical Specifications

BellSouth XAATMS services installed after the effective date of this tariff will conform to the service specifications and standards for BellSouth XAATMS service (including the BellSouth XAATMS UNI) set forth in the following references:

- BellSouth Technical Reference 73585, "Asynchronous Transfer Mode (ATM) Network Interface and Performance Specifications". This document is available from BellSouth Telecommunications, Inc., Regional Documentation Coordinator, 20th Floor, 600 North 19th Street, Birmingham, AL 35203.

The specifications set forth in BellSouth TR 73585 are in conformance with the following national standards for ATM services:

- ATM Forum document, "ATM User-Network Interface Specification" (Versions 3.0 and 3.1). This document is available from ATM Forum, 2570 West El Camino Real, Suite 304, Mountain View, California, 94040.

C. Interface Specifications

In accordance with the interface specifications set forth in BellSouth TR 73585, the following is available with BellSouth XAATMS:

- ATM Cell-switched (UNI)

**E21.3.2 Rate Categories**

A. The following rate categories apply to BellSouth XAATMS:

1. Network Interface

This rate category provides for the customer's termination on the BellSouth XAATMS switch. The Network Interface rate category includes the BellSouth XAATMS switching function.

2. PVC Features

The PVC Features rate category provides for the ordering and provisioning of ATM PVCs in association with the BellSouth XAATMS network interface.

Note 1: Cells per second.

Note 2: Cells.

Note 3: Effective August 1, 2019, BellSouth Exchange Access Asynchronous Transfer Mode Service (XAATMS) will no longer be available to new Customers. Existing term plan Customers, as of August 1, 2019, may add, move, remove or change lines and/or locations for the duration of their current term plan agreements, but may not enter into any new term plan agreements. Upon expiration of any term plan agreement, service will continue on a month-to-month basis until the service is discontinued by the Telephone Company.

(N)

## E21. FAST PACKET ACCESS SERVICE

### E21.3 BELLSOUTH EXCHANGE ACCESS ASYNCHRONOUS TRANSFER MODE SERVICE (XAATMS)<sup>1</sup> (Cont'd)

(C)

#### E21.3.2 Rate Categories (Cont'd)

##### A. (Cont'd)

##### 2. PVC Features (Cont'd)

The rates for PVC Features may vary by ATM PVC service category and are listed in E21.3.6.B. by applicable ATM PVC service category.

- a. ATM PVC Segment Charge - An ATM PVC Segment Charge applies for each ATM PVC segment established over a network interface. An ATM PVC Segment Charge applies under all ATM PVC service categories.
- b. ATM PVC Segment Bandwidth Charge - An ATM PVC Segment Bandwidth Charge is required per ATM PVC segment established under the CBR or VBR ATM PVC service category (but is not applicable to UBR ATM PVCs). ATM PVC bandwidth represents BellSouth XAATMS network resources required for the non-UBR ATM PVC and is based on the non-UBR ATM PVC's traffic parameters (i.e., PCR, SCR, and MBS). The total charge for this rate element per segment is determined by multiplying the non-UBR ATM PVC segment bandwidth by the ATM PVC Segment Bandwidth Charge, either Per Megabit or Per Increment of 64 Kbps (as appropriate per E21.3.1.A.4.).
- c. UBR Service Activation Charge - A UBR Service Activation Charge is applicable for each network interface over which UBR PVC(s) will traverse. One charge is applicable per network interface regardless of how many UBR PVCs will traverse that network interface.

##### 3. Feature Change Charge

A Feature Change Charge applies for a customer request to change an existing BellSouth XAATMS PVC Feature from E21.3.6.B. for which there is no nonrecurring charge. (Examples: A Feature Change Charge applies when a customer requests a change in the ATM PVC segment bandwidth required on an existing non-UBR ATM PVC. A Feature Change Charge applies when a customer requests that UBR Service Activation be added to an existing Network Interface which currently is not activated to carry UBR ATM PVCs if the request does not also include an order for a UBR ATM PVC Segment which carries a nonrecurring charge. A customer request to change the service category of an existing CBR ATM PVC to a VBR-RT ATM PVC would not involve a Feature Change Charge but would be treated as a disconnect of the CBR ATM PVC and a new request for a VBR-RT ATM PVC for which there is a nonrecurring charge.)

Only one Feature Change Charge applies per customer request that involves changes to multiple existing ATM PVCs of the same ATM PVC service category that are provisioned out of the same BellSouth XAATMS switch. (For example, one Feature Change Charge would apply per customer request to change the ATM PVC segment bandwidth associated with two existing CBR ATM PVCs provisioned out of the same BellSouth XAATMS switch.)

##### 4. Transfer of Service

When a change to the customer of record is requested, transfer of service charges, as set forth in E21.3.6.D. following will apply. Charges are applied per Billing Account Number (BAN). Administrative changes, as identified below, will be made without charge(s) to the customer. Such changes require the continued provision and billing of the Access Service to the same entity. (i.e., customer remains responsible for all outstanding indebtedness for Access Service). Administrative changes are as follows:

- Change of customer name (i.e., the customer of record does not change but rather the customer of record changes its name -- e.g., AT&T-Long Lines to AT&T-Long Lines to AT&T-Communications),
- Change of customer or customer's end user premises address when the change of address is not a result of physical relocation of equipment,
- Change in billing data (name, address, or contact name or telephone number. The customer of record does not change),
- Change of customer circuit identification,
- Change of billing account number,
- Change of customer test line number,
- Change of customer or customer's end user contact name or telephone number, and
- Change of jurisdiction.

Note 1: Effective August 1, 2019, BellSouth Exchange Access Asynchronous Transfer Mode Service (XAATMS) will no longer be available to new Customers. Existing term plan Customers, as of August 1, 2019, may add, move, remove or change lines and/or locations for the duration of their current term plan agreements, but may not enter into any new term plan agreements. Upon expiration of any term plan agreement, service will continue on a month-to-month basis until the service is discontinued by the Telephone Company.

(N)

## E21. FAST PACKET ACCESS SERVICE

### E21.3 BELLSOUTH EXCHANGE ACCESS ASYNCHRONOUS TRANSFER MODE SERVICE (XAATMS)<sup>1</sup> (Cont'd)

(C)

#### E21.3.2 Rate Categories (Cont'd)

A. (Cont'd)

4. (Cont'd)

All other service arrangements, including physical changes to existing services, will be charged as follows:

-If the change involves the addition of an optional feature which has a separate nonrecurring charge, that nonrecurring charge will apply.

#### E21.3.3 Acceptance Testing

At no additional charge, and at the customer's request, the Telephone Company will cooperatively test with the customer at the time of installation.

#### E21.3.4 Ordering Options and Conditions

The Access Order, as set forth in Section 5 preceding, is used in the provisioning of BellSouth XAATMS. Also included in that Section are other charges which may be associated with ordering BellSouth XAATMS (e.g., Service Date Change Charges, Cancellation Charges, etc.).

#### E21.3.5 Rate Regulations

A. Rates and charges are specified in E21.3.6. following for the ordering and provisioning of BellSouth XAATMS. BellSouth XAATMS is available under the Fast Packet Services Payment Plan (SPP) as specified in E2.4.9.B. preceding.

B. Minimum Period of Service

The minimum period per BellSouth XAATMS rate element selected is one month.

C. Installation of Service

Nonrecurring charges apply to each BellSouth XAATMS UNI installed.

Nonrecurring charges for the Network Interface elements are set forth in E21.3.6.A. following.

D. Installation of Features

Nonrecurring charges apply to each ATM PVC segment by ATM PVC service category as set forth in E21.3.6.B. following.

E. Transfer of Service

When a change in billing data (e.g., name, address, contact name or telephone number) is requested in association with a change in the customer's record, transfer of service charges, as set forth in E21.3.6.D. following will apply. Charges are applied on a per Billing Account Number (BAN).

F. Maintenance

In order to maintain the quality of BellSouth XAATMS, the Company reserves the right to perform preventive maintenance and software updates to the network. This could result in BellSouth XAATMS being unavailable during the time period between 2:00 A.M. and 4:00 A.M. Eastern Time on any given Wednesday or Sunday morning. However, the Company only expects to utilize this maintenance window for any given switch on the average of once a quarter. In addition, the Company will make every reasonable effort to provide advance notice to those customers likely to be affected by such maintenance work. This maintenance window may be adjusted by the Company upon written notice to the customer.

**Note 1:** Effective August 1, 2019, BellSouth Exchange Access Asynchronous Transfer Mode Service (XAATMS) will no longer be available to new Customers. Existing term plan Customers, as of August 1, 2019, may add, move, remove or change lines and/or locations for the duration of their current term plan agreements, but may not enter into any new term plan agreements. Upon expiration of any term plan agreement, service will continue on a month-to-month basis until the service is discontinued by the Telephone Company.

(N)



## E21. FAST PACKET ACCESS SERVICE

### E21.3 BellSouth Exchange Access Asynchronous Transfer Mode Service (XAATMS)<sup>1</sup> (Cont'd) (C)

#### E21.3.5 Rate Regulations (Cont'd)

##### G. Service Level Agreements

Service Level Agreements (SLAs) provide the Company's service level commitments for specific aspects of its ATM network's performance. SLAs are only provided for customers with at least ten ATM UNIs. Such customers must also subscribe to Network Visibility Service (specifically NVS Fault Management, On Demand Statistics and Performance Reports) which is the primary monitoring and reporting tool used for determining performance results and missed commitments.

SLA commitments only apply for service wholly within Company territory; SLA commitments will not apply for service which is part of a jointly provided service.

1. SLA commitments are provided for Network Availability, Cell Delivery Rate and Cell Loss Ratio.
2. SLA credits are provided for missed commitments, except as specified otherwise in 3. and 4. following. An SLA report is provided through the NVS system that provides details of missed commitments upon which credits will be issued; the SLA report is available on a calendar month basis. Credits are automatically issued based upon the end-of-month SLA report; such credits shall only be issued once a month. The Company's calculation of its performance through the NVS system shall be the sole determinate of the Company's obligation to provide a credit for a missed performance commitment as set forth in this tariff.
3. SLA credits for missed commitments do not apply when any commitment is not met because the Company does not have control over the circumstances causing the commitment to be missed. Situations over which the Company does not have control can be defined as, but not limited to the following:
  - a. any act, any omission or negligence on the part of the customer, any other customer or any third party, or of any other entity providing a portion of the service,
  - b. labor difficulties, governmental orders, civil commotions, acts of civil or military authority, embargoes, epidemics, declared National Emergencies, criminal actions against the Company, war, terrorist acts, riots, insurrections, fires, explosions, nuclear accidents, power blackouts, acts of God (including, but not limited to, earthquakes, floods or unusually severe weather conditions) or other circumstances beyond the Company's control,
  - c. the customer's premises equipment,
  - d. unavailability of the customer's facilities and/or equipment, and
  - e. customer oversubscription of the ATM UNI beyond 200%, calculated as the total VBR equivalent bandwidth on all PVCs carried by the ATM UNI (after the CBR bandwidth is subtracted) may not be greater than 200% of the ATM UNI Network Interface speed.
4. SLA credits for missed commitments do not apply for situations when the customer's service is out of operation as a result of scheduled maintenance windows as set forth in E21.3.5.F. preceding. Time from such maintenance activity does not count towards the time a service is considered as unavailable during a calendar month for purposes of measuring for the Network Availability SLA.
5. Service Level Commitments

SLA commitments for the specific aspects of the ATM network's performance set forth in 1. preceding are measured on a specific calendar month basis. The specific network performance commitments provided and how their performance is measured through the NVS system for a calendar month are as follows:

Network Availability Commitment: 99.9%

The Network Availability commitment is provided on the customer's total ATM network. Network Availability will measure the percentage of time during a calendar month that the customer's ATM network is available.

Network availability will be measured through the NVS system for the customer's total ATM network and for each individual ATM UNI for a whole calendar month.

For the purpose of measuring Network Availability, times during which an ATM UNI is out of operation in association with maintenance windows (as set forth in E21.3.5.F. preceding) and in association with situations over which the Company does not have control (as set forth in E21.3.5.G.3. preceding) are counted as "available" time.

**Note 1:** Effective August 1, 2019, BellSouth Exchange Access Asynchronous Transfer Mode Service (XAATMS) will no longer be available to new Customers. Existing term plan Customers, as of August 1, 2019, may add, move, remove or change lines and/or locations for the duration of their current term plan agreements, but may not enter into any new term plan agreements. Upon expiration of any term plan agreement, service will continue on a month-to-month basis until the service is discontinued by the Telephone Company. (N)

## E21. FAST PACKET ACCESS SERVICE

### E21.3 BellSouth Exchange Access Asynchronous Transfer Mode Service (XAATMS)<sup>1</sup> (Cont'd)

#### E21.3.5 Rate Regulations (Cont'd)

##### G. Service Level Agreements (Cont'd)

##### 5. Service Level Commitments (Cont'd)

SLA commitments for the specific aspects of the ATM network's performance set forth in 1. preceding are measured on a specific calendar month basis. The specific network performance commitments provided and how their performance is measured through the NVS system for a calendar month are as follows: (Cont'd)

Network Availability Commitment: 99.9% (Cont'd)

**Total ATM Network - Network Availability:** Network Availability for the customer's total network is calculated by subtracting the total unavailable time for all the ATM UNIs in a specific total calendar month, from the total available time for all the ATM UNIs in that specific total calendar month, and then dividing the difference by the total available time for all the ATM UNIs in that specific total calendar month. If the resulting percentage is less than 99.9%, the commitment for Network Availability has been missed; the Network Availability SLA Credit will then be issued on any ATM UNI whose specific individual Network Availability measurement is below 99.9%.

**Individual ATM UNI - Network Availability:** Network Availability for an individual ATM UNI is calculated by first subtracting the unavailable time from the total available time for a specific calendar month, and then dividing it by the total available time for that specific calendar month. If the Network Availability SLA commitment was missed on the customer's total network and the resulting percentage for a specific individual ATM UNI is less than 99.9%, the Network Availability SLA Credit set forth in E21.3.5.G.6. following will then be issued on that specific individual ATM UNI.

Cell Delivery Rate Commitment: by PVC Category of Service

A Cell Delivery Rate commitment is provided on a per PVC basis for each ATM PVC with one of the following classes of service: CBR, VBR-RT and VBR-NRT. (A Cell Delivery Rate commitment is not provided for ATM PVCs with a UBR class of service).

The specific commitment for Cell Delivery Rate for a PVC with a CBR class of service is 99.99%.

The specific commitment for Cell Delivery Rate for a PVC with a VBR-RT class of service is 99.9%.

The specific commitment for Cell Delivery Rate for a PVC with a VBR-NRT class of service is 99.5%.

Through the NVS System, Cell Delivery Rate will measure the percentage of cells successfully delivered for a CBR or VBR PVC during a specific calendar month. The Cell Delivery Rate measures the quantity of cells received versus quantity of cells transmitted during a specific calendar month between the two ATM UNIs forming the PVC (i.e., the difference in cells transmitted versus received are considered "lost").

The monthly Cell Delivery Rate for a qualifying PVC in a specific calendar month is determined by subtracting the total cells lost from the total cells transmitted, divided by the total cells transmitted. If the resulting percentage representing the percent of cells delivered for that PVC is less than the specific commitment for that PVC class of service, this commitment has been missed and the Cell Delivery Rate SLA Credit set forth in E21.3.5.G.6. following will then be issued on this ATM PVC.

Cell Loss Ratio Commitment: 1%

A Cell Loss Ratio commitment is provided on a per PVC basis for every ATM PVC.

Through the NVS system, Cell Loss Ratio will measure the percentage of transmitted cells not delivered (or lost) for a PVC during a specific calendar month. The Cell Loss Ratio measures the quantity of cells lost versus the quantity of cells transmitted during a specific calendar month between the two ATM UNIs forming the PVC (i.e., the difference in cells transmitted versus received are considered "lost").

The monthly Cell Loss Ratio for a PVC in a specific calendar month is determined by dividing the quantity of cells lost (determined by subtracting the quantity of cells received from the quantity of cells transmitted) by the quantity of cells transmitted during that calendar month. If the resulting percentage representing the percent of cells lost for the PVC is greater than 1%, this commitment has been missed and the Cell Delivery Rate SLA Credit set forth in E21.3.5.G.6. following will then be issued on this ATM PVC based upon its category of service.

**Note 1:** Effective August 1, 2019, BellSouth Exchange Access Asynchronous Transfer Mode Service (XAATMS) will no longer be available to new Customers. Existing term plan Customers, as of August 1, 2019, may add, move, remove or change lines and/or locations for the duration of their current term plan agreements, but may not enter into any new term plan agreements. Upon expiration of any term plan agreement, service will continue on a month-to-month basis until the service is discontinued by the Telephone Company.

## E21. FAST PACKET ACCESS SERVICE

### E21.3 BellSouth Exchange Access Asynchronous Transfer Mode Service (XAATMS)<sup>1</sup> (Cont'd) (C)

#### E21.3.5 Rate Regulations (Cont'd)

##### G. Service Level Agreements (Cont'd)

##### 6. Credits for Missed SLA Commitments

The following credits are provided for SLA performance commitments missed during a calendar month subject to the conditions outlined herein E21.3.5.G.

Total SLA credits issued for an individual ATM UNI in a specific calendar month cannot exceed the total monthly recurring charges billed for that ATM UNI (i.e., cannot exceed the sum of the monthly billing for the XAATMS Network Interface rate element plus any rate elements for features).

##### Network Availability SLA Credit:

This credit is appropriate when the Network Availability commitment for the customer's total network is missed; this credit is then applied per individual ATM UNI that does not specifically meet the Network Availability commitment.

For each individual ATM UNI not meeting this commitment for a specific calendar month, a credit equal to 1/30 of its monthly recurring charge for the XAATMS Network Interface rate element will be issued.

##### Cell Delivery Rate SLA Credit:

This credit is applied per individual ATM PVC (i.e., PVC Segment pair forming the PVC) that does not meet the Cell Delivery Rate commitment.

For each PVC not meeting this commitment for a specific calendar month, a credit equal to \$5.00 for each PVC Segment will be issued.

##### Cell Loss Ratio SLA Credit:

This credit is applied per individual ATM PVC (i.e., PVC Segment pair forming the PVC) that does not meet the Cell Loss Ratio commitment.

For each PVC not meeting this commitment for a specific calendar month, a credit equal to \$5.00 for each PVC Segment will be issued.

**Note 1:** Effective August 1, 2019, BellSouth Exchange Access Asynchronous Transfer Mode Service (XAATMS) will no longer be available to new Customers. Existing term plan Customers, as of August 1, 2019, may add, move, remove or change lines and/or locations for the duration of their current term plan agreements, but may not enter into any new term plan agreements. Upon expiration of any term plan agreement, service will continue on a month-to-month basis until the service is discontinued by the Telephone Company. (N)

**E21. FAST PACKET ACCESS SERVICE**

**E21.3 BellSouth Exchange Access Asynchronous Transfer Mode Service (XAATMS)<sup>1</sup>** (C)

**E21.3.6 Rates and Charges**

**A. Network Interface**

1. Per UNI

	Nonrecurring Charges	Month To Month	A 12 to 24 Mos. Plan	B 25 to 48 Mos. Plan	USOC
(a) 1.536 Mbps	\$500.00	\$592.50	\$540.00	260.00	XAA11
(b) 44.210 Mbps	750.00	3,639.00	2,880.00	1,550.00	XAA14
(c) 149.760 Mbps	1,000.00	6,750.00	6,075.00	2,880.00	XAA17
(d) 599.040 Mbps	1,500.00	13,500.00	12,150.00	5,800.00	XAA19

**B. PVC Features**

1. CBR ATM PVC Service Category

	Nonrecurring Charges	Month To Month	USOC
(a) PVC Segment Charge, Per Segment	\$70.00	\$5.00	XAACS
(b) Per Megabit-Bandwidth Charge, Per Segment, or	-	25.00	XAACM
(c) Per Increment of 64 Kbps-Bandwidth Charge, Per Segment	-	1.60	XAACK

2. VBR-RT ATM PVC Service Category

(a) PVC Segment Charge, Per Segment	70.00	5.00	XAAVS
(b) Per Megabit-Bandwidth Charge, Per Segment, or	-	25.00	XAAVM
(c) Per Increment of 64 Kbps-Bandwidth Charge, Per Segment	-	1.60	XAAVK

3. VBR-NRT ATM PVC Service Category

(a) PVC Segment Charge, Per Segment	70.00	5.00	XAANS
(b) Per Megabit-Bandwidth Charge, Per Segment, or	-	25.00	XAANM
(c) Per Increment of 64 Kbps-Bandwidth Charge, Per Segment	-	5.00	XAANK

4. UBR ATM PVC Service Category

(a) PVC Segment Charge, Per Segment Per Network Interface	70.00	5.00	XAAUS
(b) 1.536 Mbps UBR Service Activation Charge	-	10.00	XAAA1
(c) 44.210 Mbps UBR Service Activation Charge	-	250.00	XAAA4
(d) 149.760 Mbps UBR Service Activation Charge	-	750.00	XAAA7
(e) 599.040 Mbps UBR Service Activation Charge	-	3,000.00	XAAA9

**C. Feature Change Charge**

(a) Per Occurrence, Per Feature	75.00	None	XAAFC
---------------------------------	-------	------	-------

**D. Transfer of Service**

(a) Per Billing Account Number	75.00	None	XAATF
--------------------------------	-------	------	-------

**Note 1:** Effective August 1, 2019, BellSouth Exchange Access Asynchronous Transfer Mode Service (XAATMS) will no longer be available to new Customers. Existing term plan Customers, as of August 1, 2019, may add, move, remove or change lines and/or locations for the duration of their current term plan agreements, but may not enter into any new term plan agreements. Upon expiration of any term plan agreement, service will continue on a month-to-month basis until the service is discontinued by the Telephone Company. (N)

## E21. FAST PACKET ACCESS SERVICE

### E21.4 Reserved For Future Use

### E21.5 Reserved For Future Use

### E21.6 BellSouth Network Visibility Service

#### E21.6.1 General

- A. BellSouth Network Visibility Service (NVS) is available on an optional basis as a feature of Exchange Access Frame Relay Service (XAFRS) (a.k.a. BellSouth Exchange Access Frame Relay Service) and BellSouth Exchange Access Asynchronous Transfer Mode Service (XAATMS).
- B. BellSouth NVS is a customer network management tool that provides customers a view into their BellSouth Fast Packet network for monitoring and trouble shooting purposes. The following BellSouth NVS options are available for XAFRS (a.k.a. BellSouth Exchange Access Frame Relay Service) and BellSouth XAATMS: Fault Management, On Demand Statistics and Performance Reports.
- C. BellSouth NVS supports hierarchical customer names. For example, a customer defines an overall network name (usually the customer name) and then may choose to establish multiple sub-network names. A maximum of five hierarchical tiers are available (the overall network plus four sub-network tiers).
- D. Access to *the* BellSouth NVS *graphical interface* is via a Web interface; *alternatively, a* dial or dedicated method described in Section A32. of the General Subscriber Service Tariff may also be used to access *the NVS graphical interface*. *Additionally, NVS may be accessed via a Remote Message Interface for the collection of raw data*. For security reasons, customers are required to identify themselves via a username and password. The username and password are assigned at the time the account is established. Following is a description and requirements for each type of *Management Access Interface*.
  1. Web Interface - This interface allows customers to access *the* BellSouth NVS *graphical interface* via the Web using a standard Web browser. This type of access requires a Security Card.
    - a. Security Card – This card provides the customer a unique password identification code which will electronically change periodically.

If the customer has purchased a Security Card in conjunction with another feature or service offered by BellSouth, that Security Card may also be used in conjunction with BellSouth NVS. It is the customer's responsibility to notify BellSouth of an existing Security Card so BellSouth can ensure that the card is validated for multiple features and/or services.
  2. Dial or Dedicated Interface *access to the BellSouth NVS graphical interface* – See A32.1.2 of the General Subscriber Service Tariff.
  3. Remote Message Interface – This interface will allow SSH-IP connectivity to BellSouth NVS from other compatible Network Management systems for the collection of raw data. The customer must have SSH access to the NVS platform. Connectivity must be via a Frame Relay PVC to the Company network. Technical details and limitations on the Remote Message Interface can be found in BellSouth Technical Reference TR-73587.
- E. The customer is responsible for providing and maintaining all terminal equipment necessary to access BellSouth NVS.
- F. A customer may subscribe to BellSouth NVS on a monthly basis. An account is established which will include the XAFRS (a.k.a. BellSouth Exchange Access Frame Relay Service) and BellSouth XAATMS Network Interfaces designated by the customer to have BellSouth NVS capability. Customers may choose to subscribe to BellSouth NVS for all Network Interfaces in their BellSouth Fast Packet network or choose BellSouth NVS for only a portion.

FLORIDA

ISSUED: December 6, 2002

EFFECTIVE: December 21, 2002

BY: Joseph P. Lacher, President -FL  
Miami, Florida

## E21. FAST PACKET ACCESS SERVICE

### E21.6 BellSouth Network Visibility Service (Cont'd)

#### E21.6.1 General (Cont'd)

G. BellSouth NVS is available in two packages, 1) Fault Management and On Demand Statistics or 2) Fault Management, On Demand Statistics and Performance Reports. All network interfaces within a customer's account must be under the same package. If a customer desires to have both packages, a separate account must be established for each package type.

##### 1. Fault Management

BellSouth NVS provides the ability to monitor fault and alarm information as network events occur. If a BellSouth network event results in automatic rerouting of customer owned PVCs on a Network Interface within the BellSouth Fast Packet network, such that those PVCs are not service impacted, then BellSouth will not send PVC events to the customer. The following Fault Management features are available on a customer and sub-network basis:

- BellSouth will provide to the customer, in near real time, all events, faults, and network alarms on any Network Interface or PVC.

- The customer can determine the severity level of alarms displayed and suppress the alarms they do not wish to view.

##### 2. On Demand Statistics

BellSouth NVS provides customers statistics for each Network Interface and PVC on a customer and sub-network basis.

##### 3. Performance Reports

BellSouth NVS provides XAFRS (a.k.a. BellSouth Exchange Access Frame Relay Service) and BellSouth XAATMS customers network performance reports on their BellSouth data network. Customers have the capability of requesting performance reports for interfaces. (Interfaces are defined as network interfaces and PVCs). BellSouth NVS provides a measure of the level of network performance of a customer's network and individual interfaces that is called the Network Performance Level. The Network Performance Level components include Incoming Utilization, Outgoing Utilization, Discarded Frames/Cells and Congestion. The Network Performance Level is used in several reports to provide a weighted performance measure taking into account all the performance parameters mentioned above.

Historical Performance reports will baseline historic network performance, trend future performance and highlight network performance problems. The following selection of reports is available:

a. Network Summary Report - Provides an overview of the customer's network performance in terms of Total Frames/Cells Transmitted and Received, Percent Total Utilization, Total Frames/Cells Discarded, and Percent Frames/Cells Discarded of Total Frames/Cells Transmitted and Received.

b. Forecast Report - Provides the network interfaces or PVCs that are projected to exceed customer specific thresholds of Utilization and Congestion.

FLORIDA

ISSUED: December 6, 2002

EFFECTIVE: December 21, 2002

BY: Joseph P. Lacher, President -FL  
Miami, Florida

## E21. FAST PACKET ACCESS SERVICE

### E21.6 BellSouth Network Visibility Service (Cont'd)

(N)

#### E21.6.1 General (Cont'd)

(N)

##### G. (Cont'd)

(N)

##### 3. Performance Reports (Cont'd)

(N)

c. Network Interface Performance Report - Provides the Network Performance Level on a customer selectable interface (network interface or PVC).

(N)

d. Capacity Planning Report - Provides the top ten over-utilized and top ten under-utilized interfaces (network interface or PVC).

(N)

e. Threshold Exceptions Report - Provides a daily report on the top ten interfaces that exceed a customer selectable threshold parameter. These parameters are Input Utilization, Output Utilization, Incoming Congestion, Outgoing Congestion, In Discards, and Out Discards.

(N)

f. Top Ten Report - Provides a daily report of the top ten interfaces with the highest volumes and the worst Network Performance Level. It also specifies the top ten interfaces with the greatest change in both volume and Network Performance Level.

(N)

#### E21.6.2 Rate Regulations

(N)

A. Rates and charges are specified in E21.6.4 following for BellSouth NVS.

(N)

B. The minimum period of service is one month.

(N)

C. The rates and charges set forth for BellSouth NVS provide for the furnishing of service where suitable facilities are available.

(N)

D. In order to maintain the quality of BellSouth NVS, the Company reserves the right to perform preventive maintenance and software updates. This could result in BellSouth NVS being unavailable during the time period between Midnight and 3:00 A.M. Eastern Time on Sundays. In addition, preventive maintenance may be performed on the XAFRS (a.k.a. BellSouth Exchange Access Frame Relay Service and BellSouth XAATMS circuits being monitored by BellSouth NVS on any given Wednesday or Sunday between 2:00 A.M. and 4:00 A.M. Eastern Time. BellSouth NVS will be unable to view these circuits while preventive maintenance is being performed. The Company only expects to utilize this maintenance window on the average of once a quarter. However, the Company reserves the right to perform maintenance at any time at its discretion that it believes such maintenance is necessary. The Company will make a reasonable effort to provide notice to those customers likely to be affected by such maintenance work.

(N)

## E21. FAST PACKET ACCESS SERVICE

### E21.6 BellSouth Network Visibility Service (Cont'd)

#### E21.6.3 Rate Categories

The following rate categories apply to BellSouth NVS:

**A. Service Establishment Charge**

The Service Establishment Charge is a nonrecurring charge which applies per XAFRS (a.k.a. BellSouth Exchange Access Frame Relay Service) or BellSouth XAATMS customer account. If a customer is both a XAFRS (a.k.a. BellSouth Exchange Access Frame Relay Service) and BellSouth XAATMS customer, only one Service Establishment Charge will apply. This charge covers the initial establishment and set-up of the customer account in the BellSouth NVS database. A username(s) and password(s) will be assigned for use by the customer in accessing their account. At the time the account is established, a customer may also choose to establish sub accounts.

**B. Fault Management and On Demand Statistics**

A monthly charge applies for each Network Interface in the customer's network with BellSouth NVS capability. A nonrecurring charge is applicable per Network Interface at the time of installation.

**C. Fault Management, On Demand Statistics and Performance Reports**

A monthly charge applies for each Network Interface in the customer's network with BellSouth NVS capability. A nonrecurring charge is applicable per Network Interface at the time of installation.

**D. Subsequent Modification Charge**

The Subsequent Modification Charge is a nonrecurring charge which applies per Network Interface when a BellSouth NVS customer requests that existing BellSouth NVS Network Interfaces, or PVC's on the Network Interface, be modified. Examples of this charge include change of customer name and movement between packages. This charge is not applicable:

- when a new PVC is added to an existing BellSouth NVS Network Interface and BellSouth NVS is requested for the new PVC, or
- for a request to change a password.

**E. Management Access Interface**

All customers must have a Management Access Interface. This connection allows the customer to monitor their network. A monthly charge applies for each Web Interface *and each Remote Message Interface*; a nonrecurring charge is applicable per *Web Interface and per Remote Message Interface* at the time of installation. A Security Card described below is required for each web access. See A32.1.2 of the General Subscriber Service Tariff for a dial or dedicated access option. (C)

- Security Card - The Security Card charge specified in E21.6.4 E. following will apply for the initial card or for the issuance of additional cards for additional users or to replace a lost, damaged or expired card.



**E21. FAST PACKET ACCESS SERVICE**

**E21.6 BellSouth Network Visibility Service (Cont'd)**

**E21.6.4 Rates and Charges**

**A. Service Establishment Charge**

1. Per Customer

<b>Nonrecurring Charge</b>	<b>USOC</b>
<b>\$250.00</b>	<b>NVSSE</b>

- (a) Each

**B. Fault Management and On Demand Statistics**

1. Per XAFRS Network Interface

<b>Nonrecurring Charge</b>	<b>Monthly Rate</b>	<b>USOC</b>
<b>\$75.00</b>	<b>\$12.00</b>	<b>NVSFO</b>
<b>75.00</b>	<b>12.00</b>	<b>NVSF1</b>
<b>75.00</b>	<b>12.00</b>	<b>NVSF3</b>

- (a) Per DS0  
 (b) Per DS1  
 (c) Per DS3

2. Per BellSouth XAATMS Network Interface

<b>75.00</b>	<b>12.00</b>	<b>NVSA1</b>
<b>75.00</b>	<b>12.00</b>	<b>NVSA3</b>
<b>75.00</b>	<b>12.00</b>	<b>NVSAC</b>
<b>75.00</b>	<b>12.00</b>	<b>NVSA2</b>

- (a) Per DS1  
 (b) Per DS3  
 (c) Per OC3  
 (d) Per OC12

**C. Fault Management, On Demand Statistics and Performance Reports**

1. Per XAFRS Network Interface

<b>75.00</b>	<b>14.00</b>	<b>NVSRO</b>
<b>75.00</b>	<b>14.00</b>	<b>NVSR1</b>
<b>75.00</b>	<b>14.00</b>	<b>NVSR3</b>

- (a) Per DS0  
 (b) Per DS1  
 (c) Per DS3

2. Per BellSouth XAATMS Network Interface

<b>75.00</b>	<b>14.00</b>	<b>NVST1</b>
<b>75.00</b>	<b>14.00</b>	<b>NVST3</b>
<b>75.00</b>	<b>14.00</b>	<b>NVSTC</b>
<b>75.00</b>	<b>14.00</b>	<b>NVST2</b>

- (a) Per DS1  
 (b) Per DS3  
 (c) Per OC3  
 (d) Per OC12

**D. Subsequent Modification Charge**

1. Per Network Interface

<b>Nonrecurring Charge</b>	<b>USOC</b>
<b>\$70.00</b>	<b>NVSSM</b>

- (a) Each

**E. Management Access Interface<sup>1</sup>**

1. Web Interface

<b>Nonrecurring Charge</b>	<b>Monthly Rate</b>	<b>USOC</b>
<b>\$125.00</b>	<b>\$25.00</b>	<b>NVSW1</b>

- (a) Each

2. Remote Message Interface

<b>125.00</b>	<b>25.00</b>	<b>NVSRM</b>	(N)
---------------	--------------	--------------	-----

- (a) Each

**F. Security Card**

1. Per Card

<b>Nonrecurring Charge</b>	<b>USOC</b>
<b>\$100.00</b>	<b>NVSSC</b>

- (a) Each

**Note 1:** See A32.1.2 of the General Subscriber Service Tariff for a dial or dedicated access option.

BELLSOUTH  
TELECOMMUNICATIONS, INC.  
FLORIDA  
ISSUED: April 12, 1999  
BY: Joseph P. Lacher, President -FL  
Miami, Florida

ACCESS SERVICES TARIFF

Second Revised Page 1  
Cancels First Revised Page 1

EFFECTIVE: April 27, 1999

**E22. (DELETED)**

(D)

CONTENTS

BELLSOUTH  
TELECOMMUNICATIONS, INC.  
FLORIDA  
ISSUED: April 12, 1999  
BY: Joseph P. Lacher, President -FL  
Miami, Florida

ACCESS SERVICES TARIFF

Second Revised Page 1  
Cancels First Revised Page 1

EFFECTIVE: April 27, 1999

**E22. (DELETED)**

(D)

BELLSOUTH  
TELECOMMUNICATIONS, INC.  
FLORIDA  
ISSUED: April 12, 1999  
BY: Joseph P. Lacher, President -FL  
Miami, Florida

ACCESS SERVICES TARIFF

Second Revised Page 2  
Cancels First Revised Page 2

EFFECTIVE: April 27, 1999

**E22. (DELETED)**

(D)

BELLSOUTH  
TELECOMMUNICATIONS, INC.  
FLORIDA  
ISSUED: April 12, 1999  
BY: Joseph P. Lacher, President -FL  
Miami, Florida

ACCESS SERVICES TARIFF

Third Revised Page 3  
Cancels Second Revised Page 3

EFFECTIVE: April 27, 1999

**E22. (DELETED)**

(D)

BELLSOUTH  
TELECOMMUNICATIONS, INC.  
FLORIDA  
ISSUED: April 12, 1999  
BY: Joseph P. Lacher, President -FL  
Miami, Florida

ACCESS SERVICES TARIFF

Second Revised Page 4  
Cancels First Revised Page 4

EFFECTIVE: April 27, 1999

**E22. (DELETED)**

(D)

BELLSOUTH  
TELECOMMUNICATIONS, INC.

FLORIDA

ISSUED: April 12, 1999

BY: Joseph P. Lacher, President -FL  
Miami, Florida

ACCESS SERVICES TARIFF

First Revised Page 5  
Cancels Original Page 5

EFFECTIVE: April 27, 1999

**E22. (DELETED)**

(D)

BELLSOUTH  
TELECOMMUNICATIONS, INC.  
FLORIDA  
ISSUED: April 12, 1999  
BY: Joseph P. Lacher, President -FL  
Miami, Florida

ACCESS SERVICES TARIFF

First Revised Page 6  
Cancels Original Page 6

EFFECTIVE: April 27, 1999

**E22. (DELETED)**

(D)



BELLSOUTH  
TELECOMMUNICATIONS, INC.  
FLORIDA

ACCESS SERVICES TARIFF

First Revised Page 7  
Cancels Original Page 7

ISSUED: April 12, 1999

EFFECTIVE: April 27, 1999

BY: Joseph P. Lacher, President -FL  
Miami, Florida

**E22. (DELETED)**

(D)

BELLSOUTH  
TELECOMMUNICATIONS, INC.

FLORIDA

ISSUED: April 12, 1999

BY: Joseph P. Lacher, President -FL  
Miami, Florida

ACCESS SERVICES TARIFF

First Revised Page 8  
Cancels Original Page 8

EFFECTIVE: April 27, 1999

**E22. (DELETED)**

(D)

BELLSOUTH  
TELECOMMUNICATIONS, INC.  
FLORIDA  
ISSUED: April 12, 1999  
BY: Joseph P. Lacher, President -FL  
Miami, Florida

ACCESS SERVICES TARIFF

First Revised Page 9  
Cancels Original Page 9

EFFECTIVE: April 27, 1999

**E22. (DELETED)**

(D)

BELLSOUTH  
TELECOMMUNICATIONS, INC.  
FLORIDA  
ISSUED: April 12, 1999  
BY: Joseph P. Lacher, President -FL  
Miami, Florida

ACCESS SERVICES TARIFF

First Revised Page 10  
Cancels Original Page 10

EFFECTIVE: April 27, 1999

**E22. (DELETED)**

(D)

BELLSOUTH  
TELECOMMUNICATIONS, INC.  
FLORIDA  
ISSUED: April 12, 1999  
BY: Joseph P. Lacher, President -FL  
Miami, Florida

ACCESS SERVICES TARIFF

First Revised Page 11  
Cancels Original Page 11

EFFECTIVE: April 27, 1999

**E22. (DELETED)**

(D)

BELLSOUTH  
TELECOMMUNICATIONS, INC.  
FLORIDA  
ISSUED: April 12, 1999  
BY: Joseph P. Lacher, President -FL  
Miami, Florida

ACCESS SERVICES TARIFF

First Revised Page 12  
Cancels Original Page 12

EFFECTIVE: April 27, 1999

**E22. (DELETED)**

(D)

BELLSOUTH  
TELECOMMUNICATIONS, INC.

FLORIDA

ISSUED: April 12, 1999

BY: Joseph P. Lacher, President -FL  
Miami, Florida

ACCESS SERVICES TARIFF

First Revised Page 13  
Cancels Original Page 13

EFFECTIVE: April 27, 1999

**E22. (DELETED)**

(D)

BELLSOUTH  
TELECOMMUNICATIONS, INC.  
FLORIDA  
ISSUED: April 12, 1999  
BY: Joseph P. Lacher, President -FL  
Miami, Florida

ACCESS SERVICES TARIFF

Second Revised Page 14  
Cancels First Revised Page 14

EFFECTIVE: April 27, 1999

**E22. (DELETED)**

(D)



## E23. ETHERNET SERVICES

### CONTENTS

E23.1 AT&T SWITCHED ETHERNET SERVICE <sup>SM</sup>	1	(N)
E23.1.1 Service Description	1	
E23.1.2 Service Level Agreement (SLA)	12	
E23.1.3 Limitations and Provisioning	15	
E23.1.4 Ethernet Payment Plan (EPP)	16	
E23.1.5 Rate Conditions	20	
E23.1.6 Rates and Charges	22	(N)

## E23. METROPOLITAN STATISTICAL AREA ACCESS SERVICES

This section concurs in BellSouth Telecommunications, LLC's (BST's) Tariff FCC No. 1, Section 23, which can be accessed via the following hypertext link:

<http://cpr.att.com/pdf/fcc/1023.pdf>

Exceptions to this concurrence of BellSouth Telecommunications, LLC's (BST's) Tariff FCC No. 1, Section 23, are as listed below. The following cited exceptions relate to that specific section in the interstate Tariff FCC No. 1.

### E23.1 General Regulations

Pricing flexibility is not available in the intrastate jurisdiction for:

- Special Access
- Fast Packet
- Digital Subscriber Line
- Optical Transport Access

### E23.3 Services Available in an MSA

Pricing flexibility is not available in the intrastate jurisdiction for:

- BellSouth Wavelength SWA Dedicated Ring Service Components
- BellSouth Wavelength SWA Channel Service Components
- Special Access
- Fast Packet

### E23.5 Rates and Charges

#### E23.5.1 BellSouth SWA Dedicated Transport

**E23.5.1 (A)** BellSouth SWA Local Channel – Plan A and Plan B rates are not applicable to the intrastate jurisdiction.

**E23.5.1 (B)** BellSouth SWA Interoffice Channel – Plan A and Plan B rates are not applicable to the intrastate jurisdiction.

**E23.5.1(C)** Optional Features

**E23.5.1(C) (2)** Channelization

**E23.5.1(C) (2) (a)** DS3 Channelization – Plan A and Plan B rates are not applicable to the intrastate jurisdiction.

**E23.5.1 (D)** DNAL is not available in the intrastate jurisdiction.

**E23.5.1 (F) (1) Dedicated Tandem Trunk Port Service.**

		<u>Originating</u>	<u>Terminating</u>	
Per dedicated DS0/VG trunk port required	USOC	3PO3X	3PT3X	Monthly rate provided in section 6.8.1.c of this tariff
Per dedicated DS1 trunk port required	USOC	3PO4X	3PT4X	Monthly rate provided in section 6.8.1.C of this tariff

**E23.5.1 (K)** Inside Moves are not available in the intrastate jurisdiction.

**E23.5.1 (L)** Changes of Network Channel Interface Codes are not available in the intrastate jurisdiction.

**E23.5.1 (N)** Service Rearrangements

**E23.5.1 (N) (1) (F)** BellSouth SWA 900 Access Service dialing is not available in the intrastate jurisdiction.

**E23.5.1 (O)** Service Rearrangements

**E23.5.1 (O) (1)** Reconfiguration Charges USOC PR1VM, PR1VR, PR11M, PR11R, PR13M AND PR13R are not available in the intrastate jurisdiction.

**E23.5.1 (P)** Transfer of Service

**E23.5.1 (P) (B)** Per Circuit USOC NRBPC is not available in the intrastate jurisdiction,

Material previously appeared on this page now appears in Section 30.

ISSUED: May 31, 2013  
BY: Marshall M. Criser III, President -FL  
Miami, Florida

EFFECTIVE: July 2, 2013

## E23. METROPOLITAN STATISTICAL AREA

### E23.5 Rates and Charges (Cont'd)

#### E23.5.1 BellSouth SWA Dedicated Transport (Cont'd)

**E23.5.1(S) BellSouth Wavelength SWA Dedicated Ring Service Components** are not applicable in the intrastate jurisdiction.

**E23.5.1 (T) BellSouth Wavelength SWA Channel Service Components** are not applicable in the intrastate jurisdiction.

#### E2.5.1.1 Vintage Rates

Special access pricing flexibility is not available in the intrastate jurisdiction.

**E23.5.1.1 (B)** The following rates apply to Switched Transport Services installed before July 2, 2013.

#### BellSouth Dedicated Ring - Self-healing Multi-nodal Alternate Route Topology Ring

RATE ELEMENT	USOC	Rates
MSRing Ntwk Svc-Off-Net DS3 - 36 Mos	SG3SW	\$2,550.00
SMARTRing LC/ .25 Mile 12-36 Mos	1HSLC	\$85.00
SMARTRing LC/ .25 Mile 37-60 Mos	1HSLC	\$75.00
SMARTRing LC/ .25 Mile 61-96 Mos	1HSLC	\$70.00
SMARTRing IOC OC-3 Fixed 37-60 Mos	1HS1C	\$35.00
SMARTRing IOC OC-192+ 12-36 Mo	1HS1C	\$450.00
SMARTRing IOC OC-192+ 37-60 Mo	1HS1C	\$400.00
SMARTRing IOC OC-192+ 61-96 Mo	1HS1C	\$380.00
SMARTRing IOM OC-3 / .25 Mile 12-36 Mos	1HS1C	\$35.00
SMARTRing IOM OC-3 / .25 Mile 37-60 Mos	1HS1C	\$25.00
SMARTRing IOM >OC-3 / .25 Mile 61-96 Mos	1HS1C	\$25.00
SMARTRing IOM OC-192+ 61-96 Mo	1HS1C	\$25.00
SMARTRing INC/ .25 Mile SWC 12-36 Mos	1HSSC	\$690.00
SMARTRing INC/ .25 Mile SWC 37-60 Mos	1HSSC	\$415.00
SMARTRing INC/ .25 Mile SWC 61-96 Mos	1HSSC	\$345.00
SMARTRing INC/ .25 Mile CWC 12-36 Mos	1HSCC	\$780.00
SMARTRing INC/ .25 Mile CWC 37-60 Mos	1HSCC	\$465.00
SMARTRing INC/ .25 Mile CWC 61-96 Mos	1HSCC	\$390.00
SMARTRing Cust Node OC-192 12-36 Mo	SHSN6	\$9,375.00
SMARTRing Cust Node OC-192 37-60 Mo	SHSN6	\$8,250.00
SMARTRing Cust Node OC-192 61-96 Mo	SHSN6	\$7,300.00
SMARTRing Cust Node OC-192+ 12-36 Mo	SHSC2	\$9,375.00
SMARTRing Cust Node OC-192+ 37-60 Mo	SHSC2	\$8,250.00
SMARTRing Cust Node OC-192+ 61-96 Mo	SHSC2	\$7,300.00
SMARTRing CUCI/DS1 - 12-36 Mo	SHSBB	\$34.00
SMARTRing CUCI/DS1 - 37-60 Mo	SHSBB	\$27.00
SMARTRing CUCI/DS1 - 61-96 Mo	SHSBB	\$21.00
SMARTRing CUCI/DS3 - 12-36 Mo	SHSZT	\$135.00
SMARTRing CUCI/DS3 - 37-60 Mo	SHSZT	\$130.00

Material previously appeared on this page now appears in Section 30.

ISSUED: May 31, 2013  
BY: Marshall M. Criser III, President -FL  
Miami, Florida

EFFECTIVE: July 2, 2013

**E23. METROPOLITAN STATISTICAL AREA**

**E23.5.1.1 Vintage Rates (Cont'd)**

**E23.51.1 (B) Cont'd**

BellSouth Dedicated Ring - Self-healing Multi-nodal Alternate Route Topology Ring

RATE ELEMENT	USOC	Rates
SMARTRing CUCI/DS3 - 61-96 Mo	SHSZT	\$125.00
SMARTRing CUCI/STS-1 - 12-36 Mo	SHS13	\$170.00
SMARTRing CUCI/STS-1 - 37-60 Mo	SHS13	\$150.00
SMARTRing CUCI/STS-1 - 61-96 Mo	SHS13	\$140.00
SMARTRing CUCI/OC-1 - 12-36 Mo	SHS1C	\$90.00
SMARTRing CUCI/OC-1 - 37-60 Mo	SHS1C	\$80.00
SMARTRing CUCI/OC-1 - 61-96 Mo	SHS1C	\$75.00
SMARTRing CUCI/OC-48 (2 Fiber) 12-36 Mo	SHS1A	\$1,325.00
SMARTRing CUCI/OC-48 (2 Fiber) 37-60 Mo	SHS1A	\$1,215.00
SMARTRing CUCI/OC-48 (2 Fiber) 61-96 Mo	SHS1A	\$1,050.00
SMARTRing CUCI/OC-48 (4 Fiber) 12-36 Mo	SHS1B	\$2,650.00
SMARTRing CUCI/OC-48 (4 Fiber) 37-60 Mo	SHS1B	\$2,430.00
SMARTRing CUCI/OC-48 (4 Fiber) 61-96 Mo	SHS1B	\$2,100.00
SMARTRing CO Node OC-192 12-36 Mo	SHSH7	\$9,375.00
SMARTRing CO Node OC-192 37-60 Mo	SHSH7	\$8,250.00
SMARTRing CO Node OC-192 61-96 Mo	SHSH7	\$7,300.00
SMARTRing CO Node OC-192+ 12-36 Mo	SHSH2	\$9,375.00
SMARTRing CO Node OC-192+ 37-60 Mo	SHSH2	\$8,250.00
SMARTRing CO Node OC-192+ 61-96 Mo	SHSH2	\$7,300.00
SMARTRing COCI/DS1 - 12-36 Mo	SHSCB	\$30.00
SMARTRing COCI/DS1 - 37-60 Mo	SHSCB	\$25.00
SMARTRing COCI/DS1 - 61-96 Mo	SHSCB	\$20.00
SMARTRing COCI/DS3 - 12-36 Mos	SHSYT	\$85.00
SMARTRing COCI/DS3 - 37-60 Mos	SHSYT	\$80.00
SMARTRing COCI/DS3 - 61-96 Mos	SHSYT	\$75.00
SMARTRing COCI/STS-1 - 12-36 Mos	SHS02	\$105.00
SMARTRing COCI/STS-1 - 37-60 Mos	SHS02	\$100.00
SMARTRing COCI/STS-1 - 61-96 Mos	SHS02	\$90.00
SMARTRing COCI/OC-1 - 12-36 Mo	SHSCC	\$90.00
SMARTRing COCI/OC-1 - 37-60 Mo	SHSCC	\$80.00
SMARTRing COCI/OC-1 - 61-96 Mo	SHSCC	\$75.00
SMARTRing COCI/OC-3 (4 Fiber) - 12-36 Mos	SHS04	\$330.00
SMARTRing COCI/OC-3 (4 Fiber) - 37-60 Mos	SHS04	\$300.00
SMARTRing COCI/OC-3 (4 Fiber) - 61-96 Mos	SHS04	\$270.00
SMARTRing COCI/28 DS1 - DS3 - 12-36 Mos	SHSW8	\$550.00

Material previously appeared on this page now appears in Section 30.

**E23. METROPOLITAN STATISTICAL AREA**

**E23.5.1.1 Vintage Rates (Cont'd)**

**E23.51.1 (B) Cont'd**

BellSouth Dedicated Ring - Self-healing Multi-nodal Alternate Route Topology Ring

RATE ELEMENT	USOC	Rates	
SMARTRing COCI/28 DS1 - DS3 - 37-60 Mo	SHSW8	\$500.00	(T)
SMARTRing COCI/28 DS1 - DS3 - 61-96 Mo	SHSW8	\$450.00	
SMARTRing COCI/28 DS1- STS-1 - 12-36 Mo	SHSCS	\$650.00	
SMARTRing COCI/28 DS1- STS-1 - 37-60 Mo	SHSCS	\$600.00	
SMARTRing COCI/28 DS1- STS-1 - 61-96 Mo	SHSCS	\$575.00	
SMARTRing COCI/DS1 on 28 DS1 - DS3 12-36 Mo	SHSCA	\$12.00	
SMARTRing COCI/DS1 on 28 DS1 - DS3 37-60 Mo	SHSCA	\$9.00	
SMARTRing COCI/DS1 on 28 DS1 - DS3 61-96 Mo	SHSCA	\$7.00	
SMARTRing COCI/DS1 on 28 DS1-STS-1 12-36 Mo	SHSCG	\$35.00	
SMARTRing COCI/DS1 on 28 DS1-STS-1 37-60 Mo	SHSCG	\$30.00	
SMARTRing COCI/DS1 on 28 DS1-STS-1 61-96 Mo	SHSCG	\$25.00	(T)
SMARTRing COCI/OC-48 (2 Fiber) 12-36 Mo	SHSCJ	\$1,325.00	
SMARTRing COCI/OC-48 (2 Fiber) 37-60 Mo	SHSCJ	\$1,215.00	
SMARTRing COCI/OC-48 (2 Fiber) 61-96 Mo	SHSCJ	\$1,050.00	
SMARTRing COCI/OC-48 (4 Fiber) 12-36 Mo	SHSCK	\$2,650.00	
SMARTRing COCI/OC-48 (4 Fiber) 37-60 Mo	SHSCK	\$2,430.00	
SMARTRing COCI/OC-48 (4 Fiber) 61-96 Mo	SHSCK	\$2,100.00	
SMARTRing OC-3 Shared Node 12-36 Mo	SHSHE	\$690.00	(D)
SMARTRing OC-3 Shared Node 37-60 Mo	SHSHE	\$630.00	
SMARTRing OC-3 Shared Node 61-96 Mo	SHSHE	\$570.00	
SMARTRing OC-12 Shared Node 12-36 Mo	SHSHE	\$1,390.00	(D)
SMARTRing OC-12 Shared Node 37-60 Mo	SHSHE	\$1,260.00	
SMARTRing OC-48 & OC-48+ Shared Node 12-36 Mo	SHSHE	\$2,880.00	(D)
SMARTRing OC-48 & OC-48+ Shared Node 37-60 Mo	SHSHE	\$2,840.00	
SMARTRing OC-48 & OC-48+ Shared Node 61-96 Mo	SHSHE	\$2,460.00	

BellSouth SWA Managed Shared Network Service

RATE ELEMENT	ZONE	USOC	Rates
MSNS DS1 IOC - 0-8 Miles 60 Mo	1	1L5MS	\$110.00
MSNS DS1 IOC - 0-8 Miles 60 Mo	2	1L5MS	\$130.00
MSNS DS1 IOC - 0-8 Miles 60 Mo	3	1L5MS	\$180.00
MSNS DS1 IOC - 9-25 Miles 60 Mo	1	1L5MS	\$200.00
MSNS DS1 IOC - 9-25 Miles 60 Mo	2	1L5MS	\$240.00
MSNS DS1 IOC - 9-25 Miles 60 Mo	3	1L5MS	\$300.00
MSNS DS1 IOC - 25+ Miles 60 Mo	1	1L5MS	\$115.00
MSNS DS1 IOC - 25+ Miles 60 Mo	2	1L5MS	\$126.50

ISSUED: May 31, 2013

EFFECTIVE: July 2, 2013

BY: Marshall M. Criser III, President -FL  
Miami, Florida

**E23. METROPOLITAN STATISTICAL AREA**

**E23.5.1.1 Vintage Rates (Cont'd)**

**E23.51.1 (B) Cont'd**

BellSouth SWA Managed Shared Network Service

RATE ELEMENT	ZONE	USOC	Rates
MSNS DS1 IOC - 25+ Miles 60 Mo	3	1L5MS	\$138.00
MSNS DS1 IOM - 25+ Miles 60 Mo	1	1L5MS	\$5.70
MSNS DS1 IOM - 25+ Miles 60 Mo	2	1L5MS	\$6.60
MSNS DS1 IOM - 25+ Miles 60 Mo	3	1L5MS	\$8.05
MSNS DS0 IOC - 0-8 Miles 60 Mo		1L5MS	\$22.00
MSNS DS0 IOC - 9-25 Miles 60 Mo		1L5MS	\$38.00
MSNS DS0 IOC - 25+ Miles 60 Mo		1L5MS	\$20.00
MSNS DS0 IOM - 25+ Miles 60 Mo		1L5MS	\$1.40
MSNS DS1/DS0 Interface - Per Interface 60 Mo	1	OHS1S	\$35.00
MSNS DS1/DS0 Interface - Per Interface 60 Mo	2	OHS1S	\$39.00
MSNS DS1/DS0 Interface - Per Interface 60 Mo	3	OHS1S	\$52.00
MSNS DS1 Message Trunk Interface 60 Mo	1	OHS1M	\$100.00
MSNS DS1 Message Trunk Interface 60 Mo	2	OHS1M	\$120.00
MSNS DS1 Message Trunk Interface 60 Mo	3	OHS1M	\$140.00
MSNS DS0 - per line side connection 60 Mo		OHSOL	\$19.00
MSNS DS0 - per trunk side connection 60 Mo		OHSOT	\$19.00
MSNS - LC (1 DS3) 60 Mo	1	OHS3L	\$3,285.00
MSNS - LC (2 DS3) 60 Mo	1	OHS3L	\$3,385.00
MSNS - LC (3 DS3) 60 Mo	1	OHS3L	\$3,485.00
MSNS - LC (4 DS3) 60 Mo	1	OHS3L	\$3,585.00
MSNS - LC (5 DS3) 60 Mo	1	OHS3L	\$3,685.00
MSNS - LC (6 DS3) 60 Mo	1	OHS3L	\$3,785.00
MSNS - LC (7 DS3) 60 Mo	1	OHS3L	\$3,885.00
MSNS - LC (8 DS3) 60 Mo	1	OHS3L	\$3,985.00
MSNS - LC (9 DS3) 60 Mo	1	OHS3L	\$4,085.00
MSNS - LC (10 DS3) 60 Mo	1	OHS3L	\$ 4,185.00
MSNS - LC (11 DS3) 60 Mo	1	OHS3L	\$ 4,285.00
MSNS - LC (12 DS3) 60 Mo	1	OHS3L	\$ 4,728.00
MSNS - LC (13 DS3) 60 Mo	1	OHS3L	\$ 5,149.00
MSNS - LC (14 DS3) 60 Mo	1	OHS3L	\$ 5,549.00
MSNS - LC (15 DS3) 60 Mo	1	OHS3L	\$ 5,927.00
MSNS - LC (16 DS3) 60 Mo	1	OHS3L	\$ 6,286.00
MSNS - LC (18 DS3) 60 Mo	1	OHS3L	\$ 6,945.00
MSNS - LC (19 DS3) 60 Mo	1	OHS3L	\$ 7,247.00
MSNS - LC (20 DS3) 60 Mo	1	OHS3L	\$ 7,697.00

Material previously appeared on this page now appears in Section 30.

ISSUED: May 31, 2013

EFFECTIVE: July 2, 2013

BY: Marshall M. Criser III, President -FL  
Miami, Florida

**E23. METROPOLITAN STATISTICAL AREA**

**E23.5.1.1 Vintage Rates (Cont'd)**

**E23.51.1 (B) Cont'd**

BellSouth SWA Managed Shared Network Service

RATE ELEMENT	ZONE	USOC	Rates
MSNS - LC (21 DS3) 60 Mo	1	OHS3L	\$ 8,147.00
MSNS - LC (22 DS3) 60 Mo	1	OHS3L	\$ 8,597.00
MSNS - LC (23 DS3) 60 Mo	1	OHS3L	\$ 9,047.00
MSNS - LC (24 DS3) 60 Mo	1	OHS3L	\$ 9,497.00
MSNS - LC (25 DS3) 60 Mo	1	OHS3L	\$ 9,947.00
MSNS - LC (26 DS3) 60 Mo	1	OHS3L	\$10,397.00
MSNS - LC (27 DS3) 60 Mo	1	OHS3L	\$10,847.00
MSNS - LC (28 DS3) 60 Mo	1	OHS3L	\$11,297.00
MSNS - LC (29 DS3) 60 Mo	1	OHS3L	\$11,747.00
MSNS - LC (30 DS3) 60 Mo	1	OHS3L	\$12,197.00
MSNS - LC (31 DS3) 60 Mo	1	OHS3L	\$12,619.00
MSNS - LC (32 DS3) 60 Mo	1	OHS3L	\$12,754.00
MSNS - LC (33 DS3) 60 Mo	1	OHS3L	\$12,882.00
MSNS - LC (34 DS3) 60 Mo	1	OHS3L	\$13,003.00
MSNS - LC (35 DS3) 60 Mo	1	OHS3L	\$13,118.00
MSNS - LC (36 DS3) 60 Mo	1	OHS3L	\$13,226.00
MSNS - LC (37 DS3) 60 Mo	1	OHS3L	\$13,330.00
MSNS - LC (38 DS3) 60 Mo	1	OHS3L	\$13,431.00
MSNS - LC (39 DS3) 60 Mo	1	OHS3L	\$13,528.00
MSNS - LC (40 DS3) 60 Mo	1	OHS3L	\$13,622.00
MSNS - LC (41 DS3) 60 Mo	1	OHS3L	\$13,715.00
MSNS - LC (42 DS3) 60 Mo	1	OHS3L	\$13,806.00
MSNS - LC (43 DS3) 60 Mo	1	OHS3L	\$13,897.00
MSNS - LC (44 DS3) 60 Mo	1	OHS3L	\$13,988.00
MSNS - LC (45 DS3) 60 Mo	1	OHS3L	\$14,080.00
MSNS - LC (46 DS3) 60 Mo	1	OHS3L	\$14,174.00
MSNS - LC (47 DS3) 60 Mo	1	OHS3L	\$14,271.00
MSNS - LC (48 DS3) 60 Mo	1	OHS3L	\$14,371.00
MSNS - LC (49 DS3) 60 Mo	1	OHS3L	\$14,671.00
MSNS - LC (50 DS3) 60 Mo	1	OHS3L	\$14,946.00
MSNS - LC (51 DS3) 60 Mo	1	OHS3L	\$15,196.00
MSNS - LC (52 DS3) 60 Mo	1	OHS3L	\$15,421.00
MSNS - LC (53 DS3) 60 Mo	1	OHS3L	\$15,521.00
MSNS - LC (54 DS3) 60 Mo	1	OHS3L	\$15,721.00
MSNS - LC (55 DS3) 60 Mo	1	OHS3L	\$15,896.00

Material previously appeared on this page now appears in Section 30.

ISSUED: May 31, 2013  
BY: Marshall M. Criser III, President -FL  
Miami, Florida

EFFECTIVE: July 2, 2013

**E23. METROPOLITAN STATISTICAL AREA**

(C)

**E23.5.1.1 Vintage Rates (Cont'd)**

**E23.51.1 (B) Cont'd**

BellSouth SWA Managed Shared Network Service

RATE ELEMENT	ZONE	USOC	Rates
MSNS - LC (56 DS3) 60 Mo	1	OHS3L	\$16,046.00
MSNS - LC (57 DS3) 60 Mo	1	OHS3L	\$16,146.00
MSNS - LC (58 DS3) 60 Mo	1	OHS3L	\$16,271.00
MSNS - LC (59 DS3) 60 Mo	1	OHS3L	\$16,371.00
MSNS - LC (60 DS3) 60 Mo	1	OHS3L	\$16,471.00
MSNS - LC (61 DS3) 60 Mo	1	OHS3L	\$16,820.00
MSNS - LC (62 DS3) 60 Mo	1	OHS3L	\$17,170.00
MSNS - LC (63 DS3) 60 Mo	1	OHS3L	\$17,520.00
MSNS - LC (64 DS3) 60 Mo	1	OHS3L	\$17,870.00
MSNS - LC (65 DS3) 60 Mo	1	OHS3L	\$18,220.00
MSNS - LC (66 DS3) 60 Mo	1	OHS3L	\$18,570.00
MSNS - LC (67 DS3) 60 Mo	1	OHS3L	\$18,920.00
MSNS - LC (68 DS3) 60 Mo	1	OHS3L	\$19,270.00
MSNS - LC (69 DS3) 60 Mo	1	OHS3L	\$19,620.00
MSNS - LC (70 DS3) 60 Mo	1	OHS3L	\$19,970.00
MSNS - LC (71 DS3) 60 Mo	1	OHS3L	\$20,320.00
MSNS - LC (72 DS3) 60 Mo	1	OHS3L	\$20,670.00
MSNS - LC (73 DS3) 60 Mo	1	OHS3L	\$21,020.00
MSNS - LC (74 DS3) 60 Mo	1	OHS3L	\$21,370.00
MSNS - LC (75 DS3) 60 Mo	1	OHS3L	\$21,720.00
MSNS - LC (76 DS3) 60 Mo	1	OHS3L	\$22,070.00
MSNS - LC (77 DS3) 60 Mo	1	OHS3L	\$22,420.00
MSNS - LC (78 DS3) 60 Mo	1	OHS3L	\$22,770.00
MSNS - LC (79 DS3) 60 Mo	1	OHS3L	\$23,120.00
MSNS - LC (80 DS3) 60 Mo	1	OHS3L	\$23,470.00
MSNS - LC (81 DS3) 60 Mo	1	OHS3L	\$23,820.00
MSNS - LC (82 DS3) 60 Mo	1	OHS3L	\$24,170.00
MSNS - LC (83 DS3) 60 Mo	1	OHS3L	\$24,520.00
MSNS - LC (84 DS3) 60 Mo	1	OHS3L	\$24,870.00
MSNS - LC (85 DS3) 60 Mo	1	OHS3L	\$25,220.00
MSNS - LC (86 DS3) 60 Mo	1	OHS3L	\$25,570.00
MSNS - LC (87 DS3) 60 Mo	1	OHS3L	\$25,920.00
MSNS - LC (88 DS3) 60 Mo	1	OHS3L	\$26,270.00
MSNS - LC (89 DS3) 60 Mo	1	OHS3L	\$26,620.00
MSNS - LC (90 DS3) 60 Mo	1	OHS3L	\$26,970.00

(C)

Material previously appeared on this page now appears in Section 30.



ISSUED: May 31, 2013

EFFECTIVE: July 2, 2013

BY: Marshall M. Criser III, President -FL  
Miami, Florida

**E23. METROPOLITAN STATISTICAL AREA**

**E23.5.1.1 Vintage Rates (Cont'd)**

**E23.51.1 (B) Cont'd**

BellSouth SWA Managed Shared Network Service

RATE ELEMENT	ZONE	USOC	Rates
MSNS - LC (91 DS3) 60 Mo	1	OHS3L	\$27,320.00
MSNS - LC (92 DS3) 60 Mo	1	OHS3L	\$27,670.00
MSNS - LC (93 DS3) 60 Mo	1	OHS3L	\$28,020.00
MSNS - LC (94 DS3) 60 Mo	1	OHS3L	\$28,370.00
MSNS - LC (95 DS3) 60 Mo	1	OHS3L	\$28,720.00
MSNS - LC (96 DS3) 60 Mo	1	OHS3L	\$29,070.00
MSNS - LC (97 DS3) 60 Mo	1	OHS3L	\$29,420.00
MSNS - LC (98 DS3) 60 Mo	1	OHS3L	\$29,770.00
MSNS - LC (99 DS3) 60 Mo	1	OHS3L	\$30,120.00
MSNS - LC (100 DS3) 60 Mo	1	OHS3L	\$30,470.00
MSNS - LC (101 DS3) 60 Mo	1	OHS3L	\$30,820.00
MSNS - LC (102 DS3) 60 Mo	1	OHS3L	\$31,170.00
MSNS - LC (103 DS3) 60 Mo	1	OHS3L	\$31,520.00
MSNS - LC (104 DS3) 60 Mo	1	OHS3L	\$31,870.00
MSNS - LC (105 DS3) 60 Mo	1	OHS3L	\$32,220.00
MSNS - LC (106 DS3) 60 Mo	1	OHS3L	\$32,570.00
MSNS - LC (107 DS3) 60 Mo	1	OHS3L	\$32,920.00
MSNS - LC (108 DS3) 60 Mo	1	OHS3L	\$33,270.00
MSNS - LC (109 DS3) 60 Mo	1	OHS3L	\$33,620.00
MSNS - LC (110 DS3) 60 Mo	1	OHS3L	\$33,970.00
MSNS - LC (111 DS3) 60 Mo	1	OHS3L	\$34,320.00
MSNS - LC (112 DS3) 60 Mo	1	OHS3L	\$34,670.00
MSNS - LC (113 DS3) 60 Mo	1	OHS3L	\$35,020.00
MSNS - LC (114 DS3) 60 Mo	1	OHS3L	\$35,370.00
MSNS - LC (115 DS3) 60 Mo	1	OHS3L	\$35,720.00
MSNS - LC (116 DS3) 60 Mo	1	OHS3L	\$36,070.00
MSNS - LC (117 DS3) 60 Mo	1	OHS3L	\$36,420.00
MSNS - LC (118 DS3) 60 Mo	1	OHS3L	\$36,770.00
MSNS - LC (119 DS3) 60 Mo	1	OHS3L	\$37,120.00
MSNS - LC (120 DS3) 60 Mo	1	OHS3L	\$37,470.00
MSNS - LC (121 DS3) 60 Mo	1	OHS3L	\$37,820.00
MSNS - LC (122 DS3) 60 Mo	1	OHS3L	\$38,170.00
MSNS - LC (123 DS3) 60 Mo	1	OHS3L	\$38,520.00
MSNS - LC (124 DS3) 60 Mo	1	OHS3L	\$38,870.00
MSNS - LC (125 DS3) 60 Mo	1	OHS3L	\$39,220.00

Material previously appeared on this page now appears in Section 30.

ISSUED: May 31, 2013  
BY: Marshall M. Criser III, President -FL  
Miami, Florida

EFFECTIVE: July 2, 2013

**E23. METROPOLITAN STATISTICAL AREA**

**E23.5.1.1 Vintage Rates (Cont'd)**

**E23.51.1 (B) Cont'd**

BellSouth SWA Managed Shared Network Service

RATE ELEMENT	ZONE	USOC	Rates
MSNS - LC (126 DS3) 60 Mo	1	OHS3L	\$39,570.00
MSNS - LC (127 DS3) 60 Mo	1	OHS3L	\$39,920.00
MSNS - LC (128 DS3) 60 Mo	1	OHS3L	\$40,270.00
MSNS - LC (129 DS3) 60 Mo	1	OHS3L	\$40,620.00
MSNS - LC (130 DS3) 60 Mo	1	OHS3L	\$40,970.00
MSNS - LC (131 DS3) 60 Mo	1	OHS3L	\$41,320.00
MSNS - LC (132 DS3) 60 Mo	1	OHS3L	\$41,670.00
MSNS - LC (133 DS3) 60 Mo	1	OHS3L	\$42,020.00
MSNS - LC (134 DS3) 60 Mo	1	OHS3L	\$42,370.00
MSNS - LC (135 DS3) 60 Mo	1	OHS3L	\$42,720.00
MSNS - LC (136 DS3) 60 Mo	1	OHS3L	\$43,070.00
MSNS - LC (137 DS3) 60 Mo	1	OHS3L	\$43,420.00
MSNS - LC (138 DS3) 60 Mo	1	OHS3L	\$43,770.00
MSNS - LC (139 DS3) 60 Mo	1	OHS3L	\$44,120.00
MSNS - LC (140 DS3) 60 Mo	1	OHS3L	\$44,470.00
MSNS - LC (141 DS3) 60 Mo	1	OHS3L	\$44,820.00
MSNS - LC (142 DS3) 60 Mo	1	OHS3L	\$45,170.00
MSNS - LC (143 DS3) 60 Mo	1	OHS3L	\$45,520.00
MSNS - LC (144 DS3) 60 Mo	1	OHS3L	\$45,870.00
MSNS - LC (145 DS3) 60 Mo	1	OHS3L	\$46,220.00
MSNS - LC (146 DS3) 60 Mo	1	OHS3L	\$46,570.00
MSNS - LC (147 DS3) 60 Mo	1	OHS3L	\$46,920.00
MSNS - LC (148 DS3) 60 Mo	1	OHS3L	\$47,270.00
MSNS - LC (149 DS3) 60 Mo	1	OHS3L	\$47,620.00
MSNS - LC (150 DS3) 60 Mo	1	OHS3L	\$47,970.00
MSNS - LC (151 DS3) 60 Mo	1	OHS3L	\$48,320.00
MSNS - LC (152 DS3) 60 Mo	1	OHS3L	\$48,670.00
MSNS - LC (153 DS3) 60 Mo	1	OHS3L	\$49,020.00
MSNS - LC (154 DS3) 60 Mo	1	OHS3L	\$49,370.00
MSNS - LC (155 DS3) 60 Mo	1	OHS3L	\$49,720.00
MSNS - LC (156 DS3) 60 Mo	1	OHS3L	\$50,070.00
MSNS - LC (157 DS3) 60 Mo	1	OHS3L	\$50,420.00
MSNS - LC (158 DS3) 60 Mo	1	OHS3L	\$50,770.00
MSNS - LC (159 DS3) 60 Mo	1	OHS3L	\$51,120.00
MSNS - LC (160 DS3) 60 Mo	1	OHS3L	\$51,470.00

Material previously appeared on this page now appears in Section 30.

(C)

(C)

ISSUED: May 31, 2013

EFFECTIVE: July 2, 2013

BY: Marshall M. Criser III, President -FL  
Miami, Florida

**E23. METROPOLITAN STATISTICAL AREA**

**E23.5.1.1 Vintage Rates (Cont'd)**

**E23.51.1 (B) Cont'd**

BellSouth SWA Managed Shared Network Service

RATE ELEMENT	ZONE	USOC	Rates
MSNS - LC (161 DS3) 60 Mo	1	OHS3L	\$51,820.00
MSNS - LC (162 DS3) 60 Mo	1	OHS3L	\$52,170.00
MSNS - LC (163 DS3) 60 Mo	1	OHS3L	\$52,520.00
MSNS - LC (164 DS3) 60 Mo	1	OHS3L	\$52,870.00
MSNS - LC (165 DS3) 60 Mo	1	OHS3L	\$53,220.00
MSNS - LC (166 DS3) 60 Mo	1	OHS3L	\$53,570.00
MSNS - LC (167 DS3) 60 Mo	1	OHS3L	\$53,920.00
MSNS - LC (168 DS3) 60 Mo	1	OHS3L	\$54,270.00
MSNS - LC (169 DS3) 60 Mo	1	OHS3L	\$54,620.00
MSNS - LC (170 DS3) 60 Mo	1	OHS3L	\$54,970.00
MSNS - LC (171 DS3) 60 Mo	1	OHS3L	\$55,320.00
MSNS - LC (172 DS3) 60 Mo	1	OHS3L	\$55,670.00
MSNS - LC (173 DS3) 60 Mo	1	OHS3L	\$56,020.00
MSNS - LC (174 DS3) 60 Mo	1	OHS3L	\$56,370.00
MSNS - LC (175 DS3) 60 Mo	1	OHS3L	\$56,720.00
MSNS - LC (176 DS3) 60 Mo	1	OHS3L	\$57,070.00
MSNS - LC (177 DS3) 60 Mo	1	OHS3L	\$57,420.00
MSNS - LC (178 DS3) 60 Mo	1	OHS3L	\$57,770.00
MSNS - LC (179 DS3) 60 Mo	1	OHS3L	\$58,120.00
MSNS - LC (180 DS3) 60 Mo	1	OHS3L	\$58,470.00
MSNS - LC (181 DS3) 60 Mo	1	OHS3L	\$58,820.00
MSNS - LC (182 DS3) 60 Mo	1	OHS3L	\$59,170.00
MSNS - LC (183 DS3) 60 Mo	1	OHS3L	\$59,520.00
MSNS - LC (184 DS3) 60 Mo	1	OHS3L	\$59,870.00
MSNS - LC (185 DS3) 60 Mo	1	OHS3L	\$60,220.00
MSNS - LC (186 DS3) 60 Mo	1	OHS3L	\$60,570.00
MSNS - LC (187 DS3) 60 Mo	1	OHS3L	\$60,920.00
MSNS - LC (188 DS3) 60 Mo	1	OHS3L	\$61,270.00
MSNS - LC (189 DS3) 60 Mo	1	OHS3L	\$61,620.00
MSNS - LC (190 DS3) 60 Mo	1	OHS3L	\$61,970.00
MSNS - LC (191 DS3) 60 Mo	1	OHS3L	\$62,320.00
MSNS - LC (192 DS3) 60 Mo	1	OHS3L	\$62,670.00
MSNS - LC (1 DS3) 60 Mo	2	OHS3L	\$3,942.00
MSNS - LC (2 DS3) 60 Mo	2	OHS3L	\$4,062.00
MSNS - LC (3 DS3) 60 Mo	2	OHS3L	\$4,182.00

Material previously appeared on this page now appears in Section 30.

ISSUED: May 31, 2013

EFFECTIVE: July 2, 2013

BY: Marshall M. Criser III, President -FL  
Miami, Florida

**E23. METROPOLITAN STATISTICAL AREA**

**E23.5.1.1 Vintage Rates (Cont'd)**

**E23.51.1 (B) Cont'd**

BellSouth SWA Managed Shared Network Service

RATE ELEMENT	ZONE	USOC	Rates
MSNS - LC (4 DS3) 60 Mo	2	OHS3L	\$4,302.00
MSNS - LC (5 DS3) 60 Mo	2	OHS3L	\$4,902.00
MSNS - LC (6 DS3) 60 Mo	2	OHS3L	\$5,502.00
MSNS - LC (7 DS3) 60 Mo	2	OHS3L	\$6,181.00
MSNS - LC (8 DS3) 60 Mo	2	OHS3L	\$6,829.00
MSNS - LC (9 DS3) 60 Mo	2	OHS3L	\$7,447.00
MSNS - LC (10 DS3) 60 Mo	2	OHS3L	\$ 8,035.00
MSNS - LC (11 DS3) 60 Mo	2	OHS3L	\$ 8,596.00
MSNS - LC (12 DS3) 60 Mo	2	OHS3L	\$ 9,127.00
MSNS - LC (13 DS3) 60 Mo	2	OHS3L	\$ 9,632.00
MSNS - LC (14 DS3) 60 Mo	2	OHS3L	\$10,112.00
MSNS - LC (15 DS3) 60 Mo	2	OHS3L	\$10,566.00
MSNS - LC (16 DS3) 60 Mo	2	OHS3L	\$10,997.00
MSNS - LC (17 DS3) 60 Mo	2	OHS3L	\$11,404.00
MSNS - LC (18 DS3) 60 Mo	2	OHS3L	\$11,788.00
MSNS - LC (19 DS3) 60 Mo	2	OHS3L	\$12,150.00
MSNS - LC (20 DS3) 60 Mo	2	OHS3L	\$12,492.00
MSNS - LC (21 DS3) 60 Mo	2	OHS3L	\$12,815.00
MSNS - LC (22 DS3) 60 Mo	2	OHS3L	\$13,118.00
MSNS - LC (23 DS3) 60 Mo	2	OHS3L	\$13,404.00
MSNS - LC (24 DS3) 60 Mo	2	OHS3L	\$13,670.00
MSNS - LC (25 DS3) 60 Mo	2	OHS3L	\$13,924.00
MSNS - LC (26 DS3) 60 Mo	2	OHS3L	\$14,160.00
MSNS - LC (27 DS3) 60 Mo	2	OHS3L	\$14,382.00
MSNS - LC (28 DS3) 60 Mo	2	OHS3L	\$14,591.00
MSNS - LC (29 DS3) 60 Mo	2	OHS3L	\$14,785.00
MSNS - LC (30 DS3) 60 Mo	2	OHS3L	\$14,970.00
MSNS - LC (31 DS3) 60 Mo	2	OHS3L	\$15,143.00
MSNS - LC (32 DS3) 60 Mo	2	OHS3L	\$15,305.00
MSNS - LC (33 DS3) 60 Mo	2	OHS3L	\$15,458.00
MSNS - LC (34 DS3) 60 Mo	2	OHS3L	\$15,604.00
MSNS - LC (35 DS3) 60 Mo	2	OHS3L	\$15,742.00
MSNS - LC (36 DS3) 60 Mo	2	OHS3L	\$15,871.00
MSNS - LC (37 DS3) 60 Mo	2	OHS3L	\$15,996.00

Material previously appeared on this page now appears in Section 30.

ISSUED: May 31, 2013

EFFECTIVE: July 2, 2013

BY: Marshall M. Criser III, President -FL  
Miami, Florida

**E23. METROPOLITAN STATISTICAL AREA**

**E23.5.1.1 Vintage Rates (Cont'd)**

**E23.51.1 (B) Cont'd**

BellSouth SWA Managed Shared Network Service

RATE ELEMENT	ZONE	USOC	Rates
MSNS - LC (38 DS3) 60 Mo	2	OHS3L	\$16,117.00
MSNS - LC (39 DS3) 60 Mo	2	OHS3L	\$16,234.00
MSNS - LC (40 DS3) 60 Mo	2	OHS3L	\$16,346.00
MSNS - LC (41 DS3) 60 Mo	2	OHS3L	\$16,458.00
MSNS - LC (42 DS3) 60 Mo	2	OHS3L	\$16,567.00
MSNS - LC (43 DS3) 60 Mo	2	OHS3L	\$16,676.00
MSNS - LC (44 DS3) 60 Mo	2	OHS3L	\$16,786.00
MSNS - LC (45 DS3) 60 Mo	2	OHS3L	\$16,896.00
MSNS - LC (46 DS3) 60 Mo	2	OHS3L	\$17,009.00
MSNS - LC (47 DS3) 60 Mo	2	OHS3L	\$17,125.00
MSNS - LC (48 DS3) 60 Mo	2	OHS3L	\$17,245.00
MSNS - LC (49 DS3) 60 Mo	2	OHS3L	\$17,605.00
MSNS - LC (50 DS3) 60 Mo	2	OHS3L	\$17,935.00
MSNS - LC (51 DS3) 60 Mo	2	OHS3L	\$18,235.00
MSNS - LC (52 DS3) 60 Mo	2	OHS3L	\$18,505.00
MSNS - LC (53 DS3) 60 Mo	2	OHS3L	\$18,625.00
MSNS - LC (54 DS3) 60 Mo	2	OHS3L	\$18,865.00
MSNS - LC (55 DS3) 60 Mo	2	OHS3L	\$19,075.00
MSNS - LC (56 DS3) 60 Mo	2	OHS3L	\$19,255.00
MSNS - LC (57 DS3) 60 Mo	2	OHS3L	\$19,375.00
MSNS - LC (58 DS3) 60 Mo	2	OHS3L	\$19,525.00
MSNS - LC (59 DS3) 60 Mo	2	OHS3L	\$19,645.00
MSNS - LC (60 DS3) 60 Mo	2	OHS3L	\$19,765.00
MSNS - LC (61 DS3) 60 Mo	2	OHS3L	\$20,185.00
MSNS - LC (62 DS3) 60 Mo	2	OHS3L	\$20,605.00
MSNS - LC (63 DS3) 60 Mo	2	OHS3L	\$21,025.00
MSNS - LC (64 DS3) 60 Mo	2	OHS3L	\$21,445.00
MSNS - LC (65 DS3) 60 Mo	2	OHS3L	\$21,865.00
MSNS - LC (66 DS3) 60 Mo	2	OHS3L	\$22,285.00
MSNS - LC (67 DS3) 60 Mo	2	OHS3L	\$22,705.00
MSNS - LC (68 DS3) 60 Mo	2	OHS3L	\$23,125.00
MSNS - LC (69 DS3) 60 Mo	2	OHS3L	\$23,545.00
MSNS - LC (70 DS3) 60 Mo	2	OHS3L	\$23,965.00
MSNS - LC (71 DS3) 60 Mo	2	OHS3L	\$24,385.00
MSNS - LC (72 DS3) 60 Mo	2	OHS3L	\$24,805.00

Material previously appeared on this page now appears in Section 30.

ISSUED: May 31, 2013

EFFECTIVE: July 2, 2013

BY: Marshall M. Criser III, President -FL  
Miami, Florida

**E23. METROPOLITAN STATISTICAL AREA**

**E23.5.1.1 Vintage Rates (Cont'd)**

**E23.51.1 (B) Cont'd**

BellSouth SWA Managed Shared Network Service

RATE ELEMENT	ZONE	USOC	Rates
MSNS - LC (73 DS3) 60 Mo	2	OHS3L	\$25,225.00
MSNS - LC (74 DS3) 60 Mo	2	OHS3L	\$25,645.00
MSNS - LC (75 DS3) 60 Mo	2	OHS3L	\$26,065.00
MSNS - LC (76 DS3) 60 Mo	2	OHS3L	\$26,485.00
MSNS - LC (77 DS3) 60 Mo	2	OHS3L	\$26,905.00
MSNS - LC (78 DS3) 60 Mo	2	OHS3L	\$27,325.00
MSNS - LC (79 DS3) 60 Mo	2	OHS3L	\$27,745.00
MSNS - LC (80 DS3) 60 Mo	2	OHS3L	\$28,165.00
MSNS - LC (81 DS3) 60 Mo	2	OHS3L	\$28,585.00
MSNS - LC (82 DS3) 60 Mo	2	OHS3L	\$29,005.00
MSNS - LC (83 DS3) 60 Mo	2	OHS3L	\$29,425.00
MSNS - LC (84 DS3) 60 Mo	2	OHS3L	\$29,845.00
MSNS - LC (85 DS3) 60 Mo	2	OHS3L	\$30,265.00
MSNS - LC (86 DS3) 60 Mo	2	OHS3L	\$30,685.00
MSNS - LC (87 DS3) 60 Mo	2	OHS3L	\$31,105.00
MSNS - LC (88 DS3) 60 Mo	2	OHS3L	\$31,525.00
MSNS - LC (89 DS3) 60 Mo	2	OHS3L	\$31,945.00
MSNS - LC (90 DS3) 60 Mo	2	OHS3L	\$32,365.00
MSNS - LC (91 DS3) 60 Mo	2	OHS3L	\$32,785.00
MSNS - LC (92 DS3) 60 Mo	2	OHS3L	\$33,205.00
MSNS - LC (93 DS3) 60 Mo	2	OHS3L	\$33,625.00
MSNS - LC (94 DS3) 60 Mo	2	OHS3L	\$34,045.00
MSNS - LC (95 DS3) 60 Mo	2	OHS3L	\$34,465.00
MSNS - LC (96 DS3) 60 Mo	2	OHS3L	\$34,885.00
MSNS - LC (97 DS3) 60 Mo	2	OHS3L	\$35,305.00
MSNS - LC (98 DS3) 60 Mo	2	OHS3L	\$35,725.00
MSNS - LC (99 DS3) 60 Mo	2	OHS3L	\$36,145.00
MSNS - LC (100 DS3) 60 Mo	2	OHS3L	\$36,565.00
MSNS - LC (101 DS3) 60 Mo	2	OHS3L	\$36,985.00
MSNS - LC (102 DS3) 60 Mo	2	OHS3L	\$37,405.00
MSNS - LC (103 DS3) 60 Mo	2	OHS3L	\$37,825.00
MSNS - LC (104 DS3) 60 Mo	2	OHS3L	\$38,245.00
MSNS - LC (105 DS3) 60 Mo	2	OHS3L	\$38,665.00
MSNS - LC (106 DS3) 60 Mo	2	OHS3L	\$39,085.00

Material previously appeared on this page now appears in Section 30.

ISSUED: May 31, 2013

EFFECTIVE: July 2, 2013

BY: Marshall M. Criser III, President -FL  
Miami, Florida

**E23. METROPOLITAN STATISTICAL AREA**

**E23.5.1.1 Vintage Rates (Cont'd)**

**E23.51.1 (B) Cont'd**

BellSouth SWA Managed Shared Network Service

RATE ELEMENT	ZONE	USOC	Rates
MSNS - LC (107 DS3) 60 Mo	2	OHS3L	\$39,505.00
MSNS - LC (108 DS3) 60 Mo	2	OHS3L	\$39,925.00
MSNS - LC (109 DS3) 60 Mo	2	OHS3L	\$40,345.00
MSNS - LC (110 DS3) 60 Mo	2	OHS3L	\$40,765.00
MSNS - LC (111 DS3) 60 Mo	2	OHS3L	\$41,185.00
MSNS - LC (112 DS3) 60 Mo	2	OHS3L	\$41,605.00
MSNS - LC (113 DS3) 60 Mo	2	OHS3L	\$42,025.00
MSNS - LC (114 DS3) 60 Mo	2	OHS3L	\$42,445.00
MSNS - LC (115 DS3) 60 Mo	2	OHS3L	\$42,865.00
MSNS - LC (116 DS3) 60 Mo	2	OHS3L	\$43,285.00
MSNS - LC (117 DS3) 60 Mo	2	OHS3L	\$43,705.00
MSNS - LC (118 DS3) 60 Mo	2	OHS3L	\$44,125.00
MSNS - LC (119 DS3) 60 Mo	2	OHS3L	\$44,545.00
MSNS - LC (120 DS3) 60 Mo	2	OHS3L	\$44,965.00
MSNS - LC (121 DS3) 60 Mo	2	OHS3L	\$45,385.00
MSNS - LC (122 DS3) 60 Mo	2	OHS3L	\$45,805.00
MSNS - LC (123 DS3) 60 Mo	2	OHS3L	\$46,225.00
MSNS - LC (124 DS3) 60 Mo	2	OHS3L	\$46,645.00
MSNS - LC (125 DS3) 60 Mo	2	OHS3L	\$47,065.00
MSNS - LC (126 DS3) 60 Mo	2	OHS3L	\$47,485.00
MSNS - LC (127 DS3) 60 Mo	2	OHS3L	\$47,905.00
MSNS - LC (128 DS3) 60 Mo	2	OHS3L	\$48,325.00
MSNS - LC (129 DS3) 60 Mo	2	OHS3L	\$48,745.00
MSNS - LC (130 DS3) 60 Mo	2	OHS3L	\$49,165.00
MSNS - LC (131 DS3) 60 Mo	2	OHS3L	\$49,585.00
MSNS - LC (132 DS3) 60 Mo	2	OHS3L	\$50,005.00
MSNS - LC (133 DS3) 60 Mo	2	OHS3L	\$50,425.00
MSNS - LC (134 DS3) 60 Mo	2	OHS3L	\$50,845.00
MSNS - LC (135 DS3) 60 Mo	2	OHS3L	\$51,265.00
MSNS - LC (136 DS3) 60 Mo	2	OHS3L	\$51,685.00
MSNS - LC (137 DS3) 60 Mo	2	OHS3L	\$52,105.00
MSNS - LC (138 DS3) 60 Mo	2	OHS3L	\$52,525.00
MSNS - LC (139 DS3) 60 Mo	2	OHS3L	\$52,945.00
MSNS - LC (140 DS3) 60 Mo	2	OHS3L	\$53,365.00

Material previously appeared on this page now appears in Section 30.

ISSUED: May 31, 2013

EFFECTIVE: July 2, 2013

BY: Marshall M. Criser III, President -FL  
Miami, Florida

**E23. METROPOLITAN STATISTICAL AREA**

**E23.5.1.1 Vintage Rates (Cont'd)**

**E23.51.1 (B) Cont'd**

BellSouth SWA Managed Shared Network Service

RATE ELEMENT	ZONE	USOC	Rates
MSNS - LC (141 DS3) 60 Mo	2	OHS3L	\$53,785.00
MSNS - LC (142 DS3) 60 Mo	2	OHS3L	\$54,205.00
MSNS - LC (143 DS3) 60 Mo	2	OHS3L	\$54,625.00
MSNS - LC (144 DS3) 60 Mo	2	OHS3L	\$55,045.00
MSNS - LC (145 DS3) 60 Mo	2	OHS3L	\$55,470.00
MSNS - LC (146 DS3) 60 Mo	2	OHS3L	\$55,890.00
MSNS - LC (147 DS3) 60 Mo	2	OHS3L	\$56,310.00
MSNS - LC (148 DS3) 60 Mo	2	OHS3L	\$56,730.00
MSNS - LC (149 DS3) 60 Mo	2	OHS3L	\$57,150.00
MSNS - LC (150 DS3) 60 Mo	2	OHS3L	\$57,570.00
MSNS - LC (151 DS3) 60 Mo	2	OHS3L	\$57,990.00
MSNS - LC (152 DS3) 60 Mo	2	OHS3L	\$58,410.00
MSNS - LC (153 DS3) 60 Mo	2	OHS3L	\$58,830.00
MSNS - LC (154 DS3) 60 Mo	2	OHS3L	\$59,250.00
MSNS - LC (155 DS3) 60 Mo	2	OHS3L	\$59,670.00
MSNS - LC (156 DS3) 60 Mo	2	OHS3L	\$60,090.00
MSNS - LC (157 DS3) 60 Mo	2	OHS3L	\$60,510.00
MSNS - LC (158 DS3) 60 Mo	2	OHS3L	\$60,930.00
MSNS - LC (159 DS3) 60 Mo	2	OHS3L	\$61,350.00
MSNS - LC (160 DS3) 60 Mo	2	OHS3L	\$61,770.00
MSNS - LC (161 DS3) 60 Mo	2	OHS3L	\$62,190.00
MSNS - LC (162 DS3) 60 Mo	2	OHS3L	\$62,610.00
MSNS - LC (163 DS3) 60 Mo	2	OHS3L	\$63,030.00
MSNS - LC (164 DS3) 60 Mo	2	OHS3L	\$63,450.00
MSNS - LC (165 DS3) 60 Mo	2	OHS3L	\$63,870.00
MSNS - LC (166 DS3) 60 Mo	2	OHS3L	\$64,290.00
MSNS - LC (167 DS3) 60 Mo	2	OHS3L	\$64,710.00
MSNS - LC (168 DS3) 60 Mo	2	OHS3L	\$65,130.00
MSNS - LC (169 DS3) 60 Mo	2	OHS3L	\$65,550.00
MSNS - LC (170 DS3) 60 Mo	2	OHS3L	\$65,970.00
MSNS - LC (171 DS3) 60 Mo	2	OHS3L	\$66,390.00
MSNS - LC (172 DS3) 60 Mo	2	OHS3L	\$66,810.00
MSNS - LC (173 DS3) 60 Mo	2	OHS3L	\$67,230.00
MSNS - LC (174 DS3) 60 Mo	2	OHS3L	\$67,650.00
MSNS - LC (175 DS3) 60 Mo	2	OHS3L	\$68,070.00

Material previously appeared on this page now appears in Section 30.



ISSUED: May 31, 2013

EFFECTIVE: July 2, 2013

BY: Marshall M. Criser III, President -FL  
Miami, Florida

**E23. METROPOLITAN STATISTICAL AREA**

**E23.5.1.1 Vintage Rates (Cont'd)**

**E23.51.1 (B) Cont'd**

BellSouth SWA Managed Shared Network Service

RATE ELEMENT	ZONE	USOC	Rates
MSNS - LC (176 DS3) 60 Mo	2	OHS3L	\$68,490.00
MSNS - LC (177 DS3) 60 Mo	2	OHS3L	\$68,910.00
MSNS - LC (178 DS3) 60 Mo	2	OHS3L	\$69,330.00
MSNS - LC (179 DS3) 60 Mo	2	OHS3L	\$69,750.00
MSNS - LC (180 DS3) 60 Mo	2	OHS3L	\$70,170.00
MSNS - LC (181 DS3) 60 Mo	2	OHS3L	\$70,590.00
MSNS - LC (182 DS3) 60 Mo	2	OHS3L	\$71,010.00
MSNS - LC (183 DS3) 60 Mo	2	OHS3L	\$71,430.00
MSNS - LC (184 DS3) 60 Mo	2	OHS3L	\$71,850.00
MSNS - LC (185 DS3) 60 Mo	2	OHS3L	\$72,270.00
MSNS - LC (186 DS3) 60 Mo	2	OHS3L	\$72,690.00
MSNS - LC (187 DS3) 60 Mo	2	OHS3L	\$73,110.00
MSNS - LC (188 DS3) 60 Mo	2	OHS3L	\$73,530.00
MSNS - LC (189 DS3) 60 Mo	2	OHS3L	\$73,950.00
MSNS - LC (190 DS3) 60 Mo	2	OHS3L	\$74,370.00
MSNS - LC (191 DS3) 60 Mo	2	OHS3L	\$74,790.00
MSNS - LC (192 DS3) 60 Mo	2	OHS3L	\$75,210.00
MSNS - LC (1 DS3) 60 Mo	3	OHS3L	\$4,730.00
MSNS - LC (2 DS3) 60 Mo	3	OHS3L	\$4,874.00
MSNS - LC (3 DS3) 60 Mo	3	OHS3L	\$5,018.00
MSNS - LC (4 DS3) 60 Mo	3	OHS3L	\$5,162.00
MSNS - LC (5 DS3) 60 Mo	3	OHS3L	\$5,882.00
MSNS - LC (6 DS3) 60 Mo	3	OHS3L	\$6,602.00
MSNS - LC (7 DS3) 60 Mo	3	OHS3L	\$7,417.00
MSNS - LC (8 DS3) 60 Mo	3	OHS3L	\$8,195.00
MSNS - LC (9 DS3) 60 Mo	3	OHS3L	\$8,936.00
MSNS - LC (10 DS3) 60 Mo	3	OHS3L	\$9,642.00
MSNS - LC (11 DS3) 60 Mo	3	OHS3L	\$10,315.00
MSNS - LC (12 DS3) 60 Mo	3	OHS3L	\$10,952.00
MSNS - LC (13 DS3) 60 Mo	3	OHS3L	\$11,558.00
MSNS - LC (14 DS3) 60 Mo	3	OHS3L	\$12,134.00
MSNS - LC (15 DS3) 60 Mo	3	OHS3L	\$12,679.00
MSNS - LC (16 DS3) 60 Mo	3	OHS3L	\$13,196.00
MSNS - LC (17 DS3) 60 Mo	3	OHS3L	\$13,685.00

Material previously appeared on this page now appears in Section 30.

ISSUED: May 31, 2013

EFFECTIVE: July 2, 2013

BY: Marshall M. Criser III, President -FL  
Miami, Florida

**E23. METROPOLITAN STATISTICAL AREA**

**E23.5.1.1 Vintage Rates (Cont'd)**

**E23.51.1 (B) Cont'd**

BellSouth SWA Managed Shared Network Service

RATE ELEMENT	ZONE	USOC	Rates
MSNS - LC (18 DS3) 60 Mo	3	OHS3L	\$14,146.00
MSNS - LC (19 DS3) 60 Mo	3	OHS3L	\$14,580.00
MSNS - LC (20 DS3) 60 Mo	3	OHS3L	\$14,990.00
MSNS - LC (21 DS3) 60 Mo	3	OHS3L	\$15,378.00
MSNS - LC (22 DS3) 60 Mo	3	OHS3L	\$15,742.00
MSNS - LC (23 DS3) 60 Mo	3	OHS3L	\$16,085.00
MSNS - LC (24 DS3) 60 Mo	3	OHS3L	\$16,404.00
MSNS - LC (25 DS3) 60 Mo	3	OHS3L	\$16,709.00
MSNS - LC (26 DS3) 60 Mo	3	OHS3L	\$16,992.00
MSNS - LC (27 DS3) 60 Mo	3	OHS3L	\$17,258.00
MSNS - LC (28 DS3) 60 Mo	3	OHS3L	\$17,509.00
MSNS - LC (29 DS3) 60 Mo	3	OHS3L	\$17,742.00
MSNS - LC (30 DS3) 60 Mo	3	OHS3L	\$17,964.00
MSNS - LC (31 DS3) 60 Mo	3	OHS3L	\$18,172.00
MSNS - LC (32 DS3) 60 Mo	3	OHS3L	\$18,366.00
MSNS - LC (33 DS3) 60 Mo	3	OHS3L	\$18,550.00
MSNS - LC (34 DS3) 60 Mo	3	OHS3L	\$18,725.00
MSNS - LC (35 DS3) 60 Mo	3	OHS3L	\$18,890.00
MSNS - LC (36 DS3) 60 Mo	3	OHS3L	\$19,045.00
MSNS - LC (37 DS3) 60 Mo	3	OHS3L	\$19,195.00
MSNS - LC (38 DS3) 60 Mo	3	OHS3L	\$19,340.00
MSNS - LC (39 DS3) 60 Mo	3	OHS3L	\$19,481.00
MSNS - LC (40 DS3) 60 Mo	3	OHS3L	\$19,615.00
MSNS - LC (41 DS3) 60 Mo	3	OHS3L	\$19,750.00
MSNS - LC (42 DS3) 60 Mo	3	OHS3L	\$19,880.00
MSNS - LC (43 DS3) 60 Mo	3	OHS3L	\$20,011.00
MSNS - LC (44 DS3) 60 Mo	3	OHS3L	\$20,143.00
MSNS - LC (45 DS3) 60 Mo	3	OHS3L	\$20,275.00
MSNS - LC (46 DS3) 60 Mo	3	OHS3L	\$20,411.00
MSNS - LC (47 DS3) 60 Mo	3	OHS3L	\$20,550.00
MSNS - LC (48 DS3) 60 Mo	3	OHS3L	\$20,694.00
MSNS - LC (49 DS3) 60 Mo	3	OHS3L	\$21,126.00
MSNS - LC (50 DS3) 60 Mo	3	OHS3L	\$21,522.00
MSNS - LC (51 DS3) 60 Mo	3	OHS3L	\$21,882.00
MSNS - LC (52 DS3) 60 Mo	3	OHS3L	\$22,206.00

Material previously appeared on this page now appears in Section 30.

ISSUED: May 31, 2013

EFFECTIVE: July 2, 2013

BY: Marshall M. Criser III, President -FL  
Miami, Florida

**E23. METROPOLITAN STATISTICAL AREA**

**E23.5.1.1 Vintage Rates (Cont'd)**

**E23.51.1 (B) Cont'd**

BellSouth SWA Managed Shared Network Service

RATE ELEMENT	ZONE	USOC	Rates
MSNS - LC (53 DS3) 60 Mo	3	OHS3L	\$22,350.00
MSNS - LC (54 DS3) 60 Mo	3	OHS3L	\$22,638.00
MSNS - LC (55 DS3) 60 Mo	3	OHS3L	\$22,890.00
MSNS - LC (56 DS3) 60 Mo	3	OHS3L	\$23,106.00
MSNS - LC (57 DS3) 60 Mo	3	OHS3L	\$23,250.00
MSNS - LC (58 DS3) 60 Mo	3	OHS3L	\$23,430.00
MSNS - LC (59 DS3) 60 Mo	3	OHS3L	\$23,574.00
MSNS - LC (60 DS3) 60 Mo	3	OHS3L	\$23,718.00
MSNS - LC (61 DS3) 60 Mo	3	OHS3L	\$24,225.00
MSNS - LC (62 DS3) 60 Mo	3	OHS3L	\$24,730.00
MSNS - LC (63 DS3) 60 Mo	3	OHS3L	\$25,235.00
MSNS - LC (64 DS3) 60 Mo	3	OHS3L	\$25,740.00
MSNS - LC (65 DS3) 60 Mo	3	OHS3L	\$26,245.00
MSNS - LC (66 DS3) 60 Mo	3	OHS3L	\$26,750.00
MSNS - LC (67 DS3) 60 Mo	3	OHS3L	\$27,255.00
MSNS - LC (68 DS3) 60 Mo	3	OHS3L	\$27,760.00
MSNS - LC (69 DS3) 60 Mo	3	OHS3L	\$28,265.00
MSNS - LC (70 DS3) 60 Mo	3	OHS3L	\$28,770.00
MSNS - LC (71 DS3) 60 Mo	3	OHS3L	\$29,275.00
MSNS - LC (72 DS3) 60 Mo	3	OHS3L	\$29,780.00
MSNS - LC (73 DS3) 60 Mo	3	OHS3L	\$30,285.00
MSNS - LC (74 DS3) 60 Mo	3	OHS3L	\$30,790.00
MSNS - LC (75 DS3) 60 Mo	3	OHS3L	\$31,295.00
MSNS - LC (76 DS3) 60 Mo	3	OHS3L	\$31,800.00
MSNS - LC (77 DS3) 60 Mo	3	OHS3L	\$32,305.00
MSNS - LC (78 DS3) 60 Mo	3	OHS3L	\$32,810.00
MSNS - LC (79 DS3) 60 Mo	3	OHS3L	\$33,315.00
MSNS - LC (80 DS3) 60 Mo	3	OHS3L	\$33,820.00
MSNS - LC (81 DS3) 60 Mo	3	OHS3L	\$34,325.00
MSNS - LC (82 DS3) 60 Mo	3	OHS3L	\$34,830.00
MSNS - LC (83 DS3) 60 Mo	3	OHS3L	\$35,335.00
MSNS - LC (84 DS3) 60 Mo	3	OHS3L	\$35,840.00
MSNS - LC (85 DS3) 60 Mo	3	OHS3L	\$36,345.00
MSNS - LC (86 DS3) 60 Mo	3	OHS3L	\$36,850.00
MSNS - LC (87 DS3) 60 Mo	3	OHS3L	\$37,355.00

Material previously appeared on this page now appears in Section 30.

ISSUED: May 31, 2013

EFFECTIVE: July 2, 2013

BY: Marshall M. Criser III, President -FL  
Miami, Florida

**E23. METROPOLITAN STATISTICAL AREA**

**E23.5.1.1 Vintage Rates (Cont'd)**

**E23.51.1 (B) Cont'd**

BellSouth SWA Managed Shared Network Service

RATE ELEMENT	ZONE	USOC	Rates
MSNS - LC (91 DS3) 60 Mo	3	OHS3L	\$39,375.00
MSNS - LC (92 DS3) 60 Mo	3	OHS3L	\$39,880.00
MSNS - LC (93 DS3) 60 Mo	3	OHS3L	\$40,385.00
MSNS - LC (94 DS3) 60 Mo	3	OHS3L	\$40,890.00
MSNS - LC (95 DS3) 60 Mo	3	OHS3L	\$41,395.00
MSNS - LC (96 DS3) 60 Mo	3	OHS3L	\$41,900.00
MSNS - LC (97 DS3) 60 Mo	3	OHS3L	\$42,405.00
MSNS - LC (98 DS3) 60 Mo	3	OHS3L	\$42,910.00
MSNS - LC (99 DS3) 60 Mo	3	OHS3L	\$43,415.00
MSNS - LC (100 DS3) 60 Mo	3	OHS3L	\$43,920.00
MSNS - LC (101 DS3) 60 Mo	3	OHS3L	\$44,425.00
MSNS - LC (102 DS3) 60 Mo	3	OHS3L	\$44,930.00
MSNS - LC (103 DS3) 60 Mo	3	OHS3L	\$45,435.00
MSNS - LC (104 DS3) 60 Mo	3	OHS3L	\$45,940.00
MSNS - LC (105 DS3) 60 Mo	3	OHS3L	\$46,445.00
MSNS - LC (106 DS3) 60 Mo	3	OHS3L	\$46,950.00
MSNS - LC (107 DS3) 60 Mo	3	OHS3L	\$47,455.00
MSNS - LC (108 DS3) 60 Mo	3	OHS3L	\$47,960.00
MSNS - LC (109 DS3) 60 Mo	3	OHS3L	\$48,465.00
MSNS - LC (110 DS3) 60 Mo	3	OHS3L	\$48,970.00
MSNS - LC (111 DS3) 60 Mo	3	OHS3L	\$49,475.00
MSNS - LC (112 DS3) 60 Mo	3	OHS3L	\$49,980.00
MSNS - LC (113 DS3) 60 Mo	3	OHS3L	\$50,485.00
MSNS - LC (114 DS3) 60 Mo	3	OHS3L	\$50,990.00
MSNS - LC (115 DS3) 60 Mo	3	OHS3L	\$51,495.00
MSNS - LC (116 DS3) 60 Mo	3	OHS3L	\$52,000.00
MSNS - LC (117 DS3) 60 Mo	3	OHS3L	\$52,505.00
MSNS - LC (118 DS3) 60 Mo	3	OHS3L	\$53,010.00
MSNS - LC (119 DS3) 60 Mo	3	OHS3L	\$53,515.00
MSNS - LC (120 DS3) 60 Mo	3	OHS3L	\$54,020.00
MSNS - LC (121 DS3) 60 Mo	3	OHS3L	\$54,525.00
MSNS - LC (122 DS3) 60 Mo	3	OHS3L	\$55,030.00
MSNS - LC (123 DS3) 60 Mo	3	OHS3L	\$55,535.00
MSNS - LC (124 DS3) 60 Mo	3	OHS3L	\$56,040.00
MSNS - LC (125 DS3) 60 Mo	3	OHS3L	\$56,545.00

Material previously appeared on this page now appears in Section 30.

ISSUED: May 31, 2013

EFFECTIVE: July 2, 2013

BY: Marshall M. Criser III, President -FL  
Miami, Florida

**E23. METROPOLITAN STATISTICAL AREA**

**E23.5.1.1 Vintage Rates (Cont'd)**

**E23.51.1 (B) Cont'd**

BellSouth SWA Managed Shared Network Service

RATE ELEMENT	ZONE	USOC	Rates
MSNS - LC (126 DS3) 60 Mo	3	OHS3L	\$57,050.00
MSNS - LC (127 DS3) 60 Mo	3	OHS3L	\$57,555.00
MSNS - LC (128 DS3) 60 Mo	3	OHS3L	\$58,060.00
MSNS - LC (129 DS3) 60 Mo	3	OHS3L	\$58,565.00
MSNS - LC (130 DS3) 60 Mo	3	OHS3L	\$59,070.00
MSNS - LC (131 DS3) 60 Mo	3	OHS3L	\$59,575.00
MSNS - LC (132 DS3) 60 Mo	3	OHS3L	\$60,080.00
MSNS - LC (133 DS3) 60 Mo	3	OHS3L	\$60,585.00
MSNS - LC (134 DS3) 60 Mo	3	OHS3L	\$61,090.00
MSNS - LC (135 DS3) 60 Mo	3	OHS3L	\$61,595.00
MSNS - LC (136 DS3) 60 Mo	3	OHS3L	\$62,100.00
MSNS - LC (137 DS3) 60 Mo	3	OHS3L	\$62,605.00
MSNS - LC (138 DS3) 60 Mo	3	OHS3L	\$63,110.00
MSNS - LC (139 DS3) 60 Mo	3	OHS3L	\$63,615.00
MSNS - LC (140 DS3) 60 Mo	3	OHS3L	\$64,120.00
MSNS - LC (141 DS3) 60 Mo	3	OHS3L	\$64,625.00
MSNS - LC (142 DS3) 60 Mo	3	OHS3L	\$65,130.00
MSNS - LC (143 DS3) 60 Mo	3	OHS3L	\$65,635.00
MSNS - LC (144 DS3) 60 Mo	3	OHS3L	\$66,140.00
MSNS - LC (145 DS3) 60 Mo	3	OHS3L	\$66,645.00
MSNS - LC (146 DS3) 60 Mo	3	OHS3L	\$67,150.00
MSNS - LC (147 DS3) 60 Mo	3	OHS3L	\$67,655.00
MSNS - LC (148 DS3) 60 Mo	3	OHS3L	\$68,160.00
MSNS - LC (149 DS3) 60 Mo	3	OHS3L	\$68,665.00
MSNS - LC (150 DS3) 60 Mo	3	OHS3L	\$69,170.00
MSNS - LC (151 DS3) 60 Mo	3	OHS3L	\$69,675.00
MSNS - LC (152 DS3) 60 Mo	3	OHS3L	\$70,180.00
MSNS - LC (153 DS3) 60 Mo	3	OHS3L	\$70,685.00
MSNS - LC (154 DS3) 60 Mo	3	OHS3L	\$71,190.00
MSNS - LC (155 DS3) 60 Mo	3	OHS3L	\$71,695.00
MSNS - LC (156 DS3) 60 Mo	3	OHS3L	\$72,200.00
MSNS - LC (157 DS3) 60 Mo	3	OHS3L	\$72,705.00
MSNS - LC (158 DS3) 60 Mo	3	OHS3L	\$73,210.00
MSNS - LC (159 DS3) 60 Mo	3	OHS3L	\$73,715.00

Material previously appeared on this page now appears in Section 30.

ISSUED: May 31, 2013

EFFECTIVE: July 2, 2013

BY: Marshall M. Criser III, President -FL  
Miami, Florida

**E23. METROPOLITAN STATISTICAL AREA**

**E23.5.1.1 Vintage Rates (Cont'd)**

**E23.51.1 (B) Cont'd**

BellSouth SWA Managed Shared Network Service

RATE ELEMENT	ZONE	USOC	Rates
MSNS - LC (160 DS3) 60 Mo	3	OHS3L	\$74,120.00
MSNS - LC (161 DS3) 60 Mo	3	OHS3L	\$74,630.00
MSNS - LC (162 DS3) 60 Mo	3	OHS3L	\$75,130.00
MSNS - LC (163 DS3) 60 Mo	3	OHS3L	\$75,640.00
MSNS - LC (164 DS3) 60 Mo	3	OHS3L	\$76,140.00
MSNS - LC (165 DS3) 60 Mo	3	OHS3L	\$76,640.00
MSNS - LC (166 DS3) 60 Mo	3	OHS3L	\$77,150.00
MSNS - LC (167 DS3) 60 Mo	3	OHS3L	\$77,650.00
MSNS - LC (168 DS3) 60 Mo	3	OHS3L	\$78,160.00
MSNS - LC (169 DS3) 60 Mo	3	OHS3L	\$78,660.00
MSNS - LC (170 DS3) 60 Mo	3	OHS3L	\$79,160.00
MSNS - LC (171 DS3) 60 Mo	3	OHS3L	\$79,670.00
MSNS - LC (172 DS3) 60 Mo	3	OHS3L	\$80,170.00
MSNS - LC (173 DS3) 60 Mo	3	OHS3L	\$80,680.00
MSNS - LC (174 DS3) 60 Mo	3	OHS3L	\$81,180.00
MSNS - LC (175 DS3) 60 Mo	3	OHS3L	\$81,680.00
MSNS - LC (176 DS3) 60 Mo	3	OHS3L	\$82,190.00
MSNS - LC (177 DS3) 60 Mo	3	OHS3L	\$82,690.00
MSNS - LC (178 DS3) 60 Mo	3	OHS3L	\$83,200.00
MSNS - LC (179 DS3) 60 Mo	3	OHS3L	\$83,700.00
MSNS - LC (180 DS3) 60 Mo	3	OHS3L	\$84,200.00
MSNS - LC (181 DS3) 60 Mo	3	OHS3L	\$84,710.00
MSNS - LC (182 DS3) 60 Mo	3	OHS3L	\$85,210.00
MSNS - LC (183 DS3) 60 Mo	3	OHS3L	\$85,720.00
MSNS - LC (184 DS3) 60 Mo	3	OHS3L	\$86,220.00
MSNS - LC (185 DS3) 60 Mo	3	OHS3L	\$86,720.00
MSNS - LC (186 DS3) 60 Mo	3	OHS3L	\$87,230.00
MSNS - LC (187 DS3) 60 Mo	3	OHS3L	\$87,730.00
MSNS - LC (188 DS3) 60 Mo	3	OHS3L	\$88,240.00
MSNS - LC (189 DS3) 60 Mo	3	OHS3L	\$88,740.00
MSNS - LC (190 DS3) 60 Mo	3	OHS3L	\$89,240.00
MSNS - LC (191 DS3) 60 Mo	3	OHS3L	\$89,750.00
MSNS - LC (192 DS3) 60 Mo	3	OHS3L	\$90,250.00

Material previously appeared on this page now appears in Section 30.

ISSUED: May 31, 2013

BY: Marshall M. Criser III, President -FL  
Miami, Florida

## E23. METROPOLITAN STATISTICAL AREA

### E23.5.2 BellSouth SPA Service

Special Access pricing flexibility is not available in the intrastate jurisdiction.

### E23.5.3 Fast Packet Access Services

Fast Packet pricing flexibility is not available in the intrastate jurisdiction.

(C)

(C)

Material previously appeared on this page now appears in Section 30.

ISSUED: May 31, 2013

EFFECTIVE: July 2, 2013

BY: Marshall M. Criser III, President -FL  
Miami, Florida

### **E23. METROPOLITAN STATISTICAL AREA**

All Material has been deleted from the page listed below. These pages do not contain any information on Services or Products.

Page	Revision	Cancels Revision
24	1	Original
25	1	Original
26	1	Original
27	1	Original
28	1	Original
29	1	Original
30	1	Original
31	1	Original
32	1	Original
33	1	Original
34	1	Original
35	1	Original



BELLSOUTH  
TELECOMMUNICATIONS, INC.  
FLORIDA

ACCESS SERVICES TARIFF

Original Page 1

ISSUED: November 4, 1997

EFFECTIVE: November 19, 1997

BY: Joseph P. Lacher, President -FL  
Miami, Florida

## **E24. RESERVED FOR FUTURE USE**

(N)

CONTENTS

(N)

BELLSOUTH  
TELECOMMUNICATIONS, INC.  
FLORIDA  
ISSUED: November 4, 1997  
BY: Joseph P. Lacher, President -FL  
Miami, Florida

ACCESS SERVICES TARIFF

Original Page 1

EFFECTIVE: November 19, 1997

**E25. RESERVED FOR FUTURE USE**

(N)

CONTENTS

(N)

## E26. BELLSOUTH SWA CONTRACT TARIFFS

### CONTENTS

<b>E26.1</b>	<b>BellSouth SWA Contract Tariff No. FL2002-01 (Obsoleted, See Section E126)</b>	1	
<b>E26.2</b>	<b>BellSouth SWA Contract Tariff No. FL2003-01</b>	5	
E26.2.1	General Regulations	5	
E26.2.2	Subscription Conditions	5	
E26.2.3	Mergers and Acquisitions and Transfer of Service	6	
E26.2.4	BellSouth SWA Revenue Volume Discounts	7	
E26.2.5	BellSouth SWA Contract Tariff No. FL2003-01 Volume Discount Plan	7	
<b>E26.3</b>	<b>BellSouth SWA Contract Tariff No. FL2005-01</b>	9	
E26.3.1	General Regulations	9	
E26.3.2	Subscription Conditions	9	
E26.3.3	Mergers and Acquisitions and Transfer of Service	10	
E26.3.4	BellSouth SWA Revenue Volume Discounts	10	
E26.3.5	BellSouth SWA Contract Tariff No. FL2005-01 Volume Discount Plan	11	
<b>E26.4</b>	<b>BellSouth SWA Contract Tariff No. FL2005-02</b>	13	(N)
E26.4.1	General Regulations	13	(N)
E26.4.2	Subscription Conditions	13	(N)
E26.4.3	Mergers and Acquisitions and Transfer of Service	14	(N)
E26.4.4	BellSouth SWA Revenue Volume Discounts	14	(N)
E26.4.5	BellSouth SWA Contract Tariff No. FL2005-02 Volume Discount Plan	15	(N)

BELLSOUTH  
TELECOMMUNICATIONS, INC.  
FLORIDA  
ISSUED: March 16, 2004  
BY: Joseph P. Lacher, President -FL  
Miami, Florida

ACCESS SERVICES TARIFF

First Revised Page 1  
Cancels Original Page 1

EFFECTIVE: March 31, 2004

**E26. BELLSOUTH SWA CONTRACT TARIFFS**

**E26.1 BellSouth SWA Contract Tariff No. FL2002-01 – Obsoleted (See Section E126)**

(0)

BELLSOUTH  
TELECOMMUNICATIONS, INC.  
FLORIDA

ACCESS SERVICES TARIFF

First Revised Page 2  
Cancels Original Page 2

ISSUED: March 16, 2004  
BY: Joseph P. Lacher, President -FL  
Miami, Florida

EFFECTIVE: March 31, 2004

**E26. BELLSOUTH SWA CONTRACT TARIFFS**

**E26.1 BellSouth SWA Contract Tariff No. FL2002-01 – Obsoleted (See Section E126)**  
**(Cont'd)**

(0)

BELLSOUTH  
TELECOMMUNICATIONS, INC.  
FLORIDA  
ISSUED: March 16, 2004  
BY: Joseph P. Lacher, President -FL  
Miami, Florida

ACCESS SERVICES TARIFF

First Revised Page 3  
Cancels Original Page 3

EFFECTIVE: March 31, 2004

**E26. BELLSOUTH SWA CONTRACT TARIFFS**

**E26.1 BellSouth SWA Contract Tariff No. FL2002-01 – Obsoleted (See Section E126)**  
**(Cont'd)**

(0)

BELLSOUTH  
TELECOMMUNICATIONS, INC.  
FLORIDA

ACCESS SERVICES TARIFF

First Revised Page 4  
Cancels Original Page 4

ISSUED: March 16, 2004  
BY: Joseph P. Lacher, President -FL  
Miami, Florida

EFFECTIVE: March 31, 2004

**E26. BELLSOUTH SWA CONTRACT TARIFFS**

**E26.1 BellSouth SWA Contract Tariff No. FL2002-01 - Obsoleted (See Section E126)  
(Cont'd)**

(0)

**E26. BELLSOUTH SWA CONTRACT TARIFFS**

**E26.2 BellSouth SWA Contract Tariff No. FL2003-01**

**E26.2.1 General Regulations**

- A. The start date of BellSouth SWA Contract Tariff No. FL2003-01 is the first bill period following execution of the Letter of Agreement with the customer. (N)
- B. Customers may choose either a one or two year agreement that terminates upon completion. (N)
- C. The regulations, terms, conditions and volume discounts provided herein shall apply to the customer's applicable BellSouth SWA usage and revenues achieved in the state of Florida. (N)

**E26.2.2 Subscription Conditions**

- A. To subscribe to BellSouth SWA Contract Tariff No. FL2003-01, the customer and BellSouth must execute a Letter of Agreement. BellSouth shall provide a Letter of Agreement for the customer to execute. The Letter of Agreement shall contain:
  - 1. BellSouth SWA Contract Tariff No. FL2003-01 tariff reference (N)
  - 2. Start and termination date (N)
  - 3. Customer's name and billing address (N)
  - 4. Billing Account Number the credit will be applied (N)
  - 5. Access Customer Name Abbreviations (ACNAs) and Customer Identifications Codes (CICs) to be included in the BellSouth SWA Contract Tariff No. FL2003-01 (N)
  - 6. BellSouth SWA Contract Tariff No. FL2003-01 term (i.e., one or two years) (N)
  - 7. Commitment Level usage (N)
- B. To subscribe to BellSouth SWA Contract Tariff No. FL2003-01, the customer must have been a BellSouth SWA customer for the previous 12 months. (N)
- C. The customer's most recent twelve (12) months local switching usage will be projected forward for twelve (12) months. The customer's annual usage commitment level will be a minimum of 90 percent of this projection. (N)
- D. When the customer subscribes to BellSouth SWA Contract Tariff No. FL2003-01, the customer must identify to the Telephone Company, all Access Customer Name Abbreviations (ACNAs) and Carrier Identification Codes (CICs) to be included in BellSouth SWA Contract Tariff No. FL2003-01. (N)
- E. The customer must be the billing responsible party for all BellSouth SWA billing elements associated with the ACNAs and CICs included in the Letter of Agreement. (N)
- F. Any additions after the Letter of Agreement is executed will be handled as a merger or acquisition or transfer of service regulations as set forth in E26.2.3 following. (N)
- G. A customer subscribing to BellSouth SWA Contract Tariff No. FL2003-01 may not subscribe to any other BellSouth SWA Contract Tariff for the services as set forth in H. following. (N)
- H. The following BellSouth SWA services will be used in determining the BellSouth SWA revenues that are eligible to receive the volume discount based on the established local switching usage Commitment Level.
  - 1. Local Switching (N)
    - Local Switching 1 (N)
    - Local Switching 2 (N)
    - Local Switching 3 (N)
    - Local Switching 4 (N)
- I. A customer may not combine its local switching minutes of use with another customer, whether an individual, partnership, association or corporation, for the purpose of meeting the established minimum local switching usage, as set forth in E26.2.5.B. following. (N)



ISSUED: August 20, 2003  
BY: Joseph P. Lacher, President -FL  
Miami, Florida

EFFECTIVE: September 4, 2003

## E26. BELLSOUTH SWA CONTRACT TARIFFS

### E26.2 BellSouth SWA Contract Tariff No. FL2003-01 (Cont'd)

#### E26.2.2 Subscription Conditions (Cont'd)

- J. Cancellation of BellSouth SWA Contract Tariff No. FL2003-01
  - 1. Except as set forth in 2. following, during the term period of BellSouth SWA Contract Tariff No. FL2003-01 as defined by the customer's Letter of Agreement, a customer who cancels this BellSouth Contract Tariff No. FL2003-01 is subject to shortfall and termination liability as described in E26.2.5, following.
  - 2. A customer who cancels this BellSouth SWA Contract Tariff No. FL2003-01 under this paragraph is subject only to shortfall calculations of E26.2.5, following. Cancellation of BellSouth SWA Contract Tariff No. FL2003-01 and subscription to another BellSouth SWA Contract Tariff is allowed only on the anniversary date as defined by the customer's Letter of Agreement and upon meeting the condition below. At a minimum, the term of the new Letter of Agreement will be the remaining term of the initial Letter of Agreement.
    - a. Customer adds CIC codes that are desired to become part of the volume discount contract tariff.
- K. The services to which the incentives set forth in this BellSouth SWA Contract Tariff No. FL2003-01 apply, are obtained from Section E6. of this Tariff. BellSouth reserves the right to change the terms, conditions, rates, and charges applicable for services in Section E6 or other sections of this Tariff during the term of this Contract Tariff unless otherwise specified in this Contract Tariff. General regulations and ordering options for the BellSouth SWA services are as set forth in Sections E2. and E5. of this Tariff.

#### E26.2.3 Mergers and Acquisitions and Transfer of Service

- A. In the event the customer merges with another company or is acquired by another company; the following regulations will apply:
  - 1. The customer may elect to terminate subscription to BellSouth SWA Contract Tariff No. FL2003-01. A customer who cancels subscription to BellSouth SWA Contract Tariff No. FL2003-01 is subject to shortfall and termination liability as described in E26.2.5, following.
  - 2. The customer may not combine revenues with the merged or acquired company's revenues for the purpose of obtaining volume discounts provided under BellSouth SWA Contract Tariff No. FL2003-01.
  - 3. The customer may continue subscribing to BellSouth SWA Contract Tariff No. FL2003-01 for the duration of the term provided that the customer continues the subscription as if it were the same entity that existed prior to the merger or acquisition.
- B. If customer requests a transfer of service, pursuant to Transfer of Service regulations in Sections E2. and E6. of this Tariff, the customer's subscription to BellSouth SWA Contract Tariff No. FL2003-01 shall be terminated.

**E26. BELLSOUTH SWA CONTRACT TARIFFS** (N)

**E26.2 BellSouth SWA Contract Tariff No. FL2003-01 (Cont'd)** (N)

**E26.2.4 BellSouth SWA Revenue Volume Discounts** (N)

- A. Each year of the customer's Letter of Agreement is defined as twelve (12) consecutive bill periods following the beginning date of the Letter of Agreement. For purposes of calculating the BellSouth SWA volume discounts, month one (1) is the first complete bill period after the beginning date of the Letter of Agreement. For example, if the beginning date of the Letter of Agreement is June 6, 2003 bill period, and the bill period is the twelfth, then month one (1) for purposes of calculating the BellSouth SWA volume discounts will be the July 12, 2003 bill period. (N)
- B. The BellSouth SWA Pricing Flexibility volume discounts provided herein will be determined during the first month after the end of each year of the customer's Letter of Agreement. During the second month following the end of each year of the Letter of Agreement, the BellSouth SWA volume discounts will be applied via a credit to the customer's bill. (N)
- C. The BellSouth SWA volume discounts are applicable to the BellSouth SWA services as set forth in E26.2.2.H. preceding. (N)
- D. The BellSouth SWA volume discounts specified in BellSouth SWA Contract Tariff No. FL2003-01 will not be applied to taxes and nonrecurring BellSouth SWA revenues. (N)

**E26.2.5 BellSouth SWA Contract Tariff No. FL2003-01 Volume Discount Plan** (N)

- A. BellSouth SWA Contract Tariff No. FL2003-01 provides for annual volume discounts based upon annual local switching minutes of use (MOU) above a stated minimum usage achieved, and the Commitment Level and term year as defined in the Letter of Agreement. Discounts are achieved in term years when the achieved local switching volume is equal to or above a Commitment Level usage. When equaled or exceeded, discounts are applied to the Commitment Level usage. (N)
- B. The Commitment Level usage and the achievable volume discounts associated with the BellSouth SWA services are shown in the table below. Volume discounts are not applicable to any usage levels outside of the MOU usage ranges stated in table below: (N)

Annual Usage Commitment Level and Discounts		
Commitment Level MOUs	Year 1 Discounts	Year 2 Discounts
> 170M to 340M	0.7%	1.2%
> 340M to 1.02B	1.3%	1.8%
> 1.02B to 1.7B	2.7%	3.2%
> 1.7B to 2.38B	4.0%	4.5%
> 2.38B to 3.06	5.4%	5.9%
> 3.06B	6.7%	7.2%

- C. The volume discount received for a given year under BellSouth SWA Contract Tariff No. FL2003-01 is determined by multiplying the eligible BellSouth SWA revenue associated with the Commitment Level usage, times the discount percentage achieved as determined in A. preceding. (N)

The following example demonstrates application of the discount: (N)

- Customer Annual Commitment Level – 1.02B minutes of use (N)
- Achieved Volume – 1.05B minutes of use (N)
- Contract Year – first year of a one-year contract (N)
- All usage is Local Switching 2 (N)
- Local Switching 2 rate - \$.008661/minute (N)
- From Table – applicable discount is 2.7 percent (N)

Therefore: (N)

Volume Discount = Eligible Revenue X Discount Rate (N)

Volume Discount = (1.02B minutes X \$.008661/minute) X 2.7 percent (N)

Volume Discount = \$238,524 (N)

**E26. BELLSOUTH SWA CONTRACT TARIFFS**

**E26.2 BellSouth SWA Contract Tariff No. FL2003-01 (Cont'd)**

**E26.2.5 BellSouth SWA Contract Tariff No. FL2003-01 Volume Discount Plan (Cont'd)**

- D. When the Commitment Level usage volume is not met during a year of the term, a shortfall liability is incurred by the customer. The shortfall usage is equal to the difference in the customer's Commitment Level and the achieved local switching usage volume. The shortfall liability would be equal to the shortfall usage, times the customer's average local switching rate per MOU. The customer's average local switching rate per MOU is equal to revenue generated from the local switching usage rate elements as described in E26.2.2.H preceding, divided by the achieved local switching usage volume.

The following example demonstrates application of shortfall:

Customer Annual Commitment Level – 1.02B minutes of use

Achieved Volume – 1B minutes of use

Contract Year – first year of a one-year contract

All usage is Local Switching 2

Local Switching 2 rate - \$.008661/minute

Therefore:

Shortfall Usage = Commitment Level – Achieved Volume

Shortfall Usage = 1.02B minutes – 1.02B minutes

Shortfall Usage = .02B minutes

Shortfall Liability = Shortfall Usage X Avg Local Switching Rate

Shortfall Liability = .02B minutes X \$.008661/minute

Shortfall Liability = \$173,220

- E. In the event of an early termination of the contract, shortfall usage calculations will be based upon the monthly usage values which comprise the annual Commitment Level. If upon comparing the shortened term commitment to the achieved usage level, a shortfall usage is determined to exist, then a shortfall liability is incurred. The shortfall liability will be calculated as described in D. above.
- F. A termination liability is incurred when a customer terminates the agreement before the end date of the agreement. The termination liability is equal to 90 percent of the volume discount received during the term of the agreement.
- G. This BellSouth SWA Contract Tariff No. FL2003-01 will also provide, as a one-time promotional offer, that the customer may obtain a partial prepayment of the first annual SWA Pricing Flexibility volume discount. To qualify for this prepayment, the customer must subscribe to this plan via a Letter of Agreement (LOA) to begin no later than 30 days after the effective date of the tariff. Using the customer's usage between the commencement of this LOA and December 4, 2003, BellSouth will determine if the customer is on track to earn the discount described at the end of the first year of the LOA. If so, BellSouth will calculate by December 15, 2003, the prorated volume discount and remit to the subscriber the prepayment of this pro rata volume discount as soon as practical thereafter. At the end of the first year of the LOA, if an annual credit has been earned, the prepayment will be subtracted from this annual volume discount amount. If, at the end of the first year, the volume discount has not been earned, then the prepayment shall be returned to BellSouth with interest calculated for the period during which the prepayment was held by the customer (Interest equals prime plus two percent – the prime interest rate is that rate which is effective at the end of the first year of the LOA.).

ISSUED: July 8, 2005  
BY: Marshall M. Criser III, President -FL  
Miami, Florida

EFFECTIVE: August 7, 2005

## E26. BELLSOUTH SWA CONTRACT TARIFFS

(N)

### E26.3 BellSouth SWA Contract Tariff No. FL2005-01

(N)

#### E26.3.1 General Regulations

(N)

- A. The start date of BellSouth SWA Contract Tariff No. FL2005-01 is the first bill period following execution of the Letter of Agreement with the customer. (N)
- B. The BellSouth SWA Contract Tariff No. FL2005-01 is a one (1) year agreement that terminates upon completion. (N)
- C. The regulations, terms, conditions and volume discounts provided herein shall apply to the customer's applicable BellSouth SWA usage and revenues achieved in the state of Florida. (N)

#### E26.3.2 Subscription Conditions

(N)

- A. To subscribe to BellSouth SWA Contract Tariff No. FL2005-01, the customer and BellSouth must execute a Letter of Agreement. BellSouth shall provide a Letter of Agreement for the customer to execute. The Letter of Agreement shall contain:
  - 1. BellSouth SWA Contract Tariff No. FL2005-01 tariff reference (N)
  - 2. Start and termination date (N)
  - 3. Customer's name and billing address (N)
  - 4. Billing Account Number the credit will be applied (N)
  - 5. Access Customer Name Abbreviations (ACNAs) and Customer Identifications Codes (CICs) to be included in the BellSouth SWA Contract Tariff No. FL2005-01 (N)
  - 6. BellSouth SWA Contract Tariff No. FL2005-01 term (N)
  - 7. Commitment Level usage (N)
- B. To subscribe to BellSouth SWA Contract Tariff No. FL2005-01, the customer must have been a BellSouth SWA customer for the previous twelve (12) months. (N)
- C. The customer's most recent twelve (12) months local switching usage will be projected forward for twelve (12) months. The customer's annual usage commitment level will be a minimum of ninety-five percent (95%) of this projection. Commitment levels ranging from ninety-five percent (95%) through less than ninety-eight (98%) of this projection are subject to the shortfall calculations as described in E26.3.5.E. following when commitment levels are not attained. For commitment levels ninety-eight percent (98%) or greater, shortfall liabilities will not apply unless the customer cancels this BellSouth SWA Contract Tariff No. FL2005-01. (N)
- D. When the customer subscribes to BellSouth SWA Contract Tariff No. FL2005-01, the customer must identify to the Telephone Company, all Access Customer Name Abbreviations (ACNAs) and Carrier Identification Codes (CICs) to be included in BellSouth SWA Contract Tariff No. FL2005-01. (N)
- E. The customer must be the billing responsible party for all BellSouth SWA billing elements associated with the ACNAs and CICs included in the Letter of Agreement. (N)
- F. Any additions after the Letter of Agreement is executed will be handled as a merger or acquisition or transfer of service regulations as set forth in E26.3.3 following. (N)
- G. A customer subscribing to BellSouth SWA Contract Tariff No. FL2005-01 may not subscribe to any other BellSouth SWA Contract Tariff for the services as set forth in H. following. (N)
- H. The following BellSouth SWA services will be used in determining the BellSouth SWA revenues that are eligible to receive the volume discount based on the established local switching usage Commitment Level. (N)
  - I. Local Switching (N)
    - Local Switching 1 (N)
    - Local Switching 2 (N)
    - Local Switching 3 (N)
    - Local Switching 4 (N)
  - I. A customer may not combine its local switching minutes of use with another customer, whether an individual, partnership, association or corporation, for the purpose of meeting the established minimum local switching usage, as set forth in E26.3.5.B. following. (N)

FLORIDA

ISSUED: July 8, 2005

EFFECTIVE: August 7, 2005

BY: Marshall M. Criser III, President -FL  
Miami, Florida

## E26. BELLSOUTH SWA CONTRACT TARIFFS

### E26.3 BellSouth SWA Contract Tariff No. FL2005-01 (Cont'd)

#### E26.3.2 Subscription Conditions (Cont'd)

- J. Cancellation of BellSouth SWA Contract Tariff No. FL2005-01
  - 1. Except as set forth in 2. following, during the term period of BellSouth SWA Contract Tariff No. FL2005-01 as defined by the customer's Letter of Agreement, a customer who cancels this BellSouth SWA Contract Tariff No. FL2005-01 is subject to shortfall and termination liability as described in E26.3.5. following.
  - 2. A customer who cancels this BellSouth SWA Contract Tariff No. FL2005-01 under this paragraph is subject only to shortfall calculations of E26.3.5. following. Cancellation of BellSouth SWA Contract Tariff No. FL2005-01 and subscription to another BellSouth SWA Contract Tariff is allowed only on the anniversary date as defined by the customer's Letter of Agreement and upon meeting the condition below. At a minimum, the term of the new Letter of Agreement will be the remaining term of the initial Letter of Agreement.
    - a. Customer adds CIC codes that are desired to become part of the volume discount contract tariff.
- K. The services to which the incentives set forth in this BellSouth SWA Contract Tariff No. FL2005-01 apply, are obtained from Section E6. of this Tariff. BellSouth reserves the right to change the terms, conditions, rates, and charges applicable for services in Section E6 or other sections of this Tariff during the term of this Contract Tariff unless otherwise specified in this Contract Tariff. General regulations and ordering options for the BellSouth SWA services are as set forth in Sections E2. and E5. of this Tariff.

#### E26.3.3 Mergers and Acquisitions and Transfer of Service

- A. In the event the customer merges with another company or is acquired by another company; the following regulations will apply:
  - 1. The customer may elect to terminate subscription to BellSouth SWA Contract Tariff No. FL2005-01. A customer who cancels subscription to BellSouth SWA Contract Tariff No. FL2005-01 is subject to shortfall and termination liability as described in E26.3.5. following.
  - 2. The customer may not combine revenues with the merged or acquired company's revenues for the purpose of obtaining volume discounts provided under BellSouth SWA Contract Tariff No. FL2005-01.
  - 3. The customer may continue subscribing to BellSouth SWA Contract Tariff No. FL2005-01 for the duration of the term provided that the customer continues the subscription as if it were the same entity that existed prior to the merger or acquisition.
- B. If customer requests a transfer of service, pursuant to Transfer of Service regulations in Sections E2. and E6. of this Tariff, the customer's subscription to BellSouth SWA Contract Tariff No. FL2005-01 shall be terminated.

#### E26.3.4 BellSouth SWA Revenue Volume Discounts

- A. The year of the customer's Letter of Agreement is defined as twelve (12) consecutive bill periods following the beginning date of the Letter of Agreement. For purposes of calculating the BellSouth SWA volume discounts, month one (1) is the first complete bill period after the beginning date of the Letter of Agreement. For example, if the beginning date of the Letter of Agreement is June 6, 2005 bill period, and the bill period is the twelfth, then month one (1) for purposes of calculating the BellSouth SWA volume discounts will be the July 12, 2005 bill period.
- B. The BellSouth SWA Pricing Flexibility volume discounts provided herein will be determined during the first month after the end of the year of the customer's Letter of Agreement. During the second month following the end of the year of the Letter of Agreement, the BellSouth SWA volume discounts will be applied via a credit to the customer's bill.
- C. The BellSouth SWA volume discounts are applicable to the BellSouth SWA services as set forth in E26.3.2.H. preceding.
- D. The BellSouth SWA volume discounts specified in BellSouth SWA Contract Tariff No. FL2005-01 will not be applied to taxes and nonrecurring BellSouth SWA revenues.

ISSUED: July 8, 2005

EFFECTIVE: August 7, 2005

BY: Marshall M. Criser III, President -FL  
Miami, Florida

**E26. BELLSOUTH SWA CONTRACT TARIFFS**

(N)

**E26.3 BellSouth SWA Contract Tariff No. FL2005-01 (Cont'd)**

(N)

**E26.3.5 BellSouth SWA Contract Tariff No. FL2005-01 Volume Discount Plan**

(N)

- A. BellSouth SWA Contract Tariff No. FL2005-01 provides for annual volume discounts based upon annual local switching minutes of use (MOU) above a stated minimum usage achieved, and the Commitment Level and term year as defined in the Letter of Agreement. Discounts are achieved in term year when the achieved local switching volume is equal to or above a Commitment Level usage. When equaled or exceeded, discounts are applied to the Commitment Level usage. (N)
- B. The Commitment Level usage and the achievable volume discounts associated with the BellSouth SWA services are shown in the table below. Volume discounts are not applicable to any usage levels outside of the MOU usage ranges stated in table below: (N)
- C. The Commitment Level usage and the achievable volume discounts associated with the BellSouth SWA Common Transport IP Option, which allows termination or origination (when/where available and capacity permits) of Internet Protocol (IP) traffic, are shown in the table below. The SWA Common Transport IP Option discount will be in addition to the discount obtained from the BellSouth SWA services as described in E26.3.5.B. preceding. Only SWA Common Transport IP Option MOU eligible for the discounts as described in the table for Additional SWA Common Transport IP Option Discounts. Volume discounts are not applicable to any usage levels outside of the MOU usage ranges stated in the table below containing Additional SWA Common Transport IP Option Discounts. (N)

Annual Usage Commitment Level and Discounts		
Commitment Level MOUs	BellSouth SWA services discounts as described on E26.3.5.A.	Additional SWA Common Transport IP Option Discounts as described in E26.3.5.C.
> 100M to 250M	0.7%	15.7%
> 250M to 450M	1.3%	15.7%
> 450M to 500M	1.3%	15.7%
> 500M to 1B	2.7%	22.3%
> 1B	4.0%	26.0%

(N)

(N)

(N)

(N)

(N)

(N)

(N)

- D. The volume discount received for a given year under BellSouth SWA Contract Tariff No. FL2005-01 is determined by multiplying the eligible BellSouth SWA revenue associated with the Commitment Level usage, times the discount percentage achieved as determined in A. preceding. (N)

The following example demonstrates application of the discount: (N)

Customer Annual Commitment Level – 1.02B minutes of use (N)

Achieved Volume – 1.05B minutes of use (N)

Contract Year – first year of a one-year contract (N)

All usage is Local Switching 2 (N)

Local Switching 2 rate - \$.008760/minute (N)

From Table – applicable discount is 4.0 percent (N)

Therefore: (N)

Volume Discount = Eligible Revenue X Discount Rate (N)

Volume Discount = (1.02B minutes X \$.008760/minute) X 4.0 percent (N)

Volume Discount = \$357,408 (N)

ISSUED: July 8, 2005  
BY: Marshall M. Criser III, President -FL,  
Miami, Florida

EFFECTIVE: August 7, 2005

## E26. BELLSOUTH SWA CONTRACT TARIFFS

### E26.3 BellSouth SWA Contract Tariff No. FL2005-01 (Cont'd)

#### E26.3.5 BellSouth SWA Contract Tariff No. FL2005-01 Volume Discount Plan (Cont'd)

- E. The SWA Common Transport IP Option MOU volume discount received for the year under BellSouth SWA Contract Tariff No. FL2005-01 is determined by multiplying the eligible SWA Common Transport IP Option revenue associated with the Commitment Level usage, times the discount percentage achieved as determined in A. preceding.

The following example demonstrates application of the Annual SWA Common Transport IP Option discount:

Customer Annual Commitment Level – 1B minutes of use

Achieved Volume – 1.2B minutes of use (10M minutes of use are SWA Common Transport IP Option minutes of use)

Contract Year – first year of a one-year contract

Annual Discount for SWA Common Transport IP Option

Local Switching 2 rate - \$.008760/minute

From Table – applicable SWA Common Transport IP Option discount is 22.3 percent

Therefore:

Additional SWA Common Transport IP Option Volume Discount = Eligible Revenue X Discount Rate

Additional SWA Common Transport IP Option Volume Discount = (10M minutes X \$.008760/minute) X 22.3 percent

Additional SWA Common Transport IP Option Volume Discount = \$19,535 for the SWA Common Transport IP Option MOU

- F. When the Commitment Level usage volume is not met during a year based upon a ninety-five (95) through ninety-eight (98) percent commitment level of the term, a shortfall liability is incurred by the customer. The shortfall usage is equal to the difference in the customer's Commitment Level and the achieved local switching usage volume. The shortfall liability would be equal to the shortfall usage, times the customer's average local switching rate per MOU. The customer's average local switching rate per MOU is equal to revenue generated from the local switching usage rate elements as described in E26.3.2.H. preceding, divided by the achieved local switching usage volume.

The following example demonstrates application of shortfall:

Customer Annual Commitment Level – 1.02B minutes of use

Achieved Volume – 1B minutes of use

Contract Year – first year of a one-year contract

All usage is Local Switching 2

Local Switching 2 rate - \$.008760/minute

Therefore:

Shortfall Usage = Commitment Level – Achieved Volume

Shortfall Usage = 1.02B minutes – 1.02B minutes

Shortfall Usage = .02B minutes

Shortfall Liability = Shortfall Usage X Avg Local Switching Rate

Shortfall Liability = .02B minutes X \$.008760/minute

Shortfall Liability = \$173.220

- G. In the event of an early termination of the contract, shortfall usage calculations will be based upon the monthly usage values which comprise the annual Commitment Level. If upon comparing the shortened term commitment to the achieved usage level, a shortfall usage is determined to exist, then a shortfall liability is incurred. The shortfall liability will be calculated as described in E. above.

- H. This BellSouth SWA Contract Tariff No. FL2005-01 will also provide, as a one-time promotional offer, that the customer may obtain a partial prepayment of the first annual SWA Pricing Flexibility volume discount. To qualify for this prepayment, the customer must subscribe to this plan via a Letter of Agreement (LOA) to begin no later than thirty (30) days after the effective date of the tariff. Using the customer's usage between the commencement of this LOA and December 4, 2005, BellSouth will determine if the customer is on track to earn the discount described at the end of the year of the LOA. If so, BellSouth will calculate by December 15, 2005, the prorated volume discount and remit to the subscriber the prepayment of this pro rata volume discount as soon as practical thereafter. At the end of the year of the LOA, if an annual credit has been earned, the prepayment will be subtracted from this annual volume discount amount. If, at the end of the year, the volume discount has not been earned, then the prepayment shall be returned to BellSouth with interest calculated for the period during which the prepayment was held by the customer (Interest equals prime plus two percent (2%) – the prime interest rate is that rate which is effective at the end of the year of the LOA.).

ISSUED: December 16, 2005  
BY: Marshall M. Criser III, President -FL  
Miami, Florida

EFFECTIVE: January 15, 2006

**E26. BELLSOUTH SWA CONTRACT TARIFFS**

**E26.4 BellSouth SWA Contract Tariff No. FL2005-02**

**E26.4.1 General Regulations**

- A. The start date of BellSouth SWA Contract Tariff No. FL2005-02 is the first bill period following execution of the Letter of Agreement with the customer.
- B. The BellSouth SWA Contract Tariff No. FL2005-02 is a one (1) year agreement that terminates upon completion.
- C. The regulations, terms, conditions and volume discounts provided herein shall apply to the customer's applicable BellSouth SWA usage and revenues achieved in the state of Florida.

**E26.4.2 Subscription Conditions**

- A. To subscribe to BellSouth SWA Contract Tariff No. FL2005-02, the customer and BellSouth must execute a Letter of Agreement. BellSouth shall provide a Letter of Agreement for the customer to execute. The Letter of Agreement shall contain:
  - 1. BellSouth SWA Contract Tariff No. FL2005-02 tariff reference
  - 2. Start and termination date
  - 3. Customer name and billing address
  - 4. Billing Account Number the credit will be applied
  - 5. Access Customer Name Abbreviations (ACNAs) and Customer Identifications Codes (CICs) to be included in the BellSouth SWA Contract Tariff No. FL2005-02
  - 6. BellSouth SWA Contract Tariff No. FL2005-02 term
  - 7. Commitment Level usage
  - 8. Commitment Level 8XX Toll Free Dialing Ten Digit Screening Service Queries
- B. To subscribe to BellSouth SWA Contract Tariff No. FL2005-02, the customer must have been a BellSouth SWA customer for the previous twelve (12) months.
- C. The customer annual commitment level will be that as stated in the Letter of Agreement. The annual commitment level must be in the ranges as stated in E26.4.5.C. following
- D. When the customer subscribes to BellSouth SWA Contract Tariff No. FL2005-02, the customer must identify to the Telephone Company, all Access Customer Name Abbreviations (ACNAs) and Carrier Identification Codes (CICs) to be included in BellSouth SWA Contract Tariff No. FL2005-02.
- E. The customer must be the billing responsible party for all BellSouth SWA billing elements associated with the ACNAs and CICs included in the Letter of Agreement. However, if the customer becomes the responsible party for additional BellSouth SWA billing elements associated with additional ACNAs and CICs within eleven (11) month's after the effective date of this BellSouth SWA Contract Tariff No. FL2005-02, BellSouth will allow the additional ACNAs and CICs to be included.
- F. Any additions after the Letter of Agreement is executed will be handled as a merger or acquisition or transfer of service regulations as set forth in E26.4.3 following.
- G. A customer subscribing to BellSouth SWA Contract Tariff No. FL2005-02 may not subscribe to any other BellSouth SWA Contract Tariff for the services as set forth in H. following.
- H. The following BellSouth SWA services will be used in determining the BellSouth SWA revenues that are eligible to receive the volume discount based on the established local switching usage Commitment Level and SWA 8XX Toll Free Dialing Ten Digit Screening Service.
  - 1. Local Switching
    - Local Switching 1
    - Local Switching 2
    - Local Switching 3
    - Local Switching 4

All BellSouth marks contained herein and as set forth in the trademarks and servicemarks section of this Tariff are owned by BellSouth Intellectual Property Corporation.



ISSUED: December 16, 2005  
BY: Marshall M. Criser III, President -FL  
Miami, Florida

EFFECTIVE: January 15, 2006

## **E26. BELLSOUTH SWA CONTRACT TARIFFS**

### **E26.4 BellSouth SWA Contract Tariff No. FL2005-02 (Cont'd)**

#### **E26.4.2 Subscription Conditions (Cont'd)**

##### H. (Cont'd)

##### 2. SWA 8XX Toll Free Dialing Ten Digit Screening Service

- Per Toll Free Dialing Call Utilizing BellSouth SWA 8XX Toll Free Dialing Ten Digit Screening Service with Toll Free Dialing Number Delivery
- Per Toll Free Dialing Call Utilizing BellSouth SWA 8XX Toll Free Dialing Ten Digit Screening Service with Toll Free Dialing Number Delivery for Toll Free Dialing Numbers with Optional and Destination Features
- Per Toll Free Dialing Call Utilizing BellSouth SWA 8XX Toll Free Dialing Ten Digit Screening Service with POTS Number Delivery
- Per Toll Free Dialing Call Utilizing BellSouth SWA 8XX Toll Free Dialing Ten Digit Screening Service with POTS Number Delivery for Toll Free Dialing Numbers with Optional Complex Feature, i.e., Call Handling and Destination Features

I. A customer may not combine its local switching minutes of use and SWA 8XX Toll Free Dialing Ten Digit Screening Service with another customer, whether an individual, partnership, association or corporation, for the purpose of meeting the established minimum local switching usage and SWA 8XX Toll Free Dialing Ten Digit Screening Service Queries as set forth in E26.4.5.B. following. For a customer to qualify for this 2005-02 SWA Contract Tariff, the customer must have at least 500 Million SWA local switching minutes of use and 90M SWA 8XX Toll Free Dialing Ten Digit Screening Service queries.

J. The services to which the incentives set forth in this BellSouth SWA Contract Tariff No. FL2005-02 apply, are obtained from Section E6. of this Tariff. BellSouth reserves the right to change the terms, conditions, rates, and charges applicable for services in Section E6 or other sections of this Tariff during the term of this Contract Tariff unless otherwise specified in this Contract Tariff. General regulations and ordering options for the BellSouth SWA services are as set forth in Sections E2. and E5. of this Tariff.

#### **E26.4.3 Mergers and Acquisitions and Transfer of Service**

A. In the event the customer merges with another company or is acquired by another company, the following regulations will apply:

1. The customer may not combine Local Switching usage volumes and SWA 8XX Toll Free Dialing Ten Digit Screening Service queries with the merged or acquired company's Local Switching usage volumes and SWA 8XX Toll Free Dialing Ten Digit Screening Service queries for the purpose of obtaining volume discounts provided under BellSouth SWA Contract Tariff No. FL2005-02.
2. The customer may continue subscribing to BellSouth SWA Contract Tariff No. FL2005-02 for the duration of the term provided that the customer continues the subscription as if it were the same entity that existed prior to the merger or acquisition.

B. If the customer requests a transfer of service, pursuant to Transfer of Service regulations in Sections E2. and E6. of this Tariff, the customer's subscription to BellSouth SWA Contract Tariff No. FL2005-02 shall be terminated.

#### **E26.4.4 BellSouth SWA Revenue Volume Discounts**

A. The year of the customer's Letter of Agreement is defined as twelve (12) consecutive bill periods following the beginning date of the Letter of Agreement. For purposes of calculating the BellSouth SWA volume discounts, month one (1) is the first complete bill period after the beginning date of the Letter of Agreement. For example, if the beginning date of the Letter of Agreement is June 6, 2006 bill period, and the bill period is the twelfth (12<sup>th</sup>), then month one (1) for purposes of calculating the BellSouth SWA volume discounts will be the July 12, 2006 bill period.

B. The BellSouth SWA Pricing Flexibility volume discounts provided herein will be determined during the first month after the end of the year of the customer's Letter of Agreement. During the second month following the end of the year of the Letter of Agreement, the BellSouth SWA volume discounts will be applied via a credit to the customer's bill.

C. The BellSouth SWA volume discounts are applicable to the BellSouth SWA services as set forth in E26.4.2.H. preceding.

D. The BellSouth SWA volume discounts specified in BellSouth SWA Contract Tariff No. FL2005-02 will not be applied to taxes and nonrecurring BellSouth SWA revenues.

ISSUED: December 16, 2005  
BY: Marshall M. Criser III, President -FL  
Miami, Florida

EFFECTIVE: January 15, 2006

**E26. BELLSOUTH SWA CONTRACT TARIFFS**

**E26.4 BellSouth SWA Contract Tariff No. FL2005-02 (Cont'd)**

**E26.4.5 BellSouth SWA Contract Tariff No. FL2005-02 Volume Discount Plan**

- A. BellSouth SWA Contract Tariff No. FL2005-02 provides for annual volume discounts based upon annual local switching minutes of use (MOU), annual SWA 8XX Toll Free Dialing Ten Digit Screening Service queries achieved, and the Commitment Level and term year as defined in the Letter of Agreement. Discounts are achieved in term year when the achieved local switching volume and/or SWA 8XX Toll Free Dialing Ten Digit Screening Service is equal to or above a Commitment Level usage. When equaled or exceeded, discounts are applied to the Commitment Level usage and/or SWA 8XX Toll Free Dialing Ten Digit Screening Service queries. If the customer's achieved volume is below the Commitment Level usage and/or SWA 8XX Toll Free Dialing Ten Digit Screening Service queries, no discounts will be rewarded to the customer. (N)
- B. The Commitment Level usage, 8XX Toll Free Dialing Ten Digit Screening Service queries and the achievable volume discounts associated with the BellSouth SWA services are shown in the tables below. If the customer's achieved volume is below the Commitment Level usage and/or SWA 8XX Toll Free Dialing Ten Digit Screening Service queries, no discounts will be rewarded to the customer. (N)
- C. The Commitment Level usage, SWA 8XX Toll Free Dialing Ten Digit Screening Service queries and the achievable volume discounts associated with the BellSouth SWA Common Transport IP Option, which allows termination or origination (when/where available and capacity permits) of Internet Protocol (IP) traffic, are shown in the table below. The SWA Common Transport IP Option discount will be in addition to the discount obtained from the BellSouth SWA services as described in E26.4.5.B. preceding. Only SWA Common Transport IP Option MOU that go through the BellSouth Tandem are eligible for the discounts as described in the table for Additional SWA Common Transport IP Option Discounts. If the customer's achieved volume is below the Commitment Level usage and/or SWA 8XX Toll Free Dialing Ten Digit Screening Service queries, no discounts will be rewarded to the customer. (N)

Annual Usage Commitment Level and Discount		
Commitment Level MOUs	BellSouth SWA services discounts as described on E26.4.5.A.	Additional SWA Common Transport IP Option Discounts as described in E26.4.5.C.
> 450M to 500M	1.3%	15.7%
> 500M to 600M	2.7%	22.3%
> 600M	4.0%	26.0%

Annual 8XX Toll Free Dialing Ten Digit Screening Service Commitment Level and Discount	
Commitment Level Queries	BellSouth SWA services discounts as described on E26.4.5.A.
> 90M to 100M	7.0%
> 100M to 110M	10.0%
> 110M	15.0%

- D. The volume discount received for a given year under BellSouth SWA Contract Tariff No. FL2005-02 is determined by multiplying the eligible BellSouth SWA revenue associated with the Commitment Level usage, times the discount percentage achieved as determined in A. preceding. (N)

The following example demonstrates application of the discount: (N)

- Customer Annual Commitment Level – 550M minutes of use (N)
- Achieved Volume – 650M minutes of use (N)
- Contract Year – first year of a one-year contract (N)
- All usage is Local Switching 2 (N)
- Local Switching 2 rate - \$.008760/minute (N)
- From Table – applicable discount is 2.7 percent (N)

All BellSouth marks contained herein and as set forth in the trademarks and servicemarks section of this Tariff are owned by BellSouth Intellectual Property Corporation.

FLORIDA  
ISSUED: December 16, 2005  
BY: Marshall M. Criser III, President -FL  
Miami, Florida

EFFECTIVE: January 15, 2006

**E26. BELLSOUTH SWA CONTRACT TARIFFS**

**E26.4 BellSouth SWA Contract Tariff No. FL2005-02 (Cont'd)**

**E26.4.5 BellSouth SWA Contract Tariff No. FL2005-02 Volume Discount Plan (Cont'd)**

D. (Cont'd)

Therefore:

Volume Discount = Eligible Revenue X Discount Rate

Volume Discount = (650M minutes X \$.008760/minute) X 2.7 percent

Volume Discount = \$153,738

- E. The SWA Common Transport IP Option MOU volume discount received for the year under BellSouth SWA Contract Tariff No. FL2005-02 is determined by multiplying the eligible SWA Common Transport IP Option revenue associated with the Commitment Level usage, times the discount percentage achieved as determined in A. preceding.

The following example demonstrates application of the Annual SWA Common Transport IP Option discount:

Customer Annual Commitment Level – 550M minutes of use

Achieved Volume – 650M minutes of use (10M minutes of use are SWA Common Transport IP Option minutes of use)

Contract Year – first year of a one-year contract

Annual Discount for SWA Common Transport IP Option

Local Switching 2 rate - \$.008760/minute

From Table – applicable SWA Common Transport IP Option discount is 22.3 percent

Therefore:

Additional SWA Common Transport IP Option Volume Discount = Eligible Revenue X Discount Rate

Additional SWA Common Transport IP Option Volume Discount = (10M minutes X \$.008760/minute) X 22.3 percent

Additional SWA Common Transport IP Option Volume Discount = \$19,535 for the SWA Common Transport IP Option MOU

- F. The SWA 8XX Toll Free Dialing Ten Digit Screening Service Query volume discount received for a given year under BellSouth SWA Contract Tariff No. 2005-02 is determined by multiplying the eligible BellSouth SWA 8XX Toll Free Dialing Ten Digit Screening Service queries total billed revenue times the discount percentage achieved as determined in (A) preceding.

The following example demonstrates application of the discount

Customer Annual Commitment Level – 105M queries

Achieved Volume – 120M queries

Contract Year – first year of a one-year contract

Total Billed Revenue 8XX Toll Free Dialing Ten Digit Screening Service

query total billed revenue from the contract term = \$480,000.

From Table – applicable discount is 10.0 percent

Therefore:

Volume Discount = Total billed revenue X Discount percent

Volume Discount = (\$480,000 X 10 percent)

Volume Discount = \$48,000

- G. This BellSouth SWA Contract Tariff No. FL2005-02 will also provide, as a one-time promotional offer, that the customer may obtain a partial prepayment of the first annual SWA Pricing Flexibility volume discount. To qualify for this prepayment, the customer must subscribe to this plan via a Letter of Agreement (LOA) to begin no later than thirty (30) days after the effective date of the tariff. Using the customer's usage between the commencement of this LOA and December 4, 2006, BellSouth will determine if the customer is on track to earn the discount described at the end of the year of the LOA. If so, BellSouth will calculate by December 15, 2006, the prorated volume discount and remit to the subscriber the prepayment of this pro rata volume discount as soon as practical thereafter. At the end of the year of the LOA, if an annual credit has been earned, the prepayment will be subtracted from this annual volume discount amount. If, at the end of the year, the volume discount has not been earned, then the prepayment shall be returned to BellSouth with interest calculated for the period during which the prepayment was held by the customer (Interest equals prime plus two percent (2%) – the prime interest rate is that rate which is effective at the end of the year of the LOA.).

BELLSOUTH  
TELECOMMUNICATIONS, INC.  
FLORIDA

ACCESS SERVICES TARIFF

Original Page 1

ISSUED: November 4, 1997

EFFECTIVE: November 19, 1997

BY: Joseph P. Lacher, President -FL  
Miami, Florida

**E27. RESERVED FOR FUTURE USE**

(N)

CONTENTS

(N)

BELLSOUTH  
TELECOMMUNICATIONS, INC.  
FLORIDA  
ISSUED: August 20, 2003  
BY: Joseph P. Lacher, President -FL  
Miami, Florida

ACCESS SERVICES TARIFF

Second Revised Page 1  
Cancels First Revised Page 1  
EFFECTIVE: September 4, 2003

**E27. (DELETED)**

(D)

CONTENTS

BELLSOUTH  
TELECOMMUNICATIONS, INC.  
FLORIDA  
ISSUED: August 20, 2003  
BY: Joseph P. Lacher, President -FL  
Miami, Florida

ACCESS SERVICES TARIFF

First Revised Page 1  
Cancels Original Page 1

EFFECTIVE: September 4, 2003

**E27. (DELETED)**

(D)

BELLSOUTH  
TELECOMMUNICATIONS, INC.

FLORIDA

ISSUED: August 20, 2003

BY: Joseph P. Lacher, President -FL  
Miami, Florida

ACCESS SERVICES TARIFF

First Revised Page 2  
Cancels Original Page 2

EFFECTIVE: September 4, 2003

**E27. (DELETED)**

(D)

BELLSOUTH  
TELECOMMUNICATIONS, INC.  
FLORIDA  
ISSUED: August 20, 2003  
BY: Joseph P. Lacher, President -FL  
Miami, Florida

ACCESS SERVICES TARIFF

First Revised Page 3  
Cancels Original Page 3

EFFECTIVE: September 4, 2003

**E27. (DELETED)**

(D)



BELLSOUTH  
TELECOMMUNICATIONS, INC.

FLORIDA

ISSUED: August 20, 2003

BY: Joseph P. Lacher, President -FL  
Miami, Florida

ACCESS SERVICES TARIFF

First Revised Page 4  
Cancels Original Page 4

EFFECTIVE: September 4, 2003

**E27. (DELETED)**

(D)

BELLSOUTH  
TELECOMMUNICATIONS, INC.  
FLORIDA

ACCESS SERVICES TARIFF

Original Page 1

ISSUED: November 4, 1997

EFFECTIVE: November 19, 1997

BY: Joseph P. Lacher, President -FL  
Miami, Florida

**E28. RESERVED FOR FUTURE USE**

(N)

CONTENTS

(N)

BELLSOUTH  
TELECOMMUNICATIONS, INC.  
FLORIDA  
ISSUED: November 4, 1997  
BY: Joseph P. Lacher, President -FL  
Miami, Florida

ACCESS SERVICES TARIFF

Original Page 1

EFFECTIVE: November 19, 1997

**E29. RESERVED FOR FUTURE USE**

(N)

CONTENTS

(N)

## **E30. ETHERNET SERVICES**

### CONTENTS

E30.1 AT&T SWITCHED ETHERNET SERVICE <sup>SM</sup>	1
--	---

E30.2 AT&T DEDICATED ETHERNET	36
-------------------------------	----

(D)

## **E30. ETHERNET SERVICES**

### **E30.1 AT&T SWITCHED ETHERNET SERVICE<sup>SM</sup>**

For service description, terms and conditions, and pricing, please see AT&T Switched Ethernet Service described in the AT&T Ethernet Service Guide found at the following website: (D)

<https://cpr.att.com/pdf/commonEthServGuide.html> (C)

Material from page 2 through page 35 is hereby deleted in its entirety. (D)

BELLSOUTH  
TELECOMMUNICATIONS  
FLORIDA  
ISSUED: September 10, 2020  
BY: Joe York, President -FL  
Jacksonville, Florida

ACCESS SERVICES TARIFF

First Revised Page 2  
Cancels Original Page 2

EFFECTIVE: September 11, 2020

## **E30. ETHERNET SERVICES**

(D)

BELLSOUTH  
TELECOMMUNICATIONS  
FLORIDA  
ISSUED: September 10, 2020  
BY: Joe York, President -FL  
Jacksonville, Florida

ACCESS SERVICES TARIFF

First Revised Page 3  
Cancels Original Page 3

EFFECTIVE: September 11, 2020

## **E30. ETHERNET SERVICES**

(D)

BELLSOUTH  
TELECOMMUNICATIONS  
FLORIDA  
ISSUED: September 10, 2020  
BY: Joe York, President -FL  
Jacksonville, Florida

ACCESS SERVICES TARIFF

Third Revised Page 4  
Cancels Second Revised Page 4  
EFFECTIVE: September 11, 2020

**E30. ETHERNET SERVICES**

(D)



BELLSOUTH  
TELECOMMUNICATIONS  
FLORIDA  
ISSUED: September 10, 2020  
BY: Joe York, President -FL  
Jacksonville, Florida

ACCESS SERVICES TARIFF

First Revised Page 5  
Cancels Original Page 5

EFFECTIVE: September 11, 2020

## **E30. ETHERNET SERVICES**

(D)

BELLSOUTH  
TELECOMMUNICATIONS  
FLORIDA  
ISSUED: September 10, 2020  
BY: Joe York, President -FL  
Jacksonville, Florida

ACCESS SERVICES TARIFF

First Revised Page 6  
Cancels Original Page 6

EFFECTIVE: September 11, 2020

## **E30. ETHERNET SERVICES**

(D)

BELLSOUTH  
TELECOMMUNICATIONS  
FLORIDA  
ISSUED: September 10, 2020  
BY: Joe York, President -FL  
Jacksonville, Florida

ACCESS SERVICES TARIFF

Second Revised Page 7  
Cancels First Revised Page 7

EFFECTIVE: September 11, 2020

## **E30. ETHERNET SERVICES**

(D)

BELLSOUTH  
TELECOMMUNICATIONS  
FLORIDA  
ISSUED: September 10, 2020  
BY: Joe York, President -FL  
Jacksonville, Florida

ACCESS SERVICES TARIFF

Second Revised Page 8  
Cancels First Revised Page 8

EFFECTIVE: September 11, 2020

## **E30. ETHERNET SERVICES**

(D)

BELLSOUTH  
TELECOMMUNICATIONS  
FLORIDA  
ISSUED: September 10, 2020  
BY: Joe York, President -FL  
Jacksonville, Florida

ACCESS SERVICES TARIFF

First Revised Page 9  
Cancels Original Page 9

EFFECTIVE: September 11, 2020

## **E30. ETHERNET SERVICES**

(D)

BELLSOUTH  
TELECOMMUNICATIONS  
FLORIDA  
ISSUED: September 10, 2020  
BY: Joe York, President -FL  
Jacksonville, Florida

ACCESS SERVICES TARIFF

Second Revised Page 10  
Cancels First Revised Page 10  
EFFECTIVE: September 11, 2020

## **E30. ETHERNET SERVICES**

(D)

BELLSOUTH  
TELECOMMUNICATIONS  
FLORIDA  
ISSUED: September 10, 2020  
BY: Joe York, President -FL  
Jacksonville, Florida

ACCESS SERVICES TARIFF

First Revised Page 10.1  
Cancels Original Page 10.1

EFFECTIVE: September 11, 2020

**E30. ETHERNET SERVICES**

(D)

BELLSOUTH  
TELECOMMUNICATIONS  
FLORIDA  
ISSUED: September 10, 2020  
BY: Joe York, President -FL  
Jacksonville, Florida

ACCESS SERVICES TARIFF

First Revised Page 11  
Cancels Original Page 11

EFFECTIVE: September 11, 2020

## **E30. ETHERNET SERVICES**

(D)



BELLSOUTH  
TELECOMMUNICATIONS  
FLORIDA  
ISSUED: September 10, 2020  
BY: Joe York, President -FL  
Jacksonville, Florida

ACCESS SERVICES TARIFF

First Revised Page 12  
Cancels Original Page 12

EFFECTIVE: September 11, 2020

**E30. ETHERNET SERVICES**

(D)

BELLSOUTH  
TELECOMMUNICATIONS  
FLORIDA  
ISSUED: September 10, 2020  
BY: Joe York, President -FL  
Jacksonville, Florida

ACCESS SERVICES TARIFF

First Revised Page 13  
Cancels Original Page 13

EFFECTIVE: September 11, 2020

**E30. ETHERNET SERVICES**

(D)

BELLSOUTH  
TELECOMMUNICATIONS  
FLORIDA  
ISSUED: September 10, 2020  
BY: Joe York, President -FL  
Jacksonville, Florida

ACCESS SERVICES TARIFF

First Revised Page 14  
Cancels Original Page 14

EFFECTIVE: September 11, 2020

## **E30. ETHERNET SERVICES**

(D)

BELLSOUTH  
TELECOMMUNICATIONS  
FLORIDA  
ISSUED: September 10, 2020  
BY: Joe York, President -FL  
Jacksonville, Florida

ACCESS SERVICES TARIFF

First Revised Page 15  
Cancels Original Page 15

EFFECTIVE: September 11, 2020

## **E30. ETHERNET SERVICES**

(D)

BELLSOUTH  
TELECOMMUNICATIONS  
FLORIDA  
ISSUED: September 10, 2020  
BY: Joe York, President -FL  
Jacksonville, Florida

ACCESS SERVICES TARIFF

First Revised Page 16  
Cancels Original Page 16

EFFECTIVE: September 11, 2020

## **E30. ETHERNET SERVICES**

(D)

BELLSOUTH  
TELECOMMUNICATIONS  
FLORIDA  
ISSUED: September 10, 2020  
BY: Joe York, President -FL  
Jacksonville, Florida

ACCESS SERVICES TARIFF

First Revised Page 17  
Cancels Original Page 17

EFFECTIVE: September 11, 2020

## **E30. ETHERNET SERVICES**

(D)

BELLSOUTH  
TELECOMMUNICATIONS  
FLORIDA  
ISSUED: September 10, 2020  
BY: Joe York, President -FL  
Jacksonville, Florida

ACCESS SERVICES TARIFF

First Revised Page 18  
Cancels Original Page 18

EFFECTIVE: September 11, 2020

## **E30. ETHERNET SERVICES**

(D)

BELLSOUTH  
TELECOMMUNICATIONS  
FLORIDA  
ISSUED: September 10, 2020  
BY: Joe York, President -FL  
Jacksonville, Florida

ACCESS SERVICES TARIFF

First Revised Page 19  
Cancels Original Page 19

EFFECTIVE: September 11, 2020

## **E30. ETHERNET SERVICES**



BELLSOUTH  
TELECOMMUNICATIONS  
FLORIDA  
ISSUED: September 10, 2020  
BY: Joe York, President -FL  
Jacksonville, Florida

ACCESS SERVICES TARIFF

Second Revised Page 20  
Cancels First Revised Page 20  
EFFECTIVE: September 11, 2020

## **E30. ETHERNET SERVICES**

(D)

BELLSOUTH  
TELECOMMUNICATIONS  
FLORIDA  
ISSUED: September 10, 2020  
BY: Joe York, President -FL  
Jacksonville, Florida

ACCESS SERVICES TARIFF

First Revised Page 21  
Cancels Original Page 21

EFFECTIVE: September 11, 2020

**E30. ETHERNET SERVICES**

(D)

BELLSOUTH  
TELECOMMUNICATIONS  
FLORIDA  
ISSUED: September 10, 2020  
BY: Joe York, President -FL  
Jacksonville, Florida

ACCESS SERVICES TARIFF

Second Revised Page 22  
Cancels First Revised Page 22  
EFFECTIVE: September 11, 2020

## **E30. ETHERNET SERVICES**

(D)

BELLSOUTH  
TELECOMMUNICATIONS  
FLORIDA  
ISSUED: September 10, 2020  
BY: Joe York, President -FL  
Jacksonville, Florida

ACCESS SERVICES TARIFF

Third Revised Page 23  
Cancels Second Revised Page 23

EFFECTIVE: September 11, 2020

**E30. ETHERNET SERVICES**

(D)

BELLSOUTH  
TELECOMMUNICATIONS  
FLORIDA

ACCESS SERVICES TARIFF

Third Revised Page 24  
Cancels Second Revised Page 24

ISSUED: September 10, 2020

~~ISSUED: September 9, 2020~~

EFFECTIVE: September 11, 2020

~~EFFECTIVE: September 10, 2020~~

BY: Joe York, President -FL  
Jacksonville, Florida

## **E30. ETHERNET SERVICES**

(D)

BELLSOUTH  
TELECOMMUNICATIONS  
FLORIDA  
ISSUED: September 10, 2020  
BY: Joe York, President -FL  
Jacksonville, Florida

ACCESS SERVICES TARIFF

Third Revised Page 25  
Cancels Second Revised Page 25

EFFECTIVE: September 11, 2020

**E30. ETHERNET SERVICES**

(D)

BELLSOUTH  
TELECOMMUNICATIONS  
FLORIDA  
ISSUED: September 10, 2020  
BY: Joe York, President -FL  
Jacksonville, Florida

ACCESS SERVICES TARIFF

Third Revised Page 26  
Cancels Second Revised Page 26

EFFECTIVE: September 11, 2020

## **E30. ETHERNET SERVICES**

BELLSOUTH  
TELECOMMUNICATIONS  
FLORIDA  
ISSUED: September 10, 2020  
BY: Joe York, President -FL  
Jacksonville, Florida

ACCESS SERVICES TARIFF

Third Revised Page 27  
Cancels Second Revised Page 27

EFFECTIVE: September 11, 2020

**E30. ETHERNET SERVICES**

(D)



BELLSOUTH  
TELECOMMUNICATIONS  
FLORIDA  
ISSUED: September 10, 2020  
BY: Joe York, President -FL  
Jacksonville, Florida

ACCESS SERVICES TARIFF

Second Revised Page 28  
Cancels First Revised Page 28  
EFFECTIVE: September 11, 2020

## **E30. ETHERNET SERVICES**

(D)

BELLSOUTH  
TELECOMMUNICATIONS  
FLORIDA  
ISSUED: September 10, 2020  
BY: Joe York, President -FL  
Jacksonville, Florida

ACCESS SERVICES TARIFF

Third Revised Page 29  
Cancels Second Revised Page 29

EFFECTIVE: September 11, 2020

## **E30. ETHERNET SERVICES**

BELLSOUTH  
TELECOMMUNICATIONS  
FLORIDA  
ISSUED: September 10, 2020  
BY: Joe York, President -FL  
Jacksonville, Florida

ACCESS SERVICES TARIFF

Third Revised Page 30  
Cancels Second Revised Page 30

EFFECTIVE: September 11, 2020

## **E30. ETHERNET SERVICES**

(D)

BELLSOUTH  
TELECOMMUNICATIONS  
FLORIDA  
ISSUED: September 10, 2020  
BY: Joe York, President -FL  
Jacksonville, Florida

ACCESS SERVICES TARIFF

Third Revised Page 31  
Cancels Second Revised Page 31

EFFECTIVE: September 11, 2020

**E30. ETHERNET SERVICES**

(D)

BELLSOUTH  
TELECOMMUNICATIONS  
FLORIDA  
ISSUED: September 10, 2020  
BY: Joe York, President -FL  
Jacksonville, Florida

ACCESS SERVICES TARIFF

Third Revised Page 32  
Cancels Second Revised Page 32

EFFECTIVE: September 11, 2020

## **E30. ETHERNET SERVICES**

(D)

BELLSOUTH  
TELECOMMUNICATIONS  
FLORIDA  
ISSUED: September 10, 2020  
BY: Joe York, President -FL  
Jacksonville, Florida

ACCESS SERVICES TARIFF

First Revised Page 33  
Cancels Original Page 33

EFFECTIVE: September 11, 2020

**E30. ETHERNET SERVICES**

(D)

BELLSOUTH  
TELECOMMUNICATIONS  
FLORIDA  
ISSUED: September 10, 2020  
BY: Joe York, President -FL  
Jacksonville, Florida

ACCESS SERVICES TARIFF

First Revised Page 34  
Cancels Original Page 34

EFFECTIVE: September 11, 2020

**E30. ETHERNET SERVICES**

(D)

BELLSOUTH  
TELECOMMUNICATIONS  
FLORIDA  
ISSUED: September 10, 2020  
BY: Joe York, President -FL  
Jacksonville, Florida

ACCESS SERVICES TARIFF

First Revised Page 35  
Cancels Original Page 35

EFFECTIVE: September 11, 2020

**E30. ETHERNET SERVICES**

(D)



## **E30. ETHERNET SERVICES**

### **E30.2 AT&T DEDICATED ETHERNET SERVICE**

#### **E30.2.1 Service Description**

For service description, terms and conditions, and pricing, please see AT&T Dedicated Ethernet Service described in the AT&T Ethernet Service Guide found at the following website:

<https://cpr.att.com/pdf/commonEthServGuide.html>

Material from Page 37 through Page 52 is hereby deleted in its entirety.

(C)

(D)

(N)

(N)

BELLSOUTH  
TELECOMMUNICATIONS  
FLORIDA  
ISSUED: May 18, 2023  
BY: Joe York, President -FL  
Jacksonville, Florida

ACCESS SERVICES TARIFF

First Revised Page 37  
Cancels Original Page 37  
EFFECTIVE: May 19, 2023

## **E30. ETHERNET SERVICES**

(D)

BELLSOUTH  
TELECOMMUNICATIONS  
FLORIDA  
ISSUED: May 18, 2023  
BY: Joe York, President -FL  
Jacksonville, Florida

ACCESS SERVICES TARIFF

First Revised Page 37.1  
Cancels Original Page 37.1  
EFFECTIVE: May 19, 2023

## **E30. ETHERNET SERVICES**

(D)

BELLSOUTH  
TELECOMMUNICATIONS  
FLORIDA  
ISSUED: May 18, 2023  
BY: Joe York, President -FL  
Jacksonville, Florida

ACCESS SERVICES TARIFF

First Revised Page 37.2  
Cancels Original Page 37.2  
EFFECTIVE: May 19, 2023

**E30. ETHERNET SERVICES**

(D)

BELLSOUTH  
TELECOMMUNICATIONS  
FLORIDA  
ISSUED: May 18, 2023  
BY: Joe York, President -FL  
Jacksonville, Florida

ACCESS SERVICES TARIFF

Second Revised Page 38  
Cancels First Revised Page 38

EFFECTIVE: May 19, 2023

**E30. ETHERNET SERVICES**

(D)

BELLSOUTH  
TELECOMMUNICATIONS  
FLORIDA  
ISSUED: May 18, 2023  
BY: Joe York, President -FL  
Jacksonville, Florida

ACCESS SERVICES TARIFF

Second Revised Page 39  
Cancels First Revised Page 39

EFFECTIVE: May 19, 2023

**E30. ETHERNET SERVICES**

(D)

BELLSOUTH  
TELECOMMUNICATIONS  
FLORIDA  
ISSUED: May 18, 2023  
BY: Joe York, President -FL  
Jacksonville, Florida

ACCESS SERVICES TARIFF

Second Revised Page 40  
Cancels First Revised Page 40

EFFECTIVE: May 19, 2023

## **E30. ETHERNET SERVICES**

(D)

BELLSOUTH  
TELECOMMUNICATIONS  
FLORIDA  
ISSUED: May 18, 2023  
BY: Joe York, President -FL  
Jacksonville, Florida

ACCESS SERVICES TARIFF

Second Revised Page 41  
Cancels First Revised Page 41

EFFECTIVE: May 19, 2023

## **E30. ETHERNET SERVICES**

(D)



BELLSOUTH  
TELECOMMUNICATIONS  
FLORIDA  
ISSUED: May 18, 2023  
BY: Joe York, President -FL  
Jacksonville, Florida

ACCESS SERVICES TARIFF

First Revised Page 42  
Cancels Original Page 42  
EFFECTIVE: May 19, 2023

## **E30. ETHERNET SERVICES**

(D)

BELLSOUTH  
TELECOMMUNICATIONS  
FLORIDA  
ISSUED: May 18, 2023  
BY: Joe York, President -FL  
Jacksonville, Florida

ACCESS SERVICES TARIFF

Second Revised Page 43  
Cancels First Revised Page 43

EFFECTIVE: May 19, 2023

**E30. ETHERNET SERVICES**

(D)

BELLSOUTH  
TELECOMMUNICATIONS  
FLORIDA  
ISSUED: May 18, 2023  
BY: Joe York, President -FL  
Jacksonville, Florida

ACCESS SERVICES TARIFF

Second Revised Page 44  
Cancels First Revised Page 44

EFFECTIVE: May 19, 2023

## **E30. ETHERNET SERVICES**

(D)

BELLSOUTH  
TELECOMMUNICATIONS  
FLORIDA  
ISSUED: May 18, 2023  
BY: Joe York, President -FL  
Jacksonville, Florida

ACCESS SERVICES TARIFF

First Revised Page 44.1  
Cancels Original Page 44.1  
EFFECTIVE: May 19, 2023

**E30. ETHERNET SERVICES**

(D)

BELLSOUTH  
TELECOMMUNICATIONS  
FLORIDA  
ISSUED: May 18, 2023  
BY: Joe York, President -FL  
Jacksonville, Florida

ACCESS SERVICES TARIFF

First Revised Page 45  
Cancels Original Page 45  
EFFECTIVE: May 19, 2023

## **E30. ETHERNET SERVICES**

(D)

BELLSOUTH  
TELECOMMUNICATIONS  
FLORIDA  
ISSUED: May 18, 2023  
BY: Joe York, President -FL  
Jacksonville, Florida

ACCESS SERVICES TARIFF

First Revised Page 46  
Cancels Original Page 46  
EFFECTIVE: May 19, 2023

## **E30. ETHERNET SERVICES**

(D)

BELLSOUTH  
TELECOMMUNICATIONS  
FLORIDA  
ISSUED: May 18, 2023  
BY: Joe York, President -FL  
Jacksonville, Florida

ACCESS SERVICES TARIFF

First Revised Page 47  
Cancels Original Page 47  
EFFECTIVE: May 19, 2023

## **E30. ETHERNET SERVICES**

(D)

BELLSOUTH  
TELECOMMUNICATIONS  
FLORIDA  
ISSUED: May 18, 2023  
BY: Joe York, President -FL  
Jacksonville, Florida

ACCESS SERVICES TARIFF

First Revised Page 48  
Cancels Original Page 48  
EFFECTIVE: May 19, 2023

## **E30. ETHERNET SERVICES**

(D)



BELLSOUTH  
TELECOMMUNICATIONS  
FLORIDA  
ISSUED: May 18, 2023  
BY: Joe York, President -FL  
Jacksonville, Florida

ACCESS SERVICES TARIFF

First Revised Page 49  
Cancels Original Page 49  
EFFECTIVE: May 19, 2023

**E30. ETHERNET SERVICES**

(D)

BELLSOUTH  
TELECOMMUNICATIONS  
FLORIDA  
ISSUED: May 18, 2023  
BY: Joe York, President -FL  
Jacksonville, Florida

ACCESS SERVICES TARIFF

First Revised Page 50  
Cancels Original Page 50  
EFFECTIVE: May 19, 2023

**E30. ETHERNET SERVICES**

(D)

BELLSOUTH  
TELECOMMUNICATIONS  
FLORIDA  
ISSUED: May 18, 2023  
BY: Joe York, President -FL  
Jacksonville, Florida

ACCESS SERVICES TARIFF

First Revised Page 51  
Cancels Original Page 51  
EFFECTIVE: May 19, 2023

## **E30. ETHERNET SERVICES**

(D)

BELLSOUTH  
TELECOMMUNICATIONS  
FLORIDA  
ISSUED: May 18, 2023  
BY: Joe York, President -FL  
Jacksonville, Florida

ACCESS SERVICES TARIFF

First Revised Page 52  
Cancels Original Page 52  
EFFECTIVE: May 19, 2023

## **E30. ETHERNET SERVICES**

(D)

BELLSOUTH  
TELECOMMUNICATIONS, INC.  
FLORIDA  
ISSUED: November 4, 1997  
BY: Joseph P. Lacher, President -FL  
Miami, Florida

ACCESS SERVICES TARIFF

Original Page 1

EFFECTIVE: November 19, 1997

**E31. RESERVED FOR FUTURE USE**

(N)

CONTENTS

(N)

BELLSOUTH  
TELECOMMUNICATIONS, INC.  
FLORIDA

ACCESS SERVICES TARIFF

Original Page 1

ISSUED: November 4, 1997

EFFECTIVE: November 19, 1997

BY: Joseph P. Lacher, President -FL  
Miami, Florida

**E32. RESERVED FOR FUTURE USE**

(N)

CONTENTS

(N)

BELLSOUTH  
TELECOMMUNICATIONS, INC.

FLORIDA

ISSUED: November 4, 1997

BY: Joseph P. Lacher, President -FL  
Miami, Florida

ACCESS SERVICES TARIFF

Original Page 1

EFFECTIVE: November 19, 1997

**E33. RESERVED FOR FUTURE USE**

(N)

CONTENTS

(N)

ISSUED: November 4, 1997

EFFECTIVE: November 19, 1997

BY: Joseph P. Lacher, President -FL  
Miami, Florida

## E34. ADVANCED INTELLIGENT NETWORK (AIN) SERVICES

(N)

### CONTENTS

<b>E34.1 Reserved for Future Use</b>	1	(N)
<b>E34.2 Reserved for Future Use</b>	1	(N)
<b>E34.3 Reserved for Future Use</b>	1	(N)
<b>E34.4 Reserved for Future Use</b>	1	(N)
<b>E34.5 Reserved for Future Use</b>	1	(N)
<b>E34.6 BellSouth® AIN SMS Access Service</b>	1	(N)
E34.6.1 Description of Service	1	(N)
E34.6.2 Definitions	2	(N)
E34.6.3 Regulations	2	(N)
E34.6.4 Application of Rates	3	(N)
E34.6.5 Rates and Charges	4	(N)
<b>E34.7 BellSouth® AIN Toolkit Service</b>	4	(N)
E34.7.1 General	4	(N)
E34.7.2 Definitions	5	(N)
E34.7.3 Regulations	6	(N)
E34.7.4 Restrictions and Limitations	8	(N)
E34.7.5 Monthly Reports and Special Studies	8	(N)
E34.7.6 Rates and Charges	9	(N)



ISSUED: November 4, 1997

EFFECTIVE: November 19, 1997

BY: Joseph P. Lacher, President -FL  
Miami, Florida

## **E34. ADVANCED INTELLIGENT NETWORK (AIN) SERVICES**

### **E34.1 Reserved for Future Use**

### **E34.2 Reserved for Future Use**

### **E34.3 Reserved for Future Use**

### **E34.4 Reserved for Future Use**

### **E34.5 Reserved for Future Use**

## **E34.6 BellSouth® AIN Service Management System Access Service**

### **E34.6.1 Description of Service**

- A.** BellSouth® AIN SMS Access service is an intraLATA service that allows a customer to make changes to their Advanced Intelligent Network (AIN) services. BellSouth® AIN Toolkit service can be controlled in this manner and must be purchased separately from E34.7 following.

BellSouth® AIN SMS Access service provides the capability for a customer to access the AIN Service Management System (SMS) in an efficient and flexible way unaided by BellSouth Telecommunications (BST) personnel or the service order process. Once the customer has accessed the SMS, the customer can modify service subscription information, view service related information and access reports.

BellSouth® AIN SMS Access service supports access security, data security and security based on class of users. Access security requires a security card authentication process, in addition to log-in and password identifiers, for access to the SMS. BellSouth® AIN SMS Access service also ensures that each BellSouth® AIN SMS Access service customer can access only data that belongs to that customer. In addition, the BellSouth® AIN SMS Access service customer controls which portion of data may be accessed by each of the customer's users. This type of security is based on class of users and the customer will select a class for each user.

The SMS keeps a record of system access on a per user basis which includes date, time and log-in identifiers. This information will be available to customers via the report function of BellSouth® AIN SMS Access service. Customers may also view on-line and download AIN service specific reports through BellSouth® AIN SMS Access service.

BellSouth® AIN SMS Access service is only available to customers who subscribe to one or more of the services listed in B. following.

- B.** BellSouth® AIN Toolkit service, as set forth in E34.7 following, may be controlled using BellSouth® AIN SMS Access service.

- C.** BellSouth® AIN SMS Access service consists of the following rate elements:

-Service Establishment	-Service Charge	-Port Connection
-User Identification Codes	-Security Card	

When used with BellSouth® AIN Toolkit service, BellSouth® AIN SMS Access service also includes Storage and Session.

- D.** Company Performed Session is an optional rate element for BellSouth AIN SMS Access service.

- E.** BellSouth® AIN SMS Access service is accessed via a Dial/Shared Port Connection at a recommended modem speed of 19.2 Kbps or via ISDN. Users may experience occasional blocking due to sharing of access ports. User Identification Codes and Security Cards may be obtained as needed by the customer.

The expected life of the Security Card battery is thirty months. When the battery fails, the customer must purchase a replacement card.

- F.** Storage is provided by BellSouth® AIN SMS Access service for customer service configuration information. Multiple configurations may be kept on file and may be activated in the AIN by customer command.

ISSUED: November 4, 1997

EFFECTIVE: November 19, 1997

BY: Joseph P. Lacher, President -FL  
Miami, Florida

## E34. ADVANCED INTELLIGENT NETWORK (AIN) SERVICES (N)

### E34.6 BellSouth® AIN SMS Access Service (Cont'd) (N)

#### E34.6.2 Definitions (N)

##### ADVANCED INTELLIGENT NETWORK (AIN) (N)

The Advanced Intelligent Network (AIN) is an evolutionary telecommunications platform that utilizes the infrastructure of the existing switch-based network and Common Channel Signaling System 7 (CCS7) architecture. The AIN architecture introduces centralized computer devices to host service applications that are integrated with Stored Program Control switch resident software, CCS7 and ISDN protocol. (N)

##### SERVICE CONTROL POINT (SCP) (N)

The AIN Service Control Point (SCP) is a CCS7 accessed computer device utilized by the AIN to host AIN service applications and store associated customer data. Upon demand, the SCPs respond to queries from the switch network to provide service application and customer/network routing information prior to call completion. (N)

##### SERVICE MANAGEMENT SYSTEM (SMS) (N)

The Service Management System (SMS) is an AIN Operation Support System that distributes, interfaces and manages the AIN service applications and customer information resident in AIN SCPs and SNs. The SMS provides the capability to provision AIN services and to maintain existing service. (N)

##### SESSION (N)

A Session is the period of time a customer or the Company is logged onto BellSouth® AIN SMS Access service. The total Session time is measured from log-in to log-out. (N)

##### STORAGE UNIT (N)

A Storage Unit is a logical collection of physical records which are stored in the SMS in a record size equivalent to 100 Kilobytes (a kilobyte is equal to 1024 bytes). Storage of information in the SMS is utilized for customer service configuration information. (N)

#### E34.6.3 Regulations (N)

- A. BellSouth® AIN SMS Access service is available as an Unbundled Network Element (UNE) to certified Interexchange Carriers (IXCs) and Competitive Local Exchange Carriers (CLECs) where facilities or arrangements permit. (N)
- B. Except as noted, BellSouth® AIN SMS Access service is subject to all general regulations applicable to the provisioning of service by the Company as stated in Section E2. of this Tariff. (N)
- C. Suspension of Service as specified in Section E2. of this Tariff is not applicable for BellSouth® AIN SMS Access service. (N)
- D. BellSouth® AIN SMS Access service customers can only activate and modify AIN service subscription information that has been ordered from the Company. The functions that can be performed are dependent on the specific AIN service that is being controlled via BellSouth® AIN SMS Access service. (N)
- E. Each user will be required to have a separate User Identification Code. Each User Identification Code will require a Security Card. (N)
- F. ISDN access is required when a BellSouth® AIN SMS Access service customer is also a BellSouth® AIN Toolkit service subscriber. Otherwise, ISDN access is optional. (N)
- G. For Dial/Shared access to BellSouth® AIN SMS Access service, the customer will be required to provide a terminal as specified in I.1 following, an asynchronous dial modem capable of speeds up to 19.2 Kbps and an Exchange Access Line at the customer's premises. Further information related to modem standards may be obtained from the Company. (N)
- H. For ISDN access to BellSouth® AIN SMS Access service, the customer will be required to provide a terminal as specified in I.2 following, ISDN terminal equipment, and an ISDN equipped access line at the customer's premises. (N)
- I. Customer terminal requirements (N)
  - 1. Dial/Shared Access (N)

The type of interface device required at the customer's premises is a VT100 compatible terminal or personal computer equipped with terminal emulation software. The interface device must be compatible with American National Standard Institute (ANSI) standard X3.64. Further information related to interface specifications may be obtained from the Company. (N)

ISSUED: November 4, 1997

EFFECTIVE: November 19, 1997

BY: Joseph P. Lacher, President -FL  
Miami, Florida

## **E34. ADVANCED INTELLIGENT NETWORK (AIN) SERVICES**

### **E34.6 BellSouth® AIN SMS Access Service (Cont'd)**

#### **E34.6.3 Regulations (Cont'd)**

**I. Customer terminal requirements (Cont'd)**

**2. ISDN Access**

The type of interface device required at the customer's premises is a PC or workstation with X Windows software and an ISDN terminal interface. Further information related to interface specifications may be obtained from the Company.

**J.** The customer will be responsible for installation, maintenance and testing of customer provided compatible terminal equipment. The Company does not assume responsibility for the compatibility or suitability of the customer's equipment.

**K.** The Company shall not be responsible if changes in any of the equipment, operations or procedures of the Company utilized in the provision of BellSouth® AIN SMS Access service render any facilities provided by a customer obsolete or require modification or alteration of such equipment or system or otherwise affect its use or performance.

**L.** Reports associated with AIN services controlled by BellSouth® AIN SMS Access service may be downloaded using BellSouth® AIN SMS Access service. These reports are purchased from the tariff section which governs the AIN service being controlled. Any restrictions and limitations on the use of the information contained in the reports are described in the tariff for each individual service. BellSouth AIN Toolkit service, as set forth in E34.7 following, can be controlled using BellSouth® AIN SMS Access service.

#### **E34.6.4 Application of Rates**

**A.** No additional rates and charges (e.g., Service Order Charges) apply to this service except as listed in this section.

**B.** The Service Establishment charge is for the initial establishment of BellSouth® AIN SMS Access service in the state.

**C.** The Service Charge is a nonrecurring charge applicable per wire center per AIN service administered by BellSouth® AIN SMS Access service. A service specific Service Charge monthly rate may also apply.

**D.** A Port Connection charge is applicable for each simultaneous access capability desired by the customer.

**E.** The User Identification Codes charge is a nonrecurring charge applicable per User ID Code requested by the customer. A Security Card is also needed with each User Identification Code.

**F.** The Security Card charge is applicable for initial subscription to a User Identification Code or for replacement of the Security Card.

**G.** Storage charges apply to the amount of storage, measured in units of 100 Kbytes, occupied by a customer's file in the SMS. Storage will be measured on a calendar month and charges for the month will be based on the customer's highest level of storage during the month. For purposes of billing, a partial unit of storage will be rounded up to the nearest unit.

**H.** Session charges apply when the customer accesses BellSouth® AIN SMS Access service. A Session begins when the customer logs onto the SMS and ends when the customer logs off. BellSouth® AIN SMS Access service sessions will incur per minute of use charges based on the duration of the session.

**I.** Sessions performed by the Company at the customer's request will incur the Company Performed Session charge. Sessions performed by the Company during service installation or maintenance will not result in any session charges.

ISSUED: November 4, 1997

EFFECTIVE: November 19, 1997

BY: Joseph P. Lacher, President -FL  
Miami, Florida

**E34. ADVANCED INTELLIGENT NETWORK (AIN) SERVICES** (N)

**E34.6 BellSouth® AIN SMS Access Service (Cont'd)** (N)

**E34.6.5 Rates and Charges** (N)

**A. Rate Elements** (N)

	Nonrecurring Charge	Monthly Rate	USOC	
1. Service Establishment (per State)				(N)
(a) Initial Setup	\$302.16	\$-	CAMSE	(N)
2. Port Connection				(N)
(a) Dial/Shared Access	89.02	-	CAMDP	(N)
(b) ISDN Access	89.02	-	CAM1P	(N)
3. User Identification Codes				(N)
(a) Per User ID Code	206.27	-	CAMAU	(N)
4. Security Card (per User ID Code)				(N)
(a) Initial or Replacement	175.32	-	CAMRC	(N)
5. Storage				(N)
(a) Per Unit	-	0.0031	NA	(N)
		<b>Charge</b>	<b>USOC</b>	
6. Session				(N)
(a) Per Minute		\$0.1059	NA	(N)
7. Company Performed Session				(N)
(a) Per Minute		2.10	NA	(N)

**E34.7 BellSouth® AIN Toolkit Service** (N)

**E34.7.1 General** (N)

- A. BellSouth® AIN Toolkit allows subscribers to access call information and AIN processing capabilities to create customized telephone services according to the needs of the subscriber/end user. (N)  
Subscribers will create services by using a set of tools (i.e., a Service Creation Environment) that allows them to configure the AIN capabilities. After a service has been created, it is verified by the Service Management System (SMS) for completeness. The verified service is provisioned on the AIN network elements of the Public Switched Telephone Network and may be activated or deactivated at the subscriber's discretion. (N)  
A subscriber's created service will require the provisioning of triggers. The triggers available for BellSouth® AIN Toolkit service subscribers include the following: (N)
 

-Terminating Attempt	-10-digit Public Office Dialing Plan (PODP)	-Customized Dialing Plan (CDP)	(N)
-Off-hook Delay	-Off-hook Immediate	-Feature Code	(N)
- B. Access to the Service Creation Environment which is used by BellSouth® AIN Toolkit service subscribers will be through the use of BellSouth® AIN SMS Access service. The use of BellSouth® AIN SMS Access service is mandatory for all BellSouth® AIN Toolkit service subscribers. BellSouth® AIN SMS Access service may be purchased from E34.6 preceding. (N)
- C. BellSouth® AIN Toolkit service subscribers will have access only to those services and information related to those services that they have created. The BellSouth® AIN Toolkit service subscriber may allow multiple users to access the BellSouth® AIN Toolkit service subscription capabilities. (N)
- D. The BellSouth® AIN Toolkit service subscriber will have access to all of the available nodes in the BellSouth® AIN Toolkit service to create Decision Graphs (DG). All nodes may be used in any one DG. The DGs are created using the Decision Graph Editor (DGE) of the Service Creation Environment (SCE). (N)

® BellSouth is a registered trademark of BellSouth Corporation

ISSUED: November 4, 1997

EFFECTIVE: November 19, 1997

BY: Joseph P. Lacher, President -FL  
Miami, Florida

## **E34. ADVANCED INTELLIGENT NETWORK (AIN) SERVICES**

### **E34.7 BellSouth® AIN Toolkit Service (Cont'd)**

#### **E34.7.2 Definitions**

##### **ADVANCED INTELLIGENT NETWORK (AIN)**

The Advanced Intelligent Network (AIN) is an evolutionary telecommunications platform that utilizes the infrastructure of the existing switch based network and Common Channel Signaling System 7 (CCS7) architecture. The AIN architecture introduces centralized computer devices to host service applications that are integrated with Stored Program Control switch resident software, CCS7 and Integrated Services Digital Network (ISDN) protocol.

##### **BASIC MESSAGING ELEMENT**

A basic messaging element is the inquiry sent to a network element database and the instructions returned to complete the call processing.

##### **CREATED SERVICE**

A BellSouth® AIN Toolkit created service is a complete and correctly formed decision graph that has been created by the BellSouth® AIN Toolkit service subscriber by assembling nodes and inputting that capability data required by those nodes.

##### **DECISION GRAPH**

A decision graph depicts a created service as nodes assembled into a tree graph. Traversal of this tree graph from the root to the leaves indicates the series of capabilities (shown as nodes) that will be executed in the processing of a call. Decision graphs are created, read, updated, and modified using decision graph editor software.

##### **DIRECTORY NUMBER (DN)**

A Directory Number is a telephone number in the North American Numbering Plan (NANP) format. The DN types that can be used for BellSouth® AIN Toolkit service are:

- Equipped DN is a DN that has physical line equipment associated with it.
- Unequipped DN is a DN that has no physical line equipment associated with it.

##### **END USER**

An end user is the entity that uses the service that is created by the BellSouth® AIN Toolkit service subscriber.

##### **NODE**

A node is a part of a decision graph capable of performing a certain function.

##### **SERVICE CONTROL POINT (SCP)**

The AIN Service Control Point (SCP) is a CCS7 accessed computer device utilized by the AIN to host AIN service applications and store associated customer data. Upon demand, the SCPs respond to inquires from the switch network to provide service application and customer routing information prior to call completion.

##### **SERVICE CREATION ENVIRONMENT (SCE)**

The Service Creation Environment (SCE) is a set of computer based tools that can be used to provide customer programmability. It allows the BellSouth® AIN Toolkit service subscriber to design, edit, verify, and deploy the service in the network.

##### **SERVICE MANAGEMENT SYSTEM (SMS)**

The Service Management System (SMS) is an AIN Operation Support System that distributes, interfaces, and manages the AIN service applications and customer information resident in AIN SCPs. The SMS provides the capability to provision AIN services and to maintain existing services.

##### **SUBSCRIBER**

The BellSouth® AIN Toolkit service subscriber is the authorized entity that orders, pays for and uses the service creation environment of the BellSouth® AIN Toolkit Platform to create services on its own behalf or on behalf of the end user.

## E34. ADVANCED INTELLIGENT NETWORK (AIN) SERVICES

### E34.7 BellSouth® AIN Toolkit Service (Cont'd)

#### E34.7.2 Definitions (Cont'd)

##### SUBSCRIPTION

The subscription is a DN plus its assigned trigger(s). A subscription is created by making a Decision Graph and associating it with a set of subscription-specific data.

##### TRIGGER

Triggers are interruptions in the processing of AIN calls which instruct the switch to query a network element database for further instructions to complete call processing.

#### E34.7.3 Regulations

- A. BellSouth® AIN Toolkit service is available as an Unbundled Network Element (UNE) to certified Interexchange Carriers (IXCs) and Competitive Local Exchange Carriers (CLECs) where facilities or arrangements permit.
- B. Limitations and use of service as stated in Section E2. of this Tariff will apply.
- C. Suspension of service, as defined in Section E2. of this Tariff, is not applicable for this service.
- D. In no event shall the Company be liable for any losses or damages of any kind resulting from the unavailability of its equipment of facilities or for any act, omission, or failure of performance by the Company or its employees, or agents, in connection with this Tariff. The Company shall not be responsible for calls that can not be completed as a result of repair or maintenance difficulties on Company facilities and equipment nor on equipment owned or leased by the BellSouth® AIN Toolkit service subscriber.
- E. The use of the Off-Hook Immediate trigger, which directs a call immediately to the location selected by the BellSouth® AIN Toolkit service subscriber, affects the end-user's ability to dial 911 or E911 from the end user's telephone. It is the responsibility of the BellSouth® AIN Toolkit subscriber to notify its end users of this to insure that end users are aware that they may not be able to reach 911 or E911 in an emergency, without some further action on the part of the BellSouth® AIN Toolkit subscriber. (N)
- F. When BellSouth® AIN Toolkit service is interrupted due to a failure or malfunction of Company equipment or facilities, a pro rata adjustment of the appropriate monthly charges will be allowed at the request of the BellSouth® AIN Toolkit service subscriber if the system is unavailable to the subscriber and the Company (to perform changes for the subscriber) for more than a 24 hour period and in accordance with the regulations specified in Section E2. of this Tariff. No allowances will be granted for interruptions required to perform preventive or routine maintenance, or to perform software updates when the subscriber is notified at least 24 hours prior to such occurrences. (T)
- G. The BellSouth® AIN Toolkit service subscriber will be responsible for installation, maintenance and testing of customer provided compatible terminal equipment. The Company does not assume responsibility for the compatibility or suitability of the customer's equipment. (T)
- H. The BellSouth® AIN Toolkit service subscriber shall subscribe to adequate facilities to transport the calls to the subscriber locations. (T)
- I. The Company shall not be responsible if changes in any of the equipment, operations, or procedures of the Company utilized in the provision of BellSouth® AIN Toolkit service render any facilities provided by a subscriber obsolete or require modification or alteration of such equipment or system or otherwise affect its use or performance. (T)
- J. BellSouth® AIN Toolkit service requires the use of storage space on the SMS. BellSouth® AIN SMS Access service rates and regulations, as set forth in E34.6 preceding, will apply for BellSouth® AIN Toolkit service. (T)
- K. A BellSouth® AIN Toolkit service subscriber may be temporarily authorized by an end user to create services using the end user's DN(s). (T)
- L. End User Authorization (T)
  - 1. If requested by the Company, BellSouth® AIN Toolkit service subscribers that create services on behalf of end users must provide proof of authorization to alter the provisioning associated with those end users' DNs.
  - 2. End users can revoke their authorization at any time by informing the BellSouth® AIN Toolkit service subscriber of their decision. If an end user requests removal of a trigger, the end user will be referred to the BellSouth® AIN Toolkit service subscriber.
  - 3. The Company will not become involved in disputes between a BellSouth® AIN Toolkit service subscriber and a subscriber's end users. The end user will be referred to the BellSouth® AIN Toolkit service subscriber for resolution of any disagreement.
  - 4. BellSouth® AIN Toolkit service subscribers that create services using DNs that they have acquired in bulk service orders need not provide authorization to alter the provisioning associated with those DNs.

## E34. ADVANCED INTELLIGENT NETWORK (AIN) SERVICES

### E34.7 BellSouth® AIN Toolkit Service (Cont'd)

#### E34.7.3 Regulations (Cont'd)

##### M. Triggers

1. Triggers must be activated within 90 calendar days from the order date. Additionally, deactivated triggers must be reactivated within 90 calendar days from the deactivation date. Triggers not activated/reactivated within the 90 day period will be considered available for provisioning to another subscriber or to the same subscriber. Nonrecurring Trigger Access charges will apply for reprovisioning of triggers to the original subscriber.
2. The BellSouth® AIN Toolkit service subscriber must select the trigger(s) associated with each DN.
3. Triggers can be provisioned only on Company DNs.
4. A DN may have multiple BellSouth® AIN Toolkit triggers active in the network concurrently.
5. A BellSouth® AIN Toolkit service end user can not have more than one AIN service for the same trigger type. This restriction applies whether or not the conflicting AIN service is a BellSouth® AIN Toolkit created service.
6. A service order must be issued to add or delete a trigger.
7. In order to activate a BellSouth® AIN Toolkit service, the BellSouth® AIN Toolkit service subscriber must associate each DN plus a trigger with a decision graph.
8. The Off-hook Delay, Off-hook Immediate, and CDP triggers cannot be provisioned on the same DN.

N. The BellSouth® AIN Toolkit service subscriber may allow the end user to make changes in SMS. (T)

O. The BellSouth® AIN Toolkit service subscriber/end user must select an Interexchange Carrier to do interLATA routing of calls. The Interexchange Carrier may be selected by presubscription, by dialing 101XXXX, or by having it specified by the BellSouth® AIN Toolkit service. (T)

P. Security regulations, as set forth in BellSouth® AIN SMS Access service, E34.6 preceding, will apply to BellSouth® AIN Toolkit service. (T)

Q. The BellSouth® AIN Toolkit service subscriber may allow end users of the BellSouth® AIN Toolkit created service to access subscription data. The type of interface required at the end user's premises is a VT-100 terminal or PC emulating the VT-100 terminal. The interface device must be a modem with a transmission rate of 19.2 Kbps or less. The BellSouth® AIN Toolkit service subscriber will be required to subscribe to a User ID Code and Security Card, per the BellSouth® AIN SMS Access service, as set forth in E34.6 preceding, per end user with access to the BellSouth® AIN Toolkit created service subscription data. (T)

##### R. Decision Graphs

1. The size of the Decision Graphs (DGs) is limited. Information regarding the maximum number of nodes which can be included in a decision graph will be provided to the subscriber at the time BellSouth® AIN Toolkit is purchased.
2. After a DG is created, it must be verified by the BellSouth® AIN Toolkit service subscriber and the SMS.
3. After the DG has been verified, the BellSouth® AIN Toolkit -created service can be activated. Decision graphs may also be deactivated when the BellSouth® AIN Toolkit service subscriber no longer requires the created service.
4. DG changes that require switch translation modifications require a service order.
5. A DG which is causing harm to the network and/or service problems can be deactivated by the Company. In such instances, the BellSouth® AIN Toolkit service subscriber will be informed of the deactivation and will be provided such information as may be available concerning the cause of the problem.
6. Modifications to the DG can be made by Company personnel only when authorized by the BellSouth® AIN Toolkit service subscriber.
7. A DN may have multiple DGs active in the network, where each service uses a different trigger type.
8. Multiple DGs may exist in the SMS for a single trigger on a DN but only one DG may be active at a time.

S. If the BellSouth® AIN Toolkit service subscriber desires to receive Calling Party Number (CPN) or ANI information on a real time basis, they may subscribe to an appropriate service for that information. (T)

ISSUED: September 4, 2002  
BY: Joseph P. Lacher, President -FL  
Miami, Florida

EFFECTIVE: September 19, 2002

## E34. ADVANCED INTELLIGENT NETWORK (AIN) SERVICES

### E34.7 BellSouth® AIN Toolkit Service (Cont'd)

#### E34.7.3 Regulations (Cont'd)

- T. When CPN is delivered to the BellSouth® AIN Toolkit service subscriber for use in service provisioning, the status of the privacy indicator will also be delivered. It is solely the responsibility of the BellSouth® AIN Toolkit service subscriber to handle this information properly and in accordance with the rules, regulations, and laws of the jurisdiction in which the subscriber is doing business. The Company is not liable for any impropriety in the BellSouth® AIN Toolkit service subscriber's handling of CPN information. The Company's only responsibility is to insure that the privacy indicator is delivered to the subscriber with the CPN if the privacy indicator has been set. (T)
- U. Telephone numbers listed in any of the BellSouth® AIN Toolkit service optional call reports are intended solely for use by the BellSouth® AIN Toolkit service subscriber and/or end user. Resale of this information, other than by the subscriber to the end user, is prohibited by this Tariff. (T)
- V. The Company may invoke call gapping as may be necessary for maintenance purposes or to maintain the quality of service in the network. If call gapping is invoked specifically on a BellSouth® AIN Toolkit service subscriber's service, the Company will notify the subscriber as to the reasons this step was required and what measures may be necessary to avoid future recurrence. However, if call gapping is invoked in the network or portion of the network, the subscriber will not be individually notified. (T)
- W. BellSouth® AIN Toolkit service requires storage space on the SCP. This storage is measured in kilobytes. (T)

#### E34.7.4 Restrictions and Limitations

- A. An 800 service number can be used as a point-to number for BellSouth® AIN Toolkit service.
- B. On any individual directory number, each trigger can only be associated with one AIN service.
- C. Certain combinations of triggers cannot be active simultaneously on a directory number. Information regarding such conflicts will be provided to the subscriber at the time BellSouth® AIN Toolkit is purchased.
- D. If a BellSouth® AIN Toolkit service subscriber also subscribes to BCLID, the SCP provided number shall be delivered to the subscriber.

#### E34.7.5 Monthly Reports and Special Studies

- A. BellSouth® AIN Toolkit service Monthly Report
  - 1. The BellSouth® AIN Toolkit service subscriber may subscribe to a report for BellSouth® AIN Toolkit service on a monthly basis. This monthly report may consist of:
    - Number of recorded call attempts to a BellSouth® AIN Toolkit service subscription
    - Number of geographic node lookups per BellSouth® AIN Toolkit service subscription (only if the geographic node is used)
    - The value of the counters for the defined period of time (only if counter incremental nodes are used)
    - Number of times each announcement ID is played (only if announce and collect or terminating announcement nodes are used)
    - Number of calls routed to each terminating number
  - 2. The BellSouth® AIN Toolkit service Monthly Report is provided per BellSouth® AIN Toolkit service subscription.
- B. BellSouth® AIN Toolkit service Special Study
  - 1. The BellSouth® AIN Toolkit service subscriber may request a BellSouth® AIN Toolkit service Special Study at any time after the BellSouth® AIN Toolkit service has been activated. A BellSouth® AIN Toolkit service Special Study contains the same information as the BellSouth® AIN Toolkit service Monthly Report except that the Special Study is conducted over a limited amount of time. The special study interval must be a minimum of five days and a maximum of thirty-one days and must begin at 12:01 A.M., and it cannot span more than one calendar month.
  - 2. The BellSouth® AIN Toolkit service subscriber must request a BellSouth® AIN Toolkit service Special Study through the service ordering process.
  - 3. The BellSouth® AIN Toolkit service subscriber to the BellSouth® AIN Toolkit service Monthly Report or to the BellSouth® AIN Toolkit service Special Study, but cannot subscribe to both during the same period of time.



ISSUED: November 4, 1997

EFFECTIVE: November 19, 1997

BY: Joseph P. Lacher, President -FL  
Miami, Florida

## **E34. ADVANCED INTELLIGENT NETWORK (AIN) SERVICES**

### **E34.7 BellSouth® AIN Toolkit Service (Cont'd)**

#### **E34.7.5 Monthly Reports and Special Studies (Cont'd)**

##### **C. BellSouth® AIN Toolkit service Call Event Report**

1. The BellSouth® AIN Toolkit service subscriber may subscribe to a BellSouth® AIN Toolkit service Call Event Report on a monthly basis. The contents of this report may include parameters such as:
  - The calling telephone number, the terminating telephone number, date, time, and duration of the call, and if the call was busy or ring-no answer.
2. The BellSouth® AIN Toolkit service Call Event Report is provided per BellSouth® AIN Toolkit service subscription.

##### **D. BellSouth® AIN Toolkit service Call Event Special Study**

1. The BellSouth® AIN Toolkit service subscriber may request a BellSouth® AIN Toolkit service Call Event Special Study at any time after the BellSouth® AIN Toolkit service has been activated. A BellSouth® AIN Toolkit service Special Study contains the same information as the BellSouth® AIN Toolkit service Call Event Information Report except that the Special Study is conducted over a limited amount of time. The special study interval must be a minimum of five days and a maximum of thirty-one days and must begin at 12:01 A.M., and it can not span more than one calendar month.
2. The BellSouth® AIN Toolkit service subscriber must request a BellSouth® AIN Toolkit service Call Event Special Study through the service ordering process.
3. The BellSouth® AIN Toolkit service subscriber may subscribe to the BellSouth® AIN Toolkit service Call Event Report or to the BellSouth® AIN Toolkit service Call Event Special Study, but can not subscribe to both during the same period of time.

##### **E. The BellSouth® AIN Toolkit service Monthly Report, the BellSouth® AIN Toolkit service Special Study, the BellSouth® AIN Toolkit service Call Event Report, and the BellSouth® AIN Toolkit service Call Event Special Study are not represented as provision of billing detail.**

##### **F. The BellSouth® AIN Toolkit service Monthly Report and BellSouth® AIN Toolkit service Call Event Report are provided through BellSouth® AIN SMS Access service. The BellSouth® AIN Toolkit service Special Study and the BellSouth® AIN Toolkit service Call Event Special Study will be provided on diskette.**

#### **E34.7.6 Rates and Charges**

##### **A. Application of Rates**

1. No additional rates and charges (e.g., Service Order Charges) apply to this service except as listed in B. following.
2. The Nonrecurring BellSouth® AIN Toolkit service Charge is for the establishment of BellSouth® AIN Toolkit service per State.
3. The nonrecurring charge for trigger access applies per trigger per DN.
4. A charge will apply for each basic messaging element. Some calls to the BellSouth® AIN Toolkit-created service may incur multiple basic messaging element charges.

FLORIDA

ISSUED: November 4, 1997

EFFECTIVE: November 19, 1997

BY: Joseph P. Lacher, President -FL  
Miami, Florida

## E34. ADVANCED INTELLIGENT NETWORK (AIN) SERVICES

### E34.7 BellSouth® AIN Toolkit Service (Cont'd)

#### E34.7.6 Rates and Charges (Cont'd)

##### A. Application of Rates (Cont'd)

5. Application of the BellSouth® AIN Toolkit node charge (N)
  - a. For Type I nodes, the BellSouth® AIN Toolkit node charge applies per trigger per basic messaging element per BellSouth® AIN Toolkit service subscription. Nodes in DGs that are active for part of a day are billed for the whole day. (N)
  - b. Type I nodes are: (N)
    - (1) Announcement Node (N)
    - (2) Announce and Collect Node (N)
    - (3) Geographic Decision Node (N)
    - (4) LATA Decision Node (N)
    - (5) Writes to Flexible Table (N)
    - (6) Log Events Node (N)
6. Storage charges apply to the amount of SCP storage occupied by a BellSouth® AIN Toolkit service subscriber's files. This storage is measured monthly; the rate is applied per 100 kilobytes (or fraction thereof) per LATA. Storage is accumulated per BellSouth AIN SMS Access service account. (N)
7. A Nonrecurring Charge and Monthly Rate apply for BellSouth® AIN Toolkit service Monthly Report if the subscriber selects this service option. (N)
8. A Nonrecurring Charge applies to each BellSouth® AIN Toolkit service Special Study requested by the subscriber. (N)
9. A Nonrecurring Charge and Monthly Rate apply for the BellSouth® AIN Toolkit service Call Event Report if the subscriber selects this service option. (N)
10. A Nonrecurring Charge applies to each BellSouth® AIN Toolkit service Call Event Special Study requested by the subscriber. (N)
11. A Nonrecurring Charge and Monthly Rate apply for the BellSouth® AIN Toolkit service Call Detail Information if the subscriber selects this service option. (N)

ISSUED: November 4, 1997

EFFECTIVE: November 19, 1997

BY: Joseph P. Lacher, President -FL  
Miami, Florida

**E34. ADVANCED INTELLIGENT NETWORK (AIN) SERVICES**

**E34.7 BellSouth® AIN Toolkit Service (Cont'd)**

**E34.7.6 Rates and Charges (Cont'd)**

**B. Rates**

	<b>Nonrecurring Charge</b>	<b>Monthly Rate</b>	<b>USOC</b>	
1. Service Establishment Charge (Per state)				(N)
(a) Initial Setup	<b>\$297.31</b>	<b>\$-</b>	<b>BAPSC</b>	(N)
2. Training Session				(N)
(a) Per Customer	<b>8,453.00</b>	<b>-</b>	<b>BAPVX</b>	(N)
3. Trigger Access Charge (Per trigger, per DN)				(N)
(a) Terminating Attempt	<b>74.45</b>	<b>-</b>	<b>BAPTT</b>	(N)
(b) Off-hook Delay	<b>74.45</b>	<b>-</b>	<b>BAPTD</b>	(N)
(c) Off-hook Immediate	<b>74.45</b>	<b>-</b>	<b>BAPTM</b>	(N)
(d) 10-digit PODP	<b>153.29</b>	<b>-</b>	<b>BAPTO</b>	(N)
(e) CDP	<b>153.29</b>	<b>-</b>	<b>BAPTC</b>	(N)
(f) Feature Code	<b>153.29</b>	<b>-</b>	<b>BAPTF</b>	(N)
		<b>Rate</b>	<b>USOC</b>	
4. Basic Messaging Element Charge				(N)
(a) Per basic messaging element		<b>\$0.0278</b>	<b>NA</b>	(N)
5. Type I Node Charge (per BellSouth® AIN Toolkit service subscription)				(N)
(a) Per node, per basic messaging element		<b>0.0070</b>	<b>NA</b>	(N)
6. SCP Storage Charge (per BellSouth® AIN SMS Access service account)				(N)
(a) Per 100 kilobytes (or fraction thereof)		<b>1.94</b>	<b>NA</b>	(N)
	<b>Nonrecurring Charge</b>	<b>Monthly Rate</b>	<b>USOC</b>	
7. Monthly Report				(N)
(a) Per BellSouth® AIN Toolkit service subscription	<b>\$73.63</b>	<b>\$16.17</b>	<b>BAPMS</b>	(N)
8. Special Study				(N)
(a) Per BellSouth® AIN Toolkit service subscription	<b>48.26</b>	<b>-</b>	<b>BAPLS</b>	(N)
9. Call Event Report				(N)
(a) Per BellSouth® AIN Toolkit service subscription	<b>73.63</b>	<b>16.07</b>	<b>BAPDS</b>	(N)
10. Call Event Special Study				(N)
(a) Per BellSouth® AIN Toolkit service subscription	<b>48.26</b>	<b>-</b>	<b>BAPES</b>	(N)

®BellSouth is a registered trademark of BellSouth Corporation

BELLSOUTH  
TELECOMMUNICATIONS, INC.  
FLORIDA  
ISSUED: July 1, 1996  
BY: Joseph P. Lacher, President - FL  
Miami, Florida

ACCESS SERVICE TARIFF

Original Page 1

EFFECTIVE: July 15, 1996

**E100. RESERVED FOR FUTURE USE <sup>1</sup>**

(N)

CONTENTS

New	Old
Page	Page
1	1

**Note 1:** Text is shown as new due to reissue of all Tariff Sections. No changes in rates or regulations were made with this filing.

EFFECTIVE: July 15, 1996

**E100. RESERVED FOR FUTURE USE<sup>1</sup>**

(N)

**Note 1:** Text is shown as new due to reissue of all Tariff Sections. No changes in rates or regulations were made with this filing.

BELLSOUTH  
TELECOMMUNICATIONS, INC.  
FLORIDA  
ISSUED: July 1, 1996  
BY: Joseph P. Lacher, President - FL  
Miami, Florida

ACCESS SERVICE TARIFF

Original Page 1

EFFECTIVE: July 15, 1996

**E101. RESERVED FOR FUTURE USE<sup>1</sup>**

(N)

CONTENTS

New Page	Old Page
1	1

**Note 1:** Text is shown as new due to reissue of all Tariff Sections. No changes in rates or regulations were made with this filing.

FLORIDA  
ISSUED: July 1, 1996  
BY: Joseph P. Lacher, President - FL  
Miami, Florida

EFFECTIVE: July 15, 1996

**E101. RESERVED FOR FUTURE USE<sup>1</sup>**

(N)

**Note 1:** Text is shown as new due to reissue of all Tariff Sections. No changes in rates or regulations were made with this filing.

BELLSOUTH  
TELECOMMUNICATIONS, INC.  
FLORIDA  
ISSUED: July 1, 1996  
BY: Joseph P. Lacher, President - FL  
Miami, Florida

ACCESS SERVICE TARIFF

Original Page 1

EFFECTIVE: July 15, 1996

**E102. RESERVED FOR FUTURE USE<sup>1</sup>**

(N)

CONTENTS

New	Old
Page	Page
1	1

**Note 1:** Text is shown as new due to reissue of all Tariff Sections. No changes in rates or regulations were made with this filing.



ISSUED: July 1, 1996

EFFECTIVE: July 15, 1996

BY: Joseph P. Lacher, President - FL  
Miami, Florida

**E102. RESERVED FOR FUTURE USE<sup>1</sup>**

(N)

**Note 1:** Text is shown as new due to reissue of all Tariff Sections. No changes in rates or regulations were made with this filing.

BELLSOUTH  
TELECOMMUNICATIONS, INC.  
FLORIDA  
ISSUED: July 1, 1996  
BY: Joseph P. Lacher, President - FL  
Miami, Florida

ACCESS SERVICE TARIFF

Original Page 1

EFFECTIVE: July 15, 1996

**E103. RESERVED FOR FUTURE USE <sup>1</sup>**

(N)

CONTENTS

New Page	Old Page
1	1

**Note 1:** Text is shown as new due to reissue of all Tariff Sections. No changes in rates or regulations were made with this filing.

ISSUED: July 1, 1996  
BY: Joseph P. Lacher, President - FL  
Miami, Florida

EFFECTIVE: July 15, 1996

**E103. RESERVED FOR FUTURE USE<sup>1</sup>**

(N)

**Note 1:** Text is shown as new due to reissue of all Tariff Sections. No changes in rates or regulations were made with this filing.

BELLSOUTH  
TELECOMMUNICATIONS, INC.  
FLORIDA  
ISSUED: July 1, 1996  
BY: Joseph P. Lacher, President - FL  
Miami, Florida

ACCESS SERVICE TARIFF

Original Page 1

EFFECTIVE: July 15, 1996

**E104. RESERVED FOR FUTURE USE<sup>1</sup>**

(N)

CONTENTS

New	Old
Page	Page
1	1

**Note 1:** Text is shown as new due to reissue of all Tariff Sections. No changes in rates or regulations were made with this filing.

BELLSOUTH  
TELECOMMUNICATIONS, INC.  
FLORIDA  
ISSUED: July 1, 1996  
BY: Joseph P. Lacher, President - FL  
Miami, Florida

ACCESS SERVICE TARIFF

Original Page 1

EFFECTIVE: July 15, 1996

**E104. RESERVED FOR FUTURE USE<sup>1</sup>**

(N)

**Note 1:** Text is shown as new due to reissue of all Tariff Sections. No changes in rates or regulations were made with this filing.

EFFECTIVE: July 15, 1996

**E105. RESERVED FOR FUTURE USE<sup>1</sup>**

(N)

CONTENTS

New	Old
Page	Page
1	1

**Note 1:** Text is shown as new due to reissue of all Tariff Sections. No changes in rates or regulations were made with this filing.

FLORIDA  
ISSUED: July 1, 1996  
BY: Joseph P. Lacher, President - FL  
Miami, Florida

EFFECTIVE: July 15, 1996

**E105. RESERVED FOR FUTURE USE<sup>1</sup>**

(N)

**Note 1:** Text is shown as new due to reissue of all Tariff Sections. No changes in rates or regulations were made with this filing.

BELLSOUTH  
TELECOMMUNICATIONS, INC.  
FLORIDA  
ISSUED: July 1, 1996  
BY: Joseph P. Lacher, President - FL  
Miami, Florida

ACCESS SERVICE TARIFF

Original Page 1

EFFECTIVE: July 15, 1996

**E106. RESERVED FOR FUTURE USE<sup>1</sup>**

(N)

CONTENTS

New Page	Old Page
1	1

**Note 1:** Text is shown as new due to reissue of all Tariff Sections. No changes in rates or regulations were made with this filing.



BELLSOUTH  
TELECOMMUNICATIONS, INC.  
FLORIDA  
ISSUED: July 1, 1996  
BY: Joseph P. Lacher, President - FL  
Miami, Florida

ACCESS SERVICE TARIFF

Original Page 1

EFFECTIVE: July 15, 1996

**E106. RESERVED FOR FUTURE USE<sup>1</sup>**

(N)

**Note 1:** Text is shown as new due to reissue of all Tariff Sections. No changes in rates or regulations were made with this filing.

BELLSOUTH  
TELECOMMUNICATIONS, INC.  
FLORIDA  
ISSUED: July 1, 1996  
BY: Joseph P. Lacher, President - FL  
Miami, Florida

ACCESS SERVICE TARIFF

Original Page 1

EFFECTIVE: July 15, 1996

**E107. RESERVED FOR FUTURE USE<sup>1</sup>**

(N)

CONTENTS

New	Old
Page	Page
1	1

**Note 1:** Text is shown as new due to reissue of all Tariff Sections. No changes in rates or regulations were made with this filing.

FLORIDA

ISSUED: July 1, 1996

EFFECTIVE: July 15, 1996

BY: Joseph P. Lacher, President - FL  
Miami, Florida

**E107. RESERVED FOR FUTURE USE<sup>1</sup>**

(N)

**Note 1:** Text is shown as new due to reissue of all Tariff Sections. No changes in rates or regulations were made with this filing.

BELLSOUTH  
TELECOMMUNICATIONS, INC.  
FLORIDA  
ISSUED: July 1, 1996  
BY: Joseph P. Lacher, President - FL  
Miami, Florida

ACCESS SERVICE TARIFF

Original Page 1

EFFECTIVE: July 15, 1996

**E108. RESERVED FOR FUTURE USE<sup>1</sup>**

(N)

CONTENTS

New	Old
Page	Page
1	1

**Note 1:** Text is shown as new due to reissue of all Tariff Sections. No changes in rates or regulations were made with this filing.

BELLSOUTH  
TELECOMMUNICATIONS, INC.  
FLORIDA  
ISSUED: July 1, 1996  
BY: Joseph P. Lacher, President - FL  
Miami, Florida

ACCESS SERVICE TARIFF

Original Page 1

EFFECTIVE: July 15, 1996

**E108. RESERVED FOR FUTURE USE <sup>1</sup>**

(N)

**Note 1:** Text is shown as new due to reissue of all Tariff Sections. No changes in rates or regulations were made with this filing.

BELLSOUTH  
TELECOMMUNICATIONS, INC.  
FLORIDA  
ISSUED: July 1, 1996  
BY: Joseph P. Lacher, President - FL  
Miami, Florida

ACCESS SERVICE TARIFF

Original Page 1

EFFECTIVE: July 15, 1996

**E109. RESERVED FOR FUTURE USE<sup>1</sup>**

(N)

CONTENTS

New	Old
Page	Page
1	1

**Note 1:** Text is shown as new due to reissue of all Tariff Sections. No changes in rates or regulations were made with this filing.

BELLSOUTH  
TELECOMMUNICATIONS, INC.  
FLORIDA  
ISSUED: July 1, 1996  
BY: Joseph P. Lacher, President - FL  
Miami, Florida

ACCESS SERVICE TARIFF

Original Page 1

EFFECTIVE: July 15, 1996

**E109. RESERVED FOR FUTURE USE<sup>1</sup>**

(N)

**Note 1:** Text is shown as new due to reissue of all Tariff Sections. No changes in rates or regulations were made with this filing.

BELLSOUTH  
TELECOMMUNICATIONS, INC.  
FLORIDA  
ISSUED: July 1, 1996  
BY: Joseph P. Lacher, President - FL  
Miami, Florida

ACCESS SERVICE TARIFF

Original Page 1

EFFECTIVE: July 15, 1996

**E110. RESERVED FOR FUTURE USE<sup>1</sup>**

(N)

CONTENTS

New	Old
Page	Page
1	1

**Note 1:** Text is shown as new due to reissue of all Tariff Sections. No changes in rates or regulations were made with this filing.



BELLSOUTH  
TELECOMMUNICATIONS, INC.  
FLORIDA  
ISSUED: July 1, 1996  
BY: Joseph P. Lacher, President - FL  
Miami, Florida

ACCESS SERVICE TARIFF

Original Page 1

EFFECTIVE: July 15, 1996

**E110. RESERVED FOR FUTURE USE<sup>1</sup>**

(N)

**Note 1:** Text is shown as new due to reissue of all Tariff Sections. No changes in rates or regulations were made with this filing.

BELLSOUTH  
TELECOMMUNICATIONS, INC.  
FLORIDA  
ISSUED: July 1, 1996  
BY: Joseph P. Lacher, President - FL  
Miami, Florida

ACCESS SERVICE TARIFF

Original Page 1

EFFECTIVE: July 15, 1996

**E111. RESERVED FOR FUTURE USE<sup>1</sup>**

(N)

CONTENTS

New Page	Old Page
1	1

**Note 1:** Text is shown as new due to reissue of all Tariff Sections. No changes in rates or regulations were made with this filing.

BELLSOUTH  
TELECOMMUNICATIONS, INC.  
FLORIDA  
ISSUED: July 1, 1996  
BY: Joseph P. Lacher, President - FL  
Miami, Florida

ACCESS SERVICE TARIFF

Original Page 1

EFFECTIVE: July 15, 1996

**E111. RESERVED FOR FUTURE USE<sup>1</sup>**

(N)

**Note 1:** Text is shown as new due to reissue of all Tariff Sections. No changes in rates or regulations were made with this filing.

FLORIDA

ISSUED: July 1, 1996

BY: Joseph P. Lacher, President - FL  
Miami, Florida

EFFECTIVE: July 15, 1996

**E112. RESERVED FOR FUTURE USE<sup>1</sup>**

(N)

CONTENTS

New	Old
Page	Page
1	1

**Note 1:** Text is shown as new due to reissue of all Tariff Sections. No changes in rates or regulations were made with this filing.

BELLSOUTH  
TELECOMMUNICATIONS, INC.  
FLORIDA  
ISSUED: July 1, 1996  
BY: Joseph P. Lacher, President - FL  
Miami, Florida

ACCESS SERVICE TARIFF

Original Page 1

EFFECTIVE: July 15, 1996

**E112. RESERVED FOR FUTURE USE<sup>1</sup>**

(N)

**Note 1:** Text is shown as new due to reissue of all Tariff Sections. No changes in rates or regulations were made with this filing.

EFFECTIVE: July 15, 1996

**E113. OBSOLETE SERVICE OFFERINGS - ADDITIONAL ENGINEERING,  
ADDITIONAL LABOR AND MISCELLANEOUS CHARGES<sup>1</sup>**

(N)

CONTENTS

	New Page	Old Page
<b>E113.1 Reserved for Future Use</b>	1	1
<b>E113.2 Reserved for Future Use</b>	1	1
<b>E113.3 Miscellaneous Charges</b>	1	1
E113.3.1 Reserved for Future Use	1	1
E113.3.2 Restoration Priority	1	1

**Note 1:** Text is shown as new due to reissue of all Tariff Sections. No changes in rates or regulations were made with this filing.

EFFECTIVE: July 15, 1996

**E113. OBSOLETE SERVICE OFFERING - ADDITIONAL ENGINEERING,  
ADDITIONAL LABOR AND MISCELLANEOUS CHARGES<sup>1</sup>**

(N)

**E113.1 Reserved for Future Use**

**E113.2 Reserved for Future Use**

**E113.3 Miscellaneous Charges**

**E113.3.1 Reserved for Future Use**

**E113.3.2 Restoration Priority**

(Obsoleted 4-8-91) Not offered in connection with new service or changes in existing service on and after 4-8-91. Restoration Priority will remain in this Tariff until March 10, 1993 when it will be removed as a service offering. Restoration Priority has been replaced by Telecommunications Service Priority (TSP) System Service in E13.3.9 for qualifying customers.

A. The Company will arrange a Dedicated Access Service for Restoration Priority on receipt of certification in conformance with Part 64, Subpart D, Appendix A of the Federal Communication Commission's Rules and Regulations.

1. A charge applies when a request to provide or change a Restoration Priority is received subsequent to the issuance of an Access Order to install the service. No charge applies when a Restoration Priority is discontinued.

	<b>Nonrecurring Charge</b>	<b>USOC</b>
(a) Restoration Priority, per service arranged	<b>\$104.02</b>	-

**Note 1:** Text is shown as new due to reissue of all Tariff Sections. No changes in rates or regulations were made with this filing.

ISSUED: March 16, 2004  
BY: Joseph P. Lacher, President -FL  
Miami, Florida

EFFECTIVE: March 31, 2004

**E126. OBSOLETE SERVICE OFFERING - BELLSOUTH SWA CONTRACT TARIFFS** (N)

**CONTENTS** (N)

<b>E126.1</b>	<b>BellSouth SWA Contract Tariff No. FL2002-01</b>	1	(N)
E126.1.1	General Regulations	1	(N)
E126.1.2	Subscription Conditions	1	(N)
E126.1.3	Mergers and Acquisitions and Transfer of Service	2	(N)
E126.1.4	BellSouth SWA Revenue Volume Discounts	3	(N)
E126.1.5	BellSouth SWA Contract Tariff No. FL2002-01 Volume Discount Plan	3	(N)



EFFECTIVE: March 31, 2004

**E126. OBSOLETE SERVICE OFFERING - BELLSOUTH SWA CONTRACT TARIFFS** (N)

**E126.1 BellSouth SWA Contract Tariff No. FL2002-01** (O)(T)

(Obsoleted 3-31-04, Type 4) Not available for new contracts or renewal after the effective date of the tariff. (N)

**E126.1.1 General Regulations** (O)(T)

- A. The start date of BellSouth SWA Contract Tariff No. FL2002-01 is the first bill period following subscription to this contract tariff. (O)
- B. BellSouth SWA Contract Tariff No. FL2002-01 shall terminate on August 13, 2007. (O)
- C. The regulations, terms, conditions and volume discounts provided herein shall apply to the customer's applicable BellSouth SWA usage and revenues achieved in the state of Florida. (O)
- D. A customer that is similarly situated may subscribe within a period of thirty (30) days following the effective date of BellSouth SWA Contract Tariff No. FL2002-01. (O)

**E126.1.2 Subscription Conditions** (O)(T)

- A. To subscribe to BellSouth SWA Contract Tariff No. FL2002-01, the customer and the Company must execute a Letter of Agreement. The Company shall provide a Letter of Agreement for the customer to execute. The Letter of Agreement shall contain:
  - 1. BellSouth SWA Contract Tariff Number (O)
  - 2. Start and termination date of BellSouth SWA Contract Tariff (O)
  - 3. Customer's Name and Billing Address (O)
  - 4. Billing Account Number the credit will be applied (O)
  - 5. Access Customer Name Abbreviations (ACNAs) and Customer Identifications Codes (CICs) to be included in the BellSouth SWA Contract Tariff (O)
  - 6. BellSouth SWA Contract Tariff term (i.e., 36, 48 or 60 months) (O)
  - 7. Minimum Usage Discount Table (O)
- B. To subscribe to BellSouth SWA Contract Tariff No. FL2002-01, the customer must have been a BellSouth SWA customer for the previous 18-months. (O)
- C. When the customer subscribes to BellSouth SWA Contract Tariff No. FL2002-01, the customer must identify to the Company, all Access Customer Name Abbreviations (ACNAs) and Carrier Identification Codes (CICs) to be included in BellSouth SWA Contract Tariff No. FL2002-01. (O)
- D. The customer must be the billing responsible party for all BellSouth SWA billing elements associated with the ACNAs and CICs included in BellSouth SWA Contract No. FL2002-01. (O)
- E. Any additions after the Letter of Agreement is executed will be handled as a merger or acquisition or transfer of service regulations as set forth in *E126.1.3* following. (O)(T)
- F. A customer subscribing to BellSouth SWA Contract Tariff No. FL2002-01 may not subscribe to any other BellSouth SWA Contract Tariff that contains services as set forth in G. following. (O)
- G. The following BellSouth SWA services will be used in determining the BellSouth SWA revenues that are eligible to receive the volume discount based on the established minimum local switching usage. (O)
  - 1. BellSouth SWA Common Transport Service (O)
    - Facility Termination, per minute of use (O)
    - Per Mile, per minute of use (O)
    - DS3 to DS1 Multiplexer, per minute of use (O)
    - DS1 to VG Multiplexer, per minute of use (O)
  - 2. Access Tandem Switching (O)
    - Dedicated Tandem Trunk Port Service (O)
      - Per DSO/VG trunk port required (O)
      - Per DS1 trunk port required (O)
    - DS1 to VG Channelization (O)

EFFECTIVE: March 31, 2004

**E126. OBSELETE SERVICE OFFERING - BELLSOUTH SWA CONTRACT TARIFFS** (N)

**E126.1 BellSouth SWA Contract Tariff No. FL2002-01 (Cont'd)** (O)(T)

**E126.1.2 Subscription Conditions (Cont'd)** (O)(T)

G. (Cont'd) (O)

3. Local Switching (O)

Local Switching 1 (O)

Local Switching 2 (O)

Local Switching 3 (O)

Local Switching 4 (O)

Common Trunk Port Service (O)

Per each Common Transport trunk termination, per minute of use (O)

Dedicated End Office Trunk Port Service (O)

Per DSO/VG trunk port required (O)

Per DS1 trunk port required (O)

H. A customer may not combine its local switching minutes of use with another customer, whether an individual, partnership, association or corporation, for the purpose of meeting the established minimum local switching usage, as set forth in **E126.1.5.B.** following. (O)(T)

I. Cancellation of BellSouth SWA Contract Tariff No. FL2002-01 (O)

1. During the term period of BellSouth SWA Contract Tariff No. FL2002-01, a customer may cancel BellSouth Contract Tariff No. FL2002-01 and subsequently subscribe to another BellSouth SWA Contract Tariff only one time. (O)

2. Cancellation of BellSouth SWA Contract Tariff No. FL2002-01 and subscription to another BellSouth SWA Contract Tariff is allowed only on the anniversary date of BellSouth SWA Contract Tariff No. FL2002-01 and upon meeting one of the following conditions: (O)

a. During the first year of BellSouth SWA Contract Tariff No. FL2002-01, the local switching usage achieved is 10 percent below the minimum usage; (O)

b. During the remaining years of BellSouth SWA Contract Tariff No. FL2002-01, the local switching usage is below the minimum usage. (O)

c. Local switching usage exceeds the discount usage cap. (O)

d. Customer adds CIC codes that are desired to become part of the volume discount contract tariff. (O)

J. Rates and charges for the BellSouth SWA services included in BellSouth SWA Contract Tariff No. FL2002-01 are as set forth in Section E6. of this Tariff. General regulations and ordering options for the BellSouth SWA services are as set forth in Sections E2. and E5. of this Tariff. (O)

**E126.1.3 Mergers and Acquisitions and Transfer of Service** (O)(T)

A. In the event the customer merges with another company or is acquired by another company; the following regulations will apply: (O)

1. The customer may elect to terminate subscription to BellSouth SWA Contract Tariff No. FL2002-01. (O)

2. The customer may not combine revenues with the merged or acquired company's revenues for the purpose of obtaining volume discounts provided under BellSouth SWA Contract Tariff No. FL2002-01. (O)

3. The customer may continue subscribing to BellSouth SWA Contract Tariff No. FL2002-01 for the duration of the contract term provided that the customer continues the subscription as if it were the same entity that existed prior to the merger or acquisition. (O)

B. If customer requests a transfer of service, pursuant to Transfer of Service regulations in Sections E2. and E6. of this Tariff, the customer's subscription to BellSouth SWA Contract Tariff No. FL2002-01 shall be terminated. (O)

**E126. OBSOLETE SERVICE OFFERING - BELLSOUTH SWA CONTRACT TARIFFS** (N)

**E126.1 BellSouth SWA Contract Tariff No. FL2002-01 (Cont'd)** (O)(T)

**E126.1.4 BellSouth SWA Revenue Volume Discounts** (O)(T)

- A. Each year of BellSouth SWA Contract Tariff No. FL2002-01 is defined as twelve (12) consecutive bill periods. For purposes of calculating the BellSouth SWA volume discounts, month 1 is the bill period after the beginning date of BellSouth SWA Contract Tariff No. FL2002-01. For example, if the beginning date of BellSouth SWA Contract Tariff No. FL2002-01 is June 6, 2002 bill period, then month 1 for purposes of calculating the BellSouth SWA volume discounts will be the July 6, 2002 bill period. (O)
- B. The BellSouth SWA volume discounts provided herein will be determined during the first month after the end of each year of the BellSouth SWA Contract Tariff No. FL2002-01. During the second month following the end of each year of the BellSouth SWA Contract Tariff No. FL2002-01, the BellSouth SWA volume discounts will be applied via a credit to the customer's bill. (O)
- C. True-up provisions will be made during the first quarter after the termination date of BellSouth SWA Contract No. FL2002-01. (O)
- D. The BellSouth SWA volume discounts are applicable to the usage sensitive and recurring revenues of the BellSouth SWA services as set forth in *E126.1.2.G.* preceding. (O)(T)
- E. The BellSouth SWA volume discounts specified in BellSouth SWA Contract Tariff No. FL2002-01 will not be applied to taxes and nonrecurring BellSouth SWA revenues. (O)
- F. The BellSouth SWA services to which the volume discounts provided under BellSouth SWA Contract Tariff No. FL2002-01 apply shall only be subject to service assurance warranty regulations specified in E2.4.4 of this Tariff. (O)

**E126.1.5 BellSouth SWA Contract Tariff No. FL2002-01 Volume Discount Plan** (O)(T)

- A. BellSouth SWA Contract Tariff No. FL2002-01 provides for annual volume discounts based upon annual local switching minutes of use (MOU) above a stated minimum usage. Annual volume discounts will be determined by the local switching usage volume and the year of the contract in which the local switching usage volume is achieved. (O)
- B. The minimum usage and the achievable volume discounts associated with the BellSouth SWA services are shown in the table below. Volume discounts are not applicable to any usage levels outside of the MOU usage ranges stated in table below: (O)

Minimum Usage (MOU)	Usage Ranges (MOU)	Volume Discount Percentages				
		Year 1	Year 2	Year 3	Year 4	Year 5
1,054,830,619	1,054,830,619 – 1,075,927,232	7%	-	-	-	-
	>1,075,927,232 – 1,160,313,681	10%	15%	20%	-	-
	>1,160,313,681 – 1,371,279,805	15%	20%	25%	30%	35%

- C. The annual local switching usage included in BellSouth SWA Contract Tariff No. FL2002-01 eligible for volume discount is determined by subtracting the minimum usage from the achieved local switching usage for each year. (O)
- D. Dividing the annual local switching usage eligible for volume discount for a given year of BellSouth SWA Contract Tariff No. FL2002-01 by the minimum local switching usage will develop the usage factor. (O)
- E. A usage factor (greater than zero) will be applied to the eligible BellSouth SWA revenue generated by the BellSouth SWA services identified in *E126.1.2.G.* preceding. This calculation produces the annual revenue eligible for discount. (O)(T)
- F. The discount percent achieved, as set forth in B. preceding, is based upon the minimum usage required, the usage factor achieved and the term year. (O)
- G. The volume discount received for a given year under BellSouth SWA Contract Tariff No. FL2002-01 is determined by multiplying the eligible BellSouth SWA revenue times the discount factor achieved. (O)

**E126. OBSOLETE SERVICE OFFERING - BELLSOUTH SWA CONTRACT TARIFFS** (N)

**E126.1 BellSouth SWA Contract Tariff No. FL2002-01 (Cont'd)** (O)(T)

**E126.1.5 BellSouth SWA Contract Tariff No. FL2002-01 Volume Discount Plan (Cont'd)** (O)(T)

H. Following is an example of how the annual BellSouth SWA volume discount will be determined. (O)

BellSouth SWA Contract Tariff Volume Discount Calculation (O)

Customer Information (O)

Customer subscribed to a five year BellSouth SWA Contract Tariff and is in the 4<sup>th</sup> year of the contract term. The customer's local switching minimum usage is 5,000,000,000 minutes of use. The annual local switching usage for year 4 is 5,750,000,000 minutes of use and the eligible BellSouth SWA revenues for year 4 is \$25,000,000. (O)

Year 4 Usage Eligible for Discount = Year 4 Usage - Minimum Usage (O)

= 5.75B MOU - 5B MOU (O)

= 750M MOU (O)

Year 4 Usage Factor =  $\frac{\text{Year 4 Annual Usage}}{\text{Minimum Usage}}$  (O)

=  $\frac{750M \text{ MOU}}{5B \text{ MOU}}$  (O)

= .15 (O)

Year 4 Revenue Eligible for Discount = Year 4 Usage Factor X Year 4 eligible BellSouth SWA Revenue (O)

= .15 X \$25,000,000 (O)

= \$3,750,000 (O)

Year 4 Volume Discount = Year 4 Revenue Eligible for Discount X Discount Factor (O)

= \$3,750,000 X .30 (O)

= \$1,125,000 (O)