

EV DC FAST CHARGER Manual
FC50K-CC-S



IMPORTANT

The information provided in this documentation contains general descriptions and/or technical characteristics of the performance of the products contained herein.

This documentation is not intended as a substitute for and is not to be used for determining suitability or reliability of these products for specific user applications.

It is the duty of any such user or integrator to perform the appropriate and complete risk analysis, evaluation and testing of the products with respect to the relevant specific application or use thereof.

If you have any suggestions for improvements or amendments or have found errors in this publication, please notify us.

No part of this document may be reproduced in any form or by any means, electronic or mechanical, including photocopying, without express written permission of Signet System Inc.

All pertinent state, regional, and local safety regulations must be observed when installing and using this product.

For reasons of safety and to help ensure compliance with documented system data, only the manufacturer should perform repairs to components.

When devices are used for applications with technical safety requirements, the relevant instructions must be followed.

Failure to use Signet systems software or approved software with our hardware products may result in injury, harm, or improper operating results.

INDEX

Page Section Description

IMPORTANT SAFETY INSTRUCTIONS	4
1. INTRODUCTION	6
2. APPLICATION	6
3. RECEIVING THE CHARGER	6
4. STORAGE	6
5. MOVING AND TRANSPORT	6
6. GENERAL CHARACTERISTICS	7
7. MECHANICAL CHARACTERISTICS	
7-1. Dimensions	8
7-2. Inside / Outside view	10
8. BLOCK DIAGRAM	12
9. INSTALLATION	
9-1. Location	13
9-2. Installation Procedure	13
9-3. 208V Wiring procedure standard DC fast charger	14
9-4. 208V Wiring & Grounding	14
9-5. 480V Wiring procedure standard DC fast charger	15
9-6. 480V Wiring & Grounding	15
10. Charging operation	
10-1. Checking Installation condition	16
10-2. Operating sequence	16
10-3. Prepare for Test Run	17
10-4. Accessing hidden program menu	18
10-5. Setting Password	19
10- 6. Charging system initial setting	20
10- 7. Administrator Setting	22
10-8. Start Charging	23
10-9. Stop Charging	24
10-10. Error situation	25
10-11. Emergency Stop	25
11. MAINTENANCY	
11-1. Checking filter and Replacement	26
11-2. Checking Module Status	26
11-3. Order of Replacing Module	27
11-4. Assembly of Module	28
11-5. Fault code and Trouble shooting	28
12. Warranty	30

IMPORTANT SAFETY INSTRUCTIONS















1. SAVE THESE INSTRUCTIONS :











This manual contains important instructions for the Signet DC Fast Chargers that shall be followed during installation, operation and maintenance of the unit.

2. Read the instructions carefully and become familiar with the equipment before attempting to install, operate, or maintain it. The following special messages may appear throughout this document or on the equipment to warn of potential hazards or to call attention to information that explains a procedure.



LOOK FOR THIS SYMBOL TO POINT OUT SAFETY PRECAUTIONS. IT MEANS: *BE ALERT—YOUR SAFETY IS INVOLVED*. IF YOU DO NOT FOLLOW THESE SAFETY INSTRUCTIONS, INJURY OR PROPERTY DAMAGE CAN OCCUR.

3.  **READ FIRST:** There is important safety information throughout this document. Read this manual in its entirety before attempting any owner maintenance or trouble shooting.
4.  **QUALIFIED:** Signet chargers must be installed, uninstalled and serviced by a qualified electrician in full compliance with all local and regional electric authorities. This manual and its content do not in any way, relieve the reader of responsibility to follow local safety codes and standards.
5.  **ELECTRIC SHOCK!** : The potential for lethal electrical shock exists. Service to internal parts of a charger may only be performed by a qualified technician.
6.  **DO NOT MODIFY:** This Signet Systems charger should not be modified in any way. This will void the warranty, compromise protection and could result in a possible shock or fire hazard.
7.  **DANGER:** To reduce the risk of fire or electric shock, carefully read and follow these important safety and operating instructions before installing or operating the charger.
8.  **DANGER:** Risk of electric shock. Disconnect charger from EV and ac power before servicing. Turning off the charger does not reduce this risk.
9.  **DANGER:** Do not touch un-insulated parts of the output connector. A possibility of serious electrical shock exists.
10.  **DANGER:** Do not operate the charger with damaged cable, including cables with exposed conductors or damaged connectors. Replace damaged cables before operation.
11.  **DANGER:** Do not disassemble the charger. Have the charger examined by your dealer's qualified service technician. Incorrect re-assembly of the charger may result in an explosion, electric shock, or fire.
12.  **DANGER:** Inlet area of vehicle and the charger connector in the wet state, the charger should not be used.
13.  **DANGER:** Disconnect both ac and dc power from the charger before opening the case. Contact with live components within the charger could cause electrical shock, serious injury, or death.
14.  **DANGER:** Install and ground the charger in accordance with the national electric code and your local electric code. Failure to properly ground the charger could result in a fatal electric shock.
15.  **WARNING:** Do not leave the charger unattended while charging.
16.  **WARNING:** Do not allow water, moisture or foreign objects into the charger.

17.  **WARNING:** Do not place the charger on or near a flammable object while in use. Keep away from carpets, cluttered workbenches, etc.
18.  **WARNING:** Do not cover the air intake holes on the charger as this could cause the charger to overheat.
19.  **WARNING:** Young children should be supervised to ensure that they do not play with the appliance.
20.  **WARNING:** The user is responsible for conforming to all local and national electrical codes and standards applicable in the jurisdiction this equipment is installed in to.
21.  **WARNING:** Do not connect or disconnect the plug while the charger on. Doing so will cause arcing and burning of the connector resulting in charger damage or battery explosion.
22.  **WARNING:** Do not operate the charger with the door open or with any panels removed.
23.  **WARNING:** Do not operate the charger if it has been dropped, received a sharp blow, or otherwise damaged in any way. Call your service representative.
24.  **WARNING:** Dusty environments may require more frequent maintenance to obtain maximum life and optimum performance.
25.  **ELECTRIC SHOCK!** Risk of electric shock. Capacitor stores hazardous energy. Do not open back door of charger until 5 minutes after disconnecting all source of supply.
26.  **WARNING:** Make sure turn off the power to the charger before performing any maintenance procedures.

1. INTRODUCTION

Thank you for purchase this 'FC50K-CC-S' charger. We are sure you will be pleased with its performance and features. In order to ensure that you obtain the maximum from its operation, please read the following instructions carefully.

2. APPLICATION

This charger has been designed to only Electric Vehicle Supply Equipment. It should not be used for charging other types of batteries.

3. RECEIVING THE CHARGER

Unpack the charger and examine it for shipping damage. In the event that shipping damage is found, report it as a claim with the freight company.

Check the charger nameplate against packing lists and purchase orders to verify receipt of proper equipment. If there are any discrepancies notify the shipper immediately.

All shipments leaving manufacturing have been carefully inspected. If a shipment arrives with the crating or packing damaged, have the carrier note the condition on the receipt. Check as soon as possible for concealed damage. If damage has occurred, notify and file a claim with the carrier at once. Do not return the unit to the shipper. Failure to follow this procedure may result in refusal by the carrier to honor any claims.

4. STORAGE

When the charger is stored prior to being installed and powered up, it must be stored indoors in a clean and dry environment where the temperatures will remain within the range of -40 °F to 150 °F (-40 °C to 65 °C). The charger should be stored upright in the shipping carton that it was shipped in. This will help protect the charger from dust and abrasion. It should be stored in an area where it is not likely to be damaged. Do not stack anything on top of the charger.

5. MOVING AND TRANSPORT

Care should be taken when lifting units with forklifts or pallet jacks. Forks should extend completely under charger so as to prevent accidents.

6. GENERAL CHARACTERISTICS

Type		CHAdeMO + SAE COMBO	
Model		FC50K-CC-S	
Mechanical Max. Size, Weight		680D x 780.4W x 1129H (mm) *ADA Compliant	
AC Input	Voltage	3phase 4wire, AC 380 ~ 480V (Fundamental) 3phase 3wire, AC 200 ~ 280V (Optional)	
	Frequency	50/60 Hz	
	Power Factor	Over 0.95	
	Amperage requirement for 50kW output	3P-3Wire (208V)	3P-4Wire (480V)
154.39A		66.90A	
DC Output	Max. Voltage	500 Vdc	
	Max. Current	120 Adc	
	Max. Power	50 KW	
Operating Temperature		-25°C to +40°C	
Protective Function		Reverse polarity protection Short circuit protection Over temperature protection Over-voltage / Under-voltage protection Ground fault detection	
BMS Communication		CAN2.0A/B [CHAdeMO] PLC [SAE Combo]	
Protocol		CHAdeMO protocol Ver0.9 [CHAdeMO] SAE J1772 (IEC 15118) [SAE Combo]	
Cooling		Cooling Fans	
Compliance and Safety		CE, CHAdeMO, KS, cMETus (MET Listed to UL Standards)	
Display	LCD	7 inch Touch Screen	
	LED	3 Color LED lights - status indicator	
User Recognition		RFID card	
Option	Billing	Credit card billing system	
	Communication	SKY using CDMA or GSM Compliant with Open Charge Point Protocol	
Connection	Output	JEVS G105, YAZAKI (4.1m) [CHAdeMO] J1772, REMA (4.1m) [SAE Combo]	

7. MECHANICAL CHARACTERISTICS

7-1. Dimensions

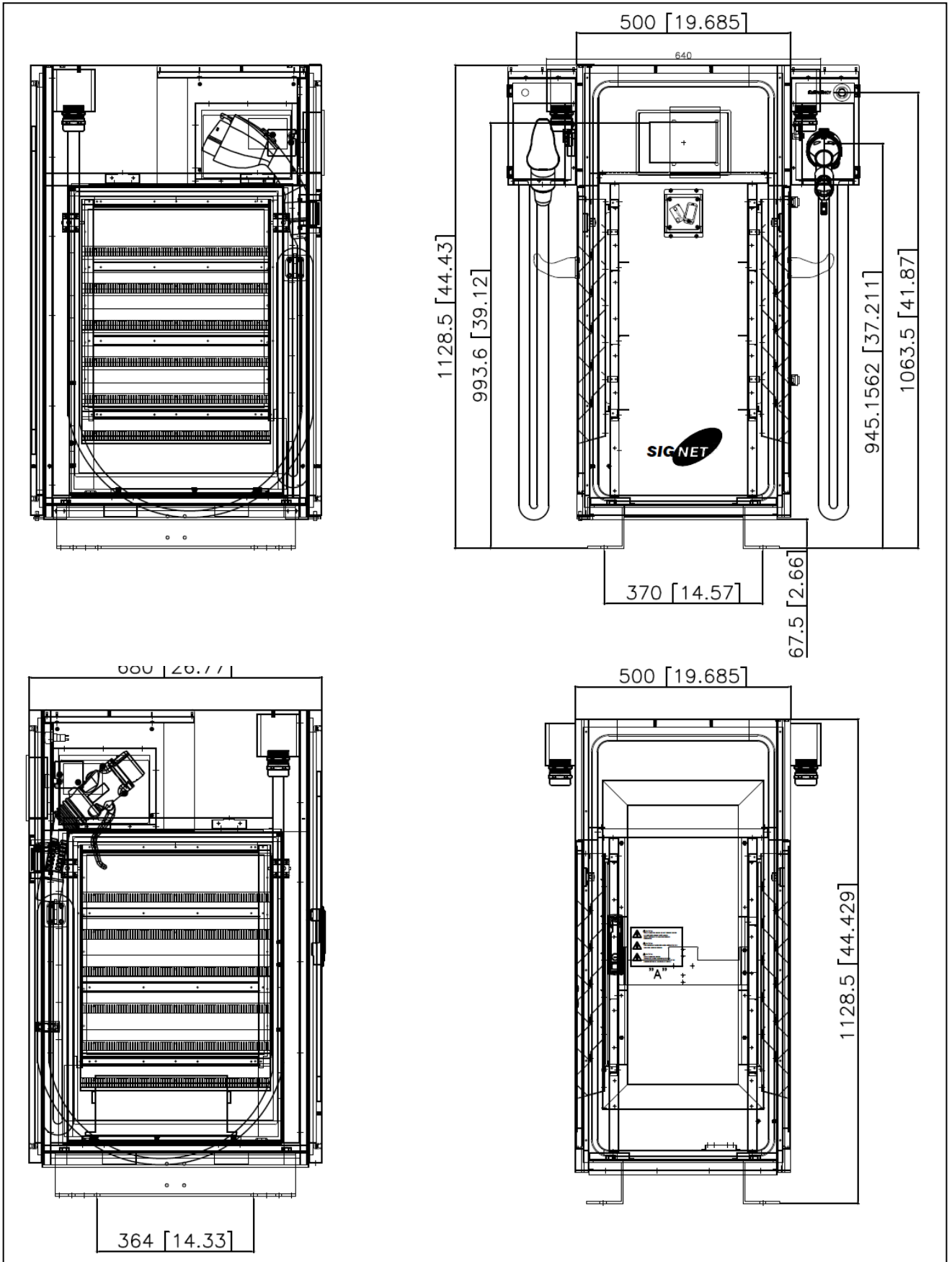

7-2. Inside/Outside view

[3-Phase 3-Wire]

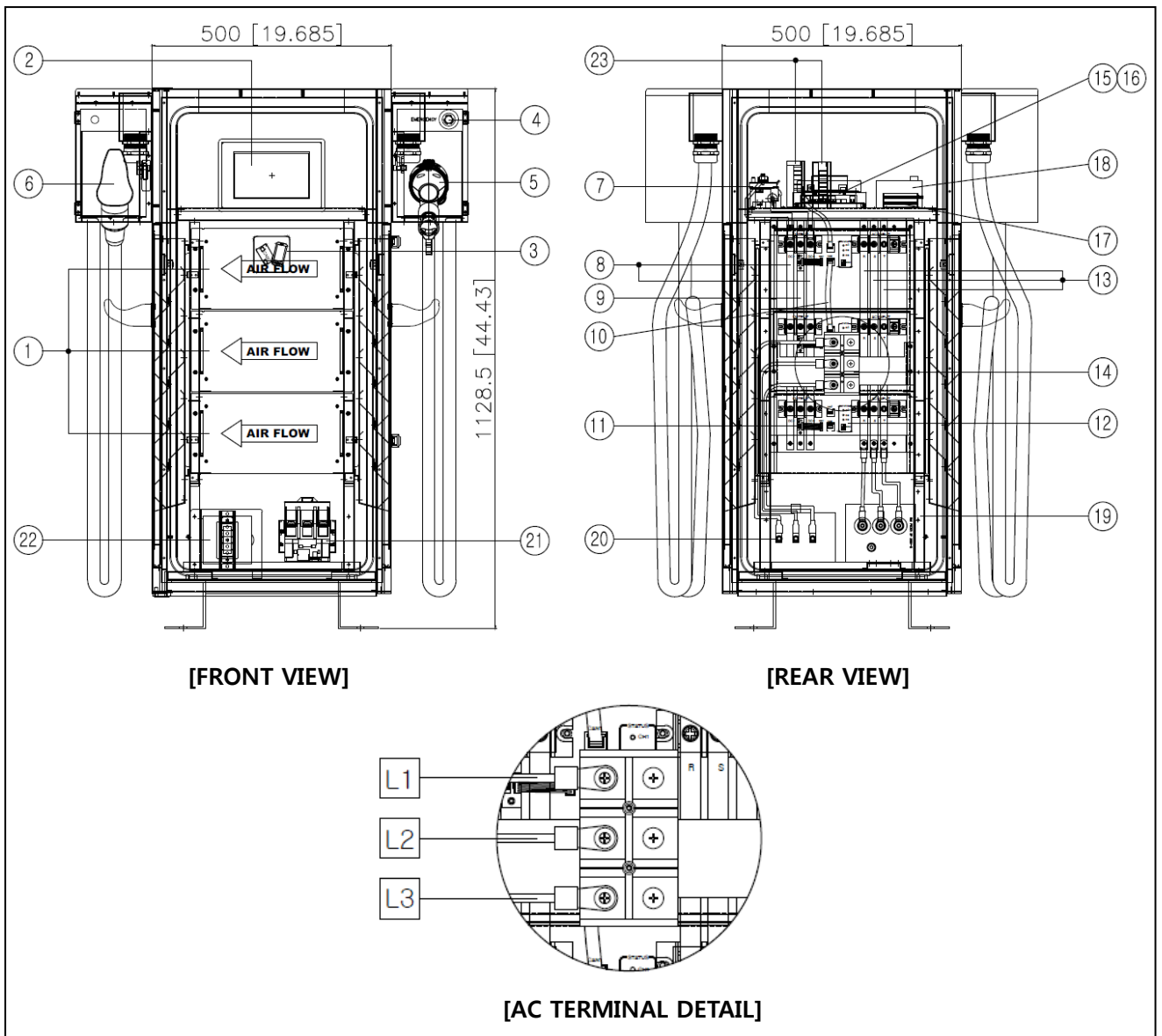

No.	Parts Name	No.	Parts Name
1	Module Case	13	AC Input BUSBAR (R,S,T)
2	7" Touch Screen	14	AC Terminal BLOCK
3	RF Card Reader	15	Main Control Board
4	Emergency Switch	16	PLC Modem
5	CHAdEMO Charging Connector	17	Modem
6	SAE J1772 CCS1 Combo Connector	18	Hub
7	DC Relay	19	Noise Filter (EMI)
8	DC-, DC+ Output BUSBAR	20	Main Power Circuit Breaker
9	Module Setting BAR	21	Magnetic Contactor
10	CAN Jumper Cable	22	AC Watt-hour Meter
11	Module Setting Board & Cable Set	23	AC/DC SMPS
12	Module Status LED		

[3-Phase 4-Wire]

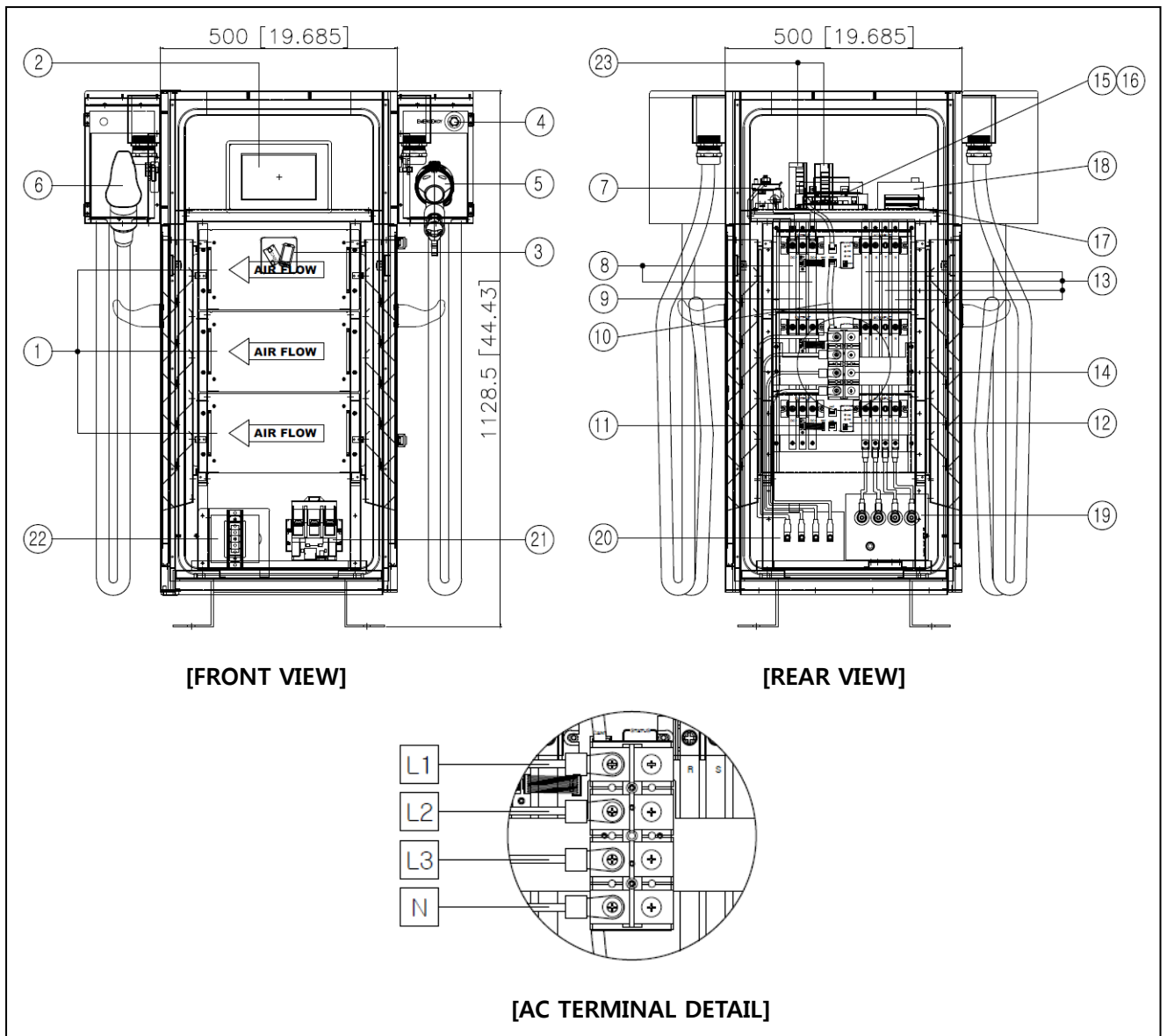

No.	Parts Name	No.	Parts Name
1	Module Case	13	AC Input BUSBAR (R,S,T,N)
2	7" Touch Screen	14	AC Terminal BLOCK
3	RF Card Reader	15	Main Control Board
4	Emergency Switch	16	PLC Modem
5	CHAdEMO Charging Connector	17	Modem
6	SAE J1772 CCS1 Combo Connector	18	Hub
7	DC Relay	19	Noise Filter (EMI)
8	DC-, DC+ Output BUSBAR	20	Main Power Circuit Breaker
9	Module Setting BAR	21	Magnetic Contactor
10	CAN Jumper Cable	22	AC Watt-hour Meter
11	Module Setting Board & Cable Set	23	AC/DC SMPS
12	Module Status LED		

8. BLOCK DIAGRAM

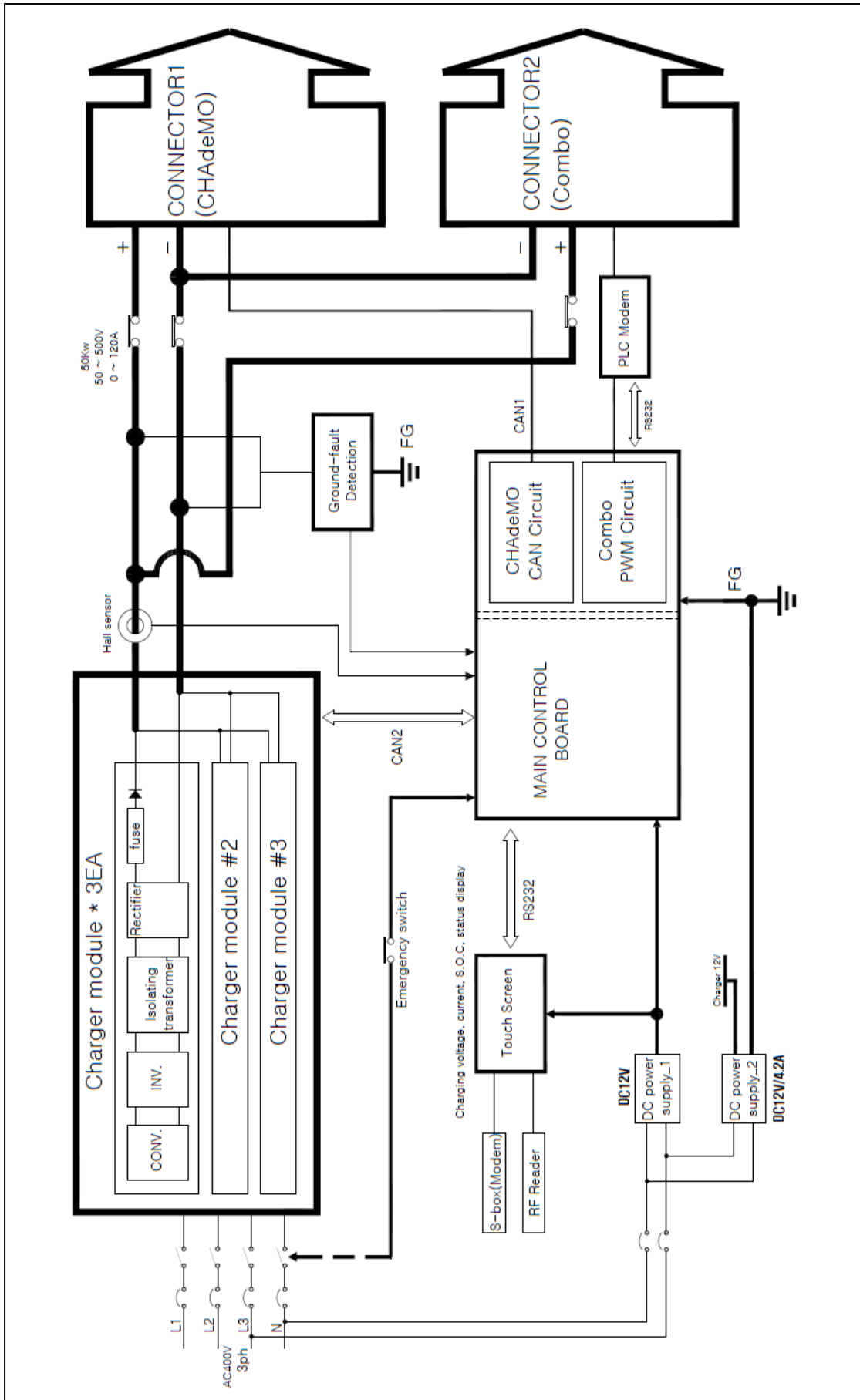

9. INSTALLATION

9-1. Location

- 1) For the best operating conditions and longest life, please take care in selecting an installation site. Operating life and performance will be influenced by charger location. It is recommended not to be exposed high temperatures, dust, corrosive fumes, combustible materials, or explosive gases.
- 2) Select a dry and well-ventilated location.
- 3) Allow 3 ft from charger in order to ensure clear level space.
- 4) Do not cover the vents on the left and right side of the charger for proper ventilation.
- 5) To reduce the risk of fire, install the charger on a non-combustible surface such as concrete, stone, brick, or steel.
- 6) The front of the charger must remain unobstructed for serviceability.

9-2. Installation Procedure

The cabinet must be fixed on a concrete base complying with the following.

Our recommendation for concrete base size is minimum 1000(W)x1000(D)x100(H) mm.

- 1) Fix the channel base included in the package and drilling four anchor holes (55mm depth) as shown in the picture with red circle

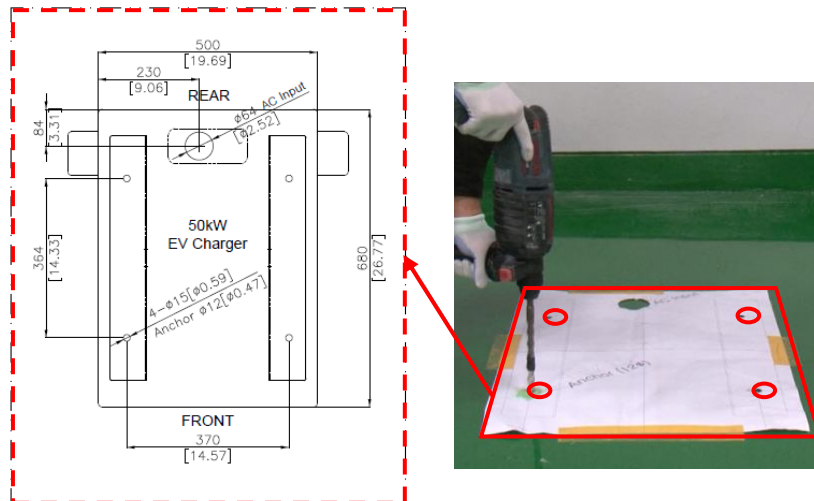

- 2) Position the charger on the base frame with **M12, 4" length** anchor bolt. And fix the charger on the base frame with the nuts and washers as shown in the picture below. The length of the anchor bolt may vary according to the material of the floor. (4" length is for concrete base)



9-3. 208V Wiring procedure standard DC fast charger

208V Wiring

The wiring connection of this Fast Charger shall be made with the following

- 1) Make sure the wiring breaker (MCCB or ELCB) for the AC power supply is OFF.
- 2) Make sure the input AC is 0V.
- 3) Make sure the main power MCB/RCD and control power ELCB of the appliance are both OFF.
- 4) Remove the plastic hood on the Main power circuit breaker.
- 5) Connect AC input cables conductors to the Main power circuit breaker
- 6) Connect grounding conductors to the connection terminals.
- 7) Use waterproof paste on the cables (where they enter the charger on the input plate) to guarantee IP44.
- 8) Do not forget to put the plastic hood back on the circuit breaker.

9-4. 208V Wiring & Grounding

This unit is to be connected to a grounded, metal, permanent wiring system; or an equipment-grounding conductor is to be run with circuit conductors and connected to equipment-grounding terminal or lead on battery charger. Connections to battery charger shall comply with all local codes and ordinances.

⚠ DANGER: IMPROPER CONNECTION OF THE GROUNDING CONDUCTOR CAN RESULT IN A RISK OF ELECTRIC SHOCK.

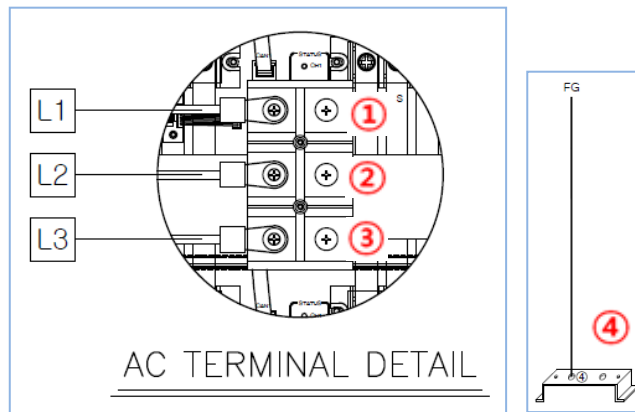

[3P3W-208V]

NO.	Terminal Assignment	
	3P3W (208V)	
①	Phase 1 (L1), M8	
②	Phase 2 (L2), M8	
③	Phase 3 (L3), M8	
④	Input ground terminal (FG), M8	
Set Max. Power according to the Input Amperage		
	Amperage at 208V	Max. Power of charger
Initial	154.39	50kW
	138.95	45kW
	123.51	40kW
	108.07	35kW
	82.63	30kW
	77.19	25kW

Note:

- The AC feed power cables to the charger are not included.
- The section for feed cables is 35 to 70mm². However, within this range, selected section is based on the distance between distribution board and charger (to be decided by customer's electrician for installation).
- A disconnecting switch has to be installed on the customer's distribution board.

⚠ To set maximum power of charger, see 10-6 Administrator Setting on page 20. This procedure must be done, if you want to use less capacity of feed cables.

9-5. 480V Wiring procedure standard DC fast charger

480V Wiring

The wiring connection of this Fast Charger shall be made with the following

- 1) Make sure the wiring breaker (MCCB or ELCB) for the AC power supply is OFF.
- 2) Make sure the input AC is 0V.
- 3) Make sure the main power MCB/RCD and control power ELCB of the appliance are both OFF.
- 4) Remove the plastic hood on the Main power circuit breaker.
- 5) Connect AC input cables conductors to the Main power circuit breaker
- 6) Connect grounding conductors to the connection terminals.
- 7) Use waterproof paste on the cables (where they enter the charger on the input plate) to guarantee IP44.
- 8) Do not forget to put the plastic hood back on the circuit breaker.

9-6. 480V Wiring & Grounding

This unit is to be connected to a grounded, metal, permanent wiring system; or an equipment-grounding conductor is to be run with circuit conductors and connected to equipment-grounding terminal or lead on battery charger. Connections to battery charger shall comply with all local codes and ordinances.

⚠ DANGER: IMPROPER CONNECTION OF THE GROUNDING CONDUCTOR CAN RESULT IN A RISK OF ELECTRIC SHOCK.

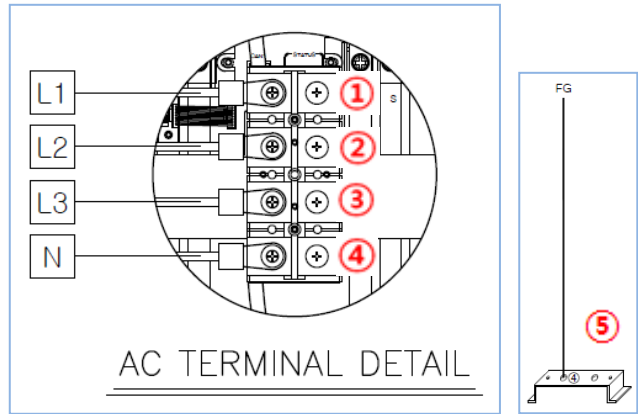

[3P4W-480V]

NO.	Terminal Assignment	
	3P4W(480V)	
①	Phase 1 (L1), M8	
②	Phase 2 (L2), M8	
③	Phase 3 (L3), M8	
④	Neutral (N), M8	
⑤	Input ground terminal (FG), M8	
Set Max. Power according to the Input Amperage		
	Amperage at 480V	Max. Power of charger
Initial	66.90	50kW
	60.21	45kW
	53.52	40kW
	46.83	35kW
	40.14	30kW
	33.45	25kW

Note:

- The AC feed power cables to the charger are not included.
- The section for feed cables is 35 to 70mm². However, within this range, selected section is based on the distance between distribution board and charger (to be decided by customer's electrician for installation).
- A disconnecting switch has to be installed on the customer's distribution board.

⚠ To set maximum power of charger, see 10-6 Administrator Setting on page 20. This procedure must be done, if you want to use less capacity of feed cables.

10. Charging operation

! **DANGER:** TO PREVENT ELECTRICAL SHOCK, DO NOT TOUCH UNINSULATED PARTS OF THE CHARGER DC OUTPUT CONNECTOR, BATTERY CONNECTOR, OR BATTERY TERMINALS. MAKE SURE ALL ELECTRICAL CONNECTORS ARE IN GOOD WORKING CONDITION. DO NOT USE CONNECTORS THAT ARE CRACKED OR CORRODED TO MAKE ADEQUATE ELECTRICAL CONTACT. USE OF A DAMAGED OR DEFECTIVE CONNECTOR MAY RESULT IN A RISK OF OVERHEATING OR ELECTRIC SHOCK.

10-1. Checking Installation condition

Make sure the charger has been installed according to the directions in this manual. Failure to do so could result in personal injury and damage to the equipment.

10-2. Operating sequence

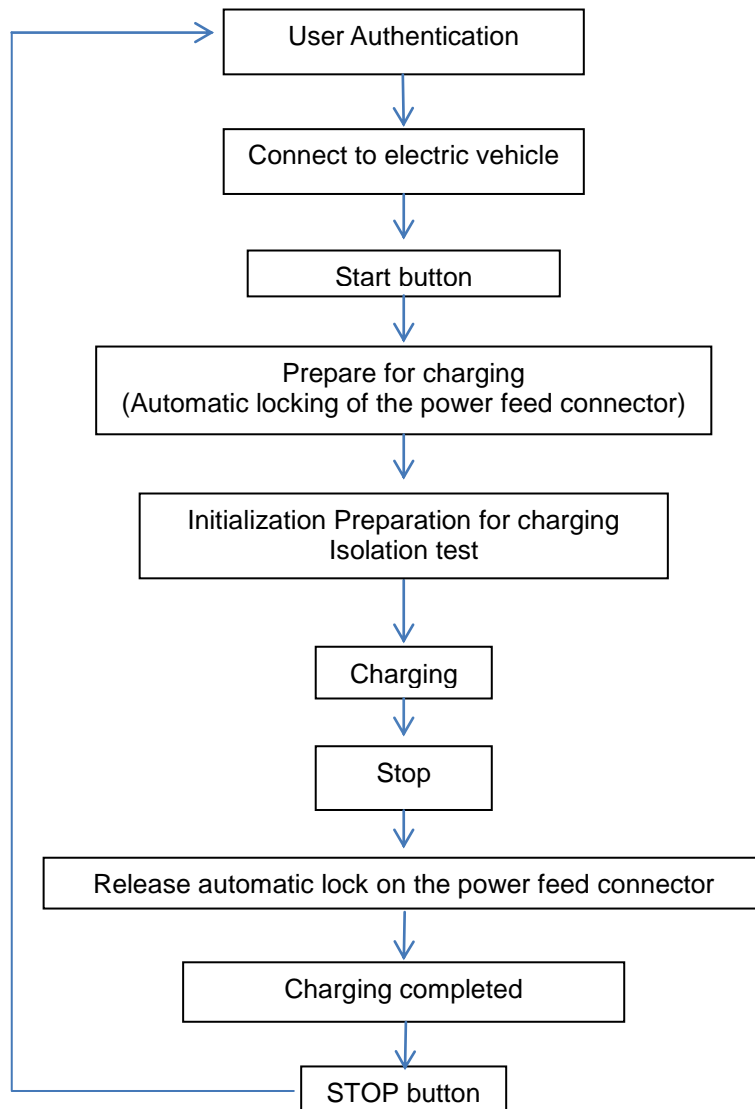

10-3. Prepare for test run

- ① Rear door open
 - Unlock the door with key provide

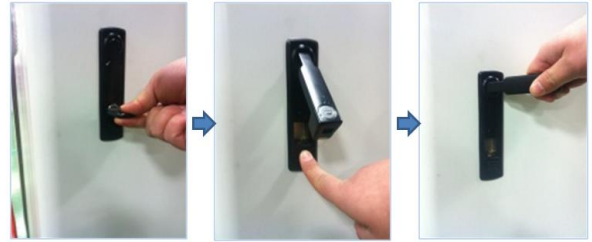

- ② Switch ON control power disconnecting device
 - Switch ON control power disconnecting device located on the bottom right.
 - Check power LED turned on RED in front.
 - Check whether internal module numbers are shown from 1 to 3

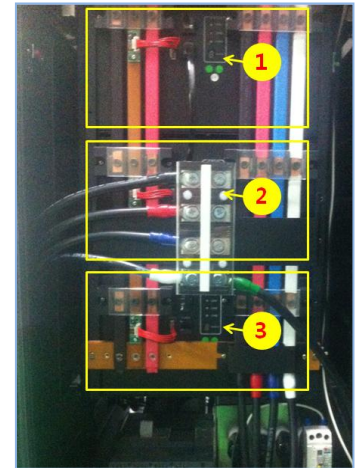

- ③ Switch ON main circuit breaker
 - After checking standby screen for card authentication and module numbers, switch ON main circuit breaker located on the bottom left.
 - Check whether every unit status LED for each module is ON.
 - If every unit status LED is ON, all preparations for charge are completed.



③ Main power circuit breaker

② Control power circuit breaker



- ④ Closing rear door
 - If the above process is completed, make sure to close rear door before charging for safety.

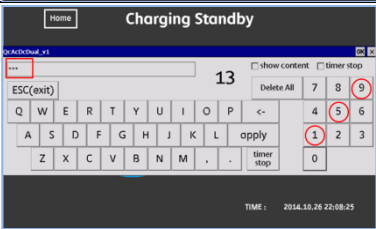
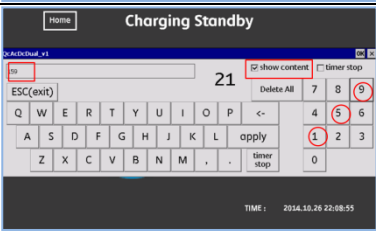
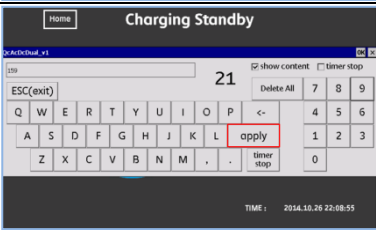
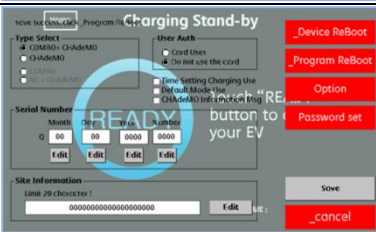

10-4. Accessing hidden program menu

STEP	Procedure	Description
1		<p>To access hidden menu,</p> <ul style="list-style-type: none"> - Hit the upper left corner of LCD touch screen (Nearby red box marked area in the picture.)
2-1		<p>Insert access code 1, 5, 9 in the pop up dialog box appeared.</p> <ul style="list-style-type: none"> - Normally access code will shown as * symbol for the security reason.
2-2		<ul style="list-style-type: none"> - If you want to display access code by numeric, check ✓ at the 'show content' check box.
2-3		<p>Hit the 'apply' button followed by access code insert.</p> <ul style="list-style-type: none"> - If there is not any insert for 30 seconds during accessing hidden menu, LCD display will be initialized. - To initialize immediately, hit the 'ESC(exit)' button.
3		<p>Hidden Menu display appeared.</p>

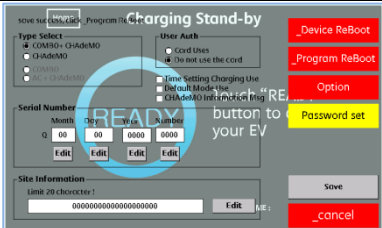
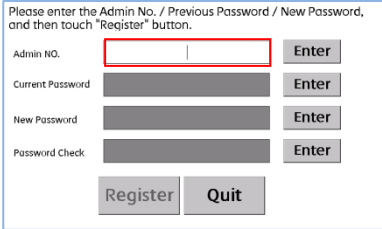
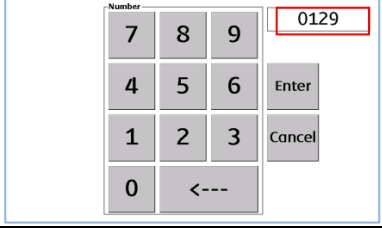
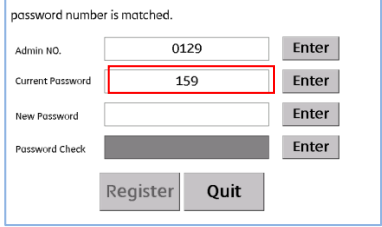
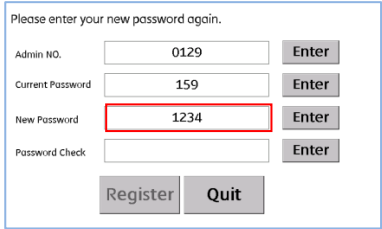
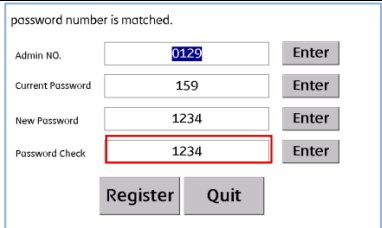
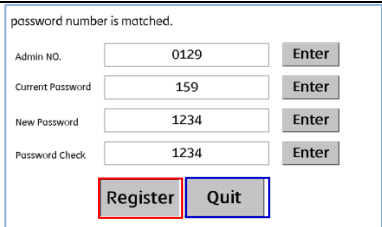
10-5. Setting Password

STEP	Procedure	Description
1		<p>To access password setting menu</p> <ul style="list-style-type: none"> - Hit 'Password set' button on the hidden menu screen. - Password setting screen will appear as step 2.
2-1		<p>To activate keypad</p> <ul style="list-style-type: none"> - Hit 'Enter' then keypad will appear.
2-2		<p>Insert admin number 0, 1, 2, 9 on pop-up screen</p> <ul style="list-style-type: none"> - Keypad will be closed when hit 'enter'
2-3		<p>Insert factory setting password 1, 5, 9. In the blank field.</p>
2-4		<p>Insert new password you desire, and then hit 'Enter'.</p>
2-5		<p>Insert the new password again and hit 'Enter'.</p> <ul style="list-style-type: none"> -Message will show as password confirmed for the admin number
2-6		<p>Hit ① 'Register' to save new password.</p> <ul style="list-style-type: none"> - To finish and close password set screen, hit ② 'Quit' button.

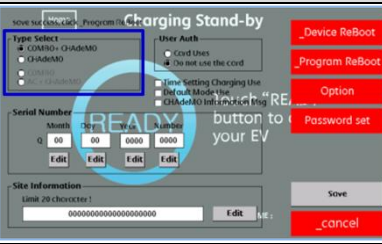
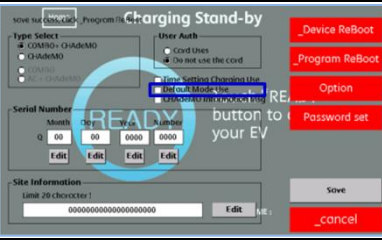
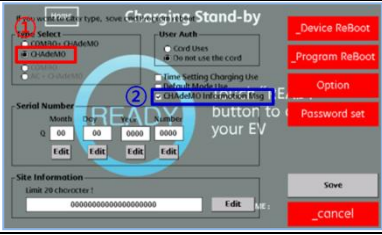
10-6. Charging system initial setting

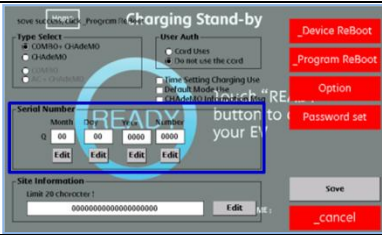
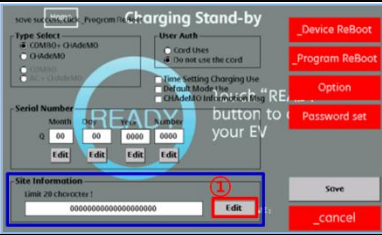
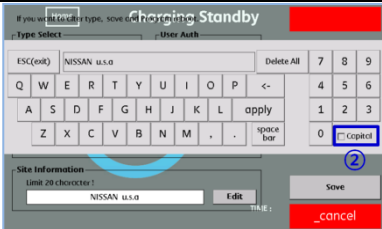

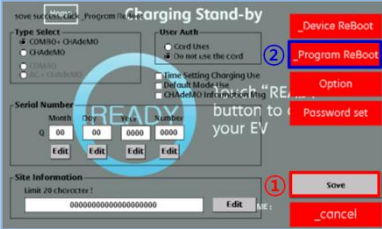
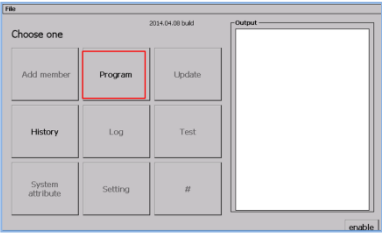

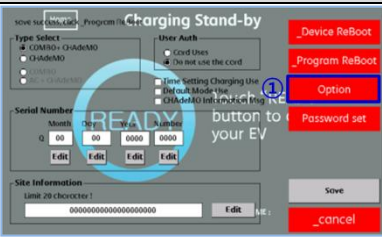
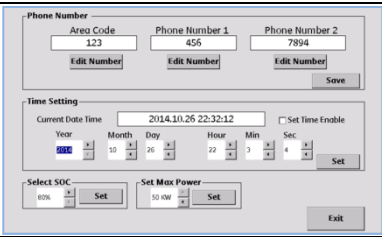
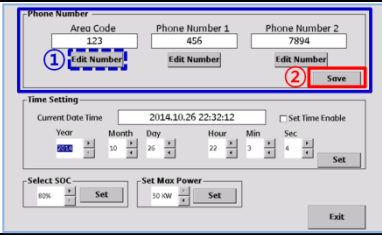
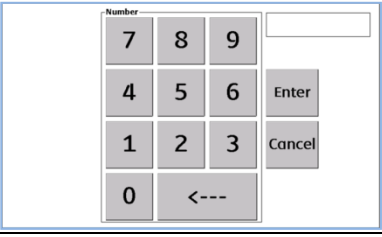
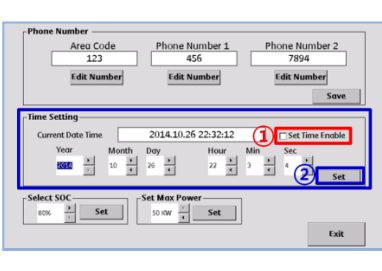
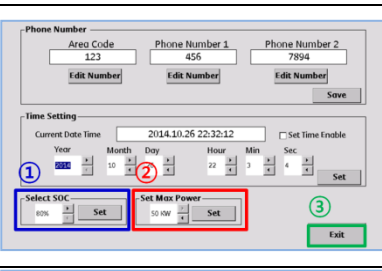
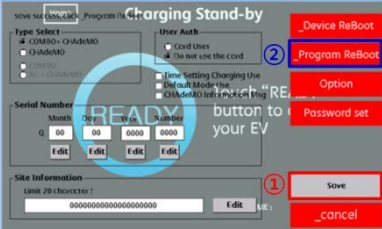

STEP	Procedure	Description
1		<p>Hidden Menu display.</p> <p>To select charger type,</p> <ul style="list-style-type: none"> - For FC50K-CC-S(Dual), select ‘COMBO+CHAdEMO’ - For FC50K-CH-S(Single), select ‘CHAdEMO’
2		<p>Test run process without network connection and/or RFID card and Mobile app is no longer available; The charger can be operated manually with LCD touch screen by checking ‘Default Mode Use’ check box.</p> <p>* Step 5 process must be done, if any setting value has been changed.</p>
3-1		<p>If you select ① ‘CHAdEMO’ for type select during step 1, you can make information message display on the user interface as shown in the picture 3-2.</p>
3-2		<p>- To display information, check ② ‘CHAdEMO Information Msg’ box.</p>
4		<p>Serial number: manufacturer use only</p>
5-1		<p>To insert site information,</p> <ul style="list-style-type: none"> - click on ① ‘Edit’ box - insert site information up to 20 letters.
5-2		<p>- To insert capital letter, check the ② ‘Capital’ box</p> <p>* This information will be sent to ‘SKY(network)’ via ‘SBOX(modem)’.</p>

<p>6-1</p>		<p>To apply any setting changed, hit the ① 'SAVE' and re-boot system by hitting ② 'Program Reboot' on the screen.</p>
<p>6-2</p>		<ul style="list-style-type: none"> - Program will reboot immediately, and 6-2 screen will appear. - Hit 'Program' inside the red rectangle in the picture. - User interface will be initialized.

10-7. Administrator Setting

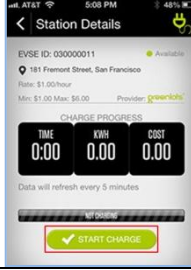
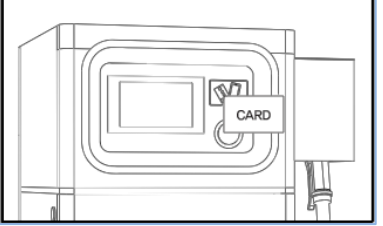
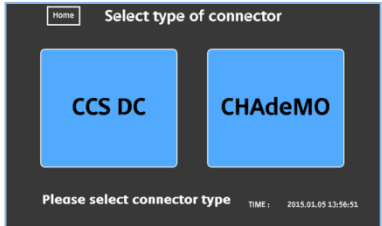
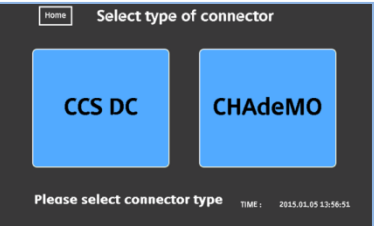
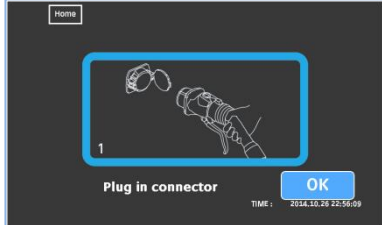
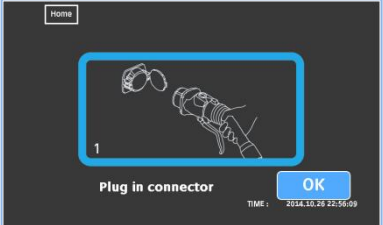
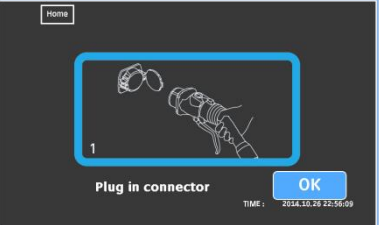
STEP	Procedure	Description
1		<p>To set special options, select ① in the picture</p>
2		<p>Administrator's special setting option screen appeared.</p> <ul style="list-style-type: none"> - Time, SOC, Max. Power and E/R contact phone number
3-1		<p>To display A/S call number on ERROR screen,</p> <ul style="list-style-type: none"> - Select ① 'Edit Number' - Number pad will be shown as 3-2. - Insert desired numbers in each fields shown in the picture 3-1
3-2		<ul style="list-style-type: none"> - To save phone number, hit ② 'save'.
4		<p>When charger connected to network and unchecked ① 'Set Time Enable', the charger time is linked to SKY(network) time sync</p> <ul style="list-style-type: none"> - To set time manually, check ① box and insert desired value in each fields. - Hit ② 'Set' to save and finish time insert.
5		<ul style="list-style-type: none"> ① To set Max. value of SOC, change field value 80 to 100 - To save value changed, hit 'Set' button. ② To set Max. power of charger, change field value 25 to 50. - To save value changed, hit 'Set' button. Installation spec. for the input power cable must be checked. ③ To return to previous screen, hit 'Exit'.
6		<p>To apply any setting changed, hit the ① 'SAVE' and re-boot system by hitting ② 'Program ReBoot' on the screen.</p> <ul style="list-style-type: none"> - Program will reboot immediately, 9 buttons screen will appear. - Hit 'Program' button.

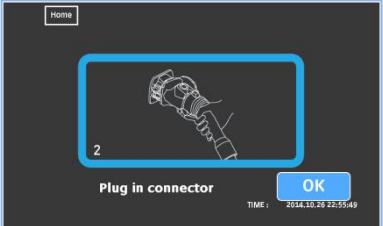
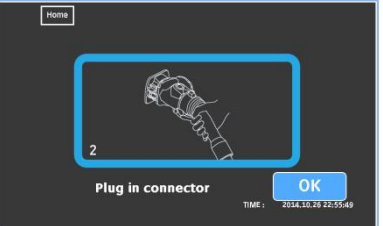
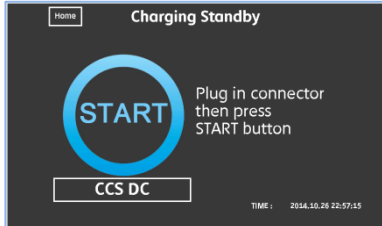
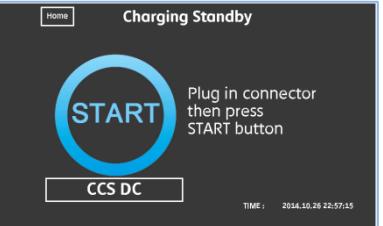
10-8. Start Charging

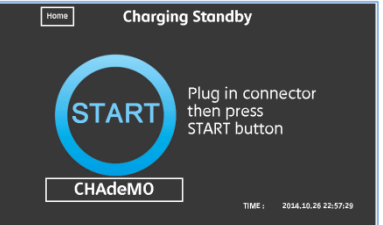
Default Mode	Network Mode	
	Mobile app	RFID Authentication
		
		
		
		
		
		
		

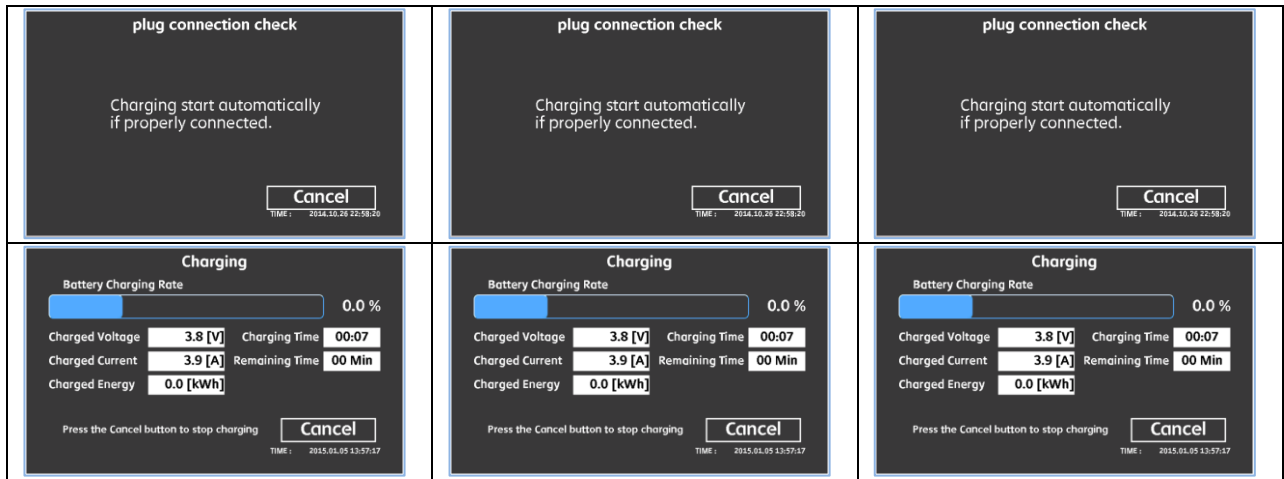

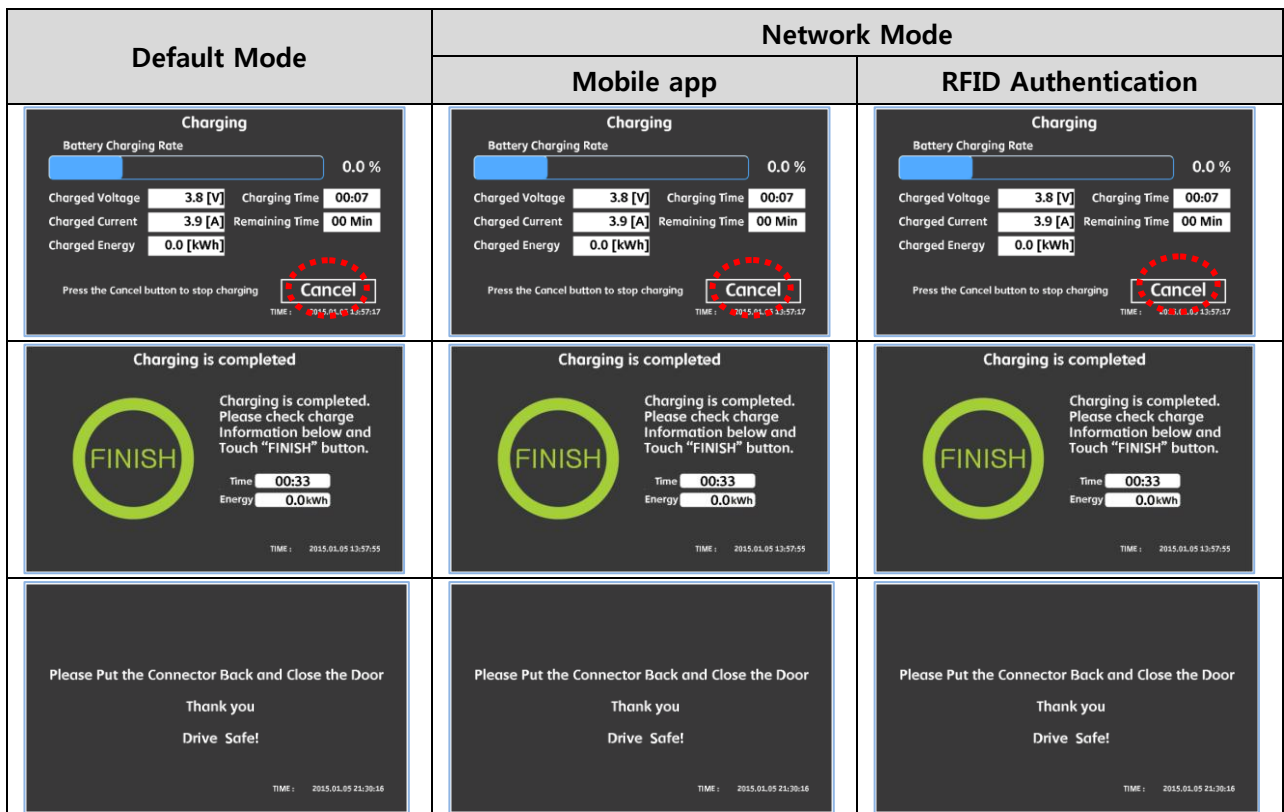

10-9. Stop Charging



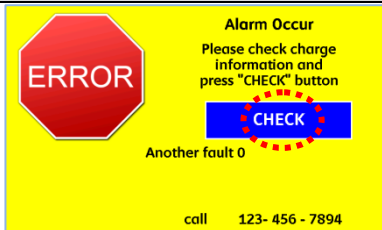

10-10. Error Situation

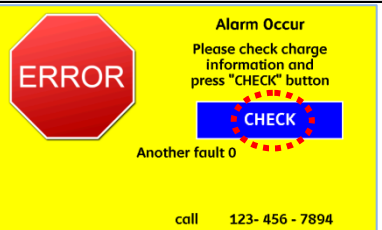
- If a problem occurs with charger or electric vehicle in the middle of charging, immediately stop charging and mark the problem and Fault code.
- When an error occurs, identify the problem and then detach connector from vehicle to put it back to the original position.
- ERROR screen will be displayed for 3 minutes. To initialize immediately, hit the 'CHECK' button.

Default Mode	Network Mode	
	Mobile app	RFID Authentication
 <p>Alarm Occur Please check charge information and press "CHECK" button</p> <p>Another fault 0</p> <p>call 123- 456 - 7894</p>	 <p>Alarm Occur Please check charge information and press "CHECK" button</p> <p>Another fault 0</p> <p>call 123- 456 - 7894</p>	 <p>Alarm Occur Please check charge information and press "CHECK" button</p> <p>Another fault 0</p> <p>call 123- 456 - 7894</p>
<p>Please Put the Connector Back and Close the Door</p> <p>Thank you</p> <p>Drive Safe!</p> <p>TIME : 2015.01.05 21:30:16</p>	<p>Please Put the Connector Back and Close the Door</p> <p>Thank you</p> <p>Drive Safe!</p> <p>TIME : 2015.01.05 21:30:16</p>	<p>Please Put the Connector Back and Close the Door</p> <p>Thank you</p> <p>Drive Safe!</p> <p>TIME : 2015.01.05 21:30:16</p>

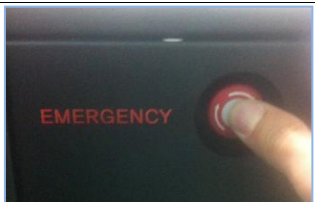
10-11. Emergency Stop

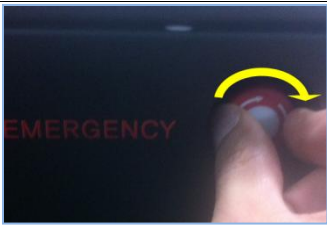
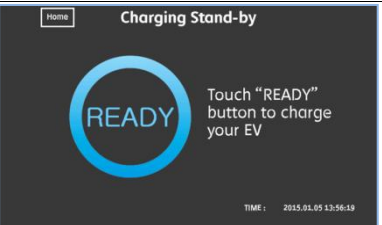
Description	
<p>Emergency stop</p> <ul style="list-style-type: none"> - In case an emergency happens while charging, press "EMERGENCY STOP" button in front side to immediately stop charger from charging. - When "EMERGENCY STOP" button is pressed, red lamp will be ON in front of button. - Charging status LED indicator will blink with Red 	
User	Display
	 <p>Alarm Occur Please check charge information and press "CHECK" button</p> <p>em_sw_on 12</p> <p>Emergency stop button is ON</p>
Description	
<p>Resetting emergency stop</p> <ul style="list-style-type: none"> - If emergency stop situation is solved, turn "EMERGENCY STOP" button clock wise to its original position. - When "EMERGENCY STOP" button goes back to its original position, red lamp will be OFF. 	
User	Display
	 <p>Charging Stand-by</p> <p>Touch "READY" button to charge your EV</p> <p>TIME : 2015.01.05 13:56:18</p>

11. MAINTENANCE



READ FIRST: There is important safety information throughout this document. Read 'Important Safety Instruction' on page 4 before attempting any owner maintenance or trouble shooting.

11-1. Checking filter and Replacement



ELECTRIC SHOCK! Risk of electric shock. Capacitor stores hazardous energy. Do not open back door of charger until 5 minutes after disconnecting all source of supply.



WARNING: Make sure turn off the power to the charger before performing any maintenance procedures.

- Inside charger, filters are installed on both sides to protect charger from fine dust.
- For the safe use of charger, make sure to check filters regularly.
- Open rear door, detach filters from charger, then check and replace them if needed.
- After filter maintenance done, replace all components to its original place and do not cover or stack any object near ventilation system.

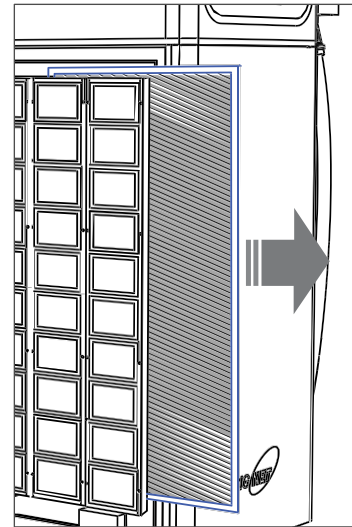

11-2. Checking Module Status

<How to check module for defects>

- Press the Top right-side on display to check charger's status.
- On password input screen, enter access code 1, 5, 9 (or password that changed by your desire) then hit "APPLY" button.

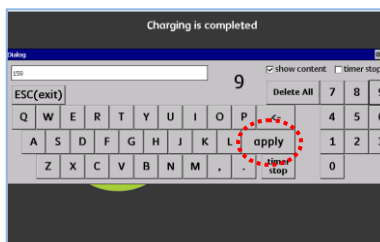

CC state		EV Data (CC 0x01)		EVSE Data (CC 0x02)	
Response Code	1	EV CCS	110	EVSE ID	1130
Version Code	2	EVMaxEnergyTransferType	6	EnergyTransferType	5
Machine Type	2	EVMaxPower	5	EVSEOperationalStatus	10
Module Status	3	EVSECode	0	EVSEProcessing	11
Module Status	3	EVSESSOC	0	EVSENoPilotConType	12
Module Status	3	EVSECurrent	1114	EVSECurrentInAchieved	13
Module Status	0	EVSEVoltage	1115	EVSEVoltageInAchieved	14
Module Status	0	EVSEMinimumVoltageIn	1116	EVSEPowerInAchieved	15
Sequence Number(Q)	110	EVSEMaximumCurrentIn	1117	EVSEPowerSetpoint	1130
Sequence Number(P)	110	EVSEMaximumPowerIn	1118	EVSEPowerCurrent	1139
CC status	48	EVSERemainingTimeToFullSOC	1119	EVSEMinimumVoltageIn	1140
Charging coupler door	1	EVSERemainingTimeToFullSOC	1120	EVSEMaximumCurrentIn	1141
EV Connection	1	EVSEEnergyCapacity	1121	EVSEMaximumPowerIn	1142
SAULT Code	40	EVSEEnergyDemand	1122	EVSEMinimumVoltageIn	1143
		EVSEMO_Curr_Slct_Cp	58	EVSEMaximumCurrentIn	1144
		EVSEMO_Volt	59	EVSEEnergyInAchieved	1145
		EVSEMO_Status	60	EVSEEnergyInAchieved	1146
		EVSEMO_Age	61	EVSEMO_Status	1147
		EVSEMO_Touch	62	EVSEMO_Status	1148
EVSEMO_SSS	110	EVSEMO_Reset	63	EVSEMO_Status	1149
EVSEMO_Random	25501	EVSEMO_Reset	64	EVSEMO_Status	1150
EVSEMO_Ac_Quick	3000	EVSEMO_Reset	65	EVSEMO_Status	1151
		EVSEMO_Reset	66	EVSEMO_Status	1152
		EVSEMO_Reset	67	EVSEMO_Status	1153
		EVSEMO_Reset	68	EVSEMO_Status	1154
		EVSEMO_Reset	69	EVSEMO_Status	1155
		EVSEMO_Reset	70	EVSEMO_Status	1156
		EVSEMO_Reset	71	EVSEMO_Status	1157
		EVSEMO_Reset	72	EVSEMO_Status	1158
		EVSEMO_Reset	73	EVSEMO_Status	1159
		EVSEMO_Reset	74	EVSEMO_Status	1160
		EVSEMO_Reset	75	EVSEMO_Status	1161
		EVSEMO_Reset	76	EVSEMO_Status	1162
		EVSEMO_Reset	77	EVSEMO_Status	1163
		EVSEMO_Reset	78	EVSEMO_Status	1164
		EVSEMO_Reset	79	EVSEMO_Status	1165
		EVSEMO_Reset	80	EVSEMO_Status	1166
		EVSEMO_Reset	81	EVSEMO_Status	1167
		EVSEMO_Reset	82	EVSEMO_Status	1168
		EVSEMO_Reset	83	EVSEMO_Status	1169
		EVSEMO_Reset	84	EVSEMO_Status	1170
		EVSEMO_Reset	85	EVSEMO_Status	1171
		EVSEMO_Reset	86	EVSEMO_Status	1172
		EVSEMO_Reset	87	EVSEMO_Status	1173
		EVSEMO_Reset	88	EVSEMO_Status	1174
		EVSEMO_Reset	89	EVSEMO_Status	1175
		EVSEMO_Reset	90	EVSEMO_Status	1176
		EVSEMO_Reset	91	EVSEMO_Status	1177
		EVSEMO_Reset	92	EVSEMO_Status	1178
		EVSEMO_Reset	93	EVSEMO_Status	1179
		EVSEMO_Reset	94	EVSEMO_Status	1180
		EVSEMO_Reset	95	EVSEMO_Status	1181
		EVSEMO_Reset	96	EVSEMO_Status	1182
		EVSEMO_Reset	97	EVSEMO_Status	1183
		EVSEMO_Reset	98	EVSEMO_Status	1184
		EVSEMO_Reset	99	EVSEMO_Status	1185
		EVSEMO_Reset	100	EVSEMO_Status	1186
		EVSEMO_Reset	101	EVSEMO_Status	1187
		EVSEMO_Reset	102	EVSEMO_Status	1188
		EVSEMO_Reset	103	EVSEMO_Status	1189
		EVSEMO_Reset	104	EVSEMO_Status	1190
		EVSEMO_Reset	105	EVSEMO_Status	1191
		EVSEMO_Reset	106	EVSEMO_Status	1192
		EVSEMO_Reset	107	EVSEMO_Status	1193
		EVSEMO_Reset	108	EVSEMO_Status	1194
		EVSEMO_Reset	109	EVSEMO_Status	1195
		EVSEMO_Reset	110	EVSEMO_Status	1196
		EVSEMO_Reset	111	EVSEMO_Status	1197
		EVSEMO_Reset	112	EVSEMO_Status	1198
		EVSEMO_Reset	113	EVSEMO_Status	1199
		EVSEMO_Reset	114	EVSEMO_Status	1200
		EVSEMO_Reset	115	EVSEMO_Status	1201
		EVSEMO_Reset	116	EVSEMO_Status	1202
		EVSEMO_Reset	117	EVSEMO_Status	1203
		EVSEMO_Reset	118	EVSEMO_Status	1204
		EVSEMO_Reset	119	EVSEMO_Status	1205
		EVSEMO_Reset	120	EVSEMO_Status	1206
		EVSEMO_Reset	121	EVSEMO_Status	1207
		EVSEMO_Reset	122	EVSEMO_Status	1208
		EVSEMO_Reset	123	EVSEMO_Status	1209
		EVSEMO_Reset	124	EVSEMO_Status	1210
		EVSEMO_Reset	125	EVSEMO_Status	1211
		EVSEMO_Reset	126	EVSEMO_Status	1212
		EVSEMO_Reset	127	EVSEMO_Status	1213
		EVSEMO_Reset	128	EVSEMO_Status	1214
		EVSEMO_Reset	129	EVSEMO_Status	1215
		EVSEMO_Reset	130	EVSEMO_Status	1216
		EVSEMO_Reset	131	EVSEMO_Status	1217
		EVSEMO_Reset	132	EVSEMO_Status	1218
		EVSEMO_Reset	133	EVSEMO_Status	1219
		EVSEMO_Reset	134	EVSEMO_Status	1220
		EVSEMO_Reset	135	EVSEMO_Status	1221
		EVSEMO_Reset	136	EVSEMO_Status	1222
		EVSEMO_Reset	137	EVSEMO_Status	1223
		EVSEMO_Reset	138	EVSEMO_Status	1224
		EVSEMO_Reset	139	EVSEMO_Status	1225
		EVSEMO_Reset	140	EVSEMO_Status	1226
		EVSEMO_Reset	141	EVSEMO_Status	1227
		EVSEMO_Reset	142	EVSEMO_Status	1228
		EVSEMO_Reset	143	EVSEMO_Status	1229
		EVSEMO_Reset	144	EVSEMO_Status	1230
		EVSEMO_Reset	145	EVSEMO_Status	1231
		EVSEMO_Reset	146	EVSEMO_Status	1232
		EVSEMO_Reset	147	EVSEMO_Status	1233
		EVSEMO_Reset	148	EVSEMO_Status	1234
		EVSEMO_Reset	149	EVSEMO_Status	1235
		EVSEMO_Reset	150	EVSEMO_Status	1236
		EVSEMO_Reset	151	EVSEMO_Status	1237
		EVSEMO_Reset	152	EVSEMO_Status	1238
		EVSEMO_Reset	153	EVSEMO_Status	1239
		EVSEMO_Reset	154	EVSEMO_Status	1240
		EVSEMO_Reset	155	EVSEMO_Status	1241
		EVSEMO_Reset	156	EVSEMO_Status	1242
		EVSEMO_Reset	157	EVSEMO_Status	1243
		EVSEMO_Reset	158	EVSEMO_Status	1244
		EVSEMO_Reset	159	EVSEMO_Status	1245
		EVSEMO_Reset	160	EVSEMO_Status	1246
		EVSEMO_Reset	161	EVSEMO_Status	1247
		EVSEMO_Reset	162	EVSEMO_Status	1248
		EVSEMO_Reset	163	EVSEMO_Status	1249
		EVSEMO_Reset	164	EVSEMO_Status	1250
		EVSEMO_Reset	165	EVSEMO_Status	1251
		EVSEMO_Reset	166	EVSEMO_Status	1252
		EVSEMO_Reset	167	EVSEMO_Status	1253
		EVSEMO_Reset	168	EVSEMO_Status	1254
		EVSEMO_Reset	169	EVSEMO_Status	1255
		EVSEMO_Reset	170	EVSEMO_Status	1256
		EVSEMO_Reset	171	EVSEMO_Status	1257
		EVSEMO_Reset	172	EVSEMO_Status	1258
		EVSEMO_Reset	173	EVSEMO_Status	1259
		EVSEMO_Reset	174	EVSEMO_Status	1260
		EVSEMO_Reset	175	EVSEMO_Status	1261
		EVSEMO_Reset	176	EVSEMO_Status	1262
		EVSEMO_Reset	177	EVSEMO_Status	1263
		EVSEMO_Reset	178	EVSEMO_Status	1264
		EVSEMO_Reset	179	EVSEMO_Status	1265
		EVSEMO_Reset	180	EVSEMO_Status	1266
		EVSEMO_Reset	181	EVSEMO_Status	1267
		EVSEMO_Reset	182	EVSEMO_Status	1268
		EVSEMO_Reset	183	EVSEMO_Status	1269
		EVSEMO_Reset	184	EVSEMO_Status	1270
		EVSEMO_Reset	185	EVSEMO_Status	1271
		EVSEMO_Reset	186	EVSEMO_Status	1272
		EVSEMO_Reset	187	EVSEMO_Status	1273
		EVSEMO_Reset	188	EVSEMO_Status	1274
		EVSEMO_Reset	189	EVSEMO_Status	1275
		EVSEMO_Reset	190	EVSEMO_Status	1276
		EVSEMO_Reset	191	EVSEMO_Status	1277
		EVSEMO_Reset	192	EVSEMO_Status	1278
		EVSEMO_Reset	193	EVSEMO_Status	1279
		EVSEMO_Reset	194	EVSEMO_Status	1280
		EVSEMO_Reset	195	EVSEMO_Status	1281
		EVSEMO_Reset	196	EVSEMO_Status	1282
		EVSEMO_Reset	197	EVSEMO_Status	1283
		EVSEMO_Reset	198	EVSEMO_Status	1284
		EVSEMO_Reset	199	EVSEMO_Status	1285
		EVSEMO_Reset	200	EVSEMO_Status	1286
		EVSEMO_Reset	201	EVSEMO_Status	1287
		EVSEMO_Reset	202	EVSEMO_Status	1288
		EVSEMO_Reset	203	EVSEMO_Status	1289
		EVSEMO_Reset	204	EVSEMO_Status	1290
		EVSEMO_Reset	205	EVSEMO_Status	1291
		EVSEMO_Reset	206	EVSEMO_Status	1292
		EVSEMO_Reset	207	EVSEMO_Status	1293
		EVSEMO_Reset	208	EVSEMO_Status	1294
		EVSEMO_Reset	209	EVSEMO_Status	1295
		EVSEMO_Reset	210	EVSEMO_Status	1296
		EVSEMO_Reset	211	EVSEMO_Status	1297
		EVSEMO_Reset	212	EVSEMO_Status	1298
		EVSEMO_Reset	213	EVSEMO_Status	1299
		EVSEMO_Reset	214	EVSEMO_Status	1300
		EVSEMO_Reset	215	EVSEMO_Status	1301
		EVSEMO_Reset	216	EVSEMO_Status	1302
		EVSEMO_Reset	217	EVSEMO_Status	1303
		EVSEMO_Reset	218	EVSEMO_Status	1304
		EVSEMO_Reset	219	EVSEMO_Status	1305
		EVSEMO_Reset	220	EVSEMO_Status	1306
		EVSEMO_Reset	221	EVSEMO_Status	1307
		EVSEMO_Reset	222	EVSEMO_Status	1308
		EVSEMO_Reset	223	EVSEMO_Status	1309
		EVSEMO_Reset	224	EVSEMO_Status	1310
		EVSEMO_Reset	225	EVSEMO_Status	1311
		EVSEMO_Reset	226	EVSEMO_Status	1312
		EVSEMO_Reset	227	EVSEMO_Status	1313
		EVSEMO_Reset	228	EVSEMO_Status	1314
		EVSEMO_Reset	229	EVSEMO_Status	1315
		EVSEMO_Reset	230	EVSEMO_Status	1316
		EVSEMO_Reset	231	EVSEMO_Status	1317
		EVSEMO_Reset	232	EVSEMO_Status	1318
		EVSEMO_Reset	233	EVSEMO_Status	1319
		EVSEMO_Reset	234	EVSEMO_Status	1320
		EVSEMO_Reset	235	EVSEMO_Status	1321
		EVSEMO_Reset	236	EVSEMO_Status	1322
		EVSEMO_Reset	237	EVSEMO_Status	1323
		EVSEMO_Reset	238	EVSEMO_Status	1324
		EVSEMO_Reset	239	EVSEMO_Status	1325
		EVSEMO_Reset	240	EVSEMO_Status	1326
		EVSEMO_Reset	241	EVSEMO_Status	1327
		EVSEMO_Reset	242	EVSEMO_Status	1328

11-3. Order of Replacing Module

 **ELECTRIC SHOCK!** Risk of electric shock. Capacitor stores hazardous energy. Do not open back door of charger until 5 minutes after disconnecting all source of supply.

 **WARNING:** Make sure turn off the power to the charger before performing any maintenance procedures.

- Open rear door and switch off all circuit breakers.

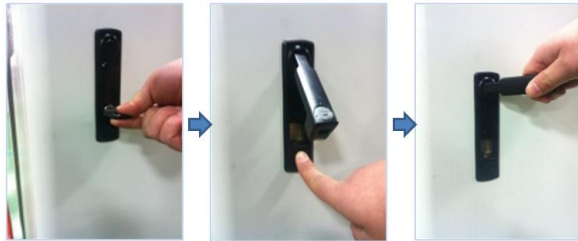

 There is a danger of getting an electric shock if you approach the inside of charger without switching OFF ground fault circuit interrupter.

- Detach signal lines connected to module.
- Detach covers of terminals.
- Detach wrench bolts fixed to in/output busbar (6mm wrench bolt)

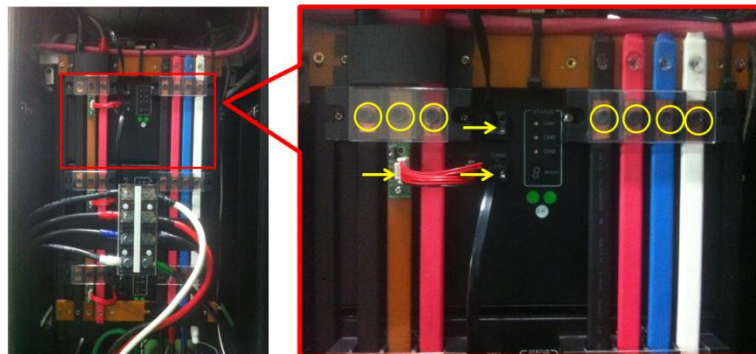

- Unlock and open the front door.
- Loosen 4 screws fixed for fastening module on front side.
- Detach module from charger by holding the handle of module on front side.

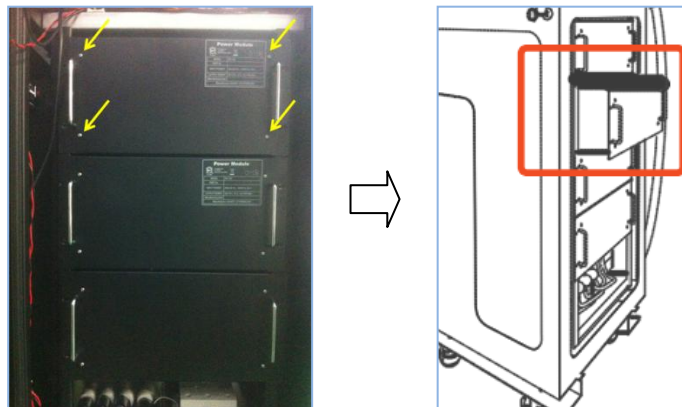

11-4. Assembly of Module

- Assembly of module could be done in reverse order of dismantlement.

 WARNING ELECTRICAL
Special cautions are required when you assemble module. If there is a mistake in assembly, there is risk of fire.

11-5. Fault code and Trouble shooting

NO.	Error Code	Description	Solution
1	s-box connection error	Communication Error between modem and HMI	Check the communication cable between SBOX and HMI
2	Network communication error	Communication with the control system is not smooth.	
3	RFID reader communication error	Charger not reading the RFID card	
4	Main board communication error	Touch screen communication error	Reconnect the cable between the controller and the main board
5	Power Module communication error	Power module communication error	Check the CAN communication line connection. Try to separate and combine the communication lines again
6	Power module response error	Power module non-response is detected	Check the switch turn on at input ELCB
7	Under-voltage on incoming line	AC voltage reduced -15% from nominal	Check line voltage, try reset.
8	Overvoltage on incoming line	AC voltage above +15% over nominal	Check line voltage, try reset.
9	Over-current on incoming line	AC current above +15% over nominal	
10	Charger output over-voltage	Overvoltage occurs to DC output	Try reset, then call customer service
11	Charger output over-current	Over-current occurs to DC output	Try reset, then call customer service
12	Charger output under-voltage	Voltage measurement of charger < 100V	Try reset, then call customer service
13	Emergency stop	The emergency stop button was pressed	
14	DC Ground fault	DC Grounding error is detected	DC cable or vehicle connector damaged, call customer service
15	Wakeup power failure	12V power supply problem(Wakeup power)	12V Power supple check.
16	Connector lock failure	Failure in power feed connector lock	Reconnect the plug to the vehicle, if the connector is damaged call customer service
17	Battery voltage incompatible	When vehicle target voltage is higher than maximum battery voltage	Try reset, and then call vehicle service.
18	Battery voltage incompatible1	The voltage required by the vehicle is higher than the available output voltage of the charger	Try reset, and then call vehicle service.
19	Time-out error(Vehicle CAN receive)	No incoming CAN signals from the vehicle	Reconnect the plug to the vehicle, Try one reset, and then call vehicle service.
20	Charging current incompatible	The current required by the vehicle is higher than the potential output current of the charger	Try reset, and then call vehicle service.
21	Time-out error(Charging enable)	No charging enable signal is received from	Try reset, and then call vehicle service.
22	Time-out error(Vehicle Relay on)	Vehicle relay is not on.	Try reset, and then call vehicle service.
23	Time-out error(Vehicle Current request)	Charging current request time-out	Try reset, and then call vehicle service.
24	Time-out error(Vehicle CAN terminated)	Vehicle side CAN communication time-out	Try reset, and then call vehicle service.
25	CAN communication fault	During charging Communication problem between the charger and the vehicle	Reconnect the cable on the vehicle and start again. If the fault remains, call customer service
26	Battery error(under - voltage)	This fault indicates that the car battery voltage is too low This fault is generated by the vehicle	Try reset, then call customer service
27	Battery error (over-voltage)	Battery over-voltage of Vehicle	Try reset, then call customer service
28	Battery error (voltage difference)	The present output voltage of the charger differs from the battery voltage of the vehicle	Try reset, then call customer service

29	Battery error (current difference)	Charger output does not follow the charging request value of the vehicle	Try reset, then call customer service
30	Battery error(temperature)	High battery temperature of Vehicle	Try reset, and then call vehicle service.
31	Vehicle shift lever position	Vehicle shift lever position error	Return the shift lever to the Park position.
32	Vehicle error (other)	Vehicle detects other failures	Try reset, then call customer service
33	Vehicle Voltage error (before charging)	Non zero Vehicle voltage before charging starts	Try reset, and then call vehicle service.
34	Vehicle Voltage error(after charging)	Non zero Vehicle voltage after charging end	Try reset, and then call vehicle service.
35	Vehicle Voltage error (Insulation test)	Non zero Vehicle voltage after insulation test	Try reset, and then call vehicle service.
36	PLC communication error	PLC modem communication error is detected	Check the RS232 cable connection status Resets the power of the PLC modem. Change the PLC modem.
37	Service Discovery error	Charging parameters does not match with vehicle	Try reset, then call customer service
38	ServicePaymentSelection error	Charging parameters does not match with vehicle	Try reset, then call customer service
39	ChargeParameterDiscovery error	Charging parameters does not match with vehicle	Try reset, then call customer service
40	CableCheck error	Requested to stop from vehicle during cable check operation.	Try reset, then call customer service
41	PreCharge error	Requested to stop from vehicle during pre-charge operation.	Try reset, then call customer service
42	Request time-out(SessionSetup)	Vehicle communication does not smooth.	Try reset, then call customer service
43	Request time-out(ServiceDiscovery)	Vehicle communication does not smooth.	Try reset, then call customer service
44	Request time-out(ServicePaymentSelection)	Vehicle communication does not smooth.	Try reset, then call customer service
45	Request time-out(ChargeParameterDiscovery)	Vehicle communication does not smooth.	Try reset, then call customer service
46	Request time-out(CableCheck)	Vehicle communication does not smooth.	Try reset, then call customer service
47	Request time-out(PreCharge)	Vehicle communication does not smooth.	Try reset, then call customer service
48	Request time-out(CurrentDemand)	Vehicle communication does not smooth.	Try reset, then call customer service
49	COMBO connector temperature	Overheating detected in the combo connector.	Reconnect the plug to the vehicle, then call customer service
50	PLC communication fault	During charging communication problem occurred between charger and vehicle	Reconnect the cable on the vehicle and start again. If the fault remains, call customer service.

	COMMON
	CHAdEMO Related
	COMBO Related

12. Warranty

Warranty terms:

All the equipment and parts proposed herein will be guaranteed by the SELLER against defects of materials and workmanship for a period of 12 months from the date of delivery". In no event shall SELLER be liable for any defects of PRODUCTS if they are arising out of any of the following causes:(i) Improper operation and/or maintenance by BUYER and/or OWNER;(ii) Operation outside the specifications or requirements provided by SELLER;(iii) Erosion or corrosion, not attributable to SELLER'S misspecification as to material;(iv) Normal wear and tear including consumption of consumables within a certain agreed probability; and/or(v) Repair or replacement by any parties not approved by SELLER."THE WARRANTIES AND GUARANTEES SET FORTH IN THIS CLAUSE IS EXCLUSIVE AS TO THE PRODUCTS AND IN LIEU OF ALL OTHER WARRANTIES, WHETHER WRITTEN, ORAL, IMPLIED OR STATUTORY; INCLUDING THE IMPLIED WARRANTIES OF MERCHANTABILITY AND FITNESS FOR A PARTICULAR PURPOSE."

Limitation of Liability: In no event shall the SELLER be liable to the Purchaser, whether based in contract, tort (including negligence and strict liability) or otherwise, for any special, indirect, incidental, or consequential loss or damage including, without limitation, damage to or loss of property or equipment, loss of profits or revenue. In no event shall the SELLER's overall liability exceed that of 100% of the Contract Price.

MODEL	FC50K-CC-S	Warranty Period
Manufacturing Date		1 yr from delivery date
Delivery Date		
Customer		Tel
Manufacturer	SIGNET SYSTEMS INC.	+82-70-4618-0124