



F. B. (Ben) Poag  
Director - Regulatory

**Regulatory Affairs**  
FLTLH00201  
1313 Blair Stone Road  
Tallahassee, FL 32301  
Voice 850 599 1027  
Fax 850 878 0777  
ben.poag@mail.sprint.com

May 4, 2006

Ms. Beth Salak  
Director, Division of Competitive Markets and Enforcement  
Attention: Tariff Section  
Florida Public Service Commission  
2540 Shumard Oak Boulevard  
Tallahassee, Florida 32399-0850

**RE: TL727, Embarq Florida, Inc. - General Exchange Tariff**

Dear Ms. Salak:

Attached for filing is the original and one (1) copy, including a CD, of the entire revised General Exchange Tariff to reflect the company name change from Sprint-Florida, Incorporated to Embarq Florida, Inc. This filing is submitted with a proposed effective date of June 5, 2006. Embarq's tariffs are available at website: [www.sprint.com/tariffs](http://www.sprint.com/tariffs).

Commission consideration and timely approval of these pages are respectfully requested. If you have any questions or need additional information regarding this filing, please contact me at (850) 599-1027.

Sincerely,

A handwritten signature in black ink, appearing to read "F. Ben Poag".

F. Ben Poag  
Director - Regulatory Affairs

Attachments

01 00-20

cc: Nancy Schnitzer

**AFFIDAVIT**

Regarding the General Exchange Tariff filing made on May 4, 2006 with an effective date of June 5, 2006 to effect change to the company name in the state of Florida from Sprint-Florida, Incorporated. to Embarq Florida, Inc.;

I, Tim D. Eshleman am an authorized agent of the applicant corporation, Embarq Florida, Inc., and am authorized to make this statement on its behalf. I attest that no terms, conditions or rates have been changed in these tariffs. I declare under penalty of perjury that the foregoing is true and correct.

Executed on 4/27/06 at Overland Park, Kansas  
(Date) (Location)

T. Esh Manager - Tariffs  
(Signature and Title)

Subscribed and sworn to before me this 27 day of April, 2006.



Anne M. Toller  
Notary Public  
My Commission Expires: 2/2/2010

GENERAL EXCHANGE TARIFF

Embarq Florida, Inc.

Second Revised Sheet 1  
Cancelling First Revised Sheet 1  
Effective: August 31, 2000

By: F. B. Poag  
Director

GENERAL EXCHANGE TARIFF  
FOR THE STATE OF FLORIDA

This tariff contains regulations and rates applicable for the furnishing of Basic Local Exchange Service, Long Distance Message Telecommunications, Wide Area Telephone Service, Mobile Telephone Service, and for other general customer services, and facilities associated with the above services offered by Embarq Florida, Inc., the Telephone Company, and/or Company within the State. This tariff is on file with the Florida Public Service Commission.

This tariff replaces those previously filed with the Florida Public Service Commission for United Telephone Company of Florida and for Central Telephone Company of Florida.

Differences in rates and rate application between certain exchanges are noted. Wherever the designations United Telephone exchanges only and Central Telephone exchanges only appear in this tariff, they refer to particular exchanges as follows:

UNITED TELEPHONE

Apopka, Arcadia, Astor, Avon Park, Belleview, Beverly Hills, Boca Grande, Bonita Springs, Bowling Green, Bushnell, Cape Coral, Cape Haze, Clermont, Clewiston, Crystal River, Dade City, Eustis, Everglades, Forest, Fort Meade, Fort Myers, Fort Myers Beach, Groveland, Homosassa Springs, Howey-in-the-Hills, Immokalee, Inverness, Kenansville, Kissimmee, LaBelle, Lady Lake, Lake Placid, Leesburg, Lehigh Acres, Marco Island, Montverde, Moore Haven, Mount Dora, Naples, North Cape Coral, North Fort Myers, North Naples, Ocala, Ocklawaha, Okeechobee, Orange City, Pine Island, Port Charlotte, Punta Gorda, Reedy Creek, Saint Cloud, Salt Springs, San Antonio, Sanibel-Captiva Islands, Sebring, Silver Springs Shores, Spring Lake, Tavares, Trilacoochee, Umatilla, Wauchula, West Kissimmee, Weirsdale, Wildwood, Williston, Windermere, Winter Garden, Winter Park, Zolfo Springs

GENERAL EXCHANGE TARIFF

Embarq Florida, Inc.

By: F. B. Poag  
Director

First Revised Sheet 2  
Cancelling Original Sheet 2  
Effective: January 1, 1997

GENERAL EXCHANGE TARIFF  
FOR THE STATE OF FLORIDA

CENTRAL TELEPHONE

Alford, Baker, Bonifay, Cherry Lake, Cottondale, Crawfordville, Crestview, DeFuniak Springs, Destin, Fort Walton Beach, Freeport, Glendale, Grand Ridge, Greenville, Greenwood, Kingsley Lake, Lawtey, Lee, Madison, Malone, Marianna, Monticello, Panacea, Ponce de Leon, Reynolds Hill, St. Marks, Santa Rosa Beach, Seagrove Beach, Shalimar, Sneads, Sopchoppy, Starke, Tallahassee, Valparaiso, Westville

Interstate communication services are furnished through facilities provided by the Company for the transmission of intelligence by electrical impulse, principally by means of wire, radio, or a combination of both.

Explanation of Symbols

When changes are made in any tariff sheet, a revised sheet will be issued canceling the tariff sheet affected; such changes will be identified through the use of the following symbols:

- (C) To signify changed regulation or tariff.
- (D) To signify discontinued rate, regulation or text.
- (I) To signify increase.
- (M) To signify a move from one sheet to another with no change in text, regulation or tariff.
- (N) To signify new rate, regulation or text.
- (O) To signify obsoleted rate, regulation or text, and a move to the obsolete service offerings section.

GENERAL EXCHANGE TARIFF

Embarq Florida, Inc.

Third Revised Sheet 3  
Cancelling Second Revised Sheet 3  
Effective: June 4, 2004

By: F. B. Poag  
Director

GENERAL EXCHANGE TARIFF  
FOR THE STATE OF FLORIDA

- (R) To signify reduction.
- (S) To signify reissued matter.
- (T) To signify change in text, but no change in rate or regulation.
- (V) To signify new vintage rates applicable only to new installations and additions to existing installations.
- (Z) To signify a correction
  
- + To signify that the marginal notation directly above it is continued down vertically to the next appearance of the same marginal notation.

The preceding symbols will apply except where additional symbols are identified at the bottom of individual sheets.

GENERAL EXCHANGE TARIFF

Embarq Florida, Inc.

By: F. B. Poag  
Director

First Revised Sheet 4  
Cancelling Original Sheet 4  
Effective: August 2, 2004

GENERAL EXCHANGE TARIFF  
FOR THE STATE OF FLORIDA

Trademarks and Service Marks Used in this Tariff

Below is a list of trademarks which may be used in this Tariff. These designations will not be listed hereafter in the Tariff. However, the laws regarding trademarks and service marks will still apply. Trademarks that are owned by the Company cannot be used by another party without authorization.

Digilink®  
Lightlink<sup>SM</sup>  
LineGuard®  
SignalRing®  
Switchlink<sup>SM</sup>  
Talking Call Waiting<sup>SM</sup>  
Telesaver<sup>SM</sup>  
Translink®

GENERAL EXCHANGE TARIFF

Embarq Florida, Inc.

Second Revised Sheet 1  
Cancelling First Revised Sheet 1  
Effective: July 14, 2001

By: F. B. Poag  
Director

TABLE OF CONTENTS

- A1. EXPLANATION OF TERMS
- A2. GENERAL REGULATIONS
- A3. BASIC LOCAL EXCHANGE SERVICE  
SUPPLEMENTAL EXCHANGE SERVICE AREA MAPS
- A4. SERVICE CHARGES
- A5. CHARGES APPLICABLE UNDER SPECIAL CONDITIONS
- A6. DIRECTORY LISTINGS
- A7. COIN TELEPHONE SERVICE
- A8. TELEPHONE ANSWERING SERVICE FACILITIES (UNITED TELEPHONE EXCHANGES ONLY)
- A9. FOREIGN EXCHANGE SERVICE AND FOREIGN CENTRAL OFFICE SERVICE
- A10. N11 SERVICES
- A11. DIGITAL CENTREX SERVICE (CENTRAL TELEPHONE EXCHANGES ONLY)
- A12. CENTRAL OFFICE NON-TRANSPORT SERVICE OFFERINGS (UNITED TELEPHONE EXCHANGES ONLY)
- A13. MISCELLANEOUS SERVICE ARRANGEMENTS
- A14. AUXILIARY EQUIPMENT

GENERAL EXCHANGE TARIFF

Embarq Florida, Inc.

Fourth Revised Sheet 2  
Cancelling Third Revised Sheet 2  
Effective: January 6, 2006

By: F. B. Poag  
Director

TABLE OF CONTENTS

- A15. CONNECTIONS OF CUSTOMER PROVIDED TERMINAL EQUIPMENT AND COMMUNICATIONS SYSTEMS
- A16. PRIVATE BRANCH EXCHANGE SERVICE
- A17. PERSONAL DIAL PAGING SERVICES
- A18. LONG DISTANCE MESSAGE TELECOMMUNICATIONS SERVICE
- A19. WIDE AREA TELECOMMUNICATIONS SERVICE
- A20. PRIVATE LINE SERVICE
- A21. RESERVED FOR FUTURE USE
- A22. LOCAL TELEPHONE SERVICE FOR STATE OF FLORIDA GOVERNMENTAL AGENCIES (CENTRAL TELEPHONE ONLY)
- A23. RESERVED FOR FUTURE USE
- A24. LOCAL TELEPHONE SERVICES FOR FLORIDA STATE UNIVERSITY (CENTRAL TELEPHONE ONLY)
- A25. RESERVED FOR FUTURE USE
- A26. INTERCONNECTION OF LOCAL EXCHANGE SERVICE TO SHARED TENANT SERVICE



GENERAL EXCHANGE TARIFF

Embarq Florida, Inc

Third Revised Sheet 3  
Cancelling Second Revised Sheet 3  
Effective: May 4, 2005

By: F. B. Poag  
Director

TABLE OF CONTENTS

- A27. SPECIAL PACKAGED OFFERINGS
- A28. DATA TRANSPORT SERVICE
- A29. DIGITAL NETWORK SERVICES
- A30. DERIVED CHANNEL SERVICES
- A39. ABBREVIATED DIALING
- A101. OBSOLETE SERVICE OFFERINGS – EXPLANATION OF TERMS
- A103. OBSOLETE SERVICE OFFERINGS – BASIC LOCAL EXCHANGE SERVICE
- A106. OBSOLETE SERVICE OFFERINGS – DIRECTORY LISTINGS
- A107. OBSOLETE SERVICE OFFERINGS – COIN TELEPHONE SERVICE
- A108. OBSOLETE SERVICE OFFERINGS – TELEPHONE ANSWERING SERVICE FACILITIES
- A111. OBSOLETE SERVICE OFFERINGS – DIGITAL CENTREX SERVICE
- A112. OBSOLETE SERVICE OFFERINGS – CENTREX SERVICE
- A113. OBSOLETE SERVICE OFFERINGS – MISCELLANEOUS SERVICE ARRANGEMENTS
- A114. OBSOLETE SERVICE OFFERINGS – AUXILIARY EQUIPMENT
- A115. OBSOLETE SERVICE OFFERINGS – CONNECTIONS WITH CERTAIN FACILITIES  
AND/OR EQUIPMENT OF OTHERS
- A116. OBSOLETE SERVICE OFFERINGS – DATA SERVICE
- A118. OBSOLETE SERVICE OFFERINGS – LONG DISTANCE MESSAGE  
TELECOMMUNICATIONS SERVICE
- A120. OBSOLETE SERVICE OFFERINGS – PRIVATE LINE SERVICE AND CHANNELS
- A123. OBSOLETE SERVICE OFFERINGS – DIGITAL CENTREX SERVICE FOR CITY, COUNTY,  
FEDERAL AND STATE AGENCIES
- A124. OBSOLETE SERVICE OFFERINGS – EMERGENCY REPORTING SERVICES
- A127. OBSOLETE SERVICE OFFERINGS – SPECIAL PACKAGED OFFERINGS
- A128. OBSOLETE SERVICE OFFERINGS – DATA TRANSPORT SERVICE
- A129. OBSOLETE SERVICE OFFERINGS – DIGITAL NETWORK SERVICES
- A139. OBSOLETE SERVICE OFFERINGS – ABBREVIATED DIALING

GENERAL EXCHANGE TARIFF

Embarq Florida, Inc.

Tenth Revised Sheet 1  
 Cancelling Ninth Revised Sheet 1  
 Effective: January 3, 2004

By: F. B. Poag  
 Director

INDEX

	SECTION	SHEET
211 SERVICE FOR COMMUNITY INFORMATION AND REFERRAL SERVICES	A10	76
311 NON-EMERGENCY SERVICE	A10	89
511 SERVICE FOR TRAVEL INFORMATION SERVICES	A10	82
711 SERVICE FOR TELECOMMUNICATIONS RELAY SERVICE (TRS)	A10	70
2GMAN – TALLAHASSEE	A28	1
ABUSE OR FRAUDULENT USE OF SERVICE	A2	9
ABUSIVE LANGUAGE, USE OF	A2	11
ACCESS LINE CHARGE	A4	1
ACCESSORIES PROVIDED BY THE SUBSCRIBER	A2	4
ACOUSTIC OR INDUCTIVE CONNECTIONS	A15	24
ADDITIONAL DIRECTORY LISTINGS	A6	2
ADDITIONAL LINE MATTER	A6	15
ADVANCE LISTINGS	A6	16
ADVANCE PAYMENTS	A2	30
ADVANTAGE SERVICE	A113	2
AIRLINE MILEAGE BETWEEN RATE CENTERS	A18	2
ALARM DETECTION AND REPORTING EQUIPMENT	A15	51
ALLOWANCE FOR INTERRUPTIONS	A2	39
ALLOWANCE FOR INTERRUPTIONS (PRIVATE LINE)	A20	3
ALLOWANCE FOR INTERRUPTIONS (WATS)	A19	32
ALTERNATE (DIRECTIVE) LISTINGS	A6	12
ANNOYANCE CALLS AND REQUESTS FOR TRACING CALLS (TRAP AND TRACE)	A2	48
ANONYMOUS CALL REJECTION	A13	46
ANSWER SUPERVISION	A13	73
APPLICATION FOR SERVICE	A2	15
APPLICATION OF RATES FOR BUSINESS AND RESIDENCE SERVICE	A2	17
ASYNCHRONOUS TRANSFER MODE (ATM)	A29	36
ATTACHMENTS (POLE ATTACHMENT RENTAL)	A5	16
AUDICHRON EQUIPMENT	A13	1
AUTOMATIC TIME AND CHARGES QUOTATION SERVICE		
AUTOMATIC TIME/TEMPERATURE/WEATHER ANNOUNCEMENT SYSTEMS	A13	1
AUXILIARY EQUIPMENT	A14	1

GENERAL EXCHANGE TARIFF

Embarq Florida, Inc.

Third Revised Sheet 2  
 Cancelling Second Revised Sheet 2  
 Effective: November 27, 1998

By: F. B. Poag  
 Director

INDEX

	<u>SECTION</u>	<u>SHEET</u>
BASE RATE AREA MAPS .....	SUPP. A3	
BASIC LOCAL EXCHANGE SERVICE .....	A3	1
BILLED NUMBER SCREENING .....	A13	68
BLOCKING SERVICES .....	A13	74
BILLING BREAKDOWN CHARGE .....	A13	66.1
BREAK-IN ROTARY GROUP .....	A14	4
BROADCAST OF RECORDINGS OF TELEPHONE CONVERSATIONS .....	A2	4
BUSINESS LISTINGS .....	A6	5
BUSINESS MAIN FLAT-RATE SERVICE .....	A3	42
BUSINESS RATE APPLICATION .....	A2	17
BUSINESS SENSE LOCAL TOLL .....	A18	30
CALL AGGREGATOR SCREENING SERVICES .....	A13	85
CALL FORWARD WITH REMOTE ACTIVATION .....	A13	21
CALL FORWARDING .....	A13	17
CALL FORWARDING-BUSY .....	A13	19
CALL FORWARDING-DON'T ANSWER .....	A13	18
CALL SCREENING SERVICES FOR MOBILE CARRIERS .....	A25	27
CALL SCREENING SERVICES FOR PBX TRUNKS .....	A16	4
CALL SCREENING FOR RESIDENCE AND BUSINESS .....	A13	67
CALL TRACING .....	A13	34
CALL TRACING DENIAL .....	A13	49
CALL WAITING .....	A13	20
CALL WAITING ID .....	A13	25
CALL WAITING OPTIONS .....	A13	26
CALLER ID .....	A13	39
CALLER ID WITH NAME .....	A13	43
CALLING NUMBER DELIVERY BLOCKING .....	A13	47
CANCELLATION OF APPLICATION PRIOR TO COMPLETION OF WORK .....	A2	16
CAPTION LISTING .....	A6	11

GENERAL EXCHANGE TARIFF

Embarq Florida, Inc.

Fifth Revised Sheet 3  
 Cancelling Fourth Revised Sheet 3  
 Effective: September 18, 2002

By: F. B. Poag  
 Director

INDEX

	<u>SECTION</u>	<u>SHEET</u>
CENDEL METROPOLITAN DATA SERVICES (CMDS) .....	A128	23
CENTRAL OFFICE NON-TRANSPORT SERVICE OFFERINGS .....	A12	1
CENTREX LINES TERMINATING IN A KEY SYSTEM		
UNITED TELEPHONE EXCHANGES .....	A12	15
CENTRAL TELEPHONE EXCHANGES .....	A11	9
CENTREX SERVICE - (CENTRAL TELEPHONE		
EXCHANGES ONLY.....	A11	1
CENTREX SERVICE - ENHANCED.....	A12	20
CENTREX SERVICE, MONTH-TO-MONTH .....	A112	1
CENTREX SERVICE (UNITED TELEPHONE EXCHANGES ONLY).....	A12	1
CENTREX TRANSLATIONS CHARGE.....	A11	5
CHANNELS, PRIVATE LINE, PROVISION OF .....	A20	29
CHARGES APPLICABLE UNDER SPECIAL CONDITIONS .....	A5	1
CITY WIDE SERVICE.....	A111	1
CLASSIFICATION OF AREAS AS THE BASIS FOR		
FURNISHING TELEPHONE SERVICE.....	A2	47
COIN LINE SERVICE .....	A7	33
COIN TELEPHONE SERVICE .....	A7	1
COMPANY FACILITIES AT HAZARDOUS OR		
INACCESSIBLE LOCATIONS.....	A2	26
COMPANY-WIDE RATE GROUPS .....	A3	2
CONCENTRATOR/IDENTIFIER UNITS.....	A8	4
CONDITIONS REQUIRING SPECIAL CONSTRUCTION.....	A5	5
CONFERENCE SERVICE .....	A18	42
CONNECTION OF CUSTOMER-PROVIDED VOICE TRANSMITTING/ RECEIVER TERMINAL EQUIPMENT FOR RECORDING OF TWO-WAY TELEPHONE CONVERSATIONS .....	A15	50
CONNECTIONS OF CERTAIN FACILITIES OF POWER, PIPE LINE, AND RAILROAD COMPANIES .....	A15	39

GENERAL EXCHANGE TARIFF

Embarq Florida, Inc.

Second Revised Sheet 4  
 Cancelling First Revised Sheet 4  
 Effective: June 5, 1998

By: F. B. Poag  
 Director

INDEX

	<u>SECTION</u>	<u>SHEET</u>
CONNECTIONS OF CERTAIN FACILITIES OF THE NATIONAL AERONAUTICS AND SPACE ADMINISTRATION .....	A15	43
CONNECTIONS OF CERTAIN FACILITIES OF THE U.S. ARMY, NAVY AND AIR FORCE .....	A15	44
CONNECTIONS OF CUSTOMER-PROVIDED COMMUNICATIONS SYSTEMS NOT SUBJECT TO PART 68 OF THE FCC RULES AND REGULATIONS .....	A15	37
CONNECTIONS OF CUSTOMER-PROVIDED TERMINAL EQUIPMENT AND COMMUNICATIONS SYSTEMS .....	A15	1
CONNECTIONS OF CUSTOMER-PROVIDED TERMINAL EQUIPMENT SPECIFICALLY EXEMPTED FROM THE FCC REGISTRATION PROGRAM .....	A15	38
CONNECTIONS OF GRANDFATHERED TERMINAL EQUIPMENT AND GRANDFATHERED COMMUNICATIONS SYSTEMS .....	A15	18
CONNECTIONS OF REGISTERED EQUIPMENT .....	A15	10
CONSTRUCTION, SPECIAL TYPES OF .....	A5	5
CONSTRUCTION CHARGES .....	A5	1
CONSTRUCTION ON PRIVATE PROPERTY .....	A5	29
CONSTRUCTION REQUIRED FOR TEMPORARY SERVICE .....	A5	21
CONTRACT SERVICE ARRANGEMENTS .....	A5	39
CREDIT AND DEPOSITS FOR APPLICANTS .....	A2	30
CUSTOM CALLING FEATURES .....	A13	16
CUSTOM CALLING FEATURE PACKAGES .....	A13	51
CUSTOM CALLING SERVICE - PACKAGED FEATURE OFFERINGS (CENTRAL TELEPHONE EXCHANGES ONLY) .....	A113	5
CUSTOM CODE RESTRICTIONS (CCR) .....	A13	75
CUSTOMER NAME AND ADDRESS .....	A113/A118	29/1
CUSTOMER PAYMENT PLANS .....	A2	40
CUSTOMER-PROVIDED TERMINAL EQUIPMENT AND COMMUNICATIONS SYSTEMS .....	A2	4
CUT-OFF ON DISCONNECT (SINGLE PARTY ACCESS LINE FEATURE) .....	A13	92

GENERAL EXCHANGE TARIFF

Embarq Florida, Inc.

Seventh Revised Sheet 5  
 Cancelling Sixth Revised Sheet 5  
 Effective: January 6, 2004

By: F. B. Poag  
 Director

INDEX

	<u>SECTION</u>	<u>SHEET</u>
D-4 CHANNEL SERVICE .....	A20	101
DAMAGE TO SUBSCRIBER'S PREMISES .....	A2	45
DATA TRANSPORT SERVICE .....	A28	1
DATA SERVICE .....	A116	1
DATA TRANSMITTING AND/OR RECEIVING TERMINAL EQUIPMENT .....	A15	47
DEFAACEMENT OF PREMISES .....	A2	45
DEPOSITS FOR APPLICANTS, CREDITS AND .....	A2	30
DERIVED CHANNEL SERVICES.....	A30	1
DESTRUCTION OF TELEPHONE EQUIPMENT BY SUBSCRIBER .....	A2	26
DIGILINK SERVICE .....	A21	1
DIGILINK SERVICE .....	A120	34
DIGITAL ACCESS CROSS CONNECT SERVICE .....	A20	56
DIGITAL CENTREX SERVICE (CENTRAL TELEPHONE ONLY) .....	A11	1
DIGITAL CENTREX SERVICE FOR THE STATE OF FLORIDA IN THE COUNTIES OF JACKSON, OKALOOSA AND WALTON (CENTRAL TELEPHONE EXCHANGES ONLY) .....	A23	1
DIGITAL TRUNKING SERVICE (DTS).....	A30	5
DIRECT IN DIALING (DID) .....	A16	1
DIRECT IN DIALING (DID) SERVICE ASSOCIATED WITH SHARED TENANT SERVICE .....	A26	14
DIRECTORIES, LOCAL EXCHANGE TELEPHONE .....	A6	21
DIRECTORIES, PROVISION OF .....	A2	24
DIRECTORY ASSISTANCE SERVICE .....	A3/A18	51/48
DIRECTORY LISTINGS .....	A6	1
DIRECTORY NUMBER TRANSFER .....	A13	113
DISCONNECTION OF SERVICE FOR CAUSE .....	A2	7
DISTINCTIVE RINGING .....	A13	35
DUPLICATE BILL CHARGES .....	A13	66

GENERAL EXCHANGE TARIFF

Embarq Florida, Inc.

Sixth Revised Sheet 6  
 Cancelling Fifth Revised Sheet 6  
 Effective: June 7, 2003

By: F. B. Poag  
 Director

INDEX

<u>SHEET</u>	<u>SECTION</u>	
E911 EMERGENCY REPORTING SERVICES.....	A10	1
ELECTRONIC SWITCHED NETWORK (SUNCOM), STATE OF FLORIDA .....	A12	17
EMERGENCY INTERRUPT SERVICE .....	A3/A18	57/45
EMERGENCY REPORTING SERVICES .....	A10	1
ENHANCED CALL WAITING.....	A13	21
ENHANCED CENTREX SERVICE .....	A12	20
ENHANCED DATA TRANSMISSION SERVICE (EDTS) .....	A13	99
ENHANCED FRAME RELAY SERVICE.....	A29	61
ENHANCED UNIVERSAL EMERGENCY NUMBER SERVICE (E911) .....	A10	1
ENTERPRISE SERVICE (SPECIAL REVERSE CHARGE TOLL SERVICE, WX SERVICE) .....	A18	33
EQUIPMENT IN EXPLOSIVE ATMOSPHERE .....	A2	46
ESP LINK .....	A30	17
ESTABLISHMENT AND FURNISHING OF SERVICE .....	A2	13
ESTABLISHMENT OF IDENTITY .....	A2	3
ETHERNET SERVICE .....	A28	1
EXCHANGE RATE GROUP CLASSIFICATION AND LOCAL CALLING AREAS .....	A3	3
EXCHANGE SERVICE AREA MAPS .....	SUPP. A3	
EXPEDITED ORDER CHARGE FOR WATS/TFC SERVICES .....	A19	40
EXPEDITED ORDER CHARGE .....	A20	103
EXPLANATION OF SYMBOLS .....		2
EXPLANATION OF TERMS .....	A1	1
EXPRESSTOUCH SERVICE .....	A13	30
EXTENDED AREA SERVICE (EAS) .....	A3	23
EXTENDED CALLING SCOPE (ECS) .....	A3	24

GENERAL EXCHANGE TARIFF

Embarq Florida, Inc.

Seventh Revised Sheet 7  
 Cancelling Sixth Revised Sheet 7  
 Effective: October 1, 2005

By: F. B. Poag  
 Director

INDEX

	<u>SECTION</u>	<u>SHEET</u>
FLAT- AND MESSAGE-RATE SERVICE .....	A2	14
FLAT-RATE SERVICE, MONTHLY EXCHANGE RATES .....	A3	44
FLOOR SPACE AND ELECTRIC POWER AT THE SUBSCRIBER'S PREMISES .....	A2	23
FLORIDA STATE UNIVERSITY, LOCAL TELEPHONE SERVICE FOR .....	A24	1
FOREIGN CENTRAL OFFICE SERVICE .....	A9	8
FOREIGN EXCHANGE LISTINGS .....	A6	14
FOREIGN EXCHANGE SERVICE .....	A9	1
FRAME RELAY SERVICE .....	A129	1
GENERAL REGULATIONS .....	A2	1
GRANDFATHERED COMMUNICATIONS SYSTEMS .....	A15	18
HAZARDOUS LOCATIONS, PROVISION OF SERVICE AT .....	A2	26
HOT LINE SERVICE (HLS) (CENTRAL TELEPHONE EXCHANGES ONLY) .....	A13	108
INDEMNIFYING AGREEMENT .....	A2	45
INDENTED LISTINGS .....	A6	10
INDIVIDUAL VOICE CHANNELS FOR CUSTOM ACCESS SOLUTIONS.....	A30	1
INITIAL SERVICE PERIODS .....	A2	22
INSTALLMENT BILLING OF SERVICE CONNECTION CHARGES .....	A4	6
INTEGRATED SERVICES DIGITAL NETWORK - BASIC RATE INTERFACE (ISDN-BRI) .....	A29	25
INTEGRATED SERVICES DIGITAL NETWORK - PRIMARY RATE INTERFACE (ISDN-PRI) II .....	A29	24.1
INTEGRATED SERVICES DIGITAL NETWORK - PRIMARY RATE INTERFACE (ISDN-PRI) .....	A129	11
INTERCONNECTION OF LOCAL EXCHANGE SERVICES TO SHARED TENANT SERVICES .....	A26	1



GENERAL EXCHANGE TARIFF

Embarq Florida, Inc.

Sixth Revised Sheet 8  
 Cancelling Fifth Revised Sheet 8  
 Effective: November 29, 2005

By: F. B. Poag  
 Director

INDEX

	<u>SECTION</u>	<u>SHEET</u>
LATE PAYMENT CHARGE .....	A2	38
LIABILITY OF THE COMPANY .....	A2	44
LIFELINE ASSISTANCE .....	A3	59
LIGHTLINK SERVICE.....	A21	1
LIMITATIONS AND USE OF SERVICE .....	A2	1
LIMITED COMMUNICATION .....	A2	6
LINK-UP FLORIDA .....	A4	11
LISTINGS, DIRECTORY .....	A6	1
LOCAL EXCHANGE EXCEPTIONS .....	A3	46
LOCAL EXCHANGE SERVICE .....	A3	1
LOCAL TAXES AND FEES, PROVISION FOR CERTAIN .....	A2	40
LOCAL TELEPHONE SERVICE FOR FLORIDA STATE UNIVERSITY.....	A24	1
LOCAL TELEPHONE SERVICE FOR STATE OF FLORIDA GOVERNMENTAL AGENCIES (CENTRAL TELEPHONE ONLY) .....	A22	1
LONG DISTANCE MESSAGE TELECOMMUNICATIONS SERVICE .....	A18	1
MAGNETIC TOLL TAPE BILLING .....	A13	64
MAINTENANCE AND REPAIRS . .....	A2	26
MAPS OF EXCHANGE SERVICE AREAS AND BASE RATE AREAS . .....	SUPP. A3	
MARKET TRIALS.....	A27	12
MESSAGE RATE PLAN – EXTENDED CALLING SCOPE (ECS) .....	A3	24
MESSAGE-RATE TRUNKS .....	A3	43
MINIMUM PROTECTION CRITERIA .....	A15	34
MISCELLANEOUS LISTINGS .....	A6	9
MISCELLANEOUS SERVICE ARRANGEMENTS .....	A13	1
MONTHLY EXCHANGE RATES .....	A3	39
MOVES OR CHANGES OF EXISTING PLANT . .....	A5	19

GENERAL EXCHANGE TARIFF

Embarq Florida, Inc.

Tenth Revised Sheet 9  
 Cancelling Ninth Revised Sheet 9  
 Effective: June 16, 2005

By: F. B. Poag  
 Director

INDEX

	<u>SECTION</u>	<u>SHEET</u>
976/900/N11 BLOCKING SERVICE .....	A13	74
N11 SERVICES .....	A10	1
NAMES SPELLED MORE THAN ONE WAY .....	A6	10
NIGHT, SUNDAY, AND HOLIDAY LISTINGS .....	A6	12
NONLISTED TELEPHONE NUMBERS .....	A6	20
NONPUBLISHED TELEPHONE NUMBERS .....	A6	17
1.544 MEGABIT PER SECOND (MBPS) SERVICE .....	A20	39
OBLIGATION TO FURNISH SERVICE .....	A2	13
OBSOLETE SERVICE OFFERINGS .....	A100	1
OBSOLETE SERVICE OFFERINGS - BASIC LOCAL EXCHANGE SERVICE .....	A103	1
OBSOLETE SERVICE OFFERINGS - DIGITAL CENTREX SERVICE (CENTRAL TELEPHONE EXCHANGES ONLY) .....	A111	2
OBSOLETE SERVICE OFFERINGS - DIGITAL CENTREX SERVICE FOR CITY, COUNTY, FEDERAL AND STATE AGENCIES (CENTRAL TELEPHONE EXCHANGES ONLY) .....	A123	1
OBSOLETE SERVICE OFFERINGS - EMERGENCY REPORTING SERVICES .....	A124	1
OBSOLETE SERVICE OFFERINGS - MISCELLANEOUS SERVICE ARRANGEMENTS .....	A113	1
OBSOLETE SERVICE OFFERINGS - SWITCHLINK AND SWITCHLINK PLUS .....	A128	1
OBSOLETE SERVICE OFFERINGS - N11 SERVICES .....	A139	1
OBSOLETE SERVICE OFFERINGS - SPECIAL PACKAGED OFFERING .....	A127	1
OBSOLETE SERVICE OFFERINGS - TELEPHONE ANSWERING SERVICE FACILITIES .....	A108	1
OFF-PREMISES EXTENSION SERVICE .....	A13	102
OPERATOR ASSISTED LOCAL CALLS .....	A3	55
OPERATOR SCREENING .....	A13	67
OPPORTUNITY 800 SERVICE .....	A19	36
OPTIONAL EXTENDED AREA SERVICE (OEAS) .....	A3	32
OPTIONAL EXTENDED LOCAL CALLING (OELC) .....	A3	28
OPTIPOINT SERVICE .....	A20	130
OWNERSHIP OF EQUIPMENT AND FACILITIES, PROVISION OF .....	A2	23
OWNERSHIP OF TELEPHONE NUMBERS, PROVISION AND .....	A2	24

GENERAL EXCHANGE TARIFF

Embarq Florida, Inc

Fifth Revised Sheet 10  
 Cancelling Fourth Revised Sheet 10  
 Effective: February 24, 2006

By: F. B. Poag  
 Director

INDEX

	<u>SECTION</u>	<u>SHEET</u>
PAY TELEPHONE LISTINGS .....	A6	9
PAY TELEPHONE SERVICE (PATS) .....	A7	10
PAYMENT ARRANGEMENTS AND CREDIT ALLOWANCES .....	A2	30
PAYMENT FOR SERVICE .....	A2	36
PAYPHONE SURCHARGE .....	A18	41.5
PBX TRUNKS, MONTHLY EXCHANGE RATES .....	A3	43
PERIOD FOR THE PRESENTATION OF CLAIMS .....	A2	45
PERSONAL DIAL PAGING SERVICE .....	A17	1
PREMISES VISIT CHARGE .....	A4	2
PREMISES WORK CHARGE .....	A4	3
PRI BUNDLE.....	A27	11.1
PRIVATE BRANCH EXCHANGE (PBX) LISTINGS .....	A6	8
PRIVATE BRANCH EXCHANGE (PBX) SERVICE .....	A16	1
PRIVATE LINE SERVICE .....	A20	1
PRIVATE LINE SERVICE AND CHANNELS .....	A120	1
PRIVATE RIGHTS-OF-WAY .....	A5	29
PRIVATE SWITCH DATABASE SERVICE .....	A5	69.6
PROVISION OF DIRECTORIES .....	A2	24
PROVISION AND OWNERSHIP OF EQUIPMENT AND FACILITIES .....	A2	23
PROVISION AND OWNERSHIP OF TELEPHONE NUMBERS .....	A2	24
PROVISION FOR CERTAIN LOCAL TAXES AND FEES .....	A2	40
PSAP EQUIPMENT, RATES FOR .....	A10	15
PSAP EQUIPMENT, RATES FOR-OBSOLETE SERVICE OFFERING.....	A124	1
PUBLIC SET USE FEE .....	A7	31

GENERAL EXCHANGE TARIFF

Embarq Florida, Inc.

Third Revised Sheet 11  
 Cancelling Second Revised Sheet 11  
 Effective: December 2, 2005

By: F. B. Poag  
 Director

INDEX

	<u>SECTION</u>	<u>SHEET</u>
RATE CENTERS .....	A18	6
RATE GROUPS, COMPANY-WIDE .....	A3	2
REARRANGEMENT OF EXISTING PLANT .....	A5	19
RECORD CHANGE CHARGE .....	A4	3
RECORDED PUBLIC ANNOUNCEMENTS .....	A2	5
RECORDING OF TELEPHONE CONVERSATIONS .....	A15	4
REFERENCE LISTINGS .....	A6	9
REFUSAL OR DISCONTINUANCE OF SERVICE .....	A2	7
REGISTERED EQUIPMENT, CONNECTIONS OF .....	A15	7
REGROUPING PROCEDURES .....	A3	22
REMOTE CALL FORWARDING .....	A13	56
REPAIRS AND MAINTENANCE .....	A2	26
REPEAT DIALING .....	A13	33
REQUIREMENTS AS TO EARNINGS, PUBLIC TELEPHONES .....	A7	5
RESALE OF LOCAL EXCHANGE SERVICE - SHARED TENANT SERVICE .....	A26	1
RESALE OF SERVICE .....	A2	3
RESIDENCE AND BUSINESS MAIN SERVICE RATES .....	A3	39
RESIDENCE LISTINGS .....	A6	4
RESIDENCE MAIN FLAT-RATE SERVICE .....	A3	44
RESIDENCE RATE APPLICATION .....	A2	19
RESIDENCE SERVICE FOR COMPANY EMPLOYEES .....	A2	29
RESTORE SERVICE .....	A4	3
RESTRICTED SENT PAID SERVICE (RSPS) CENTRAL TELEPHONE EXCHANGES ONLY .....	A13	79
RETURN CALL .....	A13	31
REVERSE NOTIFICATION TELEPHONE NUMBER DATABASE SERVICE.....	A10	69.9
RIGHTS-OF-WAY, PRIVATE .....	A5	28
ROTARY SERVICE - BUSINESS .....	A3	42.1
ROTARY SERVICE - RESIDENTIAL .....	A3	41.1

GENERAL EXCHANGE TARIFF

Embarq Florida, Inc.

Seventeenth Revised Sheet 12  
 Cancelling Sixteenth Revised Sheet 12  
 Effective: May 4, 2005

By: F. B. Poag  
 Director

INDEX

	<u>SECTION</u>	<u>SHEET</u>
711 SERVICE FOR TELECOMMUNICATIONS RELAY SERVICES (TRS) .....	A10	70
SCHOOL AND LIBRARY DISCOUNTS .....	A2	29
SECRETARIAL LINE TERMINATIONS .....	A8	2
SECRETARIAL SERVICE IN DIALING ARRANGEMENTS .....	A8	6
SELECTION OF LOCATION OF PUBLIC TELEPHONE .....	A7	1
SELECTIVE CALL REJECTION .....	A13	35
SEMPUBLIC TELEPHONE SERVICE - OBSOLETE		
SERVICE OFFERING .....	A107	1
SERIES 2000 CHANNELS .....	A20	42
SERVICE ARRANGEMENTS INVOLVING EXCESSIVE COST .....	A5	1
SERVICE CHARGES .....	A4	1
SERVICE CHARGES FOR INSIDE MOVES AND CHANGES .....	A4	7
SERVICE IRREGULARITIES .....	A2	44
SERVICE ORDERING CHARGE .....	A4	1
SET USE FEE, PUBLIC .....	A7	31
SHARED TENANT SERVICES .....	A26	1
SHARING ARRANGEMENTS - LOCAL EXCHANGE SERVICE .....	A26	23
SIGNALRING .....	A13	53
SIMPLIFIED MESSAGE DESK INTERFACE (SMDI) .....	A13	89
SINGLE PARTY ACCESS LINE FEATURE - CUT-OFF		
ON DISCONNECT .....	A13	92
SMALLTALK .....	A3	39
SPECIAL ACCESS SERVICES .....	A3	61
SPECIAL BILLING SERVICE .....	A13	62
SPECIAL CONSTRUCTION, CONDITIONS REQUIRING .....	A5	5
SPECIAL DISASTER RELIEF RATES INITIATED BY THE COMPANY .....	A5	51
SPECIAL IDENTITY NUMBER ARRANGEMENT (SINA) .....	A113	1
SPECIAL PROMOTIONS .....	A2	54
SPECIAL REVERSED CHARGE TOLL SERVICE .....	A18	33
SPECIAL SERVICE ARRANGEMENTS .....	A5	36
SPEED CALLING .....	A13	21
ETHERNET SERVICES.....	A28	13
PRIVACY ID SERVICE .....	A13	118
CONSUMER SENSE LOCAL TOLL .....	A18	27
SIMPLY FIVE .....	A18	41.3
SOLUTIONS - RESIDENCE .....	A27	1
SOLUTIONS - BUSINESS .....	A27	8
TALKING CALL WAITING .....	A13	119
SONET RING SERVICE .....	A20	154

GENERAL EXCHANGE TARIFF

Embarq Florida, Inc.

Sixth Revised Sheet 13  
 Cancelling Fifth Revised Sheet 13  
 Effective: October 26, 2001

By: F. B. Poag  
 Director

INDEX

	<u>SECTION</u>	<u>SHEET</u>
STATE OF FLORIDA ELECTRONIC SWITCHED NETWORK (SUNCOM) (UNITED TELEPHONE EXCHANGES ONLY) .....	A12	17
STATE OF FLORIDA GOVERNMENT AGENCIES, LOCAL SERVICE FOR .....	A22	1
SUNCOM (CCSA) MESSAGE TAPE FOR FLORIDA STATE UNIVERSITY (CENTRAL TELEPHONE ONLY) .....	A13	65
SUSPENSION OF BUSINESS AND RESIDENCE SERVICE .....	A2	27
 211 SERVICE FOR COMMUNITY INFORMATION AND REFERRAL SERVICES	 A10	 76
 TELECOMMUNICATIONS ACCESS SYSTEM ACT OF 1991 (TASA) .....	 A2	 53
TELECOMMUNICATIONS DEVICES (TDD'S), HANDSETS, AND SIGNALING EQUIPMENT FOR THE HEARING IMPAIRED .....	A14	1
TELECOMMUNICATIONS DEVICES (TDD'S), HANDSETS, AND SIGNALING EQUIPMENT FOR THE HEARING IMPAIRED-OBSOLETE SERVICE OFFERINGS (UNITED TELEPHONE ONLY) .....	A114	1
TELECOMMUNICATIONS DEVICES FOR PERSONS WITH HEARING IMPAIRMENT (CENTRAL TELEPHONE ONLY) .....	A114	3
TELECOMMUNICATIONS SERVICE PRIORITY (TSP) SYSTEM .....	A13	93
TELEPHONE ANSWERING SERVICE FACILITIES .....	A8	1
TELEPHONE ANSWERING SERVICE FACILITIES - OBSOLETE SERVICE OFFERINGS .....	A108	1
TELEPHONE DIRECTORIES, LOCAL EXCHANGE .....	A6	21
TELEPHONE DIRECTORIES, PROVISION OF .....	A2	24
TELEPHONE NUMBER CHANGE .....	A4	4
TELEPHONE NUMBERS, PROVISION AND OWNERSHIP OF .....	A2	24
TELESAVER SERVICE .....	A18	38

GENERAL EXCHANGE TARIFF

Embarq Florida, Inc.

Tenth Revised Sheet 14  
 Cancelling Ninth Revised Sheet 14  
 Effective: January 6, 2004

By: F. B. Poag  
 Director

INDEX

	<u>SECTION</u>	<u>SHEET</u>
TEMPORARY LISTINGS FOR TENANTS SUBLEASING		
SUBSCRIBER'S PREMISES .....	A6	13
TEMPORARY SERVICE REQUIRING CONSTRUCTION .....	A5	21
TEMPORARY SUSPENSION OF TELEPHONE SERVICE .....	A2	27
TERMINATION LIABILITY .....	A2	12
TERMINATION OF SERVICE .....	A2	11
THIRD PARTY BLOCK SERVICE .....	A13	88
THREE-WAY CALLING .....	A13	20
TOLL-PAC .....	A3	25
TOLL TERMINAL SERVICE .....	A13	111
TRADE NAMES .....	A6	6
TRANSFER OF SERVICE BETWEEN SUBSCRIBERS .....	A2	21
TRANSITIONAL LIFELINE ASSISTANCE .....	A3	60
TRANSLINK SERVICE .....	A21	1
TRANSLINK SERVICE .....	A120	41
TRANSMITTING MESSAGES .....	A2	6
TRAP AND TRACE .....	A2	48
TROUBLE LOCATION CHARGE .....	A4	10
TRUNKS .....	A3	43
TWO-TIER PAYMENT PLANS .....	A2	40
UNDERGROUND DISTRIBUTION SYSTEM - SUBDIVISIONS .....	A5	38
UNLAWFUL USE OF SERVICE .....	A2	6
UNPAID ACCOUNT - APPLICATION FOR NEW SERVICE .....	A2	15
USE OF FACILITIES OF OTHER CONNECTING CARRIERS .....	A2	44
USE OF SUBSCRIBER'S SERVICE .....	A2	1
UTILIZATION OF EMERGENCY E911 SERVICE .....	A6	20

GENERAL EXCHANGE TARIFF

Embarq Florida, Inc.

By: F. B. Poag  
Director

Second Revised Sheet 15  
Cancels First Revised Sheet 15  
Effective: February 16, 2006

INDEX

	<u>SECTION</u>	<u>SHEET</u>
VACATION SERVICE .....	A2	27
VALUPAK .....	A18	35
VANITY LISTINGS.....	A6	16
VERIFICATION AND EMERGENCY INTERRUPT SERVICE .....	A3	57
VOICE GRADE SERVICE, SERIES 2000 .....	A20	42
WEATHER ANNOUNCEMENT EQUIPMENT .....	A13	1
WIDE AREA TELECOMMUNICATIONS SERVICE (WATS) .....	A19	1
WIRED MUSIC SYSTEMS (CENTRAL TELEPHONE ONLY) .....	A115	1
WORK PERFORMED OUTSIDE REGULAR WORKING HOURS .....	A2	26
ZONE DENSITY PLAN .....	A20/A25	28/7



## GENERAL EXCHANGE TARIFF

Embarq Florida, Inc.

By: F. B. Poag  
Director

SECTION A1  
First Revised Sheet 1  
Cancelling Original Sheet 1  
Effective: January 1, 1997

### EXPLANATION OF TERMS

**ACCESS LINES** - A telephone facility between the station protector on the customer's telephone service or PBX to, and including, the serving central office main frame.

**ACCESSORIES** - Devices which are mechanically attached to, or used with, the facilities furnished by the Company and which are independent of, and not electrically, acoustically or inductively connected to the communications path of the telecommunications systems.

**ACOUSTICAL CONNECTION** - A connection made by sound.

**ADD-ON** - A feature which permits a station user to add another station to the conversation on incoming central office trunk calls.

**AFFILIATED ENTITIES** - Affiliated entities are those corporations, partnerships, proprietorships or other groups that hold stock in excess of fifty percent (50%) of the stock of the entity which claims to be affiliated.

**AGENT OR REPRESENTATIVE** - One authorized to act on behalf of another, usually by legal contract.

**AIRLINE MEASUREMENT** - The shortest distance between two points. Also see Mileage.

**ALTERNATING CURRENT SUPPLY** - Electrical energy which is used for power purposes, for protection of equipment in humid areas, and for the operation of bells and signal devices.

**AUTHORIZED PROTECTIVE CONNECTING MODULE** - A protective unit which is designed and manufactured in compliance with standards as set forth by Part 68 of the FCC rules and regulations.

## GENERAL EXCHANGE TARIFF

Embarq Florida, Inc.

By: F. B. Poag  
Director

SECTION A1  
First Revised Sheet 2  
Cancelling Original Sheet 2  
Effective: January 1, 1997

### EXPLANATION OF TERMS

**AUTHORIZED USER** - A person, firm, or corporation, other than the subscriber, who has been authorized by the Company to communicate over a private line or channel according to the terms of the tariff and (1) on whose premises a private line service is terminated or (2) who receives from or sends to the subscriber over such private line or channel communications relating solely to the business of the subscriber.

**AUXILIARY LINE** - An individual circuit connecting an additional main station with a central office for one-way (inward to the subscriber) service in order to relieve the load on the first individual line.

**AUTOMATIC IDENTIFICATION OUTWARD DIAL (AIOD)** - Provides the capability of automatically identifying the number being called and the number from which the call originates.

**BASIC TERMINATION CHARGE** - A charge applying when a subscriber discontinues a service prior to the expiration of the initial service period designated for such item. The basic termination charge is an amount established for an individual service from which the termination charge is computed.

**BATTERY** - Electrical energy for talking and signaling purposes other than ringing except in the case of intercommunicating systems when direct current may be used for ringing the station bells.

**BAUD** - A unit of signaling speed which is the reciprocal of the time duration in seconds of the shortest signal element (mark or space) within a code signal. The speed in bauds is the number of signal elements per second.

**BILL TO THIRD PARTY** - A billing arrangement by which a call can be charged to an authorized station as determined by the Company other than the station originating the call or the station where the call is terminated.

## GENERAL EXCHANGE TARIFF

Embarq Florida, Inc.

By: F. B. Poag  
Director

SECTION A1  
First Revised Sheet 3  
Cancelling Original Sheet 3  
Effective: January 1, 1997

### EXPLANATION OF TERMS

**BRIDGING CONNECTION** - Amplifying equipment and services required to connect a station, or an interexchange channel serving a station, at an intermediate point on an interexchange network or to connect an additional station at a terminal point.

**BUILDING (SAME)** - The term "Same Building," as it applies to other than Shared Tenant Service buildings, is to be interpreted as a structure under one roof, or two or more structures under separate roofs but connected by covered passageways not crossing public thoroughfares, in which the cable of the Company can be safely run provided the plant facility requirements are not appreciably greater than would be required normally if all structures were under one roof. In those cases where there are several structures under separate roofs, but connected by enclosed passageways and the plant facility requirements for furnishing telephone service are appreciably greater than would be required normally if all the structures were under one roof, the term "Same Building" applies individually to each of the separate structures. Pipes and conduit are not considered enclosed passageways.

**BUILDING (SINGLE)** - In a Shared Tenant Service application, the term "single building" means one structure under one roof. Separate buildings superficially connected are not considered as one building.

**CALL** - An attempted or completed communication.

**CALL AGGREGATOR** - Any vendor that, in the ordinary course of its operations, makes telephones available to the public or to transient users of its premises for telephone calls using a provider of operator services.

## GENERAL EXCHANGE TARIFF

Embarq Florida, Inc.

By: F. B. Poag  
Director

SECTION A1  
First Revised Sheet 4  
Cancelling Original Sheet 4  
Effective: January 1, 1997

### EXPLANATION OF TERMS

**CALLING AREA LOCAL** - The area within which telephone service is furnished subscribers under a specific schedule of exchange rates and without long distance charges. A local service area may include one or more exchange service areas under extended area service arrangements.

**CANCELLATION CHARGE** - A charge applicable under certain conditions when an application for service and/or facilities is canceled in whole or in part prior to the completion of the work involved.

**CAPTION LISTING** - The listing of the subscriber's name without address or telephone number followed by a series of indented listings covering branches or different departments of the business or other listings associated with the residence.

**CENTRAL OFFICE** - A switching unit for establishing telephone communication between stations by having the necessary equipment and operating arrangements for terminating and interconnecting lines and trunks.

**CENTRAL OFFICE AREA** - The specific section or area served by a single central office and serving all subscribers' lines which have a common central office designation.

**CENTRAL OFFICE CONNECTING FACILITY** - A facility furnished to an Other Common Carrier by the Company, in accordance with the Company's facilities for Other Common Carrier's tariffs, between the terminal location of the Other Common Carrier and a point of connection on the Company premises.

**CENTRAL OFFICE LINE** - A circuit extending from a central office to the demarcation point of an individual line, rotary line, or a PBX trunk.

GENERAL EXCHANGE TARIFF

Embarq Florida, Inc.

By: F. B. Poag  
Director

SECTION A1  
Fourth Revised Sheet 5  
Cancelling Third Revised Sheet 5  
Effective: March 1, 2003

EXPLANATION OF TERMS

**CHANNEL** - An electrical path suitable for the transmission of communications.

**CHANNEL TERMINATION** - The facilities required for terminating and connecting an interexchange channel to a station or the facilities required where, at the request of the customer, such an interexchange channel is terminated in a telephone company central office.

**CLASS OF SERVICE** - A description of telephone service furnished a customer in terms such as:

- a. For Exchange Service:
  - 1. Grade of Line: Individual Line
  - 2. Type of Rate: Flat Rate or Measured Rate
  - 3. Character of Use: Business or Residence
- b. For Long Distance Telecommunications Service:
  - 1. Type of Call: Station-to-Station, Person-to-Person, etc.
- c. For Wide area Telecommunications Service:
  - 1. Type of Rate: Outward or TFC Service

**COIN DROP PAY TELEPHONE** - A telephone station equipped with a device for collecting money in payment of telephone messages and used in connection with pay telephone service.

**COINLESS PAY TELEPHONE** - A pay telephone connected directly to the Telephone Company or another Carrier for the placing of collect, credit card and third-number billed calls only.

## GENERAL EXCHANGE TARIFF

Embarq Florida, Inc.

By: F. B. Poag  
Director

SECTION A1  
First Revised Sheet 6  
Cancelling Original Sheet 6  
Effective: January 1, 1997

### EXPLANATION OF TERMS

**COLLECT CALL** - A billing arrangement by which the charge for a call may be reversed (charged to the called station) provided the charge is accepted at the called station. A collect call may be billed to a credit card or third party number.

**COMMISSION** - Florida Public Service Commission.

**COMMON BATTERY SERVICE** - The type of telephone service in connection with which electrical energy for talking and signaling is supplied from a central point.

**COMMUNICATING DEVICE** - A device consisting of a transmitter, receiver, network control signaling unit, and associated apparatus and so connected as to permit the sending and receiving of telecommunication messages.

**COMMUNICATING SYSTEMS** - Channels and other facilities which are capable, when not connected to telecommunications services, of communications between customer-provided terminal equipment.

**COMPANY** - Whenever used in this tariff, "Company" refers to Embarq Florida, Inc., (formerly United Telephone Company of Florida and/or Central Telephone Company of Florida) unless the context clearly indicates otherwise.

**COMPANY STATION** - A station for which the central office equipment, lines and station equipment are owned and maintained by the company and provided as a part of the Company's service offering.

## GENERAL EXCHANGE TARIFF

Embarq Florida, Inc.

By: F. B. Poag  
Director

SECTION A1  
First Revised Sheet 7  
Cancelling Original Sheet 7  
Effective: January 1, 1997

### EXPLANATION OF TERMS

**COMPLETED CALL** - A completed call is a calling attempt by the subscriber that results in an off-hook condition at the receiving end. Such conditions shall include the following actions:

- a. The called party responds by personally answering the call;
- b. A customer controlled automatic answering device responds by answering the call;
- c. A Company recording, under the control of the called party responds to the calling attempt (i.e., Call Block, Anonymous Call Rejection would be completed calls), except for attempts defined as incomplete calls; and/or
- d. The calling attempt, when under the control of the called party (i.e., Call Forwarding Busy, Call Forwarding Don't Answer, etc.), is forwarded to another telephone number which results in one of the conditions described preceding.

**CONFORMANCE NUMBER** - An identifying number assigned by the FCC to a particular model of conforming answering device incorporating an authorized protective connecting module when that model or device is in conformance with the provisions set forth by the FCC in its technical reference for conforming answering devices.

**CONFORMING ANSWERING DEVICE** - A customer-provided device which automatically answers incoming calls; transmits a prerecorded voice message or appropriate audible signal to the calling party; records a voice message from the calling party if so designed and arranged; and automatically disconnects from the line in a prearranged manner on completion of the last of the functions for which it was designed and arranged as described in this paragraph. The conforming answering device may include remote interrogation and/or device function control. A conforming answering device must incorporate an authorized protective connecting module and must bear a valid conformance number.

GENERAL EXCHANGE TARIFF

Embarq Florida, Inc.

By: F. B. Poag  
Director

SECTION A1  
First Revised Sheet 8  
Cancelling Original Sheet 8  
Effective: January 1, 1997

EXPLANATION OF TERMS

**CONNECTING ARRANGEMENT** - The protective equipment to accomplish a direct electrical connection of customer-provided facilities with the facilities of the Company, or of facilities of the Company with other facilities of the Company when such customer provided equipment does not conform with the FCC Rules and Regulations on terminal equipment.

**CONNECTING COMPANY** - A corporation, association, firm or individual owning and operating a toll line and/or one or more central offices providing local exchange telephone service to the public and with whom the Company interchanges traffic.

**CONSTRUCTION CHARGE** - A separate initial charge authorized in the tariff for construction of pole lines, circuits, facilities, etc., in excess of that contemplated under the rates quoted in the exchange tariffs.

**CONSULTATION HOLD** - Permits a station user to hold an existing external call while originating a new call for the purpose of consultation. After consultation, the initial call can be restored.



## GENERAL EXCHANGE TARIFF

Embarq Florida, Inc.

By: F. B. Poag  
Director

SECTION A1  
First Revised Sheet 9  
Cancelling Original Sheet 9  
Effective: January 1, 1997

### EXPLANATION OF TERMS

**CONTINUOUS PROPERTY** - A continuous plot of ground, including any building thereon, which is used exclusively by the customer (or by an authorized user of the customer's service) and which is not separated by property occupied by others.

Application of continuous property treatment to the campus of a college or university will be based upon the following:

- a. In evaluating "continuous property" for a college or university, especially in a metropolitan area, a map of an individual campus of a college or university will be considered for determining continuous property.
- b. The addition of properties, not shown on the original map, when being made a part of the campus, will be reviewed by the Company for consideration as continuous property.
- c. Where maps are not available, the Company will review the general campus area in determining whether off-campus property additions can reasonably be considered as continuous property.

**CONTRACT** - The service agreement between a customer and the Company under which service and facilities for communication between specified locations for designated periods and for the use of the customer and the authorized users specifically named in the contract are furnished in accordance with the provisions of this tariff.

**CONTRACT PERIOD** - The length of time for which a subscriber is responsible for the charges associated with service and facilities.

**COST** - Wherever the word "cost" is used in this tariff, it is intended to cover the cost of labor, material, and incidentals, plus a charge for supervision.

## GENERAL EXCHANGE TARIFF

Embarq Florida, Inc.

By: F. B. Poag  
Director

SECTION A1  
First Revised Sheet 10  
Cancelling Original Sheet 10  
Effective: January 1, 1997

### EXPLANATION OF TERMS

**CUSTOMER** - Any person, firm, partnership, corporation, municipality, cooperative organization or government agency furnished communication service by the Company under the provisions and regulations of its tariff. Same as "subscriber".

**CUSTOMER OF RECORD/SUBSCRIBER OF RECORD** - A person, firm, partnership, corporation, municipality, cooperative organization or government agency which orders and is responsible for paying the telephone bill for any form of exchange service furnished by the Company. A subscriber may also be the agent for multi subscribers when the exchange service is for residential individual line service and the service will be used by multi owners of the individual residential apartment, the individual residential condominium unit apartment or the single-occupancy residential house.

**CUSTOMER PREMISES** - The discrete real property owned, leased, or controlled by a customer for the customer's own business or residential purposes.

**CUSTOMER PREMISES EQUIPMENT (CPE)** - Terminal equipment owned and maintained by the customer, such as telephone sets, data terminal equipment, key system equipment, etc. CPE does not include Company-provided pay stations, terminal equipment used for official telephone company business, subscriber multiplexing terminal equipment, subscriber pair gain equipment, transmit earth stations, telecommunications devices for the deaf (TDD) or E911 PSAP equipment.

**CUSTOMER-PROVIDED TERMINAL EQUIPMENT** - Devices or apparatus and their associated wiring, provided by a customer, which do not constitute a communications system and which, when connected to the communications path of the telecommunications system, are so connected either electrically, acoustically, or inductively.

## GENERAL EXCHANGE TARIFF

Embarq Florida, Inc.

By: F. B. Poag  
Director

SECTION A1  
First Revised Sheet 11  
Cancelling Original Sheet 11  
Effective: January 1, 1997

### EXPLANATION OF TERMS

**DATA ACCESS ARRANGEMENT** - A protective connecting arrangement for use with the network control signaling unit, or, in lieu of the connecting arrangement, an arrangement to identify a central office line and protective facilities and procedures to determine compliance with criteria set forth in this tariff.

**DATA SET** - A device designed to accept from and/or impart to data transmitting and/or receiving terminal equipment material in the form produced and/or accepted by the terminal equipment into a form acceptable for transmission over network facilities.

**DEMARCATIION POINT** - The point of physical interconnection (connecting block, terminal strip, jack, protector, optical network interface or remote isolation device) between the telephone network and the customer's premises wiring. This point is part of the telephone network provided and maintained by the Telephone Company under tariff. The location of this point is:

- a. Single line/single customer building - either at the point of physical entry to the building, or at a junction point as close as practicable to the point of entry.
- b. Single line/multi customer building - within the customer's premises at a point easily accessed by the customer.
- c. Multi line systems/single or multi-customer building - at a point within the same room or within 25 feet of the FCC registered terminal equipment or cross-connect field.
- d. Temporary Accommodations Subscriber Premises with inadequate grounding (i.e., some mobile homes, trailers, houseboats, construction modules) - on a permanent stake, pole or structure with a suitable safety ground.

## GENERAL EXCHANGE TARIFF

Embarq Florida, Inc.

By: F. B. Poag  
Director

SECTION A1  
First Revised Sheet 12  
Cancelling Original Sheet 12  
Effective: January 1, 1997

### EXPLANATION OF TERMS

**DIGILINK SERVICE** - A digital transmission service designed to transmit signals end to end over digital facilities routed through the Company's central offices. DigiLink is furnished at synchronous rates of 2.4, 4.8, 9.6, 19.2 and 56 Kbps between two or more points located within the same LATA. This service is available in United Telephone exchanges only.

**DIRECT BURIAL** - The installation of cables or conductors directly in the earth and not in conduit or duct.

**DIRECT CONNECTION** - Connection of terminal equipment to exchange facilities by means other than acoustic and/or inductive coupling.

**DIRECT CURRENT SUPPLY** - Electrical energy for talking and signaling purposes other than ringing. However, in some inter-communicating systems, direct current may be used for ringing the station bells.

**DIRECT ELECTRICAL CONNECTION** - A physical connection of the electrical conductors in the communications path.

**DIRECTORY ASSISTANCE CALL COMPLETION (DACC)** - A service which provides customers who dial Directory Assistance from a touch-tone telephone the option of having the requested local or intraLATA telephone number automatically dialed and the call completed by the automated Directory Assistance System.

**DIRECTORY LISTING** - The publication in the Company's directory and/or directory assistance records of information relative to a subscriber's telephone number, by which telephone users are able to ascertain the call number of a desired station.

## GENERAL EXCHANGE TARIFF

Embarq Florida, Inc.

By: F. B. Poag  
Director

SECTION A1  
First Revised Sheet 13  
Cancelling Original Sheet 13  
Effective: January 1, 1997

### EXPLANATION OF TERMS

**DISCONTINUANCE OF SERVICE** - An arrangement made at the request of the subscriber, or initiated by the Company for violation of tariff regulations by the subscriber, for a permanent interruption of telephone service. Once effected, telephone equipment would be removed, if appropriate, from the subscriber's premises and a "final" bill would be rendered showing monies owed to the Company as of the date service was disconnected.

**DORMITORY STATION** - A station furnished to a college or university and located in the living quarters of students, faculty members, or employees.

**DROP WIRE** - Wires used to connect the circuits of open wire, aerial, buried, or underground distribution facilities to a point of entrance to the building where connection is made with the inside wiring.

**DUPLEX SERVICE** - Service which provides for simultaneous transmission in both directions.

**EQUALIZATION** - The treatment applied to a telecommunications channel so that the component frequencies of the program material transmitted have about the same relationship at the two ends of the channel.

**ENTERPRISE SERVICE** - A service plan by which a subscriber can offer his/her customers in selected areas the privilege of calling him/her without payment of toll charges and without having to request that charged be reversed.

## GENERAL EXCHANGE TARIFF

Embarq Florida, Inc.

By: F. B. Poag  
Director

SECTION A1  
Second Revised Sheet 14  
Cancelling First Revised Sheet 14  
Effective: May 29, 1997

### EXPLANATION OF TERMS

**EXCHANGE** - An area served by a central office or group of central offices, together with the subscriber's lines connected thereto, forming a local system which furnishes means of telephone intercommunication without toll charges between subscribers within a specified area, usually a single city, town or village; a toll rate center. When an exchange includes only one central office, it is termed a single office exchange, but when it includes more than one central office, the exchange is termed a multi office exchange.

**EXCHANGE LINE** - Any line (circuit) directly or indirectly connecting an exchange station with a central office. Exchange lines are subdivided into Central Office Lines, Main Station Lines, Extension Station Lines, Extension Lines, PBX station Lines, Centrex Station Lines and Tie Lines.

**EXCHANGE SERVICE** - The general telephone service rendered in accordance with tariff provisions. Exchange service is a general term describing as a whole, the facilities provided for local intercommunication, together with the right to originate and receive a specified or an unlimited number of local messages at charges in accordance with the provisions of this tariff.

**EXCHANGE SERVICE AREA** - The geographical area served by an exchange within which local telephone service is furnished at the exchange rates applicable within that exchange.

**EXTENDED AREA SERVICE** - A type of telephone service furnished under tariff provisions whereby subscribers of a given exchange may complete calls to and, where provided by the tariff, receive calls from one or more exchanges without the application of long distance message telecommunication charges.

## GENERAL EXCHANGE TARIFF

Embarq Florida, Inc.

By: F. B. Poag  
Director

SECTION A1  
First Revised Sheet 15  
Cancelling Original Sheet 15  
Effective: January 1, 1997

### EXPLANATION OF TERMS

**EXTENSION LINE** - A circuit connecting an extension telephone or extension bell with the telephone circuit to which the main telephone is connected or for connecting a Private Branch Exchange (PBX) station to a PBX switchboard or to another PBX station.

**EXTENSION LINE MILEAGE** - The measurement applying to that portion of an extension line in excess of the length provided by the Company without additional charge.

**FLAT RATE SERVICE** - A classification of exchange service for which a stipulated charge is made, regardless of the amount of use.

**FOREIGN CENTRAL OFFICE MILEAGE** - The measurement applying to a line within the exchange connecting a subscriber's main access line or PBX trunk with a central office other than that from which he/she would normally be served, for the use of which a separate circuit charge is made in addition to the basic rate.

**FOREIGN CENTRAL OFFICE SERVICE** - A classification of exchange service furnished to a customer in a multi-office exchange from a central office other than the one from which service would normally be furnished.

**FOREIGN EXCHANGE LISTING** - The listing of a subscriber in the alphabetical list of an exchange other than that for the exchange from which the subscriber is served.

**FOREIGN EXCHANGE MILEAGE** - The measurement applying to a line connecting a subscriber's main line or PBX trunk with a central office of an exchange other than that from which the subscriber would normally be served, for the use of which a separate charge is made in addition to the basic rate.

## GENERAL EXCHANGE TARIFF

Embarq Florida, Inc.

By: F. B. Poag  
Director

SECTION A1  
First Revised Sheet 16  
Cancelling Original Sheet 16  
Effective: January 1, 1997

### EXPLANATION OF TERMS

**FOREIGN EXCHANGE SERVICE** - A classification of exchange service furnished to a customer from an exchange other than the one from which he/she would normally be served.

**GENERATOR** - A mechanical device for producing electrical current for ringing. Generators designed to be hand-operated are termed "hand generators" and those which are not to be hand-operated are termed "power generators."

**GRADE OF SERVICE** - The type of service which may be provided to a customer over a telephone access line, such as individual residence, business, rotary or PBX.

**HALF DUPLEX SERVICE** - Service which provides for transmission alternately in either direction or for transmission in one direction only.

**HARM** - Electrical hazards to persons, damage to Company equipment, malfunctions of Company billing equipment, and degradation of service to persons other than the user of the subject terminal equipment or communications system, as well as the calling or called party.

**HOST OFFICE** - Denotes an electronic switching system which provides call processing capabilities for one or more Remote Modules or Remote Systems.

**HUB** - Denotes a Company designated wire center where bridging or multiplexing functions are performed.

**INCOMPLETE CALL ATTEMPT** - Calls that are not completed due to insufficient answering capability. Call attempts are considered incomplete if the calling party receives a busy signal, a ring with no answer, or a recorded message stating network difficulty in completing the call, number changed, number invalid, number not in service or number not assigned.



GENERAL EXCHANGE TARIFF

Embarq Florida, Inc.

By: F. B. Poag  
Director

SECTION A1  
Second Revised Sheet 17  
Cancelling First Revised Sheet 17  
Effective: April 1, 1997

EXPLANATION OF TERMS

**INDENTED LISTING** - A directory listing indented under another listing.

**IDENTIFICATION OUTWARD DIALING** - Provides the capability of identifying the number being called and the number from which the call originates.

**INDIVIDUAL LINE SERVICE** - A classification of exchange service which provides that only one main station shall be served by the line connecting such station with the central office or other switching unit.

**INDUCTIVE CONNECTION** - A connection made by using the electromagnetic field generated by the telephone equipment.

**INITIAL SERVICE PERIOD** - The minimum period of time for which service, facilities, and equipment are provided.

**INSTALLATION CHARGE** - A nonrecurring charge applying to the provision of certain services or facilities as distinguished from the service connection charge applicable for establishment of basic telephone service. The installation charge is normally associated with optional service features and may sometimes be called an "initial" charge.

## GENERAL EXCHANGE TARIFF

Embarq Florida, Inc.

By: F. B. Poag  
Director

SECTION A1  
Third Revised Sheet 18  
Cancelling Second Revised Sheet 18  
Effective: April 9, 1999

### EXPLANATION OF TERMS

**INTERCEPT SERVICE** - A service arrangement whereby calls placed to an unequipped nonworking, a disconnected or discontinued telephone number are intercepted by operator, recording or audio response computer, and the calling party is informed that the called telephone number is not in service, has been disconnected, discontinued, or changed to another number, or that calls are received by another telephone. This service is also provided in certain central offices or switching centers to inform the calling party of system blockages, inability of the system to complete a call as dialed, no such office code, all circuits busy, etc.

**INTERFACE** - That point on the premises of the customer at which provision is made for connection of other than telephone company provided facilities to exchange facilities provided by the Telephone Company.

**INTEROFFICE CHANNEL** - That element of a private line service which interconnects Local Channels which serve customers located in different central office areas (wire center serving areas).

**LIFELINE ASSISTANCE** - A program sponsored by the Federal Communications Commission which provides reduction in the price of basic local residential exchange access service to qualifying low-income subscribers.

**LINK-UP FLORIDA** - A state-approved, FCC authorized assistance program which provides a specific credit to and a deferred payment schedule of the nonrecurring charges for the establishment of service to qualified residence customers.

**LISTING** - The publication in the Company's directory and/or directory assistance records of information relative to a subscriber's telephone number, by which telephone users are able to ascertain the call number of a desired station.

## GENERAL EXCHANGE TARIFF

Embarq Florida, Inc.

By: F. B. Poag  
Director

SECTION A1  
Second Revised Sheet 19  
Cancelling First Revised Sheet 19  
Effective: May 29, 1997

### EXPLANATION OF TERMS

**LOCAL CALLING AREA/LOCAL SERVICE AREA** - The area within which telephone service is furnished subscribers under a specific schedule of exchange rates and without long distance charges. A local service area may include one or more exchange service areas under extended area service arrangements.

**LOCAL CHANNEL** - The element of a private line service required for connecting customer premises to the serving wire center.

**LOCAL EXCHANGE SERVICE** - The general telephone service, provided under a specified schedule of rates, which allows a subscriber to originate and receive calls from his/her telephone line through facilities provided for local intercommunication to other telephone lines within a specified area without payment of toll charges. Local exchange service rates may or may not be based on usage, and generally include provisions for the local exchange access line and extended calling privileges to one or more exchange areas where applicable.

**LOCAL MEASURED SERVICE** - A classification of exchange service which may be charged on the basis of local usage, as determined by one or more of the following: 1) the number of calls, 2) the duration of the calls, 3) the distance of the calls, or 4) the time of day the calls are placed.

**LOCAL MESSAGE** - A communication between a calling telephone and any other telephone within the local service area of the calling telephone.

**LOCAL SERVICE AREA/LOCAL CALLING AREA** - The area within which telephone service is furnished subscribers under a specific schedule of exchange rates and without long distances charges. A local service area may include one or more exchange service areas under extended area service arrangements.

GENERAL EXCHANGE TARIFF

Embarq Florida, Inc.

By: F. B. Poag  
Director

SECTION A1  
First Revised Sheet 20  
Cancelling Original Sheet 20  
Effective: January 1, 1997

EXPLANATION OF TERMS

**LONG DISTANCE MESSAGE TELECOMMUNICATIONS SERVICE** - The furnishing of facilities for customers' telephone communications on an individual message basis between the rates centers or, in connection with toll stations, within the same rate center. The toll service charges specified are in payment for all service furnished between the calling and called telephones.

**LONG DISTANCE TERMINAL** - A subscriber's station used exclusively for toll service and directly connected with the Toll Switchboard.

**MAIN STATION LINE** - Any line (circuit) directly or indirectly connecting an exchange station with a central office. Exchange lines are subdivided into Central Office Lines, Main Station Lines, Extension Station Lines, Extension Lines, PBX station Lines, Centrex Station Lines and Tie Lines.

**MANUFACTURER DISCONTINUED** - Items of regulated equipment which are no longer manufactured. Existing stock items in this category may continue to be offered and provided until available stock is depleted.

**MESSAGE** - A communication between two telephone stations. Messages may be classified as local or toll.

**MESSAGE RATE SERVICE** - A classification of exchange service which is charged for on the basis of amount of use.

**MILEAGE** - A charge applying for the use of part or all of a circuit furnished by the Company in addition to the basic rate for service, including airline measurement, route measurement, etc.

**MISCELLANEOUS COMMON CARRIERS** - Communications Common Carriers, as defined in Part 21 of the FCC Rules, which are not engaged in the business of providing either a public landline message telephone service or public message telegraph service.

## GENERAL EXCHANGE TARIFF

Embarq Florida, Inc.

By: F. B. Poag  
Director

SECTION A1  
Second Revised Sheet 21  
Cancelling First Revised Sheet 21  
Effective: July 14, 2001

### EXPLANATION OF TERMS

**MOBILE TELEPHONE SERVICE** - A communication service through a land-radiotelephone base station and between a wire telephone and a mobile unit or between two mobile units.

**MOVE** - A change in the location on the same premises which does not involve a change in the class or grade of service, a change in the rate charged for service furnished, or a break in the continuity of the contract under which the service is furnished.

**N11 SERVICES** - Abbreviated three (3)-digit dialing codes which allow the caller to connect to a location in the local telephone network that otherwise would be accessible only through a seven (7)- or ten (10)-digit telephone number. The local telephone network must be preprogrammed to translate the three-digit code into the appropriate seven- or ten-digit telephone number and route the call accordingly. Among abbreviated dialing arrangements, "N11" codes are three-digit codes of which the first digit can be any digit other than 0 or 1, and the last two digits are both 1. 0 and 1 are unavailable because those digits are used for switching and routing. The following N11 codes have been designated by the FCC or by the telephone industry for the purpose listed below:

#### **N11 CODE**

#### **Purpose**

211	Allows access to community information and referral services. Designated by the FCC.
311	Allows access to non-emergency police and government services. Designated by the FCC.
411	Traditionally allows access to local directory assistance services of local telephone companies. Not designated by the FCC.
511	Allows access to traveler information services. Designated by the FCC.
611/811	Traditionally allows access to local telephone company repair and business offices. Not designated by the FCC.
711	Allows access to Telecommunications Relay Services (TRS) for individuals with hearing or speech disabilities. Designated by the FCC.
911	Federally mandated as the National Emergency Number and allows access to emergency services. Designated by the FCC and ordered by the United States Congress.
011/111	Not available. "0" and "1" are used for switching and routing purposes.

**NETWORK CONTROL SIGNALING** - The transmission of signals used in the telecommunications system which perform functions such as supervision (control, status, and charging signals), address signaling (dialing), calling and called number identification, audible tone signals (call progress signals indicating reorder or busy conditions, alerting, coin denominations, coin collect and coin return tones) to control the operation of switching machines in the telecommunications system.

**NETWORK CONTROL SIGNALING UNIT** - The terminal equipment furnished, installed and maintained by the Company for the provision of network control signaling.

**NETWORK INTERFACE** - That point on the premises of the customer at which provision is made for connection of other than telephone company provided facilities to exchange facilities provided by the Telephone Company.

**NONLISTED TELEPHONE NUMBER** - An exchange telephone number which, at the subscriber's request, is not listed in the directory but is carried in Directory Assistance Records.

GENERAL EXCHANGE TARIFF

Embarq Florida, Inc.

By: F. B. Poag  
Director

SECTION A1  
Second Revised Sheet 22  
Cancelling First Revised Sheet 22  
Effective: April 1, 1997

EXPLANATION OF TERMS

**NONPUBLISHED TELEPHONE NUMBER** - An exchange telephone number which, at the subscriber's request, is not listed in the directory and is not made available to the general public by the Company. The Company may decline to furnish the call number of such lines or may decline to complete connections with such lines unless the number is furnished by the calling party.

**NONRECURRING CHARGE** - A charge that does not occur again after it is once made.

**OTHER COMMON CARRIER** - A common carrier (when not engaged in the business of furnishing public switched network telephone services or of furnishing domestic private line voice or data service via terrestrial facilities), a Domestic or International Public Record Carrier, or a Domestic Satellite Carrier.

**PAY TELEPHONE SERVICE (PATS)** - A class of service furnished to individuals, firms or corporations which permits connection of a customer-provided instrument that is activated by the deposit of coins, cards, tokens, or the entry of a customer account number, to the lines of the Company.

**PAY STATION** - A telephone station equipped with a device for collecting money in payment of telephone messages and used in connection with pay telephone service.

**PERSON-TO-PERSON CALL** - A service whereby the person originating the call specifies to the telephone company operator a particular person to be reached, a particular mobile station to be reached through a Miscellaneous Common Carrier attendant, or a particular station, department, or office to be reached through a PBX attendant.

GENERAL EXCHANGE TARIFF

Embarq Florida, Inc.

By: F. B. Poag  
Director

SECTION A1  
First Revised Sheet 23  
Cancelling Original Sheet 23  
Effective: January 1, 1997

EXPLANATION OF TERMS

**PORT** - Denotes the point of access into a computer, a network, or other electronic devices.

**PREMISES (same)** - The term "Same Premises" (except in connection with inside moves) shall be interpreted to mean:

- (a) the building or buildings, together with the surrounding land occupied or used in the conduct of one establishment or business, or as a residence, and not intersected by a public thoroughfare or by property occupied by others; or
- (b) the portion of the building occupied by the customer, either in the conduct of his/her business or as a residence, and not intersected by a public corridor or by space occupied by others; or
- (c) the building or portion of a building occupied by the customer in the conduct of his/her business and as a residence provided both the business and residence bear the same street address; or
- (d) the continuous property operated as a single farm not intersected by a public thoroughfare.

In connection with inside moves, the term "Same Premises" is to be interpreted to mean the building or portion of a building occupied as a unit by the customer in the conduct of his/her business or residence, or a combination thereof, and not intersected by a public thoroughfare, a corridor or space occupied by others.

## GENERAL EXCHANGE TARIFF

Embarq Florida, Inc.

By: F. B. Poag  
Director

SECTION A1  
First Revised Sheet 24  
Cancelling Original Sheet 24  
Effective: January 1, 1997

### EXPLANATION OF TERMS

**PRIMARY CLASS OF SERVICE** - Any of those classes of service which the Company undertakes to furnish at any point within a specific exchange at a rate common to all applicants for the same class located in the same area.

**PRIMARY LOCATION** - The continuous property designated by the customer as the primary location and at which the attendant's position is located.

**PRINCIPAL LOCATION** - The premises of the customer at which the largest number of main stations are located.

**PRIVATE BRANCH EXCHANGE (PBX) TRUNK** - A central office line (circuit) connecting a customer-provided PBX system with a central office.

**PRIVATE LINE** - A circuit provided to furnish communication only between two or more terminals directly connected to it and not having connection with either central office or private branch exchange switching apparatus.

**PRIVATE LINE NETWORK** - Two or more private line units of the same type contracted for by one customer and reaching one or more common service points. The lines may be operated separately or they may be connected or connectable by means of a switching arrangement.

**PRIVATE LINE SERVICE** - The channels or the channels and equipment furnished to a customer for communication between specified locations.

**PROTECTIVE CONNECTING ARRANGEMENT** - Equipment provided for electrical protection when facilities provided by other than the Company are connected with facilities provided by the Company.



## GENERAL EXCHANGE TARIFF

Embarq Florida, Inc.

By: F. B. Poag  
Director

SECTION A1  
Third Revised Sheet 25  
Cancelling Second Revised Sheet 25  
Effective: November 27, 1998

### EXPLANATION OF TERMS

**PAY TELEPHONE** - An appropriate equipped piece of customer premises equipment (CPE) installed at a location chosen or accepted as suitable and for furnishing services to the general public for a fee.

**RATE CENTER** - A specified geographical location within an exchange area from which mileage measurements are determined for the application of rates between exchange areas.

**REFERENCE LISTING** - The listing of a generally accepted name of a firm or corporation followed by a reference to another listing.

**REGISTERED PROTECTIVE CIRCUITRY** - Separate, identifiable, and discrete electrical circuitry designed to protect the telephone network from harm, and registered in accordance with Part 68 of the FCC Rules and Regulations.

**REGISTERED TERMINAL EQUIPMENT** - Terminal equipment which is registered in accordance with Part 68 of the FCC Rules and Regulations.

**REMOTE MODULES AND/OR REMOTE SYSTEMS** - Denotes small end offices which obtain their call processing capability from a Host Office. When a Remote Module (RM) or a Remote System (RS) has its own NXX, the RM or RS will be considered the central office or wire center for private line rating purposes. When an RM or RS shares the NXX of the Host Office, the Host Office will be considered the central office or wire center for rating purposes.

**RESTORATION CHARGE** - A charge made for restoring service after service has been suspended (temporarily interrupted) at the request of the subscriber or by the Company for violation of tariff regulations by the subscriber.

GENERAL EXCHANGE TARIFF

Embarq Florida, Inc.

By: F. B. Poag  
Director

SECTION A1  
First Revised Sheet 26  
Cancelling Original Sheet 26  
Effective: January 1, 1997

EXPLANATION OF TERMS

**ROTARY LINE SERVICE** - A service arrangement which allows calls made to a busy number to be completed to another idle line in that rotary number group.

**ROUTE MEASUREMENT** - The actual length of a circuit between two points.

**SAME CUSTOMER** - In order for different services to be considered as furnished to the "same customer", such services must be billed in the same name. The business and residence service of a customer qualify as being furnished to the "same customer" even though the business service is furnished in other than his/her own name.

**SECRETARIAL LINES** - Extension station or main station lines of patrons of a telephone answering bureau which terminate in telephone answering facilities on the premises of the bureau so as to permit the bureau attendant to answer incoming calls on such lines.

**SERVICE CONNECTION CHARGE** - A nonrecurring charge applying to the establishment of basic telephone service for a subscriber and certain subsequent additions to that service.

**SERVICE LINES** - A two-way business individual line, a dial PBX main station, or an extension of any of the before mentioned, which is required for testing of certain services provided by the Company and which is to be billed at the existing tariff rate.

**SERVICE POINT** - When used in connection with customer-provided communication channels, this term denotes the point on the customer's premises where such channels or facilities are terminated in switching equipment used for communications with stations or customer-provided terminal equipment located on the premises.

## GENERAL EXCHANGE TARIFF

Embarq Florida, Inc.

By: F. B. Poag  
Director

SECTION A1  
First Revised Sheet 27  
Cancelling Original Sheet 27  
Effective: January 1, 1997

### EXPLANATION OF TERMS

**SERVING CENTRAL OFFICE** - The central office from which a customer or authorized user would normally be served for local exchange telephone service.

**SHARED TENANT PROVIDER** - One who has been granted a certificate of public convenience and necessity by the Florida Public Service Commission to provide Shared Tenant Services in accordance with Chapter 86-270 Laws of Florida (or Section 364.339 Florida Statutes (Supp. 1986)).

**SHARED TENANT SERVICE** - A class of resold local exchange service furnished through a common switching or billing arrangement to commercial or residential tenants within a single building by a provider other than an existing local exchange telephone company.

**STATION** - The equipment located at the customer's premises at which the line facilities terminate to provide exchange, long distance and other communications services.

In connection with private line services, a station consists of the transmitting or receiving equipment, or combination transmitting and receiving equipment, at any location on a premises and connected for private line service; or, where the service involves only channels, a station is any point on a premises at which a channel is terminated.

In connection with private line channels, a station is any point on the premises of a customer or authorized user at which a private line channel is terminated.

In connection with program transmission channels, a station includes points designated by a customer on premises other than those of the customer or an authorized user at which material is transmitted to or received from a program transmission channel. A point of connection or interexchange and local channels is not considered to be station.

GENERAL EXCHANGE TARIFF

Embarq Florida, Inc.

By: F. B. Poag  
Director

SECTION A1  
First Revised Sheet 28  
Cancelling Original Sheet 28  
Effective: January 1, 1997

EXPLANATION OF TERMS

**STATION ARRANGEMENT** - The Company-provided equipment which is necessary to condition the signals from CPE to insure that such signals are acceptable for transmission over 150 baud private line channels.

**STATION CONNECTION** - Amplifying equipment and service including special supervision which may be required when a station transmits a program to or receives a program from an interexchange network.

**STATION TERMINATION** - The connection to the exchange access line through a standard plug, jack, or equivalent.

**STATION-TO-STATION CALL** - A service whereby the person originating the call either dials the telephone number desired or gives to the telephone company operator the telephone number of the desired telephone, Miscellaneous Common Carrier connecting circuit, PBX or PBX station which is reached directly rather than through a PBX attendant, or gives only the name and address under which such number is listed and does not specify a particular person to be reached, nor a particular mobile station to be reached through a Miscellaneous Common Carrier attendant, nor a particular station, department or office to be reached through a PBX attendant.

**SUBSCRIBER OF RECORD/CUSTOMER OF RECORD** - A person, firm, partnership, corporation, municipality, cooperative organization or government agency which orders and is responsible for paying the telephone bill for any form of exchange service furnished by the Company. A subscriber may also be the agent for multi subscribers when the exchange service is for residential individual line service and the service will be used by multi owners of the individual residential apartment, the individual residential condominium unit apartment or the single-occupancy residential house.

GENERAL EXCHANGE TARIFF

Embarq Florida, Inc.

By: F. B. Poag  
Director

SECTION A1  
First Revised Sheet 29  
Cancelling Original Sheet 29  
Effective: January 1, 1997

EXPLANATION OF TERMS

**SUPPLEMENTAL CONTRACT** - A contract for service or facilities in addition to that provided for under the original contract.

**SUSPENSION OF SERVICE** - An arrangement made at the request of the subscriber, or initiated by the Company for violation of tariff regulations by the subscriber, for temporary interruption of service without terminating the service agreement. Although the service is rendered inoperable, the facilities are reserved in anticipation that normal service will be resumed at some future date.

**TELECOMMUNICATIONS SERVICES** - The services offered by the Company as specified in this General Exchange Tariff.

**TELECOMMUNICATIONS SERVICE PRIORITY (TSP) SYSTEM** - A service developed by the National Communications System (NCS) of the Federal Government which provides the regulatory, administrative and operational procedures authorizing the priority installation and/or priority restoration of National Security Emergency Preparedness (NSEP) telecommunications services.

**TELEPHONE ANSWERING SERVICE** - A service provided by other than the local exchange company for the purpose of answering customer telephone lines at a central location, either as a primary line or an extension of a primary line, when the customer is absent or does not desire to answer calls personally.

**TELEPHONE NETWORK INTERFACE (TNI) DEVICE** - A device installed by the Company on the customer's premises that establishes a point of demarcation between network facilities provided by the Company for connection to facilities provided by other than the Company. See DEMARCATION POINT.

## GENERAL EXCHANGE TARIFF

Embarq Florida, Inc.

By: F. B. Poag  
Director

SECTION A1  
Third Revised Sheet 30  
Cancelling Second Revised Sheet 30  
Effective: March 1, 2001

### EXPLANATION OF TERMS

**TELEPHONE NUMBER** - A designation assigned to an access line, central office line, or PBX trunk for convenience in placing calls and for identification in the assessment of message charges, etc. Such designation usually consists of a seven-digit number comprised of a three-digit central office code (name or numeral) followed by a four-digit line number.

**TELEPHONE OR TELECOMMUNICATIONS NETWORK** - The local telephone exchange and long distance message telecommunications facilities or network, for both interstate and intrastate.

**TEMPORARY SERVICE** - Private line service furnished for a period of less than one month.

**TERMINATION CHARGE** - A charge applying when a subscriber discontinues an item of service prior to the expiration of the initial service period designated for such item. The basic termination charge is an amount established for an individual item of service from which the termination charge is computed.

**TERMINATION OF SERVICE** - An arrangement made at the request of the subscriber, or initiated by the Company for violation of tariff regulations by the subscriber, for permanent discontinuance of service.

**THIRD PARTY BLOCK SERVICE** - A service that blocks the placing of monthly recurring charges on customers' telephone bills by third party service providers.

**TIE LINES** - A circuit connecting two switching systems, either PBX and/or ACD systems, for the purpose of inter-communicating between the stations connected with such switching systems.

**TIE LINE MILEAGE** - The measurement upon which the rate for tie lines is based in accordance with tariff provisions.

**TOLL BLOCKING** - A service that enables the customer, by means of Telephone Company operator identification, to restrict outgoing toll calls from station users and prohibits the charging of calls to the customer's telephone number(s) via alternate billing arrangements, such as third number or collect billing.

## GENERAL EXCHANGE TARIFF

Embarq Florida, Inc.

By: F. B. Poag  
Director

SECTION A1  
Third Revised Sheet 31  
Cancelling Second Revised Sheet 31  
Effective: March 1, 2003

### EXPLANATION OF TERMS

**TOLL FREE CALLING (TFC)** - Denotes a three-digit Numbering Plan Area (NPA) or Area Code that is specifically assigned by the telecommunications industry for use by Telecommunications Services Providers in the provision of telephone numbers that, unlike traditional telephone numbers and calls, when dialed are toll free to the originating caller. The specific codes assigned and used, or reserved for use, for this purpose are 800, 822, 833, 844, 855, 866, 877, and 888.

**TOLL MESSAGE** - A communication between two telephone stations, the called station being outside of the local service area of the station from which the message originates.

**TOLL SERVICE** - That part of the total telephone service rendered by the Company which is furnished between patrons in different rate centers in accordance with the rates and regulations specified in the Company's Toll Tariff.

**TOUCH-TONE CALLING SERVICE** - A classification of exchange service furnished from certain specified central offices whereby calls are originated through the use of pushbuttons in lieu of a rotary dial. Touch-Tone is included in the monthly exchange rates for Individual, Key, Centrex, Trunk and Pay Telephone Service lines.

**TRANSIENT** - One temporarily occupying the premises, with occupancy not to exceed nine (9) months.

**TRANSITIONAL LIFELINE ASSISTANCE** - A transitional program which provides a reduction of basic local telecommunication service for any Lifeline subscriber who no longer qualifies for Lifeline Assistance.

**TROUBLE LOCATION CHARGE** - The nonrecurring charge applicable in connection with a service difficulty, or acceptance testing of customer provided premises wiring, when it is determined that the difficulty was caused by or resulted from the use of CPE including intra-system wiring, protective circuitry, or communications systems connected to Company facilities and requiring a premises visit.

**UNAFFILIATED ENTITY** - One that controls less than 50% of another entities' stock.

GENERAL EXCHANGE TARIFF

Embarq Florida, Inc.

By: F. B. Poag  
Director

SECTION A1  
First Revised Sheet 32  
Cancelling Original Sheet 32  
Effective: January 1, 1997

EXPLANATION OF TERMS

**VOICE GRADE FACILITY** - A communications path typically used in the telecommunications industry for the transmission of the human voice and associated telephone signals within the frequency bandwidth of approximately 300 to 3000 Hertz between two points comprised of any form or configuration of physical plant capable of transmitting and receiving these frequencies.

**WEATHER ANNOUNCEMENT SERVICE** - An announcement service providing the means for telephone access by the general public to a brief announcement of current and forecasted weather conditions. The service is furnished by an electronic or electromechanical device and may be publicly advertised. The announcements may contain advertising messages.

**WIDE AREA TELECOMMUNICATIONS SERVICE (WATS)** - The furnishing of facilities for dial type telephone communication between a wide area service access line and access lines in specified service areas as prescribed in the tariff.

**WIRE CENTER** - A building or complex of buildings housing Company equipment necessary for the provision of switched or non-switched telephone service to customers in a defined geographical area within an exchange. The facility is identified with V&H coordinates and is assigned one or more NXX's for use in providing switched services to customers located in the specified geographical area. The company equipment located at a Wire Center may consist of switching equipment or non-switching equipment working with a distant host switch as well as equipment used to terminate dedicated non-switched services.



GENERAL EXCHANGE TARIFF

Embarq Florida, Inc.

SECTION A2

By: F.B. Poag  
Director

First Revised Contents Sheet 1  
Cancelling Original Contents Sheet 1  
Effective: January 1, 1997

GENERAL REGULATIONS

CONTENTS

A.	APPLICATION .....	1
B.	LIMITATIONS AND USE OF SERVICE .....	1
1.	Use of Subscriber's Service .....	1
2.	Establishment of Identity .....	3
3.	Customer Provided Terminal Equipment and Communications Systems .....	4
4.	Accessories Provided by the Subscriber.....	4
5.	Broadcast of Recordings of Telephone Conversations.....	4
6.	Recorded Public Announcements .....	5
7.	Limited Communication .....	6
8.	Transmitting Messages .....	6
9.	Unlawful Use of Service .....	6
10.	Refusal or Discontinuance of Service by Company .....	7
11.	Termination of Service.....	11
12.	Termination Liability.....	12
C.	ESTABLISHMENT AND FURNISHING OF SERVICE .....	13
1.	Obligation to Furnish Service .....	13
2.	Flat- and Message-Rate Service.....	14
3.	Application for Service.....	15
4.	Application of Rates for Business and Residence Service.....	17
5.	Transfer of Service Between Subscribers .....	21
6.	Initial Service Periods .....	22
7.	Floor Space and Electric Power at the Subscribers Premises.....	23
8.	Provision and Ownership of Equipment and Facilities .....	23
9.	Provision and Ownership of Telephone Numbers.....	24

GENERAL EXCHANGE TARIFF

Embarq Florida, Inc.

SECTION A2

By: F.B. Poag  
Director

Second Revised Contents Sheet 2  
Cancelling First Revised Contents Sheet 2  
Effective: April 1, 2005

GENERAL REGULATIONS

CONTENTS

C.	ESTABLISHMENT AND FURNISHING OF SERVICE (Cont'd)	
10.	Provision of Directories.....	24
11.	Maintenance and Repairs.....	26
12.	Company Facilities at Hazardous or Inaccessible Locations.....	26
13.	Work Performed Outside Regular Working Hours .....	26
14.	Suspension of Residence and Business Service (Vacation Service) .....	27
15.	Residence Service for Company Employees .....	29
16.	School and Library Discounts.....	29
D.	PAYMENT ARRANGEMENTS AND CREDIT ALLOWANCES .....	30
1.	Advance Payments.....	30
2.	Credit and Deposits for Applicants .....	30
3.	Payment for Service .....	36
4.	Allowance for Interruptions .....	39
5.	Provision for Certain Local Taxes and Fees .....	40
E.	TWO-TIER PAYMENT PLANS .....	40
1.	General .....	40
2.	Description of Plans.....	41
3.	Conditions of Plans.....	41

GENERAL EXCHANGE TARIFF

Embarq Florida, Inc.

SECTION A2

By: F.B. Poag  
Director

Third Revised Contents Sheet 3  
Cancelling Second Revised Contents Sheet 3  
Effective: May 3, 1999

GENERAL REGULATIONS

CONTENTS

F.	LIABILITY OF THE COMPANY .....	44
1.	Service Irregularities .....	44
2.	Use of Facilities of Other Connecting Carriers .....	44
3.	Indemnifying Agreement.....	45
4.	Liability Limitation .....	45
5.	Defacement of Premises .....	45
6.	Period for the Presentation of Claims.....	45
7.	Equipment in Explosive Atmosphere.....	46
8.	Year 2000 (Y2K).....	46
G.	CLASSIFICATION OF AREAS AS THE BASIS FOR FURNISHING TELEPHONE SERVICE .....	47
1.	General . . . . .	47
2.	Classification of Areas .....	47
H.	ANNOYANCE CALLS AND REQUESTS FOR TRACING CALLS (TRAP AND TRACE).....	48
1.	Types of Annoyance Calls.....	48
2.	Request Procedure to Trap and Trace.....	49
3.	Responsibility of the Telephone Company.....	50
4.	Responsibility of the Customer.....	51
5.	Results of Trap and Trace .....	52
6.	Rates and Charges.....	52
I.	TELECOMMUNICATIONS ACCESS SYSTEM ACT (TASA) OF 1991.....	53
J.	SPECIAL PROMOTIONS.....	54

## GENERAL EXCHANGE TARIFF

Embarq Florida, Inc.

BY: F. B. Poag  
Director

SECTION A2  
Second Revised Sheet 1  
Cancelling First Revised Sheet 1  
Effective: November 27, 1998

### GENERAL REGULATIONS

#### A. APPLICATION

The regulations specified herein are in addition to the rules and regulations of all communication services offered in this tariff and contained in other sections of the General Exchange Tariff. Additional regulations, where applicable, pertaining to specific service offerings are located in the various sections of this tariff.

#### B. LIMITATIONS AND USE OF SERVICE

##### 1. Use of Subscriber's Service

- a. Telephone facilities are furnished for the use of the subscriber, employees, agents, or representatives of the subscriber or members of the subscriber's domestic establishment except in connection with pay telephone service and except as the use of the service may be extended to the transient public. Transient public may include, but is not limited to, patrons of hotels, members of clubs, patients of hospitals, occupants of licensed Adult Congregate Living Facilities, nursing homes, continuing care facilities and retirement homes, students living in quarters furnished by schools, colleges or universities; to persons temporarily subleasing a subscriber's residential premises; to the transient public in connection with reservation service at airport terminals and other public places; to exhibitors at convention halls, to transient customers of time-share facilities, yacht basins, apartment hotels and composite data services; or, to clients of a certificated Shared Tenant Service operation as specified in Section A26 of this tariff. In addition, airports are permitted to extend local service to businesses located at the airport terminal and engaged in airport operations necessary for the proper functioning of the airport.

GENERAL EXCHANGE TARIFF

Embarq Florida, Inc.

BY: F. B. Poag  
Director

SECTION A2  
First Revised Sheet 2  
Cancelling Original Sheet 2  
Effective: January 1, 1997

GENERAL REGULATIONS

B. LIMITATIONS AND USE OF SERVICE (Cont'd)

1. Use of Subscriber's Service (Cont'd)

a. (Cont'd)

- 1) The transient public, for purposes of this tariff, is defined as one temporarily occupying the premises, with occupancy not to exceed nine (9) months.
- 2) The exception for Adult Congregate Living Facilities, nursing homes, continuing care facilities and retirement homes is appropriate when at least 75% of the occupants are over age 62, or totally or permanently disabled and the facility has one or more of the following licensed or certificated components:
  - a) Licensed as a nursing home pursuant to Chapter 400, Florida Statutes, or
  - b) Licensed as an Adult Congregate Living Facility pursuant to Chapter 400.404, Florida Statutes, or exempted as an ACLF pursuant to Section 400, Florida Statutes, or
  - c) Certificated as a continuing care facility pursuant to Chapter 651, Florida Statutes, or
  - d) If funded or insured by the United States Department of Housing and Urban Development (HUD) pursuant to the National Housing Act. 12 U.S. Code SS1701, programs designed to aid the elderly.

## GENERAL EXCHANGE TARIFF

Embarq Florida, Inc.

BY: F. B. Poag  
Director

SECTION A2  
First Revised Sheet 3  
Cancelling Original Sheet 3  
Effective: January 1, 1997

### GENERAL REGULATIONS

#### B. LIMITATIONS AND USE OF SERVICE (Cont'd)

##### 1. Use of Subscriber's Service (Cont'd)

###### a. (Cont'd)

3) Subscribers who desire to provide access arrangements for the exclusive use of inmates served within the confines of penal, correctional, or mental institutions shall do so under the regulations, rates and charges as set forth in Section A7 of this tariff for Coin Telephone Service.

b. Except as otherwise provided in this tariff, service furnished by the Company is intended only for communications in which the subscriber has a direct interest and shall not be used for any purpose for which a payment or other compensation shall be received from him from any other person, firm or corporation for such use, or in the collection, transmission, or delivery of any communication for others.

##### 2. Establishment of Identity

a. The calling party shall establish his/her identity in the course of any communications as often as may be necessary.

b. The calling party shall be solely responsible for establishing the identity of the person or station with whom connection is made at the called location.

GENERAL EXCHANGE TARIFF

Embarq Florida, Inc.

BY: F. B. Poag  
Director

SECTION A2  
First Revised Sheet 4  
Cancelling Original Sheet 4  
Effective: January 1, 1997

GENERAL REGULATIONS

B. LIMITATIONS AND USE OF SERVICE (Cont'd)

3. Customer-Provided Terminal Equipment and Communications Systems

Customer-provided terminal equipment may be used and customer-provided communications systems may be connected with the facilities furnished by the Company for telecommunications services as provided in Section A15 of this tariff.

4. Accessories Provided by the Subscriber

Accessories which aid a subscriber's convenience in his/her use of the facilities of the Company in the service for which they are furnished under this tariff are permissible provided any such accessory so used would not endanger the safety of Company employees or the public; manage, require change in or alteration of, or involve direct electrical connection to the equipment or other facilities of the Company; or interfere with the proper function of such equipment or facilities; or impair the operation of the telecommunications system or otherwise injure the public in its use of the Company's services.

5. Broadcast of Recordings of Telephone Conversations

The broadcasting of a recording of a telephone conversation during the period of recording is permissible provided that the interest of protecting the privacy of telephone service, the recording is made in accordance with the provisions set forth in Section A15 of this tariff.

GENERAL EXCHANGE TARIFF

Embarq Florida, Inc.

BY: F. B. Poag  
Director

SECTION A2  
First Revised Sheet 5  
Cancelling Original Sheet 5  
Effective: January 1, 1997

GENERAL REGULATIONS

B. LIMITATIONS AND USE OF SERVICE (Cont'd)

6. Recorded Public Announcements

- a. Use of Company facilities or service in connection with automatic announcement service, automatic answering and recording service, recorder-coupler service, or miscellaneous devices for recorded public announcements are subject to the following conditions:
  - 1) For purposes of identification, subscribers to telephone service who transmit recorded public announcements over facilities provided by the Company must include in the recorded message the name of the organization or individual responsible for the service and the address at which the service is provided.
  - 2) Subscribers transmitting factual public announcements such as time, stock market quotations, airline schedules, and similar information are excluded from the preceding condition.
  - 3) Nonpublished telephone numbers will not be furnished for use with recorded public announcements.
  - 4) Failure to comply with the provisions of this tariff shall be cause for termination of the service.



GENERAL EXCHANGE TARIFF

Embarq Florida, Inc.

BY: F. B. Poag  
Director

SECTION A2  
First Revised Sheet 6  
Cancelling Original Sheet 6  
Effective: January 1, 1997

GENERAL REGULATIONS

B. LIMITATIONS AND USE OF SERVICE (Cont'd)

7. Limited Communication

The Company reserves the right to limit the length of communication when necessary because of a shortage of facilities caused by emergency conditions. In addition, when deemed necessary by the Company to prevent degradation of its general telephone service, arrangements which are designed to limit the volume of calls directed beyond a central office in which such calls originate may be used by the Company. The Company will incur no liability for not forwarding such calls.

8. Transmitting Messages

The Company will not transmit messages, but offers the use of its facilities when available, and will not be liable for errors in transmission or for failure to establish connections. Employees of the Company are forbidden to accept oral or written messages to be transmitted over the facilities of the Company.

9. Unlawful Use of Service

The service is furnished subject to the condition that it will not be used for an unlawful purpose. Service will be discontinued if any law enforcement agency, acting within its apparent jurisdiction, advises in writing that such service is being used in violation of law. The Company will refuse to furnish service when it has reasonable grounds to believe that such service will be used in violation of law.

GENERAL EXCHANGE TARIFF

Embarq Florida, Inc.

BY: F. B. Poag  
Director

SECTION A2  
First Revised Sheet 7  
Cancelling Original Sheet 7  
Effective: January 1, 1997

GENERAL REGULATIONS

B. LIMITATIONS AND USE OF SERVICE (Cont'd)

10. Refusal or Discontinuance of Service by Company

- a. As applicable, the Company may refuse or discontinue telephone service under the following conditions provided that, unless otherwise stated, the customer shall be given notice and allowed a reasonable time to comply with any rule or remedy any deficiency:
  - 1) For non-compliance with and/or violation of any State or municipal law, ordinance or regulation pertaining to telephone service.
  - 2) For the use of telephone service for any other property or purpose than that described in the application.
  - 3) For failure or refusal to provide the Company with a deposit to insure payment of bills in accordance with the Company's regulations.
  - 4) For neglect or refusal to provide reasonable access to the Company for the purpose of inspection and maintenance of equipment owned by the Company.
  - 5) For non-compliance with and/or violation of the Commission's regulations or the Company's rules and regulations on file with the Commission, provided five (5) working days' written notice is given before termination.

GENERAL EXCHANGE TARIFF

Embarq Florida, Inc.

BY: F. B. Poag  
Director

SECTION A2  
First Revised Sheet 8  
Cancelling Original Sheet 8  
Effective: January 1, 1997

GENERAL REGULATIONS

B. LIMITATIONS AND USE OF SERVICE (Cont'd)

10. Refusal or Discontinuance of Service by Company (Cont'd)

a. (Cont'd)

- 6) For non-payment of bills for telephone service, including the Telecommunications Access System surcharge, provided that suspension or termination of service shall not be made without five (5) working days' written notice to the customer, except in extreme cases. The written notice shall be separate and apart from the regular monthly bill for service. The Company shall not, however, refuse or discontinue service for nonpayment of a dishonored check service charge imposed by the Company.
- 7) For purposes of paragraphs 5) and 6), "working day" means any day on which the Company's business office is open and the U.S. Mail is delivered.
- 8) Without notice in the event of customer use of equipment in such manner as to adversely affect the Company's equipment or the Company's service to others.
- 9) Without notice in the event of tampering with the equipment furnished and owned by the Company.

GENERAL EXCHANGE TARIFF

Embarq Florida, Inc.

BY: F. B. Poag  
Director

SECTION A2  
First Revised Sheet 9  
Cancelling Original Sheet 9  
Effective: January 1, 1997

GENERAL REGULATIONS

B. LIMITATIONS AND USE OF SERVICE (Cont'd)

10. Refusal or Discontinuance of Service by Company (Cont'd)

a. (Cont'd)

10) Without notice in the event of unauthorized or fraudulent use of service. Whenever service is discontinued for fraudulent use of service, the Company may, before restoring service, require the customer to make, at his own expense, all changes in facilities or equipment necessary to eliminate illegal use and to pay an amount reasonably estimated as the loss in revenues resulting from such fraudulent use.

b. In case of refusal to establish service, or whenever service is discontinued, the Company shall notify the applicant or customer in writing of the reason for such refusal or discontinuance.

c. Service shall be initiated or restored when cause for refusal or discontinuance has been satisfactorily adjusted.

d. The following shall not constitute sufficient cause for refusal of service to an applicant or customer:

1) Delinquency in payment for service by a previous occupant of the premises, unless the current applicant or customer occupied the premises at the time the delinquency occurred and the previous customer continues to occupy the premises and such previous occupant shall benefit from such new service.

GENERAL EXCHANGE TARIFF

Embarq Florida, Inc.

BY: F. B. Poag  
Director

SECTION A2  
Second Revised Sheet 10  
Cancelling First Revised Sheet 10  
Effective: April 1, 1998

GENERAL REGULATIONS

B. LIMITATIONS AND USE OF SERVICE (Cont'd)

10. Refusal or Discontinuance of Service by Company (Cont'd)

d. (Cont'd)

- 2) Delinquency in payment for service by a present occupant who was delinquent at another address and subsequently joined the household of the subscriber in good standing.
- 3) Delinquency in payment for separate telephone service of another subscriber in the same residence.
- 4) Failure to pay for business service at a different location and a different telephone number shall not constitute sufficient cause for refusal of residence service or vice versa.
- 5) Failure to pay for a service rendered by the Company which is not regulated by the Commission.
- 6) Failure to pay the bill of another customer as guarantor thereof.
- 7) Failure to pay a dishonored check service charge imposed by the Company.
- 8) Lifeline subscribers will not be disconnected for non-payment of toll charges.

- e. When service has been discontinued for proper cause, the Company may charge a reasonable fee to defray the cost of restoring service as provided in Section A4 of this tariff.

GENERAL EXCHANGE TARIFF

Embarq Florida, Inc.

BY: F. B. Poag  
Director

SECTION A2  
First Revised Sheet 11  
Cancelling Original Sheet 11  
Effective: January 1, 1997

GENERAL REGULATIONS

B. LIMITATIONS AND USE OF SERVICE (Cont'd)

10. Refusal or Discontinuance of Service by Company (Cont'd)

- f. The Company may refuse to furnish or continue to furnish service, if such service would be used or is used for a purpose other than that for which it is provided; or when its use interferes with or impairs, or would interfere with or impair, any other services rendered to the public by the Company.
- g. The Company reserves the right to cancel any contract for service with and to discontinue service to any person who uses or permits the use of obscene, profane, or grossly abusive language over or by means of the Company's facilities, and who, after reasonable notice fails, neglects, or refuses to cease and refrain from such practice or to prevent the same; and to remove its property from the premises of such person.

11. Termination of Service

a. Termination by the Company

Violation of the regulations contained in this tariff on the part of the subscriber may be regarded as sufficient cause for termination of the subscriber's service. The subscriber shall be responsible for the payment of all charges due. This includes all charges due for the period service has been rendered plus any unexpired portion of an initial service period or applicable terminations charges, or both.

## GENERAL EXCHANGE TARIFF

Embarq Florida, Inc.

BY: F. B. Poag  
Director

SECTION A2  
First Revised Sheet 12  
Cancelling Original Sheet 12  
Effective: January 1, 1997

### GENERAL REGULATIONS

#### B. LIMITATIONS AND USE OF SERVICE (Cont'd)

##### 11. Termination of Service (Cont'd)

###### b. Termination of Service at the Subscriber's Request

Service may be terminated at any time upon reasonable notice from the subscriber to the Company. Upon such termination, the subscriber shall be responsible for the payment of all charges due. This includes all charges due for the prior service has been rendered plus any unexpired portion of an initial service period or applicable termination charges, or both.

##### 12. Termination Liability

###### a. Unless noted in specific sections of this tariff, the following termination liabilities will apply:

- 1) Termination liability may not carry over from one system to a new system, but must be paid in full before the new system or equipment is installed.
- 2) Periods for which a system has been temporarily suspended by the customer, or suspended by the Company for non-payment will not be credited to the determination of the termination liability.
- 3) Service may be terminated after expiration of the initial contract period upon proper notification to the Company and payment of all charges due up to the date of termination of service.

GENERAL EXCHANGE TARIFF

Embarq Florida, Inc.

BY: F. B. Poag  
Director

SECTION A2  
First Revised Sheet 13  
Cancelling Original Sheet 13  
Effective: January 1, 1997

GENERAL REGULATIONS

B. LIMITATIONS AND USE OF SERVICE (Cont'd)

12. Termination Liability (Cont'd)

b. Calculation of Termination Liability

- 1) The customer will be liable for the total monthly rate which is to be paid over the contract period minus the recurring expenses associated with the service.
- 2) The total termination liability is calculated as follows:

Monthly rate minus monthly maintenance minus monthly Administration minus Other Taxes equals Monthly Liability. Monthly liability times the contract period (in months) equals the total termination liability to be prorated over the life of the contract.

C. ESTABLISHMENT AND FURNISHING OF SERVICE

1. Obligation to Furnish Service

- a. The Company's obligation to furnish service is dependent upon its ability to secure and retain, without unreasonable expense, suitable facilities and rights for the provision of such service.



GENERAL EXCHANGE TARIFF

Embarq Florida, Inc.

BY: F. B. Poag  
Director

SECTION A2  
First Revised Sheet 14  
Cancelling Original Sheet 14  
Effective: January 1, 1997

GENERAL REGULATIONS

C. ESTABLISHMENT AND FURNISHING OF SERVICE (Cont'd)

1. Obligation to Furnish Service (Cont'd)
  - b. The rates and charges quoted in this tariff provide for the furnishing of service and facilities where suitable facilities are available or when the construction of the necessary facilities does not involve excessive costs. When excessive costs are involved for the construction of facilities, charges for such construction will be determined in accordance with the regulations as set forth in Section A5, "Charges Applicable Under Special Conditions," except as otherwise specified.
2. Flat- and Message-Rate Service
  - a. When both flat- and message-rate service are offered in an exchange, an applicant may, at his/her option, select either type of service.
  - b. A combination of both flat- and message-rate service will not be furnished on the same premises to the same subscriber, or in the same room to the same subscriber, or to a group of different subscribers. This does not apply to:
    - 1) hotel and hospital premises where flat-rate service may be furnished for the exclusive use of the hotel or hospital management or may be contracted for separately by guests or patients, in addition to the message rate service ordinarily provided in guests' or patients' rooms and lobbies;

GENERAL EXCHANGE TARIFF

Embarq Florida, Inc.

BY: F. B. Poag  
Director

SECTION A2  
Second Revised Sheet 15  
Cancelling First Revised Sheet 15  
Effective: April 1, 1997

GENERAL REGULATIONS

C. ESTABLISHMENT AND FURNISHING OF SERVICE (Cont'd)

2. Flat- and Message-Rate Service (Cont'd)

b. (Cont'd)

- 2) premises where pay telephones may be properly located;
- 3) non-administrative lines connected to secretarial service facilities and not furnished with outward service;
- 4) the premises of a Shared Tenant Service client who requests direct service from the Company;
- 5) Opportunity 800 customers.

3. Application for Service

- a. Any applicant for service may be required to sign an application form requesting the Company to furnish the service in accordance with rates, charges, rules and regulations from time to time in force and effect.
- b. The Company reserves the right to refuse service to any applicant who is found to be indebted to the Company for service previously furnished until satisfactory arrangements have been made for the payment of all such indebtedness, except that conditions specified in B. of this section do not constitute sufficient cause for refusal of service to an applicant or customer.

GENERAL EXCHANGE TARIFF

Embarq Florida, Inc.

BY: F. B. Poag  
Director

SECTION A2  
First Revised Sheet 16  
Cancelling Original Sheet 16  
Effective: January 1, 1997

GENERAL REGULATIONS

C. ESTABLISHMENT AND FURNISHING OF SERVICE (Cont'd)

3. Application for Service (Cont'd)

b. (Cont'd)

The Company may also refuse to furnish service to any applicant desiring to establish service for former subscribers of the Company who are indebted for previous service, regardless of the listing requested for such service, until satisfactory arrangements have been made for the payment of such indebtedness.

c. If telephone service is established and it is subsequently determined that either condition in b. preceding exists, the Company may suspend or disconnect such service until satisfactory arrangements have been made for the payment of the prior indebtedness.

1) In case of refusal to establish service, or whenever service is discontinued, the Company shall notify the applicant or customer in writing of the reason for such refusal or discontinuance.

d. When an application for service and facilities or requests for additions, rearrangements, relocations, or modifications of service and equipment are canceled in whole or in part prior to completion of the work involved, the applicant is required to reimburse the Company for all expense incurred in handling the request before notice of cancellation is received. Such charge, however, is not to exceed all charges, which would apply if the work involved in complying with the request had been completed.

GENERAL EXCHANGE TARIFF

Embarq Florida, Inc.

BY: F. B. Poag  
Director

SECTION A2  
First Revised Sheet 17  
Cancelling Original Sheet 17  
Effective: January 1, 1997

GENERAL REGULATIONS

C. ESTABLISHMENT AND FURNISHING OF SERVICE (Cont'd)

3. Application for Service (Cont'd)

- e. When a subscriber requests a change in location of all or a part of the facilities covered by his/her application for service or requests for additions, rearrangements, modifications of his/her existing service and equipment prior to completion of the work involved, he/she may be required to pay the difference between the total costs and expenses incurred by the Company in completing the work involved and that which would have been incurred had the final location of the facilities been specified initially.

4. Application of Rates for Business and Residence Service

- a. In general, business rates apply at business locations and residence rates apply at residence locations. The determination as to whether subscriber service should be classified as business or residence is based on the following paragraphs.
- b. Business rates apply whenever the use of the service is primarily or substantially of a business, professional institutional or otherwise occupational nature or where the listing required is such as to indicate business use. Business rates apply for:
  - 1) Offices, stores, factories, mines, and all other places of a strictly business nature.

GENERAL EXCHANGE TARIFF

Embarq Florida, Inc.

BY: F. B. Poag  
Director

SECTION A2  
First Revised Sheet 17  
Cancelling Original Sheet 17  
Effective: January 1, 1997

GENERAL REGULATIONS

C. ESTABLISHMENT AND FURNISHING OF SERVICE (Cont'd)

4. Application of Rates for Business and Residence Service (Cont'd)

b. (Cont'd)

- 2) Boarding houses<sup>1</sup>, except as modified following, offices of hotels, halls or offices of apartment houses, colleges, quarters occupied by clubs and fraternal societies, except as modified following; public, private or parochial schools, hospitals, nursing homes, libraries, and other institutions and in churches.
- 3) Any location where a business designation is provided or when any title indicating a trade or profession is listed in the telephone directory or in other advertising, except as modified following.
- 4) Business rates will be applicable to access lines providing interconnection of Company facilities with amateur radio repeater stations if the repeater station is located on commercial property. Access lines for amateur radio repeater stations located on property used for residential purposes are subject to residence access line rates.

Note 1: For purposes of this tariff, a boarding house is defined as a house or apartment where rooms are rented or boarders taken or both. Such houses or apartments may obtain service at residence rates when in the judgment of the Company; they are not conducted primarily for business purposes and are listed as residences.

GENERAL EXCHANGE TARIFF

Embarq Florida, Inc.

BY: F. B. Poag  
Director

SECTION A2  
First Revised Sheet 19  
Cancelling Original Sheet 19  
Effective: January 1, 1997

GENERAL REGULATIONS

C. ESTABLISHMENT AND FURNISHING OF SERVICE (Cont'd)

4. Application of Rates for Business and Residence Service (Cont'd)

b. (Cont'd)

- 5) Service terminating solely on the secretarial facilities of a secretarial answering firm will carry business rates.

c. Residence rates apply for:

- 1) Private residences where a business listing in the telephone directory or business advertising is not utilized.
- 2) Private apartments in hotels, clubs, and boarding houses where service is confined to the domestic use of the subscriber and business listings are not employed.
- 3) The place of residence of a clergyman, physician, registered or practical nurse, midwife, dentist, veterinary surgeon, or other medical practitioner, provided the service is not installed in that portion of the subscriber's residence, which is used as an office, but is located in the subscriber's domestic establishment, and provided no business designation is employed. Titles such as "Doctor," "Reverend," "Judge," "Professor" are not considered business designations.
- 4) Private stable or garage when strictly a part of the subscriber's domestic establishment.
- 5) College fraternity houses where members of the fraternity lodge within the house.

## GENERAL EXCHANGE TARIFF

Embarq Florida, Inc.

BY: F. B. Poag  
Director

SECTION A2  
First Revised Sheet 20  
Cancelling Original Sheet 20  
Effective: January 1, 1997

### GENERAL REGULATIONS

#### C. ESTABLISHMENT AND FURNISHING OF SERVICE (Cont'd)

##### 4. Application of Rates for Business and Residence Service (Cont'd)

###### c. (Cont'd)

- 6) Secretarial line terminations of residence main service terminating as extension lines on the premises of a telephone answering bureau.
  - 7) Lines numbering six or fewer located at private residential locations will be billed residential rates. Lines in excess of six at private residential locations, if used primarily for domestic use, will be billed at residential rates. The residential rates as defined above will be applicable provided no business listing or directory advertising is requested.
- d. Changes from business service where a business directory listing is employed to residence service are made only in the event of a change in the subscriber's arrangements, which would entitle a subscriber to a residence classification of service. Ordinarily the subscriber's business number is to be changed and a new number assigned to the residence service without reference of calls.
  - e. Changes from residence to business service may be made without change in telephone number, if the subscriber so desires.
  - f. Where a subscriber requests facilities in excess of those which would normally be provided, applicable rates and charges, found in Section A5 of this tariff, will apply.

## GENERAL EXCHANGE TARIFF

Embarq Florida, Inc.

BY: F. B. Poag  
Director

SECTION A2  
First Revised Sheet 21  
Cancelling Original Sheet 21  
Effective: January 1, 1997

### GENERAL REGULATIONS

#### C. ESTABLISHMENT AND FURNISHING OF SERVICE (Cont'd)

##### 5. Transfer of Service Between Subscribers

- a. Service previously furnished one subscriber may be assumed by a new subscriber upon due notice of cancellation, or in case of abandonment, provided there is no lapse in service. Such transfers are subject to service connection charge regulations and may be arranged for in either of two ways:
  - 1) If the new subscriber, fully understanding the regulations governing the service and the status of the account, willingly assumes all obligations thereunder, future bills are then rendered without an adjustment to or from any particular date, with the Company arranging for the requested change in billing and directory listing. No final bill will be issued.
  - 2) If the new subscriber does not wish to assume payment of the old account, a new service application is taken and an adjustment in billing is made to and from the date the transfer is effective. A final bill is rendered for the old account and appropriate service connection charges apply for the new account.
- b. Under either method of transfer the reassignment of the old telephone number to the service of the new party is arranged for only after the former subscriber has given his consent to its use, and then only when, in the judgment of the Company, there exists no relationship, business or otherwise, between the old and new subscribers, and when in the judgment of the Company a change in the telephone number is not required.



GENERAL EXCHANGE TARIFF

Embarq Florida, Inc.

BY: F. B. Poag  
Director

SECTION A2  
First Revised Sheet 22  
Cancelling Original Sheet 22  
Effective: January 1, 1997

GENERAL REGULATIONS

C. ESTABLISHMENT AND FURNISHING OF SERVICE (Cont'd)

5. Transfer of Service Between Subscribers (Cont'd)

- c. When in the judgment of the Company a relationship does exist, business or otherwise, between the old and new subscribers, the reassignment of the old telephone number will not be permitted unless all charges due under the current account have been paid, and then only when in the judgment of the Company a change in the telephone number is not required.

6. Initial Service Periods

- a) Unless otherwise specified, the rate for all services offered in this tariff are monthly rates and the initial service period is for one month commencing with the date of installation of the service.
- b) The initial service period relates to each applicable unit of service, either on the initial or subsequent installations.
- c) For additional directory listings, the initial period is the life of the directory issue in which the listing appears. Where the additional listing does not appear in the directory, the initial period is one month.

GENERAL EXCHANGE TARIFF

Embarq Florida, Inc.

BY: F. B. Poag  
Director

SECTION A2  
First Revised Sheet 23  
Cancelling Original Sheet 23  
Effective: January 1, 1997

GENERAL REGULATIONS

C. ESTABLISHMENT AND FURNISHING OF SERVICE (Cont'd)

7. Floor Space and Electric Power at the Subscriber's Premises
  - a) The subscriber is responsible for the provision and maintenance, at his/her expense, of all suitable space and floor arrangements required on his/her premises for communication facilities provided by the Company in connection with services furnished to the subscriber by the Company. Suitable power outlets and commercial power required for the operation of such facilities shall be provided by, and at the expense of, the subscriber.
  - b) All operating procedures required for the use of communications facilities provided by the Company at the subscriber's premises will be performed at the expense of the subscriber, and must conform with the operating practices and procedures of the Company to maintain a proper standard of service.
  
8. Provision and Ownership of Equipment and Facilities
  - a) Equipment and facilities furnished by the Company on the premises of the subscriber or authorized user of the Company are the property of the Company and are provided upon the condition that such equipment and facilities, except as expressly provided in this tariff, must be installed, relocated, and maintained by the Company and that the Company's employees and agents may enter said premises at any reasonable hour to make collections from coin boxes, to install, inspect, or repair any part of the Company's equipment and facilities on the subscriber's premises, or upon termination or cancellation of the service, to remove such equipment, instruments, and lines.

GENERAL EXCHANGE TARIFF

Embarq Florida, Inc.

BY: F. B. Poag  
Director

SECTION A2  
First Revised Sheet 24  
Cancelling Original Sheet 24  
Effective: January 1, 1997

GENERAL REGULATIONS

C. ESTABLISHMENT AND FURNISHING OF SERVICE (Cont'd)

8. Provision and Ownership of Equipment and Facilities (Cont'd)
  - b) Subscribers may not disconnect or remove or permit others to disconnect or remove any apparatus installed by the Company, except upon the written consent of the Company.
  - c) Equipment and facilities furnished by the Company shall, upon termination of service from any cause whatsoever, be returned to it in good condition, reasonable wear and tear thereof expected.
9. Provision and Ownership of Telephone Numbers
  - a) Telephone numbers are the property of the Company and are assigned to the service furnished the subscriber. The subscriber has no property right to the telephone number or any other call number designation associated with services furnished by the Company, and no right to the continuance of service through any particular central office. The Company reserves the right to change such numbers, or the central office designations associated with such numbers, or both, assigned to the subscriber, whenever the Company deems it necessary to do so in the conduct of its business.
10. Provision of Directories
  - a) Customers shall receive one telephone directory for each access line or trunk in service. Subject to availability, additional directories shall be provided by the Company based on customer requests.

GENERAL EXCHANGE TARIFF

Embarq Florida, Inc.

BY: F. B. Poag  
Director

SECTION A2  
First Revised Sheet 25  
Cancelling Original Sheet 25  
Effective: January 1, 1997

GENERAL REGULATIONS

C. ESTABLISHMENT AND FURNISHING OF SERVICE (Cont'd)

10. Provision of Directories (Cont'd)

- b) Customer-Owned Pay Station subscribers shall be provided with the number of directories to meet their requirements at no charge.
- c) Volume requests which exceed the Company's ability to provide directories from its on-site supply may be referred to the directory publishing company for direct shipment.
- d) Every effort is made to make the directories as accurate as possible. The Company assumes no liability for damages arising from errors or omissions in making up or printing its directories. No liability, therefore, shall attach to the Company, except in cases of errors in charge listings where the liability of the Company shall be limited to a refund or credit at the monthly rate for such charge listing for the period during which the error or omission continues. The Company will not be a party to controversy arising between subscribers and others as a result of listings published in its directories.

## GENERAL EXCHANGE TARIFF

Embarq Florida, Inc.

BY: F. B. Poag  
Director

SECTION A2  
Second Revised Sheet 26  
Cancelling First Revised Sheet 26  
Effective: March 1, 2004

### GENERAL REGULATIONS

#### C. ESTABLISHMENT AND FURNISHING OF SERVICE (Cont'd)

##### 11. Maintenance and Repairs

All ordinary expense of maintenance and repairs, unless otherwise specified in this tariff, is borne by the Company. In case of damage, loss, theft, or destruction of any of the Company's property due to the negligence or willful act of the subscriber or other persons authorized to use the service, and not due to ordinary wear and tear or causes beyond the control of the subscriber, the subscriber shall be required to pay the expense incurred by the Company in connection with the replacement of the property damaged, lost, stolen, or destroyed, or the expense incurred in restoring it to its original condition.

##### 12. Company Facilities at Hazardous or Inaccessible Locations

Where service is to be established at a location that would involve undue hazards, or where accessibility is impracticable to employees of the Company, the subscriber may be required to install and maintain the Company's equipment and facilities in a manner satisfactory to the Company, any remuneration to be based on the conditions involved.

##### 13. Work Performed Outside Regular Working Hours

The rates and charges specified in this tariff contemplate that all work in connection with furnishing or rearranging service to be performed during regular working hours. Whenever a subscriber requests that work necessarily required in the furnishing or rearranging of his/her service be performed outside the Company's regular working hours or that work once begun be uninterrupted, so that the Company incurs costs that would not otherwise have been incurred, the subscriber may be required to pay, in addition to the other rates and charges specified in this tariff, the amount of additional costs incurred by the Company as a result of the subscriber's special requirements.

## GENERAL EXCHANGE TARIFF

Embarq Florida, Inc.

BY: F. B. Poag  
Director

SECTION A2  
Second Revised Sheet 27  
Cancelling First Revised Sheet 27  
Effective: March 1, 2004

### GENERAL REGULATIONS

#### C. ESTABLISHMENT AND FURNISHING OF SERVICE (Cont'd)

##### 14. Suspension of Business and Residence Service (Vacation Service)

###### a. General

- 1) Upon request, a subscriber to business or residence service may arrange for the temporary suspension of such service, except when subject to initial service periods.
- 2) The suspension of service is not allowed for periods of less than one month or for more than six months in any twelve month period.
- 3) Local or long distance service is not furnished during the period of suspension. At the request of the subscriber, inward calls to a station at which service is suspended may be referred to the call number of another station in the same or a distant exchange.
- 4) The charge for the total suspension period may be collected in advance.
- 5) There is no reduction in the charge for foreign central office line mileage, foreign exchange line mileage or for services that are tariffed as obsolete during the period of suspension.
- 6) No allowance is made in the charges for additional listings except when the service under the main contract is temporarily suspended.
- 7) Whenever the period of disconnection is less than the minimum period, the charge levied by the Company will not exceed the regular rate for the service. The minimum charge for any calendar year shall be three-fourths of the annual rate.
- 8) Suspension period limitations and minimum charges of 3/4 of the annual rate shall be waived for any emergency oriented organization, the primary mission of which is the preservation of life or property, and is government funded and the use of the service is limited to emergency situations. During non-emergency times, service shall be kept available on a standby basis except during testing by the subscriber. Restoration of Service charges shall apply when ending suspension or testing.

GENERAL EXCHANGE TARIFF

Embarq Florida, Inc.

BY: F. B. Poag  
Director

SECTION A2  
Second Revised Sheet 28  
Cancelling First Revised Sheet 28  
Effective: March 1, 2004

GENERAL REGULATIONS

C. ESTABLISHMENT AND FURNISHING OF SERVICE (Cont'd)

14. Suspension of Business and Residence Service (Vacation Service)

b. Application of Charges

- 1) The monthly charge for residence and business access line services will be billed at the following % of the tariff rate, excluding taxes and surcharges e.g. SLC, 911 and USF:

a)	Residence/Business Access Line only	50%
b)	Small Talk	72%
c)	Solutions Packages - Residence	
	Ideal Solution	14%
	Sure Solution II	16%
	Choice Solution	17%
	Standard Solution I	19%
	Standard Solution II	23%
	Basic Solution	15%
	Classic Solution	17%
	Core Solution	13%
	Clear Solution	13%
	Personal II Solution	13%
	Home II Solution	17%
	Safe and Sound II Solution	25%
d)	Solutions Packages - Business	
	Ideal Solution	22%
	Sure Solution II	27%
	Choice Solution	27%
	Standard Solution I	30%
	Standard Solution II	34%
	Basic Solution	23%
	Classic Solution	28%
	Priority Solution	30%
	Economy Solution	32%

- 2) Any other regulated recurring rates, e.g., features, listings, applicable on the same account during the suspension period will be billed at 0% of the tariff rate.

GENERAL EXCHANGE TARIFF

Embarq Florida, Inc.

BY: F. B. Poag  
Director

SECTION A2  
Fourth Revised Sheet 29  
Cancelling Third Revised Sheet 29  
Effective: April 1, 2005

GENERAL REGULATIONS

C. ESTABLISHMENT AND FURNISHING OF SERVICE (Cont'd)

14. Suspension of Business and Residence Service (Vacation Service)
  - b. Application of Charges
    - 3) Business Service - The following regulations shall also be observed in the Central Telephone exchanges of the Company:
      - a) Digital Centrex dormitory stations shall be exempt from the minimum 3/4 annual rate regulation.
      - b) Where a portion of a Digital Centrex System is suspended (administrative or dormitory service) and the suspension rate results in a monthly amount lower than the minimum monthly charge described in Section A12, no credit is allowed toward fulfilling the initial service period.
15. Residence Service for Company Employees
  - a. Employees of the Company will receive concessions as specified in the Company's Employee Concession Service Practice.
  - b. For retired employees of the Company, the retirement benefits as specified in the Employee Concession Service Practice will apply.
16. School and Library Discounts
  - a. General

The Universal Service Support Mechanism was established to ensure affordable telecommunications service to all Americans including low-income consumers and eligible schools and libraries. Public and private schools (grades Kindergarten - Twelve) and public libraries, may be eligible for discounts (Support) through the Schools and Libraries Universal Service Support Mechanism (E-Rate Program) in connection with the purchase of Company services and equipment (Service). In addition, these Customers may be eligible for state or local corollaries to the E-Rate Program.
  - b. Application for Support
    - 1) E-Rate Program

The Customer will abide by all E-Rate Program rules for receipt of Support. The Customer is responsible for applying to the Schools and Libraries Division (SLD) of the Universal Service Administrative Company (or other authorized E-Rate Program administrator) for Support from the E-Rate program each year the Customer is eligible for the Support. The Customer will notify the Company in writing within 30 days of its receipt of a Funding Commitment Decision Letter from the SLD along with a copy of the notice and other relevant documentation as requested by the Company.



## GENERAL EXCHANGE TARIFF

Embarq Florida, Inc.

BY: F. B. Poag  
Director

SECTION A2  
First Revised Sheet 29.1  
Cancelling Original Sheet 29.1  
Effective: April 1, 2005

### GENERAL REGULATIONS

#### C. ESTABLISHMENT AND FURNISHING OF SERVICE (Cont'd)

##### 16. School and Library Discounts (Cont'd)

##### b. Application for Support (Cont'd)

##### 2) Other Funding Sources

The Customer is responsible for applying for Support from state and/or local administrators (Funding Sources). The Customer will notify the Company in writing within 30 days of its receipt of a Support commitment from such Funding Sources and will include a copy of its application, Funding Source Support documentation, and other relevant documentation as requested by the Company.

##### c. Receipt of Support

##### 1) E-Rate Program

The Customer will pay, in full, all invoices issued by the Company prior to the Company's receipt of notification from the Funding Source acknowledging the Customer's receipt of Service. Upon notification, the Company will apply discounts to the Customer's invoices or reimburse the Customer according to the Funding Commitment Decision Letter. The Customer is responsible to apply for SLD reimbursement (instead of receiving discounted Company bills) for all eligible customer premise equipment rentals or other financed arrangements. The Company reserves the right to require the Customer to seek SLD reimbursement (instead of receiving discounted Company bills) if the Customer has not received its Funding Commitment Decision Letter from the SLD by December 31 of the funding year. All discounts or reimbursements will be retroactive to the date authorized by the SLD funding year. The Company will either apply a credit to the Customer's account or provide the Customer with a check corresponding to the appropriate amount of Support based on Service received.

##### 2) Other Funding Sources

The Customer will pay, in full, all invoices issued by the Company prior to the Company's receipt of notification from the Funding Source acknowledging the Customer's receipt of Service. Upon notification, The Company will apply discounts or reimburse the Customer for Service delivered corresponding to the Funding Source acknowledgement. These discounts or reimbursements will be retroactive to the date authorized by the Funding Source funding year. The Company may reimburse the Customer with a credit to the Customer's account or with a check corresponding to the appropriate amount of Support based on Service received.

GENERAL EXCHANGE TARIFF

Embarq Florida, Inc.

BY: F. B. Poag  
Director

SECTION A2  
First Revised Sheet 30  
Cancelling Original Sheet 30  
Effective: January 1, 1997

GENERAL REGULATIONS

D. PAYMENT ARRANGEMENTS AND CREDIT ALLOWANCES

1. Advance Payments

- a. An applicant for service or facilities may be required to pay in advance of installation an amount not to exceed applicable service connection, installation, or other recurring charges plus charges for one month of service. Where construction charges are applicable, the payment thereof may be required in advance of start of construction.
- b. The amount of the advance payment is credited to the customer's account on the first bill rendered under the contract.

2. Credit and Deposits for Applicants

- a. The Company may, in order to safeguard its interests, require an applicant to establish satisfactory credit, or pay a cash deposit, as set forth in the following:
  - 1) Credit will be deemed to be established if:
    - a) The applicant for service has been a customer of any telephone utility within the last two years and during the last twelve consecutive months of service did not have more than one occasion in which a bill was paid after becoming delinquent and never had service disconnected for nonpayment.

GENERAL EXCHANGE TARIFF

Embarq Florida, Inc.

BY: F. B. Poag  
Director

SECTION A2  
Second Revised Sheet 31  
Cancelling First Revised Sheet 31  
Effective: April 1, 1998

GENERAL REGULATIONS

D. PAYMENT ARRANGEMENTS AND CREDIT ALLOWANCES (Cont'd)

2. Credit and Deposits for Applicants (Cont'd)

a. (Cont'd)

1) Credit will be deemed to be established if: (Cont'd)

- b) The applicant for service furnishes a satisfactory guarantor to secure payment of bills for the service requested. A satisfactory guarantor shall, at a minimum, be a customer of the Company with a satisfactory payment record. A guarantor's liability shall be terminated when a residential customer whose payment of bills is secured by the guarantor meets the requirements in D.2.c.1). Guarantors providing security for payment of residential customers' bills shall only be liable for bills contracted at the service address contained in the contract of guaranty.
- c) The applicant pays a cash deposit.
- d) The applicant for service furnishes an irrevocable letter of credit from a bank or a surety bond.
- e) Lifeline subscribers, who voluntarily elect to receive Toll Blocking, are not required to pay a service deposit.

GENERAL EXCHANGE TARIFF

Embarq Florida, Inc.

BY: F. B. Poag  
Director

SECTION A2  
First Revised Sheet 32  
Cancelling Original Sheet 32  
Effective: January 1, 1997

GENERAL REGULATIONS

D. PAYMENT ARRANGEMENTS AND CREDIT ALLOWANCES (Cont'd)

2. Credit and Deposits for Applicants (Cont'd)

a. (Cont'd)

2) Amount of Deposit

The amount of the cash deposit shall not exceed an amount equal to the charges for one (1) month's local exchange service plus two (2) month's estimated toll service provided by or billed by the Company. If, after 90 days' service, the actual deposit is found to be greater than an amount equal to one (1) month's local service plus two (2) month's actual average toll service provided by or billed by the Company, the Company shall, upon demand of the subscriber to the Company, promptly refund the difference. These deposit rules apply to local exchange service and toll service provided by or billed by the Company only and do not apply to Special Arrangement Agreements covering termination equipment installations for which the Company may require a reasonable deposit.

b. New or Additional Deposits

The Company may require, upon reasonable written notice of not less than 15 days, a new deposit, where previously waived or returned, or an additional deposit, in order to secure payment of current bills. However, the total amount of the required deposit should not exceed twice the actual average monthly toll billing provided by or billed by the Company plus one (1) month's local service charge, for the 90 day period immediately prior to the date of notice.

## GENERAL EXCHANGE TARIFF

Embarq Florida, Inc.

BY: F. B. Poag  
Director

SECTION A2  
First Revised Sheet 33  
Cancelling Original Sheet 33  
Effective: January 1, 1997

### GENERAL REGULATIONS

#### D. PAYMENT ARRANGEMENTS AND CREDIT ALLOWANCES (Cont'd)

##### 2. Credit and Deposits for Applicants (Cont'd)

##### b. New or Additional Deposits (Cont'd)

In the event the customer has had service less than 90 days, then the Company shall base its new or additional deposit upon the actual average monthly billing available. When the Company has good reason to believe payment by a nonresidential customer is in jeopardy and toll usage provided by or billed by the Company is significantly above normal for that customer, the Company may request a new or additional deposit. If the deposit requested is not paid within 48 hours, the Company may discontinue service.

##### c. Refund of Deposits

- 1) After a customer has established a satisfactory payment record and has had continuous service for a period of 23 months, the Company shall refund the residential customer's deposits; and shall, at its option, either refund or pay the higher rate of interest D.2.d. for nonresidential deposits, providing that in the preceding 12 months the customer has not (a) made more than one late payment of a bill (after the expiration of 15 days from the date of mailing or delivery by the Company), (b) paid with a check refused by a bank, been disconnected for nonpayment, or (d), at any time used service in a fraudulent or unauthorized manner.
- 2) Upon termination of service, the deposit and accrued interest may be credited against the final account and balance, if any, shall be returned promptly to the customer, but in no event later than 45 days after service is discontinued.

## GENERAL EXCHANGE TARIFF

Embarq Florida, Inc.

BY: F. B. Poag  
Director

SECTION A2  
First Revised Sheet 34  
Cancelling Original Sheet 34  
Effective: January 1, 1997

### GENERAL REGULATIONS

#### D. PAYMENT ARRANGEMENTS AND CREDIT ALLOWANCES (Cont'd)

##### 2. Credit and Deposits for Applicants (Cont'd)

###### d. Interest on Deposit

All deposits held by the Company in excess of six months shall bear interest at the rate of 6% per annum. The Company shall pay an interest rate of seven percent per annum on deposits of nonresidential customers qualifying under D.2.c.1) when such deposits are not refunded after 23 months. The deposit interest shall be simple interest in all cases and settlement shall be made annually, either in cash or by credit on the current bill. No customer depositor shall be entitled to receive interest on his/her deposit until and unless a customer relationship and the deposit have been in existence for a continuous period of six months' then he/she shall be entitled to receive interest from the date of the commencement of the customer relationship and placement of the deposit. Nothing in the Commission rule prohibits the Company from refunding at any time a deposit with any accrued interest.

###### e. Record of Deposits

The Company shall keep records to show the name of each customer making the deposit; the premises occupied by the customer when the deposit was made; the date and amount of deposit; and each transaction concerning the deposit such as interest payments, interest credited, or similar transactions.

GENERAL EXCHANGE TARIFF

Embarq Florida, Inc.

BY: F. B. Poag  
Director

SECTION A2  
First Revised Sheet 35  
Cancelling Original Sheet 35  
Effective: January 1, 1997

GENERAL REGULATIONS

D. PAYMENT ARRANGEMENTS AND CREDIT ALLOWANCES (Cont'd)

2. Credit and Deposits for Applicants (Cont'd)

f. Receipt for Deposit

A nontransferable certificate of deposit shall be issued to each customer and means provided so that the customer may claim the deposit if the certificate is lost. The deposit receipt shall contain notice that after 90 days' service, the subscriber is entitled to refund of any deposit over and above an amount equal to one month's local service plus two months' average toll service provided by or billed by the Company.

g. Responsibility for Payment

The fact that a deposit has been made in no way relieves the applicant or subscriber from complying with the Company's regulations as to advance payments and the prompt payment of bills on presentation, or constitutes a waiver or modification of the regular practice of the Telephone company providing for the discontinuance of service for nonpayment of any sums due to the Company.

GENERAL EXCHANGE TARIFF

Embarq Florida, Inc.

BY: F. B. Poag  
Director

SECTION A2  
Second Revised Sheet 36  
Cancelling First Revised Sheet 36  
Effective: May 21, 1997

GENERAL REGULATIONS

D. PAYMENT ARRANGEMENTS AND CREDIT ALLOWANCES (Cont'd)

3. Payment for Service

a. The subscriber is responsible for payment of all appropriate charges for completed calls, services and equipment. All charges due by the subscriber are payable at the Company's business office or at any agency authorized to receive such payments. Any objection to billed charges should be promptly reported to the Company. Adjustments to customers' bills shall be made to the extent that records are available and/or circumstances exist which reasonably indicate that such charges are not in accordance with approved rates or that an adjustment may otherwise be appropriate. Where any undercharge in billing of a subscriber is the result of a Company mistake, the Company may not backbill in excess of twelve months. Where overbilling of a subscriber occurs, due either to company or subscriber error, no liability exists which will require the Company to pay any interest, dividend or other compensation on the amount overbilled.

1) A charge of \$25.00 or 5%, whichever is greater, will apply whenever a check or draft presented for payment for service is not accepted by the institution on which it is written.

b. The subscriber shall pay monthly in advance or on demand all charges for service and equipment and shall pay on demand all charges for long distance service. The subscriber is responsible for payment of all charges for services furnished the subscriber, including charges for services originated or charges accepted at the subscriber's station.

(1)



## GENERAL EXCHANGE TARIFF

Embarq Florida, Inc.

BY: F. B. Poag  
Director

SECTION A2  
Third Revised Sheet 37  
Cancelling Second Revised Sheet 37  
Effective: April 4, 2000

### GENERAL REGULATIONS

#### D. PAYMENT ARRANGEMENTS AND CREDIT ALLOWANCES (Cont'd)

##### 3. Payment for Service (Cont'd)

- c. Should service be suspended for nonpayment of charges, restoration of service will be made only as provided under "Restoration Charge" in Section A4 of this tariff. Non payment of the charge in D.3.a.1) will not constitute sufficient cause for interruption or cancellation of service.
  - 1) Residential customers whose telephone services have been temporarily denied for non-payment will continue to have access to 911 Service (outgoing service only). Service will be provided on a "where available" basis.
- d. When the service has been disconnected for nonpayment, the service agreement is considered to have been terminated. Re-establishment of service may be made only upon the execution of a new service agreement, which is subject to the provisions of this tariff, except as stated in the Lifeline Assistance Program in Section A3 of this tariff.
- e. At its discretion, the Company may restore or reestablish service which has been suspended or disconnected for nonpayment of charges, prior to payment of all charges due. Such restoration or reestablishment of service shall not be construed as a waiver of any rights to suspend or disconnect service for nonpayment of any such or other charges due and unpaid or for the violation of the provisions of this tariff; nor shall the failure to suspend or disconnect service for nonpayment of any past due account or accounts operate as a waiver or estoppel to suspend or disconnect service for nonpayment of such account or of any other past due account.

GENERAL EXCHANGE TARIFF

Embarq Florida, Inc.

BY: F. B. Poag  
Director

SECTION A2  
Sixth Revised Sheet 38  
Cancelling Fifth Revised Sheet 38  
Effective: October 24, 2003

GENERAL REGULATIONS

D. PAYMENT ARRANGEMENTS AND CREDIT ALLOWANCES (Cont'd)

3. Payment for Service (Cont'd)

- f. Bills for service shall not be considered delinquent prior to the expiration of 15 days from the date of mailing or delivery by the Company. However, the Company may demand immediate payment under the following circumstances:
  - 1) Where service is terminated or abandoned.
  - 2) Where toll service is two times greater than the subscriber's average usage as reflected on the monthly bills for the three months prior to the current bill or, in case of a new customer who has been receiving service for less than four months, where the toll service is twice the estimated monthly toll service.
  - 3) Where the Company has reason to believe that a business subscriber is about to go out of business or that bankruptcy is imminent for the subscriber.
  
- g. A Late Payment Charge of one and one-half percent (1½%) or \$4.00, whichever is greater, will be applied to each customer's bill when the previous month's bill has not been paid in full prior to the next billing date with the exception of charges that have been disputed by the customer. The 1.5% charge is applied to the total unpaid amount carried forward and is included in the total amount due on the current bill. If the amount is less than \$4.00, the \$4.00 minimum will be applied to the total amount due. This tariff shall apply to federal and state government pursuant to existing statutes applicable to those governmental entities.

GENERAL EXCHANGE TARIFF

Embarq Florida, Inc.

BY: F. B. Poag  
Director

SECTION A2  
First Revised Sheet 39  
Cancelling Original Sheet 39  
Effective: January 1, 1997

GENERAL REGULATIONS

D. PAYMENT ARRANGEMENTS AND CREDIT ALLOWANCES (Cont'd)

3. Payment for Service (Cont'd)

g. (Cont'd)

Effective January 1, 1992, county and municipal governments will be assessed a one percent (1%) Late Payment Charge in accordance with the provisions of the Florida Prompt Payment Act, Section 218.70-218.79, Florida Statutes.

4. Allowance for Interruptions

- a. When the use of service or facilities furnished by the Company is interrupted due to any cause other than the negligence or willful act of the subscriber or the failure of the facilities provided by the subscriber, a pro rata adjustment of the fixed monthly charges involved will be allowed, for the service and facilities rendered useless and inoperative by reason of the interruption during the time said interruption continues in excess of 24 hours from the time it is reported to or detected by the Company, except as otherwise specified in this tariff.
- b. The adjustment shall not be applicable for the time that the Company stands ready to repair the service and the subscriber does not provide access to the Company for such restoration work. For the purpose of administering this regulation, every month is considered to have 30 days.

GENERAL EXCHANGE TARIFF

Embarq Florida, Inc.

BY: F. B. Poag  
Director

SECTION A2  
First Revised Sheet 40  
Cancelling Original Sheet 40  
Effective: January 1, 1997

GENERAL REGULATIONS

D. PAYMENT ARRANGEMENTS AND CREDIT ALLOWANCES (Cont'd)

5. Provision for Certain Local Taxes and Fees

- a. When a municipality or political subdivision of the state charges the Company any license, occupational, franchise, inspection, or other similar tax or fee, whether in a lump sum, or at a flat-rate, or based on receipts, or based on poles, wires, conduits, or other facilities, subscribers receiving service within the municipality or political subdivision will be billed, insofar as practical, pro rata, the aggregate amount of such taxes and fees.
- b. Exchange subscribers shall pay as a separate charge on each customer bill a gross receipts tax adjustment in the form of a percentage to be added to their bill. This percentage shall reflect the customer's pro rata share of the amount the Company is required to pay to the State of Florida as a tax on gross receipts for the sale of telecommunications service, plus the appropriate franchise fees, regulatory assessment fees, and any other applicable taxes or fees resulting from such additional revenues.

E. TWO-TIER PAYMENT PLANS

1. General

Certain services and/or equipment may be furnished under either Plan 1 or Plan 2 as described following.

## GENERAL EXCHANGE TARIFF

Embarq Florida, Inc.

BY: F. B. Poag  
Director

SECTION A2  
First Revised Sheet 41  
Cancelling Original Sheet 41  
Effective: January 1, 1997

### GENERAL REGULATIONS

#### E. TWO-TIER PAYMENT PLANS (Cont'd)

##### 2. Description of Plans

- a. Plan 1 - embodies an extended initial service period with two-tier monthly rates for each component in the system. The first tier (Tier A) is a one-time payment or a recurring monthly rate applicable for the initial service period selected by the subscriber and is guaranteed against change. The second tier (Tier B) is a monthly rate applicable for the period the subscriber has the service and is subject to change.
- b. Plan 2 - embodies an installation charge, a single monthly rate for each component, and a minimum 30 days service period unless specified otherwise. The monthly rates apply for the period the subscriber has the service and are subject to change.

##### 3. Conditions of Plans

- a. Under Plan 1, except where the one-time payment option is selected, the monthly rate will consist of the sum of two segments, Tier A and Tier B, until the termination of the agreed-upon initial service period at which time the monthly rate will reduce to the Tier B rate. When the one-time payment option is selected for Tier A, the subsequent monthly rate will consist only of the Tier B rate.

## GENERAL EXCHANGE TARIFF

Embarq Florida, Inc.

BY: F. B. Poag  
Director

SECTION A2  
First Revised Sheet 42  
Cancelling Original Sheet 42  
Effective: January 1, 1997

### GENERAL REGULATIONS

#### E. TWO-TIER PAYMENT PLANS (Cont'd)

##### 3. Conditions of Plans (Cont'd)

###### a. (Cont'd)

- 1) The Company will provide complete maintenance service, including replacement of like components, for a period as specified for each service offered under the Two-Tier Payment Plans. At the expiration of this period, the company will provide maintenance service, but replacement of like components will be provided at supplemental charges subject to the availability of facilities.
- 2) In the event of termination of all or part of the service prior to expiration of the original Tier A initial service period, the subscriber will be required to pay any unpaid balance of the Tier A charges. At the subscriber's option, a lump sum payment will be computed by calculating the present worth of the remaining Tier A monthly payments at the annual effective interest rate used in determining the Tier A monthly rates. The Tier B rate will continue until the date the subscriber requests removal of the service. With prior written concurrence by the Company, the agreement may be transferred to a second party at the same location.
- 3) The Tier A portion of the monthly rate is not subject to change during the agreed-upon initial service period. The Tier B monthly rate is subject to changes.

GENERAL EXCHANGE TARIFF

Embarq Florida, Inc.

BY: F. B. Poag  
Director

SECTION A2  
First Revised Sheet 43  
Cancelling Original Sheet 43  
Effective: January 1, 1997

GENERAL REGULATIONS

E. TWO-TIER PAYMENT PLANS (Cont'd)

3. Conditions of Plans (Cont'd)

a. (Cont'd)

4) Additional services may be added to the existing system prior to the expiration of the original Tier A initial service period. Such services may be added in one of three ways. 1) The subscriber may enter into a new Tier A contract on that item of service for one of the available periods; 2) additional services may be added utilizing the Plan 2 rates; and 3) services may be added to the existing initial service contract by prepaying an amount equal to the months expired on the present contract times the monthly rate, thereby causing all of the Tier A contract to terminate at the same time.

b. Under Plan 2, the installation charges and monthly rates will be as filed for each item of service. The monthly rates will apply until the service is terminated and are subject to changes.

c. Charges for other service items, including service connections, moves, and changes, are as specified in other sections of this tariff.

d. Suspension of service (vacation rate) is not permitted for services provided under Two-Tier Payment Plans 1 or 2.

GENERAL EXCHANGE TARIFF

Embarq Florida, Inc.

BY: F. B. Poag  
Director

SECTION A2  
First Revised Sheet 44  
Cancelling Original Sheet 44  
Effective: January 1, 1997

GENERAL REGULATIONS

F. LIABILITY OF THE COMPANY

1. Service Irregularities

The liability of the Company for damages arising out of service provided to its subscribers such as defects or failures in facilities furnished by the Company or mistakes, omissions, preemptions, interruptions, delays, errors, or defects in the provision of its services as set forth herein or any portion of its services, occurring in the course of furnishing such facilities or services, and not caused by the negligence of the subscriber, or of the Company in failing to maintain proper standards of maintenance and operation and to exercise reasonable supervision shall, in no event, exceed an amount equivalent to the proportionate charge to the subscriber for the period of service during which such mistake, omission, interruption, delay, error or defect in transmission or defect or failure in facilities or services occurs.

2. Use of Facilities of Other Connecting Carriers

When suitable arrangements can be made, facilities of other connecting carriers may be used in conjunction with this Company's facilities in establishing connections to points not reached by this Company's facilities. Neither this Company nor any connecting carrier participating in a service shall be liable for any act or omission of any other company or companies furnishing a portion of such service.



GENERAL EXCHANGE TARIFF

Embarq Florida, Inc.

BY: F. B. Poag  
Director

SECTION A2  
Second Revised Sheet 45  
Cancelling First Revised Sheet 45  
Effective: May 3, 1999

GENERAL REGULATIONS

F. LIABILITY OF THE COMPANY (Cont'd)

3. Indemnifying Agreement

The Company shall be indemnified and saved harmless by the subscriber or subscribers against claims for libel, slander, or the infringement of copyrighting arising directly or indirectly from the material transmitted over the facilities or the use thereof; against claims for infringement of patents arising from combining with or using in connection with, facilities furnished by the Company, apparatus and systems of the subscriber; and against all other claims arising out of any act or omission of the subscriber in connection with the facilities provided by the Company.

4. Liability Limitation

The Telephone Company will not be liable for any consequential, incidental or indirect damages for any cause of action, whether in contract or tort. Consequential, incidental and indirect damages include, but are not limited to, lost projects, lost revenues and loss of business opportunity, whether or not the Telephone Company was aware or should have been aware of the possibility of these damages.

5. Defacement of Premises

The Company is not liable for any defacement of or damage to the premises of a subscriber resulting from the furnishing of service or the attachment of equipment or apparatus furnished by the Company on such premises or by the installation or removal thereof, when such defacement or damage is not the result of negligence of the employees of the Company.

6. Period for the Presentation of Claims

The Company shall not be liable for damages or statutory penalties in any case where a claim is not presented in writing within 60 days after alleged delinquency occurs.

## GENERAL EXCHANGE TARIFF

Embarq Florida, Inc.

BY: F. B. Poag  
Director

SECTION A2  
Second Revised Sheet 46  
Cancelling First Revised Sheet 46  
Effective: May 3, 1999

### GENERAL REGULATIONS

#### F. LIABILITY OF THE COMPANY (Cont'd)

##### 7. Equipment in Explosive Atmosphere

- a. The Company does not guarantee nor make any warranty with respect to equipment provided by it for use in an explosive atmosphere. The subscriber shall indemnify and hold the Company harmless from any and all loss, claims, demands, suits, or other action, or any liability whatsoever, whether suffered, made, instituted or asserted by the subscriber or by any other party or person, for any personal injury to or death of any person or persons, and for any loss, damage or destruction of any property, whether owned by the subscriber or others, caused or claimed to have been caused directly or indirectly by the installation, operation, failure to operate, maintenance, removal, presence, condition, location or use of said equipment so provided.
- b. The Company may require each subscriber to sign an agreement for the furnishing of such equipment as a condition precedent to the furnishing of such equipment.
- c. The subscriber shall furnish, install and maintain sealed conduit with explosion-proof fittings between this equipment and points outside the hazardous area where connection may be made with regular facilities of the Company. The subscriber may be required to install and maintain this equipment within the hazardous area if, in the opinion of the Company, injury or damage to Company employees or property might result from installation or maintenance by the Company.

##### 8. Year 2000 (Y2K)

The Company will make reasonable efforts to cure any material failure to provide service caused solely by year 2000 defects in the Company hardware, software or systems. Due to the interdependence among telecommunications providers and the interrelationship with non-Telephone Company processes, equipment and systems, the Company is not responsible for failures caused by circumstances beyond its control, including, but not limited to, failures caused by: 1) the Customer; 2) other telecommunications providers; or 3) customer premises equipment. In addition, the Company does not ensure compatibility between the Company and non-Telephone Company services used by the Customer.

## GENERAL EXCHANGE TARIFF

Embarq Florida, Inc.

BY: F. B. Poag  
Director

SECTION A2  
First Revised Sheet 47  
Cancelling Original Sheet 47  
Effective: January 1, 1997

### GENERAL REGULATIONS

#### G. CLASSIFICATION OF AREAS AS THE BASIS FOR FURNISHING TELEPHONE SERVICE

##### 1. General

Economical operation of the telephone business, to secure protection to the whole body of ratepayers and to the business itself, requires that the property be built and operated in accordance with a definite plan under which specified classes of service are regularly furnished in specified areas or types of areas. The Company therefore does not undertake to furnish any desired class of service at any desired location, nor does it undertake to extend its plant to remote sections where such extension is not warranted by the public necessity as distinguished from personal desire, except where adequate protection is afforded.

##### 2. Classification of Areas

- a. The general plan for furnishing telephone service is based upon Exchange Areas for the determination of the classes of service available and for the application of rates. An Exchange Area encompasses the territory served by a toll rate center and in which territory both local and long distance service is offered to the public.
- b. Generally, the Company will serve subscribers in general without the application of construction charges where the service to be furnished is of a permanent nature and dependent upon the availability of facilities.

## GENERAL EXCHANGE TARIFF

Embarq Florida, Inc.

BY: F. B. Poag  
Director

SECTION A2  
Third Revised Sheet 48  
Cancelling Second Revised Sheet 48  
Effective: May 12, 2000

### GENERAL REGULATIONS

#### G. CLASSIFICATION OF AREAS AS THE BASIS FOR FURNISHING TELEPHONE SERVICE

##### 2. Classification of Areas (Cont'd)

- c. Requests for service which are not in accordance with the general service plan, either because of class of service desired or due to the location, cannot be met under a fixed rate of charge. The general principle is that the Company undertakes to provide telephone service under conditions beyond the normal plan if the applicant will meet the special conditions imposed, as by payment of installation or construction charges, under an agreement based on the facts in the case and designed to protect the general body of rate payers by assessing unusual items of cost to those for whom the costs are incurred.
- d. The furnishing of telephone service is dependent upon the availability of facilities. Where no facilities exist, service may be subject to additional charges as specified in Section A5 of this tariff.
- e. The regulations outlined in Section A2.H do not apply in exchanges or central offices where "Call Tracing" capabilities are available as an ExpressTouch Feature reflected in Section A13.F of this Tariff.

#### H. ANNOYANCE CALLS AND REQUESTS FOR TRACING CALLS (TRAP AND TRACE)

##### 1. Types of Annoyance Calls

The most serious annoyance calls are the ones which are threatening in nature. Annoyance calls can generally be classified into one of the following four types:

- a. Threatening - These include threats of kidnapping, bodily harm, property damage, bomb threats, etc.

GENERAL EXCHANGE TARIFF

Embarq Florida, Inc.

BY: F. B. Poag  
Director

SECTION A2  
Second Revised Sheet 49  
Cancelling First Revised Sheet 49  
Effective: July 17, 1997

GENERAL REGULATIONS

H. ANNOYANCE CALLS AND REQUESTS FOR TRACING CALLS (TRAP AND TRACE) (Cont'd)

1. Types of Annoyance Calls (Cont'd)

b. Harassing - Harassing calls are usually one of the following types:

- 1) Ring and hang-up calls, or calls with heavy breathing without speaking.
- 2) False report calls where the caller represents himself as a member of the police force or hospital staff and informs the called party that a member of his family has had an accident.

c. Obscene - The call is considered obscene when a comment, request, suggestion, or prc is made which a reasonable person would consider indecent.

d. Interfering - These calls are made with the intent of hindering the called party in the use of his/her service, usually accomplished by the calling party not hanging up when the call is completed.

2. Request Procedure to Trap and Trace

a. A customer believing that he/she has received an abusive call will contact the Call Trace Bureau in his/her service area. The Company representative receiving the complaint will determine if the customer has received an abusive call or only a misdirected or sales solicitation call.

GENERAL EXCHANGE TARIFF

Embarq Florida, Inc.

BY: F. B. Poag  
Director

SECTION A2  
Second Revised Sheet 50  
Cancelling First Revised Sheet 50  
Effective: July 17, 1997

GENERAL REGULATIONS

H. ANNOYANCE CALLS AND REQUESTS FOR TRACING CALLS (TRAP AND TRACE) (Cont'd)

2. Request Procedure to Trap and Trace (Cont'd)

- b. If the review by the Company indicates that there are annoyance calls with regularity which appear to be a violation of the law, and if the annoyed customer has filed a complaint with the appropriate law enforcement agency or state attorney's office, the customer will be requested to sign an authorization permitting the Company to trace the annoyance calls and take whatever action might be necessary and appropriate to prevent the continuance of the calls.
- c. It is understood and the customer will be advised that not all abusive calls can be traced because of differences in central office equipment.

3. Responsibility of the Telephone Company

- a. The Company will not file a formal complaint concerning an annoyance call with a law enforcement agency or with a prosecutor. This is solely a matter between the customer receiving the call and the law enforcement agency. The Company is acting only as an intermediary between the customer and the law enforcement agency by providing information and assistance that might not otherwise be available.

GENERAL EXCHANGE TARIFF

Embarq Florida, Inc.

BY: F. B. Poag  
Director

SECTION A2  
Third Revised Sheet 51  
Cancelling Second Revised Sheet 51  
Effective: March 31, 2004

GENERAL REGULATIONS

H. ANNOYANCE CALLS AND REQUESTS FOR TRACING CALLS (TRAP AND TRACE) (Cont'd)

3. Responsibility of the Telephone Company (Cont'd)

- b. The results of the Trap and Trace will be provided only to the appropriate law enforcement agency.
- c. In situations where Trap and Trace functionality is initiated by a subscriber, information pertaining to nonpublished numbers will be provided to any authorized law enforcement agency upon request.

4. Responsibility of the Customer

- a. Before line identification processes are initiated, the customer-complainant will be required to:
  - 1) File a formal complaint with the appropriate law enforcement agency.
  - 2) Depending on the Central Office equipment, agree to identify each such call to the Company.
  - 3) Authorize the Company to place necessary line identification equipment on the central office facilities serving his/her telephones.
  - 4) Designate and appoint the Company as agent for purposes of revealing the identity and location of such telephones to law enforcement agencies engaged, at the customer-complainant's request, in the investigation thereof.
- b. In case of criminal action against the responsible person or civil action later by the person accused, the customer-complainant may be required to take the witness stand and testify.

GENERAL EXCHANGE TARIFF

Embarq Florida, Inc.

BY: F. B. Poag  
Director

SECTION A2  
Third Revised Sheet 52  
Cancelling Second Revised Sheet 52  
Effective: September 28, 2004

GENERAL REGULATIONS

H. ANNOYANCE CALLS AND REQUESTS FOR TRACING CALLS (TRAP AND TRACE) (Cont'd)

5. Results of Trap and Trace

If the abusive calls cannot be successfully traced, the customer will be offered the option of changing his/her telephone number, one time only, at no charge.

6. Rates and Charges

- a. There will be a nonrecurring charge to install the Trap and Trace feature and a monthly rate per access line for call Trap and Trace maintenance.

	<u>Monthly Rate</u>	<u>Nonrecurring Charge</u>
1 Month	\$30.40	\$59.00
12 Months	30.40	59.00



## GENERAL EXCHANGE TARIFF

Embarq Florida, Inc.

BY: F. B. Poag  
Director

SECTION A2  
First Revised Sheet 53  
Cancelling Original Sheet 53  
Effective: January 1, 1997

### GENERAL REGULATIONS

#### I. TELECOMMUNICATIONS ACCESS SYSTEM ACT (TASA) OF 1991

1. In Order No. 24581, Docket No. 910496-TP, Telecommunications Access System Act of 1991, the Commission requires each local exchange telecommunications company to begin accessing and collecting a surcharge per access line per month on bills rendered on or after July 1, 1991, for remission to the administrator for deposit in the operational fund. Each local exchange telecommunications company shall remit moneys collected to the administrator. On August 15, 1991, each local exchange telecommunications company shall begin remitting the moneys collected to the administrator on a monthly basis and in a manner as prescribed by the Commission. The administrator shall use such moneys to cover costs incurred during the development of the telecommunications relay services and to establish and administer the specialized telecommunications devices system.
2. The Commission requires all local exchange telecommunications companies to impose the monthly surcharge on all local exchange telecommunications company subscribers on an individual access line basis, except that such surcharge shall not be imposed upon more than 25 basic telecommunications access line per account bill rendered. The Commission is interpreting "account bill rendered" for purposes of determining the 25 access line limit using the methodology each local exchange company currently uses to define an individual account.
3. The surcharge will be itemized on the first bill rendered after July 1, 1991, at the time of the annual inventory statement and each time the surcharge is changed, as well as any other time a completely itemized bill is rendered. However, the surcharge will be itemized no more often than the total bill is itemized.

GENERAL EXCHANGE TARIFF

Embarq Florida, Inc.

BY: F. B. Poag  
Director

SECTION A2  
Sixth Revised Sheet 54  
Cancelling Fifth Revised Sheet 54  
Effective: April 3, 2006

GENERAL REGULATIONS

J. SPECIAL PROMOTIONS

1. The Company may offer special promotions of new or existing services or products for limited periods as approved by the Public Service Commission. These promotions are a temporary waiver of certain recurring and/or non-recurring charges as stated following. These promotions will be offered on a completely non-discriminating basis with each subscriber in the classification of service and area for which the promotion is offered having an equal opportunity for participation.
2. If there is an “\*” included under Charges Waived, it indicates that the waiver is available to first time subscribers of the services only.
3. The following promotions are approved by the Commission:

<u>Area of Promotion</u>	<u>Service</u>	<u>Charges Waived</u>	<u>Period</u>
Business Customers	Business Individual Line, Key Trunk, PBX Trunk, ISDN-BRI, ISDN-PRI II, Centrex Service, Frame Relay, or Translink	Company will waive all nonrecurring installation and/or service charges that are otherwise applicable when a business customer establishes a new account and subscribes to any of the services listed under the same order. The customer's initial monthly charges must be at least \$70 and the customer must commit to a minimum of a one year term in order to qualify for participation in this promotion. Charges for all regulated and non-regulated services, including all applicable taxes, surcharges and other fees, contribute towards the qualifying monthly charges. Customers subscribing to services under this promotion who discontinue service within one year of installation will be assessed all charges originally waived under the promotion.	4/3/06 thru 7/1/06

GENERAL EXCHANGE TARIFF

Embarq Florida, Inc.

BY: F. B. Poag  
Director

SECTION A2  
Seventeenth Revised Sheet 55  
Cancelling Sixteenth Revised Sheet 55  
Effective: April 3, 2006

GENERAL REGULATIONS

J. SPECIAL PROMOTIONS (Cont'd)

<u>Area of Promotion</u>	<u>Service</u>	<u>Charges Waived</u>	<u>Period</u>
Business Customers	ATM, Digilink, or Lightlink	The Company will waive all nonrecurring installation and/or service charges that are otherwise applicable when a business customer establishes a new account and subscribes to any of the services listed under the same order. The customer's initial monthly charges must be at least \$70 and the customer must commit to a minimum of a three year term in order to qualify for participation in this promotion. Charges for all regulated and non-regulated services, including all applicable taxes, surcharges and other fees, contribute towards the qualifying monthly charges. Customers subscribing to services under this promotion who discontinue service within one year of installation will be assessed all charges originally waived under the promotion.	4/3/06 thru 7/1/06

GENERAL EXCHANGE TARIFF

Embarq Florida, Inc.

BY: F. B. Poag  
Director

SECTION A2  
Nineteenth Revised Sheet 56  
Cancelling Eighteenth Revised Sheet 56  
Effective: April 3, 2006

GENERAL REGULATIONS

J. SPECIAL PROMOTIONS (Cont'd)

<u>Area of Promotion</u>	<u>Service</u>	<u>Charges Waived</u>		<u>Period</u>
Business Customers who are contacted by the Company or who contact the Company and request this promotion.	Customers must subscribe to any combination of business services for which the total monthly charges equal or exceed \$50. Charges for all regulated and non-regulated services, including all applicable taxes, surcharges and other fees, contribute towards the qualifying monthly charges.	Total		4/3/06 thru 7/1/06
		Monthly	Credit	
		<u>Charges</u>	<u>Amount</u>	
		\$50 - \$100	\$ 50.00	
		Over \$100 - \$200	\$ 100.00	
		Over \$200 - \$300	\$ 200.00	
		Over \$300 - \$400	\$ 300.00	
		Over \$400 - \$500	\$ 400.00	
		Over \$500 - \$600	\$ 500.00	
		Over \$600 - \$700	\$ 600.00	
		Over \$700 - \$800	\$ 700.00	
		Over \$800 - \$900	\$ 800.00	
		Over \$900 - \$1,000	\$ 900.00	
Over \$1,000	\$1,000.00			
A one-time credit amount, as specified above, will be reflected on the customer's first invoice.				
Business Customers who contact the Company to request that their service(s) be disconnected and agree to retain their service(s).	Customer's continued total monthly charges equal to or exceeding \$50. Charges for all regulated and non-regulated services, including all applicable taxes, surcharges and other fees, contribute towards the qualifying monthly charges.	Total		4/3/06 thru 7/1/06
		Monthly	Credit	
		<u>Charges</u>	<u>Amount</u>	
		\$50 - \$100	\$ 50.00	
		Over \$100 - \$200	\$ 100.00	
		Over \$200 - \$300	\$ 200.00	
		Over \$300 - \$400	\$ 300.00	
		Over \$400 - \$500	\$ 400.00	
		Over \$500 - \$600	\$ 500.00	
		Over \$600 - \$700	\$ 600.00	
		Over \$700 - \$800	\$ 700.00	
		Over \$800 - \$900	\$ 800.00	
		Over \$900 - \$1,000	\$ 900.00	
Over \$1,000	\$1,000.00			
A one-time credit amount, as specified above, will be reflected on the customer's first invoice.				

GENERAL EXCHANGE TARIFF

Embarq Florida, Inc

BY: F. B. Poag  
Director

SECTION A2  
Seventeenth Revised Sheet 57  
Cancelling Sixteenth Revised Sheet 57  
Effective: April 2, 2006

GENERAL REGULATIONS

J. SPECIAL PROMOTIONS (Cont'd)

<u>Area of Promotion</u>	<u>Service</u>	<u>Charges Waived</u>	<u>Period</u>
Business Customers	Enhanced Frame Relay Service and the Company's 1.5 Mbps Dedicated IP service offering under a one-year, two-year, three-year, or five-year term commitment.	All service charges otherwise applicable for installation of Enhanced Frame Relay Service will be waived for qualified customers. In addition, when customers subscribe to a one or two-year term, a single discounted Nonrecurring Charge (NRC) will apply in lieu of the Frame Relay Access Line NRC (includes access line and port) and the Permanent Virtual Circuit (PVC)-InterLATA NRC otherwise applicable for those individual Frame Relay rate elements. The NRC for a one or two-year term is \$500 and \$350, respectively. All NRCs will be waived when customers subscribe under a three or five-year term.	4/02/06 thru 6/30/06

GENERAL EXCHANGE TARIFF

Embarq Florida, Inc.

BY: F. B. Poag  
Director

SECTION A2  
Twelfth Revised Sheet 58  
Cancelling Eleventh Revised Sheet 58  
Effective: April 19, 2006

GENERAL REGULATIONS

J. SPECIAL PROMOTIONS (Cont'd)

<u>Area of Promotion</u>	<u>Service</u>	<u>Charges Waived</u>	<u>Period</u>
New Residential Customers who are contacted by the Company or who contact the Company and request this promotion and establish an account for local exchange service.	Local exchange service access lines.	Waive all service connection charges for services installed under the same order. If more than one local exchange service access line is requested under the same (initial) order, all service connection charges otherwise applicable for the installation will be waived. This waiver is not applicable on additional lines ordered after service is established. In addition to the preceding eligibility criteria, customers must not have had service disconnected for non-payment and must not have any past due bills for regulated service owed to the Company. Customers who discontinue or have their service disconnected within 90 days of installation will be assessed all charges waived under this promotion.	4/19/06 thru 5/31/06

GENERAL EXCHANGE TARIFF

Embarq Florida, Inc.

BY: F. B. Poag  
Director

SECTION A2  
Seventh Revised Sheet 59  
Cancelling Sixth Revised Sheet 59  
Effective: April 19, 2006

GENERAL REGULATIONS

J. SPECIAL PROMOTIONS (Cont'd)

<u>Area of Promotion</u>	<u>Service</u>	<u>Charges Waived</u>	<u>Period</u>
New Residential Customers	Any Solutions Package and DISH Service and/or High Speed Internet.	Customers who purchase any Solutions Package and one of the following services; DISH Service or High Speed Internet, from the Company, will receive a one time gift check in the amount of \$50.00. A residential customer that purchases any Solutions Package and both DISH Service and High Speed Internet from the Company will receive a one time gift check in the amount of \$100.00. Eligible customers must not have had service disconnected for non-payment and must not have any past due bills for regulated services owed to the Company. Customers will receive their check approximately eight weeks after all qualifying services are activated.	4/19/06 thru 5/31/06

GENERAL EXCHANGE TARIFF

Embarq Florida, Inc.

BY: F. B. Poag  
Director

SECTION A2  
Eight Revised Sheet 60  
Cancelling Seventh Revised Sheet 60  
Effective: February 24, 2006

GENERAL REGULATIONS

J. SPECIAL PROMOTIONS (Cont'd)



GENERAL EXCHANGE TARIFF

Embarq Florida, Inc.

BY: F. B. Poag  
Director

SECTION A2  
Eighth Revised Sheet 61  
Cancelling Seventh Revised Sheet 61  
Effective: February 24, 2006

GENERAL REGULATIONS

J. SPECIAL PROMOTIONS (Cont'd)

GENERAL EXCHANGE TARIFF

Embarq Florida, Inc.

BY: F. B. Poag  
Director

SECTION A2  
Eleventh Revised Sheet 62  
Cancelling Tenth Revised Sheet 62  
Effective: February 24, 2006

GENERAL REGULATIONS

J. SPECIAL PROMOTIONS (Cont'd)

GENERAL EXCHANGE TARIFF

Embarq Florida, Inc.

BY: F. B. Poag  
Director

SECTION A2  
Thirteenth Revised Sheet 63  
Cancelling Twelfth Revised Sheet 63  
Effective: February 24, 2006

GENERAL REGULATIONS

J. SPECIAL PROMOTIONS (Cont'd)

GENERAL EXCHANGE TARIFF

Embarq Florida, Inc.

BY: F. B. Poag  
Director

SECTION A2  
Seventh Revised Sheet 64  
Cancelling Sixth Revised Sheet 64  
Effective: February 24, 2006

GENERAL REGULATIONS

J. SPECIAL PROMOTIONS (Cont'd)

GENERAL EXCHANGE TARIFF

Embarq Florida, Inc.

BY: F. B. Poag  
Director

SECTION A2  
Sixth Revised Sheet 65  
Cancelling Fifth Revised Sheet 65  
Effective: February 24, 2006

GENERAL REGULATIONS

J. SPECIAL PROMOTIONS (Cont'd)

GENERAL EXCHANGE TARIFF

Embarq Florida, Inc.

BY: F. B. Poag  
Director

SECTION A2  
Second Revised Sheet 66  
Cancelling First Revised Sheet 66  
Effective: February 24, 2006

GENERAL REGULATIONS

J. SPECIAL PROMOTIONS (Cont'd)

GENERAL EXCHANGE TARIFF

Embarq Florida, Inc.

BY: F. B. Poag  
Director

SECTION A2  
Second Revised Sheet 67  
Cancelling First Revised Sheet 67  
Effective: February 24, 2006

GENERAL REGULATIONS

J. SPECIAL PROMOTIONS (Cont'd)

GENERAL EXCHANGE TARIFF

Embarq Florida, Inc.

BY: F. B. Poag  
Director

SECTION A2  
Second Revised Sheet 68  
Cancelling First Revised Sheet 68  
Effective: February 24, 2006

GENERAL REGULATIONS

J. SPECIAL PROMOTIONS (Cont'd)



GENERAL EXCHANGE TARIFF

Embarq Florida, Inc.

BY: F. B. Poag  
Director

SECTION A2  
Third Revised Sheet 69  
Cancelling Second Revised Sheet 69  
Effective: February 24, 2006

GENERAL REGULATIONS

J. SPECIAL PROMOTIONS (Cont'd)

GENERAL EXCHANGE TARIFF

Embarq Florida, Inc.

BY: F. B. Poag  
Director

SECTION A2  
Third Revised Sheet 70  
Cancelling Second Revised Sheet 70  
Effective: February 24, 2006

GENERAL REGULATIONS

J. SPECIAL PROMOTIONS (Cont'd)

GENERAL EXCHANGE TARIFF

Embarq Florida, Inc.

BY: F. B. Poag  
Director

SECTION A2  
Second Revised Sheet 71  
Cancelling First Revised Sheet 71  
Effective: February 24, 2006

GENERAL REGULATIONS

J. SPECIAL PROMOTIONS (Cont'd)

GENERAL EXCHANGE TARIFF

Embarq Florida, Inc.

BY: F. B. Poag  
Director

SECTION A2  
Second Revised Sheet 72  
Cancelling First Revised Sheet 72  
Effective: February 24, 2006

GENERAL REGULATIONS

J. SPECIAL PROMOTIONS (Cont'd)

GENERAL EXCHANGE TARIFF

Embarq Florida, Inc.

BY: F. B. Poag  
Director

SECTION A2  
Fifth Revised Sheet 73  
Cancelling Fourth Revised Sheet 73  
Effective: February 24, 2006

GENERAL REGULATIONS

J. SPECIAL PROMOTIONS (Cont'd)

GENERAL EXCHANGE TARIFF

Embarq Florida, Inc.

BY: F. B. Poag  
Director

SECTION A2  
Fifth Revised Sheet 74  
Cancelling Fourth Revised Sheet 74  
Effective: February 24, 2006

GENERAL REGULATIONS

J. SPECIAL PROMOTIONS (Cont'd)

GENERAL EXCHANGE TARIFF

Embarq Florida, Inc.

BY: F. B. Poag  
Director

SECTION A2  
Second Revised Sheet 75  
Cancelling First Revised Sheet 75  
Effective: February 24, 2006

GENERAL REGULATIONS

J. SPECIAL PROMOTIONS (Cont'd)

GENERAL EXCHANGE TARIFF

Embarq Florida, Inc.

BY: F. B. Poag  
Director

SECTION A2  
Second Revised Sheet 76  
Cancelling First Revised Sheet 76  
Effective: February 24, 2006

GENERAL REGULATIONS

J. SPECIAL PROMOTIONS (Cont'd)



GENERAL EXCHANGE TARIFF

Embarq Florida, Inc.

BY: F. B. Poag  
Director

SECTION A2  
Third Revised Sheet 77  
Cancelling Second Revised Sheet 77  
Effective: February 24, 2006

GENERAL REGULATIONS

J. SPECIAL PROMOTIONS (Cont'd)

GENERAL EXCHANGE TARIFF

Embarq Florida, Inc.

BY: F. B. Poag  
Director

SECTION A2  
Second Revised Sheet 78  
Cancelling First Revised Sheet 78  
Effective: February 24, 2006

GENERAL REGULATIONS

J. SPECIAL PROMOTIONS (Cont'd)

GENERAL EXCHANGE TARIFF

Embarq Florida, Inc.

BY: F. B. Poag  
Director

SECTION A2  
Second Revised Sheet 79  
Cancelling First Revised Sheet 79  
Effective: February 24, 2006

GENERAL REGULATIONS

J. SPECIAL PROMOTIONS (Cont'd)

GENERAL EXCHANGE TARIFF

Embarq Florida, Inc.

BY: F. B. Poag  
Director

SECTION A2  
Fourth Revised Sheet 80  
Cancelling Third Revised Sheet 80  
Effective: February 24, 2006

GENERAL REGULATIONS

J. SPECIAL PROMOTIONS (Cont'd)

GENERAL EXCHANGE TARIFF

Embarq Florida, Inc.

BY: F. B. Poag  
Director

SECTION A2  
Fourth Revised Sheet 81  
Cancelling Third Revised Sheet 81  
Effective: February 24, 2006

GENERAL REGULATIONS

J. SPECIAL PROMOTIONS (Cont'd)

GENERAL EXCHANGE TARIFF

Embarq Florida, Inc.

BY: F. B. Poag  
Director

SECTION A2  
Fourth Revised Sheet 82  
Cancelling Third Revised Sheet 82  
Effective: February 24, 2006

GENERAL REGULATIONS

J. SPECIAL PROMOTIONS (Cont'd)

GENERAL EXCHANGE TARIFF

Embarq Florida, Inc.

BY: F. B. Poag  
Director

SECTION A2  
Fourth Revised Sheet 83  
Cancelling Third Revised Sheet 83  
Effective: February 24, 2006

GENERAL REGULATIONS

J. SPECIAL PROMOTIONS (Cont'd)

GENERAL EXCHANGE TARIFF

Embarq Florida, Inc.

BY: F. B. Poag  
Director

SECTION A2  
Second Revised Sheet 84  
Cancelling First Revised Sheet 84  
Effective: February 24, 2006

GENERAL REGULATIONS

J. SPECIAL PROMOTIONS (Cont'd)



GENERAL EXCHANGE TARIFF

Embarq Florida, Inc.

BY: F. B. Poag  
Director

SECTION A2  
Third Revised Sheet 85  
Cancelling Second Revised Sheet 85  
Effective: February 24, 2006

GENERAL REGULATIONS

J. SPECIAL PROMOTIONS (Cont'd)

GENERAL EXCHANGE TARIFF

Embarq Florida, Inc.

BY: F. B. Poag  
Director

SECTION A2  
Second Revised Sheet 86  
Cancelling First Revised Sheet 86  
Effective: February 24, 2006

GENERAL REGULATIONS

J. SPECIAL PROMOTIONS (Cont'd)

GENERAL EXCHANGE TARIFF

Embarq Florida, Inc.

BY: F. B. Poag  
Director

SECTION A2  
Third Revised Sheet 87  
Cancelling Second Revised Sheet 87  
Effective: February 24, 2006

GENERAL REGULATIONS

J. SPECIAL PROMOTIONS (Cont'd)

GENERAL EXCHANGE TARIFF

Embarq Florida, Inc.

BY: F. B. Poag  
Director

SECTION A2  
Second Revised Sheet 88  
Cancelling First Revised Sheet 88  
Effective: February 24, 2006

GENERAL REGULATIONS

J. SPECIAL PROMOTIONS (Cont'd)

GENERAL EXCHANGE TARIFF

Embarq Florida, Inc.

BY: F. B. Poag  
Director

SECTION A2  
Second Revised Sheet 89  
Cancelling First Revised Sheet 89  
Effective: February 24, 2006

GENERAL REGULATIONS

J. SPECIAL PROMOTIONS (Cont'd)

GENERAL EXCHANGE TARIFF

Embarq Florida, Inc.

BY: F. B. Poag  
Director

SECTION A2  
Fourth Revised Sheet 90  
Cancelling Third Revised Sheet 90  
Effective: April 24, 2006

GENERAL REGULATIONS

J. SPECIAL PROMOTIONS (Cont'd)

<u>Area of Promotion</u>	<u>Service</u>	<u>Charges Waived</u>	<u>Period</u>
--------------------------	----------------	-----------------------	---------------

GENERAL EXCHANGE TARIFF

Embarq Florida, Inc.

BY: F. B. Poag  
Director

SECTION A2  
Second Revised Sheet 91  
Cancelling First Revised Sheet 91  
Effective: April 24, 2006

GENERAL REGULATIONS

J. SPECIAL PROMOTIONS (Cont'd)

<u>Area of Promotion</u>	<u>Service</u>	<u>Charges Waived</u>	<u>Period</u>
--------------------------	----------------	-----------------------	---------------

GENERAL EXCHANGE TARIFF

Embarq Florida, Inc.

BY: F. B. Poag  
Director

SECTION A2  
First Revised Sheet 92  
Cancelling Original Sheet 92  
Effective: January 3, 2006

GENERAL REGULATIONS

J. SPECIAL PROMOTIONS (Cont'd)

<u>Area of Promotion</u>	<u>Service</u>	<u>Charges Waived</u>	<u>Period</u>
New Business Customers or current Business Customers who establish a new account at a new location	Business Local Service (B1), Key Trunk, ISDN-BRI, ISDN-PRI II, Centrex, Enhanced Frame Relay, PBX Trunks, Translink	Waiver of all nonrecurring installation and service charges for all services installed under the same order. The customer's initial monthly charges must be at least \$75.00 to qualify for participation in this promotion.  Customers subscribing to services under this promotion who discontinue service within one year of installation will be assessed all charges originally waived under the promotion.	1/03/06 thru 4/02/06



GENERAL EXCHANGE TARIFF

Embarq Florida, Inc.

BY: F. B. Poag  
Director

SECTION A2  
First Revised Sheet 93  
Cancelling Original Sheet 93  
Effective: January 16, 2006

GENERAL REGULATIONS

J. SPECIAL PROMOTIONS (Cont'd)

<u>Area of Promotion</u>	<u>Service</u>	<u>Charges Waived</u>	<u>Period</u>
<p>New Residence customers establishing an account for local exchange service in the following exchanges and serving wire centers:                      Apopka, Astor, Belleview, Beverly Hills, Bowling Green, Bushnell, Cherry Lake, Clermont, Crystal River, Dade City, Eustis, Forest, Groveland, Homosassa Springs, Howey-In-The-Hills, Inverness, Kenansville, Kissimmee, Lady Lake, Leesburg, Montverde, Mount Dora, Ocala, Oklawaha, Orange City, Salt Springs, San Antonio, Silver Springs Shore, St. Cloud, St. Marks, Spring Lake, Tavares, Trilacoochee, Umatilla, West Kissimmee, Wildwood, Williston, Windermere, Winter Garden and Winter Park.</p>	<p>Any residential local exchange service.</p>	<p>All Service Connection charges for services installed under the same order. Customers must not have had service disconnected for non-payment and must not have any past due bills for regulated service owed to the Company. Customers who discontinue or have their service disconnected within 90 days of installation will be assessed all charges waived under this promotion.</p> <p>This waiver is not applicable on additional lines ordered after service is established.</p>	<p>1/16/06 thru 3/31/06</p>

Customers must be contacted by the Company or contact the Company and request this promotion.

GENERAL EXCHANGE TARIFF

Embarq Florida, Inc.

BY: F. B. Poag  
Director

SECTION A2  
Fourth Revised Sheet 94  
Cancelling Third Revised Sheet 94  
Effective: April 24, 2006

GENERAL REGULATIONS

J. SPECIAL PROMOTIONS (Cont'd)

<u>Area of Promotion</u>	<u>Service</u>	<u>Charges Waived</u>	<u>Period</u>
Business Customers with four lines or fewer	B1 Access Line plus Economy Bundle II A, Sure Solution II package, Priority Solutions package or Rotary Classics Solution package	The Company will waive all nonrecurring installation and/or service charges that are otherwise applicable with the B1 service when customers subscribe to the qualifying services listed. This offer cannot be combined with any other promotional offer.	01/25/06 thru 04/24/06
Residence Customers who are contacted by the Company or who contact the Company and request this promotion.	Home II Solution plus Embarq Communications, Inc. Solutions Unlimited Market Test – Option 2 or High Speed Internet	\$12.65 discount on Home II Solution bundle per month for 12 months.	2/13/06 thru 5/31/06

GENERAL EXCHANGE TARIFF

Embarq Florida, Inc.

BY: F. B. Poag  
Director

SECTION A2  
Third Revised Sheet 95  
Cancelling Second Revised Sheet 95  
Effective: April 24, 2006

GENERAL REGULATIONS

J. SPECIAL PROMOTIONS (Cont'd)

<u>Area of Promotion</u>	<u>Service</u>	<u>Charges Waived</u>	<u>Period</u>
Business Customers with four lines or fewer	Sure Solution II package with any Embarq Communications, Inc. plan; Priority Solution with Embarq Communications, Inc. Small Business Unlimited Solutions II long distance plan; or Rotary Classic Solutions	Customers who subscribe to the qualifying services listed will receive a \$25.15 credit on their next month's bill.	01/25/06 thru 06/30/06
Business Customers with four lines or fewer	Economy Bundle II A package or Rotary Line Service with Classics Custom Calling Package plus any Embarq Communications, Inc. plan	Customers who subscribe to the qualifying services listed will receive a \$15.15 credit on their next month's bill.	01/25/06 thru 06/30/06
Business Customers with four lines or fewer	B1 Access Line, B1 Access Line with Rotary or any Solutions Package	Customers who contact the Company to request that the telephone number associated with their individual Business Access Line service (B1), Rotary Access Line service or Solutions package be ported to another service provider, may receive a \$5.50 credit per month for 3 months for each access line, up to a maximum of four, when the customer agrees to retain their access line service. The credit will be applied on the customer's next three invoices.	01/25/06 thru 04/24/06

GENERAL EXCHANGE TARIFF

Embarq Florida, Inc.

SECTION A3

By: F. B. Poag  
Director

Ninth Revised Contents Sheet 1  
Cancelling Eighth Revised Contents Sheet 1  
Effective: November 12, 2004

BASIC LOCAL EXCHANGE SERVICE  
CONTENTS

A.	GENERAL .....	1
1.	Exchange Rate Schedules.....	1
2.	Exchange Service Areas.....	1
3.	Rules, Regulations, and Rates.....	1
4.	Selection of Local Exchange Services.....	1
5.	Definitions .....	1.1
B.	COMPANY WIDE RATE GROUPS .....	2
1.	Rate Groups .....	2
2.	Exchange Rate Group Classification and Calling Areas .....	3
3.	Regrouping Procedures .....	22
C.	DIALING PLANS .....	23
1.	EAS - Extended Area Service .....	23
2.	\$.20 EAS (Central Telephone exchanges only) .....	23
3.	ECS - Extended Calling Scope .....	24
4.	TOLLPAC .....	25
5.	OELC - Optional Extended Local Calling .....	28
6.	OEAS - Optional Extended Area Service .....	32
7.	Unlimited Calling – Flat Rate .....	38.1
D.	MONTHLY EXCHANGE RATES - BASIC SERVICES .....	39
1.	Residential .....	39
2.	SmallTalk .....	39
3.	Residential, Key Line .....	41.1
4.	Residential, Centrex Line .....	41.1
5.	Residential – Rotary .....	41.1
6.	Residential, Key Line - Rotary .....	42
7.	Residential, Centrex Line - Rotary .....	42
8.	Business .....	42
9.	Business, Key Line .....	42.1
10.	Business, Centrex Line.....	42.1
11.	Business – Rotary .....	42.1
12.	Business, Key Line - Rotary .....	43
13.	Business, Centrex Line - Rotary.....	43
14.	Trunks.....	43
15.	Trunks – Message Rate .....	43
16.	Rates and Charges.....	44

GENERAL EXCHANGE TARIFF

Embarq Florida, Inc.

SECTION A3

By: F. B. Poag  
Director

Second Revised Contents Sheet 1.1  
Cancelling First Revised Contents Sheet 1.1  
Effective: November 12, 2004

BASIC LOCAL EXCHANGE SERVICE  
CONTENTS

E.	LOCAL EXCHANGE EXCEPTIONS .....	46
1.	Tallahassee exchange.....	46
2.	Williston exchange.....	46
3.	Pine Island exchange: Useppa Island .....	47
4.	Punta Gorda exchange.....	48
5.	Sanibel-Captiva Islands: North Captiva Island .....	48
6.	Tavares exchange .....	49
7.	Lake Placid exchange .....	50
8.	Wildwood exchange .....	50
9.	Lady Lake exchange .....	50.2
10.	Baker exchange.....	50.2

GENERAL EXCHANGE TARIFF

Embarq Florida, Inc.

SECTION A3

By: F. B. Poag  
Director

Sixth Revised Contents Sheet 2  
Cancelling Fifth Revised Contents Sheet 2  
Effective: May 4, 2005

BASIC LOCAL EXCHANGE SERVICE  
CONTENTS

F.	DIRECTORY ASSISTANCE .....	51
1.	General .....	51
2.	Rates and Charges.....	51
G.	DIRECTORY ASSISTANCE CALL COMPLETION (DACC).....	52
1.	General .....	52
2.	Rates and Charges.....	55
H.	OPERATOR ASSISTED LOCAL CALLS .....	55
I.	VERIFICATION AND EMERGENCY INTERRUPT SERVICE.....	57
1.	General .....	57
2.	Rates and Charges.....	58
J.	LIFELINE ASSISTANCE PROGRAM .....	59
1.	General .....	59
2.	Applications and Regulations .....	59
K.	TRANSITIONAL LIFELINE ASSISTANCE PROGRAM	
1.	General .....	60
2.	Regulations.....	60
L.	SPECIAL ACCESS SERVICES .....	60
1.	General .....	60
2.	Application of Additional Measured or Message Charges .....	61
M.	RESERVE FOR FUTURE USE.....	
N.	RESERVE FOR FUTURE USE.....	

## GENERAL EXCHANGE TARIFF

Embarq Florida, Inc.

By: F. B. Poag  
Director

SECTION A3  
Second Revised Sheet 1  
Cancelling First Revised Sheet 1  
Effective: May 29, 1997

### BASIC LOCAL EXCHANGE SERVICE

#### A. GENERAL

1. Exchange rate schedules are applied according to the total number of access lines and PBX trunks in the local service area.
2. Exchange Service Areas for each exchange are identified on maps filed as a supplement to this tariff. Base Rate Area maps are also included with the United Telephone exchanges.
3. The rules, regulations and rates for service and facilities not specifically shown in this section are detailed in other sections of this tariff.
4. Selections of Local Exchange Services
  - a. All systems (PBX and multi-functional) that permit connections to access lines through an operator, dial access, or systems that maintain within their operating capabilities features that permit dial access will be billed the PBX trunk rate.
  - b. When system connection access lines is achievable other than as described above, then PBX trunk rates will not apply. Instead, a different class of service will be selected as is appropriate to the needs of the customer being served. When hybrid Key Systems are used by the customer, the Company will provide access lines at business rates if the customer certifies that there is no use of shared trunks and/or dial access arrangements. In the absence of such certification, orally or in writing, the customer using hybrid Key Systems will be charged for system connection access lines at PBX trunk rates.

## GENERAL EXCHANGE TARIFF

Embarq Florida, Inc.

By: F. B. Poag  
Director

SECTION A3  
Second Revised Sheet 1.1  
Cancelling First Revised Sheet 1.1  
Effective: April 17, 2000

### BASIC LOCAL EXCHANGE SERVICE

#### A. GENERAL (Cont'd)

##### 5. Definitions

- a. EAS - Extended Area Service - Telephone service provided under tariff whereby subscribers of a given exchange may complete calls to and receive calls from one or more exchanges without incurring toll charges. See C.1. for a complete explanation of this service.
- b. \$.20 EAS (Central Telephone exchanges only) - A type of Extended Area Service where calls from the referenced exchange to any exchange listed will be charged at \$.20 per completed call of unlimited duration for residence; and \$.20 per call up to a total of 60 minutes per message with usage exceeding the 60 minutes being charged for at the long distance message rates shown in A18 for business. See C.2. for a complete explanation of this service.
- c. ECS - Extended Calling Scope - A type of extended local calling developed by the Commission, which provides an alternative to toll message rates on routes between specified exchanges. Consists of three plans:

Plan A: All calls, residence and business, are rated at \$.25 per call for unlimited duration.

Plan B: All residence calls are rated at \$.25 per call of unlimited duration, and business calls are rated at \$.10 for the first minute and \$.06 for each additional minute.

Plan C: All calls, residence and business, are rated on a usage-sensitive basis of \$.10 for the first minute of use and \$.06 for each additional minute of use.

See C.3. for a complete explanation of this service.



## GENERAL EXCHANGE TARIFF

Embarq Florida, Inc.

By: F. B. Poag  
Director

SECTION A3  
Fourth Revised Sheet 1.2  
Cancelling Third Revised Sheet 1.2  
Effective: November 12, 2004

### BASIC LOCAL EXCHANGE SERVICE

#### A. GENERAL (Cont'd)

##### 5. Definitions (Cont'd)

- d. TOLL-PAC - a one-way calling plan which allows a subscriber the option of placing toll calls to specific nearby exchanges at a 30% discount applied to the direct dial rate. The plan has a minimum monthly rate which will apply for each point-to-point or for each point to multi-point service. TOLL-PAC for United exchanges had two rate steps, designated in the listing of exchange rate group classifications and calling areas on the following pages as (RS1) and (RS2). TOLL-PAC is available in only one Central Telephone Exchange, therefore only one rate is applicable. See C.4. for a complete explanation of this service.
- e. OELC - Optional Extended Local Calling - An optional two-way calling plan available between specific exchanges. The plan permits customers to pay a monthly flat rate for the ability to place and receive unlimited toll-free calls to and from the selected exchange which is outside the normal local calling area. See C.5. for a complete explanation of this service.
- f. OEAS - A one-way optional calling plan offered on selected exchanges to provide an alternative to long distance message rates on exchanges within the same LATA. There are two flat-rated block of time options, and one unlimited calling option available to residence customers and a discounted toll option available to residence and business customers.

GENERAL EXCHANGE TARIFF

Embarq Florida, Inc.

By: F. B. Poag  
Director

SECTION A3  
Third Revised Sheet 2  
Cancelling Second Revised Sheet 2  
Effective: November 12, 2004

BASIC LOCAL EXCHANGE SERVICE

B. COMPANY-WIDE RATE GROUPS

1. Rate Groups

The following schedules of rate groups are appropriate for the furnishing of flat-rate service. The groupings are based on access lines and PBX trunks in the local service areas.

<u>Group</u>	<u>Upper Limit</u>
1	12,500
2	85,000
3	200,000
4	550,000
5	Over 550,000

GENERAL EXCHANGE TARIFF

Embarq Florida, Inc.

By: F. B. Poag  
Director

SECTION A3  
Eighth Revised Sheet 3  
Cancelling Seventh Revised Sheet 3  
Effective: November 12, 2004

BASIC LOCAL EXCHANGE SERVICE

B. COMPANY-WIDE RATE GROUPS

2. Exchange Rate Group Classifications And Calling Areas

<u>Exchange</u>	<u>Rate Group</u>	<u>Category</u>	<u>Additional Exchanges</u>
Alford	2	EAS \$.20 EAS	Cottdale, Marianna, Graceville* Grand Ridge, Greenwood, Malone, Sneads
Apopka	5	EAS  ECS	East Orange*, Lake Buena Vista*, Montverde, Orlando, Reedy Creek, Windemere, Winter Garden, Winter Park, Celebration  Plan A: Mount Dora
Arcadia	2	ECS	Plan B: Port Charlotte, Zolfo Springs, Wauchula
Astor	3	EAS	Clermont, Eustis, Groveland, Howey-in-the-Hills, Lady Lake, Leesburg, Montverde, Mount Dora, Tavares, Umatilla, Weirsdale
Avon Park	2	EAS ECS	Sebring Plan A: Lake Placid, Spring Lake Plan B: Wauchula
Baker	2	EAS \$.20 EAS ECS	Crestview Destin, Fort Walton Beach, Shalimar, Valparaiso Plan B: DeFuniak Springs, Laurel Hill*

\*Other than Embarq Florida, Inc. service area.

GENERAL EXCHANGE TARIFF

Embarq Florida, Inc.

By: F. B. Poag  
Director

SECTION A3  
Fifth Revised Sheet 4  
Cancelling Fourth Revised Sheet 4  
Effective: November 12, 2004

BASIC LOCAL EXCHANGE SERVICE

B. COMPANY-WIDE RATE GROUPS

2. Exchange Rate Group Classifications And Calling Areas

<u>Exchange</u>	<u>Rate Group</u>	<u>Category</u>	<u>Additional Exchanges</u>
Bellevue	4	EAS	Citra*, Dunnellon*, Forest, McIntosh*, Lady Lake, Ocala, Ocklawaha, Orange Springs*, Salt Springs, Silver Springs Shores, Weirsdale Plan B: Wildwood
		ECS	
Beverly Hills	3	EAS	Crystal River, Dunnellon*, Homosassa Springs, Inverness
Boca Grande	1	ECS	Plan A: Cape Haze Plan B: Port Charlotte, Punta Gorda, Englewood*
Bonifay	2	EAS	Reynolds Hill, Westville, Chipley*, Graceville*, Vernon* DeFuniak Springs, Ponce de Leon
		\$.20 EAS	
Bonita Springs	4	EAS	Fort Myers, Fort Myers Beach, Naples, North Naples
Bowling Green	1	EAS	Wauchula, Zolfo Springs Plan A: Fort Meade
		ECS	
Bushnell	2	EAS	Wildwood Plan B: Howey-In-The-Hills, Leesburg
		ECS	

\*Other than Embarq Florida, Inc. service area.

GENERAL EXCHANGE TARIFF

Embarq Florida, Inc.

By: F. B. Poag  
Director

SECTION A3  
Seventh Revised Sheet 5  
Cancelling Sixth Revised Sheet 5  
Effective: November 12, 2004

BASIC LOCAL EXCHANGE SERVICE

B. COMPANY-WIDE RATE GROUPS

2. Exchange Rate Group Classifications And Calling Areas

<u>Exchange</u>	<u>Rate Group</u>	<u>Category</u>	<u>Additional Exchanges</u>
Cape Coral	4	EAS ECS	Fort Myers, Fort Myers Beach, North Cape Coral, North Fort Myers, Pine Island, Sanibel-Captiva Islands, Punta Gorda Plan B: Lehigh
Cape Haze	2	EAS ECS	Englewood* Plan A: Boca Grande, Port Charlotte Plan B: Punta Gorda
Cherry Lake	1	EAS	Greenville, Lee, Madison
Clermont	5	EAS	Astor, Eustis, Groveland, Howey-in-the-Hills, Lady Lake, Lake Buena Vista*, Leesburg, Montverde, Mount Dora, Orlando*, Reedy Creek, Tavares, Umatilla, Windermere, Winter Garden, Celebration*, Weirsdale
Clewiston	1	ECS	Plan A: Moore Haven Plan B: LaBelle Plan C: Belle Glade*
Cottdale	2	EAS \$.20 EAS	Alford, Marianna, Chipley*, Graceville* Grand Ridge, Greenwood, Malone, Sneads
Crawfordville	4	EAS	Alligator Point*, Carrabelle*, Panacea, Saint Marks, Sopchoppy, Tallahassee
Crestview	2	EAS \$.20 EAS ECS	Baker, Laurel Hill* Destin, Fort Walton Beach, Shalimar, Valparaiso Plan B: DeFuniak Springs
Crystal River	2	EAS	Beverly Hills, Homosassa Springs, Inverness, Yankeetown*

\*Other than Embarq Florida, Inc. service area.

GENERAL EXCHANGE TARIFF

Embarq Florida, Inc.

SECTION A3

By: F. B. Poag  
Director

Fifth Revised Sheet 6  
Cancelling Fourth Revised Sheet 6  
Effective: November 12, 2004

BASIC LOCAL EXCHANGE SERVICE

B. COMPANY-WIDE RATE GROUPS

2. Exchange Rate Group Classifications And Calling Areas

<u>Exchange</u>	<u>Rate Group</u>	<u>Category</u>	<u>Additional Exchanges</u>
Dade City	2	EAS ECS	Brooksville*, San Antonio, Trilacoochee, Zephyrhills* Plan B: Tampa-Central & North*
DeFuniak Springs	2	EAS \$.20 EAS ECS	Freeport, Glendale, Paxton*, Ponce de Leon, Santa Rosa Beach, Seagrove Beach Bonifay, Destin, Reynolds Hill, Valparaiso, Westville Plan B: Fort Walton Beach, Crestview, Baker, Shalimar Plan C: Graceville*
Destin	3	EAS \$.20 EAS	Fort Walton Beach, Santa Rosa Beach, Shalimar, Seagrove Beach, Valparaiso Baker, Crestview, DeFuniak Springs, Freeport, Glendale, Ponce de Leon
Eustis	3	EAS	Astor, Clermont, Groveland, Howey-in-the-Hills, Lady Lake, Leesburg, Montverde, Mount Dora, Tavares, Umatilla, Weirsdale
Everglades	3	EAS	Naples
Forest	3	EAS	Belleview, Citra*, Dunnellon*, McIntosh*, Ocala, Ocklawaha, Orange Springs*, Salt Springs, Silver Springs Shores, Weirsdale
Fort Meade	3	EAS ECS	Bartow*, Lakeland* Plan A: Bowling Green

\*Other than Embarq Florida, Inc. service area.

GENERAL EXCHANGE TARIFF

Embarq Florida, Inc.

SECTION A3

By: F. B. Poag  
Director

Sixth Revised Sheet 7  
Cancelling Fifth Revised Sheet 7  
Effective: November 12, 2004

BASIC LOCAL EXCHANGE SERVICE

B. COMPANY-WIDE RATE GROUPS

2. Exchange Rate Group Classifications And Calling Areas

<u>Exchange</u>	<u>Rate Group</u>	<u>Category</u>	<u>Additional Exchanges</u>
Fort Myers	4	EAS	Bonita Springs, Cape Coral, Fort Myers Beach, Lehigh Acres, North Cape Coral, North Fort Myers, Pine Island, Sanibel-Captiva Islands, Punta Gorda
		ECS	Plan A: Immokalee Plan B: LaBelle, Naples, North Naples
Fort Myers Beach	4	EAS	Bonita Springs, Cape Coral, Fort Myers, North Cape Coral, North Fort Myers, Pine Island, Sanibel-Captiva Islands
		ECS	Plan B: Naples, North Naples
Fort Walton Beach	3	EAS	Destin, Holley-Navarre*, Santa Rosa Beach, Shalimar, Valparaiso
		\$.20 EAS	Baker, Crestview, Seagrove Beach
		ECS	Plan B: Freeport, DeFuniak Springs
Freeport	2	EAS	DeFuniak Springs, Seagrove Beach, Destin, Glendale, Ponce de Leon, Santa Rosa Beach, Valparaiso
		\$.20 EAS	
		ECS	Plan B: Fort Walton Beach
Glendale	1	EAS	DeFuniak Springs
		\$.20 EAS	Destin, Freeport, Paxton*, Ponce de Leon, Santa Rosa Beach, Seagrove Beach, Valparaiso
Grand Ridge	2	EAS	Graceville*, Marianna, Sneads
		\$.20 EAS	Alford, Cottondale, Greenwood, Malone
Greenville	4	EAS	Cherry Lake, Lee, Madison, Monticello, Tallahassee
Greenwood	2	EAS	Graceville*, Malone, Marianna
		\$.20 EAS	Alford, Cottondale, Grand Ridge, Sneads

\*Other than Embarq Florida, Inc. service area.

GENERAL EXCHANGE TARIFF

Embarq Florida, Inc.

SECTION A3

By: F. B. Poag  
Director

Sixth Revised Sheet 7.1  
Cancelling Fifth Revised Sheet 7.1  
Effective: November 12, 2004

BASIC LOCAL EXCHANGE SERVICE

B. COMPANY-WIDE RATE GROUPS

2. Exchange Rate Group Classifications And Calling Areas

<u>Exchange</u>	<u>Rate Group</u>	<u>Category</u>	<u>Additional Exchanges</u>
Groveland	5	EAS  TOLL-PAC	Astor, Clermont, Eustis, Howey-in-the-Hills, Lady Lake, Leesburg, Montverde, Mount Dora, Orlando*, Tavares, Umatilla, Weirsdale, Windermere, Winter Garden Bushnell (RS2)
Homosassa Springs	2	EAS	Beverly Hills, Crystal River, Inverness
Howey-in-the Hills	3	EAS  ECS	Astor, Clermont, Eustis, Groveland, Lady Lake, Leesburg, Montverde, Mount Dora, Tavares, Umatilla, Weirsdale Plan B: Bushnell, Wildwood
Immokalee	1	ECS	Plan A: Fort Myers, Naples Plan B: LaBelle
Inverness	2	EAS TOLL-PAC	Beverly Hills, Crystal River, Homosassa Springs Brooksville* (RS2), Dunnellon* (RS2), Yankeetown*(RS3)
Kenansville	3	EAS TOLL-PAC	Kissimmee, Saint Cloud, West Kissimmee Orlando*(RS3)
Kingsley Lake	1	EAS TOLL-PAC	Lawtey, Raiford*, Starke Jacksonville*
Kissimmee	4	EAS  ECS	Haines City (427)*, Kenansville, Orlando*, Saint Cloud, West Kissimmee, Celebration* Plan A: Reedy Creek Plan B: Haines City*, Winter Park

\*Other than Embarq Florida, Inc. service area.



GENERAL EXCHANGE TARIFF

Embarq Florida, Inc.

SECTION A3

By: F. B. Poag  
Director

Ninth Revised Sheet 8  
Cancelling Eighth Revised Sheet 8  
Effective: November 12, 2004

BASIC LOCAL EXCHANGE SERVICE

B. COMPANY-WIDE RATE GROUPS

2. Exchange Rate Group Classifications And Calling Areas

<u>Exchange</u>	<u>Rate Group</u>	<u>Category</u>	<u>Additional Exchanges</u>
LaBelle	1	ECS OEAS	Plan B: Clewiston, Immokalee, Fort Myers Fort Myers
Lady Lake	4	EAS  ECS	Astor, Belleview, Clermont, Eustis, Groveland, Howey-in-the-Hills, Leesburg, Montverde, Mount Dora, Tavares, Umatilla, Weirsdale, Wildwood Plan A: Ocklawaha Plan B: Silver Springs Shores
Lake Placid	2	EAS ECS	Sebring Plan A: Avon Park, Spring Lake
Lawtey	1	EAS ECS	Kingsley Lake, Raiford*, Starke Plan A: Brooker*, Waldo* Plan C: Gainesville*
Lee	1	EAS	Cherry Lake, Greenville, Madison
Leesburg	3	EAS  ECS	Astor, Clermont, Eustis, Groveland, Howey-in- the-Hills, Lady Lake, Montverde, Mount Dora, Tavares, Umatilla, Weirsdale Plan B: Bushnell, Wildwood
Lehigh Acres	3	EAS ECS	Fort Myers Plan B: Cape Coral, North Cape Coral, North Fort Myers

\*Other than Embarq Florida, Inc. service area.

GENERAL EXCHANGE TARIFF

Embarq Florida, Inc.

SECTION A3

By: F. B. Poag  
Director

Sixth Revised Sheet 9  
Cancelling Fifth Revised Sheet 9  
Effective: November 12, 2004

BASIC LOCAL EXCHANGE SERVICE

B. COMPANY-WIDE RATE GROUPS

2. Exchange Rate Group Classifications And Calling Areas

<u>Exchange</u>	<u>Rate Group</u>	<u>Category</u>	<u>Additional Exchanges</u>
Madison	1	EAS ECS	Cherry Lake, Greenville, Lee Plan A: Monticello, Tallahassee
Malone	2	EAS \$.20 EAS	Graceville*, Greenwood, Marianna Alford, Cottondale, Grand Ridge, Sneads
Marco Island	4	EAS	Naples, North Naples
Marianna	2	EAS	Alford, Altha*, Cottondale, Graceville*, Grand Ridge, Greenwood, Malone, Sneads
Monticello	4	EAS ECS	Greenville, Tallahassee Plan A: Madison
Montverde	5	EAS	Apopka, Astor, Clermont, East Orange*, Eustis, Groveland, Howey-in-the-Hills, Lady Lake, Lake Buena Vista*, Leesburg, Mount Dora, Orlando*, Reedy Creek, Tavares, Umatilla, Windermere, Winter Garden, Winter Park, Celebration*, Weirsdale
Moore Haven	1	ECS	Plan A: Clewiston
Mount Dora	3	EAS  ECS	Astor, Clermont, Eustis, Groveland, Howey-in- the-Hills, Lady Lake, Leesburg, Montverde, Tavares, Umatilla, Weirsdale Plan A: Apopka, Winter Park Plan C: Orlando*

\*Other than Embarq Florida, Inc. service area.

GENERAL EXCHANGE TARIFF

Embarq Florida, Inc.

SECTION A3

By: F. B. Poag  
Director

Fifth Revised Sheet 10  
Cancelling Fourth Revised Sheet 10  
Effective: November 12, 2004

BASIC LOCAL EXCHANGE SERVICE

B. COMPANY-WIDE RATE GROUPS

2. Exchange Rate Group Classifications And Calling Areas

<u>Exchange</u>	<u>Rate Group</u>	<u>Category</u>	<u>Additional Exchanges</u>
Naples	4	EAS	Bonita Springs, Everglades, Marco Island, North Naples
		ECS	Plan A: Immokalee Plan B: Fort Myers, Fort Myers Beach
North Cape Coral	4	EAS	Cape Coral, Fort Myers, Fort Myers Beach, North Fort Myers, Pine Island, Sanibel-Captiva Islands
		ECS	Plan B: Lehigh Acres, Punta Gorda
North Fort Myers	4	EAS	Cape Coral, Fort Myers, Fort Myers Beach, North Cape Coral, Pine Island, Sanibel-Captiva Islands
		ECS	Plan B: Lehigh Acres, Punta Gorda
North Naples	4	EAS	Bonita Springs, Marco Island, Naples
		ECS	Plan B: Fort Myers, Fort Myers Beach
Ocala	3	EAS	Belleview, Citra*, Dunnellon*, Forest, McIntosh*, Ocklawaha, Orange Springs*, Salt Springs, Silver Springs Shores, Weirsdale
		ECS	Plan B: Williston, Wildwood
		OELC	Williston

\*Other than Embarq Florida, Inc. service area.

GENERAL EXCHANGE TARIFF

Embarq Florida, Inc.

By: F. B. Poag  
Director

SECTION A3  
Sixth Revised Sheet 11  
Cancelling Fifth Revised Sheet 11  
Effective: November 12, 2004

BASIC LOCAL EXCHANGE SERVICE

B. COMPANY-WIDE RATE GROUPS

2. Exchange Rate Group Classifications And Calling Areas

<u>Exchange</u>	<u>Rate Group</u>	<u>Category</u>	<u>Additional Exchanges</u>
Ocklawaha	3	EAS ECS TOLL-PAC	Bellevue, Citra*, Dunnellon*, Forest, McIntosh*, Ocala, Orange Springs*, Salt Springs, Silver Springs Shores, Weirsdale Plan A: Lady Lake Eustis (RS2), Leesburg (RS2), Umatilla (RS2)
Okeechobee	2	ECS	Plan B: Sebring
Orange City	3	EAS ECS	DeBary*, Deland*, DeLeon Springs* Plan A: Sanford* Plan B: Winter Park Plan C: Daytona Beach*, New Smyrna Beach*, Oak Hill*, Pierson*
<b>Panacea</b>	4	EAS	Alligator Point*, Crawfordville, Saint Marks, Sopchoppy, Tallahassee
Pine Island	4	EAS	Cape Coral, Fort Myers, Fort Myers Beach, North Cape Coral, North Fort Myers, Sanibel-Captiva Islands
<b>Ponce de Leon</b>	1	EAS \$.20 EAS ECS	DeFuniak Springs Bonifay, Destin, Freeport, Glendale, Reynolds Hill, Santa Rosa Beach, Seagrove Beach, Westville, Valparaiso Plan C: Graceville*
Port Charlotte	3	EAS ECS	North Port*, Punta Gorda Plan A: Cape Haze Plan B: Arcadia, Boca Grande

\*Other than Embarq Florida, Inc. service area.

GENERAL EXCHANGE TARIFF

Embarq Florida, Inc.

SECTION A3

By: F. B. Poag  
Director

Eighth Revised Sheet 12  
Cancelling Seventh Revised Sheet 12  
Effective: November 12, 2004

BASIC LOCAL EXCHANGE SERVICE

B. COMPANY-WIDE RATE GROUPS

2. Exchange Rate Group Classifications And Calling Areas

<u>Exchange</u>	<u>Rate Group</u>	<u>Category</u>	<u>Additional Exchanges</u>
Punta Gorda	4	EAS ECS	Cape Coral, Port Charlotte, Fort Myers Plan B: Boca Grande, Cape Haze, North Cape Coral, North Fort Myers
Reedy Creek	5	EAS  ECS	Apopka, Clermont, East Orange*, Lake Buena Vista*, Montverde, Orlando*, West Kissimmee, Windermere, Winter Garden, Winter Park, Celebration* Plan A: Kissimmee Plan B: Haines City*
Reynolds Hill	1	EAS \$.20 EAS	Bonifay, Graceville*, Westville Ponce de Leon, DeFuniak Springs
Saint Cloud	4	EAS  ECS	Celebration*, Kenansville, Kissimmee, Orlando*, West Kissimmee  Plan B: Winter Park
Saint Marks	4	EAS	Alligator Point*, Crawfordville, Panacea, Sopchoppy, Tallahassee
Salt Springs	3	EAS	Belleview, Citra*, Dunnellon*, Forest, McIntosh*, Ocala, Ocklawaha, Orange Springs*, Silver Springs Shores, Weirsdale
San Antonio	2	EAS  ECS	Brooksville*, Dade City, Trilacoochee, Zephyrhills*  Plan B: Tampa North & Central*

\*Other than Embarq Florida, Inc. service area.

GENERAL EXCHANGE TARIFF

Embarq Florida, Inc.

By: F. B. Poag  
Director

SECTION A3  
Seventh Revised Sheet 13  
Cancelling Sixth Revised Sheet 13  
Effective: November 12, 2004

BASIC LOCAL EXCHANGE SERVICE

B. COMPANY-WIDE RATE GROUPS

2. Exchange Rate Group Classifications And Calling Areas

<u>Exchange</u>	<u>Rate Group</u>	<u>Category</u>	<u>Additional Exchanges</u>
Sanibel-Captiva Islands	4	EAS	Cape Coral, Fort Myers, Fort Myers Beach, North Cape Coral, North Fort Myers, Pine Island
Santa Rosa Beach	3	EAS \$.20 EAS	Destin, DeFuniak Springs, Fort Walton Beach, Seagrove Beach Freeport, Glendale, Ponce de Leon, Valparaiso
Seagrove Beach	2	EAS \$.20 EAS	DeFuniak Springs, Destin, Freeport, Santa Rosa Beach Fort Walton Beach, Glendale, Ponce de Leon, Valparaiso
Sebring	2	EAS ECS	Avon Park, Lake Placid, Spring Lake Plan B: Okeechobee, Wauchula
Shalimar	3	EAS \$.20 EAS ECS	Destin, Fort Walton Beach, Valparaiso Baker, Crestview Plan B: DeFuniak Springs
Silver Springs Shores	3	EAS ECS	Bellevue, Citra*, Dunnellon*, Forest, McIntosh*, Ocala, Ocklawaha, Orange Springs*, Salt Springs, Weirsdale Plan B: Lady Lake, Wildwood
Sneads	2	EAS \$.20 EAS	Graceville*, Grand Ridge, Marianna Alford, Cottondale, Greenwood, Malone, Chattahoochee*
Sopchoppy	4	EAS	Alligator Point*, Carrabelle*, Crawfordville, Panacea, Saint Marks, Tallahassee

\*Other than Embarq Florida, Inc. service area.

GENERAL EXCHANGE TARIFF

Embarq Florida, Inc.

SECTION A3

By: F. B. Poag  
Director

Eighth Revised Sheet 14  
Cancelling Seventh Revised Sheet 14  
Effective: November 12, 2004

BASIC LOCAL EXCHANGE SERVICE

B. COMPANY-WIDE RATE GROUPS

2. Exchange Rate Group Classifications And Calling Areas

<u>Exchange</u>	<u>Rate Group</u>	<u>Category</u>	<u>Additional Exchanges</u>
Spring Lake	2	EAS ECS	Sebring Plan A: Avon Park, Lake Placid
Starke	2	EAS ECS	Keystone Heights*, Kingsley Lake, Lawtey, Raiford* Plan A: Brooker*, Lake Butler* Waldo* Plan C: Gainesville*
Tallahassee**	4	EAS  ECS	Alligator Point*, Bristol*, Carrabelle*, Chattahoochee*, Crawfordville, Greensboro*, Greenville, Gretna*, Havana*, Hosford*, Monticello, Panacea, Quincy*, Saint Marks, Sopchoppy Plan A: Madison
Tavares	3	EAS	Astor, Clermont, Eustis, Groveland, Howey-In-The-Hills, Lady Lake, Leesburg, Montverde, Mount Dora, Umatilla, Weirsdale
Trilacoochee	2	EAS  TOLL-PAC	Brooksville*, Dade City, San Antonio, Zephyrhills*  Bushnell (RS2)
Umatilla	3	EAS	Astor, Clermont, Eustis, Groveland, Howey-In-The-Hills, Lady Lake, Leesburg, Montverde, Mount Dora, Tavares, Weirsdale
Valparaiso	3	EAS \$.20 EAS	Destin, Fort Walton Beach, Shalimar Baker, Crestview, DeFuniak Springs, Freeport, Glendale, Ponce de Leon, Santa Rosa Beach, Seagrove Beach
Wauchula	1	EAS ECS	Bowling Green, Zolfo Springs Plan B: Avon Park, Sebring, Arcadia

\*Other than Embarq Florida, Inc. service area.

\*\*Calls to the Chattahoochee exchange will be based on an allowance of five (5) calls in the aggregate per month with a charge of twenty cents (\$.20) per call to apply to each additional call above five (5).

GENERAL EXCHANGE TARIFF

Embarq Florida, Inc.

By: F. B. Poag  
Director

SECTION A3  
Seventh Revised Sheet 15  
Cancelling Sixth Revised Sheet 15  
Effective: November 12, 2004

BASIC LOCAL EXCHANGE SERVICE

B. COMPANY-WIDE RATE GROUPS

2. Exchange Rate Group Classifications And Calling Areas

<u>Exchange</u>	<u>Rate Group</u>	<u>Category</u>	<u>Additional Exchanges</u>
Weirsdale	4	EAS	Astor, Belleview, Clermont, Eustis, Forest, Groveland, Howey-In-The-Hills, Lady Lake, Leesburg, Montverde, Mount Dora, Ocala, Ocklawaha, Salt Springs, Silver Springs Shores, Tavares, Umatilla
		ECS	Plan A: Wildwood
West Kissimmee	4	EAS	Haines City (427)*, Kenansville, Kissimmee, Orlando*, Reedy Creek, Saint Cloud, Celebration*
		ECS	Plan A: Lake Buena Vista*, Plan B: Haines City*, Winter Park
Westville	2	EAS \$.20 EAS	Bonifay, Graceville*, Reynolds Hill, Vernon* DeFuniak Springs, Ponce de Leon
Wildwood	2	EAS ECS	Bushnell, Lady Lake Plan A: Weirsdale Plan B: Belleview, Howey-In-The Hills, Leesburg, Ocala, Silver Springs Shores, Leesburg
Williston	3	EAS ECS	Archer*, Bronson*, Gainesville*
		OELC	Plan B: McIntosh*, Ocala Ocala
Windermere	4	EAS	Apopka, Clermont, East Orange*, Groveland, Lake Buena Vista*, Orlando*, Montverde, Reedy Creek, Winter Garden, Winter Park, Celebration*
Winter Garden	5	EAS	Apopka, Clermont, East Orange*, Groveland, Lake Buena Vista*, Montverde, Orlando*, Reedy Creek, Windermere, Winter Park, Celebration*

\*Other than Embarq Florida, Inc. service area.



GENERAL EXCHANGE TARIFF

Embarq Florida, Inc.

By: F. B. Poag  
Director

SECTION A3  
Sixth Revised Sheet 16  
Cancelling Fifth Revised Sheet 16  
Effective: November 12, 2004

BASIC LOCAL EXCHANGE SERVICE

B. COMPANY-WIDE RATE GROUPS

2. Exchange Rate Group Classifications And Calling Areas

<u>Exchange</u>	<u>Rate Group</u>	<u>Category</u>	<u>Additional Exchanges</u>
Winter Park	5	EAS	Apopka, East Orange*, Geneva*, Lake Buena Vista*, Montverde, Orlando*, Oviedo*, Reedy Creek, Sanford*, Windermere, Winter Garden, Celebration*
		ECS	Plan A: Mount Dora Plan B: DeBary*, Kissimmee, Orange City, Saint Cloud, West Kissimmee
Zolfo Springs	1	EAS	Bowling Green, Wauchula
		ECS	Plan B: Arcadia

\*Other than Embarq Florida, Inc. service area.

GENERAL EXCHANGE TARIFF

Embarq Florida, Inc.

By: F. B. Poag  
Director

SECTION A3  
Fifth Revised Sheet 17  
Cancelling Fourth Revised Sheet 17  
Effective: November 12, 2004

BASIC LOCAL EXCHANGE SERVICE

RESERVED FOR FUTURE USE

GENERAL EXCHANGE TARIFF

Embarq Florida, Inc.

By: F. B. Poag  
Director

SECTION A3  
Fourth Revised Sheet 18  
Cancelling Third Revised Sheet 18  
Effective: November 12, 2004

BASIC LOCAL EXCHANGE SERVICE

RESERVED FOR FUTURE USE

GENERAL EXCHANGE TARIFF

Embarq Florida, Inc.

By: F. B. Poag  
Director

SECTION A3  
Fifth Revised Sheet 19  
Cancelling Fourth Revised Sheet 19  
Effective: November 12, 2004

BASIC LOCAL EXCHANGE SERVICE

RESERVED FOR FUTURE USE

GENERAL EXCHANGE TARIFF

Embarq Florida, Inc.

By: F. B. Poag  
Director

SECTION A3  
Fifth Revised Sheet 20  
Cancelling Fourth Revised Sheet 20  
Effective: November 12, 2004

BASIC LOCAL EXCHANGE SERVICE

RESERVED FOR FUTURE USE

GENERAL EXCHANGE TARIFF

Embarq Florida, Inc.

By: F. B. Poag  
Director

SECTION A3  
Fifth Revised Sheet 21  
Cancelling Fourth Revised Sheet 21  
Effective: November 12, 2004

BASIC LOCAL EXCHANGE SERVICE

RESERVED FOR FUTURE USE

GENERAL EXCHANGE TARIFF

Embarq Florida, Inc.

By: F. B. Poag  
Director

SECTION A3  
Third Revised Sheet 22  
Cancelling Second Revised Sheet 22  
Effective: September 9, 2003

BASIC LOCAL EXCHANGE SERVICE

B. COMPANY-WIDE RATE GROUPS

3. Regrouping Procedures

The rate group in which an exchange falls shall be determined by the peak number of access lines in the exchange's local calling area since the effective date of the preceding directory.

GENERAL EXCHANGE TARIFF

Embarq Florida, Inc.

By: F. B. Poag  
Director

SECTION A3  
Fourth Revised Sheet 23  
Cancelling Third Revised Sheet 23  
Effective: November 1, 2005

BASIC LOCAL EXCHANGE SERVICE

C. DIALING PLANS

1. EAS - Extended Area Service

Telephone service which is provided under tariff whereby subscribers of a given exchange may complete and receive calls from one or more exchanges without the application of long distance message telecommunications charges.

2. \$.20 EAS

a. Calls from the referenced exchange to any exchange listed, but not shown in the corresponding local calling area, will be charged at the following rates:

- 1) Residence Service: \$.20 per completed call,\* unlimited duration
- 2) Business Service: \$.20 per completed call up to a total of 60 minutes per message. Usage exceeding the sixty minutes per message limit will be charged for on a usage basis at the long distance message rates shown in A18.

b. For calls from the Tallahassee exchange to the Chattahoochee exchange, see note on Sheet 14 of this section.

\* Residential customer calls under this plan will be based on an allowance of five (5) calls for all applicable routes in the aggregate. This allowance applies on a per account basis per month.



## GENERAL EXCHANGE TARIFF

Embarq Florida, Inc.

By: F. B. Poag  
Director

SECTION A3  
Fourth Revised Sheet 24  
Cancelling Third Revised Sheet 24  
Effective: November 1, 2005

### BASIC LOCAL EXCHANGE SERVICE

#### C. DIALING PLANS

##### 3. ECS - Extended Calling Scope

Also called Message Rate Plan, this plan was instituted in Docket No. 891239-TL, Order No. 24595, and established a \$.25\* per call message rate plan for exchanges with rate centers within a 1-10 mileage band of each other. The plan may also be established for exchanges with rate centers over 11 miles, with the approval of the Florida Public Service Commission.

Each call between the designated exchanges listed under Plan A will be charged for at a flat rate of \$.25 per call of unlimited duration. Such calls will be dialed as seven-digit local calls where the involved exchanges are in the same NPA. Where the exchanges are in different NPA's, the plan may be implemented on a 10 digit basis due to NXX code conflicts. This rate is applicable to both residential and business customers.

Plan A includes calls dialed or placed through an operator from all single party access lines, rotary lines, Centrex lines, PBX trunks, SmallTalk access lines and pay telephone lines. Plan A calls placed from SmallTalk access lines and message-rated PBX trunks will be assessed \$.25 per call; such calls are not included in call allowances. Calls placed as landline-to-mobile will be billed at \$.25 per call unless the mobile carrier subscribes to the landline-to-mobile reverse billing option in Section A25, G. Of this tariff. Operator assisted local call charges are applicable to plan calls placed through an operator.

Plan B routes include calls dialed and placed from all residential access lines, residential rotary, residential Centrex, SmallTalk and residential PBX to be billed at a flat rate of \$.25 per call\* regardless of duration. Calls dialed and placed from business access lines, business rotary, business Centrex, pay telephones and business PBX will be billed at \$.10 for the first minute and \$.06 for each additional minute of use. Calls placed as landline-to-mobile will be billed at either \$.25\* per call for residential services or \$.10/.06 per minute for business services unless the mobile carrier subscribes to the landline-to-mobile reverse billing option in Section A25 I. of this tariff. Operator assisted local call charges are applicable to plan calls placed through an operator.

\* Residential customer calls under this plan will be based on an allowance of five (5) calls for all applicable routes in the aggregate. This allowance applies on a per account basis per month.

## GENERAL EXCHANGE TARIFF

Embarq Florida, Inc.

By: F. B. Poag  
Director

SECTION A3  
Third Revised Sheet 25  
Cancelling Second Revised Sheet 25  
Effective: April 17, 2000

### BASIC LOCAL EXCHANGE SERVICE

#### C. DIALING PLANS

##### 3. ECS - Extended Calling Scope (Cont'd)

Plan C routes include one-way interLATA calls dialed and placed from all single party access lines, rotary lines, Centrex lines, PBX trunks, SmallTalk access lines and pay telephone lines to be billed on a usage-sensitive rate of \$.10 for the first minute of use and \$.06 for each additional minute of use. Calls placed as landline-to-mobile will be billed on a usage-sensitive rate of \$.10 for the first minute of use and \$.06 for each additional minute of use. Operator assisted local call charges are applicable to plan calls placed through an operator.

PATS phones utilizing the B-1 rate option will be assessed normal PATS usage charges on calls placed over ECS routes for Plan A, Plan B and Plan C.

Calls between ECS route exchanges will be considered local and will be charged for under the appropriate ECS plan rate.

##### 4. TOLL-PAC

- a. TOLL-PAC (Toll-Personalized Area Calling) is a one-way calling plan which allows a subscriber the option of placing toll calls to nearby communities with a discount of 30% applied to the direct dial rate as appropriate for the period in which the call was made. This service is an alternative to the toll rates which would normally apply for such calls.

GENERAL EXCHANGE TARIFF

Embarq Florida, Inc.

By: F. B. Poag  
Director

SECTION A3  
Second Revised Sheet 26  
Cancelling First Revised Sheet 26  
Effective: May 29, 1997

BASIC LOCAL EXCHANGE SERVICE

C. DIALING PLANS

4. TOLL-PAC (Cont'd)

- b. When a customer elects to subscribe to TOLL-PAC, the rate remains in effect for a minimum of one billing cycle period for that customer. Thereafter, it will remain in effect until discontinued by the customer with such ending period coinciding with the customer's billing cycle.
- c. The service is available only to one-party services. It is not available to PATS or FX services.
- d. As covered in other Sections of this Tariff, the resale of this service is not permitted.
- e. Rates
  - 1) A Secondary Service Ordering Charge as specified in Section A4 will apply for changes to and from the service except as provided in 2) following. The Charge will apply on a per account basis.

GENERAL EXCHANGE TARIFF

Embarq Florida, Inc.

By: F. B. Poag  
Director

SECTION A3  
Second Revised Sheet 27  
Cancelling First Revised Sheet 27  
Effective: May 29, 1997

BASIC LOCAL EXCHANGE SERVICE

C. DIALING PLANS

4. TOLL-PAC (Cont'd)

e. Rates

- 2) The Company will waive the Secondary Service Ordering Charge for exchange subscribers for a period of thirty (30) days following notification to customers that the TOLL-PAC plan will be implemented within their exchange as ordered by the Florida Public Service Commission. In addition, if also ordered by the Commission, the Secondary Service Ordering Charge will be waived for a second period of thirty (30) days after customers who could benefit from the plan have been identified and notified as to their potential savings with TOLL-PAC. Such benefiting customers will be identified through studies conducted by the Company of the preceding six (6) month toll calling habits.
- 3) Minimum monthly rates, as indicated, will apply for point-to-point or for each point to multi-point service.

f. United Telephone Exchanges

<u>Rate Step</u>	<u>Route Distance</u>	<u>Minimum Rate Per Month Per Account</u>	
		<u>RES</u>	<u>BUS</u>
2	11-22	\$3.25	\$5.85
3	23-55	5.30	9.40

GENERAL EXCHANGE TARIFF

Embarq Florida, Inc.

By: F. B. Poag  
Director

SECTION A3  
Second Revised Sheet 28  
Cancelling First Revised Sheet 28  
Effective: May 29, 1997

BASIC LOCAL EXCHANGE SERVICE

C. DIALING PLANS

4. TOLL-PAC (Cont'd)

g. Central Telephone Exchanges

Kingsley Lake to Jacksonville  
Residence and Business

\$3.12

5. OELC - Optional Extended Local Calling

a. General

- 1) Optional Extended Local Calling (OELC) is an optional two-way calling plan available to customers in the exchanges listed under OELC in B.2. previously.
- 2) OELC permits exchange subscribers to place and receive unlimited toll-free calls to and from the selected exchange which is outside the subscriber's normal local calling area for a monthly rate as specified following. This rate is in addition to the applicable local exchange rate with which OELC is associated.
  - a) Calls eligible under this plan are those which are direct dialed either from the access line arranged for OELC to the selected exchange or from the selected exchange to the access line arranged for OELC, except as identified in paragraphs c), d) and e) following.
  - b) OELC service does not include calls to or from those other exchanges which are considered within the local calling scope of the selected exchange.

GENERAL EXCHANGE TARIFF

Embarq Florida, Inc.

By: F. B. Poag  
Director

SECTION A3  
Second Revised Sheet 29  
Cancelling First Revised Sheet 29  
Effective: May 29, 1997

BASIC LOCAL EXCHANGE SERVICE

C. DIALING PLANS

5. OELC (Cont'd)

a. General (Cont'd)

2) Cont'd.

- c) Credit card calls and calls that require the assistance of an operator for completion are not eligible under the OELC plan. Such calls will be charged for at the appropriate long distance rate except that an operator will reestablish an eligible call that is interrupted due to facilities or poor transmission.
- d) Calls from coin telephones in the selected exchange to access lines arranged for OELC are not eligible under this plan. Such calls will be charged for at the appropriate long distance rate. The operator, at the time the call is placed, does not have the capability of determining which access lines are arranged for OELC.
- e) Calls from hotel/motel guest rooms in the selected exchange to access lines arranged for OELC will be quoted the appropriate long distance rate at the time the call is placed. The operator does not have the capability of determining which access lines are arranged for OELC and will quote time and charges as they would for any toll call.

GENERAL EXCHANGE TARIFF

Embarq Florida, Inc.

By: F. B. Poag  
Director

SECTION A3  
Second Revised Sheet 30  
Cancelling First Revised Sheet 30  
Effective: May 29, 1997

BASIC LOCAL EXCHANGE SERVICE

C. DIALING PLANS

5. OELC (Cont'd)

a. General (Cont'd)

2) Cont'd.

f) When a subscriber to rotary service requests OELC, the last line in the rotary group will be the first line so arranged; the next-to-last line will be second, and so on. Each line arranged for OELC will be charged for at the appropriate rate.

3) OELC is not offered to pay telephones or FX service or to resellers.

b. Directory Listing

1) Subscribers to OELC are entitled to one listing in the telephone directory of the selected exchange at no charge. This is in addition to their regular exchange directory listing.

2) Such listing will contain a line of information sufficient to advise callers in the selected exchange that the subscriber to OELC can be called toll-free on a direct dialed basis. The choice of wording in the line of information rests entirely with the Company.

GENERAL EXCHANGE TARIFF

Embarq Florida, Inc.

By: F. B. Poag  
Director

SECTION A3  
Second Revised Sheet 31  
Cancelling First Revised Sheet 31  
Effective: May 29, 1997

BASIC LOCAL EXCHANGE SERVICE

C. DIALING PLANS

5. OELC (Cont'd)

b. Directory Listing (Cont'd)

3) Due to the nature of the service, subscribers to OELC who are listed in the selected exchange directory will have their telephone number changed with no referral of calls if the OELC service is discontinued for other than a complete disconnect of exchange service during the life of the directory containing the OELC listing.

4) Additional listings and additional line matter are available at rates specified in A6 of this tariff.

c. OELC is available for calling from Ocala to Williston and from Williston to Ocala.

d. Rates

1) A Secondary Service Ordering Charge will be applicable for changes to and from OELC except that the Company will waive the charge for a 90 days period following the effective date of any new routes in this tariff.

2) The Secondary Service Ordering Charge is not applicable if the customer subscribes to OELC with initial service installation.



GENERAL EXCHANGE TARIFF

Embarq Florida, Inc.

BY: F. B. Poag  
Director

SECTION A3  
Ninth Revised Sheet 32  
Cancelling Eighth Revised Sheet 32  
Effective: November 12, 2004

BASIC LOCAL EXCHANGE SERVICE

C. DIALING PLANS (Cont'd)

5. OELC (Cont'd)

d. Rates

3)		<u>1-pty</u>	<u>Rotary</u>	<u>PBX</u>
	Ocala to Williston			
	Residence	\$ 6.25	7.30	
	Business	\$13.95	\$17.95	21.60
	Williston to Ocala			
	Residence	\$ 8.25	10.00	
	Business	\$16.95	\$23.95	30.05

6. OEAS Optional Extended Area Service

- a. OEAS is a one-way optional calling plan offered by the company to subscribers in the exchanges specified in this section. OEAS provides alternative billing for direct distance dialed (DDD) calls to an exchange beyond the subscriber's local calling area but within the same LATA.

A customer with multiple access lines, subscribing to OEAS, will be billed a monthly minimum charge for each access line.

- b. Options I, III and IV of the OEAS plan are available only to subscribers with residential access lines. Option II is available to both residential and business access line services.
- c. OEAS is not offered in conjunction with FX service, pay telephone service, Shared Tenant Services, guest and patient lines which terminate in hotels, motels, nursing homes or hospitals, nor any other form of resold service.
- d. OEAS does not include calls to other exchanges which are considered within the local calling scope of the additive exchange.

GENERAL EXCHANGE TARIFF

Embarq Florida, Inc.

By: F. B. Poag  
Director

SECTION A3  
Fourth Revised Sheet 33  
Cancelling Third Revised Sheet 33  
Effective: October 1, 1999

BASIC LOCAL EXCHANGE SERVICE

C. DIALING PLANS (Cont'd)

6. OEAS Optional Extended Area Service (Cont'd)

- e. Suspension of service is permitted for lines arranged for OEAS at the rates and regulations prescribed in Section A2 of this tariff.
- f. Credit card calls and calls that require the assistance of an operator for completion are not eligible under the OEAS plan. Such calls will be charged for at the appropriate long distance rate except that an operator will re-establish an eligible call that is interrupted due to facilities or poor transmission.
- g. Options
  - 1) Residence and business subscribers in exchanges where OEAS has been approved by the Florida Public Service Commission may select from the following options at rates specified following.
    - a) Option I, III and IV - Available to residential access lines only. With Option I and III, subscribers pay a monthly flat rate (i.e., the per line monthly minimum) and receive a block of time. The customer may use the block of time to make calls to the specified exchange. If the entire block of time is not used, the customer will be billed only the monthly minimum. Additional usage, in excess of the monthly minimum, is billed on a per minute of use basis. With Option IV, subscribers pay a monthly flat rate and receive unlimited calling to the specified exchange.

GENERAL EXCHANGE TARIFF

Embarq Florida, Inc.

By: F. B. Poag  
Director

SECTION A3  
Fourth Revised Sheet 34  
Cancelling Third Revised Sheet 34  
Effective: October 1, 1999

BASIC LOCAL EXCHANGE SERVICE

C. DIALING PLANS

6. OEAS (Cont'd)

g. Options (Cont'd)

1) (Cont'd)

b) Option II - Available to residence and business access lines. Option II provides a 50% discount from applicable DDD rates for calls placed to a specific exchange. Subscribers to Option II will be billed a minimum monthly charge per account. If total discounted toll charges to the specified exchange are less than the monthly minimum, the subscriber will be billed only the monthly minimum. Total discounted toll charges to the specified exchange that are equal to or greater than the monthly minimum will be billed the total discounted toll charges, not the monthly minimum.

2) All Options are offered subject to the availability of facilities and as authorized by the Florida Public Service Commission.

GENERAL EXCHANGE TARIFF

Embarq Florida, Inc.

By: F. B. Poag  
Director

SECTION A3  
First Revised Sheet 34.1  
Cancelling Original Sheet 34.1  
Effective: October 1, 1999

BASIC LOCAL EXCHANGE SERVICE

C. DIALING PLANS

6. OEAS (Cont'd)(M)

h. Rates and Charges

- 1) The rates for OEAS Options I, II, III, and IV are in addition to the rates and charges applicable to the basic local exchange service with which the options are associated.

If a customer subscribes to OEAS Options I, III or IV and the customer has more than one access line on the same account, each access line will be billed a monthly minimum charge. For example, a customer with two access lines subscribing to Option I is billed two \$2.00 monthly minimum charges totalling \$4.00 and has available 60 minutes for each line totalling 120 minutes that can be originated from either line.

- 2) During the six month period following the effective date of each authorized OEAS plan, the secondary service ordering charge will be waived for the initial subscription to one of the options and for one subsequent change.(M)

GENERAL EXCHANGE TARIFF

Embarq Florida, Inc.

By: F. B. Poag  
Director

SECTION A3  
Fourth Revised Sheet 35  
Cancelling Third Revised Sheet 35  
Effective: October 1, 1999

BASIC LOCAL EXCHANGE SERVICE

C. DIALING PLANS

6. OEAS (Cont'd)

h. Rates and Charges (Cont'd)

- 3) The rates for OEAS Options are shown in the following matrix. Option II rates for specific routes are based on the airline mileage between rate centers of the involved exchanges.

OPTION I, III and IV  
(Residence Only, Per Line)

Monthly Minimum	Block of Time	Additional Usage (in excess of block of time)
-----------------	---------------	---

<u>OPTION I</u> \$ 2.00	60 Minutes	\$.05 per minute
----------------------------	------------	------------------

<u>OPTION III</u> \$10.00	500 Minutes	\$.05 per minute
------------------------------	-------------	------------------

<u>OPTION IV</u> \$20.00	Unlimited	N/A
-----------------------------	-----------	-----

OPTION II  
(Residence and Business, Per Account)

OEAS Minimum Monthly Charge	Mileage <u>11-22</u>	Bands <u>23-55</u>
Residence	\$ 3.00	\$ 5.00
Business	6.00	10.00
PBX and Centrex	12.00	20.00

GENERAL EXCHANGE TARIFF

Embarq Florida, Inc.

By: F. B. Poag  
Director

SECTION A3  
Fifth Revised Sheet 36  
Cancelling Fourth Revised Sheet 36  
Effective: November 11, 2003

BASIC LOCAL EXCHANGE SERVICE

C. DIALING PLANS

6. OEAS (Cont'd)

h. Rates and Charges (Cont'd)

4) Authorized OEAS Exchange Routes

Options I, III and IV

West Kissimmee to Orlando	Option I only
Trilacoochee to Brooksville	Option I only
LaBelle to Fort Myers	Option I, III and IV
Wildwood to Leesburg	Option I only

Option II

LaBelle to Fort Myers	Residence	\$ 5.00
	Business	10.00
	PBX and Centrex	20.00

GENERAL EXCHANGE TARIFF

Embarq Florida, Inc.

By: F. B. Poag  
Director

SECTION A3  
Seventh Revised Sheet 37  
Cancelling Sixth Revised Sheet 37  
Effective: November 12, 2004

BASIC LOCAL EXCHANGE SERVICE

RESERVED FOR FUTURE USE

GENERAL EXCHANGE TARIFF

Embarq Florida, Inc.

By: F. B. Poag  
Director

SECTION A3  
Seventh Revised Sheet 38  
Cancelling Sixth Revised Sheet 38  
Effective: November 12, 2004

BASIC LOCAL EXCHANGE SERVICE

RESERVED FOR FUTURE USE



GENERAL EXCHANGE TARIFF

Embarq Florida, Inc.

By: F. B. Poag  
Director

SECTION A3  
Third Revised Sheet 38.1  
Cancels Second Revised Sheet 38.1  
Effective: November 12, 2004

BASIC LOCAL EXCHANGE SERVICE

C. DIALING PLANS

7. UNLIMITED CALLING – FLAT RATE

Unlimited Calling is a Flat Rate optional calling plan which allows customers unlimited intraLATA calling for a single monthly rate.

- a. Customers must subscribe to Integrated Services Digital Network – Primary Rate Interface II (ISDN-PRI II) as described in Section 29 or Individual Voice Channels for Custom Access Solutions or Digital Trunking Service described in Section 30.
- b. Unlimited calling – flat rate is available only between intraLATA exchanges with the 239, 863 and 941 NPAs (Area Codes).
- c. Operator assisted local call charges apply to calls placed through an operator.
- d. Rates

Monthly Recurring Rate

Per 1.544 Mbps Facility

\$100.00

GENERAL EXCHANGE TARIFF

Embarq Florida, Inc.

By: F. B. Poag  
Director

SECTION A3  
Second Revised Sheet 39  
Cancelling First Revised Sheet 39  
Effective: May 29, 1997

BASIC LOCAL EXCHANGE SERVICE

D. MONTHLY EXCHANGE RATES - BASIC SERVICES

The rates specified herein entitle the subscribers to an unlimited number of messages to all stations bearing the designation of central offices within the serving exchange and additional exchanges or portions of exchanges as shown preceding.

1. Residential

Service which is provided to private residences for the use of those occupying that dwelling.

2. SmallTalk

a. This service was formerly known as Option 30 in Central Telephone.

b. SmallTalk is a single-party local exchange access line service offered to residential subscribers only. Residential service is as defined above.

c. Subscribers to residence SmallTalk service are billed monthly in advance at the basic service rate specified herein. Messages in excess of the monthly allowance are billed monthly in arrears. Any message allowance not used in one month is not credit to the subscriber's account toward any other month.

GENERAL EXCHANGE TARIFF

Embarq Florida, Inc.

By: F. B. Poag  
Director

SECTION A3  
Second Revised Sheet 40  
Cancelling First Revised Sheet 40  
Effective: May 29, 1997

BASIC LOCAL EXCHANGE SERVICE

D. MONTHLY EXCHANGE RATES - BASIC SERVICES

2. SmallTalk (Cont'd)

d. Regulations

- 1) The rules and regulations of this tariff governing service to subscribers of flat rated access line services and flat- and message-rate service are also applicable to subscribers of SmallTalk.
- 2) SmallTalk is available only in areas served by digital central offices.
- 3) SmallTalk access lines are eligible for a reduction in rate for Vacation Service only as specified in Section A2 of this tariff.
- 4) The regulations regarding flat- and message-rate service in Section A2 are applicable to SmallTalk access lines.
- 5) SmallTalk charges are not applicable for calls to the Company business office, repair, 411, 911, N11, local 976 or the Company operator.

GENERAL EXCHANGE TARIFF

Embarq Florida, Inc.

By: F. B. Poag  
Director

SECTION A3  
Fourth Revised Sheet 41  
Cancelling Third Revised Sheet 41  
Effective: November 12, 2004

BASIC LOCAL EXCHANGE SERVICE

D. MONTHLY EXCHANGE RATES - BASIC SERVICES

2. SmallTalk (Cont'd)

e. Rates and Charges

- 1) Monthly rates are listed following.
- 2) The equivalent of \$3.00 per month in call allowance is provided with the basic SmallTalk service. Calls in excess of the \$3.00 allowance will be billed to the subscriber at the rate of \$.10 per call.
- 3) Calls to areas outside the subscriber's local exchange and EAS calling scope will be billed at the appropriate long distance rates. Such calls are not included in the monthly allowance calculation.
- 4) SmallTalk is not offered in conjunction with any other local or EAS alternative calling plan.

GENERAL EXCHANGE TARIFF

Embarq Florida, Inc.

By: F. B. Poag  
Director

SECTION A3  
Second Revised Sheet 41.1  
Cancelling First Revised Sheet 41.1  
Effective: May 10, 2002

BASIC LOCAL EXCHANGE SERVICE

D. MONTHLY EXCHANGE RATES - BASIC SERVICES

3. Residential, Key Line

Individual access lines terminating in CPE capable of multiple access line terminations.

4. Residential - Rotary

- a. Individual access lines arranged for rotary, level hunting or similar service which allows completion of an incoming call to a line that is called but in use, to another line, by utilizing central office equipment, will have a rate as specified following applicable to each line so arranged. This rotary rate is not applicable on PBX trunks, nor will it apply to access lines arranged for the Call Forwarding feature of Custom Calling Service, unless the line is also arranged for rotary service.
- b. Residential Rotary Line Service is limited to three lines in rotary. If more than three lines in rotary are required, Business Rotary Line rates will apply to all lines in rotary.

GENERAL EXCHANGE TARIFF

Embarq Florida, Inc.

By: F. B. Poag  
Director

SECTION A3  
Fourth Revised Sheet 42  
Cancelling Third Revised Sheet 42  
Effective: May 10, 2002

BASIC LOCAL EXCHANGE SERVICE

D. MONTHLY EXCHANGE RATES - BASIC SERVICES

6. Residential, Key Line - Rotary

- a. Individual access lines configured in central office provided rotary hunting and terminating in CPE capable of multiple access line terminations.
- b. Residential, Key Rotary Line Service is limited to three lines in rotary. If more than three lines in rotary are required, Business, Key Line Rotary rates will apply to all lines in rotary.

8. Business

Service which is primarily or substantially of a business, professional, institutional or otherwise occupational nature or where the listing required is such as to indicate business use.

GENERAL EXCHANGE TARIFF

Embarq Florida, Inc.

By: F. B. Poag  
Director

SECTION A3  
First Revised Sheet 42.1  
Cancelling Original Sheet 42.1  
Effective: October 13, 2000

BASIC LOCAL EXCHANGE SERVICE

D. MONTHLY EXCHANGE RATES - BASIC SERVICES

9. Business, Key Line

Individual access lines terminating in CPE capable of multiple access line terminations.

10. Business, Centrex Line

Individual access lines provided with central office based Centrex software.

11. Business - Rotary

Individual access lines arranged for rotary, level hunting or similar service which allows completion of an incoming call to a line that is called but in use, to another line, by utilizing central office equipment, will have a rate as specified following applicable to each line so arranged. This rotary rate is not applicable on PBX trunks, nor will it apply to access lines arranged for the Call Forwarding feature of Custom Calling Service, unless the line is also arranged for rotary service.

GENERAL EXCHANGE TARIFF

Embarq Florida, Inc.

By: F. B. Poag  
Director

SECTION A3  
Third Revised Sheet 43  
Cancelling Second Revised Sheet 43  
Effective: October 13, 2000

BASIC LOCAL EXCHANGE SERVICE

D. MONTHLY EXCHANGE RATES - BASIC SERVICES

12. Business, Key Line - Rotary

Individual access lines configured in central office provided rotary hunting and terminating in CPE capable of multiple access line terminations.

13. Business, Centrex Line - Rotary

Individual access lines provided with central office based Centrex software configured in central offices provided rotary hunting.

14. Trunks

a. PBX flat rates trunks are provided as inward, outward, or two-way.

b. Central Telephone - Eglin AFB -- One way trunks used for the completion of incoming toll calls to Eglin AFB will be provided at the rate found in D.16.n. following.

15. Trunks, Message Rate

PBX message rate trunks are provided to hotels, motels, apartment houses, or convalescent homes. In connection with message rate trunks, the management may separately contract for any form of business service for administrative use. Guests may separately and individually subscribe to any form of residence or business service. Message usage is accumulated on a group basis.

This service is only available in the United Telephone Orange City and Winter Park exchanges.



GENERAL EXCHANGE TARIFF

Embarq Florida, Inc.

BY: F. B. Poag  
Director

SECTION A3  
Twelfth Revised Sheet 44  
Cancelling Eleventh Revised Sheet 44  
Effective: November 1, 2005

BASIC LOCAL EXCHANGE SERVICE

D. MONTHLY EXCHANGE RATES - BASIC SERVICES

16. Rates and Charges

The rates specified herein entitle subscribers to an unlimited number of messages, unless otherwise specified to all stations bearing the designation of central office within the service exchange and additional exchanges or portions of exchanges as shown in B.2. preceding. Touch-Tone Service is included in these rates.

		Rate Groups				
		1	2	3	4	5
a.	Residential, Flat Rate	\$11.45	11.75	12.45	13.30	14.60
b.	SmallTalk, Residential Only	\$ 8.25	8.75	9.25	10.00	10.75
c.	Residential, Key Line	\$12.75	13.00	14.00	15.25	16.25
d.	Residential, Rotary, Flat Rate	\$14.75	15.50	16.00	16.50	17.75
e.	Residential, Rotary, Key Line	\$16.50	17.50	18.50	19.50	20.50

GENERAL EXCHANGE TARIFF

Embarq Florida, Inc.

BY: F. B. Poag  
Director

SECTION A3  
Ninth Revised Sheet 44.1  
Cancelling Eighth Revised Sheet 44.1  
Effective: November 1, 2005

BASIC LOCAL EXCHANGE SERVICE

D. MONTHLY EXCHANGE RATES - BASIC SERVICES (Cont'd)

16. Rates and Charges (Cont'd)

	Rate Groups				
	1	2	3	4	5
h. Business, Flat Rate	\$21.05	21.85	24.55	26.35	28.35
i. Business, Key Line	\$28.95	29.30	31.20	31.85	33.70
j. Business, Centrex Line 1) United Telephone	\$26.00	26.00	26.00	29.00	29.00
k. Business, Rotary, Flat Rate	\$29.35	29.90	32.90	35.25	38.90
l. Business, Rotary, Key Line	\$33.50	34.50	36.85	38.75	43.75
m. Business, Rotary, Centrex Line 1) United Telephone	\$30.00	30.00	33.00	35.00	39.00

GENERAL EXCHANGE TARIFF

Embarq Florida, Inc.

BY: F. B. Poag  
Director

SECTION A3  
Ninth Revised Sheet 45  
Cancelling Eighth Revised Sheet 45  
Effective: November 1, 2005

BASIC LOCAL EXCHANGE SERVICE

D. MONTHLY EXCHANGE RATES - BASIC SERVICES (Cont'd)

16. Rates and Charges (Cont'd)

	Rate Groups				
	1	2	3	4	5
n. Trunks, Flat Rate	\$35.75	36.95	41.50	43.65	49.75
1) Central Telephone -Eglin AFB	42.21				
o. Trunks, Message Rate					
1) First trunk, including 100 messages per month					
Orange City exchange only		\$39.70			
Winter Park exchange only		\$43.70			
2) Each additional trunk,					
Orange City exchange only		\$39.70			
Winter Park exchange only		\$43.70			
3) Messages in excess of allowance, each					
Orange City and Winter Park		\$ .07			

## GENERAL EXCHANGE TARIFF

Embarq Florida, Inc.

By: F. B. Poag  
Director

SECTION A3  
First Revised Sheet 45.1  
Cancelling Original Sheet 45.1  
Effective: November 1, 2005

### BASIC LOCAL EXCHANGE SERVICE

#### D. MONTHLY EXCHANGE RATES – BASIC SERVICES (Cont'd)

##### 16. Rates and Charges (Cont'd)

###### p. Term Discount Plan (TDP)

###### 1) General

- a) A Term Discount Plan (TDP) provides customers, who have five (5) or more lines/trunks at the same location and billed under a single bill or who have five (5) or more lines/trunks at different locations and billed under a single bill, with discounted rates for Business Flat Rate, Business Rotary Flat Rate, Business Key Lines, Business Rotary Key Lines, and Trunks Flat Rate. Fewer than five (5) lines/trunks billing under a single bill are not eligible for TDP rates, regardless of whether the customer subscribes to five (5) or more lines/trunks.
- b) Business Flat Rate, Business Rotary Flat Rate, Business Key Lines, Business Rotary Key Lines, and Trunks Flat Rate may be ordered under a TDP for fixed periods of two (2) years and three (3) years.
- c) The customer must specify the length of the initial service period at the time the service is ordered.
- d) At the end of the TDP commitment period the customer may subscribe to a new TDP at discounts on the prevailing rates as set forth in A3.p.3) following. If the customer does not contact the Company 90 days prior to the expiration of the TDP, the commitment period and the discount in effect at the time of expiration will automatically be extended for 12 months. The customer can terminate service at the end of the minimum commitment period with no penalty or obligation to continue the service.
- e) Rate increases or decreases will automatically be applied to the monthly term plan rates for the remaining term of the TDP. If a Company initiated rate increase causes the services under the TDP to increase by 10% or more annually, then the customer may cancel the TDP without incurring termination liability charges provided the customer notifies the Company within 30 days after the effective date of the rate increase.
- f) The customer can extend TDP commitment periods at any time during the term of the plan, up to a maximum of three years. The number of remaining months in the original term plan will apply toward the new term plan selected.

GENERAL EXCHANGE TARIFF

Embarq Florida, Inc.

By: F. B. Poag  
Director

SECTION A3  
First Revised Sheet 45.2  
Cancelling Original Sheet 45.2  
Effective: November 1, 2005

MISCELLANEOUS SERVICE ARRANGEMENTS

D. MONTHLY EXCHANGE RATES – BASIC SERVICES (Cont'd)

16. Rates and Charges (Cont'd)

p. Term Discount Plan (TDP) (Cont'd)

2) Termination Liability Charges

- a) If a customer under a Term Discount Plan (TDP) disconnects any portion of the Business Flat Rate, Business Rotary Flat Rate, Business Key Lines, Business Rotary Key Lines, and/or Trunks Flat Rate TDP service prior to the expiration of the TDP, then a Termination Liability Charge will apply to those services that are disconnected. The Termination Liability Charge will be a one-time charge equal to the sum of 50% of the payments for the remainder of the TDP. Should a customer drop below the line/trunk minimum requirement, the customer will no longer qualify for the TDP, and the remaining lines/trunks will default to the standard month-to-month rates effective with the disconnect date.

3) Discounts

	<u>Two Years</u>	<u>Three Years</u>
a) Business Flat Rate	10%	15%
b) Business Rotary Flat Rate	10%	15%
c) Business, Key Line	10%	15%
d) Business, Rotary, Key Line	10%	15%
e) Trunks, Flat Rate	10%	15%

GENERAL EXCHANGE TARIFF

Embarq Florida, Inc.

By F. B. Poag  
Director

SECTION A3  
Second Revised Sheet 46  
Cancelling First Revised Sheet 46  
Effective: May 29, 1997

BASIC LOCAL EXCHANGE SERVICE

E. LOCAL EXCHANGE EXCEPTIONS

1. Tallahassee Exchange

Calls to the Chattahoochee exchange from the Tallahassee exchange will be based upon an allowance of five (5) free calls in the aggregate per month with a charge of twenty cents (\$.20) per call to apply to each additional call above five (5).

2. Williston Exchange

- a. The subscribers listed below are within BellSouth's Bronson exchange boundary. Present service is being provided from United's Williston exchange. This service will be continued to these customers until such time that it is discontinued, moved or changed to a different class of service.

Paul R. Martin	352/528-2584
A. Martin	Nonpublished
Joel & June Martin	352/528-0616

- b. The subscribers listed below are within BellSouth's Dunnellon exchange boundary. Present service is being provided from United's Williston exchange. This service will be continued to these customers until such time that it is discontinued, moved or changed to a different class of service.

S. & L. Madeiros	352/528-6842
E. Skumanich	352/528-4745
J. W. Reynolds	352/528-3678
K. & S. Fackler	352/528-6620
J. Lloyd	352/528-0196
T. & D. Fackler	352/528-6017

GENERAL EXC.HANGE TARIFF

Embarq Florida, Inc.

SECTION A3

BY: F. B. Poag  
Director

Tenth Revised Sheet 47  
Cancelling Ninth Revised Sheet 47  
Effective: November 1, 2005

BASIC LOCAL EXCHANGE SERVICE

E. LOCAL EXCHANGE EXCEPTIONS (Cont'd)

3. Pine Island Exchange: Useppa Island

- a. Except as otherwise provided, the rates and regulations contained in the General Exchange Tariff apply in this exception area.
- b. The telephone rates specified hereunder entitle the subscriber to an unlimited number of local telephone messages to all stations bearing the designation of Pine Island, Fort Myers, Fort Myers Beach, North Fort Myers, Cape Coral, North Cape Coral, and Sanibel-Captiva Islands exchanges.
- c. A map showing the Exception Area is filed in Supplemental Section A3.
- d. Each customer will be required to make a contribution for construction for the first five years that customer location has service. This contribution for construction will apply for service provided through the originally placed, or replaced, cable pairs which number 100.
- e. Within this Exception Area, the following access line rates apply:

	<u>Business</u>	<u>Residence</u>
Individual Line	\$36.35	\$23.30
Individual Line, Rotary	45.25	26.50
PBX Trunk	53.65	
SmallTalk		20.00
Centrex	37.00	28.00
Centrex, Rotary	46.95	28.25
Key Line	41.85	25.25
Key Line, Rotary	48.75	29.50
Pay Telephone Service (PATS)	36.35 plus PATS usage	
Network Access Registers (NAR) per Register	33.20	
Off Premises Extension	35.00	20.00

- f. A special trip charge of \$35 will apply in addition to the connection charges specified within this tariff.

GENERAL EXCHANGE TARIFF

Embarq Florida, Inc.

By: F. B. Poag  
Director

SECTION A3  
Second Revised Sheet 48  
Cancelling First Revised Sheet 48  
Effective: May 29, 1997

BASIC LOCAL EXCHANGE SERVICE

E. LOCAL EXCHANGE EXCEPTIONS

3. Pine Island Exchange: Useppa Island (Cont'd)
- g. Throughout the exception area, the rates for service not specifically shown in this section are given in the General Exchange Tariff.

4. Punta Gorda Exchange

- a. The subscribers listed below are within the Punta Gorda exchange boundary. Present service is being provided from the Pine Island exchange. This service will be continued to these customers until such time that it is discontinued, moved or changed to a different class of service.

Coward Burdette & Co. Farms 941/283-1021

5. Sanibel-Captiva Islands Exchange: North Captiva Island

- a. Except as otherwise provided, the rates and regulations contained in the General Exchange Tariff apply in this exception area.
- b. The telephone rates specified hereunder entitle the subscriber to an unlimited number of local telephone messages to all stations bearing the designation of Sanibel-Captiva Islands, Fort Myers, Fort Myers Beach, North Fort Myers, Cape Coral, North Cape Coral, and Pine Island exchanges.
- c. A map showing the Exception Area is filed in Supplemental Section A3.
- d. Each customer will be required to make a contribution for construction for the first five years that customer location has service. This contribution for construction will apply for service provided through the originally placed, or replaced, cable pairs which number 200.



GENERAL EXCHANGE TARIFF

Embarq Florida, Inc.

BY: F. B. Poag  
Director

SECTION A3  
Tenth Revised Sheet 49  
Cancelling Ninth Revised Sheet 49  
Effective: November 1, 2005

BASIC LOCAL EXCHANGE SERVICE

E. LOCAL EXCHANGE EXCEPTIONS (Cont'd)

5. Sanibel-Captiva Islands: North Captiva Island (Cont'd)

e. Within this Exception Area, the following access line rates apply:

	<u>Business</u>	<u>Residence</u>
Individual Line	\$36.35	\$23.30
Individual Line, Rotary	45.25	26.50
PBX Trunk	53.65	
SmallTalk		20.00
Centrex	37.00	28.00
Centrex, Rotary	46.95	28.25
Key Line	41.85	25.25
Key Line, Rotary	48.75	29.50
Pay Telephone Service (PATS)	36.35 plus PATS usage	
Network Access Registers (NAR) per Register	33.20	
Off Premises Extension	35.00	20.00

f. A special trip charge of \$35 will apply in addition to the connection charges specified within this tariff.

g. Throughout the exception area, the rates for service not specifically shown in this section are given in the General Exchange Tariff.

GENERAL EXCHANGE TARIFF

Embarq Florida, Inc.

SECTION A3

By: F. B. Poag  
Director

Third Revised Sheet 50  
Cancelling Second Revised Sheet 50  
Effective: November 12, 2004

BASIC LOCAL EXCHANGE SERVICE

E. LOCAL EXCHANGE EXCEPTIONS

6. Tavares Exchange

The subscriber listed below is within the Tavares exchange boundary. Present service to this subscriber is provided from the Mount Dora exchange. This service will be continued to this subscriber until such time that it is discontinued, moved, or changed to a different class of service.

R. Pike 352/383-4890

7. Lake Placid Exchange

The subscriber listed below is within the Lake Placid exchange boundary. Present service to this subscriber is provided from the Spring Lake exchange. This service will be continued to this subscriber until such time that it is discontinued, moved, or changed to a different class of service.

F. L. Evans 941/655-1480

8. Wildwood Exchange

The subscribers listed below are within the Wildwood exchange boundary. Present service to these subscribers is provided from the Leesburg exchange. This service will be continued to this subscriber until such time that it is discontinued, moved, or changed to a different class of service or until October 2, 1994, whichever comes first, per Order No. 22028.

Randall Lacy	352/787-6289
Charles White	352/728-5404
Tommie Lewis	352/787-5499
Richard Brooke	352/728-4401
Antonio Geraci	352/787-3208
Frank G. Jagers	352/787-1358
C. G. Hunnewell	352/728-5202
James Hagan, Sr.	352/787-6988
L. & S. Maddox	352/787-5159
Howard Oakly	352/787-3324

GENERAL EXCHANGE TARIFF

Embarq Florida, Inc.

BY: F. B. Poag  
Director

SECTION A3  
Ninth Revised Sheet 50.1  
Cancelling Eighth Revised Sheet 50.1  
Effective: November 12, 2004

BASIC LOCAL EXCHANGE SERVICE

RESERVED FOR FUTURE USE

GENERAL EXCHANGE TARIFF

Embarq Florida, Inc.

BY: F. B. Poag  
Director

SECTION A3  
Fourth Revised Sheet 50.2  
Cancelling Third Revised Sheet 50.2  
Effective: August 8, 2003

BASIC LOCAL EXCHANGE SERVICE

E. LOCAL EXCHANGE EXCEPTIONS

10. Lady Lake Exchange

The subscriber listed below is within the Lady Lake exchange boundary. Present service to this subscriber is provided from the Belleview exchange. This service will be continued to this subscriber until such time that it is discontinued, moved or changed to a different class of service.

Florida Power Sub-Station                      352/307-1334

The subscribers listed below are within the Lady Lake exchange boundary. Present service to these subscribers is provided from the Wildwood exchange. This service will be continued to these subscribers until such time that it is discontinued, moved or changed to a different class of service.

Tony Hendrix	330-0126
Carl Bowling	330-0126
W. Lord Lyall IV	330-0166, 330-0250
Eusebio Rodriguez	330-0264
James H. Cason II	330-0419, 748-3842
Donald B. Smith	330-0571
Otilio Acevedo	330-0924
Charles & Julie Cooper	330-0925
Richard Leppala, Jr.	330-1575
Donald Stover	330-2046
Robert J. Tennison	330-2327
Palma Ruspoli	330-2590
June & Rod McKie	689-0038, 689-0039
Saul Mauricio Arias & Sandra Stringer	689-0176
Ray Alford	748-0118, 748-0095
Winston Bailey	748-0131
Ashley Sands	748-0331
WHOF Radio	748-0359
A. J. Brown	748-0359
Marcia Brown	748-0407
Richard Leppala	748-0441, 748-5994
Donald M. & Vista Bass	748-0885, 748-6675
Keith Myles	748-0949
R.M. Word	748-1028
T. M. Massey	748-1378

GENERAL EXCHANGE TARIFF

Embarq Florida, Inc.

BY: F. B. Poag  
Director

SECTION A3  
First Revised Sheet 50.2.1  
Cancelling Original Sheet 50.2.1  
Effective: August 8, 2003

BASIC LOCAL EXCHANGE SERVICE

E. LOCAL EXCHANGE EXCEPTIONS

10. Lady Lake Exchange (Cont'd)

Carl & Joan Bowling	748-1788, 748-6209, 748-2491, 748-4400
H. C. Connell	748-1975
James Q. Roop	748-2356
J. I. Young	748-2401
James Young	748-2402
Roy L. Brown	748-2756
Carol Lee Lindberg	748-2760
J. D. Stafford	748-3235
C. John Coniglio	748-3408
William & Manulani Lyall	748-3434, 748-1202, 748-0285
Bernard E & Judith A. Bradley	748-4078
Herbert & Mollie Manulkin	748-4339
Jim Bailey	748-4538
Donna Demascio	748-4612
R. Wayne & Linda Gay	748-4755
Billy & Betty Cooper	748-4778
Kenneth Pate	748-5033
Minola Jenkins	748-5882
Kenneth & Wanda Roop	748-6298, 748-6070
Linda Gay	748-6355
Shady Oaks Produce	748-6707
Edward Boscana	748-6974
Lakes & Live Oaks Home Owners	748-6985
Donald Phelps	748-7408, 748-2879
Villages of Lady Lake	748-7720
Carol Lindberg	748-7906
Andrew Moran	748-8136

GENERAL EXCHANGE TARIFF

Embarq Florida, Inc.

BY: F. B. Poag  
Director

SECTION A3  
Third Revised Sheet 50.3  
Cancels Second Revised Sheet 50.3  
Effective: January 2, 2004

BASIC LOCAL EXCHANGE SERVICE

E. LOCAL EXCHANGE EXCEPTIONS (Cont'd)

11. Baker Exchange

The subscriber listed below is within BellSouth's Munson exchange boundary. Present service is being provided from the Company's Baker exchange. This service will be continued to this customer until such time that it is discontinued, moved or changed to a different class of service.

John Hodges 850/537-7696

12. North Naples Exchange

The subscribers listed below are within the North Naples exchange boundary. Present service to these subscribers is provided from the Bonita Springs exchange. This service will be continued to these customers until such time that it is discontinued, moved or changed to a different class of service.

David & Sheila Quinn 941/992-9231, 941/992-1036  
Lynn L. Hardesty 941/947-1147

13. Wildwood Exchange

The subscribers listed below are within the Wildwood exchange boundary. Present service to these subscribers is provided from the Lady Lake exchange. This service will be continued to these customers until such time that it is discontinued, moved or changed to a different class of service.

Andrew Moran 352/751-0405  
H. Gary Morse 352/751-0395, 352/751-0396, 352/751-0397  
352/751-0398  
Mark G. Morse 352/751-0392, 352/751-0394  
Richard Schwartz 352/751-0401, 352/751-0402, 352/751-0403

14. Naples Exchange

The subscribers listed below are within the Naples exchange boundary. Present service to these subscribers is provided from the Immokalee exchange. This service will be continued to these customers until such time that it is discontinued, moved or changed to a different class of service.

Collier; Pacific Grower  
Partnership 239/658-6064, 239/657-2386, 239/658-6065  
Jose I. Vega 239/657-9536  
Agmart Farm 239/657-7211, 239/657-7411

GENERAL EXCHANGE TARIFF

Embarq Florida, Inc.

BY: F. B. Poag  
Director

SECTION A3  
First Revised Sheet 50.4  
Cancelling Original Sheet 50.4  
Effective: September 15, 2004

BASIC LOCAL EXCHANGE SERVICE

E. LOCAL EXCHANGE EXCEPTIONS (Cont'd)

15. Destin

The subscribers listed below are within the Destin exchange boundary. Present service to these subscribers is provided from the Santa Rosa Beach exchange. This service will be continued to these customers until such time that it is discontinued, moved or changed to a different class of service.

.1 Residence Customers

Abbott, Stephen	850/622-5959
Abercrombie, James	850/267-1609
Abruzzo, Joe & Pat	850/267-3590
Adams, J	850/622-0777
Adolph, Joan	850/267-1837
Albrecht, Tom	850/622-0131, 850/622-0214
Alford, John & Kimberly	850/622-1512
Alini, T	850/267-0456, 850/267-8405, 850/267-8415
Anderson, David & Pam	850/267-0312
Anderson, James	850/622-1352
Anderson, Terry & Jan	850/622-0515
Andreas Leanne	850/267-2634
Andrews, Margaret	850/622-0881
Andrulot, J	850/622-1760
Angeloni, Paul	850/267-3107, 850/622-5166
Araguel, Jane	850/622-5714
Archer, Bob & Susan	850/267-2834
Argo, Stan	850/622-2759
Armentor, Glenn & Dana	850/622-0646, 850/622-0647
Armstrong, Whit	850/267-0283
Arnold, David H	850/622-5109
Arthurs, Ted G	850/267-1226
Ashley, Bart	850/267-0213
Ausetts, Duane J	850/622-9139
Ausley, Carolyn & Joe	850/622-2114, 850/622-2115
Averbuch, Jerome	850/267-2314
Baake, Thomas	850/622-5711
Bash, J	850/622-0939
Bacon, Larry S	850/267-6032, 850/267-9913
Bailey, Edgar H	850/622-0153
Bain, Clarence D Jr	850/267-0272
Baird, M	850/267-2119
Baity, John & Patricia	850/622-5640
Baker, Nell S	850/267-5676

GENERAL EXCHANGE TARIFF

Embarq Florida, Inc.

BY: F. B. Poag  
Director

SECTION A3  
First Revised Sheet 50.5  
Cancelling Original Sheet 50.5  
Effective: September 15, 2004

BASIC LOCAL EXCHANGE SERVICE

E. LOCAL EXCHANGE EXCEPTIONS (Cont'd)

15. Destin (Continued)

.1 Residence Customers (Continued)

Baker, Richard C & Iris	850/267-1146
Bakken, Richard C & Sharel	850/622-6209
Banning, Max & Linda	850/267-3980
Barnette, Jay	850/622-5743
Barone, Steve	850/622-1157
Barreca, Ronald & Sharon	850/622-1884
Barry, Marguerite	850/267-1354
Barth, Daniel	850/267-0353
Bartosic, Thomas & Sheila	850/267-9542
Bass, Martha	850/267-1998
Baucom, Robert	850/622-5126
Baudin, Claude	850/267-2947
Bauman, Billy	850/267-0401
Bayles, Jerry	850/267-0532, 850/267-6085
Beal, W Milton	850/622-1380
Beale, Howard & Mona	850/267-3752
Beals, George	850/622-2381
Beals, Pat	850/622-1279
Beam, Larry G	850/622-9141
Bean, Danette & Skip	850/267-2927
Beardsley, Charlie & Betty	850/267-1614
Beaty, James & Terry	850/267-0128
Beers, Michael B	850/267-2025
Behr, George	850/267-2791
Beith, Mitch	850/622-9515
Beith, Mitch & Tammy J	850/622-9516
Belisle, Mark E	850/622-0273
Belk, Michael	850/622-0194, 850/622-1204
Bell, William & Joni L	850/267-0628, 850/267-1251
Belser, Bruce	850/267-5609
Bender, Juanita	850/622-1272
Berberich, William & Lois	850/622-1855, 850/622-9503
Berkley, Michael & Johnna	850/622-1709
Berres, Gerald	850/267-3041
Berrigan, Mariann	850/622-1969, 850/622-1976
Bairdsell, Gaetana	850/622-1411
Bickelhaup, Steve	850/622-0038
Bielawski, Jerry	850/267-3524, 850/622-1683



GENERAL EXCHANGE TARIFF

Embarq Florida, Inc.

BY: F. B. Poag  
Director

SECTION A3  
First Revised Sheet 50.6  
Cancelling Original Sheet 50.6  
Effective: September 15, 2004

BASIC LOCAL EXCHANGE SERVICE

E. LOCAL EXCHANGE EXCEPTIONS (Cont'd)

15. Destin (Continued)\

.1 Residence Customers (Continued)

Bilello, John H	850/267-8426
Biscone, Joseph	850/267-3793
Bistline, Charles R	850/267-0474
Blackburn, James L	850/267-0217
Blackenburg, John Dr & Cindy	850/622-0364
Blair, Ken & Jan	850/622-6500
Blake, Paul & Barbara	850/267-4998
Blankenship, Johnny	850/267-9090
Blunt, Jim & Ann	850/267-1019
Bobo, Hern	850/622-0136
Bobo, Hern & Betsy	850/267-9493
Bobo, John	850/267-0968
Bodisch, William J & Myke	850/622-3853, 850/622-3854
Boecher, J & L	850/267-1133
Bohn, Kit M	850/267-2313
Boswell, Mike & Debra	850/622-0672
Boudreaux, Allen Chris	850/267-3721
Bowlin, John & Linda	850/267-4625
Boyer, Barbara M	850/267-1485
Bradshaw, George	850/267-2468
Brady, Doris E	850/267-3784
Brady, Michael H	850/267-0236, 850/267-2974
Brady, Tom & Jean	850/622-1741
Brady, V	850/267-1489
Brand, Charlie & Pat	850/267-9410
Brandon, Sherri	850/267-0986
Branham, Randolph & Atsuko	850/622-1065
Brannon, George	850/267-2469
Brass, William C	850/622-3866
Braswell, John & Shannon	850/622-5969
Bray, Frank & Jane	850/622-0766
Breed, John & Susan	850/267-1550
Brielmayer, G	850/622-1149, 850/622-1351
Brister, Percy & Mona	850/267-1339
Britt, Garnett	850/622-0817
Broaderip, Brent	850/622-0139, 850/622-1635
Brogdon, David	850/267-2739

GENERAL EXCHANGE TARIFF

Embarq Florida, Inc.

BY: F. B. Poag  
Director

SECTION A3  
First Revised Sheet 50.7  
Cancelling Original Sheet 50.7  
Effective: September 15, 2004

BASIC LOCAL EXCHANGE SERVICE

E. LOCAL EXCHANGE EXCEPTIONS (Cont'd)

15. Destin (Continued)

.1 Residence Customers (Continued)

Brooks, Phillip	850/622-0501
Brown, Bill V Maj Gen	850/267-0434
Brown, Jeff & Natala	850/267-0214
Brown, Jim & Linda	850/267-3740
Brown, Margaret J	850/622-1389
Brown, R	850/267-6044
Brown, Walton	850/267-0088
Bruce, Eugene	850/622-1944
Bruce, Steven & Becky	850/622-9596, 850/622-9773
Bruno, Charles & Laura	850/622-1959
Buckner, Dan & Stephanie	850/622-3836
Bugnitz, John & Nancy	850/267-0496
Bunch, Wayne P & Carolyn	850/622-0948, 850/622-3867
Buretta, M L	850/267-9930
Burke, P	850/622-1160, 850/622-1161
Burress, Robert	850/267-4924
Busfield, David	850/267-1948
Butler, Hilary	850/622-9708
Butler, Robert A	850/622-0189
Butler, Tim & Beverly	850/267-2908
Caldwell, Donald	850/622-1406
Caldwell, Jack	850/267-4591, 850/267-6015
Callahan, Scot	850/267-2564
Calloway, J A Jr	850/622-3782
Campbell, H Thomas	850/267-0310
Campbell, Judy	850/267-2151
Campbell, Ronald M	850/267-0907
Campo, Allan & Donna	850/622-2046, 850/622-2076, 850/622-2086
Canale, Bevan & Ann	850/622-3225
Cannington, Royce	850/267-4986
Cantrell, Dee & Dexter	850/622-0055
Cardwell, Lee	850/622-0406
Carey, John	850/267-0488
Carlisle, Dennis & Martha	850/622-1742
Carlson, William L	850/267-2264
Caro, Peter	850/267-1500
Carpenter, Shane	850/622-5852, 850/622-5853
Carter, J S	850/622-1446
Carter, Marc	850/622-0726, 850/622-6215

GENERAL EXCHANGE TARIFF

Embarq Florida, Inc.

BY: F. B. Poag  
Director

SECTION A3  
First Revised Sheet 50.8  
Cancelling Original Sheet 50.8  
Effective: September 15, 2004

BASIC LOCAL EXCHANGE SERVICE

E. LOCAL EXCHANGE EXCEPTIONS (Cont'd)

15. Destin (Continued)

.1 Residence Customers (Continued)

Carter, William	850/622-1479
Cartwright, David	850/267-2851
Cartwright, R	850/622-9781
Carty, Bill R	850/267-0094, 850/267-4570
Casiano, E J	850/622-1035, 850/622-1045
Catrino, Ken	850/267-1417, 850/267-1915
Causey, James L	850/622-1175
Cavalaros, James G	850/267-1462
Chandler, Robert	850/267-2651
Chaney, Miller	850/622-0094
Chapman, Lewis	850/267-3723
Chapman, Ralph E	850/267-1488
Charbonneau, Art	850/267-3685, 850/267-3698, 850/622-1451
Chelette, Chris	850/622-1975
Chesley, Curt & Yonnie	850/267-1064
Choate, L M	850/267-3489
Christian, David & Jane	850/622-1492
Ciambor, James & Frances	850/267-1154, 850/267-2100
Cissel, Melissa	850/622-6252
Cissell, Benjamin & Debra	850/267-5692, 850/267-8469
Clark, James & Susan	850/622-1739, 850/622-1759
Clarke, Robert	850/267-1636, 850/622-3765
Clausen, Ray	850/622-1465
Clear, William & Elaine	850/622-0867
Clements, Sandra C	850/267-3593, 850/267-4628
Clennan, Roy	850/622-5699
Clift, Jack T	850/622-6249
Cloutier, Lawrie	850/267-0029
Coates, Donald H	850/267-0637
Cochran, Alexandra	850/267-0982
Cochran, Jim & Alex	850/267-4544
Cocks, Andrew	850/622-5989
Coffeen, Ed	850/267-0768, 850/267-1171
Colcord, Ned & Kathy	850/267-0995, 850/267-9404
Cole, J W	850/622-1715
Coleman, Sid	850/622-3217
Colfry, Al & Ann	850/267-1176
Collier, Kevin & Lisa	850/267-1330
Collins, Jack R	850/267-1015

GENERAL EXCHANGE TARIFF

Embarq Florida, Inc.

BY: F. B. Poag  
Director

SECTION A3  
First Revised Sheet 50.9  
Cancelling Original Sheet 50.9  
Effective: September 15, 2004

BASIC LOCAL EXCHANGE SERVICE

E. LOCAL EXCHANGE EXCEPTIONS (Cont'd)

15. Destin (Continued)

.1 Residence Customers (Continued)

Colomb, David & Lisa	850/267-3782
Colomb, RusseLL	850/267-1753
Compton, Vicki	850/267-0985
Conley, David	850/622-0558
Cook, Scott & Sara	850/267-3209
Coon, Russell T	850/267-2427
Coors, Giles & Suzette	850/622-2323
Copeland, Phil	850/267-0516
Corman, James F & Jane	850/267-0669
Costin, Margaret M	850/267-0783
Cottingham, George & Kitty	850/267-2544, 850/267-4914
Courtney, Joel	850/267-1570
Cowell, James	850/622-4774
Cox, Fred & Ampy	850/267-4923, 850/267-4926
Cozart, Joe & Joan	850/267-2045, 850/267-3592
Craig, J L	850/267-0553
Crain, C M	850/622-0561, 850/622-2335
Crawford, Steve	850/267-0050, 850/267-4545
Creekmore, Larry & Nancy	850/267-1633
Creel, Sonja	850/622-0772
Crew, Richard & Wendy	850/622-9559
Crews, Hillard	850/267-0256, 850/267-3469
Cronin J	850/622-0790
Crosland, Marie	850/267-0074
Cruce, Andrew & Nancy	850/267-1553, 850/267-3874, 850/267-5662
Crumbliss, Henry Jr	850/622-0629, 850/622-9572
Crunk, J & P	850/267-9539
Crunk, John & Peggy	850/267-3981
Culotta, Mike	850/267-0378
Culver, K K	850/622-3204
Cummins, Thomas C	850/267-6090
Curtis V	850/622-0919
Daake, John W	850/267-1852
Dabdoub, William & Teresa	850/622-2016
Dabria, Dave & Darrell	850/267-1138
D'Agostino Robert & Claire	850/267-6040
Daleo, Joe	850/622-1034
Damroth, Mary S	850/622-1729, 850/622-1730
Daniel, John	850/622-2763

GENERAL EXCHANGE TARIFF

Embarq Florida, Inc.

BY: F. B. Poag  
Director

SECTION A3  
First Revised Sheet 50.10  
Cancelling Original Sheet 50.10  
Effective: September 15, 2004

BASIC LOCAL EXCHANGE SERVICE

E. LOCAL EXCHANGE EXCEPTIONS (Cont'd)

15. Destin (Continued)

.1 Residence Customers (Continued)

Dannecker, Markus	850/622-0128
Daugherty, Michael	850/622-1641
Davis, Darwin & Mildred	850/267-1534
Davis, Jay D	850/622-0215
Davis, Morris & Linda	850/267-2609
Day, Snowden T	850/267-0473
De Berry, D Donald	850/267-9902
Deal, Phillip	850/622-0360, 850/622-3004, 850/622-3005, 850/622-3050
Dean, Enid & Bill	850/622-0809, 850/622-0810
Decker, Russell & Diane	850/267-0499
Deckman, Joe	850/622-3818
Del Bene, Gabrielle	850/622-5643
Dennison, J I	850/267-2250
Dermody, Craig & Lindlee	850/267-2177
Dettwiller, Fred	850/267-4523, 850/267-6025, 850/267-6029 850/267-6031, 850/267-6034, 850/622-1931
Dickinson, Charles & Mary	850/267-1828, 850/267-3500
Dickson, William & Anne	850/267-1650
Diethelm, Arnold	850/622-2344
Dietz, Diane & Stewart	850/267-1346
Dinsmore, James & Vicki	850/267-1233
Dixon, Susan & Gregory	850/267-0657
Dobelek, John A & Denise C	850/267-6041
Dodd, Ron & Felicia	850/622-0847
Dodson, Richard	850/267-2793
Dodson, Tom	850/267-3211, 850/267-4550
Dolin, Michael & Karen	850/267-1448, 850/267-1514
Dominguez, Grace	850/267-0928
Donaldson, R B	850/267-2781
Doran, Frank & Susan	850/267-2922
Douglas, William T Dr	850/267-3490
Dow, Allan	850/622-0489, 850/267-3450
Dowden, Kim & Lee	850/267-2520
Dowdle, Carey	850/267-0277, 850/267-3609
Draper, Lawrence T	850/267-0156
Drexler, Richard	850/622-2316
Dubbell, David	850/622-1237, 850/622-1238, 850/622-1224 850/622-1684

GENERAL EXCHANGE TARIFF

Embarq Florida, Inc.

BY: F. B. Poag  
Director

SECTION A3  
First Revised Sheet 50.11  
Cancelling Original Sheet 50.11  
Effective: September 15, 2004

BASIC LOCAL EXCHANGE SERVICE

E. LOCAL EXCHANGE EXCEPTIONS (Cont'd)

15. Destin (Continued)

.1 Residence Customers (Continued)

Dukehart, Dave & Ellen	850/622-1531, 850/622-1632, 850/622-1932
Dulian, Walter & Sandra	850/267-4972
Dulin, John & Jane	850/622-3750
Duncan, Debra	850/267-3807, 850/622-5154
Dupell, Richard & Denise	850/267-0234
Dwyre, Michael	850/267-0756
Earles, Charles	850/267-3109, 850/267-3124
Earles, Florence	850/267-2219
Earp, Allen & Betty	850/622-1892
Eaves, Everett	850/267-2203
Eaves, Karen & John	850/622-2372
Eaves, Mary	850/267-2139
Ebersole, Robert P & Doris	850/267-9443
Edes, Letty	850/622-1562
Edman, Dwight & Linda	850/622-9754
Edmands, Wallace M Jr	850/267-1829
Edwards, Mia	850/622-2160
Edwards, Patrick	850/622-8149
Edwards, Robert	850/267-0221, 850/267-0646
Eich, Jacqueline	850/622-0525
Ekstrom, Loretta	850/622-0473
Ellis, James N	850/267-3018
Ellison, Randy	850/267-0337
Elovitz, Mark	850/622-9759
Embley, Phil	850/267-0320
Endress, Ned R & Sandra L	850/622-3029
Ernest, Frederick P	850/267-1588
Evans, Charles	850/267-1360
Faber, Don & RUTH	850/622-1711
Faulkner, Tina & Henry	850/622-0949
Fearson, William & Carol	850/622-2073
Fehskens, J	850/622-0660, 850/622-0662
Feild, J Rodney M D	850/267-5615
Felker, Charles William	850/267-2567
Felt, Jane	850/622-8187, 850/622-1842
Fernstrom, D B Dr	850/622-5900
Fichter, Leonard	850/267-0586
Finnell, Randolph	850/622-5727
Flanagan, Brian & Annalee	850/267-1988

GENERAL EXCHANGE TARIFF

Embarq Florida, Inc.

BY: F. B. Poag  
Director

SECTION A3  
First Revised Sheet 50.12  
Cancelling Original Sheet 50.12  
Effective: September 15, 2004

BASIC LOCAL EXCHANGE SERVICE

E. LOCAL EXCHANGE EXCEPTIONS (Cont'd)

15. Destin (Continued)

.1 Residence Customers (Continued)

Flanagan, Malcolm & Eloise	850/622-2768
Floodman, Bill	850/622-9106
Flores, John	850/622-8114
Flowers, S H	850/267-0939
Flynt, Joesph	850/622-3894
Folk, Humphrey	850/267-3158
Fontana, Steve	850/267-1513
Fouts, Jimmie & Mary	850/267-1670
Fowler, Scott Fahy	850/267-2643
Fox, Oakley	850/267-1901
Francisco, Sidney	850/622-0644
Fransen, Rick & Mary	850/622-5988
Frazer, Jim & Carol	850/622-9544, 850/622-9545
Freeman, Brian	850/267-1093
Friddell, V	850/267-0069
Friend, Forman	850/267-1545
Fritz, Jerry	850/267-0374
Frye, Gil	850/267-2179
Fuchs, Martha & Jim	850/267-8419
Fuhrman, William	850/267-3558
Fuller, Joyce & Syd	850/267-0931
Fuller, K H	850/622-0180
Gabrielson, John	850/622-0709
Gaffney, Gerald	850/267-5652
Gallagher, David	850/267-1661
Galvin, Thomas & Margaret	850/622-5922
Gamble, Don & Margaret	850/267-3080
Gammon, Pete & Mott	850/267-9439
Gardner, Jerry	850/622-0186, 850/622-0196
Gardner, John	850/622-2215
Gardsbane, S	850/622-1654
Garner, Christina & Tim	850/267-1522
Garner, T	850/622-0316
Garrett, John Claude III	850/267-4692
Garver, H C	850/267-0979
Garvie, Barbara C	850/622-8175
Gary, William E III	850/267-4683
Gast, J	850/622-1879
Gatti, Anthony J	850/267-0112
Gay, Ruby	850/622-1832

GENERAL EXCHANGE TARIFF

Embarq Florida, Inc.

BY: F. B. Poag  
Director

SECTION A3  
First Revised Sheet 50.13  
Cancelling Original Sheet 50.13  
Effective: September 15, 2004

BASIC LOCAL EXCHANGE SERVICE

E. LOCAL EXCHANGE EXCEPTIONS (Cont'd)

15. Destin (Continued)

.1 Residence Customers (Continued)

Gibert, Julie	850/267-3747
Gibson, Larry & Joanna	850/267-1244
Gifford, J D	850/622-1678
Gilliland, Jack B & Phyllis	850/267-8478
Giorgetti, Marcello & Vicky	850/622-9161
Glasscock, Gary M	850/267-1481
Glaze, Bob & Sharon	850/622-0826, 850/622-6513
Goller, I H	850/622-1993
Gooch, John P	850/267-1681
Goodman, Eddie & Michelle	850/267-0072, 850/267-0090
Gorman, D & P	850/267-2317, 850/622-1579
Gottlich, Matt	850/267-267-4
Graber, David & Jill	850/267-3931
Graf, Norman & Beverly	850/622-5776
Grainger, Lex	850/267-3741, 850/267-2603, 850/267-8479 850/267-4659
Grant, Marvin & Kathy	850/622-3800
Graves, Jerry & Laurie	850/267-0173, 850/267-2533
Gray, D W	850/622-1311
Graziano, Frank Dr	850/622-2366
Greene, Edward	850/622-0846
Greenham, Don & Lynda	850/267-3866
Greenwaid, E L	850/622-0066
Greenwell, Paul & Kelly	850/267-3064
Greenwell, Sarah	850/622-1155
Greer, B F	850/622-0553
Griffin, Howard	850/267-2919
Griffith, Bryan	850/267-2545
Grill, Al & Sue	850/622-1807, 850/622-1809, 850/622-1810
Grimac, Theodore E	850/267-1903
Gruber, Burt	850/622-0870, 850/622-0871
Guraino, R	850/267-3335
Guevara, Gail & Michael	850/622-2069
Gundry, Donald R	850/267-9425, 850/267-9426, 850/267-9971
Guth, Raymond C & Dorothy L	850/267-3272
Haberern, Roger	850/267-9911
Hager, Alex & Karen	850/267-0211
Haglund, Paul	850/622-0045
Haie, D	850/622-5766
Haiey, Kenneth J Sr	850/267-0446



GENERAL EXCHANGE TARIFF

Embarq Florida, Inc.

BY: F. B. Poag  
Director

SECTION A3  
First Revised Sheet 50.14  
Cancelling Original Sheet 50.14  
Effective: September 15, 2004

BASIC LOCAL EXCHANGE SERVICE

E. LOCAL EXCHANGE EXCEPTIONS (Cont'd)

15. Destin (Continued)

.1 Residence Customers (Continued)

Hallday, Irene	850/267-3302
Hail, Don	850/267-1307, 850/267-1347
Hail, Don, James	850/622-0899
Hail, Tony & Cynthia	850/267-1909
Hailman, M	850/267-0258
Hamilton, Bonnie	850/622-5757
Hammes, Chet & Jill	850/622-9770
Hand, Mary Jo	850/622-2327
Hannah, W R	850/267-2752, 850/267-3631
Hanscom, Tom & Lisa	850/622-0767
Hanson, David	850/622-1940
Harding, Marguerite	850/267-0319
Harmon, Barrie H III	850/267-2321
Harned, Joseph W & Antoinette	850/267-4633
Harper, Jearold	850/267-3159
Harris, Gene & Kathy	850/622-0368, 850/622-2004
Harris, Phillip & Susan	850/267-1102, 850/267-1162, 850/267-3095
Harris, Robert	850/622-9534, 850/622-9535
Harris, Robert H	850/622-0191
Hartshorn, Tom	850/622-4775
Harwell, Jim & Jane	850/622-3768
Hastings, Ken	850/267-9062
Hatcher, Harold A	850/267-4663
Hawkins, B	850/267-1449
Hayden, Phillip & Mollie	850/267-2656
Hayes, Pearl M	850/267-3556
Hayes Harry S & Barbara	850/622-1960
Hays, Jennifer	850/622-3246
Heaiy, Edward	850/622-3298
Hean, Rosemary	850/622-5645
Hearn, Ted	850/267-1152
Heath, Bobby Dr	850/622-9114
Heffernan, Stuart	850/622-2094, 850/622-2095
Hegwood, James C	850/267-0596
Helms, C	850/622-3787
Helms, Samuel	850/267-0754
Henderson, Ben B	850/267-2812
Henderson, Harry	850/622-9130, 850/622-2027
Heninger, E L	850/267-0508
Henkle, O T	850/267-2252
Herbert, Mary & Don	850/622-8160
Herdrich, Harry	850/622-3897

GENERAL EXCHANGE TARIFF

Embarq Florida, Inc.

BY: F. B. Poag  
Director

SECTION A3  
First Revised Sheet 50.15  
Cancelling Original Sheet 50.15  
Effective: September 15, 2004

BASIC LOCAL EXCHANGE SERVICE

E. LOCAL EXCHANGE EXCEPTIONS (Cont'd)

15. Destin (Continued)

.1 Residence Customers (Continued)

Herndon, Jay	850/267-1832
Hertweck, Patty	850/622-3766
Herzog, Dot & Al	850/267-3394
Hickman, Victoria	850/622-1616
Higdon, Michael W	850/622-3047, 850/622-3049
Higginbotham, Steve	850/622-0382
Hightower, Ed	850/622-1153, 850/622-1573
Hilderbrand, Jerry	850/267-3970, 850/267-3975
Hill, Gary & Nancy	850/622-6572
Hill, John L	850/267-9037
Hill, Wilton D	850/267-3584
Hoar, Wayne & Kathy	850/622-0776
Hocker, K E	850/622-8142
Hodder, Edwin J Jr	850/267-0951, 850/267-0952, 850/267-0953
Hofer, Hans P & Sandra L	850/267-1891
Hoffman, Richard	850/267-3697
Hogan, Alida	850/622-9115
Hohman, Robert & Billie	850/267-5699
Holcomb, William S	850/267-1638
Holley, Linda S	850/622-5636
Holligan, Ken & Kay	850/622-0261
Howard, B & P	850/622-1863
Howard, Becky	850/267-1649
Howard, Billy W	850/267-9453
Howe, James R	850/267-2706
Hudson, Jim & Nancy	850/622-0641
Huff, Chandler	850/267-1523, 850/267-1743
Hughes, Ray	850/267-3836
Hull, Nina	850/622-3038
Hummel, Philip	850/267-3136
Hunter, Bill & Caryl	850/622-2191
Hunter, Morris	850/267-4648
Hurley, Philip & Jenise	850/622-4756
Hyneman, John W	850/622-0690
Irvin, Steven	850/622-9548, 850/622-9549
Istorico, Alfonso	850/622-0199
Jackson, Clyde & JaneT	850/622-4740, 850/622-4741
Jackson, Don	850/267-2917, 850/267-3017
Jackson, John	850/267-2122
Jackson, Van	850/622-9181, 850/622-0577
Jacobs, Richard L	850/622-1006, 850/622-1007
Jacovelli, Saverio	850/267-2912

GENERAL EXCHANGE TARIFF

Embarq Florida, Inc.

BY: F. B. Poag  
Director

SECTION A3  
First Revised Sheet 50.16  
Cancelling Original Sheet 50.16  
Effective: September 15, 2004

BASIC LOCAL EXCHANGE SERVICE

E. LOCAL EXCHANGE EXCEPTIONS (Cont'd)

15. Destin (Continued)

.1 Residence Customers (Continued)

Jamison, John W III	850/267-3639
Jeter, Don & Jeannie	850/267-3656
Jeter, Jeannie	850/267-1821
Jewell, John & Mary	850/622-8113
Johnson, Brett & Rachael	850/622-5885
Johnson, Robert R	850/622-0014
Johnson, West & Katie	850/267-0279, 850/622-2778
Jones, Dennis & Cindy	850/622-0106, 850/622-0107
Jones, H L Dick & Ann	850/622-5663
Jones, Peggy	850/267-1299
Jones, Ray & Martha	850/622-1070, 850/622-1071
Jotkus, Peter	850/267-2069
Julius, Jane	850/622-9797, 850/622-9798
Kampeter, Rich & Betty	850/622-2077
Kaplan, Phyllis	850/622-1020
Karian, L	850/622-3016, 850/622-3017
Kaufman, Robert & Barbara	850/622-4799
Keesling, Robert J & Janice	850/267-4622-
Kelley, Buddy	850/622-1264
Kelley, John & Nancy	850/622-2222
Kelly, James & Mary	850/622-1426, 850/622-1429
Kemp, Harry	850/622-0110
Kempner, Olivian	850/622-3282
Kenknight, Robert	850/622-1943
Kennedy, R & C	850/267-0163
Kent, Jack W & Harriett	850/267-3345
Kidd, Billy R	850/267-1666
Kilian, Glenn G	850/622-1970
Kimm, George & Sunsook	850/267-1032
King, Elton & Pat	850/267-1594, 850/267-2062, 850/267-9043
King, Joel & Belinda	850/622-9528
King, John W	850/267-3355
King, Kitty	850/622-1967
King, Michael	850/622-2088, 850/622-2266, 850/622-2288
Kinnick, R Nile	850/267-3566
Kinsler, Lane	850/267-1132
Kirby, M Q	850/622-0436, 850/622-0463
Kirkpatrick, John D	850/622-5692
Klotz, Donald	850/267-4507
Kohls, Greg	850/267-9073
Kopperud, Dean C	850/622-0549
Kostick, Raymond & Pamela	850/267-1205

GENERAL EXCHANGE TARIFF

Embarq Florida, Inc.

BY: F. B. Poag  
Director

SECTION A3  
First Revised Sheet 50.17  
Cancelling Original Sheet 50.17  
Effective: September 15, 2004

BASIC LOCAL EXCHANGE SERVICE

E. LOCAL EXCHANGE EXCEPTIONS (Cont'd)

15. Destin (Continued)

.1 Residence Customers (Continued)

Kotowske, Wendy & Steve	850/622-2223
Kovacic, Stan	850/622-1396
Krebs, Leonard	850/267-1058
Krynicky, Raymond	850/267-1801, 850/267-2143
Kuehl, Olivia	850/622-8171
Kuhlman, Paul	850/267-1714
Kulick, Jack & Deanna	850/267-1961
Kunkel, Larry	850/267-3311
La Borde, Cammie & Chuck	850/267-3630
La Nasa, Tony & Terry Sue	850/267-3290
Lackie, James D	850/267-1088, 850/267-5626
Ladner, Jesse	850/622-3033
Lahey, Kevin	850/267-3328
Lake, Stephen & Carol	850/267-8454
Lambert, Hugh P	850/267-0145, 850/267-2456
Landa, Martin	850/622-0674
Landquist, W R & Marge	850/267-3775
Labdry, Bryan	850/267-1764
Landwher, SteveN & Barbara	850/622-5666
Laneri, John	850/267-0404
Lang, D M	850/622-9154
Langstaff, George Q	850/267-2503
Lanier, Frederick M	850/622-2154
Lapidus, Richard & Barbara	850/267-3960
Latting, H B	850/622-9718
Laube, F H III	850/622-0581
Launch, Robert & Cindy	850/622-0356
Lauterbach, Richard	850/267-1461
Lauterbach, Richard & Lynn	850/267-1426
Lavigne, Yvonne	850/622-1005
Lawrence, Edmund	850/267-1326
Lawrence, Walter & Sophie	850/267-0796
Lazar, S & D	850/622-6518
Le Ray, George	850/267-6049
Lea, Michael G	850/622-8161
Leanard, Kimberley	850/267-3051
Lee, Randy	850/622-0079
Lefkovits, Arnold	850/267-2659
Legends, San Destin JV	850/622-0904
Legg, John	850/267-3244
Leitman, Jerry & Marcia	850/267-1562
Lenzen, George & Janice	850/622-5744

GENERAL EXCHANGE TARIFF

Embarq Florida, Inc.

BY: F. B. Poag  
Director

SECTION A3  
First Revised Sheet 50.18  
Cancelling Original Sheet 50.18  
Effective: September 15, 2004

BASIC LOCAL EXCHANGE SERVICE

E. LOCAL EXCHANGE EXCEPTIONS (Cont'd)

15. Destin (Continued)

.1 Residence Customers (Continued)

Leonard, Stephen & Janice	850/622-1452
Lepage, K & P	850/622-3852
Lepley, Dan	850/622-2190
Leppanen, Clifford	850/267-2090
Lester, Joe & Ann	850/267-3482
Letcher, Tom	850/622-1891
Levy, Stephen & Judy	850/267-2617
Lewis, J & T	850/622-5805, 850/622-5806
Leyendecker, Charles S	850/267-2348
L'Heureux, Guy	850/267-4536
Liban, Geoffrey	850/267-3016, 850/622-0918
Liles, Buddy	850/622-2736
Lillie, Peggy	850/622-2194
Lima, Rildo	850/267-2144
Limerick, John & Sharon	850/622-0395
Lipscomb, Matthew	850/267-3770
Livaditis, John	850/267-3065
Llanderosos, Osvaldo	850/267-0216
Lloyd, Ken	850/267-2451
Lo Duca, Daniel M	850/267-1052
Lockwood, James	850/622-2070
Lofton, Lamar	850/267-9483
Logan, B U	850/267-9012
Logan, K O	850/267-1260
Logan, Sam & Aileen	850/622-3795, 850/622-4753
Lohman, Walter & Carol	850/267-9491
Lord, William & Nancy	850/267-0569
Lorei, Jim R	850/267-1446
Lossonn Richard & Kay	850/267-3227
Love, Vernon	850/622-9779
Lovelace, Susan & Sparky	850/267-2901, 850/267-2954
Lovelace, Yancey	850/622-0118
Lowery, Rod & Brenda	850/622-1293
Lucas, Steven & Connie	850/622-2702
Lucking, Cynthia & Scott	850/267-1840, 850/267-4666
Ludlam, Richard R	850/267-2362
Lukacs, George	850/267-4634, 850/267-4901
Lynch, William F Jr	850/267-0712
Lynn, Robert & Naomi	850/622-0246
Lyons, James & Barbara	850/267-1498
Lysinger, Rex	850/267-2330, 850/622-1443
Mac Manus, John & Candy	850/267-1890, 850/267-2361, 850/267-8485

GENERAL EXCHANGE TARIFF

Embarq Florida, Inc.

BY: F. B. Poag  
Director

SECTION A3  
First Revised Sheet 50.19  
Cancelling Original Sheet 50.19  
Effective: September 15, 2004

BASIC LOCAL EXCHANGE SERVICE

E. LOCAL EXCHANGE EXCEPTIONS (Cont'd)

15. Destin (Continued)

.1 Residence Customers (Continued)

Mack, Robert & Janice	850/622-2701
Macura, E	850/622-1584
Maddux, J O	850/622-0595
Madsen, Gunnar & Carolyn	850/622-1746
Mahler, George	850/622-5135
Mai, Klaus L	850/267-1712
Mailho, Terrieta	850/267-3320
Majoria, Meeko	850/622-1313
Majoria, Reagan	850/622-4729, 850/622-4742
Maier, Ellen & Donald	850/622-3724
Maiik, Ahmed Dr	850/267-2167
Mailett, D R	850/622-6245
Maione, Edward & Claudia	850/267-1050, 850/267-1663, 850/267-2473
Maiouf, Michael J	850/622-9108
Mann, Jefferies W	850/267-1561, 850/267-3471
Marcum, Bob & Pam	850/622-2304, 850/622-2320, 850/622-2321
Marcus, K	850/267-3297
Marice, Mary & Harvey	850/267-3605
Markham, Richard A	850/622-3880
Marks, Susan & Fred	850/267-3498
Marshail, H C Pat	850/622-4766
Martin, Frank	850/267-1944
Martin, Jack & Joyce	850/622-5191
Martin, M	850/622-0009
Martin, Rhoda	850/267-1000, 850/267-1001
Martin, Vincent & Linda	850/622-0517, 850/622-0653
Mason, Mary L	850/622-0612
Mathias, Mike	850/622-1098
Matzliah, M N	850/267-3745
Maxwell, Terry & Becky	850/622-0396
Mayer, J	850/267-0346
Maynard, Steve & Kaye	850/622-1648
Mazac, Aidona	850/267-2014
Mazza, Richard & Linda	850/622-1019, 850/622-1392
Mazzu, Santion	850/622-2015
Mc ardle, Ruby	850/267-4660
Mc Athey, Doug & Bonnie	850/267-2355
Mc Caghren, R	850/267-3169
Mc Cail, Atwood & Teri	850/622-3858
Mc Cailum, Marie C	850/267-3701
Mc Carty, K	850/622-5651
Mc Cormick, L L	850/622-0326

GENERAL EXCHANGE TARIFF

Embarq Florida, Inc.

BY: F. B. Poag  
Director

SECTION A3  
First Revised Sheet 50.20  
Cancelling Original Sheet 50.20  
Effective: September 15, 2004

BASIC LOCAL EXCHANGE SERVICE

E. LOCAL EXCHANGE EXCEPTIONS (Cont'd)

15. Destin (Continued)

.1 Residence Customers (Continued)

Mc Crary, O	850/267-1791
Mc Curley, Nyla	850/622-3252
Mc Govern, Pat & Mary	850/622-1765
Mc Grath, Lawrence	850/267-3383
Mc Graw, Alex	850/622-5105
Mc Intyre, Mike	850/622-2285
Mc Kelvy, W S	850/622-1569, 850/622-1571
Mc Kenna, Ken	850/622-2199
Mc Lanahan, Greg & Tara	850/622-5764
Mc Lemore, Jack E & Anne	850/267-3956
Mc Lemore, Jane	850/267-0714, 850/267-0736
Mc Mahan, Howard & Barbara	850/622-1947
Mc Murray, James Dr & Janice	850/267-3127
Mc Neese, Richard	850/267-1077, 850/267-9442
Mc Neilage, C	850/267-5651
Mc Rae, Robert & Hilda	850/267-0430, 850/622-9793
Mc Teer, Victor & Mercidees	850/622-1390, 850/622-1391
McCail, Sean & Barbara	850/622-9778
McClellan, Adele	850/622-5670
Mcconomy, John	850/267-0129, 850/267-3189
Mccormick, John	850/622-5955
Mccracken, Jim	850/622-3794
Mccullar, Andrea & Robert	850/622-5966
Mcquire, Thomas	850/267-2992
Mcintosh, G David	850/267-1713
Mcmanis, Robert H	850/267-1415
Mcrae, Stanley	850/622-1494
Meadoris M	850/622-0325
Meginniss, Annette	850/267-1164
Meinberg, John R	850/622-5708
Melat, Susan & Justin	850/267-3361
Merren Thomas	850/267-0531
Meyer, Adele	850/622-3267-
Meyer, E M	850/267-2228
Miller, David	850/622-1888
Miller, Franklin P	850/267-8404
Miller, Jim & M J	850/622-0277
Miller, Patrice	850/267-4532
Miller, Raymond J Jr	850/622-0393
Miller, Robert E	850/267-3390
Miller, Roy	850/267-3389
Miller, Stephen & Carolyn	850/622-1710

GENERAL EXCHANGE TARIFF

Embarq Florida, Inc.

BY: F. B. Poag  
Director

SECTION A3  
First Revised Sheet 50.21  
Cancelling Original Sheet 50.21  
Effective: September 15, 2004

BASIC LOCAL EXCHANGE SERVICE

E. LOCAL EXCHANGE EXCEPTIONS (Cont'd)

15. Destin (Continued)

.1 Residence Customers (Continued)

Miller, Susan & Gary	850/267-3321
Miller, Wade & Ruby	850/622-1152
Mills, J P	850/267-1262, 850/267-2524
Mills, Sam	850/622-9775
Milner, James H	850/622-2279, 850/622-6509
Mimeles, Monica	850/622-8137
Miner, Robert	850/267-2350
Mitchell, E	850/622-5804
Mitchell, Sharon & Buzz	850/622-0970, 850/622-3054
Moffatt Mack & Joyce	850/267-1286
Mogabgab, Paul	850/267-1101
Moncrief, Phillip L	850/622-6265, 850/622-6266
Monk, R	850/267-0566, 850/267-3452
Monteith, B P	850/622-4743
Montgomery, Leo R	850/267-1398
Moor, M E	850/267-3315
Moore, Kenneth & Tomya	850/622-1356
Morgan, Frances	850/267-3715
Morgan, George & Carolyn	850/267-2170
Morgan, Pete & Ann	850/622-1659
Morgan, Suzanne	850/267-0415
Morgenthaler, Larry & Kay	850/622-4782
Morin, Michael P	850/622-3228
Moritz, Manfred & Brenda	850/267-0923
Morris, Bill & Mary	850/267-9430
Morris, Deverne	850/622-4788
Morris, Harry & Rose	850/267-1025
Morrison, Bob	850/622-2241
Morrison, Richard	850/622-2155
Morton, Chip & Stacey	850/622-0600
Muchow, Randail	850/267-2821
Muggridge, W O	850/622-1252
Mullen, Charles & Peggy Sue	850/622-0270, 850/622-0274
Murphy, Frederick & Betty	850/267-1565
Murray, Roger Jr	850/267-2521, 850/267-3994
Murrel, Charles	850/267-3259
Myers, Margie	850/267-3535
Myslik, Jack & Diane	850/622-2712
Neal, Frank & Shirley	850/622-1792
Neal, Frank E	850/267-0376
Neidhamer, John	850/267-2873
Neighbors, William W	850/267-2725



GENERAL EXCHANGE TARIFF

Embarq Florida, Inc.

BY: F. B. Poag  
Director

SECTION A3  
First Revised Sheet 50.22  
Cancelling Original Sheet 50.22  
Effective: September 15, 2004

BASIC LOCAL EXCHANGE SERVICE

E. LOCAL EXCHANGE EXCEPTIONS (Cont'd)

15. Destin (Continued)

.1 Residence Customers (Continued)

Neilson, Thomas & Elizabeth	850/622-0401
Nelson, Florabeth	850/267-6086
Nelson, Tom & Bette	850/622-1839
Newitt, Andrew & Carol	850/622-3294
Newton, George	850/622-0795, 850/622-1881
Ng, Denis	850/622-3058
Nichols, Charles & Lee	850/267-1970
Niehaus, C	850/622-1946
Niehaus, Harry W	850/267-3719, 850/267-3976
Nims, Angie & Gary	850/267-2611
Nixon, Leonard & Ruth	850/267-1533
Nootz, Pauline	850/622-2192
Norcross, Bob & Ginger	850/622-1343
Noriea, Nick F Jr	850/267-0361
Norman, Frank	850/267-2267-
Norment, Bev & Jeanett	850/622-2008
O'Connor, David R	850/267-9567
Odom, Steve	850/267-0436, 850/267-1395
Ogletree, Robert C Col	850/622-1918
Ognibene, Frank Dr	850/622-8109
O'Hare, Thomas	850/267-1892, 850/267-3365
Olinger, Douglas J	850/622-0551
Olshan, Morton L	850/267-3569
Olson, August	850/622-1983
Orr, Maurice	850/622-1338
O'Sullivan, C J	850/267-2632
Ott, Jerry E	850/267-0563
Owens, Peggy S	850/622-1951
Paiadini, Bruce	850/267-0251, 850/267-2844
Parker, Gary & JaneT	850/267-2199
Parker, Sam	850/622-3778
Parker, William & Margaret	850/622-2217, 850/622-3037
Parks, Barry	850/622-0852
Parks, Ernie	850/267-1807, 850/267-3545
Parmigiano, M	850/622-9128
Pasquarello, Vincent J	850/267-0494
Patton, John & Gaye	850/267-8467
Paulsen, John & Ann	850/622-2078
Payne, Wilford A	850/267-2841, 850/267-3804, 850/622-9747
Pazos, Paul & Marsha	850/622-0001
Peace, Jim & Carmen	850/267-2007
Peak, Joe & Charlotte	850/267-1818

GENERAL EXCHANGE TARIFF

Embarq Florida, Inc.

BY: F. B. Poag  
Director

SECTION A3  
First Revised Sheet 50.23  
Cancelling Original Sheet 50.23  
Effective: September 15, 2004

BASIC LOCAL EXCHANGE SERVICE

E. LOCAL EXCHANGE EXCEPTIONS (Cont'd)

15. Destin (Continued)

.1 Residence Customers (Continued)

Peake, Heather & C J	850/622-1811
Peltier, Arlene	850/267-3371
Pelts, Barry	850/622-3352
Pemberton, James P	850/267-0694
Pendergast, David L	850/622-1561
Pentz, Jack	850/267-3774
Percivai, Dana	850/267-9040
Perez, Oscar	850/267-0075
Perk, Edward & Florence	850/622-2064, 850/622-2065
Perk, Howard & Sandy	850/622-2210, 850/622-2262
Persinger, Joe & Pat	850/622-0205
Peters, Joe	850/622-1084, 850/622-1085
Peterson, Stanley C	850/267-4685
Pettigrew, Marie	850/267-2936, 850/267-4586, 850/267-4630
Pettus, Ken & Gail	850/267-2612
Phetatkhao, Wicharn	850/622-4770
Philipp, Blanche	850/267-5620
Phillips, Glen & Fran	850/267-1850/
Pike, C Edward & Joyce	850/267-1433
Pisano, Donna & Nick	850/622-0748
Pitre, Leo	850/267-3346
Pittman, Lee	850/267-0582
Pleat, George B	850/622-3372
Plohetski, John	850/622-5911
Poe, Jennifer	850/622-3211
Poitevint, D G	850/622-0652
Polley, William & Susan	850/622-9129, 850/622-9159
Pols, B	850/622-5106
Ponder, Caroline	850/622-9131
Ponsetto, Joseph Dr	850/267-3512
Poolos, Linda & Ted	850/267-1499
Pope, William	850/267-9537, 850/267-9538
Portix, Joy	850/267-3422
Posey, Steve	850/622-0169
Postma, Tess	850/622-6516
Powell, Ralph & Carol	850/269-1923, 850/622-0340
Powers, C	850/622-1468
Prestage, William	850/267-1242
Price, Prestin A & Susan R	850/622-9767
Primm, Robert & Sharon	850/622-1897
Proffitt, John & Gerri	850/267-0161
Prokesch, Richard	850/267-3012

GENERAL EXCHANGE TARIFF

Embarq Florida, Inc.

BY: F. B. Poag  
Director

SECTION A3  
First Revised Sheet 50.24  
Cancelling Original Sheet 50.24  
Effective: September 15, 2004

BASIC LOCAL EXCHANGE SERVICE

E. LOCAL EXCHANGE EXCEPTIONS (Cont'd)

15. Destin (Continued)

.1 Residence Customers (Continued)

Pruitt, Robert	850/622-0796, 850/622-1536, 850/622-1598
Pruitt, Robert B	850/267-0759
Pryor, Bob & Norma	850/622-0570, 850/622-0702
Pugeda, Faustino Dr	850/267-3681
Purdy, David	850/267-3295
Purdy, Fred W & Barbara D	850/267-5611
Quast, Vern	850/267-3488
Quillen, Tiffanie	850/267-1849
Quinlan, Linda	850/622-0992
Rachelefsky, Marvin & Paula	850/622-8106
Rachels, Wanda P	850/267-9523
Rachie, Hans & Herdis	850/267-3362
Ragan, Bradley	850/622-1091
Raines, Keith	850/622-0689
Rankin, C A	850/267-9033
Rather, Freddy	850/622-0601
Raymond, Randy & Luciene	850/622-6292
Reai, Linda	850/267-3575
Reamer, John	850/622-3212, 850/622-3213
Reda, S & B	850/622-0063
Redetzke, Ken & Sue	850/622-6565
Reeves, Jon & Beverly	850/267-0459
Reidenbach, Lucile	850/267-2933
Reily, Patrick M	850/267-1192, 850/622-0149
Rennicke, William	850/267-1874, 850/267-3392, 850/267-3859
Respress, Robert & Irene	850/622-1229
Reynolds, Bessie L	850/622-9782
Reynolds, David	850/622-1764
Rhodes, Harold A	850/267-1689
Rhodes, Margaret	850/622-0681, 850/622-2373
Rice, J D	850/622-0296
Rice, James W	850/622-0339, 850/622-5611
Rich, Kenneth E	850/622-2172
Richardson, C S	850/622-1064
Richardson, L B Jr	850/622-0314
Riedel, Steve & Sharon	850/622-2000, 850/622-2005
Riggins, Donald & K C	850/622-0080, 850/622-0179
Riggs, Howard & Cary	850/267-6017
Riggs, Mark	850/267-9563
Rio, Annette & Jose	850/622-8145
Risley, H P	850/267-0106, 850/267-6013
Ritz, Kenneth & Sharon	850/622-0502

GENERAL EXCHANGE TARIFF

Embarq Florida, Inc.

BY: F. B. Poag  
Director

SECTION A3  
First Revised Sheet 50.25  
Cancelling Original Sheet 50.25  
Effective: September 15, 2004

BASIC LOCAL EXCHANGE SERVICE

E. LOCAL EXCHANGE EXCEPTIONS (Cont'd)

15. Destin (Continued)

.1 Residence Customers (Continued)

Ritz, Mary A	850/622-1670
Roberts, James G & Claudette E	850/267-1014
Robertson, Kevin	850/267-1540
Robinson, Thomas	850/267-1895
Rodgers, Sara	850/267-2083
Rogers, King	850/622-1952
Rogers, Richard	850/267-2088
Rosbottom, Harold Jr	850/267-0150, 850/267-0905
Roscoe, L & E J	850/622-1849, 850/622-1851
Rose, Steven	850/267-1034
Rossback, Suzanne	850/267-2394
Rowbatham, Stephen & Gina	850/622-0357
Ruttenberg, Harold & Pam	850/622-0126, 850/622-1190
Saie, David K	850/622-3339, 850/622-3390
Saiiba, J E	850/622-5606
Sailoum, Richard & Jan	850/622-4745
Saimon, Andrew J	850/267-2031
Saimon, Tom JR	850/267-3966
Saivan, Jacques L	850/267-2342
Sandefur, Crawford M	850/267-0489, 850/267-3220
Sanders, Joseph	850/267-2141
Sands, Barbara & Lawrence	850/267-3121
Saucier, Robert M	850/267-3301, 850/267-8456
Saunders, Charles Philip	850/267-6020
Savage, John	850/267-0973
Savage, Johnny	850/622-5825
Savoy, Rodney & Cindy	850/267-2417, 850/622-9586
Scaifi, Susan	850/622-1046, 850/622-1801
Schaffler, Tom	850/622-3873
Schell, Gary & Millie	850/622-1907
Schibler, Charles & Karen	850/622-3249, 850/622-3723
Schilpzand, Fred	850/622-8182, 850/622-8183
Schlemmer, Christy	850/267-1960
Schloss, Howard	850/622-0245, 850/622-0250
Schmidt, Jerome & Margaret	850/267-1186
Schmitz, Clarence & Francis	850/622-1460
Schnelle, Richard & Carla	850/622-9743
Schorsten, Dan	850/267-0703
Schrader, Ee & Evelyn	850/622-3272
Schrenker, Robert	850/267-1552
Schroeder, Frank	850/267-0364, 850/267-1501
Schroer, Raymond J	850/267-3779

GENERAL EXCHANGE TARIFF

Embarq Florida, Inc.

SECTION A3

BY: F. B. Poag  
Director

First Revised Sheet 50.26  
Cancelling Original Sheet 50.26  
Effective: September 15, 2004

BASIC LOCAL EXCHANGE SERVICE

E. LOCAL EXCHANGE EXCEPTIONS (Cont'd)

15. Destin (Continued)

.1 Residence Customers (Continued)

Schudmak, Mel	850/622-3070
Schultheis, Janet & Thomas	850/267-1894
Schutty, Martin & Janet	850/267-0423, 850/267-3089
Scjwaoemberg, D	850/267-1907
Scola, Mike & Jennifer	850/622-2148
Scothorn, Donald	850/622-5669
Scott, Mildred	850/267-1471
Scozzafave, D	850/622-5114
Seaver, Susan A	850/267-9454
Self, Hank & Laura Jane	850/622-3773, 850/622-9151
Self, Henry H	850/267-3112
Shaefer, Robert R & Wendy A	850/267-1835
Shaheen, J M	850/267-4916
Shahid, Cary	850/267-3275
Sharp, Keith & Nicole	850/622-1484
Shaver, David	850/267-1282
Sheaffer, John D	850/267-2223
Sheridan, George & Judy	850/622-3093, 850/622-3094
Shields, Bruce	850/267-3081
Shirah, Michael	850/267-1686, 850/267-8475, 850/622-0061
Shoemaker, Hai	850/267-3995
Short, John & Denise	850/622-0152
Simmons, Howard & Jeanie	850/622-0833, 850/622-0837
Simmons, Jerry	850/622-0901, 850/622-0902
Simmons, Mable	850/622-3084
Simmons, Patsy	850/622-5787
Simpson, C C	850/622-0749
Simpson, Charles H & Shirlie	850/622-0232
Singleterry, M L	850/622-5682
Sirmans, Paul & Jan	850/622-5909
Skaia, Franklin C	850/267-2454
Skinner, Donald	850/267-9961
Slater, James & Janet	850/267-3391, 850/267-3537
Smith, Brad & Susan	850/267-2165, 850/267-2186
Smith, David	850/267-0696
Smith, Donna & Julian	850/267-0698
Smith, E K	850/267-6053
Smith, Fred & Sandy	850/267-2449, 850/267-3536
Smith, Gary & Susan	850/267-8429
Smith, Grant & Annette	850/267-1292
Smith, James & Candace	850/622-3201

GENERAL EXCHANGE TARIFF

Embarq Florida, Inc.

BY: F. B. Poag  
Director

SECTION A3  
First Revised Sheet 50.27  
Cancelling Original Sheet 50.27  
Effective: September 15, 2004

BASIC LOCAL EXCHANGE SERVICE

E. LOCAL EXCHANGE EXCEPTIONS (Cont'd)

15. Destin (Continued)

.1 Residence Customers (Continued)

Smith, Michael & Emilie	850/622-5881, 850/622-5882, 850/622-5883 850/622-5884
Snaider, Edith	850/267-0988
Snodgrass, D E	850/622-4722
Solley, M	850/267-267-9
Somers, MaryAnn & John Paul	850/267-9564
Soules, William	850/267-9019
Spaneas, Stephen	850/622-0042
Speigner, James M	850/622-6515
Spence, William & Catherine	850/622-1911
Spickard, Brenda	850/267-0008
Spizaie, Felix C	850/267-1709, 850/622-0271
Spradlin, Glenn & Kelly	850/267-2466
Springer, Clyde H	850/267-1394
Stanko, Anne Mrs	850/267-4992
Stator, Tom	850/622-0597
Steigner, Danny & Debbie	850/267-0661, 850/267-2208
Stenhouse, H & J	850/267-0525
Stephenson, John R	850/267-4637
Stepp, Diane	850/622-0544
Stevens, Rodney	850/267-2982
Stewart, M	850/267-2948
Stoddard, John & Judy	850/622-3207, 850/622-3208
Stone, James	850/267-2581
Stone, Jay & Ann	850/622-4714
Stoppert, James	850/267-1571
Stowe, David & Marilyn	850/622-6210
Strate, Margaret	850/622-0920
Strickland, Phillip & Jan	850/267-4950, 850/267-8449
Stroble, Charles P	850/267-0715, 850/267-5689
Sturgis, Jeanette	850/267-1416
Sullivan, David C	850/267-2676, 850/267-9044
Sullivan, Geraid	850/267-1885
Sutherland, Hugh L	850/267-4931
Swastek, Ann	850/622-2350
Sweatt, John & Suzanne	850/267-1037, 850/267-4654
Sweeney, Gerald M	850/267-0624, 850/267-2994
Sweet, D & K	850/622-2218
Tabor, Ron & Ellen	850/267-0417
Tarkin, Winifred	850/622-1714
Tatum, Dyke	850/622-0424

GENERAL EXCHANGE TARIFF

Embarq Florida, Inc.

BY: F. B. Poag  
Director

SECTION A3  
First Revised Sheet 50.28  
Cancelling Original Sheet 50.28  
Effective: September 15, 2004

BASIC LOCAL EXCHANGE SERVICE

E. LOCAL EXCHANGE EXCEPTIONS (Cont'd)

15. Destin (Continued)

.1 Residence Customers (Continued)

Tatum, Mahony & Vickie	850/622-1526
Taylor, Amos & Jane	850/622-3290
Taylor, Danny	850/622-0439
Taylor, J Keane	850/267-0281, 850/267-8464
Taylor, Jason	850/622-6564
Taylor, Joe III	850/267-1484
Taylor, M	850/267-4970, 850/267-6068
Taylor, William Don Col	850/622-0986, 850/622-1538
Terry, James W	850/267-3646
Terry, R	850/267-2161, 850/267-2164
Thebault, Stephen & Ursula	850/622-9785
Thomas, Charlotte C	850/267-5671
Thomason, Larry C	850/267-1771
Thompson, Michael C & Vaierie	850/267-9475
Tillman, Fred	850/267-2054
Tobian, Robert & Deborah	850/622-0631
Totten, Veronica	850/267-0618
Tragesser, Mike	850/622-9512
Travis, R Neal	850/622-3008
Tresskar, Chris	850/267-0169
Trotman, Jimmy L	850/267-0638, 850/267-3835
Tucker, Rita	850/267-0031, 850/267-1680
Tunnell, G Lynn	850/267-3808
Turner, C O	850/267-4621
Turner, Neal	850/622-0956, 850/622-6298
Turner, Wilma C	850/622-0244
Tyler, Ed & Carol	850/267-9554
Underwood, John R	850/267-2269
Underwood, S J	850/267-3606, 850/267-3987
Ungarino, Ellen & Tom	850/622-1256
Ussery, David	850/622-1640, 850/622-9599
Van Heusen, Billy	850/267-4609
Varzo, Benny & Michael	850/622-0791
Ventulett, Thomas W	850/622-9522
Vetter, Cyril E	850/267-3009, 850/267-9980
Vice, Jon & Teri	850/622-0869, 850/622-0886
Vick, Hugh	850/622-0819
Voda, Jan	850/267-2418
Voigt, Nick	850/622-1988, 850/622-1989
Vorst, Michael & Bonita	850/622-3727, 850/622-3728
Vosbein, Robert A	850/267-1222, 850/267-1824

GENERAL EXCHANGE TARIFF

Embarq Florida, Inc.

BY: F. B. Poag  
Director

SECTION A3  
First Revised Sheet 50.29  
Cancelling Original Sheet 50.29  
Effective: September 15, 2004

BASIC LOCAL EXCHANGE SERVICE

E. LOCAL EXCHANGE EXCEPTIONS (Cont'd)

15. Destin (Continued)

.1 Residence Customers (Continued)

Vowell, David & Brenda	850/267-3736
Vreeland, Anne	850/622-4750
Wagsfaff, T	850/622-3709, 850/622-5709
Waitzman, J W	850/267-2347
Waiden, James & Clara	850/622-1319, 850/622-1342
Waidenberger, Leonard	850/267-4913
Waiker, Billy & Mickey	850/267-0909
Waiker, Mac & Shirley	850/267-9994
Waiker, Robert G	850/267-0477
Wallace, Cleveland III	850/622-0204
Wallace, Lou	850/267-2372, 850/622-5619
Wailer, M D	850/622-1025
Walters, N	850/622-2794
Walters, Russell	850/267-2287, 850/622-0813
Walters, Russell & Diane	850/622-1957
Waitman, Mark	850/267-9001
Warmack, Edward O	850/267-2296
Washburn, Michael & Marian	850/267-6035
Wasserman, Gerald	850/267-0001
Waterfield-Holbrook, Mary Lou	850/267-1170
Waterman, Philip & Stephanie	850/622-1796
Watling, F	850/622-3030
Waxler, Billy & Delane	850/622-1772
Webb, Bill	850/267-0348
Weeks, Harry T	850/267-1261
Weidner, Alex	850/622-5110, 850/622-5125
Weller, M	850/267-9051
Werner, Annette	850/622-1880
Werth, Ken & Gail	850/622-0125
Westmoreland, Dan & Lois	850/267-1537
Weston, William & Judy	850/267-0391
Wheeler, Melissa	850/622-3263
Whitaker, Jack & Rebecca	850/622-1596, 850/622-1597
White, Charles & Betty	850/267-0137, 850/267-2152
White, Chuck & Anne	850/267-0765
White, Fernald R	850/267-3225
White, Phyllis	850/267-0462
White, Robert	850/267-1569
White, Russell	850/267-2422
Whitehead, Tara	850/267-5625
Whitney, Todd & Kitty	850/267-2024



GENERAL EXCHANGE TARIFF

Embarq Florida, Inc.

BY: F. B. Poag  
Director

SECTION A3  
First Revised Sheet 50.30  
Cancelling Original Sheet 50.30  
Effective: September 15, 2004

BASIC LOCAL EXCHANGE SERVICE

E. LOCAL EXCHANGE EXCEPTIONS (Cont'd)

15. Destin (Continued)

.1 Residence Customers (Continued)

Whittington, Jimmy & Jayne	850/267-1641
Whittington, M C & Peggy	850/267-3952, 850/267-3961
Whittle, Shirley W	850/267-1363
Weisneth, Charles & Robin	850/622-3323
Williams, Alice	850/267-1497
Williams, Eddie	850/622-5791
Williams, Glenn	850/622-5150
Williams, John K Sr	850/267-0273
Williams, Judy	850/622-2767
Williams, Kirby & Mary Blake	850/622-0541
Williams, Polly	850/622-5179
Williams, Robert	850/622-4707
Williams, Robert & Julia	850/622-0933
Williams, Robert W	850/267-3084
Willia, Lena	850/622-2399
Wilson, James W	850/267-3971
Wilson, Norville	850/267-2098
Wilson, Norville E	850/267-0403
Wilson, Terry L	850/267-4676
Winingder, Tom	850/267-3174
Wint, Frederick J	850/267-1211
Wise, Neil & Alice	850/267-0373
Womack, Charles & Marilyn	850/622-1434
Wong, Howard	850/622-1090
Wood, Anthony & Karen	850/622-1533, 850/622-1534
Wood, Richard	850/267-3706
Wolf, Bob & Phyllis	850/267-2557
Worthey, Joe & Jimmy	850/267-3554
Wright, Anthony & Vicky	850/267-4526
Wright, C Lamar & Ann	850/267-3027
Wright, Edwin & La Donna	850/267-5648
Wright, Harold E	850/267-0071
Wright, R	850/267-3407
Wright, Robert D & Wanda L	850/622-2789
Wyatt, Joe Lee & Jean	850/267-3825
Yarbro, John & Connie	850/267-2959
Yarbrough, R	850/622-2206
York, John & Charlotte	850/267-6087
Young, W L	850/622-6297
Youngblood, Ellie & Lance	850/267-1953

GENERAL EXCHANGE TARIFF

Embarq Florida, Inc.

BY: F. B. Poag  
Director

SECTION A3  
First Revised Sheet 50.31  
Cancelling Original Sheet 50.31  
Effective: September 15, 2004

BASIC LOCAL EXCHANGE SERVICE

E. LOCAL EXCHANGE EXCEPTIONS (Cont'd)

15. Destin (Continued)

.1 Residence Customers (Continued)

Youngblood, Ken & Marian	850/622-3767
Yusupova, E	850/622-2762
Zito, Joseph & Judith	850/267-3125
Zwaska, John & Virginia	850/622-9178
Zwick, B	850/622-5162
Abbott, Jackie	Non-Published
Adams, Charles	Non-Published
Adams, Paul	Non-Published
Allen, James C	Non-Published
Aronson, Kirk & Kimber	Non-Published
Badessi, Jorge	Non-Published
Baioni, Louis	Non-Published
Barnes, Art & Frances	Non-Published
Beasley, J L	Non-Published
Becker, C	Non-Published
Bloom, G V	Non-Published
Brown, Charles K	Non-Published
Caldwell, Jack	Non-Published
Chambers, Richard	Non-Published
Chrenker, Marcus & Michelle	Non-Published
Colson, Kera	Non-Published
Coon, Robert	Non-Published
Degregorio Jennifer E	Non-Published
Dray, Marion	Non-Published
Dugas, Stephen H	Non-Published
Estes, J Norman	Non-Published
Figg, Ann	Non-Published
Finamore, J & S	Non-Published
Garrett, Sherri	Non-Published
Grant, Darla	Non-Published
Hainsworth, Joseph C Sr	Non-Published
Haliday, Irene & John	Non-Published
Halpern, Norman	Non-Published
Hart, Jeff	Non-Published
Hendricks, John	Non-Published
Heyl, Cathy	Non-Published

GENERAL EXCHANGE TARIFF

Embarq Florida, Inc.

BY: F. B. Poag  
Director

SECTION A3  
First Revised Sheet 50.32  
Cancelling Original Sheet 50.32  
Effective: September 15, 2004

BASIC LOCAL EXCHANGE SERVICE

E. LOCAL EXCHANGE EXCEPTIONS (Cont'd)

15. Destin (Continued)

.1 Residence Customers (Continued)

Hohnadell, Gale & Kim	Non-Published
Jiannetto, Daniel	Non-Published
Kish, Diana	Non-Published
Kochalski, Joseph & Virginia	Non-Published
Lafferty, Beverly	Non-Published
Lawless, K Gordon	Non-Published
Lee, James L	Non-Published
Lehman, Carmen	Non-Published
Lyle, George C & Eva H	Non-Published
Lynn, Darrell	Non-Published
Mc Kern, James & Donna	Non-Published
Mcclelland, Harry	Non-Published
Miller, D J	Non-Published
Monaco, Beverly	Non-Published
Monaco, Beverly	Non-Published
Pace, Susan	Non-Published
Page, Patricia	Non-Published
Pastore, I	Non-Published
Pearce, R P Jr	Non-Published
Quinlan, Robin	Non-Published
Radke, Eroc & Wendy	Non-Published
Reece, Alan	Non-Published
Rhoads, Matt	Non-Published
Sshwartz, Harry	Non-Published
Sellers, R & D	Non-Published
Serra, Steve	Non-Published
Singh, Nahar	Non-Published
Smith, William M	Non-Published
Sobi, Rick	Non-Published
Somers, John & Julie	Non-Published
Taylor, Hamilton	Non-Published
Trainor, Matthew	Non-Published
Turner, Judith	Non-Published
Veldman, Richard	Non-Published
Watson, David	Non-Published
Wilhelm, John	Non-Published
Yeakley, Roger	Non-Published

GENERAL EXCHANGE TARIFF

Embarq Florida, Inc.

BY: F. B. Poag  
Director

SECTION A3  
First Revised Sheet 50.33  
Cancelling Original Sheet 50.33  
Effective: September 15, 2004

BASIC LOCAL EXCHANGE SERVICE

E. LOCAL EXCHANGE EXCEPTIONS (Cont'd)

15. Destin (Continued)

.2 Business Customers

Acme Oyster House	850-622-1900, 850-622-0069, 850-622-0200 850-622-1243, 850-622-1281
Adams Homes of Northwest Florida	850-622-1199, 850-622-1154
Almerica Overseas	850-622-1117
Aluminum Resources Inc	850-267-2053
Anchorage Condominiums	850-267-8402, 850-267-1613
Anchorage Home Owners Assoc	850-622-5691
Ann's Beauty Shop	850-267-0933
Another Broken Egg Café	850-622-2050, 850-622-1201, 850-622-1210
Automated Accounting Associates	850-267-9969
Baber Group	850-267-1954
Batchelor Mechanical Contractors Inc	850-267-1301
Beach Villas Assoc Inc	850-267-3108
Bistro Bijoux	850-622-0760, 850-622-0735
Blue Heron Salon at Tops'l	850-267-3578, 850-267-3579
Boswell Builders & Sons Inc	850-622-2790 850-622-2791, 850-622-2792
Broad & Cassel	850-267-2731, 850-267-2732
Burke Blue & Hutchinson P A	850-267-9498, 850-267-2991, 850-267-5665 850-267-9479, 850-267-9480, 850-267-9497 850-267-9499
Care Alliance at Crystal Bay	850-622-0945, 850-622-2081 850-622-3014
Chism Doug Landscape Architects	850-267-2050, 850-267-6046
Club Estates	850-267-3118
Costal Design Studio Inc	850-622-2380, 850-622-2733, 850-622-2755
Coastal Property Consultants Inc	850-267-3119, 850-267-1185, 850-267-1783 850-267-2993
Co-Co & Company	850-267-2727, 850-267-9403
Coffeen Nature Preserve	850-267-2312
Crystal Bay Senior Living at Sandestin	850-267-1600, 850-267-0405, 850-267-1593 850-267-1601, 850-267-1602, 850-267-1605 850-267-1606, 850-267-1606, 850-267-1704 850-267-3402, 850-267-3819, 850-267-4650 850-267-4652, 850-267-8490, 850-267-8491 850-267-9912, 850-267-9924, 850-622-9730
Destin Jewelers	850-622-0984, 850-622-0349, 850-622-4765

GENERAL EXCHANGE TARIFF

Embarq Florida, Inc.

BY: F. B. Poag  
Director

SECTION A3  
First Revised Sheet 50.34  
Cancelling Original Sheet 50.34  
Effective: September 15, 2004

BASIC LOCAL EXCHANGE SERVICE

E. LOCAL EXCHANGE EXCEPTIONS (Cont'd)

15. Destin (Continued)

.2 Business Customers

Dynetics	850-622-0223
Emerald Coast.Com	850-622-0327, 850-622-0562, 850-622-0922
	850-622-0965, 850-622-0979, 850-622-0991
	850-622-1012, 850-622-1086, 850-622-1653
	850-622-5706
Emeraldshores	850-622-2131, 850-622-2377
	Enterprise Rent-a-Car
Famous; Door Sandestin	850-267-0140, 850-267-2720, 850-267-8412
February Corporation	850-622-0913, 850-622-0963, 850-622-0967
Grandshores Management Group Inc	850-622-6222, 850-622-2125, 850-622-2126
	850-622-2127, 850-622-2128, 850-622-2129
	850-622-2130, 850-622-2132, 850-622-2133
	850-622-3720, 850-622-3747
Gulf Coast Real Estate Services	850-267-4575, 850-267-2823
Hardin Construction Co	850-267-0571, 850-267-1348, 850-267-1470
	850-267-1947, 850-267-3192
Harry Norman Realtors Inc	850-267-3877
Headstart Haircare Salon	850-267-0740, 850-267-1543, 850-267-2446
Hilton Sandestin Beach	850-267-9500, 850-267-0062, 850-267-0063
	850-267-0080, 850-267-0171, 850-267-0246
	850-267-0247, 850-267-0248, 850-267-0249
	850-267-0250, 850-267-0431, 850-267-0711
	850-267-0961, 850-267-0962, 850-267-0963
	850-267-1197, 850-267-1317, 850-267-1368
	850-267-1406, 850-267-1451, 850-267-1475
	850-267-1559, 850-267-1578, 850-267-1599
	850-267-1816, 850-267-2255, 850-267-2491
	850-267-2935, 850-267-2958, 850-267-3076
	850-267-3134, 850-267-4602, 850-267-9501
	850-267-9502, 850-267-9503, 850-267-9504
	850-267-9505, 850-267-9506, 850-267-9507
	850-267-9508, 850-267-9509, 850-267-9510
	850-267-9511, 850-267-9512, 850-622-0005
850-622-1500, 850-622-1508, 850-622-1514	
850-622-1581, 850-622-3085, 850-622-3095	
850-622-9594, 850-622-9595	
Howard Promotions	850-622-1865, 850-622-1761
Huff & Associates	850-622-1049

GENERAL EXCHANGE TARIFF

Embarq Florida, Inc.

BY: F. B. Poag  
Director

SECTION A3  
First Revised Sheet 50.35  
Cancelling Original Sheet 50.35  
Effective: September 15, 2004

BASIC LOCAL EXCHANGE SERVICE

E. LOCAL EXCHANGE EXCEPTIONS (Cont'd)

15. Destin (Continued)

.2 Business Customers

Intra West Ownership Corp	850-267-0791, 850-267-0539, 850-267-3280 850-267-4956, 850-622-0346, 850-622-0392 850-622-0472, 850-622-0659, 850-622-0673 850-622-0675, 850-622-0736, 850-622-0738 850-622-0763, 850-622-0864, 850-652-0874 850-622-0941, 850-622-0976, 850-622-1259 850-622-4764, 850-622-4789
John Macmanus Co	850-267-2013
Keyko-Max Limited Partnership	850-622-1537
Magnolia & Ivy	850-267-2595, 850-267-0073, 850-267-4636
Mailho Company	850-267-1472, 850-267-1473, 850-267-1491 850-267-5656
Miracle strip Wireless Inc	850-622-0622
Moe's Southwest Grill	850-267-9008, 850-267-0482, 850-267-9082
Ocean Club Restaurant	850-267-3666, 850-267-0380, 850-267-3438 850-267-3439, 850-267-4922, 850-622-0236 850-622-4708
Onmi Landscaping Group	850-622-6280, 850-622-5636, 850-622-6281 850-622-6282
Page O'Connor Fine Arts Inc	850-267-8433, 850-267-8434
Paint'n Place	850-267-6062, 850-267-3206
Paradise Found Vacation Rentals	850-267-0411, 850-267-0587, 850-267-2532
Pearce Group	850-267-3000, 850-267-3300, 850-267-0513 850-267-0684, 850-267-0685, 850-267-0686 850-267-0687, 850-267-1094, 850-267-1329 850-267-1358, 850-267-1418, 850-267-1495 850-267-2630, 850-267-3430, 850-267-3557 850-267-3864, 850-267-4635, 850-267-5630 850-267-9000, 850-622-0144, 850-622-0170 850-622-1000, 850-622-1111, 850-622-1998
Pelican Real Estate	850-622-3360, 850-622-3358, 850-622-3359
Point of View	850-267-2893, 850-267-2918, 850-267-5682 850-267-6023, 850-267-6081, 850-267-6082
Publix Super Markets	850/622-2098, 850/622-2326, 850/622-2724 850/622-2745, 850/622-2746, 850/622-2786 850/622-3046, 850/622-3053, 850/622-3078 850/622-3098, 850/622-3374, 850/622-3376 850/622-3378, 850/622-3394, 850/622-3395 850/622-3772

GENERAL EXCHANGE TARIFF

Embarq Florida, Inc.

BY: F. B. Poag  
Director

SECTION A3  
First Revised Sheet 50.36  
Cancelling Original Sheet 50.36  
Effective: September 15, 2004

BASIC LOCAL EXCHANGE SERVICE

E. LOCAL EXCHANGE EXCEPTIONS (Cont'd)

15. Destin (Continued)

.2 Business Customers

Quizno's Subs	850-622-0666, 850-622-0370, 850-622-1066 850-622-1180
Raspberry Rhino	850-622-1551, 850-622-0614
Sacred Heart Foundation	850-267-9095, 850-267-9096-850-267-9967
Sandestin Wine World & Liquor	850-622-0802, 850-622-0803, 850-622-0804 850-622-0805, 850-622-0806
Seagrapes Wine Cave	850-267-2526, 850-267-1377
Specialized Financial Systems	850-267-2588
Starbucks Coffee	850-267-3990, 850-267-0915, 850-267-0921 850-267-9581
Sun Treasures Inc	850-622-0233
Sweet Homebuilders Inc	850-622-2214
The Studio Manufactures Inc	850-622-2219, 850-622-2084
The Three B's LLC	850-267-1200
Tri City Electric	850-267-4606
UPS Store	850-267-6050, 850-267-6005, 850-267-6056 850-267-9002
Village Babes	850-622-1404
Vitamin World Inc	850-622-1589, 850-622-1821, 850-622-1835
W H Smith	850-267-9906, 850-267-9981
Wachovia Mortgage Corporation	850-622-1194, 850-622-1241, 850-622-2785 850-622-3731
White Sands Window Cleaning Services	850-622-5950
Amsouth Bank	Non-Published
Anchorage Condominiums Association	Non-Published
Bay Town Commercial	Non-Published
Blind Ambition	Non-Published
Crescent Mortgage	Non-Published
Fla Comm Svcs	Non-Published
Fountains at Sandestin	Non-Published
Four Mile Vlg Homeowners Association	Non-Published
Gulf Power Company	Non-Published
Howard Group	Non-Published
Mattress Outlet	Non-Published
Mediacom	Non-Published
Money Tree ATM	Non-Published
Pine Ridge Villas Association	Non-Published
Pro'Formance Plastering	Non-Published

GENERAL EXCHANGE TARIFF

Embarq Florida, Inc.

BY: F. B. Poag  
Director

SECTION A3  
First Revised Sheet 50.37  
Cancelling Original Sheet 50.37  
Effective: September 15, 2004

BASIC LOCAL EXCHANGE SERVICE

E. LOCAL EXCHANGE EXCEPTIONS (Cont'd)

15. Destin (Continued)

.2 Business Customers

Sandestine Homeowners Association	Non-Published
Sandestin Resort	Non-Published
Sacred Heart Hospital on the Emerald Coast	Non-Published
Embarq Florida, Inc	Non-Published
Payphone Services Inc	Non-Published
Summit at Tops'l	Non-Published
Sun Healthcare Group	Non-Published
U S Health & Fitness Corp	Non-Published
Tides Owners Association	Non-Published



## GENERAL EXCHANGE TARIFF

Embarq Florida, Inc.

By: F. B. Poag  
Director

SECTION A3  
Eleventh Revised Sheet 51  
Cancelling Tenth Revised Sheet 51  
Effective: November 12, 2004

### BASIC LOCAL EXCHANGE SERVICE

#### F. DIRECTORY ASSISTANCE

##### 1. General

- a. Directory Assistance Service is provided by the Telephone Company to assist the users of the service in obtaining telephone numbers.
- b. The rates set forth following apply when subscribers of the company request assistance in determining telephone numbers of subscribers (1) who are located in the same Local Calling Area or, (2) who are not located in the same Local Calling Area or Home Numbering Plan Area as the subscriber's serving exchange.
- c. There will be no charge for Local Calling Area Directory Assistance calls received from customers with a physical or mental impairment rendering them unable to use the telephone directory.
- d. Calls to Long Distance Directory Assistance are charged for at the appropriate rate.
- e. Directory Assistance Service for Outside the Local / Home Numbering Plan Area is not available for Pay Telephone Service as described in Section A7 of this tariff.

##### 2. Rates and Charges

###### a. Local Calling Area

- 1) A charge of \$.55 is applicable for each call to Directory Assistance, except as noted in 3) following.
- 2) A maximum of two numbers may be requested on each call.
- 3) A customer is allowed one Directory Assistance call per access line or PBX trunk line per billing period without charge. This allowance is cumulative for group billed services. A subscriber to Centrex Service is allowed one Directory Assistance call per billing period for each Centrex station line at no charge.

GENERAL EXCHANGE TARIFF

Embarq Florida, Inc.

By: F. B. Poag  
Director

SECTION A3  
Eighth Revised Sheet 52  
Cancelling Seventh Revised Sheet 52  
Effective: March 1, 2003

BASIC LOCAL EXCHANGE SERVICE

F. DIRECTORY ASSISTANCE

2. Rates and Charges (Cont'd)

b. Outside the Local / Home Numbering Plan Area

- 1) A charge of \$.95 is applicable for each call to Directory Assistance.
- 2) A maximum of two numbers may be requested on each call.

c. In locations where the customer has the technical capability to direct dial Directory Assistance but places the call by dialing "0", Operator Assisted Station-to-Station Charges listed in Section A3.H.3.b. will apply, in addition to the Directory Assistance Service Charge.

G. DIRECTORY ASSISTANCE CALL COMPLETION (DACC)

1. General

- a. Directory Assistance Call Completion (DACC) provides an incoming Directory Assistance customer requesting a local or IntraLATA number a mechanized announcement offering call completion to the listed number requested, excluding nonpublished numbers. The call is completed on a sent-paid basis which is paid for by the calling customer, except on 0+HNPA+555 calls which will allow Calling Card and Billed to Third Number Charges.
- b. The mechanized announcement will instruct the caller that for an additional charge, they may have the call automatically completed by depressing a specific digit on the key pad. All completed calls will be charged the DACC charge, in addition to any other appropriate charges.

GENERAL EXCHANGE TARIFF

Embarq Florida, Inc.

By: F. B. Poag  
Director

SECTION A3  
Second Revised Sheet 53  
Cancelling First Revised Sheet 53  
Effective: May 29, 1997

BASIC LOCAL EXCHANGE SERVICE

G. DIRECTORY ASSISTANCE CALL COMPLETION (DACC)

1. General (Cont'd)

- c. The Telephone Company assumes no responsibility or liability for any errors in the information furnished. The caller shall indemnify the Company and hold it free and harmless of and from any and all claims, demands, or damages that shall arise from the use of the service.
  - 1) This service is furnished solely for the telephone calling purposes of the caller.
  - 2) Additional provisions concerning limitations of liability and allowance for interruption of service are set forth in Section A2 of this tariff.
- d. This offering provides call completion on a Local Access and Transport Area (LATA) basis. Customers will need to consult their directory for LATA maps.
- e. DACC will be furnished only where facilities permit and where the service used by the customer can support all billing requirements for the service.
- f. Only the second provided Directory Assistance telephone number may be dialed and completed by DACC if two Directory Assistance requests are made during the same call.
- g. Customers who currently subscribe to a screening option that includes 1+ or 411 will not be eligible for this service.

GENERAL EXCHANGE TARIFF

Embarq Florida, Inc.

By: F. B. Poag  
Director

SECTION A3  
Third Revised Sheet 54  
Cancelling Second Revised Sheet 54  
Effective: June 3, 1997

BASIC LOCAL EXCHANGE SERVICE

G. DIRECTORY ASSISTANCE CALL COMPLETION (DACC)

1. General (cont'd)

h. DACC is not available for the following:

- 1) Alternately billed calls, i.e., Collect, Calling Card\*, or Billed to Third Number\*
- 2) Any PBX type customer who requires real-time notification of charges, i.e., hotels/motels, hospitals, etc.
- 3) Any special lines, i.e., prisons, etc.
- 4) 900/976 directory assistance number requests
- 5) Calls from Pay telephone, coin or coinless stations
- 6) InterLATA long distance calls
- 7) Cellular providers/wireless technology
- 8) Independent telephone companies that access the Company's directory assistance service
- 9) WATS
- 10) Alternate or Competitive Local Exchange Companies
- 11) N11 services

i. Local and intraLATA individual message detail is included as a part of this service.

j. DACC is not subject to concessions.

\* On 0+HNPA+555 calls, Calling Card and Billed to Third Number charges will be allowed.

GENERAL EXCHANGE TARIFF

Embarq Florida, Inc.

By: F. B. Poag  
Director

SECTION A3  
Seventh Revised Sheet 55  
Cancelling Sixth Revised Sheet 55  
Effective: October 24, 2003

BASIC LOCAL EXCHANGE SERVICE

G. DIRECTORY ASSISTANCE CALL COMPLETION (DACC)

2. Rates and Charges

- a. The DACC service charge specified will be applicable to all subscribers, except that DACC service charges are not applicable to handicapped customers who are exempt from Directory Assistance charges.
- b. For charging purposes, a completed call is defined in Section A1 of this tariff.
- c. Service Charges

	Rate
DACC service charge, per completed call	\$.50

H. OPERATOR ASSISTED LOCAL CALLS

- 1. All types of local exchange service have local calling areas as specified previously in this tariff which are the areas that can be called on a flat-rate basis (no charge for individual calls), on a local coin call rate basis, or a measured or message rate basis.
- 2. Local dial calls must be dialed and completed without the assistance of a Company operator and must be billed to the originating telephone when a charge is applicable. Otherwise, operator assistance charges will apply to the call, in addition to the applicable local dial rate.
- 3. The following service charges apply in addition to the local dial rate applicable for operator assisted local calls.
  - a. Station-to-Station customer dialed credit card local call \$1.00
  - b. Station-to-Station operator assisted sent-paid, collect, third number, and non-customer-dialed credit card calls \$1.60
  - c. Person-to-Person operator assisted local call \$4.00

GENERAL EXCHANGE TARIFF

Embarq Florida, Inc.

By: F. B. Poag  
Director

SECTION A3  
Second Revised Sheet 56  
Cancelling First Revised Sheet 56  
Effective: May 29, 1997

BASIC LOCAL EXCHANGE SERVICE

H. OPERATOR ASSISTED LOCAL CALLS (Cont'd)

4. The following Operator Assisted Local Calls are exempt from the service charge:
  - a. Calls to designated Company numbers for official telephone business.
  - b. Emergency calls to recognizable authorized civil agencies.
  - c. Those cases where a Company operator provides assistance to:
    - 1) re-establish a call which has been interrupted after the called number has been reached, or
    - 2) reach the called telephone number where facility problems prevent customer dial completion.
    - 3) Place a non-coin, sent-paid call for a calling party who identifies himself/herself as being handicapped and unable to dial the call because of that handicap.

## GENERAL EXCHANGE TARIFF

Embarq Florida, Inc.

By: F. B. Poag  
Director

SECTION A3  
Second Revised Sheet 57  
Cancelling First Revised Sheet 57  
Effective: May 29, 1997

### BASIC LOCAL EXCHANGE SERVICE

#### I. VERIFICATION AND EMERGENCY INTERRUPT SERVICE

##### 1. General

Verification and Emergency Interrupt Service is furnished where and to the extent that facilities permit. The customer shall indemnify and save the Company harmless against all claims that may arise from either party to the interrupted call or any person.

##### a. Verification

- 1) The Company furnishes Verification Service for the purpose of aiding subscribers with legitimate call completion problems. Upon request, the operator will verify and provide the line status condition of a local subscriber line.
- 2) A subscriber originated request for verification of a local number other than an emergency agency number is a chargeable verification request. No charge applies if the line is out of order.

##### b. Emergency Interrupt Service

- 1) The Company furnishes Emergency Interrupt Service when a subscriber who has originated a verification request to a line which has been found in a busy talking state informs the operator that an urgent or emergency situation exists and requests that the operator have the busy line cleared.
- 2) A subscriber originated request for Emergency Interrupt to a local number other than an emergency agency number is a chargeable Emergency Interrupt request.
- 3) An Emergency Interrupt requires verification. Both charges are applicable for an Emergency Interrupt Request.

GENERAL EXCHANGE TARIFF

Embarq Florida, Inc.

BY: F. B. Poag  
Director

SECTION A3  
Sixth Revised Sheet 58  
Cancelling Fifth Revised Sheet 58  
Effective: October 13, 2002

BASIC LOCAL EXCHANGE SERVICE

I. VERIFICATION AND EMERGENCY INTERRUPT SERVICE

2. Rates and Charges

- a. A charge of \$2.00 is applicable for each chargeable verification request as defined previously.
- b. A charge of \$2.00 in addition to the verification charge is applicable for each chargeable emergency interrupt request as defined previously.
- c. No charge will apply if the requesting customer identifies that the call is to or from an official public emergency agency. An official public emergency agency is defined as a government agency which is operated by the Federal, state or local government, and has the capability and legal authority to provide prompt and direct aid to the public in emergency situations. Such agencies include the local police, state police, fire department, licensed hospitals, etc.
- d. Charges may not be billed on a collect basis or on a third number basis to the number being verified or interrupted.
- e. If the number verified is not in use, or as a result of interrupt, the line is cleared, and at the calling party's request the operator completes the call, the charges for Operator Assisted Local Calls as defined in this tariff section apply in addition to the applicable verification and emergency interrupt charges.



## GENERAL EXCHANGE TARIFF

Embarq Florida, Inc.

By: F. B. Poag  
Director

SECTION A3  
Fifteenth Revised Sheet 59  
Cancelling Fourteenth Revised Sheet 59  
Effective: November 1, 2005

### BASIC LOCAL EXCHANGE SERVICE

#### J. LIFELINE ASSISTANCE PROGRAM

##### 1. General

- a. The Interstate Subscriber Line Charge Waiver and Matching Program adopted by the Florida Public Service Commission is a Lifeline Assistance Program and provides for a federal credit equal to 100% of the Interstate Subscriber Line Charge (SLC) of \$6.50 as shown in the Interstate Access Tariff, Section 4, an equivalent Company provided subsidy of \$5.75, plus an additional federal reduction of \$3.50 for a total credit of up to \$15.75 per month. Effective October 1, 2000, eligible applicants living on federally recognized Native American reservations will receive an additional credit of up to \$25.00 sufficient to reduce the monthly rate for local service to no less than \$1.00 inclusive of the subscriber line charge.
- b. The federal and Company credits are applied to the local service bills for qualified residential recipients of public assistance who apply for the credits and authorize agency verification of their participation in at least one of the following programs: Temporary Assistance to Needy Families (TANF), Medicaid, Supplementary Security Income (SSI), food stamps, Federal Public Housing Assistance (Section 8), Low-Income Home Energy Assistance Program (LIHEAP) and National School Lunch Program (free meals program only).
- c. An applicant living on federally recognized Native American reservations is eligible for additional credit as outlined in J.1.a. preceding, if he/she is currently a recipient of benefits from one of the following assistance programs: Temporary Assistance to Needy Families (TANF), Medicaid, Supplementary Security Income (SSI), food stamps, Federal Public Housing Assistance (Section 8), Low-Income Home Energy Assistance Program (LIHEAP), Federal Public Housing Assistance, Bureau of Indian Affairs (BIA) General Assistance, Tribally Administered Temporary Assistance for Needy Families, Head Start (only for those meeting its income qualifying standard) and National School Lunch Program (free meals program only).
- d. Additionally, customers not receiving benefits under one of the preceding programs, and whose total gross annual income does not exceed 135% of the federal poverty guidelines, meet the requirements of a State established means test and may apply directly to the Office of Public Counsel (OPC) for eligibility certification.
- e. Lifeline Assistance is available for one telephone line per residence, at the customer's principle place of residence.

GENERAL EXCHANGE TARIFF

Embarq Florida, Inc.

By: F. B. Poag  
Director

SECTION A3  
Eighth Revised Sheet 59.1  
Cancelling Seventh Revised Sheet 59.1  
Effective: September 19, 2005

BASIC LOCAL EXCHANGE SERVICE

J. LIFELINE ASSISTANCE PROGRAM - (Cont'd)

1. General - (Cont'd)

- f. SmallTalk Service as found in D.2. of this tariff section is not eligible for Lifeline Assistance.
- g. Vacation Service is not applicable to lines with Lifeline assistance.
- h. Local Service may not be disconnected for failure to pay toll charges.
- i. Toll Blocking services are available to Lifeline customers at no charge.
- j. Deposits may not be collected from customers who select toll blocking. If a Lifeline customer removes Toll Blocking prior to establishing an acceptable credit history, a deposit may be required. When applicable, advance payments will not exceed the connection and local service charges for one month.
- k. Federal Universal Service Fund End User Charge will not be billed to Lifeline customers.
- l. From September 19, 2005 through March 31, 2006, relocated victims of Hurricane Katrina from the following areas:
  - 1. Any Louisiana parish
  - 2. Any Mississippi county
  - 3. Baldwin, Choctaw, Clarke, Greene, Hale, Jefferson, Marengo, Mobile, Pickens, Sumter, Tuscaloosa or Washington Counties in Alabama

may receive Lifeline assistance without qualifying under 1.b., 1.c. or 1.d above upon self certification of displacement from the above identified areas and qualification for any federal or state disaster relief program. Effective April 1, 2006, Hurricane Katrina Lifeline benefits will be discontinued unless the subscriber qualifies under one of the above programs.

GENERAL EXCHANGE TARIFF

Embarq Florida, Inc.

By: F. B. Poag  
Director

SECTION A3  
First Revised Sheet 59.1.1  
Cancelling Original Sheet 59.1.1  
Effective: September 19, 2005

BASIC LOCAL EXCHANGE SERVICE

J. LIFELINE ASSISTANCE PROGRAM - (Cont'd)

2. Applications and Regulations

a. Guidelines for implementation of this program are as follows:

- 1) Certification Procedures – As proof of eligibility, all applicants for this service will sign a Simplified Certification Document, certifying under penalty of perjury, that the customer is receiving benefits from one of the programs identified in paragraph J.1.b, above, identifying the specific program or programs from which the customer receives benefits, and agreeing to notify the Company if the customer ceases to participate in such program or programs.

The Simplified Certification Document will be provided to the customer by the Company, upon request.

- 2) Processing Procedures -- The Company will process all Simplified Certification Documents and apply the appropriate credit on the subscriber's monthly bill.
- 3) Verification Procedures -- The Company reserves the right to periodically audit its records, working in conjunction with the appropriate state agencies, for the purpose of determining continuing eligibility. Information obtained during such audit will be treated as confidential information to the extent required under State and Federal laws. The use or disclosure of information concerning enrollees will be limited to purposes directly connected with the administration of the Lifeline plan.

## GENERAL EXCHANGE TARIFF

Embarq Florida, Inc.

By: F. B. Poag  
Director

SECTION A3  
Second Revised Sheet 59.2  
Cancelling First Revised Sheet 59.2  
Effective: October 5, 2000

### BASIC LOCAL EXCHANGE SERVICE

#### J. LIFELINE ASSISTANCE PROGRAM – (Cont'd)

##### 2. Applications and Regulations – (Cont'd)

- a. Guidelines for implementation of this program are as follows: - (Cont'd)

3) - (Cont'd)

When a customer is determined to be ineligible as a result of an audit, the Company will contact the customer. If the customer cannot provide eligibility documentation, the Lifeline credit will be discontinued on the following bill.

- b. No Secondary Service Ordering Charges will apply when this service is initiated or canceled by a subscriber.
- c. A Lifeline customer's basic local service will not be disconnected for non-payment of unpaid toll charges or ancillary services, but may be disconnected for non-payment of basic local service charges, taxes and fees. Access to toll service may be denied for non-payment of regulated tolls. Access to ancillary services may be denied for non-payment of basic local service charges. A Lifeline customer's request for reconnection of basic local service will not be denied if the service was previously denied for non-payment of toll or ancillary charges. Partial payments will first be applied to basic local service.
- d. Lifeline eligible customers who have previously been disconnected for nonpayment of local charges may obtain local service equipped with toll blocking upon payment of outstanding debt for regulated non-toll charges, taxes and fees. Toll blocking shall not be removed prior to receipt of full payment of all outstanding toll charges.
- e. Payment for the outstanding debt associated with Basic Local Service and associated taxes and fees may be paid in installments for a period of not less than four months. Should the customer default on this payment arrangement, service will be disconnected and the customer must pay the outstanding non-toll balance in full before local service will be reestablished. Installment payments are not available on defaulted amounts previously installment billed.
- f. Payment for other outstanding debt will be pursued in the same manner as for non-Lifeline customers.

GENERAL EXCHANGE TARIFF

Embarq Florida, Inc.

By: F. B. Poag  
Director

SECTION A3  
Third Revised Sheet 60  
Cancelling Second Revised Sheet 60  
Effective: June 16, 1998

BASIC LOCAL EXCHANGE SERVICE

K. TRANSITIONAL LIFELINE ASSISTANCE PROGRAM

1. General

- a. Transitional Lifeline Assistance is a state program which provides a 30% reduction of the applicable monthly exchange flat rate for residential basic local service for subscribers who no longer qualify for the Lifeline Assistance Program.

2. Regulations

- a. A Lifeline Assistance subscriber who requests this service will receive the discounted rate for a period of one (1) year from the date the subscriber ceases to be qualified for the Lifeline Assistance Program.

L. SPECIAL ACCESS SERVICES

1. General

- a. When a special access line, intraLATA interexchange private line or Private Bypass Facility is connected to a device capable of and for the intention of completing calls into the local exchange network, there will be an additional measured or message charge associated with the flat rate local service rate for that device (i.e., the PBX trunk in the case of a PBX). Those customers who intend to use their special access line, intraLATA interexchange private line or private bypass facility for the completion of calls into the local exchange network and have local exchange service other than flat rate will be required to convert to flat rate.
- b. The measured charge will apply where facilities and equipment are available in the exchange central office. In all other exchange central offices, the message charge will apply. As facilities and equipment become available in central offices, measured charges will apply.

GENERAL EXCHANGE TARIFF

Embarq Florida, Inc.

BY: F. B. Poag  
Director

SECTION A3  
Eighth Revised Sheet 61  
Cancelling Seventh Revised Sheet 61  
Effective: October 6, 2005

BASIC LOCAL EXCHANGE SERVICE

L. SPECIAL ACCESS SERVICES

2. Application of Additional Measured or Message Charges

These usage charges are in addition to all other applicable local service rates and charges.

- |   |        |
|---|--------|
| a. Measured Charge, per minute of local usage | \$ .03 |
| b. Message Charge, per local message          | \$ .12 |

Please refer to the Private Line tariff for specific regulations.

M. STORM COST RECOVERY CHARGE

1. General

In accordance with the Florida Public Service Commission's ruling in Docket No. 050374-TL, a charge will be assessed to each Access Line or Facility beginning October 6, 2005 through October 5, 2007. This charge is designed to recover extraordinary expenditures incurred by the Company for storm damage restoration related to Hurricanes Charley, Frances, Jeanne and Ivan during 2004. This surcharge will not be assessed to Lifeline customers.

2. Rates and Charges

	<u>Monthly Rate</u>
Per Access Line	\$0.85 *

\* For each PBX Trunks multiply the rate by two. For each ISDN-PRI multiply the rate by five for each T-1 facility.

GENERAL EXCHANGE TARIFF

Embarq Florida, Inc.

BY: F. B. Poag  
Director

SECTION A3  
Fifth Revised Sheet 62  
Cancelling Fourth Revised Sheet 62  
Effective: May 4, 2005

BASIC LOCAL EXCHANGE SERVICE

RESERVE FOR FUTURE USE

GENERAL EXCHANGE TARIFF

Embarq Florida, Inc.

BY: F. B. Poag  
Director

SECTION A3  
Sixteenth Revised Sheet 63  
Cancelling Fifteenth Revised Sheet 63  
Effective: May 4, 2005

BASIC LOCAL EXCHANGE SERVICE

RESERVE FOR FUTURE USE



GENERAL EXCHANGE TARIFF

Embarq Florida, Inc.

BY: F. B. Poag  
Director

SECTION A3  
Twelfth Revised Sheet 63.1  
Cancelling Eleventh Revised Sheet 63.1  
Effective: May 4, 2005

BASIC LOCAL EXCHANGE SERVICE

RESERVE FOR FUTURE USE

GENERAL EXCHANGE TARIFF

Embarq Florida, Inc.

BY: F. B. Poag  
Director

SECTION A3  
Sixth Revised Sheet 63.2  
Cancels Fifth Revised Sheet 63.2  
Effective: May 4, 2005

BASIC LOCAL EXCHANGE SERVICE

RESERVE FOR FUTURE USE

GENERAL EXCHANGE TARIFF

Embarq Florida, Inc.

BY: F. B. Poag  
Director

SECTION A3  
Third Revised Sheet 63.3  
Cancels Second Revised Sheet 63.3  
Effective: May 4, 2005

BASIC LOCAL EXCHANGE SERVICE

RESERVE FOR FUTURE USE

GENERAL EXCHANGE TARIFF

Embarq Florida, Inc.

BY: F. B. Poag  
Director

SECTION A3  
Second Revised Sheet 63.4  
Cancels First Revised Sheet 63.4  
Effective: May 4, 2005

BASIC LOCAL EXCHANGE SERVICE

RESERVE FOR FUTURE USE

GENERAL EXCHANGE TARIFF

Embarq Florida, Inc.

BY: F. B. Poag  
Director

SECTION A3  
Fifth Revised Sheet 64  
Cancelling Fourth Revised Sheet 64  
Effective: May 4, 2005

BASIC LOCAL EXCHANGE SERVICE

RESERVE FOR FUTURE USE

GENERAL EXCHANGE TARIFF

Embarq Florida, Inc.

BY: F. B. Poag  
Director

SECTION A3  
Fourth Revised Sheet 65  
Cancelling Third Revised Sheet 65  
Effective: May 4, 2005

BASIC LOCAL EXCHANGE SERVICE

RESERVE FOR FUTURE USE

GENERAL EXCHANGE TARIFF

Embarq Florida, Inc.

BY: F. B. Poag  
Director

SECTION A3  
Eleventh Revised Sheet 66  
Cancelling Tenth Revised Sheet 66  
Effective: May 4, 2005

BASIC LOCAL EXCHANGE SERVICE

RESERVE FOR FUTURE USE

GENERAL EXCHANGE TARIFF

Embarq Florida, Inc.

BY: F. B. Poag  
Director

SECTION A3  
Sixth Revised Sheet 67  
Cancels Fifth Revised Sheet 67  
Effective: May 4, 2005

BASIC LOCAL EXCHANGE SERVICE

RESERVE FOR FUTURE USE



GENERAL EXCHANGE TARIFF

Embarq Florida, Inc.

Section A4

By: F. B. Poag  
Director

Third Revised Contents Sheet 1  
Cancelling Second Revised Contents Sheet 1  
Effective: November 12, 2004

SERVICE CHARGES

CONTENTS

	SHEET
A. GENERAL .....	1
B. DEFINITIONS/APPLICATION OF CHARGES.....	1
1. Service Ordering Charge.....	1
2. Access Line Charge .....	1
3. Premises Visit Charge.....	2
4. Premises Visit Work Charge .....	3
5. Record Change Charge .....	3
6. Restore Service.....	3
7. Telephone Number Change.....	4
C. REGULATIONS .....	4
D. SERVICE CHARGES FOR MOVES AND CHANGES .....	7
E. RATES AND CHARGES.....	9
F. TROUBLE LOCATION CHARGE .....	10
G. LINK-UP FLORIDA .....	11

## GENERAL EXCHANGE TARIFF

Embarq Florida, Inc.

By: F. B. Poag  
Director

Section A4  
First Revised Sheet 1  
Cancelling Original Sheet 1  
Effective: January 1, 1997

### SERVICE CHARGES

#### A. GENERAL

1. A service charge represents the charge for one or more work functions necessary to perform a service connection, move, or change.

#### B. DEFINITIONS/APPLICATION OF CHARGES

1. Service Ordering Charge (Primary and Secondary) The charge appropriate for receiving and recording information and/or taking action in connection with a customer or applicant and processing the necessary data.
  - a. The service order charge applies per customer request for work performed by the Company to be completed for the same account at the same premises, on the same date.
  - b. Where more than one account is located at the same premises, work on each individual account will be considered separately.
  - c. One Service Ordering Charge is applicable for each channel (circuit) between two points on separate premises. Multiple channels between the same points, or multi-point channels, or extension of mileage channels, ordered at the same time are included under the same Service Ordering Charge.
2. Access Line Charge Work associated with the line extending from the serving central office to the customer's demarcation point. Includes, but is not limited to, central office connections, cable cross connections, and connecting and disconnecting the drop and block wires.

GENERAL EXCHANGE TARIFF

Embarq Florida, Inc.

By: F. B. Poag  
Director

Section A4  
First Revised Sheet 2  
Cancelling Original Sheet 2  
Effective: January 1, 1997

SERVICE CHARGES

B. DEFINITIONS/APPLICATION OF CHARGES (Cont'd)

2. (Cont'd)

a. The access line charge applies for work including but not limited to:

- 1) Making and changing connections in the central office
- 2) Making and changing connections in distribution facilities between the central office and the customer's demarcation point, including necessary cross connections and line transfers.

3. Premises Visit Charge The charge that applies for a visit to the customer's premises for customer-requested rearrangement of drop wire, protector and/or Telephone Network Interface device (TNI).

- a. The premises visit charge applies only for a visit to the customer's premises to relocate or rearrange drop wire, protector and/or TNI at the customer's request.
- b. When more than one visit is necessary to complete the work due to Company reasons, only one Premises Visit Charge applies.
- c. This charge does not apply for disconnect work.
- d. For each trip to more than one customer location, a premises visit charge will apply for each location visited.

GENERAL EXCHANGE TARIFF

Embarq Florida, Inc.

By: F. B. Poag  
Director

Section A4  
First Revised Sheet 3  
Cancelling Original Sheet 3  
Effective: January 1, 1997

SERVICE CHARGES

B. DEFINITIONS/APPLICATION OF CHARGES (Cont'd)

4. Premises Work Charge Includes work performed on the customer's premises other than work required to establish network access.
  - a. The premises work charge applies to work performed on the customer premises for customer requested rearrangement of the drop wire, protector and/or TNI.
5. Record Change Charge The charge appropriate for adding or changing directory listings at the customer's request.
  - a. The record change charge applies for changing listings at the customer's request. It does not apply for corrections of name or address or for listings changed for Company reasons.
6. Restore Service The charge applicable to restoration of service following a temporary suspension of service. The suspension of service may be at the customer's request or for nonpayment of charges.
  - a. In the event service is temporarily suspended at the subscriber's request, such service will be restored at the charges listed following.
  - b. In the event service is temporarily interrupted for nonpayment, such service will be restored upon payment of charges due or, at the discretion of the Company, a substantial portion thereof, and the Restore Service charges will be applicable.

GENERAL EXCHANGE TARIFF

Embarq Florida, Inc.

By: F. B. Poag  
Director

Section A4  
Fifth Revised Sheet 4  
Cancelling Fourth Revised Sheet 4  
Effective: June 4, 2005

SERVICE CHARGES

B. DEFINITIONS/APPLICATION OF CHARGES (Cont'd)

7. Telephone Number Change For performing work associated with a customer's request for changes in telephone numbers.
  - a. The charge for Telephone Number Change is per line.

C. REGULATIONS

1. Service charges will apply for, but not limited to:
  - a. All classes of access line service
  - b. PBX trunks
  - c. Data transport services
  - d. Centrex service
  - e. Mobile interconnection
  - f. Pay Telephone Service (PATS)
  - g. Shared Tenant Service (STS)
  - h. Miscellaneous facilities
  - i. Dormitory Service stations

GENERAL EXCHANGE TARIFF

Embarq Florida, Inc.

By: F. B. Poag  
Director

Section A4  
Second Revised Sheet 5  
Cancelling First Revised Sheet 5  
Effective: April 1, 1997

SERVICE CHARGES

C. REGULATIONS (Cont'd)

2. Service charges do not apply for:
  - a. The substitution of the name of another member of the family for that already listed in the directory, nor for correction in the addresses in the directory.
  - b. Telephone Service previously provided over a Government system where there is no break in the continuity of service.
  - c. Company-initiated directory listings or changes in class or grade of service.
  - d. Upgrades or downgrades to or from flat rate service to measured rate service.
3. When service is re-established at a location which has been destroyed by fire, flood, or wind, or made untenable by fire, flood, or wind, service connection charges do not apply when the service is re-established within a reasonable time. If the subscriber desires service at a new location for a temporary period, the service connection charge will apply covering the establishment of service at the temporary location, but no service connection charge will apply when service is re-established at the former location. If the subscriber desires service established at a new and permanent location, then the service connection charge will apply. Changes in a location of existing access line terminations to points outside the premises occupied by the subscriber are considered as new service connections at the new location.

## GENERAL EXCHANGE TARIFF

Embarq Florida, Inc.

By: F. B. Poag  
Director

Section A4  
First Revised Sheet 6  
Cancelling Original Sheet 6  
Effective: January 1, 1997

### SERVICE CHARGES

#### C. REGULATIONS (Cont'd)

4. In all cases where construction or installation charges apply, such charges are in addition to the prescribed service connection charges. Service Ordering Charges apply in addition to, and not in lieu of, mileage charges, initial Nonrecurring Charges, as well as Construction Charges.
5. Except as provided in this paragraph, service connection charges are required to be paid when the desired work functions are requested. For existing subscribers, additional service may be established in advance of payment of service connection charges. Service may be established in advance of payment of service connection charges for additions to the service provided for the use of departments, administrations, or agencies of the Federal, State, County, or Municipal governments.
6. Where the service desired requires more than one order, premises work, or access line work function, the total charge is the sum of the separate charges for each function required, except as provided elsewhere in this tariff.
7. The service connection charges specified in this tariff contemplate work being performed during regular scheduled working hours. Work performed during non-scheduled hours will necessitate the subscriber paying an additional charge on costs incurred for such nonscheduled work.
8. Applicants for service may pay service connection charges in equal monthly installments over a period of at least three months. The Company will charge a service fee of \$1.00 for each monthly installment billing of service connection charges.

GENERAL EXCHANGE TARIFF

Embarq Florida, Inc.

By: F. B. Poag  
Director

Section A4  
First Revised Sheet 7  
Cancelling Original Sheet 7  
Effective: January 1, 1997

SERVICE CHARGES

C. REGULATIONS (Cont'd)

9. A Record Change Charge will be appropriate for changes from residence to business service. From business to residence service, a Secondary Service Ordering Charge will apply if a telephone number change is required.
10. Concessions
  - a. In connection with service at a concession rate, except for employee concession, no concession is allowed from the regular service connection charges.
  - b. In connection with Residence Service for Company Employees, which is furnished at a reduced rate, a reduction is allowed from the regular service connection charges, as specified in Section A2.

D. SERVICE CHARGES FOR MOVES AND CHANGES

1. Charges for changes requested by the subscriber apply as follows:
  - a. Additions or changes to directory listings except for corrections to the listing or address or changes initiated by the Company.
  - b. Telephone number changes requested by the subscriber.



GENERAL EXCHANGE TARIFF

Embarq Florida, Inc.

By: F. B. Poag  
Director

Section A4  
Second Revised Sheet 8  
Cancelling First Revised Sheet 8  
Effective: April 1, 1997

SERVICE CHARGES

D. SERVICE CHARGES FOR MOVES AND CHANGES (Cont'd)

1. (Cont'd)

- c. For rearrangement of drop wire, protector, and/or Telephone Network Interface Device (TNI), the Secondary Service Ordering Charge, Premises Visit Charge and the Premises Work Charge applicable to the access line or PBX trunk, as appropriate, will apply.
2. Secondary service ordering charges apply for moving or changing existing service, or adding new or additional service other than access lines.
3. Charges for moves and changes do not apply as follows:
  - a. Stations for which no exchange service charges apply; i.e., Company stations whether installed in offices or residences of Company officials or employees.
  - b.
  - c. Moves or changes required for the proper maintenance of the service.
  - d. Changes in telephone number made where, in the judgment of the Company, it is necessary for continuation of satisfactory service.

GENERAL EXCHANGE TARIFF

Embarq Florida, Inc.

BY: F. B. Poag  
Director

Section A4  
Fifth Revised Sheet 9  
Cancelling Fourth Revised Sheet 9  
Effective: November 1, 2005

SERVICE CHARGES

E. RATES AND CHARGES

	<u>Residence</u>	<u>Business</u>
1. Service Ordering Charges, each order		
a. Primary associated with access line	\$23.00	\$32.00
b. Secondary	12.00	18.00
c. Access Line Charge, each line	30.00	37.00
d. Premises Visit Charge	20.00	30.00
e. Premises Work Charge, per ¼ Hour or fraction thereof	12.00	12.00
f. Record Change Charge	12.00	18.00
g. Telephone Number Change, including Service ordering charge, each	12.00	18.00
h. Restore Service	24.00	24.00

GENERAL EXCHANGE TARIFF

Embarq Florida, Inc.

BY: F. B. Poag  
Director

Section A4  
Ninth Revised Sheet 10  
Cancelling Eighth Revised Sheet 10  
Effective: November 12, 2004

SERVICE CHARGES

F. TROUBLE LOCATION CHARGE

A Trouble Location Charge will apply when a report of trouble results in a visit to the customer's premises and the trouble is found on the customer's side of the demarcation point in customer owned CPE or customer owned inside wire. A Trouble Location Charge (TLC) does not apply if the customer does not have a Telephone Network Interface (TNI) device.

Charge, per visit	
Residence	\$50.00
Business	50.00
Enhanced Frame Relay	75.00

## GENERAL EXCHANGE TARIFF

Embarq Florida, Inc.

By: F. B. Poag  
Director

Section A4  
Second Revised Sheet 11  
Cancelling First Revised Sheet 11  
Effective: January 25, 2006

### SERVICE CHARGES

#### G. LINK-UP FLORIDA

##### 1. General

- a. Link-Up Florida is offered in all exchanges to provide subsidized assistance to qualifying applicants. It is intended to preserve and promote subscribership among low income households by providing a credit to and a deferred schedule for payment of the installation and connection charges applicable to the provisioning of residence service. The Link-Up Florida program applies to installation and connection charges only. All other services will fall under Commission approved tariffed rates and regulations.
- b. The Company's rules for the Link-Up Florida program are as provided in Commission Order No. 19684, Docket Number 880847-TL.
- c. The Company's deferred payment schedule referenced in the previously mentioned order is provided as follows in this section.
- d. In compliance with the FCC's Order, FCC 05-178, dated October 14, 2005, support under the federal Link-Up program will be provided to victims of Hurricane Katrina moving to temporary housing arrangements and to those who return to permanent residences in the affected areas. A federal credit in the amount of thirty dollars (\$30.00) per qualifying household will be available to subscribers upon request and certification by the applicants that they were residents of counties that are designated by FEMA as eligible for individual assistance. A signed letter with this certification will suffice. A maximum of two federal credits (one for the temporary location and one for a return to the permanent location) will be available for qualified subscribers. These credits will be available for customer orders through March 1, 2007. These subscribers will not necessarily be eligible for the Lifeline program as specified in this tariff.

##### 2. Regulations

- a. Persons wishing to qualify for the credit must meet state certification criteria for eligibility. This credit is available only to residence customers, and will be applied to the nonrecurring charges for the establishment of service for a single telephone line per household at the principal place of residence.

GENERAL EXCHANGE TARIFF

Embarq Florida, Inc.

By: F. B. Poag  
Director

Section A4  
Fifth Revised Sheet 12  
Cancelling Fourth Revised Sheet 12  
Effective: September 19, 2005

SERVICE CHARGES

G. LINK-UP FLORIDA (Cont'd)

2. Regulations (Cont'd)

a. (Cont'd)

- 1) The customer will be responsible for payment of any applicable monthly charges in association with his/her service.
- 2) The Company reserves the right to require a deposit according to the regulations set forth in Section A2.
- 3) Any additional services, other than the basic R-1 service will be at the appropriate tariffed rate.

b. The subscriber must not be a dependent for federal income tax purposes, unless the subscriber is more than 60 years of age.

c. The federal credit is applied to the local service bills for qualified residential recipients of public assistance who apply for the credits and authorize agency verification of their participation in at least one of the following programs: Temporary Assistance to Needy Families (TANF), Medicaid, Supplementary Security Income (SSI), food stamps, Federal Public Housing Assistance (Section 8), Low-Income Home Energy Assistance Program (LIHEAP) and National School Lunch Program (free meals program only).

d. For an applicant living on federally recognized Native American reservations, additional assistance programs are as follows: Bureau of Indian Affairs (BIA) General Assistance, Tribally Administered Temporary Assistance for Needy Families, Head Start (only for those meeting its income qualifying standard) and National School Lunch Program (free meals program only).

e. Additionally, customers not receiving benefits under one of the preceding programs, and whose total gross annual income does not exceed 135% of the federal poverty guidelines, meet the requirements of a State established means test and may apply directly to the Office of Public Counsel (OPC) for eligibility certification.

f. From September 19, 2005 through March 31, 2006, relocated victims of Hurricane Katrina from the following areas:

1. Any Louisiana parish
2. Any Mississippi county
3. Baldwin, Choctaw, Clarke, Greene, Hale, Jefferson, Marengo, Mobile, Pickens, Sumter, Tuscaloosa or Washington Counties in Alabama

may receive Link-Up Florida benefits without qualifying under 2.c. or 2.d above upon self certification of displacement from the above identified areas and qualification for any federal or state disaster relief program.

GENERAL EXCHANGE TARIFF

Embarq Florida, Inc.

By: F. B. Poag  
Director

Section A4  
First Revised Sheet 13  
Cancelling Original Sheet 13  
Effective: August 26, 2003

SERVICE CHARGES

G. LINK-UP FLORIDA (Cont'd)

3. Rates and Charges

Applicable Federal Credit is 50% of the total of the Service Ordering Charge plus Access Line Charge or a \$30.00 reduction, whichever is less. Effective October 1, 2000, in addition to the reduction in this section, eligible applicants living on federally recognized Native American reservations will receive a 100% discount on service connection charges which exceed \$60.00, up to a maximum of \$130.00. These charges include both line extension and initial connection charges. The combined Link-up credit shall not exceed \$100.00.

- a. There is not restriction as to the number of service connections per year for which qualifying low-income subscribers who relocate may receive link-up support.

GENERAL EXCHANGE TARIFF

Embarq Florida, Inc.

SECTION A5

By: F.B. Poag  
Director

First Revised Contents Sheet 1  
Cancelling Original Contents Sheet 1  
Effective: January 1, 1997

CHARGES APPLICABLE UNDER SPECIAL CONDITIONS

CONTENTS

	<u>SHEET</u>
A. GENERAL .....	1
1. Contents .....	1
2. Explanation of Terms.....	1
B. SPECIAL CONSTRUCTION .....	4
1.General.....	4
2.Conditions Requiring Special Construction.....	5
3.Ownership of Facilities .....	7
4.Interval to Provide Facilities .....	7
5.Special Construction Involving Interstate and Intrastate Facilities.....	7
6.Charges of Other Companies.....	8
7.Liabilities, Charges and Payments for Special Construction.....	8
8.Contingent Liabilities .....	10
9.Nonrecurring and Recurring Charges .....	16
10. Deferral of the Start of Service .....	25
11. Construction on Public Highways or Public Rights-of-Way .....	27
12. Construction on Private Property Across Which Rights-of-Way and Easements Satisfactory to the Company are Provided Without Cost to the Company .....	28

GENERAL EXCHANGE TARIFF

Embarq Florida, Inc.

SECTION A5

By: F.B. Poag  
Director

First Revised Contents Sheet 1  
Cancelling Original Contents Sheet 1  
Effective: November 12, 2004

CHARGES APPLICABLE UNDER SPECIAL CONDITIONS

CONTENTS

	<u>SHEET</u>
C. ADDITIONAL ENGINEERING, ADDITIONAL LABOR AND MISCELLANEOUS CHARGES .....	32
1. Additional Engineering.....	32
2. Additional Labor.....	34
3. Miscellaneous Charges .....	35
D. CHARGES FOR UNUSUAL INSTALLATIONS.....	35
E. SPECIAL SERVICE ARRANGEMENTS.....	36
1. General Regulations.....	36
F. BULK FACILITY TERMINATIONS FOR SECRETARIAL SERVICE FACILITIES.....	38
G. UNDERGROUND DISTRIBUTION SYSTEMS - SUBDIVISIONS.....	38
H. CONTRACT SERVICE ARRANGEMENTS .....	40
I. DIGITAL SERVICES FOR THE FLORIDA LOTTERY (CENTRAL TELEPHONE).....	42
1. General.....	42
2. Rates .....	43



GENERAL EXCHANGE TARIFF

Embarq Florida, Inc.

SECTION A5

By: F.B. Poag  
Director

Second Revised Contents Sheet 3  
Cancelling First Revised Contents Sheet 3  
Effective: September 29, 2004

CHARGES APPLICABLE UNDER SPECIAL CONDITIONS

CONTENTS

	<u>SHEET</u>
J. D-4 CHANNEL SERVICE FOR PUBLIC EMPLOYEES SERVICE COMPANY (CENTRAL TELEPHONE) .....	44
1. General .....	44
2. Rates .....	45
K. DIGITAL DATA TEST FOR THE STATE OF FLORIDA (CENTRAL TELEPHONE).....	46
1. General .....	46
2. Rates .....	46
L. DIGITAL NETWORK FOR OKALOOSA COUNTY SCHOOL BOARD (CENTRAL TELEPHONE).....	46
1. General .....	46
2. Rates .....	47
M. SUNCOM NETWORK (CENTRAL TELEPHONE).....	48
1. General .....	48
2. Switching .....	48
3. Additional Services .....	50
N. VIDEO CIRCUIT FOR LEON COUNTY JAIL AND LEON COUNTY COURTHOUSE .....	50
1. General .....	50
2. Rates .....	51
O. SPECIAL DISASTER RELIEF RATES INITIATED BY THE COMPANY	
1. General .....	51

## GENERAL EXCHANGE TARIFF

Embarq Florida, Inc.

By: F.B. Poag  
Director

Section A5  
Second Revised Sheet 1  
Cancelling First Revised Sheet 1  
Effective: September 29, 2004

### CHARGES APPLICABLE UNDER SPECIAL CONDITIONS

#### A. GENERAL

##### 1. Contents

Section A5 contains the regulations, rates and charges applicable to the provision of Company services which require:

- Special Construction
- Additional Engineering, Labor and Miscellaneous Charges
- Charges for Unusual Installations
- Specialized Service or Arrangements
- Contract Service Arrangements
- Special Disaster Relief Rates Initiated by the Company

##### 2. Explanation of Terms

The following terms are applicable to this section of the tariff.

**ACTUAL COST** - the estimated costs applicable to the specific case of special construction plus prorated costs of items used in common with other facilities, minus estimated net salvage.

**ESTIMATED COST** - the estimated costs applicable to the specific case of special construction of facilities plus prorated costs of items used in common with other facilities, minus estimated net salvage.

**EXCESS CAPACITY** - a quantity of facilities requested by a customer which is greater than that which the Company would construct to fulfill the customer's order for service.

## GENERAL EXCHANGE TARIFF

Embarq Florida, Inc.

By: F.B. Poag  
Director

Section A5  
First Revised Sheet 2  
Cancelling Original Sheet 2  
Effective: January 1, 1997

### CHARGES APPLICABLE UNDER SPECIAL CONDITIONS

#### A. GENERAL (Cont'd)

##### 2. Explanation of Terms (Cont'd)

**FACILITIES** - any cable, poles, conduit, microwave or carrier equipment, wire center distribution frames, central office switching equipment, computers (both hardware and software), business machines, etc., utilized to provide the services offered under this tariff or the services provided by a customer for his own use.

**FIVE (5) YEAR FORECAST** - a projection of the maximum number of cable pairs the customer will require over a five year period that is mutually agreed upon by the customer and the Company. This is normally the Initial Liability Period.

**INITIAL LIABILITY PERIOD - (ILP)** a written agreement with the Company and the customer on the quantity of cable pairs to be provided and the length of time in which the customer expects to place the cable pairs in service.

**MAXIMUM TERMINATION LIABILITY (MTL) CHARGE** - the maximum amount of money for which the customer is liable in the event all services or facilities ordered in a special construction case are discontinued before a specified period of time.

**MTL PERIOD** - the length of time the customer is liable for a termination charge in the event the specially constructed facilities are terminated. The MTL period is equal to the average account life of the telephone facilities provided. When the construction involves multiple classes of plant with differing lives, the MTL period is equal to the weighted average of the account lives involved in the special construction case.

GENERAL EXCHANGE TARIFF

Embarq Florida, Inc.

By: F.B. Poag  
Director

Section A5  
First Revised Sheet 3  
Cancelling Original Sheet 3  
Effective: January 1, 1997

CHARGES APPLICABLE UNDER SPECIAL CONDITIONS

A. GENERAL (Cont'd)

2. Explanation of Terms (Cont'd)

NET SALVAGE - the estimated scrap, or trade-in value, less the estimated cost of salvage. Cost of salvage includes the costs of demolishing, tearing down, removing, or otherwise disposing of the material and any other applicable costs. Because the cost of removal may exceed salvage, facilities may have negative net salvage.

NONRECOVERABLE COST - the cost of providing for the specially constructed facilities for which the Company has no foreseeable use should the customer terminate service.

OTHER TELEPHONE COMPANY - a company that is not Embarq Florida, Inc., but is engaged in the business of furnishing public switched network telephone exchange services.

PERMANENT FACILITIES - facilities that are expected to remain in place for the normal service life of the plant.

RECOVERABLE COST - the cost of providing for the specially constructed facilities for which the Company has a foreseeable reuse, either in place or elsewhere, should the customer terminate service.

SPECIAL CONSTRUCTION - a series of tariff regulations that are designed to protect the Company from undue risk associated with specially constructed facilities and allows the Company to recover excessive investments incurred by the construction of facilities that will carry services currently offered on a general basis in a service tariff. These regulations are also designed to prevent undue subsidizations of specially constructed facilities by the general body of ratepayers.

## GENERAL EXCHANGE TARIFF

Embarq Florida, Inc.

By: F.B. Poag  
Director

Section A5  
Second Revised Sheet 4  
Cancelling First Revised Sheet 4  
Effective: May 26, 2005

### CHARGES APPLICABLE UNDER SPECIAL CONDITIONS

#### A. GENERAL (Cont'd)

##### 2. Explanation of Terms (Cont'd)

**SUBSCRIBERS IN GENERAL** - as used in this tariff is to be interpreted to include those cases where the construction of permanent facilities is required to serve two or more customers.

**TEMPORARY FACILITIES** - facilities used to provide service(s) where it is known before construction that the facilities will be relocated, abandoned or removed prior to the normal service life of the facilities. The cost of temporary facilities is not to be recovered from subscribers in general and does not constitute a carrier of last resort obligation for the Company.

**TERMINATION CHARGE** - the portion of the maximum termination charge that is applied as a nonrecurring charge when all services are discontinued prior to the expiration of the specified liability period.

**UNDERUTILIZATION CHARGE** - an obligation, incurred by a customer, which is designed to reimburse the Company for the annual costs of a portion of specially constructed facilities when the customer's actual use of those facilities is less than 70% of the amount of use forecasted or ordered by the customer.

#### B. SPECIAL CONSTRUCTION

##### 1. General

- a. Special construction consists of a series of tariff regulations that are designed to protect the Company from undue risk associated with specially constructed facilities and allows the Company to recover excessive investments incurred by the construction of facilities that will carry services currently offered on a general basis in a service tariff. These regulations are also designed to prevent undue subsidization of specially constructed facilities by the general body of ratepayers

GENERAL EXCHANGE TARIFF

Embarq Florida, Inc.

By: F.B. Poag  
Director

Section A5  
First Revised Sheet 5  
Cancelling Original Sheet 5  
Effective: January 1, 1997

CHARGES APPLICABLE UNDER SPECIAL CONDITIONS

B. SPECIAL CONSTRUCTION (Cont'd)

1. General (Cont'd)

- b. When special construction of facilities is required, the provisions of this tariff apply in addition to all regulations, rates and charges set forth in the appropriate service tariff. All applicable provisions set forth in this tariff will be implemented by a written agreement prepared by the Company and signed by the customer.
- c. The regulations, rates and charges applicable for special construction of Company facilities which are used to provide services under this tariff are as follows.

2. Conditions Requiring Special Construction

Special construction is required when suitable facilities are not available to meet a customer's order for service and/or a mutually agreed upon facility forecast and one or more of the following conditions exist:

- a. The Company has no other requirement for the facilities constructed at the customer's request.
- b. The customer requests that service be furnished using a type of facility, or via a route, other than that which the Company would otherwise utilize in furnishing the requested service.

GENERAL EXCHANGE TARIFF

Embarq Florida, Inc.

By: F.B. Poag  
Director

Section A5  
Third Revised Sheet 6  
Cancelling Second Revised Sheet 6  
Effective: June 16, 2005

CHARGES APPLICABLE UNDER SPECIAL CONDITIONS

B. SPECIAL CONSTRUCTION (Cont'd)

2. Conditions Requiring Special Construction (Cont'd)

- c. The customer requests the construction of more facilities than required to satisfy his initial order for service; and submits a mutually agreed upon facility forecast.
- d. The customer requests construction be expedited resulting in added cost to the Company.
- e. The customer requests that temporary facilities be constructed.
- f. The cost to construct line extension facilities for an individual subscriber when the cost exceeds the estimated five year exchange revenue.
- g. The term "customer" as used in the preceding context also includes those entities, businesses, government agencies or their agents, which request the construction of temporary facilities or create a requirement for the construction of temporary network facilities. The services provided over the temporary facilities may be ordered by and billed to separate end user customers. Examples of such entities or businesses include, but are not limited to, political campaigns, sporting events, concerts, government agencies such as the Federal Emergency Management Agency (FEMA) or the United States Army Corps of Engineers or agents of such agencies or businesses.
- h. No customer shall be charged special construction rates for the minimum grade of line offered where the new plant parallels and reinforces existing plant or is constructed on or along any public road or highway and is to be used to serve subscribers in general.

GENERAL EXCHANGE TARIFF

Embarq Florida, Inc.

By: F.B. Poag  
Director

Section A5  
First Revised Sheet 7  
Cancelling Original Sheet 7  
Effective: January 1, 1997

CHARGES APPLICABLE UNDER SPECIAL CONDITIONS

B. SPECIAL CONSTRUCTION (Cont'd)

3. Ownership of Facilities

Unless otherwise specified in this Tariff, the Company retains ownership of all specially constructed facilities even though the customer may be required to pay special construction charges.

4. Interval to Provide Facilities

- a. Based on available information and the type of service ordered, the Company will establish an objective date for the installation of necessary facilities. The date will be established on an individual case basis and provided to the customer. The Company will make every reasonable effort to assure that the date is met. However, shortage of components, personnel or other factors may lengthen the installation interval.
- b. If the scheduled completion date cannot be met due to circumstances beyond the control of the Company, a new completion date will be established and the customer will be notified. The amount of interest accrued on all prepaid items will be credited to the customer's account for any delays that could have been circumvented by the Company.

5. Special Construction Involving Interstate and Intrastate Facilities

When special construction involves facilities used to provide both interstate and intrastate services, charges for the portion of the construction used to provide intrastate service shall be in accordance with Embarq Florida, Inc.'s Intrastate



## GENERAL EXCHANGE TARIFF

Embarq Florida, Inc.

By: F.B. Poag  
Director

Section A5  
First Revised Sheet 8  
Cancelling Original Sheet 8  
Effective: January 1, 1997

### CHARGES APPLICABLE UNDER SPECIAL CONDITIONS

#### B. SPECIAL CONSTRUCTION (Cont'd)

##### 5. Special Construction Involving Interstate and Intrastate Facilities - (Cont'd)

Access Service tariff. Charges for the portion of the construction used to provide interstate service shall be in accordance with Embarq's Interstate Access Tariff.

##### 6. Charges of Other Companies

Charges and/or maximum termination liabilities for special construction of facilities provided by another company are developed by the other company and may be applied by Embarq Florida, Inc., under this tariff on the other company's behalf.

##### 7. Liabilities, Charges and Payments for Special Construction

- a. The various charges and payments that apply when the Company provides special construction of facilities in accordance with a customer's specific request are described as follows. The customer must provide the Company with written approval of all liabilities and charges prior to the start of construction. If more than one condition requiring special construction is involved, charges for each condition apply.
- b. Payment is due upon presentation of a bill for the specially constructed facilities. To safeguard its interests during construction, the Company will require the customer to make an advance payment for the portion of the estimated cost of the special construction for which the customer is subject to a nonrecurring charge. Partial payments will be requested as costs are incurred and will be credited to the customers account. No special construction charges paid to the Company are refundable except as provided under Section B.7.d.(2).

GENERAL EXCHANGE TARIFF

Embarq Florida, Inc.

By: F.B. Poag  
Director

Section A5  
First Revised Sheet 9  
Cancelling Original Sheet 9  
Effective: January 1, 1997

CHARGES APPLICABLE UNDER SPECIAL CONDITIONS

B. SPECIAL CONSTRUCTION (Cont'd)

7. Liabilities, Charges and Payments for Special Construction (Cont'd)

- c. When the facilities are provided, billing of recurring charges for specially constructed facilities starts on the contract service date or the in-service date, whichever is earlier. Billing accrues through and includes the day that the specially constructed facilities are discontinued. Monthly charges will normally be billed one month in advance.
- d. The customer has the option of having the liabilities and charges billed based on either estimated or actual costs. Costs, as used in this context, may include one or more of the items specified in E.1.c. following. Estimated costs will be billed unless the customer notifies the Company of the selection of the actual cost option in writing prior to the start of special construction.
  - 1) Under the estimated cost option, special construction liabilities and charges are developed based on estimated costs and will be specified in the written agreement between the customer and the Company.

GENERAL EXCHANGE TARIFF

Embarq Florida, Inc.

By: F.B. Poag  
Director

Section A5  
First Revised Sheet 10  
Cancelling Original Sheet 10  
Effective: January 1, 1997

CHARGES APPLICABLE UNDER SPECIAL CONDITIONS

B. SPECIAL CONSTRUCTION (Cont'd)

7. Liabilities, Charges and Payments for Special Construction (Cont'd)

d. (Cont'd)

- 2) Under the actual cost option, if all actual costs are not available prior to the start of service, estimated special construction charges will be specified in the written agreement between the customer and the Company. As soon as the actual costs, including costs of preparation and processing are subsequently determined, the estimated charges will be adjusted to reflect the actual costs.

8. Contingent Liabilities

In special construction cases that involve recurring charges, as described in B.9.b. following, one or both of two categories of contingent liabilities will apply. These liabilities, Maximum Termination Liability (MTL) and Underutilization Liability (UL) are described as follows:

- a. Maximum Termination Liability and Termination Charge is a liability against the customer for whom facilities were constructed. If the customer prematurely discontinues the use of the facilities, the liability will be converted into a termination charge if it is determined at the time of disconnect that the facilities are not reusable.

GENERAL EXCHANGE TARIFF

Embarq Florida, Inc.

By: F.B. Poag  
Director

Section A5  
First Revised Sheet 11  
Cancelling Original Sheet 11  
Effective: January 1, 1997

CHARGES APPLICABLE UNDER SPECIAL CONDITIONS

B. SPECIAL CONSTRUCTION (Cont'd)

8. Contingent Liabilities (Cont'd)

a. (Cont'd)

- 1) An MTL is equal to the nonrecoverable costs associated with specially constructed facilities and is the maximum amount which could be applied as a termination charge if all specially constructed facilities were discontinued before MTL expires.
- 2) The liability period is equal to the average life of the account associated with the specially constructed facilities. The liability period is generally expressed in terms of an effective and expiration date.
- 3) A termination charge is applicable when all services using specially constructed facilities which have a written and signed agreement for an MTL are discontinued prior to the expiration of the liability period. The charge reflects the unamortized portion of the nonrecoverable costs at the time of termination, adjusted for net salvage and possible reuse. Administrative costs associated with the specific case of special construction and any costs for restoring a location to its original condition are also included. A termination charge may never exceed the MTL agreed to and signed by the customer in the initial contract.
- 4) The MTL in the signed agreement is in decreasing amounts at ten-year intervals over the average account life of the facilities. In the event that the average

GENERAL EXCHANGE TARIFF

Embarq Florida, Inc.

By: F.B. Poag  
Director

Section A5  
First Revised Sheet 12  
Cancelling Original Sheet 12  
Effective: January 1, 1997

CHARGES APPLICABLE UNDER SPECIAL CONDITIONS

B. SPECIAL CONSTRUCTION (Cont'd)

8. Contingent Liabilities (Cont'd)

a. (Cont'd)

4) (Cont'd)

account life of the facilities is not an even multiple of ten; the last increment will reflect the appropriate number of years remaining.

Example illustrating a 27-year average account life:

<u>MTL</u>	<u>Effective Date</u>	<u>Expiration Date</u>
\$10,000	6/1/84	6/1/94
7,000	6/1/94	6/1/04
3,000	6/1/04	6/1/11

- 5) Prior to the expiration of each liability period, the customer has the option to terminate the special construction case and pay the appropriate charges, or extend the use of the specially constructed facilities for the new liability period.
- 6) The Company will notify the customer six months in advance of the expiration date of each ten-year liability period. The customer must provide the Company with written notification at least 30 days prior to the expiration of the liability period if termination is elected. Failure to do so will result in an automatic extension of the special construction case to the next liability period at the MTL amount.

GENERAL EXCHANGE TARIFF

Embarq Florida, Inc.

By: F.B. Poag  
Director

Section A5  
First Revised Sheet 13  
Cancelling Original Sheet 13  
Effective: January 1, 1997

CHARGES APPLICABLE UNDER SPECIAL CONDITIONS

B. SPECIAL CONSTRUCTION (Cont'd)

8. Contingent Liabilities (Cont'd)

a. (Cont'd)

- 7) A partial termination of specially constructed facilities will be provided, at the election of the customer. The termination is determined by multiplying the termination charge which would result if all services using the specially constructed facilities were discontinued, at the time partial termination is elected, by the percentage of specially constructed facilities to be partially terminated. A new written agreement will be made following a partial termination to list remaining MTL amounts and the number of specially constructed facilities the customer will remain liable for.

Example: A customer with an MTL contract of \$100,000 for 3600 specially constructed facilities requests a partial termination of 900 facilities. The termination charge for all facilities, at the time of election, is \$60,000. The partial termination charge in this example is \$60,000 x 900/3600, or \$15,000.

- b. Annual Underutilization Liability and Underutilization Charge as specified in Section B.9.b.1) denotes a per unit amount that will be billed annually if less than 70% of the specially constructed facilities are being utilized.

- 1) Prior to the start of special construction, the Company and the customer will agree on the quantity of facilities to be provided, and the length of the

GENERAL EXCHANGE TARIFF

Embarq Florida, Inc.

By: F.B. Poag  
Director

Section A5  
First Revised Sheet 14  
Cancelling Original Sheet 14  
Effective: January 1, 1997

CHARGES APPLICABLE UNDER SPECIAL CONDITIONS

B. SPECIAL CONSTRUCTION (Cont'd)

8. Contingent Liabilities (Cont'd)

b. (Cont'd)

1) (Cont'd)

planning period during which the customer expects to place the facilities in service. The planning period is hereinafter referred to as the Initial Liability Period (ILP). The ILP is listed in the written agreement with an effective and expiration date.

2) Underutilization occurs only if, at the expiration date of the ILP and annually thereafter, less than 70% of the specially constructed facilities are in service per the written agreement at tariff service rates.

3) An annual underutilization liability amount is calculated on a per unit basis (i.e., per cable pair) for each case of special construction. This amount is equal to the annual per unit cost and includes depreciation, maintenance, administration, return, taxes and any other costs identified in the supporting documentation provided at the time the special construction agreement is signed.

4) Upon the expiration of the ILP, the number of underutilized facilities, if any, is multiplied by the annual underutilization liability amount. This product is then multiplied by the number of years (including any fraction thereof) in the ILP to determine the underutilization charge.

GENERAL EXCHANGE TARIFF

Embarq Florida, Inc.

By: F.B. Poag  
Director

Section A5  
First Revised Sheet 15  
Cancelling Original Sheet 15  
Effective: January 1, 1997

CHARGES APPLICABLE UNDER SPECIAL CONDITIONS

B. SPECIAL CONSTRUCTION (Cont'd)

8. Contingent Liabilities (Cont'd)

b. (Cont'd)

- 5) Annually thereafter, the number of underutilized facilities, if any, existing on the anniversary of the ILP expiration date will be multiplied by the annual underutilization liability amount to determine the underutilization charge for the preceding 12 month period.

Example: A customer orders 100 services and the special construction of a 600 pair building riser cable is agreed to, based on the customer's five year facility requirements. The ILP, in this example, would be five years. The annual underutilization liability is stated in the written agreement at \$2 per pair. If 400 pairs were in service at the end of the ILP, there would be an underutilization of 20 pairs, i.e.,  $420$  (70% of 600) - 400 = 20. The total underutilization charge for the first five years would be \$200, or \$2 per pair x 20 pairs x 5 years.

If 420 pairs are in service at the end of the sixth year, there is no underutilization, i.e.,  $420 - 420 = 0$ .



GENERAL EXCHANGE TARIFF

Embarq Florida, Inc.

By: F.B. Poag  
Director

Section A5  
First Revised Sheet 16  
Cancelling Original Sheet 16  
Effective: January 1, 1997

CHARGES APPLICABLE UNDER SPECIAL CONDITIONS

B. SPECIAL CONSTRUCTION (Cont'd)

9. Nonrecurring and Recurring Charges

Nonrecurring and/or Recurring Charges are applicable for special construction as follows:

a. Nonrecurring Charges

One or more of the following nonrecurring charges will apply for each case of special construction or inquiry for special construction:

- quotation preparation
- case preparation
- termination
- cancellation
- rearrangements and/or removals
- expediting the construction
- optional payment plan
- supporting structures on private property/
- pole attachment fees
- special routing of service entrance facilities
- temporary facilities

1) Quotation Preparation Charge - Applicable prior to placing an order for service requiring special construction.

- a) The quotation preparation charge is an optional nonrecurring charge that applies whenever a customer requests a detailed estimate of charges for special construction. The charge includes the costs associated with the development and

GENERAL EXCHANGE TARIFF

Embarq Florida, Inc.

By: F.B. Poag  
Director

Section A5  
First Revised Sheet 17  
Cancelling Original Sheet 17  
Effective: January 1, 1997

CHARGES APPLICABLE UNDER SPECIAL CONDITIONS

B. SPECIAL CONSTRUCTION (Cont'd)

9. Nonrecurring and Recurring Charges (Cont'd)

a. Nonrecurring Charges (Cont'd)

1) Quotation Preparation Charge (Cont'd)

a) (Cont'd)

preparation of the quotation and any applicable receipts and other taxes. The customer will be advised of the charge for quotation preparation and must agree to pay the charge before development of the quotation will commence.

b) If, after being advised of the quotation preparation charge, the customer requests a detailed estimate, it will be developed and furnished. A bill for the quotation preparation will be rendered. The quotation is valid for 90 days and will identify all costs associated with the provision of the facilities needed to satisfy the customer's service requirements. The quotation will be considered to be accurate within +/- 10% of the cost quoted. Any unforeseen extraordinary costs which might cause a deviation greater than +10% will require additional approval of the customer. The quotation preparation charge is applicable regardless of whether service is ordered by the customer.

c) If the customer cancels the request for a quotation prior to its completion, the customer will be billed the lesser of the amount for the quotation

GENERAL EXCHANGE TARIFF

Embarq Florida, Inc.

By: F.B. Poag  
Director

Section A5  
First Revised Sheet 18  
Cancelling Original Sheet 18  
Effective: January 1, 1997

CHARGES APPLICABLE UNDER SPECIAL CONDITIONS

B. SPECIAL CONSTRUCTION (Cont'd)

9. Nonrecurring and Recurring Charges (Cont'd)

a. Nonrecurring Charges (Cont'd)

1) Quotation Preparation Charge (Cont'd)

c) (Cont'd)

preparation charge, which the customer was advised would apply, or the costs incurred for quotation preparation plus any appropriate taxes through the cancellation date.

d) The payment of the quotation preparation charge or any portion thereof does not assign, confer, or transfer title or ownership rights to proposals or equipment, designed or furnished by the Company. Title and ownership rights for any item developed at the customer's request remains with the Company except as specifically provided by an agreement between all parties.

2) Case Preparation Charge - applicable after the customer receives the quote and places an order for service requiring special construction. The charge for case preparation includes the administrative expense associated with preparing the proposal. This expense includes such items as preparation and processing, and gross receipts and other taxes. The Case Preparation Charge is the equivalent of a Primary Service Ordering Charge.

GENERAL EXCHANGE TARIFF

Embarq Florida, Inc.

By: F.B. Poag  
Director

Section A5  
First Revised Sheet 19  
Cancelling Original Sheet 19  
Effective: January 1, 1997

CHARGES APPLICABLE UNDER SPECIAL CONDITIONS

B. SPECIAL CONSTRUCTION (Cont'd)

9. Nonrecurring and Recurring Charges (Cont'd)

a. Nonrecurring Charges (Cont'd)

- 3) Termination Charge - A termination charge applies when, at the customer's request, service provided on specially constructed facilities which have specified MTLs, is discontinued prior to the expiration of the liability period unless otherwise specified in the written agreement.
- 4) Cancellation Charge - If the customer cancels the order prior to the start of service, a cancellation charge will apply. The charge will include all unrecoverable costs incurred by the Company up to and including the time of cancellation for the provision of the specific customer request.
- 5) Rearrangement and/or Removal Charges
  - a) When the Company is requested to move, change, rearrange or remove existing plant for which no specific charge is quoted in this tariff, the person/company at whose request such move or change is made will be required to bear the costs incurred by the Company in complying with the request.
  - b) Where by statute, ordinance or other legal requirement, existing aerial facilities are required to be relocated underground, the Company will charge the net cost attributable to such relocation to the local exchange subscribers located within the political subdivision or area affected by such

GENERAL EXCHANGE TARIFF

Embarq Florida, Inc.

By: F.B. Poag  
Director

Section A5  
First Revised Sheet 20  
Cancelling Original Sheet 20  
Effective: January 1, 1997

CHARGES APPLICABLE UNDER SPECIAL CONDITIONS

B. SPECIAL CONSTRUCTION (Cont'd)

9. Nonrecurring and Recurring Charges (Cont'd)

a. Nonrecurring Charges (Cont'd)

5) Rearrangement and/or Removal Charges (Cont'd)

b) (Cont'd)

statute, ordinance or other legal requirement. This nonrecurring charge (NRC), developed by dividing the total rearrangement and/or removed cost by the total number of subscribers affected by the ordinance, will be billed as a one time charge via the customer's bill. All customers will have the option of a lump sum payment or monthly payments spread over a specified agreed-to time period.

6) Expedited Order Charge - An expedited order charge applies when a customer requests that construction be completed on an expedited basis and the Company incurs additional costs. The charge is equal to the difference in the estimated cost of construction on an expedited basis and construction without expediting.

7) Supporting Structures on Private Property - These charges, when applicable as specified in Section B.12., include the costs of planning and building supporting structure on private property. Supporting structure includes poles, conduit, trenching, backfilling and associated costs. In cases where the customer or property owner is unable to provide the structure, the Company, at its discretion, will perform the work and

GENERAL EXCHANGE TARIFF

Embarq Florida, Inc.

By: F.B. Poag  
Director

Section A5  
First Revised Sheet 21  
Cancelling Original Sheet 21  
Effective: January 1, 1997

CHARGES APPLICABLE UNDER SPECIAL CONDITIONS

B. SPECIAL CONSTRUCTION (Cont'd)

9. Nonrecurring and Recurring Charges (Cont'd)

a. Nonrecurring Charges (Cont'd)

7) Supporting Structures on Private Property (Cont'd)

bill the customer or property owner. Ownership and maintenance of supporting structures on private property is vested in the customer or property owner.

8) Service Entrance Facilities - Entrance facilities include all cable and wire required to reach the normal network interface. When, at the request of the property owner or customer, a special route, network location, network arrangement or duplicate facility is required, an NRC will apply. The charge will be equal to the additional cost above that which would have normally been incurred if the special route, location or arrangement was not required. These costs can be billed on an actual or estimated basis as provided in Section B.7.d. of this tariff.

9) Temporary Facilities

a) Special Construction is considered to be "temporary" if one of the following conditions exist:

- (1) The facilities are constructed to provide service to a customer for less than the minimum service period or less than one month, whichever is longer.

GENERAL EXCHANGE TARIFF

Embarq Florida, Inc.

By: F.B. Poag  
Director

Section A5  
First Revised Sheet 22  
Cancelling Original Sheet 22  
Effective: January 1, 1997

CHARGES APPLICABLE UNDER SPECIAL CONDITIONS

B. SPECIAL CONSTRUCTION (Cont'd)

9. Nonrecurring and Recurring Charges (Cont'd)

a. Nonrecurring Charges (Cont'd)

9) Temporary Facilities (Cont'd)

a) (Cont'd)

(2) The facilities are constructed and it is known in advance that the newly placed plant will be relocated or removed prior to the end of the normal service life of the plant.

b) If a customer desires to change the service requested from temporary to permanent, such a change will be permitted if the request is made before any initial payment for the temporary service is received by the Company. The customer is liable for any NRCs for the construction of temporary facilities that cannot be reused or transferred to the permanent facilities. If the permanent facilities cannot be reused then a contract for underutilization and maximum termination charge will apply for the permanent facilities in addition to quotation and/or case preparation charges, and any recurring charges associated with the special construction.

c) The NRC for temporary facilities includes all nonrecoverable costs associated with the placement and removal of such facilities.

GENERAL EXCHANGE TARIFF

Embarq Florida, Inc.

By: F.B. Poag  
Director

Section A5  
First Revised Sheet 23  
Cancelling Original Sheet 23  
Effective: January 1, 1997

CHARGES APPLICABLE UNDER SPECIAL CONDITIONS

B. SPECIAL CONSTRUCTION (Cont'd)

9. Nonrecurring and Recurring Charges (Cont'd)

b. Recurring Charges

Recurring charges will always apply for the following conditions:

When a customer uses fewer facilities (i.e., cable pairs) than originally forecasted (Underutilization Charge).

When a customer orders more facilities (i.e., cable pairs) than required to satisfy the demand projected in the Initial Liability Period (ILP) (Excess Capacity Charge).

When a customer requests a facility route or type other than that which the Company would utilize to provide a service (Charges for route or type other than normal).

When a customer's request results in the Company's leasing transmission or other equipment to provide service (Lease Charge).

When a customer requests service that involves extraordinary conditions (Excess Costs).

- 1) Underutilization Charge - An underutilization charge will apply at the end of the ILP if less than 70% of the cable pairs placed is being utilized. The charges are calculated as outlined in B.8.b.



GENERAL EXCHANGE TARIFF

Embarq Florida, Inc.

By: F.B. Poag  
Director

Section A5  
First Revised Sheet 24  
Cancelling Original Sheet 24  
Effective: January 1, 1997

CHARGES APPLICABLE UNDER SPECIAL CONDITIONS

B. SPECIAL CONSTRUCTION (Cont'd)

9. Nonrecurring and Recurring Charges (Cont'd)

b. Recurring Charges (Cont'd)

- 2) Excess Capacity Charge - An excess capacity charge applies when the customer requests more cable pairs be placed than are required to satisfy the demand projected in the ILP. The charge is based on the estimated cost per cable pair times the excess number of cable pairs requested. The charge applies monthly beginning with the contract service date until the customer orders service to be activated on 70% of the cable pairs placed. The excess capacity charge will not apply to cable pairs identified in the forecasted amount.
- 3) Charge for Route or Type Other Than Normal - When the customer requests special construction using a route or type of facilities other than that which the Company would normally use, a monthly recurring charge is applicable. The charge is the difference between the estimated recurring costs of the specially constructed facilities and the estimated recurring costs of the facilities the Company would normally use. The charge will be no greater than the recurring costs of the specially constructed facilities. If the customer has elected the actual cost option, the recurring charge will be adjusted to reflect the actual cost of the new construction when the cost is determined. This adjusted recurring charge is applicable from the start of service.

GENERAL EXCHANGE TARIFF

Embarq Florida, Inc.

By: F.B. Poag  
Director

Section A5  
First Revised Sheet 25  
Cancelling Original Sheet 25  
Effective: January 1, 1997

CHARGES APPLICABLE UNDER SPECIAL CONDITIONS

B. SPECIAL CONSTRUCTION (Cont'd)

9. Nonrecurring and Recurring Charges (Cont'd)

b. Recurring Charges (Cont'd)

- 4) Lease Charge - A monthly and/or nonrecurring lease charge applies when the Company leases equipment (i.e., portable microwave equipment) in order to provide service to meet the customer's requirements. The amount of the charge is the total added cost to the Company caused by the lease.
- 5) Excess Costs - When a customer requests service that involves extraordinary conditions or circumstances and the anticipated 5-year revenue to be derived is not sufficient to support the costs associated with the service provision, then a monthly recurring charge is applicable as specified in D. following.

10. Deferral of the Start of Service

The customer may request the Company to defer the start of service on specially constructed facilities for a cumulative period of no more than eighteen months. If the deferral exceeds eighteen months, the special construction case is considered to be cancelled and cancellation charges apply. Requests for deferral must be in writing and are subject to the following regulations.

GENERAL EXCHANGE TARIFF

Embarq Florida, Inc.

By: F.B. Poag  
Director

Section A5  
First Revised Sheet 26  
Cancelling Original Sheet 26  
Effective: January 1, 1997

CHARGES APPLICABLE UNDER SPECIAL CONDITIONS

B. SPECIAL CONSTRUCTION (Cont'd)

10. Deferral of the Start of Service (Cont'd)

- a. Construction Has Not Started - If the Company has not incurred any costs (i.e., engineering and/or installation) before receiving the customer's request for deferral, no charge applies other than the quotation preparation charge if applicable. However, the original quotation will be reviewed by the Company at the time of reinstatement to determine if the original charges are still valid. Any change in charges requires the concurrence of the customer in writing. Supplemental quotation preparation and case preparation charges will also apply.
- b. Construction Has Started But Is Not Complete - If the construction of facilities has started but has not been completed before the Company receives the customer request for deferral, charges will apply. The charges vary depending on whether all or some of the services ordered are deferred.
  - 1) All Services Are Deferred - When all services involving special construction are deferred, a charge equal to the costs incurred during each month of the deferral applies. Those costs include the recurring costs for that portion of the facilities already completed and any other costs associated with the deferral. The quotation preparation charge and case preparation charge also apply.

GENERAL EXCHANGE TARIFF

Embarq Florida, Inc.

By: F.B. Poag  
Director

Section A5  
First Revised Sheet 27  
Cancelling Original Sheet 27  
Effective: January 1, 1997

CHARGES APPLICABLE UNDER SPECIAL CONDITIONS

B. SPECIAL CONSTRUCTION (Cont'd)

10. Deferral of the Start of Service (Cont'd)

b. Construction Has Started But Is Not Complete (Cont'd)

2) Some But Not All Services Are Deferred - When some, but not all, services utilizing the specially constructed facilities are deferred, the special construction case will be completed. Underutilization and maximum termination charges will apply in addition to quotation and case preparation charges, and any recurring charges associated with the special construction.

c. Construction Complete - If the construction of facilities has been completed before the Company receives the customer's request for deferral, the quotation preparation charge, case preparation charge, underutilization and maximum termination charge, as originally determined, and any recurring charges associated with the special construction will apply.

11. Construction on Public Highways or Public Rights-of-Way

a. No special construction is applicable for the reasonable provision of new network distribution facilities where the facilities are used for subscribers in general. However, if the provision of such facilities is determined to be unreasonable by the Company, then special construction charges will apply.

b. Where facilities are used to serve an individual subscriber, the subscriber may be required to pay recurring and/or nonrecurring construction charges.

GENERAL EXCHANGE TARIFF

Embarq Florida, Inc.

By: F.B. Poag  
Director

Section A5  
First Revised Sheet 28  
Cancelling Original Sheet 28  
Effective: January 1, 1997

CHARGES APPLICABLE UNDER SPECIAL CONDITIONS

B. SPECIAL CONSTRUCTION (Cont'd)

11. Construction on Public Highways or Public Rights-of-Way (Cont'd)
  - c. If special construction is required to serve two or more subscribers and the Company determines that the construction costs are excessive or unreasonable, the excess construction costs will be proportionally charged to all subscribers served by the line extension during the five years following construction completion. Charges will be considered excessive when five times the annual exchange revenue derived from the services utilizing the extended facilities is not expected to exceed the cost to construct the facilities.
  - d. The charge in either event will be the amount by which construction cost exceeds the amount of five times the annual exchange revenue.
  - e. Ownership and maintenance of such facilities is vested in the Company.
12. Construction on Private Property Across Which Rights-of-Way and Easements Satisfactory to the Company are Provided Without Cost to the Company
  - a. No special construction is applicable for the provision of new network distribution facilities where the facilities are used for subscribers in general if the Company determines that the cost of construction is not excessive or unreasonable. When facilities are used to serve an individual subscriber, or if construction costs to serve two or more subscribers are excessive or unreasonable, the subscriber(s) will be required to pay recurring and/or nonrecurring construction charges under the following conditions:

GENERAL EXCHANGE TARIFF

Embarq Florida, Inc.

By: F.B. Poag  
Director

Section A5  
First Revised Sheet 29  
Cancelling Original Sheet 29  
Effective: January 1, 1997

CHARGES APPLICABLE UNDER SPECIAL CONDITIONS

B. SPECIAL CONSTRUCTION (Cont'd)

12. Construction on Private Property Across Which Rights-of-Way and Easements Satisfactory to the Company are Provided Without Cost to the Company (Cont'd)

a. (Cont'd)

- 1) When five times the annual exchange revenue derived from the services utilizing the facilities is not expected to exceed the cost to construct the facilities.
- 2) The charge shall be the amount by which the construction cost exceeds the amount of five times the annual exchange revenue.

Ownership and maintenance of such circuits on private property is vested in the Company.

- b. Supporting structures on private property beyond a mutually agreeable terminating point is the responsibility of the customer.
- c. Requests for moves and rearrangements of poles, cables, and distribution terminals will be accommodated on the basis of cost.
- d. Service Charges as specified in Section A4 of this tariff will apply to moves or rearrangements of drop wire (aerial or buried). Moves and rearrangements exceeding these limitations will be accommodated on the basis of cost.

GENERAL EXCHANGE TARIFF

Embarq Florida, Inc.

By: F.B. Poag  
Director

Section A5  
First Revised Sheet 30  
Cancelling Original Sheet 30  
Effective: January 1, 1997

CHARGES APPLICABLE UNDER SPECIAL CONDITIONS

B. SPECIAL CONSTRUCTION (Cont'd)

12. Construction on Private Property Across Which Rights-of-Way and Easements Satisfactory to the Company are Provided Without Cost to the Company (Cont'd)

e. The regulations for extending service onto residential and commercial properties are detailed following. Where a building or property is mixed residential/commercial, the rules for commercial property will apply.

1) Residential Properties

- a) In areas where buried service is normally furnished by the Company, the Company will open and close necessary trenches providing that suitable easements and rights-of-way are obtained at no cost to the Company; or, the subscriber(s) or property owner(s) may open and close the trench to the specifications of the Company.
- b) In areas where aerial service is normally furnished by the Company, the Company will provide all poles necessary for the provision of basic exchange service, subject to a. preceding, or the subscriber(s) or property owner(s) may provide poles to the specifications of the Company.
- c) In lieu of buried service, in areas where buried service is normally furnished by the Company, the subscriber(s) or property owner(s) may provide a conduit, equipped with pullwire, to a service point designated by the Company.

GENERAL EXCHANGE TARIFF

Embarq Florida, Inc.

By: F.B. Poag  
Director

Section A5  
First Revised Sheet 31  
Cancelling Original Sheet 31  
Effective: January 1, 1997

CHARGES APPLICABLE UNDER SPECIAL CONDITIONS

B. SPECIAL CONSTRUCTION (Cont'd)

12. Construction on Private Property Across Which Rights-of-Way and Easements Satisfactory to the Company are Provided Without Cost to the Company (Cont'd)

e. (Cont'd)

1) Residential Properties (Cont'd)

d) In cases where the subscriber(s) or property owner(s) requests service in other than the normal manner (i.e., buried in an aerial service area), excess costs to provide service will be billed to the person(s) requesting service.

2) Commercial Properties

a) Property owners and/or subscribers are responsible for the provision of an underground conduit system from a service point designated by the Company to a mutually agreeable termination point inside commercial buildings. The entrance conduit system will include the necessary handholes, pullboxes, pullwires, manholes and other associated structure to enable the Company to install the cable or wire.

b) Where the terrain or other conditions are such that, in the judgment of the Company, a conduit system will not serve as a feasible entrance method, the property owner or subscriber may open and close a trench to the specifications of the Company; or, at the subscriber's request and Company's discretion, the Company will perform the trenching work and apply appropriate special construction charges.



GENERAL EXCHANGE TARIFF

Embarq Florida, Inc.

By: F.B. Poag  
Director

Section A5  
First Revised Sheet 32  
Cancelling Original Sheet 32  
Effective: January 1, 1997

CHARGES APPLICABLE UNDER SPECIAL CONDITIONS

B. SPECIAL CONSTRUCTION (Cont'd)

12. Construction on Private Property Across Which Rights-of-Way and Easements Satisfactory to the Company are Provided Without Cost to the Company (Cont'd)

e. (Cont'd)

1) Commercial Properties (Cont'd)

c) In areas served by aerial cable, the Company will provide all necessary poles, subject to 12.a. preceding.

C. ADDITIONAL ENGINEERING, ADDITIONAL LABOR AND MISCELLANEOUS CHARGES

1. Additional Engineering

a. Additional engineering is that engineering or engineering consultation requested by the customer as described in 1) through 3) following. The Company will notify the customer in writing that additional engineering charges as specified in b. following will apply before any additional engineering is undertaken.

1) Engineering Consultation - Engineering consultation is the securing of technical advice from the Company by the customer not in connection with a specific order, and situations in which the customer requests the Company to provide information or to perform a function which will entail additional engineering by the Company. This does not include inquiries of a short duration where no significant engineering time is required or inquiries associated with customer service forecasts.

GENERAL EXCHANGE TARIFF

Embarq Florida, Inc.

By: F.B. Poag  
Director

Section A5  
First Revised Sheet 33  
Cancelling Original Sheet 33  
Effective: January 1, 1997

CHARGES APPLICABLE UNDER SPECIAL CONDITIONS

C. ADDITIONAL ENGINEERING, ADDITIONAL LABOR AND MISCELLANEOUS CHARGES (Cont'd)

1. Additional Engineering (Cont'd)

a. (Cont'd)

- 2) Expedited Engineering - Expedited engineering is that time required to meet a customer request for a less than normal engineering design interval.
- 3) Engineering of Connections with Other Telephone Companies - Engineering of connections with other telephone companies, if not concurring carriers, is the engineering activity of contacting, coordinating and designing with another telephone company, portions of facilities which connect facilities provided by another telephone company.

b. Charges for Additional Engineering

The following charges are applicable for engineering consultation, expedited engineering and engineering of connections with other telephone companies, if not concurring carriers.

	<u>First Half Hour or Fraction thereof</u>	<u>Each Additional Half Hour or fraction thereof</u>
Basic time, normally scheduled work hours. Per Engineer	\$ 66.00	\$ 39.79
Overtime, outside of normally scheduled work hours. Per Engineer	73.41	47.20

GENERAL EXCHANGE TARIFF

Embarq Florida, Inc.

By: F.B. Poag  
Director

Section A5  
First Revised Sheet 34  
Cancelling Original Sheet 34  
Effective: January 1, 1997

CHARGES APPLICABLE UNDER SPECIAL CONDITIONS

C. ADDITIONAL ENGINEERING, ADDITIONAL LABOR AND MISCELLANEOUS  
CHARGES (Cont'd)

2. Additional Labor (Cont'd)

- a. Additional labor is that requested by the customer on a given service as described in 1) through 6) following. The Company will notify the customer in writing that additional labor charges as specified in b. following will apply before any additional labor is undertaken.
  - 1) Overtime installation - Company installation effort outside of regularly scheduled working hours.
  - 2) Overtime repair - Company maintenance effort performed outside of regularly scheduled working hours.
  - 3) Additional installation testing - testing performed by the Company at the time of installation which is in addition to pre-service acceptance testing. Pre-service testing includes testing for dialing, answering and talking capabilities.
  - 4) Stand by - includes all time in excess of one-half (1/2) hour during which Company personnel stand by to make coordinated tests on a given service.
  - 5) Testing and maintenance with other telephone companies - Additional testing, maintenance or repair of facilities which connect to facilities of other telephone companies, if not concurring carriers, which is in addition to effort required to test, maintain or repair facilities provided solely by the Company.

GENERAL EXCHANGE TARIFF

Embarq Florida, Inc.

By: F.B. Poag  
Director

Section A5  
First Revised Sheet 35  
Cancelling Original Sheet 35  
Effective: January 1, 1997

CHARGES APPLICABLE UNDER SPECIAL CONDITIONS

C. ADDITIONAL ENGINEERING, ADDITIONAL LABOR AND MISCELLANEOUS CHARGES (Cont'd)

2. Additional Labor (Cont'd)

a. (Cont'd)

6) Other labor - As agreed to by the Company and the customer, additional labor not included in 1) through 5) preceding may be undertaken.

b. Charges for Additional Labor

1) Overtime Installation or Repair - Provided at the rates and charges as found in Section A4 of this tariff.

2) Additional installation testing, stand by, testing and maintenance with other telephone companies, if not concurring carriers, or other labor - Provided at the rates and charges as found in Section A4, C.1.n. of this tariff.

3. Miscellaneous Charges

Trouble Location Charge - See Section A4 of this tariff.

D. CHARGES FOR UNUSUAL INSTALLATIONS

Special Types of Installation - When a special type of installation is desired by a subscriber or where the individual requirements of a particular situation make the installation unusually expensive, the subscriber is required to bear the excess cost of such installation. Recurring monthly charges will be calculated on the actual cost of

## GENERAL EXCHANGE TARIFF

Embarq Florida, Inc.

By: F.B. Poag  
Director

Section A5  
First Revised Sheet 36  
Cancelling Original Sheet 36  
Effective: January 1, 1997

### CHARGES APPLICABLE UNDER SPECIAL CONDITIONS

#### D. CHARGES FOR UNUSUAL INSTALLATIONS (Cont'd)

provisioning, normal maintenance, and taxes. In addition, any special maintenance expense that may occur from time to time will be borne by the subscriber except that maintenance of buried service wire, including trenching where required, will be at the expense of the Company. A subscriber may also be required to pay the amount of additional costs incurred by the Company resulting from the subscriber's special requests. Such special requests may include, but are not limited to, expedited shipping.

#### E. SPECIAL SERVICE ARRANGEMENTS

##### 1. General Regulations

- a. Special service arrangements (Special Assemblies) may be provided by the Company at the request of a customer on an individual case basis if such service or arrangements meet the following criteria:
  - 1) The requested service or arrangements are not offered under other sections of this tariff.
  - 2) The facilities utilized to provide the requested service or arrangements are of a type normally used by the Company in furnishing its other services.
  - 3) The requested service or arrangements are compatible with other Company services, facilities, equipment and its engineering and maintenance practices.
  - 4) This offering is subject to the availability of the necessary Company personnel and capital resources.

GENERAL EXCHANGE TARIFF

Embarq Florida, Inc.

By: F.B. Poag  
Director

Section A5  
First Revised Sheet 37  
Cancelling Original Sheet 37  
Effective: January 1, 1997

CHARGES APPLICABLE UNDER SPECIAL CONDITIONS

E. SPECIAL SERVICE ARRANGEMENTS (Cont'd)

1. General Regulations (Cont'd)

- b. Rates, charges and additional regulations, if applicable, for special service arrangements are developed on an individual case basis and will include all costs associated with the provision of the service plus an appropriate level of contributions.
- c. Costs for the specialized service or arrangements will include one or more of the following items but is not limited to only these items.

- Labor, engineering and materials
- Supervision
- Operating expenses, i.e., maintenance, administration, etc.
- Return on investment
- Taxes
- Depreciation
- Charges associated with construction provided by another company
- Charges for securing, clearing and retaining private rights-of-way
- Charges for securing use of poles and/or pole line attachments on utility poles of other companies
- Equipment or space rental or lease charges
- Expenses incurred due to damages caused by the customer or his agents
- Any other identifiable associated cost
- Cost for rearrangements or changes
- Supporting structures

## GENERAL EXCHANGE TARIFF

Embarq Florida, Inc.

By: F.B. Poag  
Director

Section A5  
First Revised Sheet 38  
Cancelling Original Sheet 38  
Effective: January 1, 1997

### CHARGES APPLICABLE UNDER SPECIAL CONDITIONS

#### F. BULK FACILITY TERMINATIONS FOR SECRETARIAL SERVICE FACILITIES

Secretarial service firms generally have sufficient activity (i.e., installations of secretarial service lines terminated in telephone answering bureau switchboards) to warrant the provision of a bulk facility termination which will enable the Company to more readily meet the customer's service needs. Where, in the Company's judgment, such termination of a bulk facility is required, cable facilities will be provided as fixed terminations on secretarial line jacks of telephone answering bureau switchboards at charges based on costs at the time this work is done. These charges will be applicable to the secretarial service firm and will be in addition to all other appropriate tariff rates and charges for work done and services provided.

#### G. UNDERGROUND DISTRIBUTION SYSTEM - SUBDIVISIONS

- a. Requests for underground distribution systems must be made in writing by the developer. The application must give detail as to the area to be served, development schedule, location of utility easements and such other information that may be required to assist in the planning for the distribution system.
- b. The Company shall have the right to reject these requests whenever the electric distribution system is of overhead design.
- c. Rights-of-Way and easements suitable to the Company must be furnished by the applicant in reasonable time to meet service requirements and, at no cost to the Company, must be cleared of trees, tree stumps, paving, and other obstructions, staked to show property lines and final grade by the applicant before the Company will commence construction of the underground distribution system. Such clearing and grading must be maintained by the applicant during construction by the Company.

## GENERAL EXCHANGE TARIFF

Embarq Florida, Inc.

By: F.B. Poag  
Director

Section A5  
First Revised Sheet 39  
Cancelling Original Sheet 39  
Effective: January 1, 1997

### CHARGES APPLICABLE UNDER SPECIAL CONDITIONS

#### G. UNDERGROUND DISTRIBUTION SYSTEM - SUBDIVISIONS (Cont'd)

- d. Temporary facilities of aerial type may be utilized during the initial construction stages of the underground distribution system to meet the immediate requirement for telephone service.
- e. The distribution system will be constructed with suitable material to assure that the applicant will receive adequate telephone service for the reasonably foreseeable future.
- f. Any damages to the lines, equipment or facilities of the Company caused by the customer, sub-divider, builder, developer, their agents, or representatives shall be repaired by the Company and charges associated with such repairs shall be paid by the customer, sub-divider, builder, or developer.
- g. The Company will install the underground distribution system at no charge to the applicant except that the applicant will be required to provide conduit of suitable size for the entrance facilities at multiple-occupancy buildings.
- h. The entrance conduit will be terminated in an accessible space of sufficient size to permit the termination of the entrance facility. The space provided must also be equipped with grounding facility.
- i. A cash deposit may be required as a performance guarantee. When the deposit is necessary, it shall be the difference in cost of the facilities requested and the facilities which the Company would normally provide. This deposit would be equated on a pro rata basis for making quarterly refunds during the first five years after the construction completion. The refund amount would be determined by multiplying the quarterly increase in



## GENERAL EXCHANGE TARIFF

Embarq Florida, Inc.

By: F.B. Poag  
Director

Section A5  
First Revised Sheet 40  
Cancelling Original Sheet 40  
Effective: January 1, 1997

### CHARGES APPLICABLE UNDER SPECIAL CONDITIONS

#### G. UNDERGROUND DISTRIBUTION SYSTEM - SUBDIVISIONS (Cont'd)

##### i. (Cont'd)

subscribers by the pro rata share. Quarterly refunds will be made during the first five years after construction completion or until such time as the deposit is depleted if prior to the five years. Any portion of the deposit remaining unrefunded after the fifth year will become the property of the Company. No interest will accrue on the deposit if refunded quarterly. If not refunded quarterly, interest will accrue on the refund- able amount at the then current prime interest rate.

#### H. CONTRACT SERVICE ARRANGEMENTS

1. When economically practicable, customer specific contract service arrangements may be furnished in lieu of existing tariff offerings provided there is reasonable potential for uneconomic bypass of the Company's services. Uneconomic bypass occurs when an alternative service arrangement is utilized, in lieu of Company services, at prices below the Company's rates but above the Company's incremental costs.
2. Rates, Charges, Terms, and additional regulations, if applicable, for the contract service arrangements will be developed on an individual case basis, and will include all relevant costs, plus an appropriate level of contribution.
3. Costs for the contract service arrangements may include one or more of the following items:
  - a. Labor, engineering, and materials.
  - b. Operating expenses, i.e., maintenance, administration, etc.
  - c. Return on investment.

GENERAL EXCHANGE TARIFF

Embarq Florida, Inc.

By: F.B. Poag  
Director

Section A5  
First Revised Sheet 41  
Cancelling Original Sheet 41  
Effective: January 1, 1997

CHARGES APPLICABLE UNDER SPECIAL CONDITIONS

H. CONTRACT SERVICE ARRANGEMENTS (Cont'd)

3. (Cont'd)

- d. Taxes.
  - e. Depreciation.
  - f. Any other identifiable associated cost.
4. Unless otherwise specified, the regulations for contract service arrangements are in addition to the applicable regulations and rates specified in other sections of this tariff.
5. Contract Service Arrangements may be offered on any non-basic service in this Tariff that satisfies the requirements specified in this section of the tariff. Contract Service Arrangements may be offered for a basic service only if the basic service is offered as part of a package with non-basic services.
6. Contract Service Arrangements are furnished by the Company to a subscriber only for communications in which the subscriber has a direct interest and shall not be used for any purpose for which a payment or other compensation shall be received by him from any other person, firm or corporation for such use, or in the collection, transmission or delivery of any communication for others. Contract service arrangements will not be offered to Other Common Carriers (OCCs) or other parties for the purposes of resale and/or shared use.

GENERAL EXCHANGE TARIFF

Embarq Florida, Inc.

By: F.B. Poag  
Director

Section A5  
First Revised Sheet 42  
Cancelling Original Sheet 42  
Effective: January 1, 1997

CHARGES APPLICABLE UNDER SPECIAL CONDITIONS

H. CONTRACT SERVICE ARRANGEMENTS (Cont'd)

7. The subscriber and the Company may elect to enter into an agreement where certain rates and/or charges for contract service arrangements are applicable for a fixed period of time. The Company will continue to offer such contract service arrangements without change in the applicable rates and/or charges unless mutual consent has been reached between the Company and the subscriber to undertake such changes. The Florida Public Service Commission will not adjust contract service arrangement rates and/or charges during this period. At the completion of this period, the agreement may be renewed at the option of the Company and the subscriber. Revised rates and/or charges may apply to any renewed agreement.

I. DIGITAL SERVICES FOR THE FLORIDA LOTTERY (Central Telephone)

1. General

- a. This tariff is a Special Assembly Tariff to provide DS3 44.736 Mbs Service and DS3 Fiber Route Diversity for the Florida Lottery.
- b. Service will be provided between Tallahassee Main and the Florida Lottery Building located at 250 Marriott Drive, Tallahassee, Florida.

GENERAL EXCHANGE TARIFF

Embarq Florida, Inc.

By: F.B. Poag  
Director

Section A5  
First Revised Sheet 43  
Cancelling Original Sheet 43  
Effective: January 1, 1997

CHARGES APPLICABLE UNDER SPECIAL CONDITIONS

I. DIGITAL SERVICES FOR THE FLORIDA LOTTERY (Central Telephone) (Cont'd)

2. Rates

a. DS3 Equipment and Mileage

	<u>NRC</u>	<u>Monthly Rate</u>
1) DS3 Equipment, first facility	\$ 2,000.00	\$ 2,827.00
2) DS3 Channel Mileage, Tallahassee Main to Florida Lottery Building	\$ 4,000.00	\$ 646.00
3) A five (5) year termination liability for the DS3 equipment and DS3 mileage will apply. The liability is \$89,040.00 reducible for each month in service.		

b. DS3 Fiber for Route Diversity

	<u>NRC</u>	<u>Monthly Rate</u>
1) Additional Fiber between Tallahassee Main and Florida Lottery Building \$ 4,000.00	\$ 1,594.00	

GENERAL EXCHANGE TARIFF

Embarq Florida, Inc.

By: F.B. Poag  
Director

Section A5  
First Revised Sheet 44  
Cancelling Original Sheet 44  
Effective: January 1, 1997

CHARGES APPLICABLE UNDER SPECIAL CONDITIONS

I. DIGITAL SERVICES FOR THE FLORIDA LOTTERY (Central Telephone) (Cont'd)

2. Rates (Cont'd)

c. Additional Equipment\*

	<u>NRC</u>	<u>Monthly Rate</u>
1) DS3 Equipment, each facility installed after first facility	\$ 1,000.00	\$ 1,032.00
2) Power Supply	-0-	\$ 256.00

J. D-4 CHANNEL SERVICE FOR PUBLIC EMPLOYEES SERVICE COMPANY (Central Telephone)

1. General

- a. This tariff is a Special Assembly Tariff to provide Point-to-Point D-4 channel service for the public Employees Service Company (PESCO).
- b. The service will be provided between the PESCO location at 2424 Allen Road and 3471 North Monroe Street, Tallahassee, Florida, with the D-4 channel bank equipment located at the North Monroe Street location.
- c. The rates shown are in addition to the normal 1.54 MB rates as shown in Section A20 of this Tariff.

\*This equipment to be installed at a later date dependent upon Lottery requirements.

GENERAL EXCHANGE TARIFF

Embarq Florida, Inc.

By: F.B. Poag  
Director

Section A5  
First Revised Sheet 45  
Cancelling Original Sheet 45  
Effective: January 1, 1997

CHARGES APPLICABLE UNDER SPECIAL CONDITIONS

J. D-4 CHANNEL SERVICE FOR PUBLIC EMPLOYEES SERVICE COMPANY (Central Telephone)  
(Cont'd)

2. Rates

a. D-4 Channel Equipment

	<u>NRC</u>	<u>Monthly Rate</u>
(1) D-4 Common Equipment	\$ 375.00	\$ 190.00
(2) D-4 Channel Termination, Voice Services with Signaling, each, one required for each channel	None	\$ 7.30

b. Termination Liability

- (1) A three year termination liability applies for both the D-4 common equipment and the D-4 channel terminations.
- (2) Termination liability applies from date of installation. Customer may not place this service on suspended rate.
- (3) Termination liability is reduced by the amount shown below for each month the equipment is in service.
  - (a) Common Equipment \$ 168.00 per month
  - (b) Channel Terminations \$ 6.50 per month

GENERAL EXCHANGE TARIFF

Embarq Florida, Inc.

By: F.B. Poag  
Director

Section A5  
First Revised Sheet 46  
Cancelling Original Sheet 46  
Effective: January 1, 1997

CHARGES APPLICABLE UNDER SPECIAL CONDITIONS

K. DIGITAL DATA TEST FOR THE STATE OF FLORIDA (Central Telephone)

1. General

- a. This is a special assembly tariff to provide a digital data test system for the State of Florida.
- b. The digital data test system will be physically located on the premises of Embarq Florida, Inc.. Service will be provided between the Tallahassee main office and the State of Florida, Department of General Services, Division of Communications, Tallahassee, Florida.

2. Rates

Monthly Rate

- a. Digital Data Test System \$ 561.25
- b. A five (5) year termination liability in the amount of \$16,164.00 will apply. The liability is reducible by \$269.40 for each month in service.

L. DIGITAL NETWORK FOR OKALOOSA COUNTY SCHOOL BOARD (Central Telephone)

1. General

- a. This tariff is a Special Assembly Tariff to provide digital networking for the Okaloosa County School Board.
- b. Digital facility service will be provided between the Fort Walton Beach access tandem and Destin, Shalimar, Niceville/Valparaiso and between the Crestview access tandem and the Baker central office.

GENERAL EXCHANGE TARIFF

Embarq Florida, Inc.

By: F.B. Poag  
Director

Section A5  
First Revised Sheet 47  
Cancelling Original Sheet 47  
Effective: January 1, 1997

CHARGES APPLICABLE UNDER SPECIAL CONDITIONS

L. DIGITAL NETWORK FOR OKALOOSA COUNTY SCHOOL BOARD (Central Telephone) (Cont'd)

2. Rates

a. Digital Facility Route Per Channel

	<u>Monthly Rate</u>
1) Fort Walton Beach-Destin	
Regular Channel	\$ 15.10
P-Phone Channel	28.11
2) Fort Walton Beach-Niceville/Valparaiso	
Regular Channel	\$ 15.33
P-Phone Channel	28.34
3) Fort Walton Beach - Shalimar	
Regular Channel	\$ 14.91
P-Phone Channel	27.92
4) Crestview-Baker	
Regular Channel	\$14.45
P-Phone Channel	27.46

b. Installation Charges per D4 Terminal (Each Terminal consists of 48 Channels)	\$ 280.00
--	-----------



GENERAL EXCHANGE TARIFF

Embarq Florida, Inc.

By: F.B. Poag  
Director

Section A5  
First Revised Sheet 48  
Cancelling Original Sheet 48  
Effective: January 1, 1997

CHARGES APPLICABLE UNDER SPECIAL CONDITIONS

M. SUNCOM NETWORK (Central Telephone)

1. General

This tariff applies to the private line switched long distance communications network known as SUNCOM provided to the State of Florida.

- a. The monthly rates and charges apply to switching services as outlined in RFP No. 85-014-4.70 TEN and as agreed to in Department of General Services contract 72-90-03-02-300/85-066.
- b. Additional equipment, facilities and services may be furnished as requested by the State of Florida Division of Communications.
- c. Rates and charges for additional equipment, facilities and services will be developed upon request. The rates for additional services will be filed in this tariff.

2. Switching

SUNCOM service will be provided via a Northern Telecom Digital Multiplex System (DMS-100) located in Tallahassee, Florida.

GENERAL EXCHANGE TARIFF

Embarq Florida, Inc.

By: F.B. Poag  
Director

Section A5  
First Revised Sheet 48  
Cancelling Original Sheet 48  
Effective: January 1, 1997

CHARGES APPLICABLE UNDER SPECIAL CONDITIONS

M. SUNCOM NETWORK (Central Telephone) (Cont'd)

2. Switching (Cont'd)

a. Switching Charges

- 1) Switching Charges will be calculated on the basis of access ports to the DMS-100 switch.

<u>Switch Port</u>	<u>Monthly Rate</u>
Access Line, per port	\$ 13.00
Inter Machine Trunk (IMT), each	13.00
Off Net Access Line (FX/FGA), each	13.00
Wide Area Telephone Service (WATS), each	-
Local Off Net Access Line (LONAL), each	-
Centrex Port (same switch), each	13.00

- 2) The port charge does not include the access line charges. Access line charges and service charges are covered by applicable General Customer Services Tariffs, Access Tariffs and the Southern Bell Private Line Tariff.

b. Minimum Annual Charge

- 1) A minimum annual charge for switching ports applies. Additional facilities or equipment charges do not apply towards meeting the minimum annual charge.
- 2) The minimum annual charge is \$150,000.00 per year. This charge applies for five (5) years from the time of system cutover which will be on or about May 1, 1993, unless terminated earlier by mutual agreement between the Department of General Services and Embarq Florida, Inc..

GENERAL EXCHANGE TARIFF

Embarq Florida, Inc.

By: F.B. Poag  
Director

Section A5  
Second Revised Sheet 50  
Cancelling First Revised Sheet 50  
Effective: May 29, 1997

CHARGES APPLICABLE UNDER SPECIAL CONDITIONS

M. SUNCOM NETWORK (Central Telephone) (Cont'd)

3. Additional Services

a. SMDR Magnetic Tape Drive

	<u>NRC</u>	<u>Monthly Rate</u>
1) Magnetic tape drive (without backup)	\$ 2,700.00	\$ 466.55
2) A seven year termination liability of \$14,600.00 applies. The termination liability will be reduced \$171.83 for each month the tape drive is in service.		

b. SUNCOM NCC Interface

	<u>Monthly Rate</u>
1) NCC Interface	\$ 3,007.00
2) A seven year termination liability of \$116,658.00 applies. The termination liability will be reduced \$1,388.79 for each month the interface is in service.	

N. VIDEO CIRCUIT FOR LEON COUNTY JAIL AND LEON COUNTY COURTHOUSE (Central Telephone)

1. General

- a. This tariff is a special assembly tariff to provide a broadcast quality video loop and the required optic terminals between the county jail and county courthouse. The CODEC will be provided by the subscriber.

GENERAL EXCHANGE TARIFF

Embarq Florida, Inc.

By: F.B. Poag  
Director

Section A5  
Second Revised Sheet 51  
Cancelling First Revised Sheet 51  
Effective: September 29, 2004

CHARGES APPLICABLE UNDER SPECIAL CONDITIONS

N. VIDEO CIRCUIT FOR LEON COUNTY JAIL AND LEON COUNTY COURTHOUSE (Central Telephone) (Cont'd)

2. Rates

	<u>NRC</u>	<u>Monthly Rate</u>
a. Optic Terminal-Customer Premise 2 Each Circuit		\$ 171.00
b. Optic Terminal-Central Office 2 Each Circuit		183.00
c. IOC Channel Termination-C.O. 2 Each Circuit		159.00
d. IOC Fiber Channel 1 Each Circuit		21.00
e. Local Channel Each Customer Location	\$ 557.00	65.00

O. SPECIAL DISASTER RELIEF RATES INITIATED BY THE COMPANY

1. At the discretion of the Company following a disaster, an emergency due to a major event such as a hurricane, the Company may discount and/or waive recurring and non-recurring rates and charges for subscriber disaster victims in a defined geographic area, e.g., exchange or exchanges, for a period beginning immediately after the disaster for a period of up to one year. Such services include but are not limited to non-recurring installation charges for temporary relocation of basic service, recurring charges for vacation service and call forwarding services.

GENERAL EXCHANGE TARIFF

Embarq Florida, Inc.

SECTION A6

By: F. B. Poag  
Director

Third Revised Contents Sheet 1  
Cancelling Second Revised Contents Sheet 1  
Effective: February 3, 2006

DIRECTORY LISTINGS

CONTENTS

	<u>SECTION</u>
A. GENERAL REGULATIONS .....	1
B. RESIDENCE LISTINGS .....	4
C. BUSINESS LISTINGS .....	5
D. PRIVATE BRANCH EXCHANGE LISTINGS .....	8
E. PAY TELEPHONE LISTINGS .....	9
F. MISCELLANEOUS LISTINGS .....	9
1. Reference Listings .....	9
2. Names Spelled More than One Way .....	10
3. Indented Listings .....	10
4. Caption Listings .....	11
5. Alternative (Directive) Listings .....	12
6. Temporary Listings for Tenants Subleasing Subscribers' Premises .....	13
7. Foreign Exchange Listings .....	14
8. Additional Line Matter .....	15
9. Advance Listings .....	16
10. Vanity Listings.....	16
11. Rates and Charges.....	17

GENERAL EXCHANGE TARIFF

Embarq Florida, Inc.

By: F. B. Poag  
Director

SECTION A6  
First Revised Contents Sheet 2  
Cancelling Original Contents Sheet 2  
Effective: January 1, 1997

DIRECTORY LISTINGS

CONTENTS

	<u>SECTION</u>
G. NONPUBLISHED AND NONLISTED NUMBER SERVICE .....	17
1. General .....	17
2. Nonpublished Telephone Numbers .....	17
3. Nonlisted Telephone Numbers .....	20
4. Utilization of Emergency E911 Service .....	20
5. Rates and Charges .....	20
6. Exceptions .....	21
H. LOCAL EXCHANGE TELEPHONE DIRECTORIES .....	21

GENERAL EXCHANGE TARIFF

Embarq Florida, Inc.

By: F. B. Poag  
Director

SECTION A6  
First Revised Sheet 1  
Cancelling Original Sheet 1  
Effective: January 1, 1997

DIRECTORY LISTINGS

A. GENERAL REGULATIONS

1. The rates and regulations specified herein for directory listings apply only to the alphabetical section of the telephone directory.
2. Listings are intended solely for the purpose of identifying subscribers' telephone numbers and as an aid to the use of the telephone service. The listing of subscribers without charge or at the rate specified herein for additional listings in the alphabetical section of the directory does not contemplate special prominence of arrangement.
3. The Company, in accepting listings as prescribed by subscribers or prospective subscribers, will not be a party to controversies between subscribers as a result of the publication of such listings in its directories.
4. Listings are furnished only as specified for the various services mentioned in this section. Listings which, in the opinion of the Company, are not necessary in connection with any services or facilities not specifically mentioned in this section are not furnished either with or without charge.
5. The Company reserves the right to limit the length of any listing to one line in the directory by the use of abbreviations when, in the judgment of the Company, the clearness of the listing and the identification of the subscriber is not impaired in any way.

GENERAL EXCHANGE TARIFF

Embarq Florida, Inc.

By: F. B. Poag  
Director

SECTION A6  
First Revised Sheet 2  
Cancelling Original Sheet 2  
Effective: January 1, 1997

DIRECTORY LISTINGS

A. GENERAL REGULATIONS (Cont'd)

6. The number of listings permitted without extra charge in connection with exchange service is as follows:
  - a. Individual lines, each access line..... 1 listing
  - b. Private Branch Exchanges directly connected to a central office (including "Series" and Centrex), each system..... 1 listing
  - c. Shared Tenant System, each STS system... 1 listing
  - d. Mobile Carrier system, each system..... 1 listing
7. It is desired by the Company that all subscribers shall be properly listed in the directory. Errors or omissions should be promptly reported to the business office.
8. In connection with individual line service where there is more than one access line connected for rotary service, only one listing is regularly furnished. However, additional name listings, which would otherwise be available at the regular rate for additional listings, may be obtained without charge provided they do not exceed the number of access lines or auxiliary lines. Additional listings on consecutive numbers usually bear the call number of the first line.
9. No listing, with or without charge, will be permitted where such listing is a repetition of any other listing furnished the subscriber.



GENERAL EXCHANGE TARIFF

Embarq Florida, Inc.

By: F. B. Poag  
Director

SECTION A6  
First Revised Sheet 3  
Cancelling Original Sheet 3  
Effective: January 1, 1997

DIRECTORY LISTINGS

A. GENERAL REGULATIONS (Cont'd)

10. Charges for extra listings are automatically discontinued after the following circumstances:
  - a. Upon termination of the main contract for service.
  - b. The listed party becomes a subscriber to exchange service, similar in classification, i.e., business or residence, as that under which such party is already listed.
  - c. In the case of the death of the listed party.
  - d. Listing charges may be discontinued at the end of any directory period upon receipt of written notice from the subscriber requesting discontinuance of listing at least 30 days in advance of the closing date of the directory. In this case, the minimum listing charge will be for one directory period.
  - e. In case the listed party moves from the premises at which the exchange service listed is furnished.
  
11. Street numbers, followed by the names of streets, will be used in identifying the location of the subscriber, except when, in the judgment of the Company, names of buildings, apartment houses, or communities serve as a better means of identification. Corner addresses are undesirable and, except in the judgment of the Company, will be used only where the street number is not available or as additional line matter. The use of floor, room, or suite numbers of buildings or apartment houses or other such detailed designations, are not permitted except as additional line matter.

GENERAL EXCHANGE TARIFF

Embarq Florida, Inc.

By: F. B. Poag  
Director

SECTION A6  
Second Revised Sheet 4  
Cancels First Revised Sheet 4  
Effective: November 30, 2004

DIRECTORY LISTINGS

A. GENERAL REGULATIONS (Cont'd)

13. The Company reserves the right to reject additional listings when, in its judgment, such listings would tend to delay or impede the use of the service.

B. RESIDENCE LISTINGS

1. Residence listings normally consist of a name, the address of the premises at which service is rendered and the telephone number. The address of the premises at which service is rendered may be omitted at the request of the subscriber. At no charge and upon the request of any residential subscriber, the Company shall list an additional first name or initial under the same address, telephone number and surnames of the subscriber. The Company shall place the first names or initials in the order requested by the subscriber.
2. The primary listing is ordinarily the name of the individual who contracts for the service. Where the service is contracted for by one party for the use of a second party, the primary listing may be the name of the second party. Additional listings may be furnished in the names of relative, including those by marriage, domestic employees of the subscriber, or other persons residing in the subscriber's house who are recognized as a part of the subscriber's domestic establishment.
3. Listings of residence telephones of clergymen, physicians, surgeons, dentists, veterinary surgeons, professors, government officials, etc., may, for the purpose of identification, include abbreviated designations of titles. Also, the title of "Mrs.," "Miss" or "Ms." is permitted. Degrees are permitted when they serve as a means of better identification; however, titles and designations will be omitted when a degree is used which conveys adequate information.
4. All listings in connection with residence service at concession rates are furnished subject to the regulations specified in this section, except that in connection with residence service for employees of the Company, where two or more employees reside at the same address and use the same telephone, the name of each additional employee may be listed, regardless of whether or not such employees are members of the subscriber's immediate family. The charge, therefore, will be the regular rate for an additional listing.

GENERAL EXCHANGE TARIFF

Embarq Florida, Inc.

By: F. B. Poag  
Director

SECTION A6  
Second Revised Sheet 5  
Cancels First Revised Sheet 5  
Effective: November 30, 2004

DIRECTORY LISTINGS

B. RESIDENCE LISTINGS (Cont'd)

5. DUAL-NAME LISTINGS

A. Dual-name listings are defined as a combination of names and/or initials of two individuals with the same or different surname(s), residing at the same address or of one person known by two sets of first and/or middle names and/or initials.

B. The following examples illustrate the format options for dual-name listings:

1. PRIMARY LISTING

Jones, John & Mary	123 Main St	Anytown 12345	123 456-7890
or			
Jones, John T & Mary F	123 Main St	Anytown 12345	123 456-7890
or			
Jones, Mary F	123 Main St	Anytown 12345	123 456-7890
or			
Jones, John T Mrs	123 Main St	Anytown 12345	123 456-7890
or			
Jones, John & Mary Smith	123 Main St	Anytown 12345	123 456-7890
or			
Jones, John & Tom Smith	123 Main St	Anytown 12345	123 456-7890

2. PRIMARY WITH ADDITIONAL LISTING(s)

Jones, John T	123 Main St	Anytown 12345	123 456-7890
Jones, Mary F & John T	123 Main St	Anytown 12345	123 456-7890
Jones, John T Tex	123 Main St	Anytown 12345	123 456-7890
Jones, John & Mary Smith	123 Main St	Anytown 12345	123 456-7890
Smith, Mary	123 Main St	Anytown 12345	123 456-7890
Jones, John & Tom Smith	123 Main St	Anytown 12345	123 456-7890
Smith, Tom	123 Main St	Anytown 12345	123 456-7890

GENERAL EXCHANGE TARIFF

Embarq Florida, Inc.

SECTION A6

By: F. B. Poag  
Director

First Revised Sheet 5.1  
Cancelling Original Sheet 5.1  
Effective: November 30, 2004

DIRECTORY LISTINGS

B. RESIDENCE LISTINGS (Cont'd)

5. DUAL-NAME LISTINGS (Cont'd)

- C. Dual-name listings are available only for residence subscribers.
- D. Dual-name listings may be provided as the primary listing at no monthly recurring charge for the addition of the second name to the listing.
- E. Dual-name listings may be provided as an additional listing at the customer's option at the regular additional listing rate.
- F. A service charge as specified in Section A4 applies for:
  - 1. Changing a primary single-name directory listing to a primary dual-name directory listing.
  - 2. Changing the primary or additional dual-name directory listing once established.
  - 3. Changing an additional dual-name directory listing to a primary dual-name directory listing.
- G. No nonrecurring charge applies when the dual-name listing is established with the initial establishment of service or when a change in an existing listing is requested on an order for which service charges are otherwise applicable.

GENERAL EXCHANGE TARIFF

Embarq Florida, Inc.

By: F. B. Poag  
Director

SECTION A6  
Second Revised Sheet 6  
Cancels First Revised Sheet 6  
Effective: November 30, 2004

DIRECTORY LISTINGS

C. BUSINESS LISTINGS

1. Business listings normally consist of a name, designation descriptive of the subscriber's business, the address of the premises at which service is rendered, and the telephone number. The address of the premises at which service is rendered may be omitted at the request of the subscriber.
2. The primary listing is ordinarily the name of the individual, firm or corporation which contracts for the service or the name under which a business is regularly conducted. Where the service is contracted for by one party for the use of a second party, the primary listing may be the name of the second party. Additional listings may be furnished in the names of partners or members of the firm, if the subscriber is a partnership or firm: the names of officers of a corporation, if the subscriber is a corporation; and for any business establishment, the names of associates or employees of the subscriber. Business additional listings may also be the bona fide names of individuals, firms, or corporations which the subscriber owns, controls or is duly authorized to and actually does represent. An additional listing may also be provided for the residence of a business subscriber when the business is located at or operated from the residence.
3. A trade name made up by adding a term such as Company, Agency, Shop, Works, etc., to the name of a commodity or service will not be accepted as a listing unless the subscriber is legally authorized to do business under the trade name.
4. A designation consists of a word or phrase, abbreviated where necessary, used to describe the general character of the subscriber's business. Designations will not be used where the name under which the subscriber is doing business is sufficient to indicate the character of the business.

GENERAL EXCHANGE TARIFF

Embarq Florida, Inc.

By: F. B. Poag  
Director

SECTION A6  
First Revised Sheet 7  
Cancelling Original Sheet 7  
Effective: January 1, 1997

DIRECTORY LISTINGS

C. BUSINESS LISTINGS (Cont'd)

5. Listings of clergymen, physicians, surgeons, dentists, veterinary surgeons, professors, government officials, etc., may, for the purpose of identification, include abbreviated designations of titles. Also, the title of "Mrs.," "Miss" or "Ms." is permitted. Degrees are permitted when they serve as a means of better identification; however, titles and designations will be omitted when a degree is used which conveys adequate information.
6. The listing of an individual, together with his/her title and the name of the business with which he/she is connected or represents, in lieu of a designation of the general character of the business, is not permitted. Likewise, the listing of the name of a firm or corporation, together with the name or name and title of an individual connected therewith, in lieu of a designation of the character of the business is not permitted.

Example:

Smith, J.G. Mgr.,	Lewis Grocery Co.	14 Maple	NXX-1214
	Or		
Lewis Grocery Co.,	Smith, J.G. Mgr.	14 Maple	NXX-1214

7. All listings of a subscriber's services which are located on the same premises, must bear the same address, except in the case of PBX trunk off-premises extension service, the address may be that of the premises at which the exchange station off-premises extension is located.

GENERAL EXCHANGE TARIFF

Embarq Florida, Inc.

By: F. B. Poag  
Director

SECTION A6  
First Revised Sheet 8  
Cancelling Original Sheet 8  
Effective: January 1, 1997

DIRECTORY LISTINGS

C. BUSINESS LISTINGS (Cont'd)

8. The Company reserves the right to reject listings which appear to be designated primarily to give publicity to the commodity or service, or which, in its judgment, are otherwise objectionable or unnecessary for identification purposes.

D. PRIVATE BRANCH EXCHANGE LISTINGS

1. In connection with private branch exchange (PBX) service, only one listing is ordinarily necessary to properly identify the subscriber. Additional listings may be furnished without extra charge when, in the judgment of the Company, they are necessary to properly identify the subscriber or would be helpful to his/her service, provided they do not exceed the number of trunk lines. All listings, with or without extra charge, usually bear the call number of the first trunk line. However, at the request of the customer, they may bear any of the consecutive numbers including listings of those numbers employed in receiving calls when the PBX operator is not on duty. The listing of a trunk line not consecutive with the rotary series or a listing of the first number of a separate rotary series of trunk lines may be arranged for to meet special conditions.
2. When, in the judgment of the Company, the use of reference or other listings in excess of the number of listings permitted without extra charge, as set out previously, are needed for better identification in order to facilitate the Company's operations, such listings may be provided without charge.

GENERAL EXCHANGE TARIFF

Embarq Florida, Inc.

By: F. B. Poag  
Director

SECTION A6  
Second Revised Sheet 9  
Cancelling First Revised Sheet 9  
Effective: April 1, 1997

DIRECTORY LISTINGS

D. PRIVATE BRANCH EXCHANGE LISTINGS (Cont'd)

3. Listings of PBX trunks installed at either business or residence locations are furnished under the regulations specified above for residence and business listings, respectively.

E. PAY TELEPHONE LISTINGS

Listings are not provided in connection with pay telephone service except where, in the judgment of the Company, the listing will facilitate the Company's operation. No additional charge (paid) listings are permitted.

F. MISCELLANEOUS LISTINGS

1. Reference Listings

Reference listings may be arranged for at the regular rate for additional listings when both the main and reference listings appear in the same alphabetical list (directory Section). Reference listings may be furnished to subscribers who change their names, absorb other businesses or subdivide their business and have the authority to continue the use of the old names; and in other cases, when in the judgment of the Company, they are considered necessary and are not intended for advertising purposes.

Example: Long Lumber Co. .... See South Lumber Co.





GENERAL EXCHANGE TARIFF

Embarq Florida, Inc.

By: F. B. Poag  
Director

SECTION A6  
First Revised Sheet 11  
Cancelling Original Sheet 11  
Effective: January 1, 1997

DIRECTORY LISTINGS

F. MISCELLANEOUS LISTINGS (Cont'd)

4. Caption Listings

- a. Listings may be indented under a caption or subcaption at no additional charge when, in the judgment of the Company, the captions will facilitate the use of the service. The captions must be an essential part of the indented listings which follow and should include names of departments, branches of business or title of officials.

Example: Standard Oil Co.  
Gen'l Ofc 2500 Broadway ..... NXX-1234  
Dist Mgr 500 Oak ..... NXX-1225  
Res ..... NXX-1435  
Service Stations  
122 Elm ..... NXX-2222  
45 Oak ..... NXX-3456  
400 Pine ..... NXX-2851

- b. The names of individuals are not permitted in listings to be indented under captions except when, in the judgment of the Company, name captions will further identify individuals or officers with the same title.

Example: Judges County Court  
Potter, Harold A. .... NXX-1234  
Gorman, Janice V. .... NXX-3324  
Gomez, Lester R. .... NXX-3256

GENERAL EXCHANGE TARIFF

Embarq Florida, Inc.

By: F. B. Poag  
Director

SECTION A6  
First Revised Sheet 12  
Cancelling Original Sheet 12  
Effective: January 1, 1997

DIRECTORY LISTINGS

F. MISCELLANEOUS LISTINGS (Cont'd)

4. Caption Listings (Cont'd)

- c. Listings of departments and of variations of the same general line of business which, in the judgment of the Company, are not considered necessary or which are intended to advertise the extent of the subscriber's business, are not permitted.

5. Alternative (Directive) Listings

- a. Subscribers may obtain listings which refer calling parties to certain other telephone numbers after business hours or on Sundays and Holidays, or in case no answer is received on the call for the first listed number of numbers. Such listings are provided at the regular rate for an additional listing. Alternate listings are of two general types, according to whether the listing indicates (a) that the alternate telephone number is to be called after business hours, or on Sundays or Holidays, or (b) that the alternate telephone number is to be called in the event that no answer is received on the call for the first number or numbers.
- b. Alternate listings which refer calling parties to other telephone numbers may indicate the telephone numbers of subscribers who are agreeable to the use of their telephone numbers in such alternate listings or they may be the telephone numbers of members or employees of the firm. Names of individuals are not permitted in alternate listings.

GENERAL EXCHANGE TARIFF

Embarq Florida, Inc.

By: F. B. Poag  
Director

SECTION A6  
First Revised Sheet 13  
Cancelling Original Sheet 13  
Effective: January 1, 1997

DIRECTORY LISTINGS

F. MISCELLANEOUS LISTINGS (Cont'd)

5. Alternative (Directive) Listings (Cont'd)

b) (Cont'd)

Examples:	Northgate Water & Sewer Corp. 2001 Main St. ....	NXX-1234
	Nights & Sundays call .....	NXX-3214
	Jones Hardware 2233 First .....	NXX-3456
	After 5 pm, Sundays & Holidays call Service Manager .....	NXX-3344
	Stewart's Plumbing Co. 2 Elm .....	NXX-4455
	If no answer call .....	NXX-5544

6. Temporary Listings for Tenants Subleasing Subscribers' Premises

- a. Residence subscribers who lease their premises for periods of nine months or less and who request the Company to render service to their tenants without change in billing may arrange for the listing of such tenants.
- b. Such listings will not be furnished in the event the subscriber and the tenant occupy the premises at the same time.
- c. For such listings, the additional listing rate applies.

GENERAL EXCHANGE TARIFF

Embarq Florida, Inc.

By: F. B. Poag  
Director

SECTION A6  
First Revised Sheet 14  
Cancelling Original Sheet 14  
Effective: January 1, 1997

DIRECTORY LISTINGS

F. MISCELLANEOUS LISTINGS (Cont'd)

6. Temporary Listings for Tenants Subleasing Subscribers' Premises (Cont'd)
  - d. Bills covering all charges will be rendered in the name of the subscriber and the subscriber will be responsible for all such charges.
7. Foreign Exchange Listings
  - a. Foreign Exchange listings are offered to subscribers who wish to be listed in a telephone directory of an exchange other than their home exchange.
  - b. Foreign exchange listings to appear in a Company exchange directory are furnished at the rates approved for additional listings.
  - c. Foreign exchange listings for the Company. subscribers are furnished at the approved rates of the company accepting the listing for publication in their exchange directory and will be printed in the format used by the company accepting the listing.
  - d. When, in the judgment of the Company, in the case of stations located in exchange border areas, a foreign exchange listing is needed for better identification in order to facilitate the completion of calls, such listing may be provided without charge. This service is also intended for those customers who receive telephone service from one exchange and yet have a premises mailing address in another (foreign) exchange.

GENERAL EXCHANGE TARIFF

Embarq Florida, Inc.

By: F. B. Poag  
Director

SECTION A6  
First Revised Sheet 15  
Cancelling Original Sheet 15  
Effective: January 1, 1997

DIRECTORY LISTINGS

F. MISCELLANEOUS LISTINGS (Cont'd)

8. Additional Line Matter

- a. Additional line matter may be arranged for at the regular rate for additional listings when the subscriber wishes to provide additional information to calling parties and when, in the judgment of the Company, it is not intended for advertising purposes.
- b. Additional line matter may include supplementary address information, hours of operation, mailing information or calling instructions.
- c. The names of individuals are not permitted in additional line matter.
- d. Additional line matter must provide information directly related to the subscriber's main listing or address where the service is located.
- e. The Company reserves the right to reject listings which, in its' judgment, are objectionable or may be detrimental to the service of other subscribers.
- f. Hearing impaired customers with TDDs may request an additional directory listing indicating "TDD" or "TDD and Voice" at no charge.

GENERAL EXCHANGE TARIFF

Embarq Florida, Inc

BY: F. B. Poag  
Director

SECTION A6  
Ninth Revised Sheet 16  
Cancelling Eighth Revised Sheet 16  
Effective: March 18, 2006

DIRECTORY LISTINGS

F. MISCELLANEOUS LISTINGS (Cont'd)

9. Advance Listings

- a. When a subscriber will establish a residence or business shortly after the close of subscriber listing records but preceding publication, the exchange company shall, upon request, establish and list service at the requested new address and immediately place the service on suspension.
- b. Service connection charges as specified in Section A4 and other appropriate local service charges shall be due and payable, independent of whether service is later restored.

10. Vanity Listings

- a. Where available, a subscriber may request to have the assigned telephone number published in the telephone directory in upper case alpha form, i.e., "333-THIS", rather than 333-8447. Use of Vanity Listings is not exclusive to any single subscriber. The letters "Q" and "Z" are not available nor may the "#" or "\*" symbols be used with this service. The numbers "0" or "1" may not be used to represent the letters "O" or "I", respectively, in a Vanity Listing.
- b. Prior to establishing a Vanity Listing, the Company reserves the right to require, when necessary in its sole discretion, satisfactory evidence from the subscriber that the subscriber is authorized to use any trade name, business name, or any other name or term, requested by the subscriber, which is copyrighted or otherwise reserved.
- c. Provisioning of a Vanity Listing is based upon the current availability of that telephone number. The Company reserves the right to exclude certain numbers or blocks of numbers from assignment, and will determine the availability criteria in its sole discretion. No customer waiting lists will be maintained. The Company reserves the right to reject any listing or number, which in its sole discretion, may be considered objectionable or would tend to delay or impede the use of the directory.
- d. The Company will not be a party to any controversy or conflict between customers as a result of the Vanity Listing.
- e. The customer shall have no property right in the Vanity Listing, and the number shall remain the property of the Company. The Company reserves the right to change the Vanity Listing in its sole discretion. The Company is not liable for any kind of monetary or damage claims due to errors, omissions, or customer problems associated with Vanity Listings.
- f. Vanity Listings may be listed in the Company directories white pages at the rates provided in this Section. Customers wanting the Vanity Listing will be charged the Vanity Listing rate in addition to the applicable nonrecurring rates found in Section 4. Customers wanting the Vanity Listing with the numeric equivalent listing will be charged the Vanity Listing rate and the Additional Listing rate in addition to the applicable nonrecurring rates found in Section 4. When listed, the numeric equivalent of the Vanity Listing shall immediately follow the alpha listing in the directory. Only the numerical listing shall be available from Directory Assistance.

GENERAL EXCHANGE TARIFF

Embarq Florida, Inc.

By: F. B. Poag  
Director

SECTION A6  
Second Revised Sheet 17  
Cancels First Revised Sheet 17  
Effective: February 3, 2006

DIRECTORY LISTINGS

F. MISCELLANEOUS LISTINGS (Cont'd)

11. Rates and Charges

- a. Additional name listings in excess of those permitted without extra charge, reference listings, alternative (directive) listings, temporary listings, foreign exchange listings, listings for clients of Shared Tenant Service, Mobile Carriers, and Pay Telephone Service (PATS) operations and additional line matter, where permitted, are furnished at the following monthly rates:

	<u>Monthly Rate</u>
Per foreign exchange listing, residence	\$3.00
Per foreign exchange listing, business	\$3.00
Per Vanity Listing, residence	3.00
Per Vanity Listing, business	5.00
Per listing, all other types of listings, residence	1.85
Per listing, all other types of listings, business	1.85

- b. A charge will be applicable if such listings are requested after the service is established. The subscriber to the service assumes responsibility for all charges for additional listings associated with his/her service.
- c. Listing charges date from the day the information records are posted and are payable monthly in advance. Information records are posted at the time of the application for the listing.

G. NONPUBLISHED AND NONLISTED NUMBER SERVICE

1. General

Some subscribers request their telephone numbers be omitted from both the directory and the Company's information records. Such requests may be fulfilled through the assignment of a nonpublished or nonlisted telephone number subject to the regulations outlined below.

2. Nonpublished Telephone Numbers

- a. A nonpublished telephone number is one omitted from both the directory and the Company's information records. Such requests are discouraged as far as possible, and the subscriber requesting this service releases the Company from all responsibility for losses arising from such an arrangement.



GENERAL EXCHANGE TARIFF

Embarq Florida, Inc.

By: F. B. Poag  
Director

SECTION A6  
First Revised Sheet 18  
Cancelling Original Sheet 18  
Effective: January 1, 1997

DIRECTORY LISTINGS

G. NONPUBLISHED AND NONLISTED NUMBER SERVICE (Cont'd)

2. Nonpublished Telephone Numbers (Cont'd)

- b. Nonpublished numbers will not be furnished upon request of a calling party. However, when a call is placed from a telephone number associated with a nonpublished listing, the number may be disclosed if the called party has the necessary equipment for receiving and/or disclosing incoming telephone numbers.
- c. Incoming calls to nonpublished telephone numbers will be completed by the Company only when the calling party places the call by number. The Company will not complete a call to a nonpublished subscriber on behalf of another caller when the caller does not furnish the nonpublished number to the Company. The Company will adhere to this practice notwithstanding any claim of emergency the calling party may present. The acceptance by the Company of the subscriber's request to furnish a nonpublished number does not create any relationship or obligation, direct or indirect, to any person other than the subscriber.

GENERAL EXCHANGE TARIFF

Embarq Florida, Inc.

By: F. B. Poag  
Director

SECTION A6  
First Revised Sheet 19  
Cancelling Original Sheet 19  
Effective: January 1, 1997

DIRECTORY LISTINGS

G. NONPUBLISHED AND NONLISTED NUMBER SERVICE (Cont'd)

2. Nonpublished Telephone Numbers (Cont'd)

- d. In the absence of gross negligence or willful misconduct, no liability for damages arising from publishing a nonpublished telephone number in the directory or disclosing said number to any person attached to the Company, and where such a number is published in the directory, the Company's liability shall be limited to and satisfied by a refund of any monthly charges which the Company may have made for such nonpublished telephone number. In addition, and at the subscriber's request, the Company will change the nonpublished telephone number at no charge to the subscriber.
- e. Telephone numbers transmitted via Caller ID are intended solely for the use of the Caller ID subscriber. Resale of this information is prohibited as described in Section A13 of this tariff.
- f. The subscriber indemnifies and saves the Company harmless against any and all claims for damages caused or claimed to have been caused, directly or indirectly, by the publication of a nonpublished telephone number or the disclosing of said number to any person.

GENERAL EXCHANGE TARIFF

Embarq Florida, Inc.

BY: F. B. Poag  
Director

SECTION A6  
Tenth Revised Sheet 20  
Cancelling Ninth Revised Sheet 20  
Effective: November 12, 2004

DIRECTORY LISTINGS

G. NONPUBLISHED AND NONLISTED NUMBER SERVICE (Cont'd)

3. Nonlisted Telephone Numbers

- a. A nonlisted telephone number is one for which no listing appears in the alphabetical section of the directory. The number is listed in the directory assistance records and is given out upon request.
- b. The acceptance by the Company of the subscriber's request to furnish a nonlisted telephone number does not create any relationship or obligation, direct or indirect, to any person other than the subscriber.

4. Utilization of Emergency E911 Service

Parties with nonpublished or nonlisted telephone numbers forfeit the privacy afforded by this service to the extent that the telephone number, address, and name associated with the originating access line are automatically delivered to the emergency answering point when the customer calls E911 service.

5. Utilization of Call Tracing and Requests for Tracing Calls (Trap and Trace)

Parties with nonpublished or nonlisted numbers forfeit the privacy afforded by the service to the extent that the telephone number is identified through activation of a Trap and Trace and/or Call Tracing procedure whereby the name and address of the subscriber will be provided to any authorized law enforcement agency upon request.

6. Rates and Charges

	<u>Monthly Rate</u>
Nonpublished Number, per month	\$3.00
Nonlisted Number, per month	\$2.55

Charges as specified in Section A4 are applicable if this service is requested subsequent to initial service.

GENERAL EXCHANGE TARIFF

Embarq Florida, Inc.

By: F. B. Poag  
Director

SECTION A6  
First Revised Sheet 21  
Cancelling Original Sheet 21  
Effective: January 1, 1997

DIRECTORY LISTINGS

G. NONPUBLISHED AND NONLISTED NUMBER SERVICE (Cont'd)

6. Exceptions

The foregoing rates do not apply for the following services:

- a. When additional service is furnished to the same subscriber who has service listed in the telephone directory at the same address.
- b. When additional service is furnished to the same subscriber who has service listed in the telephone directory at a different address, provided arrangements are such that calls to the listed number will be answered at all times, and the listed service is in the same exchange area.
- c. When a subscriber's telephone number terminates in a telecommunications device for the deaf (TDD) due to hearing or speech impairment.
- d. For subscribers to Pay Telephone Service (PATs) as defined in Section A7 of this tariff.

H. LOCAL EXCHANGE TELEPHONE DIRECTORIES

1. Exchange telephone subscribers will receive revised, updated telephone directories for the exchange from which they receive service at least once every fifteen months, normally once every twelve months.

GENERAL EXCHANGE TARIFF

Embarq Florida, Inc.

By: F. B. Poag  
Director

SECTION A6  
Second Revised Sheet 22  
Cancelling First Revised Sheet 22  
Effective: November 27, 1998

DIRECTORY LISTINGS

H. LOCAL EXCHANGE TELEPHONE DIRECTORIES (Cont'd)

2. The directories shall normally alphabetically list the name, address and telephone number of all subscribers located in the exchange(s) contained in the directory, except the telephone numbers for pay telephones or telephone numbers unlisted or unpublished at the subscriber's request.
3. Telephone directories are furnished subscribers to facilitate the use of the service. They remain the property of the Company and may be collected upon issuance of new directories.
4. Pay telephone service (PATS) subscribers shall be provided with the number of directories to meet their requirements at no charge.
5. Customers shall receive one telephone directory for each access line or trunk in service. Subject to availability, additional directories shall be provided by the Company based on customer requests. The Company reserves the right to limit the number of additional or replacement directories.
6. Volume requests that exceed the Company's capability to provide directories from its on-site supply may be referred to the directory publishing company for direct shipment.
7. The subscriber will be charged the rate invoiced to the Company by the publishing company for each directory requested, plus any mailing costs. Mailing costs will be assessed the subscriber based on bound printed matter, postal zone and weight charges established by the U. S. Postal Service.

GENERAL EXCHANGE TARIFF

Embarq Florida, Inc.

SECTION A7

By: F. B. Poag  
Director

Fourth Revised Contents Sheet 1  
Cancelling Third Revised Contents Sheet 1  
Effective: September 3, 1997

COIN TELEPHONE SERVICE

CONTENTS

A.	Reserved For Future Use	
B.	Reserved For Future Use	
C.	PAY TELEPHONE SERVICE .....	10
1.	General .....	10
2.	Directory Listings .....	11
3.	Responsibility of Customer .....	12
4.	Violation of Tariff .....	14
5.	Optional Service Features .....	15
6.	Rates and Charges .....	23.1
7.	Billing and Collection Service (United Telephone exchanges only) .....	28
D.	PUBLIC SET USE FEE .....	31
1.	General .....	31
2.	Rates and Charges .....	33
E.	COIN LINE SERVICE .....	33
1.	General .....	33
2.	Rates and Charges .....	37

GENERAL EXCHANGE TARIFF

Embarq Florida, Inc.

By: F. B. Poag  
Director

SECTION A7  
Second Revised Sheet 1  
Cancelling First Revised Sheet 1  
Effective: April 1, 1997

COIN TELEPHONE SERVICE

RESERVED FOR FUTURE USE

GENERAL EXCHANGE TARIFF

Embarq Florida, Inc.

By: F. B. Poag  
Director

SECTION A7  
Second Revised Sheet 2  
Cancelling First Revised Sheet 2  
Effective: April 1, 1997

COIN TELEPHONE SERVICE

RESERVED FOR FUTURE USE



GENERAL EXCHANGE TARIFF

Embarq Florida, Inc.

By: F. B. Poag  
Director

SECTION A7  
Second Revised Sheet 3  
Cancelling First Revised Sheet 3  
Effective: April 1, 1997

COIN TELEPHONE SERVICE

RESERVED FOR FUTURE USE

GENERAL EXCHANGE TARIFF

Embarq Florida, Inc.

By: F. B. Poag  
Director

SECTION A7  
Second Revised Sheet 4  
Cancelling First Revised Sheet 4  
Effective: April 1, 1997

COIN TELEPHONE SERVICE

RESERVED FOR FUTURE USE

GENERAL EXCHANGE TARIFF

Embarq Florida, Inc.

By: F. B. Poag  
Director

SECTION A7  
Second Revised Sheet 5  
Cancelling First Revised Sheet 5  
Effective: April 1, 1997

COIN TELEPHONE SERVICE

RESERVED FOR FUTURE USE

GENERAL EXCHANGE TARIFF

Embarq Florida, Inc.

By: F. B. Poag  
Director Effective: April 1, 1997

SECTION A7  
Second Revised Sheet 6  
Cancelling First Revised Sheet 6

COIN TELEPHONE SERVICE

RESERVED FOR FUTURE USE

GENERAL EXCHANGE TARIFF

Embarq Florida, Inc.

By: F. B. Poag  
Director

SECTION A7  
Second Revised Sheet 7  
Cancelling First Revised Sheet 7  
Effective: April 1, 1997

COIN TELEPHONE SERVICE

RESERVED FOR FUTURE USE

GENERAL EXCHANGE TARIFF

Embarq Florida, Inc.

By: F. B. Poag  
Director

SECTION A7  
Second Revised Sheet 8  
Cancelling First Revised Sheet 8  
Effective: April 1, 1997

COIN TELEPHONE SERVICE

RESERVED FOR FUTURE USE

GENERAL EXCHANGE TARIFF

Embarq Florida, Inc.

By: F. B. Poag  
Director

SECTION A7  
Second Revised Sheet 9  
Cancelling First Revised Sheet 9  
Effective: April 1, 1997

COIN TELEPHONE SERVICE

RESERVED FOR FUTURE USE

GENERAL EXCHANGE TARIFF

Embarq Florida, Inc.

By: F. B. Poag  
Director

SECTION A7  
Second Revised Sheet 10  
Cancelling First Revised Sheet 10  
Effective: April 15, 1997

COIN TELEPHONE SERVICE

C. PAY TELEPHONE SERVICE

1. General

- a. Pay Telephone Service (PATS) is a class of service furnished to individuals, firms or corporations which permits connection of a customer-provided instrument that is activated by the deposit of coins, cards, tokens or the entry of a customer account number, to the lines of the Company.
- b. The Company will not be responsible for the operation, maintenance, coin refund, or coin collection of any PATS instrument nor will Company employees offer PATS operating instructions for those instruments.
- c. Intrastate discounted long distance calling plans are permitted in connection with PATS access lines.
- d. Participation of subscribers to PATS service in optional EAS plans is not allowed.
- e. Subscribers to PATS service are subject to the rates, rules and regulations as specified elsewhere in this tariff, as well as the regulations found in Section 25-24.515 of the Florida Public Service Commission Rules and Regulations.
- f. Foreign Exchange Service will be provided only within the local calling area in accordance with regulations as specified in Section A9 of this tariff.



GENERAL EXCHANGE TARIFF

Embarq Florida, Inc.

By: F. B. Poag  
Director

SECTION A7  
First Revised Sheet 11  
Cancelling Original Sheet 11  
Effective: January 1, 1997

COIN TELEPHONE SERVICE

C. PAY TELEPHONE SERVICE (Cont'd)

1. General

- g. Suspension of service, offered in Section A2, is not available to PATS access lines unless all factors indicate that the PATS instrument is located within an establishment which is temporarily closed and that the instrument is totally inaccessible to the general public. In all cases, the decision to permit temporary suspension of service for PATS service rests with the Company.

2. Directory Listings

- a. A listing in the white page section of the exchange directory may be provided in connection with PATS service. The PATS provider, however, may choose to have nonpublished telephone numbers for PATS access lines at no additional charge. Additional listings will be provided at rates specified in Section A6 of this tariff.
- b. Although the PATS provider is entitled to a directory listing without charge, the PATS client may be listed instead at the rate for an Additional Listing.

GENERAL EXCHANGE TARIFF

Embarq Florida, Inc.

By: F. B. Poag  
Director

SECTION A7  
Second Revised Sheet 12  
Cancelling First Revised Sheet 12  
Effective: April 15, 1997

COIN TELEPHONE SERVICE

C. PAY TELEPHONE SERVICE

3. Responsibility of the Customer

- a. The customer shall be responsible for the installation, operation and maintenance of any customer-provided coin-operated or non-coin-operated telephones used in connection with this service.
- b. Instruments connected to a PATS access line must be FCC registered and of a type which permits free caller access to local directory assistance (411), 911, and where 911 is not available, free access to the operator.
- c. All PATS instruments will be required to ring at a level acceptable to the Commission and to receive incoming calls at no charge, except those placed in hospitals, schools, correctional institutions and others for which a specific exemption may be granted.
  - 1) The PATS provider must subscribe to Billed Number Screening and to Operator Screening. Call blocking, as specified in Section A13 of this tariff, is available for PATS providers as a blocking option. PATS providers who elect to allow access to international calling will be advised of the potential for fraud and their responsibility.

GENERAL EXCHANGE TARIFF

Embarq Florida, Inc.

By: F. B. Poag  
Director

SECTION A7  
Second Revised Sheet 13  
Cancelling First Revised Sheet 13  
Effective: April 15, 1997

COIN TELEPHONE SERVICE

C. PAY TELEPHONE SERVICE (Cont'd)

3. Responsibility of the Customer (Cont'd)

c. (Cont'd)

2) One extension station without a dial or coin collector may be allowed for answering purposes only. The extension must be within the premises and within 35 feet of the main station; or, the extension must have a privacy feature which disables the extension when the main station is in use.

d. PATS access lines are standard loop start, two-wire circuits. Optional reverse battery or ground start features are available at rates as stated in Section A13 of this tariff.

e. The PATS provider shall be responsible for payment of a Trouble Location Charge for each visit by the Company to the premises of the subscriber where the service difficulty or trouble reports result from the use of equipment or facilities provided by the subscriber.

f. PATS providers utilizing the first B-1 rate option will be assessed normal PATS usage charges on calls placed over all message rate routes. PATS providers utilizing the second B-1 rate option will be treated as a normal B-1 customer and will pay rates equal to any other B-1 customer.

GENERAL EXCHANGE TARIFF

Embarq Florida, Inc.

By: F. B. Poag  
Director

SECTION A7  
First Revised Sheet 14  
Cancelling Original Sheet 14  
Effective: January 1, 1997

COIN TELEPHONE SERVICE

C. PAY TELEPHONE SERVICE (Cont'd)

3. Responsibility of the Customer (Cont'd)

- g. Customer-provided telephones must be connected to the Company network in compliance with Part 68 of the FCC Rules and Regulations as well as regulatory requirements of the Florida Public Service Commission as found in FPSC Rules 25-24.515.
- h. The PATS provider is responsible for meeting all federal, state and local statutes with respect to provision of customer-provided telephones in accordance with all hearing impaired and handicapped person requirements.
- i. The customer shall be responsible for payment of charges of all toll messages originating from or accepted at this type of service.

4. Violation of Tariff

- a. Where any customer-provided, coin-operated, or non-coin-operated telephone is in violation of this tariff, the Company will promptly notify the customer of the violation and will take immediate action, including the disconnection of service, as is necessary for the protection of the telecommunications network and Company employees. The charge will be provided in Section A4 of this tariff.

GENERAL EXCHANGE TARIFF

Embarq Florida, Inc.

By: F. B. Poag  
Director

SECTION A7  
Second Revised Sheet 15  
Cancelling First Revised Sheet 15  
Effective: May 29, 1997

COIN TELEPHONE SERVICE

C. PAY TELEPHONE SERVICE (Cont'd)

4. Violation of Tariff (Cont'd)

- b. The customer shall discontinue use of the customer-provided coin-operated or non-coin-operated telephone and correct the violation and notify the Company in writing within five days after receipt of such notice that the violation has been corrected.
- c. Failure of the customer to discontinue such use or to correct the violation within 5 days will result in the disconnection or suspension of the customer's service until such time as the customer complies with the provisions of this tariff.

5. Optional Service Features

a. United Telephone exchanges only

- 1) Central Office Blocking with Operator Screening provides outgoing call restriction where facilities are available. PATS providers are required to subscribe to operator screening.

Operator Screening is provided for intraLATA calling through Company operators when the Company is chosen as the presubscribed carrier. Screening for intraLATA and/or InterLATA calling is the responsibility of the carriers who choose to acknowledge the network screening signals passed on to them.

GENERAL EXCHANGE TARIFF

Embarq Florida, Inc.

By: F. B. Poag  
Director

SECTION A7  
Second Revised Sheet 16  
Cancelling First Revised Sheet 16  
Effective: July 17, 1998

COIN TELEPHONE SERVICE

C. PAY TELEPHONE SERVICE (Cont'd)

5. Optional Service Features (Cont'd)

a. United Telephone exchanges only (Cont'd)

1) (Cont'd)

Operator assisted sent-paid calls will not be accepted from PATS telephones.

Per Line	Monthly Rate
	\$1.00

2) PATS providers may also subscribe to Billed Number Screening with rules as stated in Section A13.

a) Per Line	Monthly Rate
	\$1.00

b) The Company shall not collect from a PATS provider for charges billed to a line for calls which originated from that line through the use of 101XXXX+0, 101XXXX+01, 950, or TFC access code, or when the call originating from that line otherwise reached an operator position, if the originating line is subscribed to Operator Screening and the call was placed after the effective date of the Operator Screening order.

GENERAL EXCHANGE TARIFF

Embarq Florida, Inc.

By: F. B. Poag  
Director

SECTION A7  
First Revised Sheet 17  
Cancelling Original Sheet 17  
Effective: January 1, 1997

COIN TELEPHONE SERVICE

C. PAY TELEPHONE SERVICE (Cont'd)

5. Optional Service Features (Cont'd)

a. United Telephone exchanges only (Cont'd)

2) (Cont'd)

c) The Company shall not collect from a PATS provider for charges for collect calls if the line to which the call was billed was subscribed to Billed Number Screening and the call was placed after the effective date of the Billed Number Screening Order.

(1) For purposes of b) and c) preceding, "effective date" shall mean the date after the call screening order was placed and associated charges apply.

d) Any calls billed through the Company, which have been identified as not collectible as described in paragraphs b) and c) preceding, will be removed from any PATS provider's bill after the PATS provider gives notice of the fraudulent charges to the Company. Such notice shall be provided to the Company in writing no later than the due date of the bill.

GENERAL EXCHANGE TARIFF

Embarq Florida, Inc.

By: F. B. Poag  
Director

SECTION A7  
First Revised Sheet 18  
Cancelling Original Sheet 18  
Effective: January 1, 1997

COIN TELEPHONE SERVICE

C. PAY TELEPHONE SERVICE (Cont'd)

5. Optional Service Features (Cont'd)

a. United Telephone exchanges only (Cont'd)

2) (Cont'd)

e) The PATS provider will not be responsible for charges described in d) preceding that are associated with any failure of the screening service subscribed to by the PATS provider.

3) Local calls from PATS access lines are normally dialed and completed without the assistance of a Company operator. However, where the PATS end user requests operator assistance in completing a local call, the charges in A7 C.6.c. are applicable to the end user.

a) Except as stated in b) following, such calls from PATS lines will be completed as collect, third number billed, or credit card calls. Sent-paid calls will not be accepted from PATS lines.

b) Calls from PATS access lines located in prisons, penal institutions, and specified mental institutions may be completed by the operator on a collect only basis. Such calls may not be completed under any other billing arrangement.



GENERAL EXCHANGE TARIFF

Embarq Florida, Inc.

By: F. B. Poag  
Director

SECTION A7  
Second Revised Sheet 19  
Cancelling First Revised Sheet 19  
Effective: November 30, 2005

COIN TELEPHONE SERVICE

C. PAY TELEPHONE SERVICE (Cont'd)

5. Optional Service Features (Cont'd)

a. United Telephone exchanges only (Cont'd)

3) (Cont'd)

c) No usage charges will be assessed to the PATS provider for local calls handled by a Company operator nor will any remittance be due the PATS provider for such calls.

b. Central Telephone exchanges only

1) Central Office Blocking with Operator Screening

Central Office Blocking with Operator Screening is offered to provide a choice of restrictions to a PATS customer. This feature is offered only in digital central offices when facilities are available.

a) Option C - Two-Way Service. Provides screening information to the operator to prevent operator assisted sent-paid calls from being billed to the line. Provides central office blocking of 011+ calls.

b) Option C1 - Same as Option C except 1+900 and 976 calls are also blocked.

c) Option C2 - Same as Option C1 except central office blocking of 011+ calls is excluded.

GENERAL EXCHANGE TARIFF

Embarq Florida, Inc.

By: F. B. Poag  
Director

SECTION A7  
First Revised Sheet 20  
Cancelling Original Sheet 20  
Effective: January 1, 1997

COIN TELEPHONE SERVICE

C. PAY TELEPHONE SERVICE (Cont'd)

5. Optional Service Features (Cont'd)

b. Central Telephone exchanges only (Cont'd)

1) Central Office Blocking with Operator Screening (Cont'd)

- c) Option D - Outward Only Service. Provides screening information to the operator to prevent operator assisted sent-paid calls from being billed to the line.\* Provides central office blocking of 011+ calls.
- d) Option D1 - Same as Option D except 1+900 and 976 calls are also blocked.
- e) Option E - Two-Way Service. Provides central office blocking of 7-digit local, 976, 1+DDD and 1+900 calls. Provides screening to the operator to prevent operator assisted sent-paid calls from being billed to the line. Also provides C.O. blocking of 011+ calls.

GENERAL EXCHANGE TARIFF

Embarq Florida, Inc.

By: F. B. Poag  
Director

SECTION A7  
Second Revised Sheet 21  
Cancelling First Revised Sheet 21  
Effective: May 29, 1997

COIN TELEPHONE SERVICE

C. PAY TELEPHONE SERVICE (Cont'd)

5. Optional Service Features (Cont'd)

b. Central Telephone exchanges only (Cont'd)

1) Central Office Blocking with Operator Screening (Cont'd)

f) Option F - Outward Only Service. Provides central office blocking of 7 digit local, 976, 1+DDD, 1+900 and 011+ calls. Provides screening information to the operator to prevent operator assisted sent-paid calls from being billed to the line.

g) Option G - Two-way Service. Provides central office blocking of 976, 1+DDD, 1+900 calls and 011+ calls. Provides screening information to the operator to prevent operator assisted sent-paid calls from being billed to the line.

GENERAL EXCHANGE TARIFF

Embarq Florida, Inc.

By: F. B. Poag  
Director

SECTION A7  
First Revised Sheet 22  
Cancelling Original Sheet 22  
Effective: January 1, 1997

COIN TELEPHONE SERVICE

C. PAY TELEPHONE SERVICE (Cont'd)

5. Optional Service Features (Cont'd)

b. Central Telephone exchanges only (Cont'd)

1) Central Office Blocking with Operator Screening (Cont'd)

h) Option H - Outward Only Service. Provides central office blocking of 976, 1+DDD, 1+900 and 011+ calls. Provides screening information to the operator to prevent operator assisted sent-paid calls from being billed to the line.\*

\* Options D, F and H may only be provided for placement in correctional institutions, schools, hospitals and other locations for which the Public Service Commission may grant a specific exemption.

2) Billed Number Screening as provided in Section A13 of this tariff is a mandatory service feature for customer-owned pay station service.

GENERAL EXCHANGE TARIFF

Embarq Florida, Inc.

By: F. B. Poag  
Director

SECTION A7  
Second Revised Sheet 23  
Cancelling Second Sheet 23  
Effective: November 30, 2005

COIN TELEPHONE SERVICE

C. PAY TELEPHONE SERVICE (Cont'd)

5. Optional Service Features (Cont'd)

b. Central Telephone exchanges only (Cont'd)

3) Rates

	Monthly Rate
Option C	\$1.50
Option C1	1.50
Option C2	1.50
Option D	1.50
Option D1	1.50
Option E	1.50
Option F	1.50
Option G	1.50
Option H	1.50

c. Coin Signaling

1) Coin Signaling consists of Coin Collect and Coin Return functions. Coin Collect is used when a call has been completed and Coin Return is used if a no answer or a busy condition is encountered.

2) This optional feature may be purchased by the PATS provider subscribing to either B-1 option. The feature is included as a component of Coin Line Service (CLS), therefore, it is not necessary for CLS subscribers to purchase this feature separately.

3) Rates and Charges

	<u>Monthly Rate</u>
Per Line	\$ 4.50

GENERAL EXCHANGE TARIFF

Embarq Florida, Inc.

By: F. B. Poag  
Director

SECTION A7  
First Revised Sheet 23.1  
Cancelling Original Sheet 23.1  
Effective: April 15, 1997

COIN TELEPHONE SERVICE

C. PAY TELEPHONE SERVICE (Cont'd)

6. Rates and Charges

- a. Monthly rates to the provider of PATS service shall be as stated in this tariff. Appropriate service connection charges as found in Section A4 shall apply. Long distance charges are additional and will be billed at established long distance rates.
- b. The PATS provider may choose to subscribe to a flat rate option with PATS features, a flat rate option with B1 features, or a usage based option for the provision of service.

GENERAL EXCHANGE TARIFF

Embarq Florida, Inc.

By: F. B. Poag  
Director

SECTION A7  
Second Revised Sheet 24  
Cancelling First Revised Sheet 24  
Effective: October 28, 1997

COIN TELEPHONE SERVICE

C. PAY TELEPHONE SERVICE (Cont'd)

6. Rates and Charges (Cont'd)

- c. Charges to the user of the PATS service shall be determined by the PATS provider with the following exceptions:
- 1) IntraLATA and interLATA toll coin calls - a rate of \$.25 per minute, plus a \$1.00 surcharge may be applied.
  - 2) 0+ and 0- intraLATA toll non-coin calls billed directly or on behalf of the pay telephone provider - a rate of \$.25 per minute, plus the Commission authorized set use fee described following, plus a \$1.00 surcharge may be applied.
  - 3) Applicable operator services charges may be imposed on the PATS user by the PATS provider. Such charges cannot exceed the Company's charge to the PATS provider for these services.
  - 4) Charges for calls to long distance Directory Assistance (555-1212) shall be assessed to the PATS provider at rates specified in this tariff and other tariffs in which the Company concurs. The charge to the PATS user may not exceed this rate.
  - 5) Calls to 911 and where 911 is not available, the operator, are at no charge to the PATS user or the PATS provider.

GENERAL EXCHANGE TARIFF

Embarq Florida, Inc.

By: F. B. Poag  
Director

SECTION A7  
Fourth Revised Sheet 25  
Cancelling Third Revised Sheet 25  
Effective: April 16, 1998

COIN TELEPHONE SERVICE

C. PAY TELEPHONE SERVICE (Cont'd)

6. Rates and Charges (Cont'd)

c. (Cont'd)

- 6) The charge imposed by the PATS provider for local calls dialed 0+ or 0-, is not to exceed the local rate per call, plus the fixed \$.25 set use charge and applicable operator/calling card surcharges will apply.
- 7) PATS providers may impose a 15 minute time limit on sent-paid local calls originating from their pay phones. If a time limit is imposed, the PATS provider must:
  - a) Post a conspicuous notice on the pay telephone indicating that the end user will be charged an additional amount after 15 minutes or be disconnected.
  - b) Verbally notify end users at least 30 seconds prior to disconnection that the 15 minute time limit is about to expire and that they will be disconnected if they do not deposit the additional amount for 15 additional minutes.



GENERAL EXCHANGE TARIFF

Embarq Florida, Inc.

By: F. B. Poag  
Director

SECTION A7  
First Revised Sheet 26  
Cancelling Original Sheet 26  
Effective: January 1, 1997

COIN TELEPHONE SERVICE

C. PAY TELEPHONE SERVICE (Cont'd)

6. Rates and Charges (Cont'd)

d. The following monthly rates and charges are applicable to Pay Telephone Service (PATS) access lines.

1) Where usage measurement is selected:

a) A flat monthly rate element equal to 80 percent of the applicable single line business (B1) rate.

b) Measured rate, for all local calls and calls to long distance companies that can be reached by dialing a local number, first minute or fraction thereof: \$.03

Each additional 1/10 minute, or fraction thereof: \$.0015

c) An off-peak measured rate will apply for local calls placed between 12:00 noon and 2:00 p.m. weekdays; between 9:00 p.m. and 9:00 a.m. all days; and between 9:00 a.m. and 9:00 p.m. Saturdays and Sundays as follows:

First minute or fraction thereof \$.02

Each additional 1/10 minute, or fraction thereof \$.001

GENERAL EXCHANGE TARIFF

Embarq Florida, Inc.

By: F. B. Poag  
Director

SECTION A7  
First Revised Sheet 27  
Cancelling Original Sheet 27  
Effective: January 1, 1997

COIN TELEPHONE SERVICE

C. PAY TELEPHONE SERVICE (Cont'd)

6. Rates and Charges (Cont'd)

d. (Cont'd)

1) (Cont'd)

d) Calls within the local calling area are each charged at least one (1) minute of use. For local calls that exceed one (1) minute, usage charges are based on conversation time rounded up to the nearest one-tenth (1/10) minute. At the end of each billing period, the rated messages will be accumulated and the total of the message charges will be rounded down to the nearest whole cent.

e) Minimum monthly billing, per month \$30.00

2) Flat Rate, per month, per line,  
including PATS usage rates and  
PATS features Business  
Rates apply\*

3) Flat rate, per month, per line,  
including B1 rates and B-1  
features Business  
Rates apply\*

\*See Section A3 for applicable rates.

GENERAL EXCHANGE TARIFF

Embarq Florida, Inc.

By: F. B. Poag  
Director

SECTION A7  
First Revised Sheet 28  
Cancelling Original Sheet 28  
Effective: January 1, 1997

COIN TELEPHONE SERVICE

C. PAY TELEPHONE SERVICE (Cont'd)

7. Billing and Collection Service (United Telephone exchanges only)

a. General

- 1) The Company will provide billing and collection services to PATS providers for the set use fee on completed 0- and 0+ intraLATA toll calls, if the Company is the presubscribed carrier of these calls.
- 2) If the Company is the presubscribed carrier, the set use fee will be applied to completed intraLATA calls dialed as 0- or 0+ from PATS access lines. The set use charge is applicable on local calls when dialed as 0- or 0+.
- 3) The Company reserves the right to provide, upon specific request, the name, address and telephone number of the PATS provider in response to inquiries and/or questions regarding the PATS provider's services.
- 4) Service to a customer of the Company may be suspended for nonpayment of the set use fee in accordance with the regulations specified in Section A2.

GENERAL EXCHANGE TARIFF

Embarq Florida, Inc.

By: F. B. Poag  
Director

SECTION A7  
First Revised Sheet 29  
Cancelling Original Sheet 29  
Effective: January 1, 1997

COIN TELEPHONE SERVICE

C. PAY TELEPHONE SERVICE (Cont'd)

7. Billing and Collection Service (United Telephone exchanges only) (Cont'd)

b. Liability

- 1) The Company shall not be liable for any losses or damages of any kind resulting from the unavailability or failure of its equipment or facilities; or for any act, omission, or failure of performance by the Company, its employees or agents in connection with this tariff. The Company shall not be responsible for incomplete calls or calls that cannot be completed as a result of end user action, subscriber equipment and facilities, or Company equipment and facilities.

GENERAL EXCHANGE TARIFF

Embarq Florida, Inc.

By: F. B. Poag  
Director

SECTION A7  
First Revised Sheet 30  
Cancelling Original Sheet 30  
Effective: January 1, 1997

COIN TELEPHONE SERVICE

C. PAY TELEPHONE SERVICE (Cont'd)

7. Billing and Collection Service (United Telephone exchanges only) (Cont'd)

b. Liability (Cont'd)

- 2) The Company report of the number of calls completed from each PATS access line subscribing to billing and collection service shall be the sole document upon which remittance to the PATS provider will be made. The Company will not be liable for incorrect counts resulting from lost or damaged tapes or program failures nor for differing counts that may be accumulated by the PATS provider. In the event that the billing data is lost, the Company will estimate the volume of lost messages and associated set use fees based on prior billing periods. In such events, the extent of the Company's liability for damages shall be limited to the granting of a corresponding credit adjustment to the amounts due the PATS provider to account for the unbillable revenue.

c. Company Responsibility

- 1) The Company will produce a record of the number of eligible calls billed for each PATS access line subscribing to this service. The Company will bill and collect the authorized set use fee plus the applicable long distance and operator services charges.

GENERAL EXCHANGE TARIFF

Embarq Florida, Inc.

By: F. B. Poag  
Director

SECTION A7  
Second Revised Sheet 31  
Cancelling First Revised Sheet 31  
Effective: November 27, 1998

COIN TELEPHONE SERVICE

C. PAY TELEPHONE SERVICE (Cont'd)

7. Billing and Collection Service (United Telephone exchanges only) (Cont'd)

c. Company Responsibility (Cont'd)

- 2) Each month, the Company will issue a credit to the PATS provider's account, on a per line basis, for the total billed set use fees less the Company's uncollectible charges.
- 3) If the PATS access line is disconnected, any remittance amount due the PATS provider will be credited to the final billing for the service.

D. PUBLIC SET USE FEE

1. General

- a. A set use fee will be billed to and collected from end users by the Company on behalf of the Company and subscribers of the PATS pay station tariff. The fee applies to both 0 and 0+ local and/or intraLATA Company processed completed messages which originate from pay telephones. This fee is optional for 0- and 0+ intraLATA and/or interLATA calls based on negotiated arrangements between the carrier and the pay phone provider.

GENERAL EXCHANGE TARIFF

Embarq Florida, Inc.

By: F. B. Poag  
Director

SECTION A7  
Second Revised Sheet 32  
Cancelling First Revised Sheet 32  
Effective: November 27, 1998

COIN TELEPHONE SERVICE

D. PUBLIC SET USE FEE (Cont'd)

1. General (Cont'd)

- b. Billing and collection of Company processed completed messages which originate from pay telephones and to which the set use fee applies, will be provided under the conditions stated in C.7. preceding.
- c. The Company must be notified of any disputes within 30 days from the date the details were initially made available to the PATS provider.
- d. The company shall not be responsible for calls that cannot be completed as a result of repair or maintenance difficulties on Company facilities and equipment nor on equipment owned by the subscriber.
- e. In the event that the billing data is lost, the Company will estimate the volume of lost messages and associated set use fees based on prior billing periods. In such events, the extent of the Company's liability for damages shall be limited to the granting of a corresponding credit adjustment to the amounts due to the PATS Provider to account for the unbillable revenue.
- f. In the absence of willful misconduct, no liability for damages to the PATS Provider, or other entity or person other than that as set forth preceding shall be attached to the Company for its action or the conduct of its employees in providing the billing and collection of the set use fee.

GENERAL EXCHANGE TARIFF

Embarq Florida, Inc.

By: F. B. Poag  
Director

SECTION A7  
Second Revised Sheet 33  
Cancelling First Revised Sheet 33  
Effective: November 27, 1998

COIN TELEPHONE SERVICE

D. PUBLIC SET USE FEE (Cont'd)

2. Rates and Charges

a. Public Set Use Fee - Charges applied to the caller

- 1) For 0- and 0+ local and/or intraLATA Company processed completed messages which originate from pay telephones.

a) per message \$ .25

E. COIN LINE SERVICE

1. General

- a. Coin Line Service (CLS) is a standard dial tone first coin line for customer provided pay telephones (PATS). The service will be provided from central offices where facilities are available.
- b. This service is provided subject to the requirements set forth in Section A7 and A2 of this tariff.



GENERAL EXCHANGE TARIFF

Embarq Florida, Inc.

By: F. B. Poag  
Director

SECTION A7  
First Revised Sheet 34  
Cancelling Original Sheet 34  
Effective: January 1, 1997

COIN TELEPHONE SERVICE

E. COIN LINE SERVICE (Cont'd)

1. General (Cont'd)

c. Features of the service are as follows:

- 1) Service will be provided on a two-way basis, except lines placed in correctional institutions, schools, hospitals and other locations for which a specific exemption has been granted by the Public Service Commission. There will be no charge imposed for incoming calls.
- 2) Service will be provided on a dial tone first basis to enable end users to dial certain calls without requiring coin deposits, i.e., 911 Emergency Calls, local directory assistance, and non-sent paid calls.
- 3) Central office blocking of 900 and 976 calls will be provided.
- 4) Operator Call Screening will be provided to alert operator and carrier systems that the call is originating from a CLS line and may require special handling and billing treatment.
- 5) Billed Number Screening will be provided to indicate in validation data bases that incoming collect and bill-to-third number calls are not to be billed to the line.

GENERAL EXCHANGE TARIFF

Embarq Florida, Inc.

By: F. B. Poag  
Director

SECTION A7  
Third Revised Sheet 35  
Cancelling Second Revised Sheet 35  
Effective: July 17, 1998

COIN TELEPHONE SERVICE

E. COIN LINE SERVICE (Cont'd)

1. General (Cont'd)

c. (Cont'd)

- 6) Coin signaling (coin collect and coin return) will be provided by the network. Coin collect is used when a call has been completed and coin return is used if a no answer or busy condition is encountered.
- 7) Standard recorded announcements will be utilized with CLS.
- 8) The Company's operator system will handle 0-, 0+ and 1+ intraLATA toll calls carried by the Company and 0+ local calls from CLS lines. All 101XXXX 0+ dialed intraLATA toll calls will be routed to the dialed carrier.
- 9) Currently, sent paid interLATA, interstate and international calls originating from CLS lines, including but not limited to 1+, 101XXXX1+, 011+, 101XXXX011+, 950, 1+ and TFC 1+ access code calls, will be forwarded to AT&T for coin rating and completion. When other interexchange carriers provide sent paid service, 1+ presubscription intraLATA and/or interLATA calls will be permitted. Special billing/coin sharing arrangements between the CLS subscriber and their respective carriers will be the responsibility of the CLS subscriber.

GENERAL EXCHANGE TARIFF

Embarq Florida, Inc.

By: F. B. Poag  
Director

SECTION A7  
Second Revised Sheet 36  
Cancelling First Revised Sheet 36  
Effective: May 29, 1997

COIN TELEPHONE SERVICE

E. COIN LINE SERVICE (Cont'd)

1. General (Cont'd)

c. (Cont'd)

- 10) All 0+ intraLATA and/or interLATA calls will be routed to the CLS subscriber's presubscribed carrier.
- 11) The Company shall not be liable for shortages of coins collected and deposited at the subscriber's equipment. The limit of the Company's liability for end user fraud of whatever nature occurring at or in association with the subscriber's equipment shall be governed by provisions of this tariff and rule or regulation of the FPSC. In case of a conflict, the rule or regulation will prevail.
- 12) International Call Blocking (011+) is available in Section A13 of this tariff.

GENERAL EXCHANGE TARIFF

Embarq Florida, Inc.

By: F. B. Poag  
Director

SECTION A7  
Fourth Revised Sheet 37  
Cancelling Third Revised Sheet 37  
Effective: November 1, 2005

COIN TELEPHONE SERVICE

E. COIN LINE SERVICE (Cont'd)

2. Rates and Charges

a. The Coin Line Service rates will be as follows:

1) Usage rate service - monthly recurring, plus usage

- |                           |         |
|---------------------------|---------|
| a) Two way, per line      | \$37.70 |
| b) Outward only, per line | \$37.70 |

2) Calls within the local calling area are each charged for at least one minute of use. For calls that exceed one minute, usage charges are based on conversation time rounded up to the nearest one tenth minute.

3) Calls placed over message Rate Routes will be assessed normal PATS usage charges as reflected in this Section, C.6.d.1)b).c).

b. Sent paid local calls will be rated by the CLS subscriber's set.

c. Operator handled sent paid local calls will be rated to the end user at the rate set forth in this tariff section plus the appropriate operator surcharge in Section A3 of this tariff.

d. Non-sent paid local calls will be rated to the end user at the rate set forth in this tariff section plus the appropriate operator surcharge in Section A3 plus the set use fee as provided in this tariff section.

GENERAL EXCHANGE TARIFF

Embarq Florida, Inc.

By: F. B. Poag  
Director

SECTION A7  
Third Revised Sheet 38  
Cancelling Second Revised Sheet 38  
Effective: March 1, 2003

COIN TELEPHONE SERVICE

E. COIN LINE SERVICE (Cont'd)

2. Rates and Charges (Cont'd)

- e. Sent paid intraLATA long distance calls carried by the Company will be rated to the end user at the long distance rate and the appropriate operator surcharge as set forth in Section A18 of this tariff. The CLS subscriber will be charged the applicable MTS long distance rate set forth in Section A18 of this tariff.
- f. Non-sent paid intraLATA toll calls when carried by the Company will be rated to the end user at the long distance rate and the appropriate operator surcharge set forth in Section A18 of this tariff plus the set use fee as provided in this section.
- g. The CLS subscriber will be charged for long distance Directory Assistance Service at the rate specified in Section A18 of this tariff for business individual line service. The network will require a deposit be made by the end user unless charged to an alternate billing method.
- h. Service Charges as covered in Section A4 of this tariff for business individual line service are applicable.
- i. Listings in connection with CLS are furnished under the regulations specified in Section A6 of this tariff for Pay Telephone Listings.

GENERAL EXCHANGE TARIFF

Embarq Florida, Inc.

By: F. B. Poag  
Director

SECTION A7  
First Revised Sheet 39  
Cancelling Original Sheet 39  
Effective: January 1, 1997

COIN TELEPHONE SERVICE

E. COIN LINE SERVICE (Cont'd)

2. Rates and Charges (Cont'd)

- k. Suspension of service, as covered in Section A2, is not available unless the instrument is totally inaccessible to the general public on a temporary basis. In all cases, the decision to permit temporary suspension of service rests with the Company.
- l. When service is temporarily suspended at the subscriber's request, a Secondary Service Ordering Charge and a restoration charge, as specified in Section A4, will be charged for each telephone number restored.
- m. Rates for Verification and Emergency Interrupt Service as provided in Sections A3 and A18 of this tariff are applicable. The network will require a deposit be made by the end user unless charged to an alternate billing method.

GENERAL EXCHANGE TARIFF

Embarq Florida, Inc.

SECTION A8

BY: F. B. Poag  
Director

First Revised Contents Sheet 1  
Cancelling Original Contents Sheet 1  
Effective: January 1, 1997

TELEPHONE ANSWERING SERVICE FACILITIES  
(UNITED TELEPHONE Exchanges only)  
CONTENTS

A.	GENERAL .....	1
B.	INITIAL CONTRACT PERIOD .....	3
C.	RATES AND CHARGES .....	3
D.	SECRETARIAL SERVICES IN-DIALING ARRANGEMENTS .....	6
	1. General .....	6
	2. Rates and Charges .....	8

GENERAL EXCHANGE TARIFF

Embarq Florida, Inc.

BY: F. B. Poag  
Director

SECTION A8  
First Revised Sheet 1  
Cancelling Original Sheet 1  
Effective: January 1, 1997

TELEPHONE ANSWERING SERVICE FACILITIES  
(UNITED TELEPHONE Exchanges only)

A. GENERAL

1. The Telephone Company will provide facilities, as outlined herein, for customers for their use in providing telephone answering service for other telephone customers to individual line service when they are absent or do not desire to answer their calls personally.
2. Customer-owned station equipment or specially designed secretarial service switchboards may be utilized to provide facilities for terminating a number of extension lines connected to customer's individual access lines, so that an attendant may answer incoming calls to the lines of customers who contract with the secretarial service to do so, during periods when the customers leave their telephone unattended. Access line terminations are also provided in those cases where the customer contracts with the secretarial service to answer all incoming calls or where the secretarial service wishes to terminate administrative service for answering purposes only.
3. A concentrator-identifier is available for connecting a telephone answering bureau with extension lines or individual access lines of its clients located in central office districts other than that in which a secretarial switchboard is located. This arrangement is limited to central office districts within the same local calling areas as the secretarial switchboard and subject to equipment operational limitations.



GENERAL EXCHANGE TARIFF

Embarq Florida, Inc.

BY: F. B. Poag  
Director

SECTION A8  
First Revised Sheet 2  
Cancelling Original Sheet 2  
Effective: January 1, 1997

TELEPHONE ANSWERING SERVICE FACILITIES  
(UNITED TELEPHONE Exchanges only)

A. GENERAL (Cont'd)

4. Local exchange trunks may be terminated in a customer-owned secretarial switchboard for the purpose of completing local or long distance calls to and from administrative access lines furnished with and terminating on the same premises as the secretarial switchboard.
5. Wide Area Telephone Service (WATS) access lines may not be terminated in secretarial switchboards or concentrators. Extension lines on Inward WATS lines may be terminated in telephone answering equipment for the purpose of answering calls at such times as the subscriber is not available at the main access line location.
6. Foreign exchange service and secretarial lines associated therewith may be terminated in customer-provided secretarial equipment for answering purposes and may not be terminated in secretarial equipment for completing calls to and from administrative telephones or the attendant.
7. The telephone answering bureau may forward calls from secretarial lines to the general exchange network over local exchange central office lines furnished the bureau for its administrative use. However, the secretarial service facilities furnished by the Company are not designed for such call-forwarding. The answering bureau forwards calls at its own risk and the Company will not be liable for defects in transmission or other service difficulties arising out of or resulting from this type of connection.

GENERAL EXCHANGE TARIFF

Embarq Florida, Inc.

BY: F. B. Poag  
Director

SECTION A8  
First Revised Sheet 3  
Cancelling Original Sheet 3  
Effective: January 1, 1997

TELEPHONE ANSWERING SERVICE FACILITIES  
(UNITED TELEPHONE Exchanges only)

B. INITIAL CONTRACT PERIODS

Contracts for concentrator-identifier equipment are required with termination charges being applicable as indicated herein or as described under Optional Pricing Plans.

C. RATES AND CHARGES

1. Rates and charges billed to the secretarial firm for secretarial service facilities are as follows:

a. Central office trunks connected to customer-provided secretarial switchboards

- |  |                                    |
|--|------------------------------------|
| 1) Associated with switchboards<br>serving administrative stations<br>or equipped for bridging - | PBX Trunk rates<br>and charges     |
| 2) Associated with switchboards<br>not serving administrative<br>stations -                      | Business Line<br>Rates and charges |

GENERAL EXCHANGE TARIFF

Embarq Florida, Inc.

BY: F. B. Poag  
Director

SECTION A8  
First Revised Sheet 4  
Cancelling Original Sheet 4  
Effective: January 1, 1997

TELEPHONE ANSWERING SERVICE FACILITIES  
(UNITED TELEPHONE Exchanges only)

C. RATES AND CHARGES (Cont'd)

1. Rates and charges billed to the secretarial firm for secretarial service facilities are as follows:  
(Cont'd)

b. Concentrator and identifier equipment and facilities  
(Cont'd)

1) Concentrator and identifier unit with a capacity of 24 lines and 6 trunks (talk paths), each

Monthly Rate

All exchanges except  
South Division

Individual Case  
Basis

South Division

\$200.00

2) Trunks connecting concentrator and identifier units (a minimum of two required)

a) Where the units are in the same exchange, the rates set forth in Section A20, as appropriate, will apply for each trunk between the units.

b) Where the units are in different exchanges, the rates set forth in B3.4 of BellSouth's tariff will apply, as appropriate, for each trunk between the units.

GENERAL EXCHANGE TARIFF

Embarq Florida, Inc.

BY: F. B. Poag  
Director

SECTION A8  
First Revised Sheet 5  
Cancelling Original Sheet 5  
Effective: January 1, 1997

TELEPHONE ANSWERING SERVICE FACILITIES  
(UNITED TELEPHONE Exchanges only)

C. RATES AND CHARGES (Cont'd)

1. Rates and charges billed to the secretarial firm for secretarial service facilities are as follows:  
(Cont'd)
  - b. Concentrator and identifier equipment and facilities  
(Cont'd)
    - 3) Extension lines or individual access lines may be connected to the concentrator when they originate in the office in which the concentrator is located or when they originate in an office with area contiguous to that office area in which the concentrator is located.
2. Rates and charges billed to the individual access line customer for secretarial service facilities are as follows:
  - a. For extension lines associated with Centrex lines, individual access lines, or PBX trunks which are terminated on a secretarial board position or console, the rates set forth in Section A20 of this tariff, as appropriate, apply.
  - b. For direct terminations of Centrex lines, individual access lines, or private lines on a secretarial board position or console, the normal charges associated with those services, as appropriate, apply.

GENERAL EXCHANGE TARIFF

Embarq Florida, Inc.

BY: F. B. Poag  
Director

SECTION A8  
First Revised Sheet 6  
Cancelling Original Sheet 6  
Effective: January 1, 1997

TELEPHONE ANSWERING SERVICE FACILITIES  
(UNITED TELEPHONE Exchanges only)

D. SECRETARIAL SERVICE IN-DIALING ARRANGEMENTS

1. General

- a. Secretarial Service In-Dialing Arrangements provide the central office equipment (telephone numbers) necessary for in-dialing from the exchange network and inward access lines necessary to deliver the calls to customer-provided terminal equipment located at the premises of the Telephone Answering Service.
- b. Inward access lines used with the provision of In-Dialing arrangements service shall be provided at rates and charges equivalent to PBX flat-rate trunks.
- c. This service is provided on the condition that the customer subscribes to sufficient inward access lines, a minimum of two, to adequately handle the volume of calls directed to the service without interfering with or impairing any services offered by the Telephone Company.
- d. The service is furnished subject to the availability of facilities and telephone numbers. The assignment of telephone numbers and the sequence of the numbers assigned to dialing arrangements is made at the discretion of the Company. Where the customer requests additional blocks of telephone numbers to be held in reserve for future use, rates and charges as shown in A8 D.2. are applicable for each unused block of telephone numbers.

GENERAL EXCHANGE TARIFF

Embarq Florida, Inc.

BY: F. B. Poag  
Director

SECTION A8  
First Revised Sheet 7  
Cancelling Original Sheet 7  
Effective: January 1, 1997

TELEPHONE ANSWERING SERVICE FACILITIES  
(UNITED TELEPHONE Exchanges only)

D. SECRETARIAL SERVICE IN-DIALING ARRANGEMENTS (Cont'd)

1. General (Cont'd)

- e. Where facilities and telephone numbers are provided from other than the customer's normal serving central office, foreign central office mileage charges will be applicable in accordance with Section A9 of this tariff.
- f. Where it is determined that Company facilities will be connected to the customer-provided terminal equipment through a direct electrical connection, the provisions shown in Section A15 of this tariff shall apply.
- g. Customer-provided terminal equipment must provide for the intercepting of assigned, but unused, station numbers.
- h. Telephone numbers furnished herein do not include directory listings. Directory listings for clients of the Telephone Answering Service utilizing one of these numbers will be provided in accordance with the regulations of Section A6 of this tariff for Alternate (Directive) Listings. Where clients have no local exchange service but want to list one of these numbers, a monthly charge equal to the monthly rate for Additional Listings in Section A6 will be applicable.
- i. Telephone numbers furnished herein shall be used exclusively for the purpose of completing and handling incoming-only calls directed to the clients of the Telephone Answering Service.

GENERAL EXCHANGE TARIFF

Embarq Florida, Inc.

BY: F. B. Poag,  
Director

SECTION A8  
First Revised Sheet 8  
Cancelling Original Sheet 8  
Effective: January 1, 1997

TELEPHONE ANSWERING SERVICE FACILITIES  
(UNITED TELEPHONE Exchanges only)

D. SECRETARIAL SERVICE IN-DIALING ARRANGEMENTS (Cont'd)

2. Rates and Charges

In-Dialing Arrangements

- a. Per 100 numbers\*                      See DID in Section A11 for rates
- b. Inward access lines                      See flat-rate PBX Trunk rates

\* Charges apply to each 100 number group per central office regardless of the amount of numbers in use.

GENERAL EXCHANGE TARIFF

Embarq Florida, Inc.

SECTION A9

By: F. B. Poag  
Director

First Revised Contents Sheet 1  
Cancelling Original Contents Sheet 1  
Effective: January 1, 1997

FOREIGN EXCHANGE SERVICE AND FOREIGN CENTRAL OFFICE SERVICE  
CONTENTS

A.	FOREIGN EXCHANGE (FX) SERVICE	1
1.	General	1
2.	Rates and Charges (United Telephone exchanges only)	3
3.	Rates and Charges (Central Telephone exchanges only)	7
B.	FOREIGN CENTRAL OFFICE (FCO) SERVICE	8
1.	General	8
2.	Rates and Charges (United Telephone exchanges only)	9
3.	Rates and Charges (Central Telephone exchanges only)	10



GENERAL EXCHANGE TARIFF

Embarq Florida, Inc.

By: F.B. Poag  
Director

SECTION A9  
Second Revised Sheet 1  
Cancelling First Revised Sheet 1  
Effective: December 29, 1997

FOREIGN EXCHANGE SERVICE AND FOREIGN CENTRAL OFFICE SERVICE

A. FOREIGN EXCHANGE (FX) SERVICE

1. General

- a. Foreign Exchange Service is exchange service furnished to a subscriber from an exchange other than the one from which he would normally be served. This tariff applies for foreign exchange service where all facilities and serving points are located in the same LATA.
- b. Foreign Exchange Service is not in accord with the general plan of furnishing telephone service and such service is furnished only under special conditions, where warranted, by the circumstances involved, and provided facilities are available.
- c. Foreign Exchange Service is furnished subject to the same restrictions as to the use of the service by other than the subscriber and his/her representatives, as apply in connection with other classes of service.
- d. Foreign Exchange Service is offered in connection with flat-rate individual access line service, PBX trunk service and rotary line service, Centrex or Enhanced Centrex service, and ISDN.
- e. Other services or facilities used in connection with Foreign Exchange Service (except as otherwise indicated in this tariff) are furnished subject to the rates and regulations applying in the exchange from which the subscriber would normally be served.

GENERAL EXCHANGE TARIFF

Embarq Florida, Inc.

By: F. B. Poag  
Director

SECTION A9  
Second Revised Sheet 2  
Cancelling First Revised Sheet 2  
Effective: September 1, 1997

FOREIGN EXCHANGE SERVICE AND FOREIGN CENTRAL OFFICE SERVICE

A. FOREIGN EXCHANGE (FX) SERVICE (Cont'd)

1. General (Cont'd)

- f. Subscribers to Foreign Exchange Service are not required to contract for service in the exchange from which they would normally be served except as specified in paragraph A.1.i. following or where the Foreign Exchange Service is furnished from another company's exchange territory.
- g. Where the serving Foreign Exchange is a multi-office exchange, Foreign Exchange service will be provided from whichever central office would be the most economical to the Company. If a subscriber desires operation from a different central office and facilities are available, Foreign Exchange service will be provided from the desired central office and charges specified in 3.a. following will apply.
- h. Foreign Exchange service is provided as a voice grade service and is not represented as suitable for satisfactory transmission of data. The Company does not assure standard quality of transmission levels for FX extension line service when more than one station is in use simultaneously.
- i. Where nonoptional extended scope service is in effect between two exchanges, Foreign Exchange Service will not be furnished between such exchanges, unless the customer also maintains local service from the exchange from which he/she would normally be served.

GENERAL EXCHANGE TARIFF

Embarq Florida, Inc.

By: F. B. Poag  
Director

SECTION A9  
Second Revised Sheet 3  
Cancelling First Revised Sheet 3  
Effective: December 29, 1997

FOREIGN EXCHANGE SERVICE AND FOREIGN CENTRAL OFFICE SERVICE

A. FOREIGN EXCHANGE (FX) SERVICE (Cont'd)

1. General (Cont'd)

- j. Custom Calling Features and ExpressTouch Service may be provided in conjunction with Foreign Exchange Service only in central offices equipped to accommodate such combinations.
- k. High capacity digital private line service rate elements may be substituted for the closed end FX rate elements specified in paragraph A.2.f. following if the customer requests termination of the FX service over high capacity facilities. Open end FX usage charges as set forth in paragraph A.2. following will apply regardless of any substitutions with respect to the closed end FX rate elements.
- l. This service is not offered in conjunction with extended area local calling plans.
- m. Resale of this service is not permitted.

2. Rates and Charges (United Telephone exchanges only)

- a. For the open end, or dial tone end, which is located in the foreign exchange where network switching of calls occurs, the rates for Foreign Exchange Service are the usage charges below and the Service Connection charges for flat-rate individual access line service, rotary line service, flat-rate PBX trunk service, or ISDN service applicable within the serving Foreign Exchange.

GENERAL EXCHANGE TARIFF

Embarq Florida, Inc.

By: F. B. Poag  
Director

SECTION A9  
Seventh Revised Sheet 4  
Cancelling Sixth Revised Sheet 4  
Effective: May 5, 2004

FOREIGN EXCHANGE SERVICE AND FOREIGN CENTRAL OFFICE SERVICE

A. FOREIGN EXCHANGE (FX) SERVICE (Cont'd)

2. Rates and Charges (United Telephone exchanges only) (Cont'd)

- b. The outward usage charge below will apply on a customer dialed sent-paid basis for all calls originated by the customer over the Foreign Exchange Service line and terminated within the local calling area of the foreign exchange. The inward usage charge below will apply for all calls terminated to the customer's Foreign Exchange Service line.

Per outward minute of use	\$ .020
Per inward minute of use	\$ .020

- c. When two or more Foreign Exchange Service lines are arranged in the same rotary group, they will be considered one service group for purposes of determining usage charges, i.e., usage for all FX lines in the rotary group will be combined before applying the usage charges.
- d. The toll rates to access lines or PBX trunks connected for Foreign Exchange Service are the same as regularly apply to access lines and PBX trunks located in the Foreign Exchange area.

GENERAL EXCHANGE TARIFF

Embarq Florida, Inc.

By: F. B. Poag  
Director

SECTION A9  
Ninth Revised Sheet 5  
Cancelling Eighth Revised Sheet 5  
Effective: May 5, 2005

FOREIGN EXCHANGE SERVICE AND FOREIGN CENTRAL OFFICE SERVICE

A. FOREIGN EXCHANGE (FX) SERVICE (Cont'd)

2. Rates and Charges (United Telephone exchanges only) (Cont'd)

- e. For the closed end, or station end, which is located in the subscriber's exchange, the rates are set forth below. In addition, Service Order Modification Charges as specified in Section A20 of this tariff are applicable for changes, cancellations or modifications to orders associated with the closed end.

	<u>Monthly Rate</u>	<u>Nonrecurring Charge</u>	
		<u>First</u>	<u>Additional</u>
Local Channel			
Foreign Exchange Service	\$35.15	\$270.00	\$87.00
Foreign Central Office	\$25.00	\$270.00	\$87.00
	<u>Fixed Monthly Charge</u>	<u>Monthly Charge Per Mile</u>	<u>Nonrecurring Charge Per Channel</u>
Interoffice Channel	\$40.00	\$3.00	\$87.00
Bridging Equipment Charge		<u>Nonrecurring Charge</u>	<u>Monthly Rate</u>
Per local channel bridged		\$30.00	\$8.00

GENERAL EXCHANGE TARIFF

Embarq Florida, Inc.

By: F. B. Poag  
Director

SECTION A9  
First Revised Sheet 6  
Cancelling Original Sheet 6  
Effective: January 1, 1997

FOREIGN EXCHANGE SERVICE AND FOREIGN CENTRAL OFFICE SERVICE

A. FOREIGN EXCHANGE (FX) SERVICE (Cont'd)

2. Rates and Charges (United Telephone exchanges only) (Cont'd)

- g. Where the applicant for Foreign Exchange Service is so located that it would be more economical for the Company to provide the Foreign Exchange Service direct from the Foreign Exchange to the applicant's location by the extension or utilization of existing plant, and where such facilities do not cross LATA boundaries, an Interoffice Channel charge will not apply.
- h. The rates and charges quoted for Foreign Exchange service provide for the furnishing of the service where suitable facilities are available and where the construction of the necessary facilities does not involve excessive costs. When the revenue to be derived from the service is not sufficient to warrant the Company assuming the unusual cost of providing the necessary construction, or if the service life of the constructed facilities will be unusually short or unknown, the customer and/or customers will be required to pay such cost in accordance with the regulations in Section A5 of this tariff.

GENERAL EXCHANGE TARIFF

Embarq Florida, Inc.

SECTION A9

By: F. B. Poag  
Director

Third Revised Sheet 7  
Cancelling Second Revised Sheet 7  
Effective: June 4, 2005

FOREIGN EXCHANGE SERVICE AND FOREIGN CENTRAL OFFICE SERVICE

A. FOREIGN EXCHANGE (FX) SERVICE (Cont'd)

3. Rates and Charges (Central Telephone exchanges only)

- a. Foreign Exchange service is provided in accordance with the rates, rules and regulations set forth in Section A20 of this tariff for the closed end, or station end rate elements for local channels, interoffice channels and bridging equipment as described in Section A20
- b. The open end, or dial tone end, which is located in the Foreign Exchange where network switching of the call occurs will be rated at the usage charges following, unless the FX service is provided in a central office where technical constraints prohibit measurement of terminating usage, then a combination of usage and flat rate will apply. Service connection charges for flat rate individual access line service, rotary line service, or PBX trunk service are applicable.
- c. Usage charges for all calls originating and terminating within the local calling area of the foreign exchange:

1) Originating Usage, per minute of use or fraction thereof	\$ .020
2) Terminating usage, per minute of use or fraction thereof	\$ .020

GENERAL EXCHANGE TARIFF

Embarq Florida, Inc.

By: F. B. Poag  
Director

SECTION A9  
Second Revised Sheet 8  
Cancelling First Revised Sheet 8  
Effective: September 1, 1997

FOREIGN EXCHANGE SERVICE AND FOREIGN CENTRAL OFFICE SERVICE

A. FOREIGN EXCHANGE (FX) SERVICE (Cont'd)

3. Rates and Charges (Central Telephone exchanges only) (Cont'd)

- d. The total usage per line will be billed on a per minute of use basis.
- e. Toll rates which apply to access lines and trunks in the exchange area will also apply to FX Service.
- f. Where suitable facilities are not available for the provision of FX service and the revenue derived from normal rates and charges are not sufficient to warrant the Company assuming unusual costs of construction, the subscriber or subscribers will be required to pay such costs in accordance with the regulations in Section A5 of this tariff.

B. FOREIGN CENTRAL OFFICE (FCO) SERVICE

1. General

- a. Foreign Central Office Service is exchange service furnished to a subscriber in a multi office exchange from a central office other than one from which service would normally be furnished.



GENERAL EXCHANGE TARIFF

Embarq Florida, Inc.

By: F. B. Poag  
Director

SECTION A9  
First Revised Sheet 9  
Cancelling Original Sheet 9  
Effective: January 1, 1997

FOREIGN EXCHANGE SERVICE AND FOREIGN CENTRAL OFFICE SERVICE

B. FOREIGN CENTRAL OFFICE (FCO) SERVICE (Cont'd)

1. General (Cont'd)

- b. Foreign Central Office Service is offered in connection with flat-rate individual access line service, private branch exchange service, and rotary line service.
- c. Foreign Central Office Service is not in accord with the general plan of furnishing telephone service and such service is furnished only under special conditions where warranted by the circumstances involved and provided facilities are available.
- d. Other services or facilities used in connection with Foreign Central Office Service except as otherwise indicated in this tariff, are furnished subject to the rates and regulations applying in the Foreign Central Office from which the subscriber is served.

2. Rates and Charges (United Telephone exchanges only)

- a. For the open end, or dial tone end, which is located in the foreign central office where network switching of calls occurs, the rate for FCO Service is the monthly rate and Service Connection charges for flat-rate, individual access line service, rotary line service, or flat-rate PBX trunk service applicable within the exchange.
- b. For the closed end, or station end, the rates set forth in paragraph A.2.f. preceding (for closed end FX) apply.

GENERAL EXCHANGE TARIFF

Embarq Florida, Inc.

By: F. B. Poag  
Director

SECTION A9  
Eighth Revised Sheet 10  
Cancelling Seventh Revised Sheet 10  
Effective: May 5, 2005

FOREIGN EXCHANGE SERVICE AND FOREIGN CENTRAL OFFICE SERVICE

B. FOREIGN CENTRAL OFFICE (FCO) SERVICE (Cont'd)

3. Rates and Charges (Central Telephone exchanges only)

- a. The rate for foreign central office service is the monthly rate for the class of service desired plus an interoffice channel, an interoffice nonrecurring charge and interoffice mileage charges per mile rates at the rates shown below:

	<u>Fixed Monthly Charge</u>	<u>Monthly Charge Per Mile</u>	<u>Nonrecurring Charge</u>
Interoffice Channel	\$40.00	\$3.00	\$87.00

GENERAL EXCHANGE TARIFF

Embarq Florida, Inc.

By: F. B. Poag  
Director

SECTION A10  
Sixth Revised Contents Sheet 1  
Cancelling Fifth Revised Contents Sheet 1  
Effective: December 2, 2005

N11 SERVICES  
CONTENTS

A.	E911 EMERGENCY REPORTING SERVICES.....	1
	1. UNITED TELEPHONE EXCHANGES .....	1
	2. CENTRAL TELEPHONE EXCHANGES .....	21
	3. WIRELESS E911 PHASE 2 .....	69.1
	4. PRIVATE SWITCH DATABASE SERVICE .....	69.6
	5. REVERSE NOTIFICATION TELEPHONE NUMBER DATABASE SERVICE .....	69.9
B.	711 SERVICE FOR TELECOMMUNICATIONS RELAY SERVICES (TRS) .....	70
C.	211 SERVICE FOR COMMUNITY INFORMATION AND REFERRAL SERVICES .....	76

GENERAL EXCHANGE TARIFF

Embarq Florida, Inc.

By: F. B. Poag  
Director

SECTION A10  
Second Revised Contents Sheet 2  
Cancelling First Revised Contents Sheet 2  
Effective: December 2, 2005

N11 SERVICES  
CONTENTS

E. 311 NON-EMERGENCY SERVICE ..... 89

GENERAL EXCHANGE TARIFF

Embarq Florida, Inc.

By: F. B. Poag  
Director

SECTION A10  
Second Revised Sheet 1  
Cancelling First Revised Sheet 1  
Effective: July 14, 2001

N11 SERVICES

A. E911 EMERGENCY REPORTING SERVICES

1. UNITED TELEPHONE EXCHANGES

NOTE: See Limited Availability Svc. Offerings, Sec. A2, Para. J.

a. General

- 1) Enhanced Universal Emergency Number Service, also referred to as Enhanced 911 or E911, is a telephone exchange communication service whereby a Public Safety Answering Point (PSAP) designated by the customer may receive telephone calls dialed to the telephone number 911. E911 Service includes lines and equipment necessary for the answering, transferring, and dispatching of public emergency telephone calls originated by persons within the serving area who dial 911.
- 2) Enhanced 911 Service is offered subject to availability of facilities.
- 3) The E911 customer may be a municipality or other state or local governmental unit, or an authorized agent of one or more municipalities or other state or local government units to whom authority has been lawfully delegated. The customer must be legally authorized to subscribe to the service and have public safety responsibility by law to respond to telephone calls from the public for emergency police, fire or other emergency services within the telephone central office areas arranged for 911 calling.

GENERAL EXCHANGE TARIFF

Embarq Florida, Inc.

By: F. B. Poag  
Director

SECTION A10  
Second Revised Sheet 2  
Cancelling First Revised Sheet 2  
Effective: July 14, 2001

N11 SERVICES

A. E911 EMERGENCY REPORTING SERVICES (Cont'd)

1. UNITED TELEPHONE EXCHANGES (Cont'd)

b. Explanation of Terms

- 1) ALTERNATE ROUTING (AR) - A feature provided to allow E911 calls to be routed to a designated alternate location if, (1) all E911 exchange lines to the primary PSAP (see definition below) are busy, or (2) the primary PSAP closes down for a period (night service). This is a standard feature of E911 Service.
- 2) AUTOMATIC LOCATION IDENTIFICATION (ALI) - A feature by which the address associated with the calling party's telephone number (identified by ANI as designated below) is forwarded to the PSAP for display.
- 3) AUTOMATIC NUMBER IDENTIFICATION (ANI)- A feature by which the calling party's ANI telephone number is forwarded to the E911 Control Office and to the PSAP's ANI/ALI Display Transfer Units.

GENERAL EXCHANGE TARIFF

Embarq Florida, Inc.

By: F. B. Poag  
Director

SECTION A10  
Second Revised Sheet 3  
Cancelling First Revised Sheet 3  
Effective: July 14, 2001

N11 SERVICES

A. E911 EMERGENCY REPORTING SERVICES (Cont'd)

1. UNITED TELEPHONE EXCHANGES (Cont'd)

b. Explanation of Terms (Cont'd)

- 4) DATA MANAGEMENT SYSTEM (DMS) - A system of manual procedures and computer programs used to create, store, and update the data required to provide the Selective Routing (SR) and ALI features.
- 5) DEFAULT ROUTING (DR)- A feature activated when an incoming E911 call cannot be selectively routed due to an ANI feature, garbled digits, or other causes. Such incoming calls are routed from the E911 Control Office to a default PSAP. Each incoming E911 facility group to the Control Office is assigned to a designated default PSAP. This is a standard feature of E911 Service.
- 6) ANI/ALI DISPLAY TRANSFER UNIT - A console and associated common equipment for displaying ANI and/or ALI at the PSAP attendant position and used by the attendant to activate Fixed and/or Selective Transfer functions.
- 7) END OFFICE - The central office(s) in the E911 System which receive originating E911 calls.
- 8) ENHANCED 911 (E911) CONTROL OFFICE - The office providing tandem switching capability for E911 calls. It controls switching of ANI information to the PSAP and also provides the SR feature, standard ESS Speed Calling features, call transfer capability, and certain maintenance functions for each PSAP.

GENERAL EXCHANGE TARIFF

Embarq Florida, Inc.

By: F. B. Poag  
Director

SECTION A10  
Second Revised Sheet 4  
Cancelling First Revised Sheet 4  
Effective: July 14, 2001

N11 SERVICES

A. E911 EMERGENCY REPORTING SERVICES (Cont'd)

1. UNITED TELEPHONE EXCHANGES (Cont'd)

b. Explanation of Terms (Cont'd)

- 9) ENHANCED 911 SERVICE AREA - The geographic area in which the customer will respond to all E911 calls and dispatch appropriate emergency assistance.
- 10) FIXED TRANSFER - A feature which enables a PSAP attendant to transfer incoming E911 calls to secondary PSAPs by use of a single button on the ANI/ALI Display Transfer Unit.
- 11) FORCED DISCONNECT - A function of the E911 central office trunk circuit which enables the PSAP attendant to release a connection even though the calling party has not hung up. This feature prevents the jamming of the E911 exchange lines and is a standard feature of E911 Service.
- 12) IDLE TONE APPLICATION - A feature which allows the PSAP attendant to distinguish between calls that have been abandoned before they are answered and calls where the calling party is unable to speak for some reason. If the caller abandoned the line before the PSAP attendant answered, a distinct tone is heard by the attendant. If the caller is still on the line but unable to speak, no tone will be heard. This is a standard feature of E911 Service.



GENERAL EXCHANGE TARIFF

Embarq Florida, Inc.

By: F. B. Poag  
Director

SECTION A10  
Second Revised Sheet 5  
Cancelling First Revised Sheet 5  
Effective: July 14, 2001

N11 SERVICES

A. E911 EMERGENCY REPORTING SERVICES (Cont'd)

1. UNITED TELEPHONE EXCHANGES (Cont'd)

b. Explanation of Terms (Cont'd)

- 13) MANUAL TRANSFER - A feature that enables the PSAP attendant to transfer an incoming call by depressing the switch hook of the associated telephone or the "add" button on the ANI/ALI Display Transfer Unit and dialing either a 7-digit or 10-digit telephone number or a 2-digit Speed Calling Code. Manual Transfer is associated with the E911 trunk unit and is a standard feature of E911 Service.
- 14) PUBLIC SAFETY ANSWERING POINT (PSAP) - An answering location for E911 calls originating in a given area. A PSAP may be designated as Primary or Secondary, which refers to the order in which calls are directed for answering. Primary PSAPs respond first; secondary PSAPs receive calls on a transfer basis only. PSAPs are public service agencies such as police, fire, or emergency medical or a common bureau serving a group of such entities.
- 15) SELECTIVE ROUTING (SR) - A feature that routes an E911 call from a central office to the designated primary PSAP based upon the identified number of the calling party.
- 16) SELECTIVE TRANSFER - A feature providing persons at the PSAP the ability to transfer an incoming call to another agency by depressing a single button labeled with the type of agency, e.g., "Fire", on the ANI/ALI Display Transfer Unit. This type of transfer is only available when the SR feature is provided.

GENERAL EXCHANGE TARIFF

Embarq Florida, Inc.

By: F. B. Poag  
Director

SECTION A10  
Second Revised Sheet 6  
Cancelling First Revised Sheet 6  
Effective: July 14, 2001

N11 SERVICES

A. E911 EMERGENCY REPORTING SERVICES (Cont'd)

1. UNITED TELEPHONE EXCHANGES (Cont'd)

b. Explanation of Terms (Cont'd)

- 17) SERVICE CENTRAL OFFICE - The central office from which a PSAP, either primary or secondary, is served.
- 18) UNIVERSAL EMERGENCY NUMBER SERVICE - An exchange communication service for receiving telephone calls placed by persons in need of assistance who dial the number 911. Such calls are answered at PSAPs established and operated by the customer. The lines and equipment associated with the service arrangement for the answering, transferring, and dispatching of public emergency telephone calls are included.
- 19) UNIVERSAL EMERGENCY NUMBER SERVICE CUSTOMER - A municipality or other state or local government unit or an authorized agent of one or more municipalities or other state or local governmental units to whom authority has been lawfully delegated within a defined geographic area to respond to public emergency telephone calls, at the minimum for police and fire service.

c. Rules and Regulations

- 1) This service is limited to the use of central office telephone number 911 as the universal emergency telephone number. Only one E911 service will be provided within any government agency's locality.

GENERAL EXCHANGE TARIFF

Embarq Florida, Inc.

By: F. B. Poag  
Director

SECTION A10  
Third Revised Sheet 7  
Cancelling Second Revised Sheet 7  
Effective: July 14, 2001

N11 SERVICES

A. E911 EMERGENCY REPORTING SERVICES (Cont'd)

1. UNITED TELEPHONE EXCHANGES (Cont'd)

c. Rules and Regulations (Cont'd)

- 2) The 911 emergency telephone number is not intended as a total replacement for the telephone service of the various public safety agencies which participate in the use of this number. The public safety agencies will subscribe to other exchange telephone service as provided in other sections of this tariff.
- 3) The service is furnished to the customer only for the purpose of receiving reports of emergencies by the public. Residential customers whose telephone services have been temporarily denied for non-payment will continue to have access to 911 Service (outgoing service only). Service will be provided on a "where available" basis.
- 4) E911 Service is classified as Business Exchange Service and is arranged for 1-way incoming service to the appropriate PSAP. Outgoing calls can only be made on a transfer basis.
- 5) E911 Service is provided solely for the benefit of the customer operating the PSAP. The provision of E911 Service by the Company shall not be interpreted, constructed, or regarded, either expressly or implied, as being for the benefit of or creating any Company obligation toward any third person or legal entity other than the customer.
- 6) The Company does not undertake to answer and forward 911 calls, but furnishes the use of its facilities to enable the customer's personnel to respond to such calls on the customer's premises.
- 7) Terminal equipment as offered in this section of the tariff may be provided by the Company for use with this service.

GENERAL EXCHANGE TARIFF

Embarq Florida, Inc.

By: F. B. Poag  
Director

SECTION A10  
Third Revised Sheet 8  
Cancelling Second Revised Sheet 8  
Effective: July 14, 2001

N11 SERVICES

A. E911 EMERGENCY REPORTING SERVICES (Cont'd)

1. UNITED TELEPHONE EXCHANGES (Cont'd)

c. Rules and Regulations (Cont'd)

- 8) Temporary suspension of service is not provided for any part of the E911 Service.
- 9) E911 information consisting of the name, address, and telephone number of telephone customers whose listings are not published in directories or listed in Directory Assistance Offices is confidential. Information will be provided on a call-by-call basis only for the purpose of responding to emergency calls.
- 10) The E911 calling party forfeits the privacy afforded by nonlisted and nonpublished service to the extent that the telephone number, address, and name associated with the originating station location are furnished to the PSAP.
- 11) Central offices that are not currently equipped to transmit ANI will not be modified to provide ANI just for E911 Service. When the Selective Routing feature is provided, in such circumstances, Default Routing and central office identification will be provided in lieu of Selective Routing and ANI Display.
- 12) The Company's entire liability to any person for interruption or failure of E911 Service shall be limited to the terms set forth in this section and other sections of this tariff. The Company shall not be liable to any person or entity for any damages whatsoever resulting from or in connection with the provision of access to E-911 Service during the temporary denial of a residential subscriber service for non-payment.

GENERAL EXCHANGE TARIFF

Embarq Florida, Inc.

By: F. B. Poag  
Director

SECTION A10  
Second Revised Sheet 9  
Cancelling First Revised Sheet 9  
Effective: July 14, 2001

N11 SERVICES

A. E911 EMERGENCY REPORTING SERVICES (Cont'd)

1. UNITED TELEPHONE EXCHANGES (Cont'd)

c. Rules and Regulations (Cont'd)

- 13) The rates charged for E911 Service do not contemplate the inspection or constant monitoring of facilities to discover errors, defects, and malfunctions in the service, nor does the Company undertake such responsibility. The customer shall make such operational tests as, in the judgment of the customer, are required to determine whether the system is functioning properly for its use. The customer shall promptly notify the Company in the event the system is not functioning properly.
- 14) The Company's liability for any loss or damage arising from errors, interruptions, defects, failures, or malfunctions of this service or any part thereof, whether caused by the negligence of the Company or otherwise, shall not exceed the greater of \$50.00 or an amount equivalent to the pro rata charge for the service affected during the period of time that the service was fully or partially inoperative. These limited damages shall be in addition to any credit which may be given for an out-of-service condition.
- 15) Each customer agrees to release, indemnify, defend, and hold harmless the Company from any and all loss, claims, demands, suits, or other action, or any liability whatsoever, whether suffered, made, instituted or asserted by the customer or by any other party or person, for any personal injury to or death of any person or persons, or for any loss, damage or destruction of any property, whether owned by the customer or others.

GENERAL EXCHANGE TARIFF

Embarq Florida, Inc.

By: F. B. Poag  
Director

SECTION A10  
Second Revised Sheet 10  
Cancelling First Revised Sheet 10  
Effective: July 14, 2001

N11 SERVICES

A. E911 EMERGENCY REPORTING SERVICES (Cont'd)

1. UNITED TELEPHONE EXCHANGES (Cont'd)

c. Rules and Regulations (Cont'd)

- 16) The customer also agrees to release, indemnify, and hold harmless the Company for any infringement or invasion of the right of privacy of any person or persons, caused or claimed to have been caused, directly or indirectly, by the installation, operation, failure to operate, maintenance, removal, presence, conditions, occasion or use of E911 service features and the equipment associated therewith, or by any services furnished by the Company in connection therewith, including, but not limited to, the identification of the telephone number, address, or name associated with the telephone used by the party or parties accessing 911 Service hereunder, and which arise out of the negligence or other wrongful act of the Company, the customer, its user, agencies or municipalities, or the employees or agents of any one of them.
- 17) The Company's intent will be to provide at least the same level of service reliability and quality as the telephone service being provided in the exchanges where E911 is offered.
- 18) Because the Company serving boundaries and political subdivision boundaries may not coincide, it is the obligation of the customer to make arrangements to handle all E911 calls that originate from telephones served by central offices in the local service area whether or not the calling telephone is situated on property within the geographical boundaries of the customer's public safety jurisdiction.

GENERAL EXCHANGE TARIFF

Embarq Florida, Inc.

By: F. B. Poag  
Director

SECTION A10  
Second Revised Sheet 11  
Cancelling First Revised Sheet 11  
Effective: July 14, 2001

N11 SERVICES

A. E911 EMERGENCY REPORTING SERVICES (Cont'd)

1. UNITED TELEPHONE EXCHANGES (Cont'd)

c. Rules and Regulations (Cont'd)

- 19) Application for E911 Service must be executed in writing by each customer. If application for service is made by an agent, the Company must be provided in writing with satisfactory proof of appointment of the agent by the customer.
- 20) The customer must furnish the Company its agreement to the following terms and conditions:
  - a) That all E911 calls will be answered on a 24 hour day, 7 day week basis.
  - b) That the customer has responsibility for dispatching the appropriate emergency service vehicles within the E911 service area, or will undertake to transfer all E911 calls received to the governmental agency with responsibility for dispatching such services, to the extent that such services are reasonably available.
  - c) That the customer will develop an appropriate method for responding to calls for nonparticipating agencies which may be directed to the E911 PSAP by calling parties.
  - d) That the customer will subscribe to local exchange service at the PSAP location for administrative purposes, for placing outgoing calls, and for receiving other calls.

GENERAL EXCHANGE TARIFF

Embarq Florida, Inc.

By: F. B. Poag  
Director

SECTION A10  
Second Revised Sheet 12  
Cancelling First Revised Sheet 12  
Effective: July 14, 2001

N11 SERVICES

A. E911 EMERGENCY REPORTING SERVICES (Cont'd)

1. UNITED TELEPHONE EXCHANGES (Cont'd)

c. Rules and Regulations (Cont'd)

20) The customer must furnish the Company its agreement to the following terms and conditions: (Cont'd)

e) That the customer will subscribe to, or provide, telephone equipment with a capacity adequate to handle the number of incoming E911 lines recommended by the Company to be installed.

21) When the Selective Routing feature is provided, the customer is responsible for identifying primary and secondary PSAP locations as well as the unique combinations of police, fire, and ambulance or any other appropriate agencies responsible for providing emergency service in the E911 serving area. An Emergency Service Number (ESN) will be provided for each unique combination by the Company. The customer will associate these ESNs with street address ranges or other mutually agreed upon routing criteria in the E911 serving area. These ESNs will be carried in the Data Management System (DMS) to permit routing of 911 calls to the primary and secondary PSAPs responsible for handling of calls from each telephone in the E911 serving area. The following terms define the customer's responsibility in providing this information.

a) Initial and subsequent ESN assignments by street name, address range, and area or other mutually agreed upon routing criteria shall be furnished by the customer to the Company prior to the effective date of service.



GENERAL EXCHANGE TARIFF

Embarq Florida, Inc.

By: F. B. Poag  
Director

SECTION A10  
Second Revised Sheet 13  
Cancelling First Revised Sheet 13  
Effective: July 14, 2001

N11 SERVICES

A. E911 EMERGENCY REPORTING SERVICES (Cont'd)

1. UNITED TELEPHONE EXCHANGES (Cont'd)

c. Rules and Regulations (Cont'd)

21) (Cont'd)

- b) After establishment of service, it is the customer's responsibility to continue to verify the accuracy of the routing information contained in the master address file, and to advise the Company of any changes in street names, establishment of new streets, changes in address numbers used on existing streets, closing and abandonment of streets, changes in police, fire, ambulance, or other appropriate agencies' jurisdiction over any address, annexations, and other changes in municipal and county boundaries, incorporation of new cities or any other matter that will affect the routing of E911 calls to the proper PSAP.
- c) The Company will provide to the customer on request a complete written copy of the master address file to permit the customer to verify the accuracy of the police, fire and ambulance PSAP routing designations.
- d) Changes, deletions, and additions which the customer desires to have made in the master address file should be submitted on an "as occurred" basis.
- e) The Company will furnish a written copy to the customer for verification showing each change, deletion, and addition to the master address file.

GENERAL EXCHANGE TARIFF

Embarq Florida, Inc.

By: F. B. Poag  
Director

SECTION A10  
Second Revised Sheet 14  
Cancelling First Revised Sheet 14  
Effective: July 14, 2001

N11 SERVICES

A. E911 EMERGENCY REPORTING SERVICES (Cont'd)

1. UNITED TELEPHONE EXCHANGES (Cont'd)

c. Rules and Regulations (Cont'd)

21) (Cont'd)

f) The Company will bill "911" local option fees in accordance with Chapter 365, Florida Statutes, as amended. Each customer imposing a "911" local option fee agrees to release, indemnify, defend and hold harmless the Company from any and all loss, claims, demands, suits or other action, or any liability whatsoever, whether suffered, made, instituted or asserted by the customer or by any other party or person, arising out of the Company's good faith compliance with the instructions of the customer concerning the imposition, billing, collection or remittance of the "911" fee, whether or not the act of complying with the customer's instructions is deemed to be negligent.

d. Service Features

1) E911 Service is available in five service feature offerings:

- a) Automatic Number Identification
- b) Selective Routing
- c) Automatic Number Identification and Selective Routing
- d) Automatic Number Identification and Automatic Location Identification
- e) Automatic Number Identification, Automatic Location Identification, and Selective Routing

2) The following standard features are included with each of the service offerings:

- a) Forced Disconnect
- b) Idle Tone Application
- c) Default Routing
- d) Alternate Routing (Night Service)
- e) Speed Calling
- f) Central Office Transfer Arrangements

GENERAL EXCHANGE TARIFF

Embarq Florida, Inc.

By: F. B. Poag  
Director

SECTION A10  
Second Revised Sheet 15  
Cancelling First Revised Sheet 15  
Effective: July 14, 2001

N11 SERVICES

A. E911 EMERGENCY REPORTING SERVICES (Cont'd)

1. UNITED TELEPHONE EXCHANGES (Cont'd)

d. Service Features (Cont'd)

3) PSAP equipment deemed essential to the operation of E911 service may be provided by the customer or by the Company under the terms and rates as specified in this section of the tariff. If provided by the Company, such equipment is offered to Public Service Agencies responsible for the provision of E911 service only and includes the ANI/ALI Display Transfer equipment. This Display Transfer equipment consists of a microprocessor controller, stored program system capable of serving up to 64 incoming lines and 16 Display and Transfer units with a combination of 16 total parts for printers.

e. Rates for PSAP Equipment

This equipment is provided subject to an initial contract period of three or five years or a one-time payment as selected by the customer. Termination charges, as prescribed elsewhere in this tariff, are applicable in the event termination occurs prior to expiration of the initial contract.

	<u>Tier A</u>		<u>Tier B</u>
	<u>1 Mo.</u>	<u>36 Mo.</u>	<u>60 Mo.</u>

1) Positron PSAP Equipment

a) Basic Positron PSAP System - Provides the capacity for 16 trunks, 16 positions. Basic configuration is equipped for 2 trunks, 4 positions and 1 display module.

\$48,174.60	\$1,742.85	\$1,228.75	\$582.25
-------------	------------	------------	----------

GENERAL EXCHANGE TARIFF

Embarq Florida, Inc.

By: F. B. Poag  
Director

SECTION A10  
Second Revised Sheet 16  
Cancelling First Revised Sheet 16  
Effective: July 14, 2001

N11 SERVICES

A. E911 EMERGENCY REPORTING SERVICES (Cont'd)

1. UNITED TELEPHONE EXCHANGES (Cont'd)

e. Rates for PSAP Equipment (Cont'd)

1) Positron PSAP Equipment (Cont'd)

	<u>Tier A</u>			<u>Tier B</u>
	<u>1 Mo.</u>	<u>36 Mo.</u>	<u>60 Mo.</u>	
b) Trunk Card - contains 2 identical trunk circuits, each providing CO trunk control, terminal equipment control, identification of answering position, recorder control and audio output.	\$1,488.45	\$ 53.40	\$ 37.50	\$ 17.60
c) Positron Intelligent Display Module (IDM) - Provides instant display of associated ANI/ALI data when a call is answered. IDM is available in either desktop or panel-mount version.	\$2,140.05	\$ 77.00	\$ 54.15	\$ 25.50
d) Serial Input/Output Interface - Provides serial outputs for connection to outside equipment. Each SIO card features four ports that can be individually set for transmission at 300, 1200, 2400 or 9600 baud rates. Ports can be set to support either RC 232C (DCE or DTE) or RS 422 standards.	\$1,999.75	\$ 42.95	\$ 30.15	\$ 14.10

GENERAL EXCHANGE TARIFF

Embarq Florida, Inc.

By: F. B. Poag  
Director

SECTION A10  
Second Revised Sheet 17  
Cancelling First Revised Sheet 17  
Effective: July 14, 2001

N11 SERVICES

A. E911 EMERGENCY REPORTING SERVICES (Cont'd)

1. UNITED TELEPHONE EXCHANGES (Cont'd)

e. Rates for PSAP Equipment (Cont'd)

1) Positron PSAP Equipment (Cont'd)

	Tier A			Tier B
	<u>1 Mo.</u>	<u>36 Mo.</u>	<u>60 Mo.</u>	
e) MF Receiver - Decodes multi-frequency tones received from an incoming E-911 call.	\$ 977.05	\$ 34.90	\$ 24.45	\$ 11.40
f) Trunk Motherboard - Provides wired-for capacity for trunks 17-64 in increments of 16 trunks per unit.	\$2,055.55	\$ 73.95	\$ 52.00	\$ 24.45
g) Trunk Shelf - Provides capacity for trunks 33-64.	\$ 785.35	\$ 27.95	\$ 19.55	\$ 9.05
h) Control Input/Output Card - Provides 4 16-bit parallel parts. Two are used by the CPU and 2 are used to output commands to the DAL TOM card and receive MF tones and power status from it.	\$ 828.60	\$ 29.50	\$ 20.65	\$ 9.60

GENERAL EXCHANGE TARIFF

Embarq Florida, Inc.

By: F. B. Poag  
Director

SECTION A10  
Second Revised Sheet 18  
Cancelling First Revised Sheet 18  
Effective: July 14, 2001

N11 SERVICES

A. E911 EMERGENCY REPORTING SERVICES (Cont'd)

1. UNITED TELEPHONE EXCHANGES (Cont'd)

e. Rates for PSAP Equipment (Cont'd)

1) Positron PSAP Equipment (Cont'd)

	<u>Tier A</u>			<u>Tier B</u>
	<u>1 Mo.</u>	<u>36 Mo.</u>	<u>60 Mo.</u>	
i) Transfer Matrix - Allows access for 4 PSAP trunks to 8 (half) or 16 (full) transfer lines.				
half	\$ 2,994.55	\$107.95	\$ 76.00	\$ 35.85
full	\$ 3,525.75	\$127.20	\$ 89.55	\$ 42.30

2) Equipment Moves or Changes

- a) Moves or changes involving equipment at PSAP locations will be based upon costs, not to exceed nonrecurring charges specified elsewhere in this tariff.
- b) Charges for customer requests that necessitate additions, removals, moves, or changes of access facilities and/or equipment on Company premises will be based upon costs per request.
- c) Installation of additional facilities to maintain a satisfactory grade-of-service such as described in Section A10.A.1.c.17 of this tariff will be provided by the Company at no additional charge to the customer.

GENERAL EXCHANGE TARIFF

Embarq Florida, Inc.

By: F. B. Poag  
Director

SECTION A10  
Second Revised Sheet 19  
Cancelling First Revised Sheet 19  
Effective: July 14, 2001

N11 SERVICES

A. E911 EMERGENCY REPORTING SERVICES (Cont'd)

1. UNITED TELEPHONE EXCHANGES (Cont'd)

f. All Counties

1) General

Enhanced Universal Emergency Number Service (E911) will be provided within the established boundaries of requesting counties subject to the rules, regulations and definitions specified in this section of the tariff.

2) Rates

The following rates are applicable for county-wide E911 Service.

a) Including Automatic Number Identification, Automatic Location Identification and Selective Routing

<u>Service Establishment Charge</u>	<u>Nonrecurring Charge</u>	<u>Monthly Rate</u>
\$1,270/M	\$730/M	\$120/M

b) Including Automatic Number Identification, and Automatic Location Identification

<u>Service Establishment Charge</u>	<u>Nonrecurring Charge</u>	<u>Monthly Rate</u>
\$1,270/M	\$730/M	\$ 93/M

GENERAL EXCHANGE TARIFF

Embarq Florida, Inc.

By: F. B. Poag  
Director

SECTION A10  
Second Revised Sheet 20  
Cancelling First Revised Sheet 20  
Effective: July 14, 2001

N11 SERVICES

A. E911 EMERGENCY REPORTING SERVICES (Cont'd)

1. UNITED TELEPHONE EXCHANGES (Cont'd)

f. All Counties (Cont'd)

2) Rates (Cont'd)

- c) When the Selective Routing feature is selected by the county, a testing charge of \$27 per thousand access lines and PBX trunks per month is applicable for each month of pre turn-up system testing requested by the county.
- d) Each county's Nonrecurring and Service Establishment charges are calculated at the time E911 Service is established and are based on the number of access lines and PBX trunks, per thousand, in service in the respective county. The Nonrecurring charge is applied also annually thereafter per thousand access lines and trunks added during the year.
- e) Each county's Monthly Charge is applied based on the number of access lines and PBX trunks, per thousand, that have access to that county's E911 Service. The total billed amount is subject to annual adjustment to reflect changes in the number of access lines served.
- f) The Monthly Rate provides normal maintenance 7 days a week including holidays provided trouble is reported between hours of 8 a.m. and 12 midnight. Trouble reported outside this time period will be cleared and billed on a per occasion per hour rate.
- g) Appropriate rates in this tariff and other tariffs in which the Company concurs are applicable in addition to the rates shown in A10.A.1.f.2 of this tariff.



GENERAL EXCHANGE TARIFF

Embarq Florida, Inc.

By: F. B. Poag  
Director

SECTION A10  
Second Revised Sheet 21  
Cancelling First Revised Sheet 21  
Effective: July 14, 2001

N11 SERVICES

A. E911 EMERGENCY REPORTING SERVICES (Cont'd)

2. CENTRAL TELEPHONE EXCHANGES

a. General

- 1) When requested by local government authorities, and subject to the availability of facilities, the Company will provide a universal emergency number 911 for use of Public Safety Answering Points (PSAPs) engaged in assisting local governments in the protection and safety of the general public.
- 2) Two types of services are offered, basic 911 and Enhanced 911 (E911) service. Selection of the appropriate service to serve various customers will be made jointly by the Company and the customer and will be based on a thorough analysis of customer needs at each location and on the availability of facilities in each area.
- 3) Rates and charges for basic 911 and E911 service are based on the costs for a municipal or county wide system. Because of the unique requirements of each system, the system will be tarified specifically for each municipality or county.
- 4) Terminal equipment will be provided by the Company for 911 service. Where not specifically itemized in this tariff, said equipment, including moves, rearrangements or changes, will be provided at rates and charges based upon costs.

GENERAL EXCHANGE TARIFF

Embarq Florida, Inc.

By: F. B. Poag  
Director

SECTION A10  
Second Revised Sheet 22  
Cancelling First Revised Sheet 22  
Effective: July 14, 2001

N11 SERVICES

A. E911 EMERGENCY REPORTING SERVICES (Cont'd)

2. CENTRAL TELEPHONE EXCHANGES (Cont'd)

b. Explanation of Terms

- 1) ALTERNATE ROUTING (AR) - A feature provided to allow E911 calls to be routed to a designated alternate location if (1) all E911 exchange lines to the primary PSAP are busy, or (2) the primary PSAP closes down for a period (night service). This is a standard feature of E911 service.
- 2) ATTENDANT CONSOLE - A selector console and associated common equipment for displaying ANI numbers at the PSAP attendant position and used by the attendant to activate Fixed and/or Selective Transfer functions.
- 3) AUTOMATIC LOCATION IDENTIFICATION (ALI) - A feature by which the name and address associated with the calling party's telephone number (identified by ANI as defined below) is forwarded to the PSAP for display. Telephones associated with a calling party's telephone number but which are physically located elsewhere (off premises extensions, secondary locations, etc.) will also be identified with the same address associated with the calling party's telephone number at the primary location. No ALI data is provided when a call is sent to Default Routing (DR).
- 4) AUTOMATIC NUMBER IDENTIFICATION (ANI) - A feature by which the calling party's telephone number is forwarded to the E911 Control Office and to the PSAP's display.

GENERAL EXCHANGE TARIFF

Embarq Florida, Inc.

By: F. B. Poag  
Director

SECTION A10  
Second Revised Sheet 23  
Cancelling First Revised Sheet 23  
Effective: July 14, 2001

N11 SERVICES

A. E911 EMERGENCY REPORTING SERVICES (Cont'd)

2. CENTRAL TELEPHONE EXCHANGES (Cont'd)

b. Explanation of Terms (Cont'd)

- 5) DEFAULT ROUTING (DR)- A feature activated when an incoming E911 call cannot be selectively routed due to an ANI failure, garbled digits or other causes. Such incoming calls are routed from the E911 Control Office to a default PSAP. Each incoming E911 facility group to the Control Office is assigned to a designated default PSAP. This is a standard feature of E911 service. No ANI/ALI data is provided when a call is sent to Default Routing.
- 6) END OFFICE - The Central Office(s) in the E911 system from which E911 calls are originated.
- 7) ENHANCED 911 SERVICE AREA - The geographic area in which the customer will respond to all E911 calls and dispatch appropriate emergency assistance.
- 8) FIXED CALL EXTENSION - A feature which enables a PSAP attendant to extend incoming E911 calls to secondary PSAPs by use of a single button on the attendant console.
- 9) FORCED DISCONNECT - A function of the E911 Central Office trunk circuit which enables the PSAP attendant to release a connection even though the calling party has not hung up. This feature prevents the jamming of the E911 exchange lines and is a standard feature of E911 service.

GENERAL EXCHANGE TARIFF

Embarq Florida, Inc.

By: F. B. Poag  
Director

SECTION A10  
Second Revised Sheet 24  
Cancelling First Revised Sheet 24  
Effective: July 14, 2001

N11 SERVICES

A. E11 EMERGENCY REPORTING SERVICES (Cont'd)

2. CENTRAL TELEPHONE EXCHANGES (Cont'd)

b. Explanation of Terms (Cont'd)

- 10) MANUAL TRANSFER - A feature that enables the PSAP attendant to transfer an incoming call by depressing the switch hook of the associated telephone or the "add" button on the Display and Transfer Unit and dialing either a 7 digit or 10-digit telephone number or a 2-digit Speed Calling Code. Manual Transfer is associated with the E911 trunk unit and is a standard feature of the E911 service.
- 11) PUBLIC SAFETY ANSWERING POINT (PSAP) - An answering location for 911 calls originating in a given area. A PSAP may be designated as Primary or Secondary, which refers to the order in which calls are directed for answering. Primary PSAPs respond first; Secondary PSAPs receive calls on a transfer basis only. PSAPs are public service agencies such as police, fire, or emergency medical or a common bureau servicing a group of such entities.
- 12) SELECTIVE ROUTING (SR) - A feature that routes an E911 call from a Central Office to the designated primary PSAP based upon the identified number of the calling party.
- 13) SERVING CENTRAL OFFICE - The central office from which a PSAP, either primary or secondary, is served.
- 14) UNIVERSAL EMERGENCY NUMBER SERVICE - A telephone exchange communication service for receiving telephone calls placed by persons in need of assistance who dial the number 911. Such calls are answered at PSAPs established and operated by the customer. The lines and equipment associated with the service arrangement for the answering, transferring and dispatching of public emergency telephone calls are included.

GENERAL EXCHANGE TARIFF

Embarq Florida, Inc.

By: F. B. Poag  
Director

SECTION A10  
Second Revised Sheet 25  
Cancelling First Revised Sheet 25  
Effective: July 14, 2001

N11 SERVICES

A. E911 EMERGENCY REPORTING SERVICES (Cont'd)

2. CENTRAL TELEPHONE EXCHANGES (Cont'd)

b. Explanation of Terms (Cont'd)

15) UNIVERSAL EMERGENCY NUMBER SERVICE CUSTOMER - A municipality or other county or local governmental unit or an authorized agent of one or more municipalities or other county or local governmental units to whom authority has been lawfully delegated within a defined geographic area to respond to public emergency telephone calls, at the minimum for police and fire service.

16) WIRE CENTER - The term "wire center" denotes the local telephone dial switching office serving subscribers in a well defined area.

c. Rules and Regulations

1) 911 service is provided by the Company where facilities and operating conditions permit.

2) This offering is limited to the use of central office number 911 as the universal emergency number and only one 911 service will be provided within any geographical area.

3) The 911 emergency number is not intended to replace the telephone service of the various public safety agencies which may participate in the use of this number. The customer must subscribe for additional local exchange service at the PSAPs for administrative purposes for placing of outgoing calls and for receiving other emergency calls, including any which might be relayed by Company operators.

GENERAL EXCHANGE TARIFF

Embarq Florida, Inc.

By: F. B. Poag  
Director

SECTION A10  
Second Revised Sheet 26  
Cancelling First Revised Sheet 26  
Effective: July 14, 2001

N11 SERVICES

A. E911 EMERGENCY REPORTING SERVICES (Cont'd)

2. CENTRAL TELEPHONE EXCHANGES (Cont'd)

c. Rules and Regulations (Cont'd)

- 4) The service is furnished to municipalities and other governmental agencies only for the purpose of voice reporting emergencies by the public.
- 5) When the use of service or facilities furnished by the Company is interrupted due to any cause other than the negligence or willful act of the subscriber or the failure of the facilities provided by the subscriber, a pro rata adjustment of the fixed monthly charges involved will be allowed as covered by Section A2 of this tariff. Where allowances on features which are affected by the interrupted service shall be considered; and further, only those access lines on the interrupted portion of a service shall be considered in determining the number of access lines affected.
- 6) It will be the intent of the Company to provide facilities designed to provide a call blocking probability of one call per hundred during normal busy hours for 911 service.
- 7) This service is offered solely as an aid in handling assistance calls in connection with fire, police and other emergencies and does not create any relationship or obligation, direct or indirect, to any person other than the customer contracting for 911 service. In the event of any interruption of the service, the Company shall not be liable to any person, corporation or other entity for any loss or damage in an amount greater than an amount equal to the pro rata allowance of the tariff rate for the service or facilities provided to the customer for the time such interruption continues, after notice to the Company. No allowance shall be made if the interruption is due to the negligence or willful act of the customer of the service.

GENERAL EXCHANGE TARIFF

Embarq Florida, Inc.

By: F. B. Poag  
Director

SECTION A10  
Second Revised Sheet 27  
Cancelling First Revised Sheet 27  
Effective: July 14, 2001

N11 SERVICES

A. E911 EMERGENCY REPORTING SERVICES (Cont'd)

2. CENTRAL TELEPHONE EXCHANGES (Cont'd)

c. Rules and Regulations (Cont'd)

7) (Cont'd)

Further, each customer agrees to release, indemnify, defend, and hold harmless the Company from any and all loss, claims, demands, suits or other action, or any liability whatsoever, whether suffered, made, instituted or asserted by the customer or by any other party or person, for any personal injury to or death of any person or persons, or for any loss, damage or destruction of any property, whether owned by the customer or others, or for any infringement or invasion of the right of privacy of any person or persons, caused or claimed to have been caused, directly or indirectly, by the installation, operation, failure to operate, maintenance, removal, presence, condition, location or use of 911 service features and the equipment associated therewith or by any services which are or may be furnished by the Company in connection therewith, including but not limited to the identification of the telephone number, address or name associated with the telephone used by the party or parties accessing 911 services hereunder, and which arise out of the negligence or other wrongful act of the Company, the customer, its user agencies or municipalities or employees or agents of any one of them.

GENERAL EXCHANGE TARIFF

Embarq Florida, Inc.

By: F. B. Poag  
Director

SECTION A10  
Second Revised Sheet 28  
Cancelling First Revised Sheet 28  
Effective: July 14, 2001

N11 SERVICES

A. E911 EMERGENCY REPORTING SERVICES (Cont'd)

2. CENTRAL TELEPHONE EXCHANGES (Cont'd)

c. Rules and Regulations (Cont'd)

- 8) When an order for 911 service and facilities or requests for additions, rearrangements, relocations, or modifications of service and equipment are canceled in whole or in part prior to the completion of the work involved, the customer is required to reimburse the Company for all expenses incurred in handling the request before notice of cancellation is received. Such charges, however, are not to exceed all charges which would apply if the work involved in complying with the request had been completed.
- 9) Application for 911 service must be executed in writing by the customer (a municipality, a local government authority or their duly appointed agent). If execution is by an agent, satisfactory evidence of the appointment must be provided in writing to the company. At least one local law enforcement agency must be included among the participating agencies in any 911 offering.
- 10) The customer must furnish the Company, in writing, with its agreement to the following terms and conditions:
  - a) That at least one PSAP will be provided and staffed on a 24-hour, seven days per week basis.
  - b) That the customer accepts responsibility for dispatching, or having others dispatch police, fire, ambulance or other emergency services as required, to the extent as such services are reasonably available.



GENERAL EXCHANGE TARIFF

Embarq Florida, Inc.

By: F. B. Poag  
Director

SECTION A10  
Second Revised Sheet 29  
Cancelling First Revised Sheet 29  
Effective: July 14, 2001

N11 SERVICES

A. E911 EMERGENCY REPORTING SERVICES (Cont'd)

2. CENTRAL TELEPHONE EXCHANGES (Cont'd)

c. Rules and Regulations (Cont'd)

10) (Cont'd)

- c) That the customer will develop an appropriate method for responding to calls for nonparticipating agencies which may be directed to the 911 PSAP by calling parties.
  - d) That the customer will subscribe to or provide 911 equipment with a capacity adequate to handle the number of incoming 911 lines recommended by the Company to be installed. (Applies to E911 service only.)
- 11) Terminal equipment as offered in the appropriate sections of this Tariff may be provided by the Company for use with this service.
  - 12) Temporary suspension of service is not provided for any part of the 911 service.
  - 13) The rates charged for 911 service do not contemplate the constant monitoring or inspection of facilities to discover errors, defects, and malfunctions in the service, nor does the Company undertake such responsibility. The customer shall make such operational tests as, in the judgment of the customer, are required to determine whether the system is functioning properly for its use. The customer shall promptly notify the Company in the event the system is not functioning properly.

GENERAL EXCHANGE TARIFF

Embarq Florida, Inc.

By: F. B. Poag  
Director

SECTION A10  
Second Revised Sheet 30  
Cancelling First Revised Sheet 30  
Effective: July 14, 2001

N11 SERVICES

A. E911 EMERGENCY REPORTING SERVICES (Cont'd)

2. CENTRAL TELEPHONE EXCHANGES (Cont'd)

c. Rules and Regulations (Cont'd)

- 14) Company serving boundaries and political subdivision boundaries may not coincide. If a central office serves telephones located both within and outside the customer's public safety jurisdiction, it is the obligation of the customer to make arrangements to handle all 911 calls that originate from telephones served by these central offices.
- 15) 911 service is classified as Business Exchange Service and is arranged for one-way incoming service to the appropriate PSAP. Outgoing calls can only be made on a transfer basis.
- 16) E911 information consisting of the names, addresses and telephone numbers of customers whose listings are not published in directories or listed in Directory Assistance Offices is confidential. Information will be provided on a call-by-call basis only for the purpose of responding to emergency calls. The 911 calling party forfeits the privacy afforded by nonpublished and nonlisted telephone number service to the extent that the telephone number, address and name associated with the originating station location are furnished to the PSAP.
- 17) Central offices that are not currently equipped to transmit ANI will not be modified to provide ANI just for E911 service. Default Routing and Central Office identification will be provided in lieu of Selective Routing and ANI Display. When the Selective Routing feature is provided

GENERAL EXCHANGE TARIFF

Embarq Florida, Inc.

By: F. B. Poag  
Director

SECTION A10  
Second Revised Sheet 31  
Cancelling First Revised Sheet 31  
Effective: July 14, 2001

N11 SERVICES

A. E911 EMERGENCY REPORTING SERVICES (Cont'd)

2. CENTRAL TELEPHONE EXCHANGES (Cont'd)

c. Rules and Regulations (Cont'd)

17) (Cont'd)

the customer is responsible for identifying primary and secondary PSAP locations as well as the unique combinations of police, fire, and ambulance or any other appropriate agencies responsible for providing emergency service in the E911 serving area.

18) The Company's entire liability to any person for interruption or failure of 911 service shall be limited to the terms set forth in this section and other sections of this Tariff.

19) General Regulations located in Section A2 of this Tariff will also apply to this service offering.

20) Where a 911 call is placed by the calling party via interconnection with an interexchange carrier, the Company cannot guarantee the completion of said 911 call, the quality of the call or any features that may otherwise be provided with 911 service.

GENERAL EXCHANGE TARIFF

Embarq Florida, Inc.

By: F. B. Poag  
Director

SECTION A10  
Second Revised Sheet 32  
Cancelling First Revised Sheet 32  
Effective: July 14, 2001

N11 SERVICES

A. E911 EMERGENCY REPORTING SERVICES (Cont'd)

2. CENTRAL TELEPHONE EXCHANGES (Cont'd)

c. Rules and Regulations (Cont'd)

21) The Company will bill "911" local option fees in accordance with Chapter 365, Florida Statutes, as amended. Each customer imposing a 911 local option fee agrees to release, indemnify, defend and hold harmless the Company from any and all loss, claims, demands, suits or other action, or any liability whatsoever, whether suffered, made, instituted or asserted by the customer or by any other party or person, arising out of the Company's good faith compliance with the instructions of the customer concerning the imposition, billing, collection or remittance of the 9121 fee, whether or not the act of complying with the customer's instructions is deemed to be negligent.

d. E-911 Service for Okaloosa County, Florida

1) General

a) This tariff is for E911 service for Okaloosa County and service is provided under this tariff and the "Agreement to Furnish Enhanced 911 Emergency Reporting Telephone Service" signed and agreed to by the Board of County Commission and Central Telephone Company of Florida.

GENERAL EXCHANGE TARIFF

Embarq Florida, Inc.

By: F. B. Poag  
Director

SECTION A10  
Second Revised Sheet 33  
Cancelling First Revised Sheet 33  
Effective: July 14, 2001

N11 SERVICES

A. E911 EMERGENCY REPORTING SERVICES (Cont'd)

2. CENTRAL TELEPHONE EXCHANGES (Cont'd)

d. E-911 Service for Okaloosa County, Florida (Cont'd)

1) General (Cont'd)

- b) The E911 system shall provide the services and features as shown in this section following. Additions, modifications, or removals of service components shall be made by the Company at the customer's request. Such changes shall be made at the company's prevailing rates at the time the request is made. Rates for new services shall be developed on an individual case basis.
- c) The customer's E911 coordinator will act as coordinator for implementation and ongoing administration of all 911 data management associated with E911 service.
- d) The Coordinator's responsibilities include but are not limited to:
  - (1) Coordinating the identification of PSAP locations as well as the unique combinations of police, fire, emergency medical, and any other appropriate agencies responsible for providing emergency service in the E911 area.

GENERAL EXCHANGE TARIFF

Embarq Florida, Inc.

By: F. B. Poag  
Director

SECTION A10  
Second Revised Sheet 34  
Cancelling First Revised Sheet 34  
Effective: July 14, 2001

N11 SERVICES

A. E911 EMERGENCY REPORTING SERVICES (Cont'd)

2. CENTRAL TELEPHONE EXCHANGES (Cont'd)

d. E-911 Service for Okaloosa County, Florida (Cont'd)

1) General (Cont'd)

d) (Cont'd)

(2) Coordinating the Emergency Service Numbers (ESNs) with street address ranges or other routing criteria in the E911 serving area for all agencies that are part of the system, including those with separate agreements, if any. Such ESNs will be assigned to permit routing of E911 calls to the primary and secondary PSAPs responsible for handling calls from each telephone in the E911 serving area.

(3) After establishment of the E911 service, coordinating the accuracy of the routing information, and to advise the Company of any changes in street names, establishment of new streets, changes in address numbers used on existing streets, closing and abandonment of streets, changes in police, fire, ambulance or other appropriate agencies' jurisdiction over any address, annexation and other changes in local jurisdictional boundaries, incorporation of new cities or any other matter that will affect the routing of E911 calls to the proper PSAP for all agencies that are part of the system, including those with separate contracts, if any.

GENERAL EXCHANGE TARIFF

Embarq Florida, Inc.

By: F. B. Poag  
Director

SECTION A10  
Second Revised Sheet 35  
Cancelling First Revised Sheet 35  
Effective: July 14, 2001

N11 SERVICES

A. E911 EMERGENCY REPORTING SERVICES (Cont'd)

2. CENTRAL TELEPHONE EXCHANGES (Cont'd)

d. E-911 Service for Okaloosa County, Florida (Cont'd)

1) General (Cont'd)

d) (Cont'd)

- (4) The initial ALI and the ANI record will be loaded from the Company's customer records. These records will be provided to the Okaloosa County 911 Coordinator for verification and comparison of correct addresses. It shall be the responsibility of the County 911 Coordinator to provide to the company changes necessary from the verification process. Changes, deletions and additions which the customer desires to have made in the ALI should be submitted to the Company on an "as occurred" basis. Changes are to be forwarded to the Company's E911 Coordinator at the following address:

Embarq Florida, Inc.  
E911 Coordinator  
P O Box 2214  
Tallahassee Florida 32316-2214

- e) Costs incurred by the Company for services requested by the customer over and above those specified in this Agreement shall be charged, as incurred, to the customer on a time and materials basis.

GENERAL EXCHANGE TARIFF

Embarq Florida, Inc.

By: F. B. Poag  
Director

SECTION A10  
Second Revised Sheet 36  
Cancelling First Revised Sheet 36  
Effective: July 14, 2001

N11 SERVICES

A. E911 EMERGENCY REPORTING SERVICES (Cont'd)

2. CENTRAL TELEPHONE EXCHANGES (Cont'd)

d. E911 Service for Okaloosa County, Florida (Cont'd)

1) General (Cont'd)

f) Customer agrees to limit the use of utility provided information regarding its telephone subscribers, including names, addresses, and telephone numbers, to the strict performance of the customer's assigned responsibilities as a public agency under the terms of this agreement.

g) If, prior to the date on which this service is available and accepted for use by the customer, the customer cancels all or any part of the service, the customer shall pay to the Company an amount of money as provided below :

(1) Any and all costs expended or committed for the installation and removal of said service, including but not limited to, labor costs, engineering and supply expenses, costs for equipment and facilities less salvage value;

(2) The total applicable nonrecurring charges.

h) System acceptance is required when the equipment is cut over and operating in accordance with the manufacturer's specifications and the Performance Criteria following; should the equipment not operate in accordance with manufacturer's specifications and the Performance Criteria, the Company will make the equipment operate in accordance with such



GENERAL EXCHANGE TARIFF

Embarq Florida, Inc.

By: F. B. Poag  
Director

SECTION A10  
Second Revised Sheet 37  
Cancelling First Revised Sheet 37  
Effective: July 14, 2001

N11 SERVICES

A. E911 EMERGENCY REPORTING SERVICES (Cont'd)

2. CENTRAL TELEPHONE EXCHANGES (Cont'd)

d. E911 Service for Okaloosa County, Florida (Cont'd)

1) General (Cont'd)

h) (Cont'd)

specifications. When acceptance is required, the customer agrees to sign an acceptance certificate that: (1) the equipment has been installed in good condition, (2) the equipment is accepted as installed, and (3) payment is due without setoff or abatement.

Should the Company not be able to install the equipment, as a result of their direct control and responsibility, the customer will not be financially responsible for the affected hardware and/or service.

- i) Unless sooner terminated, this Agreement shall continue for an initial period of 120 months from the date the E911 service is placed in service for the ANI/ALI PSAP equipment as shown.
- j) All equipment furnished by the Company hereunder shall remain the property of the Company. The customer shall be responsible for loss or damage to the equipment furnished under this Agreement unless such loss or damage is due to causes beyond its control.

GENERAL EXCHANGE TARIFF

Embarq Florida, Inc.

By: F. B. Poag  
Director

SECTION A10  
Second Revised Sheet 38  
Cancelling First Revised Sheet 38  
Effective: July 14, 2001

N11 SERVICES

A. E911 EMERGENCY REPORTING SERVICES (Cont'd)

2. CENTRAL TELEPHONE EXCHANGES (Cont'd)

d. E911 Service for Okaloosa County, Florida (Cont'd)

1) General (Cont'd)

k) The Company warrants the equipment will be free from defects in material and workmanship, and the Company will provide, at its expense, maintenance service to keep the equipment in good working condition and repair. If warranty work is necessary, the Company will at its option, repair the equipment in place or accept the return of equipment, at its expense, for repair or replacement.

2) Maintenance and Repairs

a) Maintenance and repairs of the E911 facilities and equipment under this Agreement is subject to the Company's General Exchange Tariff. Maintenance will include the furnishing of all necessary labor and materials for the equipment. The Company will respond to requests to perform service for any significant malfunction of the equipment within four (4) hours of receipt of notice from the customer requesting such service. Significant malfunction is defined as any service interruption that renders the following:

- (1) Any E911 trunk out of service
- (2) Any E911 system ringdown circuit out of service
- (3) Any E911 system data circuit out of service

GENERAL EXCHANGE TARIFF

Embarq Florida, Inc.

By: F. B. Poag  
Director

SECTION A10  
Second Revised Sheet 39  
Cancelling First Revised Sheet 39  
Effective: July 14, 2001

N11 SERVICES

A. E911 EMERGENCY REPORTING SERVICES (Cont'd)

2. CENTRAL TELEPHONE EXCHANGES (Cont'd)

d. E911 Service for Okaloosa County, Florida (Cont'd)

2) Maintenance and Repairs (Cont'd)

a) (Cont'd)

(4) ALI and/or ANI screen functions inoperative at any console

(5) Failure of ANI and/or ALI at any PSAP

(6) Failure of PSAP to PSAP transfer of ANI and/or ALI

(7) Failure of PSAP to secondary answering position transfer of ANI and/or ALI

(8) Inability to receive incoming calls

(9) Inability to make outgoing calls

(10) Total console failure

(11) Failure of selective routing system.

b) The Company warrants that the E911 system will be administered under its "Priority Restoral" Service Program which qualifies the service for priority treatment for service affecting situations requiring repair.

GENERAL EXCHANGE TARIFF

Embarq Florida, Inc.

By: F. B. Poag  
Director

SECTION A10  
Second Revised Sheet 40  
Cancelling First Revised Sheet 40  
Effective: July 14, 2001

N11 SERVICES

A. E911 EMERGENCY REPORTING SERVICES (Cont'd)

2. CENTRAL TELEPHONE EXCHANGES (Cont'd)

d. E911 Service for Okaloosa County, Florida (Cont'd)

2) Maintenance and Repairs (Cont'd)

c) Except for damages due to the Company's gross negligence or willful misconduct, the Company's liability for any loss or damage arising from any errors, interruptions, defects, failure of equipment or service or malfunction in this service or any part thereof whether caused by the negligence of the Company or otherwise shall be (1) totally disclaimed and excluded with respect to incidental, special, consequential, and commercial damages, and (2) not in excess of the lesser of \$500.00 or the actual damages incurred by the customer with respect to all other damages.

d) The Company and its duly authorized agents and employees shall have the right of ingress and egress where said facilities are installed for the purpose of inspecting, maintaining, and repairing said facilities and for all other purposes necessary to the performance of this Agreement.

3) Rates and Charges

a) The in service date for the service covered by this Tariff shall be September 1, 1988.

b) Authorized Agencies "PSAP Service"

(1) Crestview Police Department

GENERAL EXCHANGE TARIFF

Embarq Florida, Inc.

By: F. B. Poag  
Director

SECTION A10  
Second Revised Sheet 41  
Cancelling First Revised Sheet 41  
Effective: July 14, 2001

N11 SERVICES

A. E911 EMERGENCY REPORTING SERVICES (Cont'd)

2. CENTRAL TELEPHONE EXCHANGES (Cont'd)

d. E911 Service for Okaloosa County, Florida (Cont'd)

3) Rates and Charges (Cont'd)

b) Authorized Agencies "PSAP Service" (Cont'd)

- (2) Okaloosa County Sheriff's Department
- (3) Fort Walton Beach Police Department
- (4) Hurlbert Field
- (5) Niceville Police Department
- (6) Valparaiso Police Department
- (7) Eglin Air Force Base

c) Nonrecurring Charges

Nonrecurring Charges shall be paid as follows:

\$ 49,768.00	(10%)	Upon signing of agreement
\$149,304.00	(30%)	November 1, 1987
\$159,257.00	(32%)	On the cut over date
\$139,350.00	(28%)	Upon acceptance or until collected from subscribers in Okaloosa County whichever occurs last, but in no event later than October 1, 1988.

GENERAL EXCHANGE TARIFF

Embarq Florida, Inc.

By: F. B. Poag  
Director

SECTION A10  
Second Revised Sheet 42  
Cancelling First Revised Sheet 42  
Effective: July 14, 2001

N11 SERVICES

A. E911 EMERGENCY REPORTING SERVICES (Cont'd)

2. CENTRAL TELEPHONE EXCHANGES (Cont'd)

d. E911 Service for Okaloosa County, Florida (Cont'd)

3) Rates and Charges (Cont'd)

d) Monthly Rates

Pursuant to the agreement, the monthly equipment rate of \$20,033.00 for a ten (10) year period is applicable for the E911 equipment itemized following. The equipment rate does not include the monthly rates for applicable tariffed line services subscribed to by the customer for E911 service.

(1) ANI Equipment

(a) Crestview Police Department

1 Console  
1 Control Cabinet  
2 Incoming Trunk Cards  
2 Ringdown Trunk Cards

(b) Fort Walton Beach Police Department

2 Consoles  
1 Control Cabinet  
3 Incoming Trunk Cards  
1 Ringdown Trunk Card

GENERAL EXCHANGE TARIFF

Embarq Florida, Inc.

By: F. B. Poag  
Director

SECTION A10  
Second Revised Sheet 43  
Cancelling First Revised Sheet 43  
Effective: July 14, 2001

N11 SERVICES

A. E911 EMERGENCY REPORTING SERVICES (Cont'd)

2. CENTRAL TELEPHONE EXCHANGES (Cont'd)

d. E911 Service for Okaloosa County, Florida (Cont'd)

3) Rates and Charges (Cont'd)

d) Monthly Rates

(1) ANI Equipment (Cont'd)

(c) Shalimar - Okaloosa County Sheriff's Department

2 Consoles  
1 Control Cabinet  
5 Incoming Trunk Cards  
7 Ringdown Trunk Cards

(d) Hurlburt Field

1 Console  
1 Control Cabinet  
2 Incoming Trunk Cards  
1 Ringdown Trunk Cards

(e) Niceville Police Department

1 Console  
1 Control Cabinet  
2 Incoming Trunk Cards  
2 Ringdown Trunk Cards

GENERAL EXCHANGE TARIFF

Embarq Florida, Inc.

By: F. B. Poag  
Director

SECTION A10  
Second Revised Sheet 44  
Cancelling First Revised Sheet 44  
Effective: July 14, 2001

N11 SERVICES

A. E911 EMERGENCY REPORTING SERVICES (Cont'd)

2. CENTRAL TELEPHONE EXCHANGES (Cont'd)

d. E911 Service for Okaloosa County, Florida (Cont'd)

3) Rates and Charges (Cont'd)

d) Monthly Rates (Cont'd)

(1) ANI Equipment (Cont'd)

(f) Valparaiso Police Department

1 Console  
1 Control Cabinet  
2 Incoming Trunk Cards  
1 Ringdown Trunk Card

(g) Eglin Air Force Base

1 Console  
1 Control Cabinet  
2 Incoming Trunk Cards  
2 Ringdown Trunk Cards

(2) ALI Equipment

(a) Crestview (will serve the northern part of the county)

1 HP 3000  
1 Flow Control Engine  
7 Modems  
3 CRTs/Thinkjet Printers  
1 Spooled Printer



GENERAL EXCHANGE TARIFF

Embarq Florida, Inc.

By: F. B. Poag  
Director

SECTION A10  
Second Revised Sheet 45  
Cancelling First Revised Sheet 45  
Effective: July 14, 2001

N11 SERVICES

A. E911 EMERGENCY REPORTING SERVICES (Cont'd)

2. CENTRAL TELEPHONE EXCHANGES (Cont'd)

d. E911 Service for Okaloosa County, Florida (Cont'd)

3) Rates and Charges (Cont'd)

d) Monthly Rates (Cont'd)

(2) ALI Equipment (Cont'd)

(b) Shalimar (will serve the southern part of the county)

1 HP 3000XE  
1 Flow Control Engine  
47 Modems  
15 CRTs/Thinkjet Printers  
1 Spooled Printer (Heavy Duty)

(c) Selective Routing Switch

Hardware  
Software

4) Additional Equipment and Features

a) The equipment and features shown in this section are those features requested by Okaloosa County after the original Request for service.

GENERAL EXCHANGE TARIFF

Embarq Florida, Inc.

By: F. B. Poag  
Director

SECTION A10  
Second Revised Sheet 46  
Cancelling First Revised Sheet 46  
Effective: July 14, 2001

N11 SERVICES

A. E911 EMERGENCY REPORTING SERVICES (Cont'd)

2. CENTRAL TELEPHONE EXCHANGES (Cont'd)

d. E911 Service for Okaloosa County, Florida (Cont'd)

4) Additional Equipment and Features (Cont'd)

b) The rates shown following are in addition to the monthly rate shown previously.

	<u>Monthly Rate</u>	<u>NRC</u>
c) Destin Fire Department Informer CRT/Thinkjet Printer	\$255.35	---
Does not include tariffed Local Private Line circuits		
d) Fort Walton Beach Ringdown Trunk Card	37.50	---
e) Eglin Air Force Base Medical Service Back-Up	79.00	---
f) Hurlburt Air Force Base Medical Service Back-Up	95.00	
g) Selective Routing Switch Equipment Upgrade Includes Four (4) Additional Incoming Trunks	645.00	---

GENERAL EXCHANGE TARIFF

Embarq Florida, Inc.

By: F. B. Poag  
Director

SECTION A10  
Second Revised Sheet 47  
Cancelling First Revised Sheet 47  
Effective: July 14, 2001

N11 SERVICES

A. E911 EMERGENCY REPORTING SERVICES (Cont'd)

2. CENTRAL TELEPHONE EXCHANGES (Cont'd)

d. E911 Service for Okaloosa County, Florida (Cont'd)

5) Performance Criteria

a) Grade of Service

The E911 system should be designed to provide P01 grade of service. This will result in an average of one busy indication in one hundred attempts to reach the primary PSAP.

b) Design Specifications

- (1) The E911 system should be designed to provide a minimum of seven (7) primary PSAPs with growth capacity.
- (2) The E911 system should be designed to handle 60,000 subscriber numbers with growth capability of 10 percent per year.
- (3) The E911 system should be designed to handle a minimum of 100 trunks.
- (4) The E911 system should be designed to provide automatic alarms if system failure occurs or if any portion of the system has failure.
- (5) The E911 system PSAP should be designed to process a minimum of 23 calls per second.

GENERAL EXCHANGE TARIFF

Embarq Florida, Inc.

By: F. B. Poag  
Director

SECTION A10  
Second Revised Sheet 48  
Cancelling First Revised Sheet 48  
Effective: July 14, 2001

N11 SERVICES

A. E911 EMERGENCY REPORTING SERVICES (Cont'd)

2. CENTRAL TELEPHONE EXCHANGES (Cont'd)

d. E911 Service for Okaloosa County, Florida (Cont'd)

5) Performance Criteria (Cont'd)

b) Design Specifications (Cont'd)

- (6) The E911 system PSAP equipment should be designed to handle a minimum of 12 answering positions.
- (7) The E911 system should be designed so that the ANI will display at the same time that the 911 call is answered at the primary PSAP.
- (8) The E911 system should be designed so that ALI information appears on the ALI CRT in a minimum of 3 seconds.
- (9) The E911 system should be designed so that evaluation and performance reporting can be obtained.
- (10) The E911 system should be designed to provide default routing of 911 calls. Default routing should take place when
  - (a) ANI failure occurs.
  - (b) Retrieval of the calling number is not found in the selective routing data base.
  - (c) All trunks to the correct PSAP are busy.

GENERAL EXCHANGE TARIFF

Embarq Florida, Inc.

By: F. B. Poag  
Director

SECTION A10  
Second Revised Sheet 49  
Cancelling First Revised Sheet 49  
Effective: July 14, 2001

N11 SERVICES

A. E911 EMERGENCY REPORTING SERVICES (Cont'd)

2. CENTRAL TELEPHONE EXCHANGES (Cont'd)

d. E911 Service for Okaloosa County, Florida (Cont'd)

5) Performance Criteria (Cont'd)

b) Design Specifications (Cont'd)

(10) (Cont'd)

(d) A primary PSAP is out of service.

(11) The E911 system should be designed to provide transfer capability so that a primary PSAP can transfer a 911 call to any other primary PSAP and ANI will also transfer so that the receiving PSAP will retrieve ALI.

(a) The transfer arrangement should be designed so that after a 911 call is transferred, the transferring PSAP can drop off without disconnecting the 911 caller and the PSAP transfer.

(b) The transfer arrangement should be designed so that a primary PSAP can transfer a 911 caller to any seven digit number or secondary PSAP including transfer of ALI and ANI.

(c) The transfer arrangement should be designed so that if a primary PSAP receives a busy signal after an attempt to transfer a call, that transfer can be cancelled without disconnecting the 911 caller.

GENERAL EXCHANGE TARIFF

Embarq Florida, Inc.

By: F. B. Poag  
Director

SECTION A10  
Second Revised Sheet 50  
Cancelling First Revised Sheet 50  
Effective: July 14, 2001

N11 SERVICES

A. E911 EMERGENCY REPORTING SERVICES (Cont'd)

2. CENTRAL TELEPHONE EXCHANGES (Cont'd)

d. E911 Service for Okaloosa County, Florida (Cont'd)

5) Performance Criteria (Cont'd)

b) Design Specifications (Cont'd)

(11) (Cont'd)

(d) The transfer arrangement should be designed so that a primary PSAP that has received a transfer from another PSAP can transfer the 911 call to another primary or secondary PSAP without disconnect.

12) The E911 system should be designed so that telephone company service order information will be updated in the 911 ALI data base within 48 hours from the point a service order is completed by the telephone company.

13) The E911 system should be designed to provide forced disconnect to prevent over congestion in the event that a 911 caller has not hung up.

GENERAL EXCHANGE TARIFF

Embarq Florida, Inc.

By: F. B. Poag  
Director

SECTION A10  
Second Revised Sheet 51  
Cancelling First Revised Sheet 51  
Effective: July 14, 2001

N11 SERVICES

A. E911 EMERGENCY REPORTING SERVICES (Cont'd)

2. CENTRAL TELEPHONE EXCHANGES (Cont'd)

e. E-911 Service for Leon County Florida

1) General

- a) This tariff is for E911 service for Leon County and service is provided under this tariff and the "Agreement to Furnish Emergency Reporting Telephone Service" signed October 23, 1990 and agreed to by the Board of County Commissioners and Central Telephone company of Florida.
- b) The E911 system shall provide the services and features as shown following. System additions, modifications, or removals of service components shall be made by the Company at the customer's request. Such changes shall be made at the company's prevailing rates at the time the request is made. Rates for new service shall be developed on an individual case basis.
- c) The customer's E911 Coordinator will act as coordinator for implementation and ongoing administration of all E911 data management associated with E911 service.
- d) Costs incurred by the company for services requested by the customer over and above those specified in this tariff shall be charged, as incurred, to the customer on a time and materials basis.

GENERAL EXCHANGE TARIFF

Embarq Florida, Inc.

By: F. B. Poag  
Director

SECTION A10  
Second Revised Sheet 52  
Cancelling First Revised Sheet 52  
Effective: July 14, 2001

N11 SERVICES

A. E911 EMERGENCY REPORTING SERVICES (Cont'd)

2. CENTRAL TELEPHONE EXCHANGES (Cont'd)

e. E-911 Service for Leon County Florida (Cont'd)

1) General (Cont'd)

- e) The customer agrees to limit the use of utility provided information regarding its telephone subscribers, including names, addresses, and telephone numbers, to the strict performance of the customer's assigned responsibilities as a public agency under the terms of the Agreement.
- f) The contract period for this service is twelve months and shall automatically renew for successive periods of one year. In the event the customer shall give notice of its intention not to renew prior to the seventh one-year anniversary of the agreement date; the customer shall pay the net book value of the equipment as carried on the company's books of account in accordance with generally accepted accounting principles and applicable Public Service Commission (PSC) rules.



GENERAL EXCHANGE TARIFF

Embarq Florida, Inc.

By: F. B. Poag  
Director

SECTION A10  
Second Revised Sheet 53  
Cancelling First Revised Sheet 53  
Effective: July 14, 2001

N11 SERVICES

A. E911 EMERGENCY REPORTING SERVICES (Cont'd)

2. CENTRAL TELEPHONE EXCHANGES (Cont'd)

e. E-911 Service for Leon County Florida (Cont'd)

2) Maintenance and Repairs

- a) The Company will provide maintenance for the E911 system throughout the lifetime of the contract. The rates shown cover the costs of a maintenance contract. This maintenance excludes repairs or replacements made necessary by misuse, negligence, accident, theft or unexplained loss, abuse, connection to foreign electric current, fire, water, flood, wind, storms, lightning, any act of God or public enemy, failure to provide a suitable operating environment, unauthorized attachments or modification, or improper software changes, wiring, installation, repair or alteration by anyone other than the Company. The Company may perform repairs necessitated by any excluded cause of customer's request at the Company's then prevailing rates.
- b) The Company will respond to requests to perform services for any malfunction of the system, including station or trunk failure, (Regular Service) within the Company's next business day after receipt of notice from the customer requesting such service. The Company will respond to requests to perform service for a total system failure of the system ("Emergency Service") within four (4) hours of receipt of notice from the customer requesting such service.

GENERAL EXCHANGE TARIFF

Embarq Florida, Inc.

By: F. B. Poag  
Director

SECTION A10  
Second Revised Sheet 54  
Cancelling First Revised Sheet 54  
Effective: July 14, 2001

N11 SERVICES

A. E911 EMERGENCY REPORTING SERVICES (Cont'd)

2. CENTRAL TELEPHONE EXCHANGES (Cont'd)

e. E-911 Service for Leon County Florida (Cont'd)

2) Maintenance and Repairs (Cont'd)

c) "Emergency Service" will be provided only for system failures resulting in the following:

- (1) Total 911 system failure
- (2) Partial 911 system failure affecting call processing to one or more PSAP's or service agencies
- (3) An individual PSAP cannot receive calls at any one position
- (4) An individual PSAP cannot transfer calls at any one position.
- (5) Facilities failure that prevents an individual central office from reaching a PSAP
- (6) No ANI at one PSAP - all positions
- (7) No ALI at one PSAP - all positions
- (8) ALI system failure - all PSAPs
- (9) No ability to make a hard copy of ANI/ALI information at a primary PSAP.

GENERAL EXCHANGE TARIFF

Embarq Florida, Inc.

By: F. B. Poag  
Director

SECTION A10  
Second Revised Sheet 55  
Cancelling First Revised Sheet 55  
Effective: July 14, 2001

N11 SERVICES

A. E911 EMERGENCY REPORTING SERVICES (Cont'd)

2. CENTRAL TELEPHONE EXCHANGES (Cont'd)

e. E-911 Service for Leon County Florida (Cont'd)

2) Maintenance and Repairs (Cont'd)

d) The Company and its duly authorized agents and employees shall have the right of ingress and egress where said facilities are installed for the purpose of inspecting, maintaining, and repairing said facilities and for all other purposes necessary to the performance of this tariff and Agreement.

3) Rates and Charges

a) Authorized Agencies "PSAP Service"

- (1) Leon County Sheriff's Office
- (2) Tallahassee Police Department
- (3) Tallahassee Fire Department
- (4) Florida State University Police
- (5) Florida A&M University Police
- (6) Division of Safety and Crime Prevention
- (7) Tallahassee Memorial Regional Medical Center

b) Nonrecurring Charge

Due upon acceptance by customer                      \$451,000.00

GENERAL EXCHANGE TARIFF

Embarq Florida, Inc.

By: F. B. Poag  
Director

SECTION A10  
Second Revised Sheet 56  
Cancelling First Revised Sheet 56  
Effective: July 14, 2001

N11 SERVICES

A. E911 EMERGENCY REPORTING SERVICES (Cont'd)

2. CENTRAL TELEPHONE EXCHANGES (Cont'd)

e. E-911 Service for Leon County Florida (Cont'd)

3) Rates and Charges (Cont'd)

c) Monthly Rates

(1) Equipment Charges	\$16,063.00
(2) Data Base Administration	9,530.70
(3) Network Services Charges	Charges for lines and trunks are included in other sections of this tariff.

d) Contract Equipment and Features

- (1) The following listed equipment and features are covered under the rates shown previously.

	<u>Item</u>	<u>Qty</u>
1.	BAT-50AH BATTERY PAC K 50 AMP HOUR	2 EA
2.	CAB-CK CONNECTOR KIT PER CABLE	175 EA
3.	CAB-SH CABLE, SHIELDED	2600 FT
4.	CC216 RACK, MULTITECH MODEM	3 EA
5.	CE1570 CONSOLE, DESK/TABLE TOP	1 EA
6.	DRA-1 RACK, EQUIPMENT 19"	1 EA
7.	GABU-1 CIRCUIT	1 EA
8.	GACON TERMINAL, ASRS CONSOLE	1 EA
9.	GAERC CIRCUIT CARD, ERA DIAL	11 EA
10.	GAERP CIRCUIT PANEL, ERA DIAL	1 EA
11.	GAICP PANEL, INCOMING TRUNK	3 EA
12.	GAICT CARD INCOMING TRUNK	28 EA
13.	GAMFC CARD, MF SENDER	1 EA

GENERAL EXCHANGE TARIFF

Embarq Florida, Inc.

By: F. B. Poag  
Director

SECTION A10  
Second Revised Sheet 57  
Cancelling First Revised Sheet 57  
Effective: July 14, 2001

N11 SERVICES

A. E911 EMERGENCY REPORTING SERVICES (Cont'd)

2. CENTRAL TELEPHONE EXCHANGES (Cont'd)

e. E-911 Service for Leon County Florida (Cont'd)

3) Rates and Charges (Cont'd)

d) Contract Equipment and Features (Cont'd)

(1) The following listed equipment and features are covered under the rates shown previously. (Cont'd)

	<u>Item</u>	<u>Qty</u>
14.	GAMFC CARD, MATRIX EXPANSION	12 EA
15.	GANI-RC PACKAGE, TELEPAK ANI REGIONAL SPARES	1 EA
16.	GANI-S PACKAGE, TELEPAK	2 EA
17.	GASR-RC PACKAGE, ASRS	1 EA
18.	GASR-S PACKAGE, ASRS	1 EA
19.	GASRC CARD, ASRS TRUNK	11 EA
20.	GASRP PANEL, ASRS TRUNK CARD	1 EA
21.	GSBU-E CONSOLE, THREE OPERATOR	1 EA
22.	GWERA CIRCUIT CARD, ERA	16 EA
23.	GSICT CIRCUIT CARD, INCOMING TRUNK	4 EA
24.	GSLIP INTERFACE, ALI PSAP	1 EA
25.	GSLIS INTERFACE	1 EA
26.	GSMXOG CARD, MATRIX EXPANSION	3 EA
27.	GSTE-1 BAY, TRUNK EXPANSION	1 EA
28.	GXBU-T CONSOLE, FIVE OPERATOR	1 EA
29.	GXERA CIRCUIT CARD, ERA	17 EA
30.	GXERP CIRCUIT PANEL, ERA	1 EA
31.	GXICT CIRCUIT CARD	7 EA
32.	GXLIP INTERFACE, ALI PSAP	1 EA
33.	GXLIS INTERFACE, ALI ERA	1 EA
34.	GXXMDOG CARD, MATRIX EXPANSION	10 EA
35.	GXTE-1 BAY, TRUNK EXPANSION	1 EA

GENERAL EXCHANGE TARIFF

Embarq Florida, Inc.

By: F. B. Poag  
Director

SECTION A10  
Second Revised Sheet 58  
Cancelling First Revised Sheet 58  
Effective: July 14, 2001

N11 SERVICES

A. E911 EMERGENCY REPORTING SERVICES (Cont'd)

2. CENTRAL TELEPHONE EXCHANGES (Cont'd)

e. E-911 Service for Leon County Florida (Cont'd)

3) Rates and Charges (Cont'd)

d) Contract Equipment and Features (Cont'd)

- (1) The following listed equipment and features are covered under the rates shown previously. (Cont'd)

	<u>Item</u>	<u>Qty</u>
36.	H-XEO-510 MEMORY, SUB 4 MB	2 EA
37.	HD1151B/ABA SYSTEM, MS-DOS	1 EA
38.	HD1182A MONITOR, VGA COLOR	1 EA
39.	HD1347B VECTRA, ES/12 WITH 3.5 FD 42 MB HD VGA ADAPTER	1 EA
40.	H10833B CABLE, HP-IB FOR CARTRIDGE TAPE UNIT	2 EA
41.	H13242N CABLE, PRINTER	1 EA
42.	H2228A PRINTER	20 EA
43.	H2934A PRINTER, DOT MATRIX 200 CPS	4 EA
44.	H32545A CPU, HP MICRO 3000 XE WITH TWO MB MEMORY	2 EA
45.	H40242M CABLE, TERMINAL	2 EA
46.	H40290A CONTROLLER, ATP/M EIGHT PORT FOR MICRO 3000 SERIES	12 EA
47.	H51630A JETPAPER 500	20 EA
48.	H7959B DISK DRIVE 304 MB	2 EA
49.	H829595 BASE, TILT/SWIVEL FOR COLOR MONITOR	2 EA
50.	H9145A TAPE DRIVE, CARTRIDGE 133 MB	2 EA
51.	H92214P STAND	4 EA
52.	H92261A CARTRIDGE, INK BLK 2228A	20 EA
53.	H92261U STAND, QUIETJET PRINTER	20 EA
54.	INF911-CP INFORMER CONTINUOUS PRINT	12 EA

GENERAL EXCHANGE TARIFF

Embarq Florida, Inc.

By: F. B. Poag  
Director

SECTION A10  
Second Revised Sheet 59  
Cancelling First Revised Sheet 59  
Effective: July 14, 2001

N11 SERVICES

A. E911 EMERGENCY REPORTING SERVICES (Cont'd)

2. CENTRAL TELEPHONE EXCHANGES (Cont'd)

e. E-911 Service for Leon County Florida (Cont'd)

3) Rates and Charges (Cont'd)

d) Contract Equipment and Features (Cont'd)

- (1) The following listed equipment and features are covered under the rates shown previously. (Cont'd)

	<u>Item</u>	<u>Qty</u>
55.	INF911-RM INFORMER RACK MOUNT	3 EA
56.	MT224EH MODEM, MULTITECH 2400 BPS WITH MNP/5	41 EA
57.	MT224ER MODEM, MULTITECH 2400 BPS WITH MNP/5	46 EA
58.	PCA1000 RINGDOWN, P-I-C ERA	2 EA
59.	PCA1054 DIAL, P-I-C ERA	2 EA
60.	PS216A POWER SUPPLY, MULTITECH MODEM RACK	4 EA
61.	PWR-48V POWER SUPPLY/BATTERY BACKUP 48 VOLT DC INCLUDES BATTERY PACK 48 VOLT DC 50 AMP HOUR RECTIFIER 48 VOLT DC 30 AMP RACK COVERS GROUND BAR DISTRIBUTION FUSES ALARM PANEL	2 EA
62.	RAB-11CO CONTROL OPTION, ASCII	1 EA
63.	RAB-14CM MODULE, CHANNEL	40 EA
64.	RAB-14CR RACK, CONTROL	4 EA
65.	SW-ALI-SRO REPORTING OPTION, STATISTICAL MICRO 3000 ONLY	1 EA
66.	SW-ALI-XE LICENSE-XE, ALI SOFTWARE	1 EA

GENERAL EXCHANGE TARIFF

Embarq Florida, Inc.

By: F. B. Poag  
Director

SECTION A10  
First Revised Sheet 60  
Cancelling Original Sheet 60  
Effective: July 14, 2001

N11 SERVICES

A. E911 EMERGENCY REPORTING SERVICES (Cont'd)

2. CENTRAL TELEPHONE EXCHANGES (Cont'd)

e. E-911 Service for Leon County Florida (Cont'd)

3) Rates and Charges (Cont'd)

d) Contract Equipment and Features (Cont'd)

(1) The following listed equipment and features are covered under the rates shown previously. (Cont'd)

	<u>Item</u>	<u>Qty</u>
67.	SW-ALI-XEB LICENSE, ALI SFTWE XE BACKUP	1 EA
68.	SW-IFACE SFTWE, PC-HP3000 INTERFACE	1 EA
69.	SW-PCLINK SYSTEM, PC-MAINFRAME IFACE	1 EA
70.	SW-SK SWITCH, MANUAL BYPASS FOR UPS UNITS	6 EA
71.	TC-SCU CONTROL UNIT, KEY SYSTEM STATUS	6 EA
72.	UPS-3KVA BEST 3 KVA UPS FOR HP3000	1 EA
73.	H92245L CARTRIDGE, DATA TAPE 133 MB	2 EA

f. Basic 911 With ANI Service for Jefferson County

1) General

a) This tariff covers the provision of ANI delivered 911 service to the County of Jefferson, Florida. The 911 system shall provide services and features as shown following, at the rates shown following.



GENERAL EXCHANGE TARIFF

Embarq Florida, Inc.

By: F. B. Poag  
Director

SECTION A10  
Second Revised Sheet 61  
Cancelling First Revised Sheet 61  
Effective: July 14, 2001

N11 SERVICES

A. E911 EMERGENCY REPORTING SERVICES (Cont'd)

2. CENTRAL TELEPHONE EXCHANGES (Cont'd)

f. Basic 911 With ANI Service for Jefferson County (Cont'd)

1) General (Cont'd)

b) Additions, modifications or removals of service components shall be made by the Company at the customer's request. Such changes shall be made at the Company's prevailing rates at the time the request is made. Rates for new services shall be developed on an individual case basis.

2) Maintenance and Repairs

a) Maintenance and repairs of 911 facilities and equipment under this tariff will include the furnishing of all necessary labor and materials for the equipment. The Company will respond to requests to perform service for any significant malfunction of the equipment within four (4) hours of receipt of notice from the customer requesting such service.

b) The Company warrants that the 911 system will be administered under its "Priority Restoral" service program which qualifies the service for priority treatment for service affecting situations requiring repair.

GENERAL EXCHANGE TARIFF

Embarq Florida, Inc.

By: F. B. Poag  
Director

SECTION A10  
Second Revised Sheet 62  
Cancelling First Revised Sheet 62  
Effective: July 14, 2001

N11 SERVICES

A. E911 EMERGENCY REPORTING SERVICES (Cont'd)

2. CENTRAL TELEPHONE EXCHANGES (Cont'd)

f. Basic 911 With ANI Service for Jefferson County (Cont'd)

3) Rates and Charges

a) Nonrecurring Charge

Due upon acceptance by customer \$30,000.00

b) Monthly Recurring Charges

Telepak ANI Mini System \$ 926.00

Includes:

2 Operator Consoles

1 Control Cabinet-Equipped

1 Epson FX 850 Serial Printer

Lot Spare Parts

1 Power Supply

5 Interface Trunking

Lot System Installation and Maintenance

g. E911 Service for Jackson County, Florida

1) General

a) This tariff is for E911 service for Jackson County and service is provided under this tariff and the "Agreement to Furnish Emergency Reporting Telephone Service" signed July 28, 1992, and agreed to by the Board of County Commissioners and Embarq Florida, Inc. (Central Telephone Company of Florida).

GENERAL EXCHANGE TARIFF

Embarq Florida, Inc.

By: F. B. Poag  
Director

SECTION A10  
Second Revised Sheet 63  
Cancelling First Revised Sheet 63  
Effective: July 14, 2001

N11 SERVICES

A. E911 EMERGENCY REPORTING SERVICES (Cont'd)

2. CENTRAL TELEPHONE EXCHANGES (Cont'd)

g. E911 Service for Jackson County, Florida (Cont'd)

1) General (Cont'd)

- b) The E911 system shall provide the services and features as shown following. System additions, modifications, or removals of service components shall be made by the Company at the customer's request. Such changes shall be made at the Company's prevailing rates at the time the request is made. Rates for new service shall be developed on an individual case basis.
- c) The Company will furnish an employee who will act as E911 coordinator for the ongoing administration of E911 data management associated with the E911 Service, pursuant to the terms of an Agreement for Data Base Administration Services entered into by the Company and the Jackson County Board of County Commissioners on July 28, 1992.
- d) Costs incurred by the Company for services requested by the customer over and above those specified in this tariff shall be charged, as incurred, to the customer on a time and materials basis.
- e) The customer agrees to limit the use of utility provided information regarding its telephone subscribers, including names, addresses, and telephone numbers, to the strict performance of the customer's assigned responsibilities as a public agency under the terms of the Agreement.

GENERAL EXCHANGE TARIFF

Embarq Florida, Inc.

By: F. B. Poag  
Director

SECTION A10  
Second Revised Sheet 64  
Cancelling First Revised Sheet 64  
Effective: July 14, 2001

N11 SERVICES

A. E911 EMERGENCY REPORTING SERVICES (Cont'd)

2. CENTRAL TELEPHONE EXCHANGES (Cont'd)

g. E911 Service for Jackson County, Florida (Cont'd)

1) General (Cont'd)

f) The contract period for this service is twelve months and shall automatically renew for successive periods of one year. In the event the customer shall give notice of its intention not to renew prior to the tenth one year anniversary of the agreement date; the customer shall pay as liquidated damages and not as a penalty, the amounts set forth in Section 16 of that certain agreement to furnish emergency reporting telephone service (the "E911 Agreement").

2) Maintenance and Repairs

a) The Company will provide maintenance for the E911 system throughout the lifetime of the contract. The rates shown following cover the costs of a maintenance contract. This maintenance excludes repairs or replacements made necessary by misuse, negligence, accident, theft or unexplained loss, abuse, connection to foreign electric current, fire, water, flood, wind, storms, lightning, any act of God or public enemy, failure to provide a suitable operating environment, unauthorized attachments or modification, or improper software changes, wiring, installation, repair or alteration by anyone other than the Company. The Company may perform repairs necessitated by any excluded cause of customer's request at the Company's then prevailing rates.

GENERAL EXCHANGE TARIFF

Embarq Florida, Inc.

By: F. B. Poag  
Director

SECTION A10  
Second Revised Sheet 65  
Cancelling First Revised Sheet 65  
Effective: July 14, 2001

N11 SERVICES

A. E911 EMERGENCY REPORTING SERVICES (Cont'd)

2. CENTRAL TELEPHONE EXCHANGES (Cont'd)

g. E911 Service for Jackson County, Florida (Cont'd)

2) Maintenance and Repairs (Cont'd)

- b) The Company will respond to requests to perform services for any malfunction of the system, including station or trunk failure, (Regular Service) within the Company's next business day after receipt of notice from the customer requesting such service. The company will respond to requests to perform service for a total system failure of the system ("Emergency Service") within four (4) hours of receipt of notice from the customer requesting such service.
- c) "Emergency Service" will be provided only for system failures resulting in the following:
  - (1) Total 911 system failure
  - (2) Partial 911 system failure affecting call processing to one or more PSAP's or service agencies
  - (3) An individual PSAP cannot receive calls at any one position
  - (4) An individual PSAP cannot transfer calls at any one position.
  - (5) Facilities failure that prevents an individual central office from reaching a PSAP

GENERAL EXCHANGE TARIFF

Embarq Florida, Inc.

By: F. B. Poag  
Director

SECTION A10  
Second Revised Sheet 66  
Cancelling First Revised Sheet 66  
Effective: July 14, 2001

N11 SERVICES

A. E911 EMERGENCY REPORTING SERVICES (Cont'd)

2. CENTRAL TELEPHONE EXCHANGES (Cont'd)

g. E911 Service for Jackson County, Florida (Cont'd)

2) Maintenance and Repairs (Cont'd)

c) "Emergency Service" will be provided only for system failures resulting in the following (Cont'd)

(6) No ANI at one PSAP - all positions

(7) No ALI at one PSAP - all positions

(8) ALI system failure - all PSAPs

(9) No ability to make a hard copy of ANI/ALI information at a primary PSAP.

d) The Company and its duly authorized agents and employees shall have the right of ingress and egress where said facilities are installed for the purpose of inspecting, maintaining, and repairing said facilities and for all other purposes necessary to the performance of this tariff and Agreement.

3) Rates and Charges

a) Authorized Agencies "PSAP Service"

(1) Jackson County Sheriff's Office (Primary)

(2) Marianna Police Department (Secondary)

b) Nonrecurring Charge

E911 Equipment and Data Base \$128,000.00

GENERAL EXCHANGE TARIFF

Embarq Florida, Inc.

By: F. B. Poag  
Director

SECTION A10  
Second Revised Sheet 67  
Cancelling First Revised Sheet 67  
Effective: July 14, 2001

N11 SERVICES

A. E911 EMERGENCY REPORTING SERVICES (Cont'd)

2. CENTRAL TELEPHONE EXCHANGES (Cont'd)

g. E911 Service for Jackson County, Florida (Cont'd)

3) Rates and Charges (Cont'd)

c) Monthly Recurring Charges

(1) Equipment Charges	\$ 2,205.00
(2) Data Base Administration	960.00
(3) Network Service Charges	Charges for lines and trunks are included in other sections of this tariff.

4) Contract Equipment and Features

The following listed equipment and features are covered under the rates shown previously.

ITEM

Primary PSAP - 3 positions

Telepak ANI Standard System  
Basic Telepak Standard System with -  
3 Operator Consoles  
Trunk Expansion Bay-35 trunks  
Incoming Trunk Circuit Cards  
Incoming Trunk Circuit Panels  
ERA Circuit Cards-Dial  
Matrix Expansion Cards-IC  
ALI Interface-PSAP

GENERAL EXCHANGE TARIFF

Embarq Florida, Inc.

By: F. B. Poag  
Director

SECTION A10  
Second Revised Sheet 68  
Cancelling First Revised Sheet 68  
Effective: July 14, 2001

N11 SERVICES

A. E911 EMERGENCY REPORTING SERVICES (Cont'd)

2. CENTRAL TELEPHONE EXCHANGES (Cont'd)

g. E911 Service for Jackson County, Florida (Cont'd)

4) Contract Equipment and Features (Cont'd)

The following listed equipment and features are covered under the rates shown previously. (Cont'd)

ITEM

Telepak ANI Standard System (Cont'd)

Radio Transfer Switch  
Telepak ANI Site Spare Package

ALI Computer System

HP Series 927LX system with  
-24 Mb Memory  
-670 MB Disk Drive  
-Digital Data Cartridge Tape System  
-System Console Terminal  
-20 User MPE-XL License  
1.3 Gb DAT Tapes  
DTC for MPE XL Systems-48 port  
6 RS232 Modem Ports-25 pin  
HP 700/92 Terminal-Green  
Terminal Cable  
200 cps Dot Matrix Printer  
Printer Cable  
Printer Ribbons (3)  
Design Plus Floor Stand  
MultiTech 2400 bps Modem with MNP/5  
MultiTech 2400 bps Rack Modem with MNP/5  
MultiTech Modem Rack (holds 16 modems)  
MultiTech Modem Rack Power Supply  
Serial Data Cable-25'  
ALI software License-Level 2



GENERAL EXCHANGE TARIFF

Embarq Florida, Inc.

By: F. B. Poag  
Director

SECTION A10  
Second Revised Sheet 69  
Cancelling First Revised Sheet 69  
Effective: July 14, 2001

N11 SERVICES

A. E911 EMERGENCY REPORTING SERVICES (Cont'd)

2. CENTRAL TELEPHONE EXCHANGES (Cont'd)

g. E911 Service for Jackson County, Florida (Cont'd)

4) Contract Equipment and Features (Cont'd)

The following listed equipment and features are covered under the rates shown previously. (Cont'd)

ITEM

ALI Computer System (Cont'd)  
PC-HP3000 Interface Software

Power Supplies, Battery Backup, and UPS Units

48 vdc Power Supply/Battery Backup includes:

- Battery Pack 48 vdc 50 ah
- Rectifier 48 vdc 30
- Rack, Covers, Ground Bar
- distr Fuses, alarm panel

Best 850 VA UPS

## GENERAL EXCHANGE TARIFF

Embarq Florida, Inc.

By: F. B. Poag  
Director

SECTION A10  
First Revised Sheet 69.1  
Cancelling Original Sheet 69.1  
Effective: June 11, 2004

### N11 SERVICES

#### A. E911 EMERGENCY REPORTING SERVICES (Cont'd)

##### 3. WIRELESS E911 PHASE 2

###### a. Description of Service

Wireless E911 Phase 2 is only available in combination with E911 as specified in this section of the tariff and is subject to the regulations specified herein.

In accordance with the FCC's Report and Order 94-102, Wireless E911 Phase 2 provides PSAPs with the wireless E911 caller's location and callback number (CBN) information, as specified by the FCC. The FCC has adopted specific handset-based and network-based location accuracy and reliability solutions standards for the Wireless Service Providers (WSPs).

###### b. General Regulations

- 1) The Company is not responsible for the location determination technology, the accuracy of the location determination technology, or the investigation or maintenance of said technologies. Only the data required and specified by the FCC in its Report and Order 94-102 will be delivered by the Company to the PSAP. This required data includes the cell site or sector location, the callback number, and the latitude/longitude of the caller. Each customer agrees that delivery, or lack of delivery, of additional data elements which may be provided by the WSP will not be the responsibility of the Company and the Company assumes no responsibility or liability for such information.
- 2) PSAPs must have all required elements of Wireless E911 Phase 1, utilizing p-ANI routing and cell site/sector location based information, in place before implementing Phase 2. This is necessary to accommodate loading of the respective p-ANIs also known as Emergency Service Routing Key/Emergency Service Routing Digit into the Company's Database Management System. In addition, the following requirements must be met for Phase 2 implementation:
  - a) PSAPs must order both the Company's Extended ALI Display Format and the ALI Database Upgrade for Wireless Phase 2 to accommodate the x/y data provided by Wireless E911 Phase 2 Service. See rates in 3.F. following.
  - b) WSPs must have Position Determining Entity (PDE) and a Mobile Position Center (MPC)/Gateway Mobile Location Center (GMLC) in their network.
  - c) WSPs or their designated database provider must have obtained an interface to the Company's ALI database that complies with the Company's existing operating standard. This interface will be used by the WSP to provide the Phase 2 data.

## GENERAL EXCHANGE TARIFF

Embarq Florida, Inc.

By: F. B. Poag  
Director

SECTION A10  
First Revised Sheet 69.2  
Cancelling Original Sheet 69.2  
Effective: June 11, 2004

### N11 SERVICES

#### A. E911 EMERGENCY REPORTING SERVICES (Cont'd)

##### 3. WIRELESS E911 PHASE 2 (Cont'd)

###### c. Definition of Terms

###### 1) Callback Number (CBN)

The wireless caller's 10-digit handset telephone number. The CBN is used by the PSAP to reestablish a call in the event the call was prematurely disconnected.

###### 2) Interface

A reference point for a data path that exists between an MPC/GMLC and an ESME (the ALI database). The data that traverses the interface is made up of an Emergency Services Position Request and the response. The interface is not provided by and is not the responsibility of the Company.

###### 3) Emergency Services Message Entity (ESME)

An entity in the emergency services network which serves as the point of interface to an MSC for common channel emergency services messaging. ESME is another term for the ALI database.

###### 4) Enhanced MF Signaling (EMFS)

A signaling protocol for sending 10 or 20 digits of ANI from the 911 Tandem to the PSAP. EMF signaling is required when an interconnecting WSP selects Phase 2 NCAS mode without WLS911.

###### 5) Mobile Position Center (MPC)

The interface between the wireless network and the Company's ALI database. The MPC serves as the wireless network entity which retrieves, forwards, stores, and controls position data within the wireless location network. The MPC is not provided by and is not the responsibility of the Company. Global System for Mobile (GSM) communication Gateway Mobile Location Centers (GMLCs) will be treated as MPCs by the Company.

###### 6) Mobile Switching Center (MSC)

The wireless equivalent of a Central Office, which provides switching functions for wireless calls. The MSC is not provided by and is not the responsibility of the Company.

###### 7) Phase 2 NCAS

In this mode the p-ANI and the CBN both are sent to the Selective Router. The trunk between the Selective Router and the PSAP must support transport of at least two 10-digit numbers.

GENERAL EXCHANGE TARIFF

Embarq Florida, Inc.

By: F. B. Poag  
Director

SECTION A10  
First Revised Sheet 69.3  
Cancelling Original Sheet 69.3  
Effective: June 11, 2004

N11 SERVICES

A. E911 EMERGENCY REPORTING SERVICES (Cont'd)

3. WIRELESS E911 PHASE 2 (Cont'd)

c) Definition of Terms (Cont'd)

8) Position Determining Entity (PDE)

The PDE determines the geographic location of a wireless handset when the wireless caller places a 911 call or while the call is in process. The PDE is not provided by and is not the responsibility of the Company.

9) Pseudo-ANI (P-ANI)

A pseudo, non-dialable telephone number assigned to a cell site or a sector of a cell site to provide location identification for wireless E911 calls.

10) WLS911

The Company solution that sends either eight or ten digits of ANI to the PSAP and dynamically updates the static cell site or sector information with the CBN as provided by the WSP. This solution when used in conjunction with a WSP's interface allows WSPs to comply with the FCC's order without requiring PSAPs to upgrade their PSAP equipment to utilize Enhanced MF signaling.

11) Wireless Service Provider (WSP)

A person or entity that provides Commercial Mobile Radio Service (CMRS). The term wireless includes service provided by any wireless real-time, two-way voice communication device, including radio-telephone communications used in cellular telephone service, personal communication service (PCS), or functional or competitive equivalent. The term does not include service providers whose customers do not have access to 911 or 911-like services.

12) Wireline Compatibility Mode

Occurs when the WSP sends only p-ANI to the Company E911 tandem and the PSAP receives eight or ten digits of ANI.

13) X,Y Coordinates

The latitude and longitude of the 911 wireless caller's location.

## GENERAL EXCHANGE TARIFF

Embarq Florida, Inc.

By: F. B. Poag  
Director

SECTION A10  
First Revised Sheet 69.4  
Cancelling Original Sheet 69.4  
Effective: June 11, 2004

### N11 SERVICES

#### A. E911 EMERGENCY REPORTING SERVICES (Cont'd)

##### 3. WIRELESS E911 PHASE 2 (Cont'd)

###### d) Enhanced MF

Enhanced MF (EMF) is a new signaling protocol from the 911 Tandem to the PSAP. Enhanced MF accommodates either ten or 20 digits of ANI. Enhanced MF is not a requirement of Wireless Phase 2 implementation but EMF must be used by PSAPs when an interconnecting Wireless Service Provider chooses the Phase 2 NCAS Mode (as defined in J-STD-036 Annex D, Table D.1.2. and/or D.2.), without WLS911. If an interconnecting WSP chooses a Phase 2 NCAS solution without WLS911, the PSAP's equipment must be 20-digit Enhanced MF capable. The PSAP must request the Company convert them to EMF signaling when preparing to accept Phase 2 calls from a WSP utilizing Phase 2 NCAS without WLS911. Once a PSAP has been converted to 20 digit EMF Signaling the functionality of WLS911 is disabled for all WSPs serving that PSAP.

###### e) Wireless E911 Phase 2 Service

This service is comprised of two components, Extended ALI Display Format and ALI Database Upgrade for Wireless Phase 2. Both components are required for implementation of this service.

###### 1) Extended ALI Display Format

The PSAP's Automatic Location Identification (ALI) display format must be changed to the Company's Extended ALI Display Format to accommodate the latitude and longitude, or x,y coordinates. The provision and delivery of the x,y information to the PSAP requires an interface between the ALI database and the WSP's Mobile Position Center (MPC)/Gateway Mobile Location Center (GMLC). The provisioning of the interface is the responsibility of the WSP.

###### 2) ALI Database Upgrade for Wireless Phase 2

The ALI Database Upgrade for Wireless Phase 2 enables the PSAP to query and retrieve wireless caller location information from the Company's Automatic Location Identification (ALI) database. Location information may include cell site sector location, longitude and latitude of the wireless caller's location, and the wireless caller's callback number (CBN). This upgrade will enable the necessary interfaces, software, and databases to permit the wireless caller's location information to be populated in the Company's ALI database and/or retrieved when queried by the customer's PSAP equipment.

GENERAL EXCHANGE TARIFF

Embarq Florida, Inc.

By: F. B. Poag  
Director

SECTION A10  
First Revised Sheet 69.5  
Cancelling Original Sheet 69.5  
Effective: June 11, 2004

N11 SERVICES

A. E911 EMERGENCY REPORTING SERVICES (Cont'd)

3. Wireless E911 Phase 2 (Cont'd)

f) Rates and Charges

	Nonrecurring Charge	Monthly Rate	SAE Code
1) Enhanced MF signaling, per PSAP	\$0.00	\$0.00	-
2) Extended ALI Display Format, per PSAP	\$3,500.00	\$0.00	-
3) ALI Database Upgrade for Wireless Phase 2, per PSAP	\$0.00	\$250.00	AEMDATA (WLS)

## GENERAL EXCHANGE TARIFF

Embarq Florida, Inc.

By: F. B. Poag  
Director

SECTION A10  
First Revised Sheet 69.6  
Cancelling Original Sheet 69.6  
Effective: December 2, 2005

### N11 SERVICES

#### A. E911 EMERGENCY REPORTING SERVICES (Cont'd)

##### 4. Private Switch Database Service

###### a. Description of Service

- 1) Private Switch Database Service is available to companies that use a Private Branch Exchange (PBX) or Centrex to manage their individual telephones and want to provide specific location information for each of these telephones to the Public Safety Answering Point (PSAP) responsible for responding to an emergency.
- 2) Private Switch Database Service allows a customer with a multi-line private switch to facilitate reception of either (1) Automatic Number Identification (ANI) or (2) a combination of ANI and Automatic Location Identification (ALI) information by a PSAP for emergency "9-1-1" calls originating from the location served by the customer's multi-line private switch. A private switch is customer premises equipment (CPE) at the end user customer's location.

###### b. General Regulations

- 1) The customer is responsible for validating address information through Master Street Access Guide (MSAG) and for coordinating with the Company to provide the National Emergency Number Association (NENA) standard format of telephone numbers and address data. The Company will allow the customer to update records no more frequently than on a daily basis. The data may originate from the customer's private switch, when technically feasible, or from a manually created list.
- 2) The Company will:
  - a) Be responsible for uploading a NENA formatted data file to its ALI database;
  - b) Hold the information in confidence and protect it in accordance with state and federal rules applicable to emergency 911 services; and
  - c) Use the information only in connection with providing emergency services to PSAPs.
- 3) The Company may immediately terminate a customer's use of Private Switch Database Service if, in the Company's sole judgment, the customer falsifies the information provided or fails to comply with any other provisions of this tariff.
- 4) The Company will only provide Private Switch Database Service where the Company is the primary 911 database provider for the PSAP serving the customer's location
- 5) The Company will provide a software package that will allow the customer to load the database information in the appropriate NENA format for transmission to the Company's data center
- 6) The Company will charge the private switch customer a monthly recurring charge for maintenance of the data in the national ALI database for delivery upon a 911 call to the PSAP.

GENERAL EXCHANGE TARIFF

Embarq Florida, Inc.

By: F. B. Poag  
Director

SECTION A10  
First Revised Sheet 69.7  
Cancelling Original Sheet 69.7  
Effective: December 2, 2005

N11 SERVICES

A. E911 EMERGENCY REPORTING SERVICES (Cont'd)

4. Private Switch Database Service (Cont'd)

c. Limitations

- 1) The Company offers no warranty or representation with respect to the accuracy or completeness of the Private Switch Database Service. The Company relies on its customers for all private switch information placed in the Company's database management system.
- 2) The Company does not warrant or represent that its database management system will be compatible with every type of private switch equipment. Customers who wish to provide automated updates to the Company's database management system are responsible for acquiring their own private switch equipment and for testing the compatibility of that equipment with the Company's database management system.

d. Obligations of the Customer

- 1) When implementing Private Switch Database Service, the customer must contact the Telephone Company's E-911 representative to negotiate trunking, hardware and software requirements associated with the Private Switch Database Service.
- 2) The customer will be responsible for loading address information into the Private Switch Database Service software package and transmitting that information to the Telephone Company.



GENERAL EXCHANGE TARIFF

Embarq Florida, Inc.

By: F. B. Poag  
Director

SECTION A10  
First Revised Sheet 69.8  
Cancelling Original Sheet 69.8  
Effective: December 2, 2005

N11 SERVICES

A. E911 EMERGENCY REPORTING SERVICES (Cont'd)

4. Private Switch Database Service (Cont'd)

e. Rates and Charges

1) Private Switch Database Service rates

	<u>Nonrecurring Charge</u>
a) Installation	
(1) Initial Installation	\$900.00
(2) Subsequent addition of Station Records	0.00
	<u>Monthly Recurring Charge</u>
b) Monthly Rate <sup>1</sup>	
(1) Up to 1000, per 1000 Station Records	\$100.00
(2) 1001 - 4000, per 1000 Station Records	70.00
(3) Over 4000, per 1000 Station Records	60.00

2) Separate charges, not specified in this section of the tariff, are applicable for network connectivity from the customer's private switch to the Company's central office facilities.

3) Each Private Switch Database Service customer's Installation Charge and Monthly Rate is calculated at the time Private Switch Database Service is established and is based on the number of station records in service for the customer. The total number of station records are audited annually by the Telephone Company and applied to the account.

<sup>1</sup> The Monthly Rate is calculated based on the total number of station records submitted by the customer at installation or at the time of the annual audit. For example, 900 station records = \$100 MRC; 3900 station records = \$70 X 4 = \$280 MRC; 4500 station records = \$60 X 5 = \$300 MRC.

GENERAL EXCHANGE TARIFF

Embarq Florida, Inc.

By: F. B. Poag  
Director

SECTION A10  
First Revised Sheet 69.9  
Cancelling Original Sheet 69.9  
Effective: December 2, 2005

N11 SERVICES

A. E911 EMERGENCY REPORTING SERVICES (Cont'd)

5. Reverse Notification Telephone Number Database Service

a. Description of Service

- 1) The Company offers Reverse Notification Telephone Number Database Service (Reverse Database Service) to support the ability of Public Safety Answering Points (PSAPs) to make broadcast notification calls to areas under their jurisdiction in the event of emergencies.

b. General Regulations

- 1) Reverse Database Service is offered solely for the purpose of permitting PSAPs to make broadcast notifications to particular geographic areas and associated local telephone numbers in the event of emergencies. PSAPs ordering Reverse Database Service must provide the Company with written certification of their authority to make public emergency notifications.
- 2) PSAPs may not use Reverse Database Service information in connection with E911 Emergency Reporting Services.
- 3) PSAPs subscribing to Reverse Database Service will receive CD-ROM downloads of information from the Company's Automatic Location Indicator (ALI) database. The Company will provide ten-digit telephone numbers, associated addresses, and names to the extent that information is present in the Company's ALI database.
- 4) Reverse Database Service will include ALI information obtained by the Company from other local exchange carriers serving a PSAP's jurisdiction, when there are multiple local exchange carriers in a PSAP's jurisdiction. Reverse Database Service will include ALI information obtained from customers who operate private switches and have requested that carriers maintain appropriate information in the carrier's ALI database.
- 5) The Company will provide Reverse Database Service only for the jurisdictional area where a PSAP is authorized to provide emergency services. PSAPs will not be able to obtain foreign listings, foreign exchange cross-listings, foreign central office subscriptions, and multiple listings through Reverse Database Service.

GENERAL EXCHANGE TARIFF

Embarq Florida, Inc.

By: F. B. Poag  
Director

SECTION A10  
First Revised Sheet 69.10  
Cancelling Original Sheet 69.10  
Effective: December 2, 2005

N11 SERVICES

A. E911 EMERGENCY REPORTING SERVICES (Cont'd)

5. Reverse Notification Telephone Number Database Service (Cont'd)

b. General Regulations (Cont'd)

- 6) The Company considers all information provided to a PSAP under Reverse Database Service to be confidential and proprietary. Information received through Reverse Database Service may contain the names, addresses and telephone numbers of individuals whose listings are not published in directories and/or are not listed in directory assistance databases. The PSAP must:
  - a) Hold all Reverse Database Service information in confidence and protect it in accordance with the security regulations by which it protects its own proprietary or confidential information;
  - b) Restrict disclosure of the information solely to those PSAP employees and/or agents with a need to know and not disclose or resell such information to any other parties;
  - c) Use the information only when delivering broadcast notifications of emergencies; and
  - d) Notify the Company immediately of any confirmed or suspected misuse of Reverse Database Service information.
- 7) The PSAP represents and warrants that it will use information received through Reverse Database Service only in emergency situations. A PSAP may not access, use, import, export, copy, print, distribute or release information for any purpose other than what is necessary to make outbound telephone emergency notifications.
- 8) The Company may immediately terminate a PSAP's use of Reverse Database Service and demand the return of all Reverse Database Service information furnished to the PSAP if, in the Company's judgment, the PSAP misuses the information provided or fails to comply with any other provision of this tariff.
- 9) A PSAP's modification, merger or enhancement of information received through the Reverse Database Service will not relieve the PSAP from any provision of this tariff.

GENERAL EXCHANGE TARIFF

Embarq Florida, Inc.

By: F. B. Poag  
Director

SECTION A10  
First Revised Sheet 69.11  
Cancelling Original Sheet 69.11  
Effective: December 2, 2005

N11 SERVICES

A. E911 EMERGENCY REPORTING SERVICES (Cont'd)

5. Reverse Notification Telephone Number Database Service (Cont'd)

c. Limitations

- 1) The Company offers no warranty or representation with respect to the accuracy or completeness of the Reverse Database Service. The Company may rely on other local exchange carriers or private switch customers for certain information used in the Reverse Database Service.
- 2) The Company does not warrant or represent that the Reverse Database Service will be compatible with every type of reverse notification equipment. PSAPs are responsible for acquiring their own broadcast notification equipment and for testing the compatibility of that equipment with the Reverse Database Service.
- 3) By offering Reverse Database Service, the Company makes no warranties or representations for the operation of customer's broadcast notification equipment or for the availability or performance of any telephone network facilities, including the Company's facilities, during a broadcast notification.

d. Liability of the Company

- 1) By subscribing to Reverse Database Service, a PSAP agrees to hold harmless and indemnify the Company, along with its employees, directors, officers, agents, and subcontractors, from and against all claims or suits arising out of or resulting from the provision of Reverse Database Service, specifically including, but not limited to, all claims or suits resulting from or allegedly resulting from errors or omissions in the file or the use of such information by the PSAP or its agents.
- 2) To the extent that the PSAP claims sovereign immunity or other statutory limitations against third party claims, the PSAP will extend that same protection to the Company in connection with the PSAP's use of the Reverse Database Service.

GENERAL EXCHANGE TARIFF

Embarq Florida, Inc.

By: F. B. Poag  
Director

SECTION A10  
First Revised Sheet 69.12  
Cancelling Original Sheet 69.12  
Effective: December 2, 2005

N11 SERVICES

A. E911 EMERGENCY REPORTING SERVICES (Cont'd)

5. Reverse Notification Telephone Number Database Service (Cont'd)

e. Rates and Charges

- 1) PSAPs can purchase Reverse Database Service in the following formats:
  - a) One-time update – The customer purchases one CD-ROM update and pays a nonrecurring charge.
  - b) Monthly update – The customer purchases monthly CD-ROM updates and pays a monthly recurring charge. The customer commits to purchasing the CD-ROM for a minimum of twelve consecutive months. Should the customer terminate service prior to the twelfth month, the customer will be billed for any remaining months to fulfill the twelve-month minimum.

	Nonrecurring <u>Charge</u>	Monthly <u>Rate</u>
2) Reverse Database Service,		
a) One-time update (CD-ROM)	\$1,200.00	\$ 0.00
b) Monthly update (CD-ROM) 12 Month Term	0.00	500.00

GENERAL EXCHANGE TARIFF

Embarq Florida, Inc.

By: F. B. Poag  
Director

SECTION A10  
First Revised Sheet 70  
Cancelling Original Sheet 70  
Effective: July 14, 2001

N11 SERVICES

B. 711 SERVICE FOR TELECOMMUNICATIONS RELAY SERVICES (TRS)

1. General

- a. 711 Dialing Code ("711") is a three digit local dialing arrangement for telephone voice transmission access to all certified Telecommunications Relay Services entities as a toll free call. Pursuant to Order 00-257, issued by the Federal Communications Commissions (FCC) in CC Docket 92-105, the FCC assigned 711 dialing code for nationwide access to Telecommunications Relay Services (TRS) entities, to be implemented not later than October 1, 2001.
- b. 711 is available the Company within the Company's service area only. To provide access to 711 to end users in another company service area or to a Competitive Local Exchange Carrier (CLECs) end users within the local calling area, the TRS entity must make appropriate arrangements with the other company or CLEC serving that territory. The TRS entity should work separately with competing local providers to ascertain that its end user customers will be able to reach relay services provided by dialing 711.
- c. This service is subject to the availability of the 711 dialing code.
- d. 711 can be delivered via regular exchange access lines (by individual business lines, PBX trunks, etc.).
- e. Limitations and use of service are as stated in Section A2 of this Tariff.
- f. Directory Listings may be provided for 711 at rates and regulations as specified in Section A6 of this Tariff.
- g. Access to 711 is not available to the following classes of service:
  - Hotel/Motel/Hospital Service (toll call only)
  - 1+
  - 0+, 0- (Credit Card, Third-Party Billing, Collect Calls)
  - Inmate Service
  - 101XXXX
  - Cellular - Type 2AIn addition, operator assisted calls to 711 will not be completed.

GENERAL EXCHANGE TARIFF

Embarq Florida, Inc.

By: F. B. Poag  
Director

SECTION A10  
First Revised Sheet 71  
Cancelling Original Sheet 71  
Effective: July 14, 2001

N11 SERVICES

B. 711 SERVICE FOR TELECOMMUNICATIONS RELAY SERVICES (TRS) (Cont'd)

2. Obligations of the TRS Entity

- a. The TRS entity must, prior to provisioning of the service, sign a written acknowledgement of possible recall of the 711 dialing code by the FCC and an agreement to return the code upon receipt of 6 months written notice of such a recall from the Company or regulating entity and abide by all terms and conditions which may be identified by the FCC in CC Docket 92-105 regarding the use and return of the 711 dialing code. If a recall is affected, the Company will work with the TRS entity affected by such recall to transfer their service arrangements, to a 7 or 10-digit dialing arrangement within the 6-month notice period. The TRS entity will be required to migrate to any access arrangement the telecommunications relay services subsequently agreed to by the industry and approved by the FCC. The TRS entity will be charged the appropriate tariff rates for the establishment of the new access arrangement.
- b. The TRS entity should work separately with wireless companies to ascertain their end user customers will be able to reach telephone relay services provided by dialing 711.
- c. The TRS entity should work separately with competitive local exchange companies to ascertain their end user customers will be able to reach telephone relay services provided by dialing 711.
- d. The TRS entity is restricted from selling or transferring the 711 dialing code to an unaffiliated entity, either directly or indirectly.
  - 1) An "affiliate" of a TRS entity is any entity that directly, or indirectly through one or more intermediaries, controls, is controlled by, or is under common control with the TRS entity. The term "control" (including the terms "controlling," "controlled by," and "under common control with") means the possession, direct or indirect, of the power to direct or cause the direction of the management and policies of an entity, whether through the ownership of voting securities, by contract, or otherwise.

GENERAL EXCHANGE TARIFF

Embarq Florida, Inc.

By: F. B. Poag  
Director

SECTION A10  
First Revised Sheet 72  
Cancelling Original Sheet 72  
Effective: July 14, 2001

N11 SERVICES

B. 711 SERVICE FOR TELECOMMUNICATIONS RELAY SERVICES (TRS) (Cont'd)

2. Obligations of the TRS Entity (Cont'd)

- e. The 711 Dialing Code will be provided by the Company to the TRS entity under the following conditions:
  - 1) For network sizing and protection, the TRS entity must provide an estimate of annual call volumes, the expected busy hour and the expected holding time for each call to the 711 dialing code.
  - 2) The TRS entity will subscribe to adequate telephone facilities initially and subsequently as may be required, in the judgment of the Company, to adequately handle calls to 711 without impairing the Company's general telephone service or telephone facilities.
  - 3) The TRS entity is responsible for obtaining all necessary permission, licenses, written consents, waivers, releases and all other rights from all persons whose work, statements or performance are used in connection with the 711 dialing code, and from all holders of copyrights, trademarks, and patents used in connection with said service.
- f. If a pre-recorded announcement is provided by the TRS entity, the following conditions apply:
  - 1) The TRS entity will provide announcements. The company will provide only the delivery of the call.
  - 2) The provision of access to the 711 network by the Company for the transmission of announcement is subject to availability of such facilities and the requirements of the local exchange network.
  - 3) The TRS entity assumes all financial responsibility for all costs involved in providing announcement including, but not limited to, the recorder-announcement equipment located on the TRS entity's premises.
  - 4) The TRS entity assumes, according to other specific rates and charges under tariff, all financial responsibility for all facilities required, to connect the recorder-announcement equipment located on the TRS entity's premises.



GENERAL EXCHANGE TARIFF

Embarq Florida, Inc.

By: F. B. Poag  
Director

SECTION A10  
First Revised Sheet 73  
Cancelling Original Sheet 73  
Effective: July 14, 2001

N11 SERVICES

B. 711 SERVICE FOR TELECOMMUNICATIONS RELAY SERVICES (TRS) (Cont'd)

3. Obligations of the Company

- a. Once the 711 Dialing Code has been assigned and the subscriber has provided the Company the appropriate toll free number, implementation of the 711 Dialing Code will begin on or after July 16, 2001. The Company will implement the TRS entity's request within a reasonable time, given the complexity of the order.

If, during or at the end of the provisioning period, the TRS entity has failed to establish service or decides to discontinue service establishment, the 711 code will be recalled and the number will be considered available for reassignment.

- b. When a 711 Service call is placed by the calling party via interconnection with an interexchange carrier, the Company cannot guarantee the completion of said 711 Service call, the quality of the call or any features that otherwise may be provided with 711 dialing service.

4. Obligations of the Competitive Local Exchange Carrier (CLEC)

- a. In those instances where a CLEC provides the 711 dialing code to its end user within the local calling area, terms and conditions for 711 dialing code are as defined in the appropriate Interconnection Agreement.
  - 1) For purposes of providing a CLEC end user access to the TRS entity within the local calling area, appropriate arrangements must be made by the CLEC with the TRS entity serving the local calling area.
  - 2) A CLEC may negotiate the provision of directory listing as defined in the Interconnection Agreement.

GENERAL EXCHANGE TARIFF

Embarq Florida, Inc.

By: F. B. Poag  
Director

SECTION A10  
First Revised Sheet 74  
Cancelling Original Sheet 74  
Effective: July 14, 2001

N11 SERVICES

B. 711 SERVICE FOR TELECOMMUNICATIONS RELAY SERVICES (TRS) (Cont'd)

5. Liability

- a. The TRS entity is responsible for, and shall indemnify, protect, defend and save harmless the Company against all suits, actions, claims, demands and judgments, and of all costs, expenses and counsel fees incurred on account thereof, arising out of and resulting directly or indirectly from the service or in connection therewith, including, but not limited to, any loss, damage, expense or liability resulting from any infringement or claim of infringement, of any patent, trademark, copyright, or resulting from any claim of liable and slander. Unless otherwise specifically provided in this Tariff, the Company shall be authorized to disconnect any tariffed service provided to the TRS entity utilized, directly or indirectly, with the 711 dialing code, which fails to comply with regulations and conditions set forth herein, upon five (5) days of notice to the subscriber. Disconnection may be suspended at the discretion of the Company if it receives written certification that the TRS entity is in compliance with regulations and conditions of the tariffs. Continual noncompliance shall be cause for disconnection without notice at the discretion of the Company.
- b. The TRS entity shall respond promptly to any and all complaints lodged with any regulatory authority against any service provided via the 711 dialing code. If requested by the Company, the TRS entity shall assist the Company in responding to complaints made to the Company concerning the 711 dialing code.
- c. A written notice will be sent to any TRS entity following oral notification when their service unreasonably interferes with or impairs other services rendered to the public by the Company. If after notification the TRS entity makes no modification in method of operation or in the service arrangements that are deemed service-protective by the Company, or if the TRS entity is unwilling to accept the modifications, or if the TRS entity continues to cause service impairment, the Company reserves the right, at any time, without further notice, to institute protective measures, up to and including termination of service. In an emergency situation as defined by the Company, the Company reserves the right, at any time, without notice, to institute protective measures up to and including termination of service.
- d. The Company may take all legal and practical steps to disassociate itself from the TRS entity providing services whose business and/or public conduct (whether demonstrated or proposed) is of a type that in the Company's discretion generates unacceptable levels of complaints by end users.

GENERAL EXCHANGE TARIFF

Embarq Florida, Inc.

By: F. B. Poag  
Director

SECTION A10  
First Revised Sheet 75  
Cancelling Original Sheet 75  
Effective: July 14, 2001

N11 SERVICES

B. 711 SERVICE FOR TELECOMMUNICATIONS RELAY SERVICES (TRS) (Cont'd)

5. Liability (Cont'd)

- e. In no event shall the Company be liable for any losses or damages of any kind resulting from the unavailability of its equipment or facilities or for any act, omission or failure of performance by the Company, or its employees, or agents, in connection with this Tariff. The Company shall not be responsible for calls that cannot be completed as a result of repair or maintenance difficulties on Company facilities and equipment nor on equipment owned or leased by the TRS entity.

6. Other Terms and Conditions

- a. Only one 10-digit toll free number may be used as the lead number per basic local calling area.
- b. The 711 Dialing Code is provided where facilities permit.
- c. The 711 Service will not provide calling number information in real time to the TRS entity. If this type of information is required, the TRS entity must subscribe to compatible Caller ID Service as described in Section A13 of this Tariff.
- d. The 711 Service is provided solely for the benefit of the TRS entity. The provision of the 711 Service by the Company shall not be interpreted, constructed, or regarded, either expressly or implied, as being for the benefit of or creating any Company obligation toward any third person or legal entity other than the TRS entity.

7. Rates and Charges

- a. The 711 Service is ordered by the FCC to be provided without charge. Therefore, there are no rates or charges for the 711 Service.

GENERAL EXCHANGE TARIFF

Embarq Florida, Inc.

By: F. B. Poag  
Director

SECTION A10  
Second Revised Sheet 76  
Cancelling First Revised Sheet 76  
Effective: September 2, 2003

N11 SERVICES

C. 211 SERVICE FOR COMMUNITY INFORMATION AND REFERRAL SERVICES

1. General

- a. The 211 Dialing Code ("211") is a three-digit local dialing arrangement for local access to community information and referral services as a toll free call. Pursuant to Order 00-256, issued by the Federal Communications Commission (FCC) in CC Docket 92-105, the Florida Public Service Commission (FPSC) assigned the 211 Dialing Code for access to Local Community Information and Referral Service Agencies (Local Agencies) to be determined within each local exchange.
- b. The 211 Service allows a Company subscriber to access a Local Agency call center by dialing only the 211 Dialing Code.
- c. Subject to other terms and conditions of this Tariff, Company subscribers shall be able to make, and assigned Local Agencies shall be able to receive, calls using the 211 Dialing Code as part of their local exchange service. The 211 Dialing Code is supplemental to and is not a replacement for either party's local exchange service.
- d. All 211 Dialing Code calls shall be local in nature and shall not result in any Extended Calling Scope ("ECS"), TOLL PAC, Optional Extended Local Calling ("OELC"), Optional Extended Area Service ("OEAS"), intraLATA toll, interLATA long distance or pay-per-call charges to Company subscribers.
- e. 211 Dialing Code calls may result in local measured service charges where Company subscribers' service plans include such charges as part of home and EAS exchange calling.
- f. The 211 Service is not available for the following classes of service: inmate service, 1+ and 0+ calling, 0- operator assisted calling and 101XXXX calling. The 211 Service is otherwise available wherever local service is available.

## GENERAL EXCHANGE TARIFF

Embarq Florida, Inc.

By: F. B. Poag  
Director

SECTION A10  
First Revised Sheet 77  
Cancelling Original Sheet 77  
Effective: August 2, 2001

### N11 SERVICES

#### C. 211 SERVICE FOR COMMUNITY INFORMATION AND REFERRAL SERVICES (Cont'd)

##### 2. Obligations of the Local Community Information and Referral Services Agencies

- a. The Local Agencies shall make written application for the 211 Dialing Code to the Company at the local exchange level. The Local Agencies may establish the 211 Dialing Code in all, in part or in none of the Company's local exchanges.
- b. The Local Agency's written application to establish the 211 Dialing Code in a Company local exchange shall include the following:
  - 1) The local, foreign exchange, or toll free number into which the Company is to translate the dialed 211 code. If a Local Agency desires to change the telephone number into which the 211 Dialing Code is translated in an exchange, then the Local Agency shall make a new application.
  - 2) A location description of the Local Agency call center where 211 calls made from the Company local exchange will be routed.
  - 3) For network sizing and protection, an estimate of annual call volumes, the expected busy hour and holding time for each call to the 211 Dialing Code.
  - 4) An acknowledgement of the possibility that the FCC's designation of the 211 Dialing Code may be recalled at any time.
- c. Local Calling for Company Subscribers
  - 1) The Company, in cooperation with the Local Agencies, will make reasonable efforts to ensure that all 211 Dialing Code calls are local in nature and do not generate ECS, TOLL PAC, OELC, OEAS, intraLATA toll, interLATA long distance or pay-per-call charges for Company subscribers.
  - 2) When the Local Agencies make application for the 211 Dialing Code in a Company local exchange, Local Agencies shall supply the Company with a seven (7) or ten (10) digit telephone number that terminates within the Company local exchange or one of the local exchange's EAS exchanges. The Company's exchange facilities will translate the dialed 211 Dialing Code into the telephone number the Local Agency provides once 211 Dialing Code is established in the local exchange.
  - 3) When a Local Agency makes application for the 211 Dialing Code in a Company local exchange and a Local Agency call center is not located within the local exchange or one of the local EAS exchanges, then the Local Agency shall establish Foreign Exchange Service or supply the Company with a toll free telephone number so that Company subscribers' 211 Dialing Code calls remain local in nature.

GENERAL EXCHANGE TARIFF

Embarq Florida, Inc.

By: F. B. Poag  
Director

SECTION A10  
First Revised Sheet 78  
Cancelling Original Sheet 78  
Effective: August 2, 2001

N11 SERVICES

C. 211 SERVICE FOR COMMUNITY INFORMATION AND REFERRAL SERVICES (Cont'd)

2. Obligations of the Local Community Information and Referral Services Agencies (Cont'd)

- d. The Local Agencies shall be liable for and shall indemnify, protect, defend and hold harmless the Company against all suits, actions, claims, demands and judgments, plus any expenses and counsel fees incurred by the Company on account thereof, whether suffered, made, instituted or asserted by the Local Agency or any party or person, for any personal injury to or death of any person or persons, or for any loss, damage or destruction of any property, whether owned by the Local Agency or others, arising out of or resulting directly or indirectly from the 211 Dialing Code.
- e. The Local Agencies shall develop an appropriate method for responding to 211 calls directed to it out of confusion or in error by Company subscribers.
- f. The Local Agencies must be prepared to receive all calls to the 211 Dialing Code during normal business hours. To this end, the Local Agencies agree to subscribe to termination facilities and lines in sufficient quantities to provide adequate service to the public.
- g. The Local Agencies shall comply with all present and future rules pertaining to the 211 abbreviated dialing code, including any and all requirements to relinquish the 211 Dialing Code in the event of a national assignment contrary to that made by the FPSC.
- h. The Local Agencies are responsible for obtaining all necessary permissions, licenses, written consents, waivers and releases and all other rights from all persons whose work, statements or performances are used in connection with the 211 Dialing Code, and from all holders of copyrights, trademarks and patents used in connection with said service.
- i. The Local Agencies shall respond promptly to any and all complaints lodged with any regulatory authority against the 211 Dialing Code. If requested by the Company, the Local Agencies shall assist the Company in responding to complaints made to the Company concerning the 211 Dialing Code.
- j. The Local Agencies shall not promote the 211 Dialing Code with the use of an autodialer or broadcasting of tones that dial the 211 Dialing Code.
- k. The Company can only make the 211 Dialing Code available to end users located in Company local exchanges. To establish the 211 Dialing Code to end users in non-Company local exchanges, the Local Agencies must make appropriate arrangements with the companies serving those local exchanges, even where Company subscribers may make local calls to the non-Company local exchanges.
- l. The Local Agencies should work separately with Competitive Local Exchange Carriers ("CLEC") operating and serving customers in the Company's local exchanges to ascertain whether the 211 Dialing Code will be available to their end users.

## GENERAL EXCHANGE TARIFF

Embarq Florida, Inc.

By: F. B. Poag  
Director

SECTION A10  
First Revised Sheet 79  
Cancelling Original Sheet 79  
Effective: August 2, 2001

### N11 SERVICES

#### C. 211 SERVICE FOR COMMUNITY INFORMATION AND REFERRAL SERVICES (Cont'd)

##### 3. Obligations of the Company

- a. The Company shall provision the 211 Dialing Code within ninety (90) days of the Company's receipt of the Local Agencies' completed application(s) for service.
- b. When a 211 Dialing Code call is placed by the calling party via interconnection with an inter-exchange carrier, the Company cannot guarantee the completion of the 211 call, the quality of the call or any features that may otherwise be provided with 211 Dialing Code.
- c. The Company does not undertake to answer and forward 211 Service calls, but furnishes the use of its facilities to enable the Local Agencies to respond to such call at the Local Agencies' established call centers.
- d. The rates charged for the 211 Dialing Code do not contemplate the inspection or constant monitoring of facilities to discover errors, defects, and malfunctions in service, nor does the Company undertake such responsibility. The Local Agencies shall make such operational tests as, in the judgment of the Local Agencies, are required to determine whether the Company's facilities are functioning properly for its use. The Local Agencies shall promptly notify the Company in the event the Company's facilities are not functioning properly.

##### 4. Liability

- a. The liability of the Company for losses or damages of any kind arising out of mistakes, omissions, interruptions, delays or defects in transmission, or failure or defects in any facility furnished by the Company, occurring in the course of furnishing the 211 Dialing Code, or of the Company in failing to maintain proper standards of maintenance and operation or to exercise reasonable supervision, shall in no event exceed an amount equivalent to the proportionate charge to the Local Agencies for the 211 Dialing Code and local exchange services for the period of service during which such mistake, omission, interruption, delay, error or defect in transmission or defect or failure in facilities occurs.
- b. The Company has no liability for losses or damages caused by the negligence of the Local Agencies.
- c. The Company's entire liability to any person for interruption or failure of the 211 Dialing Code shall be limited to the terms set forth in this section and other sections of this Tariff.
- d. The FPSC's local assignment and the Local Agencies' use of the 211 Dialing Code are subject to preemption by the FCC. The Company shall not be liable to the Local Agencies for any damages the Local Agencies may incur that result from a national assignment of the 211 Dialing Code.

## GENERAL EXCHANGE TARIFF

Embarq Florida, Inc.

By: F. B. Poag  
Director

SECTION A10  
First Revised Sheet 80  
Cancelling Original Sheet 80  
Effective: August 2, 2001

### N11 SERVICES

#### C. 211 SERVICE FOR COMMUNITY INFORMATION AND REFERRAL SERVICES (Cont'd)

##### 5. Other Terms and Conditions

- a. The 211 Dialing Code will not provide calling number information in real time to the Local Agencies. If this type of information is required, the Local Agencies must subscribe to compatible Caller ID service as described in Section A13 of this Tariff.
- b. The 211 Dialing Code is provided solely for the benefit of the Local Agencies. The provision of the 211 Dialing Code by the Company shall not be interpreted, constructed or regarded, either expressly or implied, as being for the benefit of or creating any Company obligation toward any third person or legal entity other than the Local Agencies.
- c. A written notice will be sent to the Local Agency following oral notification when its 211 service unreasonably interferes with or impairs other services rendered to the public by the Company or by other subscribers of abbreviated dialing codes. If, after notification, the Local Agency makes no modification in method of operation or in the service arrangements that are deemed service-protective by the Company, or if the Local Agency is unwilling to accept the modifications, or if the Local Agency continues to cause service impairment, the Company reserves the right at any time, without further notice, to institute protective measures, up to and including termination of service.
- d. In an emergency situation as determined by the Company, the Company reserves the right, at any time, without notice, to institute protective measures, up to and including termination of service.

##### 6. Rates and Charges

- a. Subject to other terms and conditions of the Tariff, Company subscribers shall be able to make and Local Agencies shall be able to receive calls using the 211 Dialing Code as part of both parties' local exchange service. The 211 Dialing Code is supplemental to and is not a replacement for either party's local exchange service.
- b. The Local Agencies shall pay a nonrecurring Central Office Charge for each company host central office out of which the 211 Dialing Code is established.
  - 1) Some Company local exchanges are served by more than one host central office. In order to establish the 211 Dialing Code in such an exchange, the Local Agency shall pay a Central Office Charge for each host central office in the Company local exchange.
  - 2) Some host central offices serve more than one Company local exchange. If the Local Agency makes applications to establish the 211 Dialing Code in multiple Company local exchanges served by the same host central office, then only one Central Office Charge shall apply. However, the Local Agency shall pay the full Central Office Charge whether or not it requests the 211 Dialing Code in all the Company local exchanges served by the host central office.



GENERAL EXCHANGE TARIFF

Embarq Florida, Inc.

By: F. B. Poag  
Director

SECTION A10  
Third Revised Sheet 81  
Cancelling Second Revised Sheet 81  
Effective: June 4, 2004

N11 SERVICES

C. 211 SERVICE FOR COMMUNITY INFORMATION AND REFERRAL SERVICES (Cont'd)

6. Rates and Charges (Cont'd)

- c. Where applicable, the Local Agency shall pay a nonrecurring Exclusion Charge.
  - 1) When the Local Agency does not make contemporaneous applications to establish the 211 Dialing Code in every Company local exchange served by a host central office, the Local Agency shall pay an Exclusion Charge for each Company local exchange served by the host central office where the 211 Dialing Code is not established.
  - 2) When a Company local exchange is once excluded, but the Local Agency later makes application to establish the 211 Dialing Code in the Company local exchange, then an Exclusion Charge shall again apply.
  - 3) When the Approved Information and Referral Service Provider requests a different telephone number be translated to the 211 abbreviated dialing code in a participating central office other than the telephone number translated to the 211 abbreviated dialing code in the host central office.
- d. The Local Agency shall pay a nonrecurring Number Change Charge when it makes application to change the telephone number into which the 211 Dialing Code is translated. The Number Change Charge shall be applied on a per telephone number, per host central office basis.
- e. Applicable Service Order Charges as specified in Section A4 of the Tariff will apply in addition to the rates listed below.
- f. Florida 211 Dialing Code Offering Non-Recurring Costs:

<u>Rate Elements</u>	<u>Non-Recurring Rate</u>
Central Office Charge(1)	\$250.00
Exclusion Charge(2)	325.00
Number Change Charge	50.00

- (1) This is applied at the host central office only, and covers all offices that are part of that host complex with a single translated number. If more than one translated number is desired, apply the charge as many times as there are numbers. Any given office must have one number translated to – this cost does not cover cases where the Local Agency wants two or more translated numbers. Such a case would require class marking or a database.
- (2) This is applied at the host office only, and could cover any number of offices that would not have access to the 211 Dialing Code.

GENERAL EXCHANGE TARIFF

Embarq Florida, Inc.

By: F. B. Poag  
Director

SECTION A10  
First Revised Sheet 82  
Cancelling Original Sheet 82  
Effective: July 15, 2002

N11 SERVICES

D. 511 SERVICE FOR TRAVEL INFORMATION SERVICES

1. General

- a. The Federal Communications Commission ("FCC") has nationally assigned the three digit 511 abbreviated dialing code to traveler information services. In CC Docket 92-105, Order 00-236, the FCC concluded that a governmental entity may request 511 assignment from wireline providers in order to provide intelligent transportation systems and other transportation information. The FCC also concluded that state public utility commissions may continue to exercise jurisdiction over N11 codes to ensure that carriers comply with transportation agencies' requests to deploy 511 expeditiously.
- b. The three digit 511 abbreviated dialing code the Approved Travel Information Service Provider ("511 Provider") for use in providing community travel Information services to the public by way of voice grade facilities.
- c. The Company makes the 511 abbreviated dialing code available to the 511 Provider as a tariffed, local calling area based service ("511 Service"). The 511 Service allows a Company subscriber to access the 511 Provider's call center by dialing only the 511 abbreviated dialing code using voice grade facilities. Subject to other terms and conditions of this tariff, Company subscribers shall be able to make and the 511 Provider shall be able to receive calls using the 511 Service as part of their local exchange services. The 511 Service is supplemental to and is not a replacement for either party's local exchange service.
- d. All 511 abbreviated dialing code calls must be local in nature and will not result in any extended calling scope (ECS), \$.20 EAS, intraLATA toll, interLATA long distance or pay-per-call charges to Company subscribers. However, 511 Service calls may result in measured service charges where Company subscribers' service plans include such charges as part of local measured service or home exchange service calling plans.
- e. The 511 Service is not available for the following classes of service:
  1. Hospital service.
  2. Inmate Service.
  3. 1+ and 0+ calling.
  4. 0-operated assisted calling.
  5. 101XXXXX calling.

## GENERAL EXCHANGE TARIFF

Embarq Florida, Inc.

By: F. B. Poag  
Director

SECTION A10  
Second Revised Sheet 83  
Cancelling First Revised Sheet 83  
Effective: September 20, 2003

### N11 SERVICES

#### D. 511 SERVICE FOR TRAVEL INFORMATION SERVICES

##### 2. Obligations of the Approved Travel Information Services Provider

- a. The 511 Provider must submit a written application to the Company for 511 Service at the local exchange level. The 511 Provider may establish 511 Service in all or part of the Company's local exchanges.
- b. The 511 Provider's written application to establish 511 Service in a Company local exchange must include the following:
  1. The local, foreign exchange or toll free telephone number into which the Company should translate the dialed 511 abbreviated code. If the 511 Provider desires to change the telephone number into which the 511 abbreviated dialing code is translated, the 511 Provider must pay a Number Change Charge as found in Section A10.
  2. A location description of the 511 Provider call center where 511 calls made from the Company local exchange will be routed.
  3. For network sizing and protection, an estimate of annual call volumes and holding time for calls to the 511 Service.
- c. Local Calling for Company Subscribers
  1. The 511 Provider, in cooperation with the Company, will assure that all 511 Service calls are local and do not generate extended calling scope (ECS), \$.20 EAS, intraLATA toll, interLATA long distance or pay-per-call charges for Company subscribers.
  2. When the 511 Provider applies for 511 Service in a Company local exchange, the 511 Provider must supply the Company with a seven or ten digit telephone number that terminates within the Company local exchange's local calling area. The Company will translate the 511 digits into the telephone number provided by the 511 Provider.
  3. When the 511 Provider applies for 511 Service in a Company local exchange and a 511 Provider call center is not located within the local exchange's local calling area, the 511 Provider must establish foreign exchange service or supply the Company with a toll free telephone number so that Company subscribers' 511 Service calls do not incur toll charges.

GENERAL EXCHANGE TARIFF

Embarq Florida, Inc.

By: F. B. Poag  
Director

SECTION A10  
First Revised Sheet 84  
Cancelling Original Sheet 84  
Effective: July 15, 2002

N11 SERVICES

D. 511 SERVICE FOR TRAVEL INFORMATION SERVICES

2. Obligations of the Approved Travel Information Services Provider (Cont'd)

- d. The 511 Provider is liable for and will indemnify, protect, defend and hold harmless the Company against all suits, actions, claims, demands and judgments, plus any expenses and counsel fees incurred by the Company on account thereof, whether suffered, made, instituted or asserted by the 511 Provider or any other party or person, for any personal injury to or death of any person or persons, or for any loss, damage or destruction of any property, whether owned by the 511 Provider or others, arising out of or resulting directly or indirectly from the 511 Service.
- e. The 511 Provider must develop an appropriate method for responding to 511 calls directed to it out of confusion or in error by Company subscribers.
- f. The 511 Provider must subscribe to termination facilities and lines in sufficient quantities to provide adequate service to the public, and enable the 511 Provider to receive calls to the 511 Service during normal business hours.
- g. The 511 Service is provided on the condition that the 511 Provider subscribes to termination facilities and lines in sufficient quantities to adequately handle calls to the 511 Service without interfering with or impairing any services offered by the Company. There will be one path available for each line to which to 511 Provider subscribes.
- h. The 511 Provider must comply with all present and future state and federal rules pertaining to abbreviated dialing codes.
- i. The 511 Provider is responsible for obtaining all necessary permissions, licenses, written consents, waivers and releases and all other rights from all persons whose work, statements or performances are used in connection with the 511 Service. The 511 Provider is also responsible for obtaining all necessary permissions, licenses, written consents, waivers and releases and all other rights from all holders of copyrights, trademarks and patents used in connection with the said service.
- j. The 511 Provider must respond promptly to all complaints lodged with any regulatory authority against the 511 Service. If requested by the Company, the 511 Provider must assist the Company in responding to complaints made to the Company concerning the 511 Service.
- k. The 511 Provider shall not promote the 511 Service with the use of an autodialer or broadcasting of tones that dial the 511 abbreviated dialing code.

GENERAL EXCHANGE TARIFF

Embarq Florida, Inc.

By: F. B. Poag  
Director

SECTION A10  
First Revised Sheet 85  
Cancelling Original Sheet 85  
Effective: July 15, 2002

N11 SERVICES

D. 511 SERVICE FOR TRAVEL INFORMATION SERVICES

2. Obligations of the Approved Travel Information Services Provider (Cont'd)

- I. The 511 Service is available only to end users located in Company local exchanges. To establish 511 calling to end users in non-Company local exchanges, the 511 Provider must make appropriate arrangements with the companies serving those local exchanges, even where Company subscribers may make local calls to the non-Company local exchanges.
- m. The 511 Provider must work separately with competitive local exchange carriers ("CLECs") operating and serving customers in the Company's local exchanges to ascertain whether 511 abbreviated dialing will be available to their end users.

3. Obligations of the Company

- a. The Company will establish the 511 Service within ninety days after receipt of the 511 Provider's completed application(s) for service or the effective date of this tariff, whichever is later.
- b. When a 511 Service call is placed by the calling party via interconnection with an interexchange carrier, the Company cannot guarantee the completion of said 511 Service call, the quality of the call or any features that may otherwise be provided with 511 Service.
- c. The Company does not undertake to answer and forward 511 Service calls but furnishes the use of its facilities to enable the 511 Provider to respond to such calls at the 511 Provider established call centers.
- d. The rates charged for 511 Service do not contemplate the inspection or constant monitoring of facilities to discover errors, defects, and malfunctions in service, nor does the Company undertake such responsibility. The 511 Provider must conduct such operational tests as, in the judgment of the 511 Provider, are required to determine whether the Company's facilities are functioning properly for its use. The 511 Provider must promptly notify the Company in the event the Company's facilities are not functioning properly.

## GENERAL EXCHANGE TARIFF

Embarq Florida, Inc.

By: F. B. Poag  
Director

SECTION A10  
First Revised Sheet 86  
Cancelling Original Sheet 86  
Effective: July 15, 2002

### N11 SERVICES

#### D. 511 SERVICE FOR TRAVEL INFORMATION SERVICES

##### 4 Liability

- a. The liability of the Company for losses or damages of any kind arising out of mistakes, omissions, interruptions, delays, errors or defects in transmission, or failure or defects in any facility furnished by the Company, occurring in the course of furnishing 511 Service, or of the Company in failing to maintain proper standards of maintenance and operation or to exercise reasonable supervision, shall in no event exceed an amount equivalent to the proportionate charge to the 511 Provider for the 511 Service and local exchange services for the period of service during which such mistake, omission, interruption, delay, error or defect in transmission or defect or failure in facilities occurs.
- b. The Company is not liable for any losses or damages caused by the negligence of the 511 Provider.
- c. The Company's entire liability to any person for interruption or failure of the 511 Service is limited to the terms set forth in this and other sections of this Tariff.

##### 5. Other Terms and Conditions

- a. The 511 Service will not provide calling number information in real time to the 511 Provider. If this type of information is required, the 511 Provider must subscribe to compatible Caller ID service as described in Section 13 of this tariff. The Caller ID service will only provide calling number information as described in Section 13 of this tariff.
- b. The 511 Service is provided solely for the benefit of the 511 Provider. The provision of the 511 Service by the Company shall not be interpreted, constructed or regarded, either expressly or implied, as being for the benefit of or creating any Company obligation toward any third person or legal entity other than the 511 Provider.
- c. A written notice will be sent to the 511 Provider following oral notification when its 511 Service unreasonably interferes with or impairs other services rendered to the public by the Company or by other subscribers of abbreviated dialing codes. If after notification the 511 Provider makes no modification in method of operation or in the service arrangements that are deemed service-protective by the Company, or if the 511 Provider is unwilling to accept the modifications, or if the 511 Provider continues to cause service impairment, the Company reserves the right, at any time, without further notice, to institute protective measures, up to and including termination of service.
- d. In an emergency situation as determined by the Company, the Company reserves the right, at any time, without notice, to institute protective measures, up to and including termination of service.

GENERAL EXCHANGE TARIFF

Embarq Florida, Inc.

By: F. B. Poag  
Director

SECTION A10  
Third Revised Sheet 87  
Cancelling Second Revised Sheet 87  
Effective: July 12, 2005

N11 SERVICES

D. 511 SERVICE FOR TRAVEL INFORMATION SERVICES

6. Rates and Charges

- a. A Central Office Charge applies for each Company host central office out of which the 511 Provider orders 511 Service, as follows:
  1. When a Company local exchange is served by more than one host central office, a Central Office Charge is applicable for each host central office in that local exchange.
  2. If the 511 Provider establishes 511 Service in multiple Company local exchanges served by the same host central office, only one Central Office Charge applies.
- b. An Exclusion Charge in lieu of a Central Office Change applies for the establishment of 511 Service as follows:
  1. When the 511 Provider does not make simultaneous applications to establish 511 Service in every Company local exchange served by a host central office, the 511 Provider must pay an Exclusion Charge per host central office if any local exchange(s) are excluded from the translation.
  2. When a Company local exchange is once excluded, but the 511 Provider later makes application to establish 511 Service in the Company local exchange, then an Exclusion Charge applies per host central office when a local exchange continues to be excluded from the translation.
  3. When the 511 Provider requests a different telephone number be translated to the 511 abbreviated dialing code in a participating Company local exchange other than the telephone number translated to the 511 abbreviated dialing code in the host central office, then an Exclusion Charge applies per host central office.
- c. A Number Change Charge applies when the 511 Provider applies to change the telephone number into which the 511 abbreviated dialing code is translated. The Number Change Charge is applied on a per telephone number, per host central office basis.

GENERAL EXCHANGE TARIFF

Embarq Florida, Inc.

By: F. B. Poag  
Director

SECTION A10  
Second Revised Sheet 88  
Cancelling First Revised Sheet 88  
Effective: July 8, 2005

N11 SERVICES

D. 511 SERVICE FOR TRAVEL INFORMATION SERVICES

6. Rates and Charges (Cont'd)

d. When translating the seven or ten digit number to the 511 abbreviated dialing code, applicable Service Ordering Charges as specified in Section 4 of this tariff will apply as follows, in addition to the rates listed below.

1. A business rate Primary Service Ordering Charge per order, as found in Section 4.E.1. of this tariff.
2. A business rate Access Line Charge per translated number as found in Section 4.E.1 of this tariff.

e. Rates:

	Non-Recurring Charge
Central Office Charge (per host Central Office)	\$ 250.00
Exclusion Charge (per host Central Office)	325.00
Number Change Charge (per telephone number)	50.00



## GENERAL EXCHANGE TARIFF

Embarq Florida, Inc.

By: F. B. Poag  
Director

SECTION A10  
First Revised Sheet 89  
Cancelling Original Sheet 89  
Effective: January 3, 2004

### N11 SERVICES

#### E. NON-EMERGENCY 311 SERVICE (Cont'd)

##### 1. General

- a. Non-Emergency 311 Service (NE311) is a local telephone exchange communications service which allows Company subscribers to reach non-emergency local government services by dialing an abbreviated telephone number. The Federal Communications Commission (FCC) reserved the abbreviated telephone number, 3-1-1, for non-emergency access to public services. NE311 Service is an optional service which may be purchased by a local municipality, state or local governmental unit to whom authority has been lawfully delegated. The NE311 Service Provider must be granted authority by the appropriate city, county, or state officials to provide the service.
- b. NE311 Service allows a Company subscriber to access an approved NE311 Service Provider by dialing only the 311 abbreviated dialing code. Subject to other terms and conditions of this Tariff, Company subscribers shall be able to make and the NE311 Service Provider shall be able to receive calls using the NE311 Service as part of their local exchange services. The NE311 Service is supplemental to and is not a replacement for either party's local exchange service.
- c. All NE311 Service calls must be local in nature and shall not result in any intraLATA toll, interLATA long distance or pay-per-call charges to Company subscribers. However, NE311 Service calls may result in local measured service charges where Company subscribers' service plans include such charges as part of Home and Extended Area Service (EAS) exchange calling. NE311 Service calls are not permitted where local calling is restricted.
- d. The NE311 Service is not available for the following classes of service: inmate service, 1+ and 0+ calling, 0- operated assisted calling and 101XXXX calling. NE311 Service is otherwise available wherever local service is accessible.
- e. Only calls originating within a NE311 Service Provider's area of jurisdiction (the "NE311 Service Area") will be routed to a call center/answering point designated by the NE311 Service Provider. There can be only one NE311 Service Provider in each geographic area. NE311 Service areas may not overlap. This assures that NE311 calls from a telephone line within a NE311 Service Area can be routed to a unique NE311 call center/answering point.
- f. NE311 Service is offered subject to the availability of facilities.

## GENERAL EXCHANGE TARIFF

Embarq Florida, Inc.

By: F. B. Poag  
Director

SECTION A10  
First Revised Sheet 90  
Cancelling Original Sheet 90  
Effective: January 3, 2004

### N11 SERVICES

#### E. NON-EMERGENCY 311 SERVICE (Cont'd)

##### 2. Obligations of the Non-Emergency 311 Service Provider

- a. The NE311 Service Provider must submit a written application for NE311 Service on a Company local exchange by local exchange basis. The NE311 Service Provider may establish NE311 Service in all or part of the Company's local exchanges.
- b. The NE311 Service Provider's written application to establish NE311 Service in a Company local exchange shall include the following:
  - 1) The unpublished local telephone number into which the Company is to translate the dialed NE311 abbreviated code. If the NE311 Service Provider desires to change the telephone number into which the NE311 abbreviated dialing code is translated in an exchange, then the NE311 Service Provider must pay the Number Change Charge specified in Section E.7.h.(1)(c).
  - 2) A location description of the NE311 Service Provider call center where NE311 calls made from the Company local exchange will be routed.
  - 3) For network sizing and protection, an estimate of annual call volumes, the expected busy hour and holding time for each call to the NE311 Service.
  - 4) An acknowledgment of the possibility that the assignment of the NE311 abbreviated dialing code may be recalled at any time. The assignment of the dialing code is provided on a first come first served basis.
- c. Local Calling for Company Subscribers
  - 1) The NE311 Service Provider, in cooperation with the Company, shall assure that all NE311 Service calls are local in nature and do not generate local, intraLATA toll, interLATA long distance or pay-per-call charges for Company subscribers.
  - 2) When the NE311 Service Provider makes application for NE311 Service in a Company local exchange, the NE311 Service Provider shall supply the Company with an unpublished seven or ten digit telephone number that terminates within the Company local exchange or one of the local exchange's EAS exchanges. The Company's exchange facilities will translate the dialed NE311 dialing code into the telephone number the NE311 Service Provider provides once NE311 Service is established in the local exchange.
  - 3) When the NE311 Service Provider makes application for NE311 Service in a Company local exchange and a NE311 Service Provider call center is not located within the local exchange or one of the local exchange's EAS exchanges, then the NE311 Service Provider shall establish foreign exchange service or supply the Company with a toll free telephone number so that Company subscribers' NE311 Service calls remain local in nature.

GENERAL EXCHANGE TARIFF

Embarq Florida, Inc.

By: F. B. Poag  
Director

SECTION A10  
First Revised Sheet 91  
Cancelling Original Sheet 91  
Effective: January 3, 2004

N11 SERVICES

E. NON-EMERGENCY 311 SERVICE (Cont'd)

2. Obligations of the Non-Emergency 311 Service Provider (Cont'd)

- d. The NE311 Service Provider is liable for and will indemnify, protect, defend and hold harmless the Company against all suits, actions, claims, demands and judgments, plus any expenses and counsel fees incurred by the Company on account thereof, whether suffered, made, instituted or asserted by the NE311 Service Provider or any other party or person, for any personal injury to or death of any person or persons, or for any loss, damage or destruction of any property, whether owned by the N11 Service Provider or others, arising out of or resulting directly or indirectly from the NE311 Service.
- e. The NE311 Service Provider must develop an appropriate method for responding to NE311 calls directed to it out of confusion or in error by Company subscribers. This includes calls from customers that reside within the Company local exchange but outside the legally designated jurisdiction of the NE311 Service Provider (i.e. exchange boundaries that cross county borders.)
- f. The NE311 Service Provider must be prepared to receive all calls to the NE311 Service during normal business hours. To this end, the NE311 Service Provider agrees to subscribe to termination facilities and lines in sufficient quantities to provide adequate service to the public.
- g. NE311 Service is provided on the condition that the NE311 Service Provider subscribes to termination facilities and lines in sufficient quantities to adequately handle calls to the NE311 Service without interfering with or impairing any services offered by the Company. For each line subscribed to by the NE311 Service Provider, there will be one path available.
- h. The NE311 Service Provider must comply with all present and future rules pertaining to abbreviated dialing codes.
- i. The NE311 Service Provider is responsible for obtaining all necessary permissions, licenses, written consents, waivers and releases and all other rights from all persons whose work, statements or performances are used in connection with the 311 Service, and from all holders of copyrights, trademarks and patents used in connection with the said service.
- j. The NE311 Service Provider must respond promptly to any and all complaints lodged with any regulatory authority against the NE311 Service. If requested by the Company, the NE311 Service Provider shall assist the Company in responding to complaints made to the Company concerning the NE311 Service.
- k. The NE311 Service Provider shall not promote the NE311 Service with the use of an autodialer or broadcasting of tones that dial the NE311 abbreviated dialing code.

## GENERAL EXCHANGE TARIFF

Embarq Florida, Inc.

By: F. B. Poag  
Director

SECTION A10  
First Revised Sheet 92  
Cancelling Original Sheet 92  
Effective: January 3, 2004

### N11 SERVICES

#### E. NON-EMERGENCY 311 SERVICE (Cont'd)

##### 2. Obligations of the Non-Emergency 311 Service Provider (Cont'd)

- i. The Company can only make NE311 Service available to end users located in Company local exchanges. To establish NE311 calling to end users in non-Company local exchanges, the NE311 Service Provider must make appropriate arrangements with the companies serving those local exchanges, even where Company subscribers may make local calls to the non-Company local exchanges.
- m. The NE311 Service Provider must work separately with competitive local exchange carriers operating and serving customers in the Company's local exchanges to ascertain whether NE311 abbreviated dialing will be available to their end users.
- n. In the event that an end user mis-dials and reports an emergency by dialing 311, the NE311 Service Provider agrees to release, indemnify, defend, and save harmless the Company from claims, suits, actions, damages, costs, judgments, actions of every name and description arising out of or due to acts or omissions of the NE311 Service Provider, its agents and its employees while answering and dispatching 311 calls.

##### 3. Obligations of the Company

- a. The Company shall provision the NE311 Service within ninety days of the Company's receipt of the NE311 Service Provider's completed application(s) for service. If the Company receives an application from an approved NE311 Service Provider prior to the effective date of this tariff, the Company will provision the 311 Service within ninety days of the effective date of the tariff.
- b. When an NE311 Service call is placed by the calling party via interconnection with an interexchange carrier, the Company cannot guarantee the completion of said NE311 Service call, the quality of the call or any features that may otherwise be provided with NE311 Service.
- c. The Company will route NE311 calls originating from end users on the Company's local exchange network whether they purchase service directly from the Company or from another provider reselling Company service. Otherwise, the Company is not responsible for establishing NE311 Service for calls originating from other telecommunications providers.
- d. The Company does not undertake to answer and forward NE311 Service calls but furnishes the use of its facilities to enable the NE311 Service Provider to respond to such calls at NE311 Service Provider established call centers.

GENERAL EXCHANGE TARIFF

Embarq Florida, Inc.

By: F. B. Poag  
Director

SECTION A10  
First Revised Sheet 93  
Cancelling Original Sheet 93  
Effective: January 3, 2004

N11 SERVICES

E. NON-EMERGENCY 311 SERVICE (Cont'd)

3. Obligations of the Company (Cont'd)

- e. The rates charged for NE311 Service do not contemplate the inspection or constant monitoring of facilities to discover errors, defects, and malfunctions in service, nor does the Company undertake such responsibility. The NE311 Service Provider shall make such operational tests as, in the judgment of the NE311 Service Provider, are required to determine whether the Company's facilities are functioning properly for its use. The NE311 Service Provider shall promptly notify the Company in the event the Company's facilities are not functioning properly.
- f. NE311 Service is furnished subject to all operating failures and interruptions, including, but not limited to, equipment breakdowns, errors, defects, malfunctions and interruptions of service experienced in the regular telephone exchange system. The rates provided for this service are subject to the limitations which appear in this section and in other applicable sections of this and other tariffs. The Company does not undertake to provide a higher level of service reliability and quality than the telephone exchange service being provided in the exchange that NE311 Service is offered.

4. Liability

- a. The liability of the Company for losses or damages of any kind arising out of mistakes, omissions, interruptions, delays, errors or defects in transmission, or failure or defects in any facility furnished by the Company, occurring in the course of furnishing NE311 Service, or of the Company in failing to maintain proper standards of maintenance and operation or to exercise reasonable supervision, shall in no event exceed an amount equivalent to the proportionate charge to the NE311 Service Provider for the NE311 Service and local exchange services for the period of service during which such mistake, omission, interruption, delay, error or defect in transmission or defect or failure in facilities occurs. The Company has no liability for losses or damages caused by the negligence of the NE311 Service Provider.
- b. The Company's entire liability to any person for interruption or failure of the NE311 Service shall be limited to the terms set forth in this section and other sections of this Tariff.
- c. The local assignment and the NE311 Service Provider's use of the 311 abbreviated dialing code is subject to preemption by the Federal Communications Commission. The Company shall not be liable to the NE311 Service Provider for any damages the NE311 Service Provider may incur that results from a national assignment of the 311 abbreviated dialing code.
- d. The Company accepts no responsibility for obtaining subscriber record information from telephone end users.
- e. The Company will make every effort to route NE311 calls to the appropriate NE311 Service Provider calling center, however, the Company will not be held responsible for routing mistakes or errors.

GENERAL EXCHANGE TARIFF

Embarq Florida, Inc.

By: F. B. Poag  
Director

SECTION A10  
First Revised Sheet 94  
Cancelling Original Sheet 94  
Effective: January 3, 2004

N11 SERVICES

E. NON-EMERGENCY 311 SERVICE (Cont'd)

5. Other Terms and Conditions

- a. The NE311 Service will not provide calling number information in real time to the NE311 Service Provider. If this type of information is required, the NE311 Service Provider must subscribe to compatible Caller ID service as described in Section 13 of this tariff.
- b. The NE311 Service is provided solely for the benefit of the NE311 Service Provider. The provision of the NE311 Service by the Company shall not be interpreted, construed or regarded, either expressly or implied, as being for the benefit of or creating any Company obligation toward any third person or legal entity other than the NE311 Service Provider.
- c. A written notice will be sent to the NE311 Service Provider following oral notification when its NE311 Service unreasonably interferes with or impairs other services rendered to the public by the Company or by other subscribers of abbreviated dialing codes. If after notification the NE311 Service Provider makes no modification in method of operation or in the service arrangements that are deemed service-protective by the Company, or if the NE311 Service Provider is unwilling to accept the modifications, or if the NE311 Service Provider continues to cause service impairment, the Company reserves the right, at any time, without further notice, to institute protective measures, up to and including termination of service. In an emergency situation as defined by the Company, the Company reserves the right, at any time, without notice, to institute protective measures, up to and including termination of service.

6. Optional Features

- a. Call Summary Report: The NE311 Service Provider may choose to receive a monthly call summary report that provides the NE311 Service Provider with a summary of their NE311 traffic. The data is delivered using electronic mail distribution to the NE311 Service Provider and is reported as the number of calls by central office by month.

GENERAL EXCHANGE TARIFF

Embarq Florida, Inc.

By: F. B. Poag  
Director

SECTION A10  
Second Revised Sheet 95  
Cancelling First Revised Sheet 95  
Effective: July 12, 2005

N11 SERVICES

E. NON-EMERGENCY 311 SERVICE (Cont'd)

7. Rates

- a. The nonrecurring charges associated with the initial NE311 Service establishment are specified in E.7.h. following. These are one-time charges which apply only when the NE311 Service Provider establishes or modifies NE311 Service.
- b. The NE311 Service Provider shall pay a nonrecurring Central Office Charge for each Company host central office out of which NE311 Service is established.
  - 1) Some Company local exchanges are served by more than one host central office. In order to establish NE311 Service in such an exchange, the NE311 Service Provider shall pay a Central Office Charge for each host central office in the Company local exchange.
  - 2) Some host central offices serve more than one Company local exchange. If the NE311 Service Provider makes applications to establish NE311 Service in multiple Company local exchanges served by the same host central office, then only one Central Office Charge shall apply. However, the full Central Office Charge applies whether or not the NE311 Service Provider requests NE311 Service in all the Company local exchanges served by that host central office.
- c. An Exclusion Charge Applies in lieu of a Central Office Charge for the establishment of NE311 Service as follows:
  - 1) When the NE311 Service Provider does not simultaneously establish NE311 Service in every Company local exchange served by a host central office, the NE311 Service Provider shall pay an Exclusion Charge per host central office if any local exchange(s) are excluded from the translation.
  - 2) When a Company local exchange is once excluded, but the NE311 Service Provider later applies to establish NE311 Service in the Company local exchange, an Exclusion Charge again applies per host central office when a local exchange continues to be excluded from the translation.
  - 3) When the NE311 Service Provider requests a different telephone number be translated to the 311 abbreviated dialing code in a participating Company local exchange other than the telephone number translated to the 311 abbreviated dialing code in the host central office, then an Exclusion Charge applies per host central office.
- d. A nonrecurring Number Change Charge applies when the NE311 Service Provider changes the telephone number into which the NE311 abbreviated dialing code is translated. The Number Change Charge shall be applied on a per telephone number, per host central office basis.
- e. Applicable service ordering charges as specified in Section 4 of this tariff will apply in addition to the rates listed below.
- f. The charges associated with the Call Summary Report are monthly charges.
- g. The minimum service period for NE 311 Service is one month.

GENERAL EXCHANGE TARIFF

Embarq Florida, Inc.

By: F. B. Poag  
Director

SECTION A10  
Second Revised Sheet 96  
Cancelling First Revised Sheet 96  
Effective: July 8, 2005

N11 SERVICES

E. NON-EMERGENCY 311 SERVICE (Cont'd)

7. Rates (Cont'd)

h. Rates

1. Basic Service

	<u>Nonrecurring Charge</u>
(a) Central Office Charge (per host Central Office)	\$ 250.00
(b) Exclusion Charge (per host Central Office)	325.00
(c) Number Change Charge (per telephone number)	50.00



GENERAL EXCHANGE TARIFF

Embarq Florida, Inc.

SECTION A11

By: F. B. Poag  
Director

Fourth Revised Contents Sheet 1  
Cancelling Third Revised Contents Sheet 1  
Effective: May 10, 2002

CENTREX SERVICE  
(Central Telephone exchanges only)

CONTENTS

A.	CENTREX SERVICE .....	1
1.	General .....	1
2.	Definitions .....	2.2
3.	Service Features .....	3
4.	Term Discount Plan .....	4
5.	Rates and Charges .....	5
B.	CENTREX SERVICE - OPTIONAL FEATURES.....	6
1.	Rates and Charges.....	6
C.	EXPRESSTOUCH CENTREX FEATURES .....	7
1.	General .....	7
2.	Regulations.....	7
3.	Features.....	8
4.	Rates and Charges.....	9

## GENERAL EXCHANGE TARIFF

Embarq Florida, Inc.

By: F. B. Poag  
Director

SECTION A11  
Second Revised Sheet 1  
Cancelling First Revised Sheet 1  
Effective: May 10, 2002

### CENTREX SERVICE (Central Telephone exchanges only)

#### A. CENTREX SERVICE

##### 1. General

- a. Centrex Service is a central office communications system package provided on individual access lines from central office equipment located on Company premises. Centrex Service is offered on a per customer premises basis at the following rates, terms and conditions. Customers subscribing to Centrex Service with 26 or more Centrex access lines may, but are not required to, subscribe to Centrex Service as a Special Service Arrangement as provided in Section A5.E. of this tariff.
- b. Customer premises for the purposes of this tariff section is defined as a single or as multiple structures on the same customer's contiguous property and the Centrex Service is provisioned via a single entrance facility and a single network interface device (NID). All cable, wires, facilities and customer premises equipment on the customer side of the NID are non-regulated and are the responsibility of the customer.
- c. Centrex Service is provided subject to the availability of facilities and central office equipment as determined by the Company.
- d. Centrex Service does not include terminal equipment on the customer's premises. Provision of the telephone instruments or other equipment is the responsibility of the customer. Some features require customer provided customer premises equipment (CPE).
- e. Directory listings are furnished in accordance with the rates and regulations specified in Section A6 of this tariff.
- f. Service Ordering Charges as specified in Section A4 of this tariff apply to the services offered in this section and are in addition to the Centrex Service Establishment Translation Charge in this section of the tariff. For feature changes after the initial installation, the Secondary Service Ordering Charge will apply in addition to applicable nonrecurring charges.
- g. The minimum service period for Centrex Service is one month. For customers with contracts prior to May 10, 2002, if at any time during the contract period the Company increases the monthly recurring rates for the service, the customer may terminate the service without incurring any early termination liability.

GENERAL EXCHANGE TARIFF

Embarq Florida, Inc.

By: F. B. Poag  
Director

SECTION A11  
Third Revised Sheet 2  
Cancelling Second Revised Sheet 2  
Effective: March 1, 2003

CENTREX SERVICE  
(Central Telephone exchanges only)

A. CENTREX SERVICE (Cont'd)

1. General (Cont'd)

- h. The quality of transmission for calls utilizing call forwarding or conferencing may vary depending on the distance and routing involved.
- i. Directory Assistance charges, as specified in Section A3 of this tariff, apply to the services offered in this section.
- j. Call Forward/Busy - Call Forward/Busy shall not be used to extend calls on a planned and continuing basis to intentionally avoid the payment in whole or in part of message toll charges that would regularly be applicable between the station originating the call and the station to which the call is transferred.
- k. Temporary Suspension of Service (Vacation Service), as specified in Section A2 of this tariff, is not allowed for Centrex Service.
- l. Not all Centrex Service features are compatible. Some combinations of features will not work when applied on the same line.
- m. Other services requested by the customer will be provided in accordance with applicable tariff sections.
- n. Centrex Service terminating into a PBX system are at the rates specified in Section A3.D.16.n.2) or A.3.D.16.n.3) of this tariff.

GENERAL EXCHANGE TARIFF

Embarq Florida, Inc.

By: F. B. Poag  
Director

SECTION A11  
First Revised Sheet 2.1  
Cancelling Original Sheet 2.1  
Effective: May 10, 2002

CENTREX SERVICE  
(Central Telephone exchanges only)

A. CENTREX SERVICE (Cont'd)

1. General (Cont'd)

- p. The assignment of telephone numbers and the sequence of the numbers assigned to a Centrex Service are made at the discretion of the Company. The Company does not guarantee to provide telephone numbers arranged in a consecutive manner. If the customer requests telephone numbers under a special numbering arrangement to be terminated in a Centrex customer group, then additional recurring and non-recurring charges may apply as determined on an Individual Case Basis (ICB) per Section A5.
- q. Centrex Service is not provided in association with local measured service and is not available on residential lines.
- r. All exchange access lines terminating in a Centrex system must be served by the same central office or associated remote switch. Centrex access lines may be provided as Foreign Exchange (FX) Service or Foreign Central Office (FCO) at the rates and charges specified in Section A9 of this tariff.
- s. The rates and charges applicable to Extended Area Service (EAS), Extended Calling Scope (ECS), TOLL-PAC and 25/25 Plan, as specified in Section A3 of this tariff also applies in addition to the rates and charges applicable to Centrex Service. Optional Extended Local Calling (OELC) and OEAS are not available to Centrex Service.

GENERAL EXCHANGE TARIFF

Embarq Florida, Inc.

By: F. B. Poag  
Director

SECTION A11  
First Revised Sheet 2.2  
Cancelling Original Sheet 2.2  
Effective: May 10, 2002

CENTREX SERVICE  
(Central Telephone exchanges only)

A. CENTREX SERVICE (Cont'd)

2. Definitions

ABBREVIATED DIALING<sup>1</sup>

Allows a station abbreviated dialing (i.e., 3, 4, or 5 digit dialing) to other station members within the same customer group.

AUTO ANSWER BACK<sup>1</sup>

Allows any incoming call to the Primary Directory Number of the set to be automatically answered after four seconds. Compatible only on a digital, hands free business set.

AUTOMATIC CALL DISTRIBUTION (ACD)<sup>2</sup>

Automatic Call Distribution is a digital central office service that provides advanced call distribution and queuing capabilities as an integrated function of Centrex service. The customer must subscribe to and maintain a minimum of two Automatic Call Distribution positions and at least one Automatic Call Distribution group.

AUTOMATIC LINE<sup>2</sup>

Provides an automatic connection between a calling station that goes off-hook and a predetermined location. Available on MDC sets only.

CALL FORWARD - UNIVERSAL, BUSY, AND NO ANSWER<sup>1</sup>

Allows a customer to have incoming calls to a station automatically forwarded to a predetermined telephone number, either on all calls and/or busy calls and/or calls not answered.

CALL HOLD<sup>1</sup>

Allows the user to hold one call for any length of time by flashing and dialing a special code providing neither party goes "on-hook"; the station line is then free to originate another call. Dialing the hold code a second time retrieves the first call.

CALL PARK<sup>1</sup>

Allows a station to park a call against its own directory number. The parked call can be retrieved from any station by dialing a feature access code and the directory number against which the call is parked.

1. Standard feature

2. Optional feature

GENERAL EXCHANGE TARIFF

Embarq Florida, Inc.

By: F. B. Poag  
Director

SECTION A11  
First Revised Sheet 2.3  
Cancelling Original Sheet 2.3  
Effective: May 10, 2002

CENTREX SERVICE  
(Central Telephone exchanges only)

A. CENTREX SERVICE (Cont'd)

2. Definitions (Cont'd)

CALL PICK-UP<sup>1</sup>

Allows a station to answer incoming calls to another station within a pre-set pick-up group. Calls are answered according to the member who has been ringing the longest.

CALL TRANSFER<sup>1</sup>

Allows a station to transfer an incoming call to another user.

CALL WAITING<sup>1</sup>

Informs a station user by tone, while on an established call, that a second call is waiting.

CLASS OF SERVICE RESTRICTIONS<sup>2</sup>

Defines the specific features and calling patterns available to stations and attendants within a customer group. Access code restrictions can be set up to restrict stations and attendants from trunk types such as local, toll, DID, and WATS. The following options are available:

Fully Restricted Service – Allows intragroup dialing only, must dial 9

Toll Restricted Service – Allows intragroup and local dialing only, must dial 9

Unrestricted Service – Allows full access to all facilities, must dial 9

Unrestricted Assume Dial 9 – Same as unrestricted; however, user cannot utilize abbreviated dialing

Note: 900 and 976 block available with all options

DIRECT INWARD DIALING<sup>1</sup>

This service allows for incoming calls from the exchange network to reach a specific station. The calling party dials the seven-digit directory number to reach the station.

DIRECT OUTWARD DIALING<sup>1</sup>

With this service, a Centex station user can place external calls to the exchange network by dialing the access code (usually the digit 9) receiving an optional second dial tone, then dialing the number.

1. Standard feature

2. Optional feature

GENERAL EXCHANGE TARIFF

Embarq Florida, Inc.

By: F. B. Poag  
Director

SECTION A11  
First Revised Sheet 2.4  
Cancelling Original Sheet 2.4  
Effective: May 10, 2002

CENTREX SERVICE  
(Central Telephone exchanges only)

A. CENTREX SERVICE (Cont'd)

2. Definitions (Cont'd)

DISTINCTIVE RINGING<sup>1</sup>

Produces a different ringing cadence for calls within and outside the customer group. One (1) long ring for internal calls, two (2) short rings for external calls.

LAST NUMBER REDIAL<sup>1</sup>

Enables the subscriber to redial the last called number by pressing a single key rather than dialing the entire number.

MEET-ME-CONFERENCE<sup>2</sup>

Allows up to six (6) conferees to hold a conference call by dialing a pre-determined directory number at a specified time.

MULTIPLE APPEARANCE-DIRECTORY NUMBER (MADN)<sup>2</sup>

A directory number that is assigned to more than one station may be arranged as a single business set or per customer group.

MUSIC-ON-HOLD<sup>2</sup>

Provides the music-on-hold capability to calls that terminate on business sets within a customer group. When a call is put on hold, the caller hears music, announcement, silence, or a combination of the three treatments. Music source can be provided by the subscriber or the central office and requires an additional Centrex line to do so.

RING AGAIN<sup>1</sup>

Allows a station user encountering a busy station to be notified when the busy station becomes idle and to be placed automatically in a ring-again mode.

1. Standard feature
2. Optional feature

GENERAL EXCHANGE TARIFF

Embarq Florida, Inc.

By: F. B. Poag  
Director

SECTION A11  
First Revised Sheet 2.5  
Cancelling Original Sheet 2.5  
Effective: May 10, 2002

CENTREX SERVICE  
(Central Telephone exchanges only)

A. CENTREX SERVICE (Cont'd)

2. Definitions (Cont'd)

SECONDARY DIRECTORY NUMBER<sup>2</sup>

Directory number not associated with a line, but assigned for use with priority hunting.

SPEED CALL LONG - CUSTOMER GROUP (30)<sup>2</sup>

Allows user to store up to 30 frequently dialed numbers and be called using a 2-digit code.

SPEED CALL LONG - CUSTOMER GROUP (50)<sup>2</sup>

Allows user to store up to 50 frequently dialed numbers and be called using a 2-digit code.

SPEED CALL SHORT (10)<sup>1</sup>

Allows user to store up to 10 numbers that can be dialed automatically by using single digit codes.

STATION CONTROL CONFERENCE<sup>2</sup>

Enables a Centrex station user to establish a conference call consisting of up to thirty (30) conferees without the assistance of the attendant.

STATION HUNTING (sequential, circular, multiline)<sup>1</sup>

When a called access line is busy, the call will be routed to a vacant (if available) access line in the hunt (rotary) group.

THREE-WAY CONFERENCE WITH CONSULTATION HOLD AND TRANSFER<sup>1</sup>

Allows a station to include a third party in a call and optionally to transfer the call to the third party and performs consultation hold.

UNIFORM CALL DISTRIBUTION (UCD)<sup>2</sup>

This service allows for an even distribution of incoming calls to a listed directory number over a group of Unity or other 500/2500 type sets. Each station has its own directory number. Included with this feature is the provision of message announcement for calls in queuing. The customer will be responsible for providing the compatible tape and the announcement.

1. Standard feature

2. Optional feature



GENERAL EXCHANGE TARIFF

Embarq Florida, Inc.

By: F. B. Poag  
Director

SECTION A11  
Second Revised Sheet 3  
Cancelling First Revised Sheet 3  
Effective: May 10, 2002

CENTREX SERVICE  
(Central Telephone exchanges only)

A. CENTREX SERVICE (Cont'd)

3. Service Features

The features listed are station or attendant console related. The basic rate includes all features, however the customer must specify which features are activated for each Centrex line.

a. Standard Features

- 1) Abbreviated Dialing
- 2) Auto Answer Back
- 3) Call Forward - Universal, Busy, and No Answer
- 4) Call Hold
- 5) Call Park
- 6) Call Pick-Up
- 7) Call Transfer
- 8) Call Waiting
- 9) Direct Inward Dialing
- 10) Direct Outward Dialing
- 11) Distinctive Ringing
- 12) Last Number Redial
- 13) Ring Again
- 14) Speed Call Short (10)
- 15) Station Hunting
- 16) Three-Way Conference with Consultation Hold and Transfer

GENERAL EXCHANGE TARIFF

Embarq Florida, Inc.

By: F. B. Poag  
Director

SECTION A11  
Third Revised Sheet 4  
Cancelling Second Revised Sheet 4  
Effective: June 20, 2002

CENTREX SERVICE  
(Central Telephone exchanges only)

A. CENTREX SERVICE (Cont'd)

4. Term Discount Plan (TDP)

- a. Term Discount Plans (TDPs) are available for Centrex Service. TDPs provide the customer with discounted rates. The customer agrees to a minimum service commitment period for Centrex Service when the TDP is established. The customer must order a TDP in writing to the Company. A TDP may be ordered based on the following plan options:

Plan A:	12 months
Plan B:	36 months

- b. The customer must specify the length of the initial service period at the time the service is ordered. When a customer converts to a TDP, no Centrex Service Establishment Translation Charge is applied toward Centrex facilities in-service at that time. If a customer moves from a month to month plan to a TDP, or upgrades from a 12 month TDP to a 36 month TDP, then no Centrex Service Establishment Translation Charge is applied.
- c. If a TDP customer disconnects service prior to the end of the TDP, the customer is liable for 100% of the payments remaining for the rest of the term plan. If Special Construction Charges were applied to the service being terminated, any termination charges associated with Special Construction Charges will also apply.
- d. Rate increases or decreases will automatically be applied to the monthly term plan rates for the remaining term of the TDP. If Company initiated rate increases to any rate element or combination of rate elements causes the charges for the entire Centrex service under the TDP to increase by 10% or more annually, then the customer may cancel the TDP without incurring termination liability charges provided that the customer notifies the Company within 30 days after the effective date of the rate increase.
- e. TDP commitment periods can be extended by the customer at any time during the term of the plan, up to a maximum of 36 months. The number of months accrued in the current plan will apply toward the new plan selected.
- f. At the end of the TDP service commitment period, the customer may subscribe to a new TDP at the prevailing rates set forth in Section A11.A.5. following. At the end of the TDP service commitment period there is no automatic renewal of the TDP, so the rates will convert to the prevailing month to month rates unless the customer selects a new TDP.
- g. Customers under a TDP who change physical locations will not be subject to termination charges if the customer subscribes to a new Centrex TDP at the new location.
- h. Special Construction Charges may apply as specified in Section A5.

GENERAL EXCHANGE TARIFF

Embarq Florida, Inc.

By: F. B. Poag  
Director

SECTION A11  
Twelfth Revised Sheet 5  
Cancelling Eleventh Revised Sheet 5  
Effective: November 1, 2005

CENTREX SERVICE  
(Central Telephone exchanges only)

A. CENTREX SERVICE (Cont'd)

5. Rates and Charges

a. Monthly Rates

	<u>Rate Groups</u>				
	1	2	3	4	5
Business, Centrex Line					
Central Telephone, MTM	\$30.00	30.00	30.00	30.00	30.00
Central Telephone, 1 YR	\$28.00	28.00	28.00	28.00	28.00
Central Telephone, 3 YR	\$27.00	27.00	27.00	27.00	27.00

b. Centrex Service Establishment Translation Charge

The charge for performing the central office translation associated with configuring a Centrex customer's network parameters.

- 1) Applies to each Centrex customer group translation activity performed.

Nonrecurring Charge (per Centrex customer group) \$50.00

- 2) Service Ordering Charges as specified in Section A4 of this tariff apply to the services offered in this section and are in addition to the Centrex Service Establishment Translation Charge.

c. Feature Changes After Initial Installation

- 1) Nonrecurring Charge (per line) \$10.00  
Maximum charge of \$50 per order.

- 2) For feature changes after the initial installation, the Secondary Service Ordering Charge will apply in addition to applicable nonrecurring charges.

- 3) This applies to both standard features and optional features.

- d. Subscriber Line Charge (SLC)/End User Common Line Charge (EULC) is applicable and will be billed on a per line basis. For rates see Subscriber Line Charge/End User Common Line Charge in Section 4 of the Interstate Access Tariff.

GENERAL EXCHANGE TARIFF

Embarq Florida, Inc.

SECTION A11

By: F. B. Poag  
Director

Third Revised Sheet 6  
Cancelling Second Revised Sheet 6  
Effective: May 10, 2002

CENTREX SERVICE  
(Central Telephone exchanges only)

B. CENTREX SERVICE OPTIONAL FEATURES

1. Rates and Charges

	<u>SAE Code</u>	<u>Monthly Rate</u>
a. Optional Features, per line equipped		
1) Automatic Call Distribution		ICB
2) Automatic Line	FAL1FAB	\$ 2.00
3) Class-of-Service Restrictions	FRF1FAB	2.00
4) Meet-Me-Conference	FMM1FAB	.50
5) Multiple Appearance Directory Number (MADN)		
Multiple Call Arrangement (Per Customer Group)	FAM1FAB(GRP)	5.75
Single Call Arrangement (Per Business Set)	FAM1FAB(LIN)	1.75
6) Music On-Hold (Per Customer Group)	FAI1FAB	25.00
7) Secondary Directory Number (Per Directory Number)	FNX1FAB	1.75
8) Speed Call Long - Customer Group		
Speed Call 30	FS31FAB	.80
Speed Call 50	FS51FAB	.95
9) Uniform Call Distribution	1FCY(ADM)	ICB

GENERAL EXCHANGE TARIFF

Embarq Florida, Inc.

By: F. B. Poag  
Director

SECTION A11  
Second Revised Sheet 7  
Cancelling First Revised Sheet 7  
Effective: May 10, 2002

CENTREX SERVICE  
(Central Telephone exchanges only)

C. EXPRESSTOUCH<sup>SM</sup> CENTREX FEATURES

1. General

ExpressTouch Centrex features are central office call management features offered to Centrex customers in addition to the optional features offered previously in this section of the tariff.

2. Regulations

a. The following regulations apply to the features listed in 3. following:

- 1) ExpressTouch Centrex features are provided subject to the availability of facilities. Additionally, the features described will only operate on call originating and terminating within the Custom Local Area Signaling Services (CLASS) serving areas.
- 2) In no event shall the Company be held liable for any losses or damages arising from the unavailability or failure of its equipment or facilities, or for any act, omission or failure of performance by the Company or its employees or agents in connection with this service.

b. The following regulations apply to the Caller ID feature only, in addition to the regulations listed in a. preceding.

- 1) If an incoming call is from a caller utilizing a PBX trunk or a rotary line group, the telephone number displayed may be the main number of that PBX or rotary group rather than the directory number accessed by the caller.

GENERAL EXCHANGE TARIFF

Embarq Florida, Inc.

By: F. B. Poag  
Director

SECTION A11  
Fifth Revised Sheet 8  
Cancelling Fourth Revised Sheet 8  
Effective: May 10, 2002

CENTREX SERVICE  
(Central Telephone exchanges only)

C. EXPRESSTOUCH CENTREX FEATURES (Cont'd)

2. Regulations (Cont'd)

- b. The following regulations apply to the Caller ID feature only, in addition to the regulations listed preceding.
  - 2) The Company will deliver all numbers, subject to the technical limitations defined in this tariff, including telephone numbers associated with Nonpublished Listing Service as described in Section A6 of this tariff.
  - 3) Telephone numbers transmitted via Caller ID are intended solely for the use of the Caller ID subscriber. Resale of this information is prohibited by the tariff.
  - 4) Calling numbers will not be displayed on operator-handled calls, access lines where Calling Number Delivery Blocking has been activated, or with calls originating outside of the CLASS serving area.

3. Features

- a. Repeat Dialing - When activated, Repeat Dialing automatically redials the last number the customer attempted to call. If the called line is not busy, the call will be placed and the caller will be notified with a distinctive ring.
- b. Return Call - Return Call enables a customer to place a call to the telephone number associated with the most recent call received, whether or not the call was answered.
- c. Caller ID - this feature enables the customer to view on a display unit the directory number of an incoming telephone call. The display unit may be an ancillary device which is attached to the customer's telephone set or may be a special telephone set with the display unit built-in. The calling number will display between the first and second ring.
- d. Calling Number Delivery Blocking - This service is provided at no charge to the subscriber. The service will be provided as described in Section A13.

GENERAL EXCHANGE TARIFF

Embarq Florida, Inc.

By: F. B. Poag  
Director

SECTION A11  
Eighth Revised Sheet 9  
Cancelling Seventh Revised Sheet 9  
Effective: August 7, 2002

CENTREX SERVICE  
(Central Telephone exchanges only)

C. EXPRESSTOUCH<sup>SM</sup> CENTREX FEATURES (Cont'd)

3. Features (Cont'd)

e. Call Tracing

- 1) Call Tracing enables the customer to initiate an automatic trace of the last call received. A usage charge will be assessed on a per-occasion basis for each successful trace made. A trace is considered successful when the customer is informed by the voice response unit that the Call Tracing has been successfully completed. Certain types of calls, i.e., out of the area long distance, cannot be traced using this feature.
- 2) Upon activation by the customer, the call tracing information (calling and called number, the time the call was received, and the time the trace was activated) is recorded and stored until requested by an authorized law enforcement agency. The information collection process is instantaneous and the customer using the feature will be notified immediately if the trace was successful and will then be instructed to contact the local law enforcement agency if they wish to file a complaint. The customer is not provided the traced number.
- 3) If the customer receives another call prior to activating the trace, or receives a Call Waiting indication during the call to be traced, Call Tracing will **not** record the last call, which may not be the call the call trace activation was intended to record.

- f. Call Tracing Denial - This service allows the Call Tracing feature to be blocked. To initiate the blocking feature, the customer must contact the Company. The Company will then install the blocking feature on the customer's line. The blocking feature cannot be deactivated by the customer. This feature is provided at no charge to the customer.

4. Rates and Charges

Per Line	Monthly Rates
a. Return Call	\$ 2.50
b. Repeat Dialing	2.00
c. Caller ID	5.50
d. Call Tracing	See Section A13.F.4.C

GENERAL EXCHANGE TARIFF

Embarq Florida, Inc.

By: F. B. Poag  
Director

SECTION A11  
Third Revised Sheet 9.1  
Cancelling Second Revised Sheet 9.1  
Effective: May 10, 2002

CENTREX SERVICE  
(Central Telephone exchanges only)

RESERVED FOR FUTURE USE



GENERAL EXCHANGE TARIFF

Embarq Florida, Inc.

By: F. B. Poag  
Director

SECTION A11  
Fifth Revised Sheet 10  
Cancelling Fourth Revised Sheet 10  
Effective: May 10, 2002

CENTREX SERVICE  
(Central Telephone exchanges only)

RESERVED FOR FUTURE USE

GENERAL EXCHANGE TARIFF

Embarq Florida, Inc.

By: F. B. Poag  
Director

SECTION A11  
Second Revised Sheet 11  
Cancelling First Revised Sheet 11  
Effective: May 10, 2002

CENTREX SERVICE  
(Central Telephone exchanges only)

RESERVED FOR FUTURE USE

GENERAL EXCHANGE TARIFF

Embarq Florida, Inc.

By: F. B. Poag  
Director

SECTION A11  
Second Revised Sheet 12  
Cancelling First Revised Sheet 12  
Effective: May 10, 2002

CENTREX SERVICE  
(Central Telephone exchanges only)

RESERVED FOR FUTURE USE

GENERAL EXCHANGE TARIFF

Embarq Florida, Inc.

By: F. B. Poag  
Director

SECTION A11  
Second Revised Sheet 13  
Cancelling First Revised Sheet 13  
Effective: May 10, 2002

CENTREX SERVICE  
(Central Telephone exchanges only)

RESERVED FOR FUTURE USE

GENERAL EXCHANGE TARIFF

Embarq Florida, Inc.

By: F. B. Poag  
Director

SECTION A11  
Second Revised Sheet 14  
Cancelling First Revised Sheet 14  
Effective: May 10, 2002

CENTREX SERVICE  
(Central Telephone exchanges only)

RESERVED FOR FUTURE USE

GENERAL EXCHANGE TARIFF

Embarq Florida, Inc.

By: F. B. Poag  
Director

SECTION A11  
Second Revised Sheet 15  
Cancelling First Revised Sheet 15  
Effective: May 10, 2002

CENTREX SERVICE  
(Central Telephone exchanges only)

RESERVED FOR FUTURE USE

GENERAL EXCHANGE TARIFF

Embarq Florida, Inc.

By: F. B. Poag  
Director

SECTION A11  
Second Revised Sheet 16  
Cancelling First Revised Sheet 16  
Effective: May 10, 2002

CENTREX SERVICE  
(Central Telephone exchanges only)

RESERVED FOR FUTURE USE

GENERAL EXCHANGE TARIFF

Embarq Florida, Inc.

By: F. B. Poag  
Director

SECTION A11  
Second Revised Sheet 17  
Cancelling First Revised Sheet 17  
Effective: May 10, 2002

CENTREX SERVICE  
(Central Telephone exchanges only)

RESERVED FOR FUTURE USE



GENERAL EXCHANGE TARIFF

Embarq Florida, Inc.

By: F. B. Poag  
Director

SECTION A11  
Second Revised Sheet 18  
Cancelling First Revised Sheet 18  
Effective: May 10, 2002

CENTREX SERVICE  
(Central Telephone exchanges only)

RESERVED FOR FUTURE USE

GENERAL EXCHANGE TARIFF

Embarq Florida, Inc.

By: F. B. Poag  
Director

SECTION A11  
Second Revised Sheet 19  
Cancelling First Revised Sheet 19  
Effective: May 10, 2002

CENTREX SERVICE  
(Central Telephone exchanges only)

RESERVED FOR FUTURE USE

GENERAL EXCHANGE TARIFF

Embarq Florida, Inc.

By: F. B. Poag  
Director

SECTION A11  
Second Revised Sheet 20  
Cancelling First Revised Sheet 20  
Effective: May 10, 2002

CENTREX SERVICE  
(Central Telephone exchanges only)

RESERVED FOR FUTURE USE

GENERAL EXCHANGE TARIFF

Embarq Florida, Inc.

By: F. B. Poag  
Director

SECTION A11  
Second Revised Sheet 21  
Cancelling First Revised Sheet 21  
Effective: May 10, 2002

CENTREX SERVICE  
(Central Telephone exchanges only)

RESERVED FOR FUTURE USE

GENERAL EXCHANGE TARIFF

Embarq Florida, Inc.

By: F. B. Poag  
Director

SECTION A11  
Second Revised Sheet 22  
Cancelling First Revised Sheet 22  
Effective: May 10, 2002

CENTREX SERVICE  
(Central Telephone exchanges only)

RESERVED FOR FUTURE USE

GENERAL EXCHANGE TARIFF

Embarq Florida, Inc.

SECTION A12

By: F. B. Poag  
Director

First Revised Contents Sheet 1  
Cancelling Original Contents Sheet 1  
Effective: January 1, 1997

CENTRAL OFFICE NON-TRANSPORT SERVICE OFFERINGS  
(UNITED TELEPHONE EXCHANGES ONLY)

CONTENTS

A.	CENTREX SERVICE .....	1
1.	General .....	1
2.	Basic System .....	2
3.	Rates and Charges.....	11
B.	STATE OF FLORIDA ELECTRONIC SWITCHED NETWORK (SUNCOM) .....	17
1.	General .....	17
2.	SUNCOM Network Switching Services .....	17
3.	Rates and Charges.....	18
C.	ENHANCED CENTREX SERVICE .....	20
1.	General .....	20
2.	Regulations.....	22
3.	Definitions .....	27
4.	Intercept of Calls to Unassigned Station Lines.....	44
5.	Conversion of Basic Centrex Service to Enhanced Centrex Service .....	44
6.	Payment Schedules.....	46
7.	Common Rates and Charges .....	48
8.	Rates and Charges.....	60
9.	Optional Service Features .....	70
D.	EXPRESSTOUCH CENTREX FEATURES .....	89
1.	General .....	89
2.	Regulations of Service.....	89
3.	Features.....	91
4.	Rates and Charges.....	93

GENERAL EXCHANGE TARIFF

Embarq Florida, Inc.

By: F. B. Poag  
Director

SECTION A12  
Fifth Revised Sheet 1  
Canceling Fourth Revised Sheet 1  
Effective: March 1, 2003

CENTRAL OFFICE NON-TRANSPORT SERVICE OFFERINGS  
(UNITED TELEPHONE EXCHANGES ONLY)

A. CENTREX SERVICE

1. General

- a. Centrex Service is a central office communications system package provided in association with individual line exchange business and residence services furnished where available from digital central office equipment located in Company buildings. Centrex is not provided in association with PBX trunks or pay telephone service.
- b. Centrex is offered as a customer option and may be provided subject to the availability of facilities and central office equipment as determined by the Company.
- c. A combination of business and residence lines in a Centrex system is not permitted. All exchange lines in a Centrex system must be of the same type, i.e., must be either flat rate or measured service, and must be billed to the same account.
- d. Centrex provides for a system accommodating from one to twenty-five central office lines. All exchange access lines terminating in a Centrex system must be served by the same central office.
- e. Suspension of service as provided in Section A2 of this Tariff, is permitted in connection with Centrex.

GENERAL EXCHANGE TARIFF

Embarq Florida, Inc.

By: F. B. Poag  
Director

SECTION A12  
Third Revised Sheet 2  
Cancelling Second Revised Sheet 2  
Effective: December 1, 1997

CENTRAL OFFICE NON-TRANSPORT SERVICE OFFERINGS  
(UNITED TELEPHONE EXCHANGES ONLY)

A. CENTREX SERVICE (Cont'd)

1. General (Cont'd)

- g. The quality of transmission for calls utilizing call forwarding or conferencing may vary depending on the distance and routing involved.
- h. Customer premises equipment associated with this service is provided by the customer.
- i. Payment Plans
  - 1) A minimum term payment plan of twelve months shall be applicable to Basic Centrex Systems.
  - 2) The termination liability for the Basic Centrex System is such that if a subscriber terminates their Centrex service prior to the expiration of the twelve month period, the subscriber shall immediately pay a termination liability in the amount of 100% of the monthly charges remaining in that twelve month period.
  - 3) At the expiration of the 12 month service period, the subscriber's service period will automatically renew for successive periods of 12 months each at the then current tariff rates, unless the subscriber provides written or verbal notice of termination at least thirty (30) days in advance of any scheduled renewal.

2. Basic System

a. Standard Features

- 1) Call Hold  
Allows a station user to place a call on hold by flashing the switchhook and dialing a code.
- 2) Call Pickup  
Allows a station user to answer another station users incoming call within a defined group by dialing a code.
- 3) Ring Again (Camp On)  
Allows a station user encountering a busy station, within the same station group, to be notified when the busy station becomes idle and to be placed automatically in a ring again mode.



GENERAL EXCHANGE TARIFF

Embarq Florida, Inc.

By: F. B. Poag  
Director

SECTION A12  
First Revised Sheet 3  
Cancelling Original Sheet 3  
Effective: January 1, 1997

CENTRAL OFFICE NON-TRANSPORT SERVICE OFFERINGS  
(UNITED TELEPHONE EXCHANGES ONLY)

A. CENTREX SERVICE (Cont'd)

2. Basic System (Cont'd)

a. Standard Features (Cont'd)

4) Station-To-Station Calling

Allows stations within a group to complete calls to other stations within the same group without the assistance of an attendant, by dialing a 2 through 7 digit number.

5) Three-Way Conference/Transfer/Consultation Hold

Allows a station user to establish three-way conference calls and provides the capability to transfer incoming, outgoing, and intragroup calls. The user may also place a call on hold to consult privately with a third party.

b. Optional Features

1) Call Forward - Don't Answer

Allows for forwarding of an incoming call to a preselected line within the system when the called line does not answer after a predetermined number of rings.

GENERAL EXCHANGE TARIFF

Embarq Florida, Inc.

By: F. B. Poag  
Director

SECTION A12  
First Revised Sheet 4  
Cancelling Original Sheet 4  
Effective: January 1, 1997

CENTRAL OFFICE NON-TRANSPORT SERVICE OFFERINGS  
(UNITED TELEPHONE EXCHANGES ONLY)

A. CENTREX SERVICE (Cont'd)

2. Basic System (Cont'd)

b. Optional Features (Cont'd)

2) Call Forward - Busy

Allows for forwarding of an incoming call to a preselected line within the system when the called station is in use.

3) Call Forwarding

Allows all calls to a line equipped with Centrex to be automatically forwarded to a selected line within the system or outside the system.

4) Call Waiting

Provides the station user, who is busy on an existing call, with a private tone signal which indicates that another call is waiting. The station user may then ignore the waiting call; or terminate the original call and answer the waiting call; or, through the use of switchhook flashes, put the original call on hold and receive the waiting call; or alternately talk on both calls until one is terminated. (This feature cannot be utilized if Call Forward - Busy or Call Forward - Don't Answer is activated.)

GENERAL EXCHANGE TARIFF

Embarq Florida, Inc.

By: F. B. Poag  
Director

SECTION A12  
First Revised Sheet 5  
Cancelling Original Sheet 5  
Effective: January 1, 1997

CENTRAL OFFICE NON-TRANSPORT SERVICE OFFERINGS  
(UNITED TELEPHONE EXCHANGES ONLY)

A. CENTREX SERVICE (Cont'd)

2. Basic System (Cont'd)

b. Optional Features (Cont'd)

5) Class-of-Service Restrictions

Provides the ability to allow or deny all calls originating or terminating on individual stations and tie trunks. Three types are offered.

a) Fully Restricted Service - stations are denied access to the exchange network.

b) Toll Restricted Service - restricts stations from toll calls.

c) Unrestricted Service - no restriction on calls.

6) Station Controlled Conference

Allows a station user to establish a conference call consisting of three to six conferees.

7) Meet-Me-Conference

Provides one six-party conference bridge and directory number for conferees to dial at a specified time to hold a conference.

GENERAL EXCHANGE TARIFF

Embarq Florida, Inc.

By: F. B. Poag  
Director

SECTION A12  
First Revised Sheet 6  
Cancelling Original Sheet 6  
Effective: January 1, 1997

CENTRAL OFFICE NON-TRANSPORT SERVICE OFFERINGS  
(UNITED TELEPHONE EXCHANGES ONLY)

A. CENTREX SERVICE (Cont'd)

2. Basic System (Cont'd)

b. Optional Features (Cont'd)

8) Speed Call - Station

Allows a station user to reach frequently dialed numbers by dialing an abbreviated code.

- a) Speed Call 10 - 1-10 telephone numbers
- b) Speed Call 30 - 1-30 telephone numbers
- c) Speed Call 50 - 1-50 telephone numbers

9) Speed Call - Group

Provides all lines with the ability to dial telephone numbers from a group list by dialing an abbreviated code.

- a) Group Speed Call 30 - up to 30 telephone numbers
- b) Group Speed Call 50 - up to 50 telephone numbers

GENERAL EXCHANGE TARIFF

Embarq Florida, Inc.

By: F. B. Poag  
Director

SECTION A12  
First Revised Sheet 7  
Cancelling Original Sheet 7  
Effective: January 1, 1997

CENTRAL OFFICE NON-TRANSPORT SERVICE OFFERINGS  
(UNITED TELEPHONE EXCHANGES ONLY)

A. CENTREX SERVICE (Cont'd)

2. Basic System (Cont'd)

b. Optional Features (Cont'd)

10) Automatic Line

A predetermined telephone number is automatically dialed when the station handset is taken off-hook.

11) Call Park

Allows a station user to put the call on hold and then retrieve the call at another extension.

12) Station Hunting

Provides Directory Number Hunt, Circular Line Hunt and Multi-line Hunt arrangements.

13) Off-Premises Extension Station

Permits access to Centrex features for a station that is located off the customers premises but within the same central office.

GENERAL EXCHANGE TARIFF

Embarq Florida, Inc.

By: F. B. Poag  
Director

SECTION A12  
First Revised Sheet 8  
Cancelling Original Sheet 8  
Effective: January 1, 1997

CENTRAL OFFICE NON-TRANSPORT SERVICE OFFERINGS  
(UNITED TELEPHONE EXCHANGES ONLY)

A. CENTREX SERVICE (Cont'd)

2. Basic System (Cont'd)

b. Optional Features (Cont'd)

14) Centrex Toll Free Code (TFC) Service

A feature designed to meet the needs of Centrex customers who utilize TFC Service by providing the TFC Service connection to Centrex equipped lines in the serving central office.

15) Centrex OUTWATS

A feature designed to meet the needs of Centrex customers who utilize OUTWATS by providing the OUTWATS connection to Centrex equipped lines in the serving central office through dial access.

16) Centrex OUTWATS/Callback Queue

A feature designed to meet the needs of Centrex customers who utilize OUTWATS by providing the OUTWATS connection to Centrex equipped lines in the serving central office through dial access. The queue feature allows the central office to signal a waiting OUTWATS user when the line is available.

GENERAL EXCHANGE TARIFF

Embarq Florida, Inc.

By: F. B. Poag  
Director

SECTION A12  
First Revised Sheet 9  
Cancelling Original Sheet 9  
Effective: January 1, 1997

CENTRAL OFFICE NON-TRANSPORT SERVICE OFFERINGS  
(UNITED TELEPHONE EXCHANGES ONLY)

A. CENTREX SERVICE (Cont'd)

2. Basic System (Cont'd)

b. Optional Features (Cont'd)

17) Multiple Appearance Directory Number (MADN)

Permits the assignment of a directory number to more than one business set.

Multiple call arrangement - allows simultaneous use of more than one business set with the same directory number.

Single call arrangement - allows only one business set with the same directory number to be used at any given time.

18) Auto Answer Back

An incoming call is automatically answered through a hands free unit after four seconds.

19) Fictitious Directory Number

Permits the assignment of more than one directory number to the same station line.

GENERAL EXCHANGE TARIFF

Embarq Florida, Inc.

By: F. B. Poag  
Director

SECTION A12  
First Revised Sheet 10  
Cancelling Original Sheet 10  
Effective: January 1, 1997

CENTRAL OFFICE NON-TRANSPORT SERVICE OFFERINGS  
(UNITED TELEPHONE EXCHANGES ONLY)

A. CENTREX SERVICE (Cont'd)

2. Basic System (Cont'd)

b. Optional Features (Cont'd)

20) Music-On-Hold

Provides music to the calling party while on hold. This feature is only available in central offices which currently have music sources.



GENERAL EXCHANGE TARIFF

Embarq Florida, Inc.

SECTION A12

By: F. B. Poag  
Director

Seventh Revised Sheet 11  
Cancelling Sixth Revised Sheet 11  
Effective: December 24, 2004

CENTRAL OFFICE NON-TRANSPORT SERVICE OFFERINGS  
(UNITED TELEPHONE EXCHANGES ONLY)

A. CENTREX SERVICE (Cont'd)

3. Rates and Charges

The following rates and charges are for Centrex service only and are in addition to the applicable service connection charges, monthly local exchange access line rates and nonrecurring charges for individual exchange access lines and other services or equipment with which they are associated.

	<u>System Size</u>	<u>12 Month Rate Per Month</u>
a. Centrex - Basic System, per line equipped. Includes all standard features.	1 - 25 lines	\$5.50 each
b. Optional Features, per line equipped		
Call Forward - Don't Answer		1.50
Call Forward - Busy		1.50
Call Forwarding		2.00
Call Waiting		3.00
Class-of-Service Restrictions		2.00
Station Controlled Conference		.50
Meet-Me-Conference		1.00
Speed Call - Station		
Speed Call 10		.75
Speed Call 30		2.00
Speed Call 50		3.00
Speed Call - Group		
Group Speed Call 30		.80
Group Speed Call 50		.95

GENERAL EXCHANGE TARIFF

Embarq Florida, Inc.

SECTION A12

By: F. B. Poag  
Director

Third Revised Sheet 12  
Cancelling Second Revised Sheet 12  
Effective: November 12, 2004

CENTRAL OFFICE NON-TRANSPORT SERVICE OFFERINGS  
(UNITED TELEPHONE EXCHANGES ONLY)

A. CENTREX SERVICE (Cont'd)

3. Rates and Charges (Cont'd)

b. Optional Features, per line equipped (Cont'd)

	<u>System Size</u>	<u>12 Month Rate Per Month</u>
Automatic Line		2.00
Call Park		.50
Station Hunting		25% of B-1 Rate
Off-Premises Extension Station		2.50
Centrex TFC Service		2.50
Centrex OUTWATS		2.50
Centrex OUTWATS/Callback Queue		3.00
	<u>Nonrecurring Charge</u>	<u>Monthly Rate</u>
Multiple Appearance Directory Number (MADN)		
Multiple call arrangement		
Per MADN group	\$5.75	\$5.75
Per line	-	25% of B-1 Rate
Single call arrangement		
Per business set	1.75	.45
Auto Answer Back		
Per business set	1.45	2.95
Fictitious Directory Number		
Per directory number	1.75	2.00

GENERAL EXCHANGE TARIFF

Embarq Florida, Inc.

By: F. B. Poag  
Director

SECTION A12  
Second Revised Sheet 13  
Cancels First Revised Sheet 13  
Effective: May 10, 2002

CENTRAL OFFICE NON-TRANSPORT SERVICE OFFERINGS  
(UNITED TELEPHONE EXCHANGES ONLY)

A. CENTREX SERVICE (Cont'd)

3. Rates and Charges (Cont'd)

b. (Cont'd)

	<u>System Size</u>	<u>12 Month Rate Per Month</u>
Music-On-Hold, Per system		
1 - 7 lines	-	20.00
8 - 14 lines	-	25.00
15 - 25 lines	-	30.00

NOTE: A subscriber to Centrex Basic may select features from the Enhanced Centrex tariff providing the selected features are not offered in the Centrex Basic tariff. The applicable rates and charges for the selected features are specified in the Enhanced Centrex tariff.

GENERAL EXCHANGE TARIFF

Embarq Florida, Inc.

By: F. B. Poag  
Director

SECTION A12  
Second Revised Sheet 14  
Cancels First Revised Sheet 14  
Effective: May 10, 2002

CENTRAL OFFICE NON-TRANSPORT SERVICE OFFERINGS  
(UNITED TELEPHONE EXCHANGES ONLY)

A. CENTREX SERVICE (Cont'd)

3. Rates and Charges (Cont'd)

c. Service Establishment Charges

1) <u>System Size</u>	<u>Service Establishment Charge, per system</u>	<u>Charge Per Line</u>
1 - 7 lines	\$40.00	\$3.00
8 - 14 lines	75.00	3.00
15 - 25 lines	95.00	3.00

2) A charge of \$3.00 per line added to the Centrex Basic System is applicable whenever additional lines are requested subsequent to initial system installation. This is in addition to the appropriate service connection charges.

3) Centrex WATS features are subject to the rates and regulations applicable to all WATS services as specified in this tariff and other tariffs in which the Company concurs.

4) If one or more of the optional Centrex WATS features are requested subsequent to initial system installation, a non-recurring charge of \$40.00 will be applicable in addition to the appropriate service connection charges.

GENERAL EXCHANGE TARIFF

Embarq Florida, Inc.

SECTION A12

By: F. B. Poag  
Director

Third Revised Sheet 15  
Cancelling Second Revised Sheet 15  
Effective: October 13, 2001

CENTRAL OFFICE NON-TRANSPORT SERVICE OFFERINGS  
(UNITED TELEPHONE EXCHANGES ONLY)

A. CENTREX SERVICE (Cont'd)

3. Rates and Charges (Cont'd)

c. Service Establishment Charges (Cont'd)

5) Appropriate extension line mileage charges as specified in other sections of this tariff apply when the Off-Premises Extension Station option is selected by the customer.

d. Centrex Lines Terminating in a Key System

Customers whose Centrex lines terminate in a key system may only subscribe to the following features at the rates as shown. The rates for these features are in addition to the applicable Rotary Line Service local exchange rates.

Service Establishment Charge, per system \$20.00

	<u>12 Month Rate</u> <u>Per Month</u>
Call Forward - Don't Answer	\$ 1.50
Call Forward - Busy	1.50
Call Forwarding	4.50
Call Waiting	4.00
3-Way Conference/Consultation Hold	4.00
Station Controlled Conference	3.00

GENERAL EXCHANGE TARIFF

Embarq Florida, Inc.

By: F. B. Poag  
Director

SECTION A12  
First Revised Sheet 16  
Cancelling Original Sheet 16  
Effective: January 1, 1997

CENTRAL OFFICE NON-TRANSPORT SERVICE OFFERINGS  
(UNITED TELEPHONE EXCHANGES ONLY)

A. CENTREX SERVICE (Cont'd)

3. Rates and Charges (Cont'd)

d. Centrex Lines Terminating in a Key System (Cont'd)

	<u>12 Month Rate Per Month</u>
Speed Call	
Speed Call 10	\$3.00
Speed Call 30	3.50
Speed Call 50	4.00
Centrex TFC Service	2.50
Centrex OUTWATS	2.50
Centrex OUTWATS/Callback Queue	3.00

e. Type "C" Line Card

A type "C" line card is required for use with a customer-provided proprietary telephone set. A proprietary telephone set is one that permits features to be activated through individual key functions rather than through dialing a code. The following rates are applicable per line that is associated with a proprietary set.

<u>Non-Recurring Charge</u>	<u>12 Month Rate Per Month</u>
\$ 5.00	\$2.50

f. Service charges as specified in Section A4 of this tariff are applicable to changes in or additions to an Centrex system.

GENERAL EXCHANGE TARIFF

Embarq Florida, Inc.

By: F. B. Poag  
Director

SECTION A12  
First Revised Sheet 17  
Cancelling Original Sheet 17  
Effective: January 1, 1997

CENTRAL OFFICE NON-TRANSPORT SERVICE OFFERINGS  
(UNITED TELEPHONE EXCHANGES ONLY)

B. STATE OF FLORIDA ELECTRONIC SWITCHED NETWORK (SUNCOM)

1. General

- a. SUNCOM is an Electronic Switched Network (ESN) which provides a private telephone communications network for the government and agencies of the State of Florida as authorized by the State of Florida, Department of General Services.
- b. SUNCOM is provided by the Company within the Fort Myers Market Area (LATA) through an ESN digital switching node which controls switching for all State communications within the Fort Myers Market Area (LATA).
- c. The provision and maintenance of the SUNCOM network within the Fort Myers Market Area (LATA) is by agreement between the Company and the State of Florida, Department of General Services.
- d. Appropriate rules and regulations as specified in this section and other sections of this tariff are applicable to the SUNCOM network.

2. SUNCOM Network Switching Services

- a. ESN Common Equipment - the Fort Myers switching node will be served by the Company's digital central office equipment.

GENERAL EXCHANGE TARIFF

Embarq Florida, Inc.

By: F. B. Poag  
Director

SECTION A12  
First Revised Sheet 18  
Cancelling Original Sheet 18  
Effective: January 1, 1997

CENTRAL OFFICE NON-TRANSPORT SERVICE OFFERINGS  
(UNITED TELEPHONE EXCHANGES ONLY)

B. STATE OF FLORIDA ELECTRONIC SWITCHED NETWORK (SUNCOM) (Cont'd)

2. SUNCOM Network Switching Services (Cont'd)

- b. Network Control Center (NCC) Interface - an arrangement which will connect the SUNCOM switcher to the State's Network Control Center in Tallahassee. The NCC Interface includes the necessary central office equipment, an information processor and two data modems.
- c. Station Message Detail Recording (SMDR) Redundancy - the Company will store a maximum of three days of SUNCOM SMDR data. The stored data will be retrieved and transferred to magnetic tape at the request of the State. The tape will be in SMDR format.

3. Rates and Charges

- a. The non-recurring and monthly rates shown below are applicable for the Fort Myers node of the SUNCOM ESN. These rates are for the ESN service only and are in addition to the monthly charges for access lines, trunks, WATS, Centrex, private lines or any other facilities used in the provision of service at rates as specified in other sections of the tariff.
- b. A charge equal to a telephone number change charge will be applicable for customer requested changes in class-of-service, authorization codes and routing.



GENERAL EXCHANGE TARIFF

Embarq Florida, Inc.

By: F. B. Poag  
Director

SECTION A12  
First Revised Sheet 19  
Cancelling Original Sheet 19  
Effective: January 1, 1997

CENTRAL OFFICE NON-TRANSPORT SERVICE OFFERINGS  
(UNITED TELEPHONE EXCHANGES ONLY)

B. STATE OF FLORIDA ELECTRONIC SWITCHED NETWORK (SUNCOM) (Cont'd)

3. Rates and Charges (Cont'd)

- c. Service connection charges as specified in Section A4 of this tariff are applicable to the establishment of the SUNCOM network and for any subsequent changes to the system.

	<u>Monthly Rates</u>	<u>Non-recurring Charges</u>
d. ESN Common Equipment	\$ 75.00	\$2,500.00
e. ESN Connections, each		
Line Side	16.95	20.00
Trunk Side	17.95	20.00
LONAL/ONAL/WATS Circuits, Each	25.00	20.00
Digital Hi-Capacity Circuit, per channel	11.40	20.00
f. NCC Interface	2,500.00	500.00
g. SMDR Redundancy Data Storage	40.00	450.00
Transfer to magnetic tape, per request	--	110.00

GENERAL EXCHANGE TARIFF

Embarq Florida, Inc.

By: F. B. Poag  
Director

SECTION A12  
First Revised Sheet 20  
Cancelling Original Sheet 20  
Effective: January 1, 1997

CENTRAL OFFICE NON-TRANSPORT SERVICE OFFERINGS  
(UNITED TELEPHONE EXCHANGES ONLY)

B. STATE OF FLORIDA ELECTRONIC SWITCHED NETWORK (SUNCOM) (Cont'd)

3. Rates and Charges (Cont'd)

- h. The customer may furnish a blank magnetic tape or the Company will furnish the tape at the following rate:

	<u>Monthly Rates</u>	<u>Non-recurring Charges</u>
Per tape	--	\$14.50

C. ENHANCED CENTREX SERVICE

1. General

- a. Enhanced Centrex is furnished from digital central office equipment located on Company premises and associated facilities so arranged as to provide the following basic service features:
- 1) Direct Inward Dialing (DID) and Direct Outward Dialing (DOD) of exchange and long distance message network calls to and from stations and attendant positions of an Enhanced Centrex system.
  - 2) Intercommunication calls between stations of the same Enhanced Centrex system.
  - 3) Identified Outward Dialing (IOD), by station number of outgoing long distance message calls dialed by a station. Only calls billed to the subscriber by this Company will be provided this identification.

GENERAL EXCHANGE TARIFF

Embarq Florida, Inc.

By: F. B. Poag  
Director

SECTION A12  
Second Revised Sheet 21  
Cancelling First Revised Sheet 21  
Effective: September 3, 1997

CENTRAL OFFICE NON-TRANSPORT SERVICE OFFERINGS  
(UNITED TELEPHONE EXCHANGES ONLY)

C. ENHANCED CENTREX SERVICE (Cont'd)

1. General (Cont'd)

a. (Cont'd)

- 4) Common recorded announcement interception of calls to unassigned station numbers.
- 5) Basic Station Line Hunting.

b. Enhanced Centrex Service, terminating at a single customer premises location, will be furnished in two categories, based on the size of the subscriber's system.

- 1) Systems with 26-75 Station Lines.
- 2) Systems with 76-150 Station Lines.

c. An Enhanced Centrex System may be comprised of the following components:

Common Equipment  
Network Access  
Main Station Lines  
Terminating Arrangements  
Features

The Common Equipment, Network Access, Main Station Lines and Features components will be included in every system.

The Common Equipment, Network Access and Terminating Arrangements will be at the rates and charges as specified in C. 7. of this section of the tariff.

Main Station Line rates will consist of the intercom charge and the appropriate wire center line mileage charge. These charges are located in C. 8. of this section of the tariff.

GENERAL EXCHANGE TARIFF

Embarq Florida, Inc.

By: F. B. Poag  
Director

SECTION A12  
First Revised Sheet 22  
Cancelling Original Sheet 22  
Effective: January 1, 1997

CENTRAL OFFICE NON-TRANSPORT SERVICE OFFERINGS  
(UNITED TELEPHONE EXCHANGES ONLY)

C. ENHANCED CENTREX SERVICE (Cont'd)

2. Regulations

- a. Enhanced Centrex service is furnished subject to the availability of facilities and features from digital central office equipment, located in a central office building owned or leased by the Company. The service allows for normal station activity including incidental additions and deletions. Major additions to and/or major relocations of Enhanced Centrex systems are subject to the same rules and regulations as initial installations.
- b. Certain auxiliary services are available on an individual main station line basis and are subject to the capabilities of the serving central office.
- c. Optional Service Features as listed in C. 9. include Attendant Features and Auxiliary Attendant Features. These features may require customer provided compatible terminal equipment.
- d. All console functions by the attendants at the subscriber's premises are performed at the expense of the subscriber and must conform with the operating practices and procedures of the Company to maintain a proper standard of service.
- e. All Enhanced Centrex main station lines must be associated with the main switching equipment. Satellite switching equipment is not offered with Enhanced Centrex service.

GENERAL EXCHANGE TARIFF

Embarq Florida, Inc.

By: F. B. Poag  
Director

SECTION A12  
First Revised Sheet 23  
Cancelling Original Sheet 23  
Effective: January 1, 1997

CENTRAL OFFICE NON-TRANSPORT SERVICE OFFERINGS  
(UNITED TELEPHONE EXCHANGES ONLY)

C. ENHANCED CENTREX SERVICE (Cont'd)

2. Regulations (Cont'd)

- f. Tie lines for direct connections between a basic Enhanced Centrex system and other systems are provided primarily for communication between stations of the two systems. In such cases, rates and charges for tie line service as specified in A13 of this Tariff and miscellaneous line termination charges apply. In addition, these tie line connections may be arranged to provide completion of incoming or outgoing local and long distance calls through the Enhanced Centrex system to or from other systems provided such connections to the exchange or long distance network are only made at one system at a time.
- g. Where completion of incoming and outgoing local and long distance calls through an Enhanced Centrex system is furnished to or from main station lines of a separate Enhanced Centrex system in another exchange, the charges applicable for the following features apply in addition to the regular charges for the facilities connecting the systems.
  - 1. Rates and charges as specified in Section B3 of the Southern Bell Private Line Service Tariff apply to miscellaneous lines furnished with unique access codes (trunk level access).
  - 2. Enhanced Centrex optional feature charges as outlined in Section C. 9 apply for each trunk terminated main station line as offered in Section C. 7 of this Tariff, as appropriate.

GENERAL EXCHANGE TARIFF

Embarq Florida, Inc.

By: F. B. Poag  
Director

SECTION A12  
Second Revised Sheet 24  
Cancelling First Revised Sheet 24  
Effective: March 1, 2003

CENTRAL OFFICE NON-TRANSPORT SERVICE OFFERINGS  
(UNITED TELEPHONE EXCHANGES ONLY)

C. ENHANCED CENTREX SERVICE (Cont'd)

2. Regulations (Cont'd)

- h. A system may not be provided for Intercommunication (stand alone) service only. Access to the Exchange Network must be provided.
- i. A combination of Flat Rate and Message Rate Service will not be allowed within a single customer system except as provided in Section A2 of this tariff.
- j. Suspension of Enhanced Centrex Service as described in A2 will be permitted.
- k. A twelve month minimum term payment plan shall be applicable to Enhanced Centrex systems.
- l. Directory Listings will be furnished subject to the rates and regulations specified in Section A6 of this Tariff.

GENERAL EXCHANGE TARIFF

Embarq Florida, Inc.

By: F. B. Poag  
Director

SECTION A12  
Second Revised Sheet 25  
Cancelling First Revised Sheet 25  
Effective: July 17, 1998

CENTRAL OFFICE NON-TRANSPORT SERVICE OFFERINGS  
(UNITED TELEPHONE EXCHANGES ONLY)

C. ENHANCED CENTREX SERVICE (Cont'd)

2. Regulations (Cont'd)

- n. The number of simultaneous exchange and toll network calls to and from main station lines and attendant positions of an Enhanced Centrex system is limited by the number of Network Access Registers subscribed to by the customer. Each Network Access Register may be arranged for two-way, one-way incoming or one-way outgoing operation depending upon the option of the customer at the time the Network Access Register is installed. When a change in the type of operation is requested by the customer, the appropriate Service Charges as specified in Section A4 of this Tariff apply per Network Access Register affected.
- o. Service charges, as specified in Section A4 of this Tariff, apply to all Enhanced Centrex systems except as provided in C. 5. of this Tariff.
- p. Enhanced Centrex installation charges are due on initial installation or subsequent additions unless deferred over a predetermined period of time as specified in Section A22 of this Tariff.
- q. Enhanced Centrex main station lines may be restricted from dialing three-digit central office and service codes by applying Code Restriction to the line. The three-digit codes which may be restricted constitute those codes to which Public Announcement, Directory Assistance or Dial-It type pay-to-listen services (e.g., 900 and 976 calls) are assigned which could generate billing to the originating main station line. Code Restriction arrangements may also be used to prohibit toll calls to a carrier other than the Presubscribed Interexchange Carrier (dialed 101XXXX). InterLATA calls dialed 0-(operator handled) calls cannot be restricted.

GENERAL EXCHANGE TARIFF

Embarq Florida, Inc.

By: F. B. Poag  
Director

SECTION A12  
First Revised Sheet 26  
Cancelling Original Sheet 26  
Effective: January 1, 1997

CENTRAL OFFICE NON-TRANSPORT SERVICE OFFERINGS  
(UNITED TELEPHONE EXCHANGES ONLY)

C. ENHANCED CENTREX SERVICE (Cont'd)

2. Regulations (Cont'd)

q. (Cont'd)

- 1) At the time a Code Restriction arrangement is installed, the Enhanced Centrex system will be arranged for the Code Restriction specified by the customer and the main station lines designated by the customer will be so equipped. When the customer requests the subsequent addition or removal of code restriction on a main station line, the appropriate Service Charges as specified for a change in line termination apply per main station line affected. No such charges apply when the Code Restriction arrangement is disconnected in its entirety.
  - 2) Where Code Restriction applies to a particular central office code, direct outward dialed main station line access is denied to telephone numbers associated with that central office code.
  - 3) Code Restriction arrangements to deny access to Directory Assistance and/or Public Announcement Services are not guaranteed. These features are intended to limit main station line direct dialed outgoing calls, but such calls may, in certain circumstances, be completed and will be charged for in the normal manner.
- r. The first system established per customer within a central office must consist of a minimum of twenty-six (26) main station lines.



GENERAL EXCHANGE TARIFF

Embarq Florida, Inc.

By: F. B. Poag  
Director

SECTION A12  
First Revised Sheet 27  
Cancelling Original Sheet 27  
Effective: January 1, 1997

CENTRAL OFFICE NON-TRANSPORT SERVICE OFFERINGS  
(UNITED TELEPHONE EXCHANGES ONLY)

C. ENHANCED CENTREX SERVICE (Cont'd)

3. Definitions

ACCESS LINES TO CUSTOMER PROVIDED FEATURES

Allows dial access from Enhanced Centrex service for connection to customer provided features. (Code Calling, Loudspeaker Paging, Radio Paging, Dictation and Music)

ATTENDANT AUTODIAL

This feature permits an attendant to dial frequently called numbers by depressing the Autodial feature key, which is programmed with the number.

ATTENDANT CAMP-ON AND CAMP-ON MODE OPTIONS

This feature allows incoming listed number calls, which the attendant attempts to complete to a busy main station line, to be held waiting and then automatically connected when the called main station line becomes available. An indication of camp-on will be given to the busy main station line each time the attendant attempts a completion.

ATTENDANT CONFERENCE

Using a six-port conference circuit, an attendant may interconnect up to five conferees on one call. The sixth port is required for attendant access.

GENERAL EXCHANGE TARIFF

Embarq Florida, Inc.

By: F. B. Poag  
Director

SECTION A12  
First Revised Sheet 28  
Cancelling Original Sheet 28  
Effective: January 1, 1997

CENTRAL OFFICE NON-TRANSPORT SERVICE OFFERINGS  
(UNITED TELEPHONE EXCHANGES ONLY)

C. ENHANCED CENTREX SERVICE (Cont'd)

3. Definitions (Cont'd)

ATTENDANT GROUP TRUNK ACCESS CONTROL

This feature utilizes special keys on the customer provided attendant console to serve as a common interface for trunk group busy and trunk group access for all trunk groups allocated to the customer group.

ATTENDANT POSITION

Customer-provided terminal equipment utilized for attendant control and call connecting functions.

ATTENDANT RECALL TIMER

This feature returns attendant-extended calls to a main station to the attendant after a prescribed waiting period if the main station user is unable to answer.

ATTENDANT SERVICE

Incoming calls to the main listed number are answered by an attendant, who may complete the call to the desired main station line by means of the Call Transfer feature. An unrestricted or semi-restricted main station line user may dial the attendant over attendant lines to secure help in the completion of an outgoing call by means of Dial "O" calling.

GENERAL EXCHANGE TARIFF

Embarq Florida, Inc.

By: F. B. Poag  
Director

SECTION A12  
First Revised Sheet 29  
Cancelling Original Sheet 29  
Effective: January 1, 1997

CENTRAL OFFICE NON-TRANSPORT SERVICE OFFERINGS  
(UNITED TELEPHONE EXCHANGES ONLY)

C. ENHANCED CENTREX SERVICE (Cont'd)

3. Definitions (Cont'd)

AUTOMATIC CALLBACK/RING AGAIN

Automatic Callback permits a main station line user who attempts an intercommunication call to a busy main station line to be automatically connected to that line when both called and calling lines are subsequently idle.

AUTOMATIC LINE

See Direct Connect Number.

AUTOMATIC ROUTE SELECTION

Automatic Route Selection is an optional feature, available where facilities permit, that allows station users, by dialing a preselected code to automatically select the preferred route subscribed for by a customer for network calls. Alternate routing to other facilities, subscribed to by the customer, is also provided. This arrangement is available for use with Foreign Exchange (FX), WATS, CCSA off-net, tie lines and Interexchange Carrier (IC) access lines which are compatible with Automatic Route Selection and toll network facilities.

BASIC TERMINATIONS

See Miscellaneous Line Terminations.

CALL-BACK QUEUE

See Queuing.

GENERAL EXCHANGE TARIFF

Embarq Florida, Inc.

By: F. B. Poag  
Director

SECTION A12  
First Revised Sheet 30  
Cancelling Original Sheet 30  
Effective: January 1, 1997

CENTRAL OFFICE NON-TRANSPORT SERVICE OFFERINGS  
(UNITED TELEPHONE EXCHANGES ONLY)

C. ENHANCED CENTREX SERVICE (Cont'd)

3. Definitions (Cont'd)

CALL FORWARDING - ALL CALLS

Automatically routes all incoming calls to the attendant or a predetermined telephone number.

CALL FORWARDING-BUSY LINE

Automatically routes calls to the attendant or preselected main station line when the called main station line is busy.

CALL FORWARDING-NO ANSWER

Automatically routes calls to the attendant or preselected main station line when the called main station line doesn't answer within the preset ringing cycle.

CALL HOLD

Allows a main station line user to place any call involving their main station line on hold by flashing and dialing a special code. The main station line is then free to originate another call. The first call is retrieved by dialing the hold code a second time.

CALL PARK

Call Park allows the attendant to park calls against any directory in the attendant customer group. The parked call may be retrieved from any station by dialing the feature access code for retrieval plus the directory number.

GENERAL EXCHANGE TARIFF

Embarq Florida, Inc.

By: F. B. Poag  
Director

SECTION A12  
First Revised Sheet 31  
Cancelling Original Sheet 31  
Effective: January 1, 1997

CENTRAL OFFICE NON-TRANSPORT SERVICE OFFERINGS  
(UNITED TELEPHONE EXCHANGES ONLY)

C. ENHANCED CENTREX SERVICE (Cont'd)

3. Definitions (Cont'd)

CALL PICKUP

Allows a main station line user to answer calls directed to another main station line within the same preset call pick-up group.

CALL TRANSFER

Call Transfer provides for the transfer of calls by an Enhanced Centrex station. The Call Transfer feature is needed in addition to Three-way Calling if the station's type of call transfer is different from the call transfer type selected for the customer's group.

CALL WAITING-DIAL

The Dial Call Waiting feature provides the ability for originating main station lines to invoke call waiting service on selected intragroup calls by dialing an access code followed by the extension number of the main station line to be call waited.

CALL WAITING-EXEMPT

Prevents the Call Waiting-Originating or the Dial Call Waiting features from being imposed on the line when the station is busy.

CALL WAITING-ORIGINATING

Allows an equipped main station line to send the Call Waiting tone to any busy main station line in the same system.

GENERAL EXCHANGE TARIFF

Embarq Florida, Inc.

By: F. B. Poag  
Director

SECTION A12  
First Revised Sheet 32  
Cancelling Original Sheet 32  
Effective: January 1, 1997

CENTRAL OFFICE NON-TRANSPORT SERVICE OFFERINGS  
(UNITED TELEPHONE EXCHANGES ONLY)

C. ENHANCED CENTREX SERVICE (Cont'd)

3. Definitions (Cont'd)

CALL WAITING-TERMINATING

Informs a busy main station line, when the main station line is so equipped, that an incoming call is waiting (burst of tone). Permits holding the present connection while answering the new call then return to the original connection.

CODE RESTRICTION ARRANGEMENTS

A Code Restriction Arrangement automatically denies a portion of all main station lines of a Enhanced Centrex system direct outward dialing access to one or more three-digit codes within the local calling area in which the system is located. Code restriction provides a distinctive tone to indicate that access is not permitted on call attempts.

CONFERENCE CALLING-STATION

Allows a main station user to establish a conference connection of up to six conferees (including the originator) without the aid of the attendant.

CONSULTATION HOLD-ALL CALLS

Allows a main station user to place a call on hold by depressing the switchhook, at which time dial tone is returned. The station user may then proceed to establish connection with another internal station or outside party, and after speaking with the "consulted" party, the station user may (1) return to the call initially held, (2) depress the switchhook thereby effecting Add-On Conference or (3) hang up and effect transfer of the initial call to the consulted party.

GENERAL EXCHANGE TARIFF

Embarq Florida, Inc.

By: F. B. Poag  
Director

SECTION A12  
First Revised Sheet 33  
Cancelling Original Sheet 33  
Effective: January 1, 1997

CENTRAL OFFICE NON-TRANSPORT SERVICE OFFERINGS  
(UNITED TELEPHONE EXCHANGES ONLY)

C. ENHANCED CENTREX SERVICE (Cont'd)

3. Definitions (Cont'd)

CUSTOMER GROUP

A Customer Group is that portion of the memory storage in the serving central office that contains the features for a specific system.

DATA CALL PROTECTION

Data Call Protection prevents calls from being interrupted by call waiting tones, testing or busy verification attempts. Data call protection is not customer changeable and lines assigned this feature may not utilize call transfer or conference capabilities.

DIAL "O" CALLING

Dial "O" Calling permits a main station line user to reach an attendant position by dialing the single digit "O".

DIAL CODE SENDING (CODE CALLING) FEATURE

Code Calling provides dial access to customer-premises located code calling equipment by main station line, attendant access and tie lines of an Enhanced Centrex system. The dialed two or three digit code activates signaling devices on the customer's premises to produce a coded signal corresponding to the dialed code. The called party, upon recognition of the signal, is automatically connected to the calling party by dialing a special code from any main station line in the system.

GENERAL EXCHANGE TARIFF

Embarq Florida, Inc.

By: F. B. Poag  
Director

SECTION A12  
First Revised Sheet 34  
Cancelling Original Sheet 34  
Effective: January 1, 1997

CENTRAL OFFICE NON-TRANSPORT SERVICE OFFERINGS  
(UNITED TELEPHONE EXCHANGES ONLY)

C. ENHANCED CENTREX SERVICE (Cont'd)

3. Definitions (Cont'd)

DIAL THRU ATTENDANT

This feature allows main station line users to complete dialing on other than station-to-station calls after the attendant selects the trunk facility.

DIRECT CONNECT NUMBER/AUTOMATIC LINE

Station specially programmed to dial a predetermined telephone number when the station user goes off-hook.

DIRECT INWARD DIALING

Incoming calls from the exchange or toll network may be dialed directly or any called main station line served by the Enhanced Centrex main switching equipment without the help of an attendant.

DIRECT OUTWARD DIALING

Outward calls may be dialed directly from any unrestricted main station line served by the Enhanced Centrex main switching equipment without the help of an attendant.



GENERAL EXCHANGE TARIFF

Embarq Florida, Inc.

By: F. B. Poag  
Director

SECTION A12  
First Revised Sheet 35  
Cancelling Original Sheet 35  
Effective: January 1, 1997

CENTRAL OFFICE NON-TRANSPORT SERVICE OFFERINGS  
(UNITED TELEPHONE EXCHANGES ONLY)

C. ENHANCED CENTREX SERVICE (Cont'd)

3. Definitions (Cont'd)

DIRECTED CALL PICK-UP - NONBARGE-IN

The Directed Call Pick-Up - Nonbarge-In feature allows a main station line user to pick up an unanswered call to another main station line equipped with Directed Call Pick-Up by dialing a special answer code plus the number of the main station line being rung. If the main station line being rung has already answered, busy tone will be returned to the main station line user dialing the answer code and station line number.

DIRECTED CALL PICK-UP -NONBARGE-IN EXEMPT

Directed Call Pick-Up - Nonbarge-In Exempt allows a station to be exempt from Directed Call Pick-Up Non-Barge In.

DIRECTORY NUMBER HUNTING

See Station Hunting Arrangements

DISTINCTIVE CALL WAITING TONES

Distinctive Call Waiting provides different tones for an incoming waiting call depending on whether the incoming call is internal or external.

DISTRIBUTED LINE HUNTING

See Station Hunting Arrangements

GENERAL EXCHANGE TARIFF

Embarq Florida, Inc.

By: F. B. Poag  
Director

SECTION A12  
First Revised Sheet 36  
Cancelling Original Sheet 36  
Effective: January 1, 1997

CENTRAL OFFICE NON-TRANSPORT SERVICE OFFERINGS  
(UNITED TELEPHONE EXCHANGES ONLY)

C. ENHANCED CENTREX SERVICE (Cont'd)

3. Definitions (Cont'd)

EXECUTIVE BUSY OVERRIDE

Executive Busy Override allows a station user to gain access to a busy station within the same system. A warning tone is transmitted to the called station and then a three-way call is established.

EXECUTIVE BUSY OVERRIDE-EXEMPT

A line equipped with this feature is exempt from override attempts.

FACILITY GROUPS

Provides simulated trunk group access for miscellaneous line terminations. A Facility Group may be one-way (incoming or out-going) or two-way operational.

INTERCEPT

Intrasystem and incoming network calls dialed to unassigned numbers are routed to recorded announcements.

INTERPOSITION TRANSFERS

This feature allows an attendant to call and speak to another attendant and to transfer a call to another attendant.

GENERAL EXCHANGE TARIFF

Embarq Florida, Inc.

By: F. B. Poag  
Director

SECTION A12  
First Revised Sheet 37  
Cancelling Original Sheet 37  
Effective: January 1, 1997

CENTRAL OFFICE NON-TRANSPORT SERVICE OFFERINGS  
(UNITED TELEPHONE EXCHANGES ONLY)

C. ENHANCED CENTREX SERVICE (Cont'd)

3. Definitions (Cont'd)

MAIN STATION EXTENSION SERVICE

Main station extension service consists of an additional station or stations on the same station circuit as the associated main station.

MAIN STATION LINE

A main station line connects customer provided terminal equipment to the serving central office.

MISCELLANEOUS LINE TERMINATIONS

Miscellaneous lines are those lines not basic to the system; such as tie lines, WATS, Foreign Exchange, CCSA, etc., which required switching capabilities in order to function with Enhanced Centrex service.

MULTI-LINE HUNT GROUP (Basic)

See Station Hunting Arrangements

NETWORK ACCESS REGISTER

The Network Access Register provides for exchange and long distance message network calling to and from main stations and attendant positions of an Enhanced Centrex system.

GENERAL EXCHANGE TARIFF

Embarq Florida, Inc.

By: F. B. Poag  
Director

SECTION A12  
First Revised Sheet 38  
Cancelling Original Sheet 38  
Effective: January 1, 1997

CENTRAL OFFICE NON-TRANSPORT SERVICE OFFERINGS  
(UNITED TELEPHONE EXCHANGES ONLY)

C. ENHANCED CENTREX SERVICE (Cont'd)

3. Definitions (Cont'd)

NETWORK CLASS OF SERVICE

This feature provides the capability to allow or deny types of calls to a station on both an incoming and an outgoing basis.

OFF-HOOK QUEUE

See Queuing.

PERMANENT HOLD

Allows a main station user to place any call involving their main station line on hold by flashing the switchhook and dialing a special code. When Permanent Hold is activated no calls can be originated or terminated from the main station line. The first call is retrieved by going off-hook. If the call is not retrieved within a time designated by the customer, the station line will ring and the held call will be returned.

QUEUING

Queuing permits station users to be placed in a queue whenever the first choice route for completing a particular call is already in use. Two queuing arrangements are available:

- A Call-Back Queue, in which case the calling station goes on-hook and is called back when a facility becomes available.

GENERAL EXCHANGE TARIFF

Embarq Florida, Inc.

By: F. B. Poag  
Director

SECTION A12  
First Revised Sheet 39  
Cancelling Original Sheet 39  
Effective: January 1, 1997

CENTRAL OFFICE NON-TRANSPORT SERVICE OFFERINGS  
(UNITED TELEPHONE EXCHANGES ONLY)

C. ENHANCED CENTREX SERVICE (Cont'd)

3. Definitions (Cont'd)

QUEUING (Cont'd)

- An Off-Hook Queue, in which case the calling station remains off-hook and is held in queue until a facility becomes available.

RING AGAIN

See Automatic Callback.

SPEED CALLING

Lets the main station line user place calls to a list of frequently called telephone numbers by dialing fewer digits than the complete directory number.

STATION DIRECT INWARD DIALING RESTRICTION

Permits the customer to have selected main station lines restricted from receiving Direct In-Dialed calls from the MTS network. Direct In-Dial call attempts will be routed to the attendant.

STATION HUNTING ARRANGEMENTS

Directory Number Hunt, Distributed Line Hunt and Uniform Call Distribution are optional main station line hunt arrangements for searching over and distributing calls in a hunt group. These hunts are extensions of the basic multi line hunting feature included in Enhanced Centrex service.

GENERAL EXCHANGE TARIFF

Embarq Florida, Inc.

By: F. B. Poag  
Director

SECTION A12  
First Revised Sheet 40  
Cancelling Original Sheet 40  
Effective: January 1, 1997

CENTRAL OFFICE NON-TRANSPORT SERVICE OFFERINGS  
(UNITED TELEPHONE EXCHANGES ONLY)

C. ENHANCED CENTREX SERVICE (Cont'd)

3. Definitions (Cont'd)

STATION HUNTING ARRANGEMENTS (Cont'd)

Directory Number Hunting

Each line in a Directory Number Hunt group has its own unique directory number. The hunt group is accessed by dialing any number in the hunt group. The number of lines hunted depends on the hunting option (i.e., circular or sequential assigned to the group).

- Circular hunt permits a complete hunt over all the terminals in the group starting and ending with the dialed number.
- Sequential hunting starts at the number dialed and ends at the last number in the group.

Distributed Line Hunting

With Distributed Line Hunting, hunting starts after the first idle line found by the previous hunt and continues until the starting point is reached. Provides for an equal distribution of calls.

GENERAL EXCHANGE TARIFF

Embarq Florida, Inc.

By: F. B. Poag  
Director

SECTION A12  
First Revised Sheet 41  
Cancelling Original Sheet 41  
Effective: January 1, 1997

CENTRAL OFFICE NON-TRANSPORT SERVICE OFFERINGS  
(UNITED TELEPHONE EXCHANGES ONLY)

C. ENHANCED CENTREX SERVICE (Cont'd)

3. Definitions (Cont'd)

STATION HUNTING ARRANGEMENTS (Cont'd)

Uniform Call Distribution (Cont'd)

Multi-Line Hunt Group (Basic)

When a call is originated to a busy station line in a basic multi-line hunting group, the call hunts once in a prearranged order for an idle station through all remaining station lines in that group.

Uniform Call Distribution

Uniform Call Distribution provides an even distribution of incoming network and intercom calls among the individual main station lines of a hunt group and includes Circular Hunt.

- Call Queuing is an option that may be added to the Uniform Call Distribution arrangement. Queuing permits calls, in excess of main station lines in a Uniform Call Distribution group, to be held in the central office and distributed in their order of arrival to main station lines in the group as the main station lines become available.

GENERAL EXCHANGE TARIFF

Embarq Florida, Inc.

By: F. B. Poag  
Director

SECTION A12  
First Revised Sheet 42  
Cancelling Original Sheet 42  
Effective: January 1, 1997

CENTRAL OFFICE NON-TRANSPORT SERVICE OFFERINGS  
(UNITED TELEPHONE EXCHANGES ONLY)

C. ENHANCED CENTREX SERVICE (Cont'd)

3. Definitions (Cont'd)

STATION IDENTIFICATION

An itemized list of toll calls is shown on the toll bill with the number of each originating main station line.

STATION MESSAGE DETAIL RECORDING - (SMDR)

Station Message Detail Recording (SMDR) is an arrangement to provide a record by main station line number of originating intercity traffic routing over dial type tie lines, WATS, CCSA, interexchange carrier access lines and/or the Toll Network.

The station message detail will include the calling main station line number, the called number, date, time of day, duration of call and the type of facility used. The record will be provided on magnetic tape to customers requiring message detail for cost allocation and telecommunications system management purposes. The detail will be provided on all facilities in routes selected by the customer for Station Message Detail Recording.



GENERAL EXCHANGE TARIFF

Embarq Florida, Inc.

By: F. B. Poag  
Director

SECTION A12  
First Revised Sheet 43  
Cancelling Original Sheet 43  
Effective: January 1, 1997

CENTRAL OFFICE NON-TRANSPORT SERVICE OFFERINGS  
(UNITED TELEPHONE EXCHANGES ONLY)

C. ENHANCED CENTREX SERVICE (Cont'd)

3. Definitions (Cont'd)

STATION-TO-STATION CALLING

Calls may be dialed directly between any two main station lines of an Enhanced Centrex system.

THREE-WAY CALLING

Allows a station user to add a third party to an existing two-party conversation.

TOLL DIVERSION

Toll Diversion automatically denies station direct-dialing access to the long distance message network. Station users attempting to place such calls are diverted to the attendant.

TOLL RESTRICTION

Toll restriction automatically denies station direct-dialing access to the long distance message network.  
Station users attempting to place such calls will receive an announcement or a signal to indicate that access is denied.

TRUNK EQUIPMENT

See Miscellaneous Line Termination

UNIFORM CALL DISTRIBUTION

See Station Hunting Arrangements

GENERAL EXCHANGE TARIFF

Embarq Florida, Inc.

By: F. B. Poag  
Director

SECTION A12  
First Revised Sheet 44  
Cancelling Original Sheet 44  
Effective: January 1, 1997

CENTRAL OFFICE NON-TRANSPORT SERVICE OFFERINGS  
(UNITED TELEPHONE EXCHANGES ONLY)

C. ENHANCED CENTREX SERVICE (Cont'd)

4. Intercept of Calls to Unassigned Station Lines

- a. Incoming calls from the exchange and toll networks to unassigned station lines are intercepted by the same standard central office recorded announcement equipment used to intercept such calls for exchange services. The announcement provided states that the number called is not in service.
- b. Intercommunicating calls to unassigned station lines are intercepted by central office recorded announcement equipment which is common to all Enhanced Centrex systems served out of the same office. The announcement states that the number is not in service and advises that the attendant or the directory of the caller's system should be consulted.

5. Conversion of Basic Centrex Service to Enhanced Centrex Service

- a. When a Basic Centrex customer elects to convert to Enhanced Centrex Service, service connection charges do not apply to existing in-service station lines, terminating arrangements, toll diversion and toll restriction equipped station lines, conference arrangements and other optional features and/or services provided such services and features are offered under Enhanced Centrex and each of the following conditions are met:

GENERAL EXCHANGE TARIFF

Embarq Florida, Inc.

By: F. B. Poag  
Director

SECTION A12  
First Revised Sheet 45  
Cancelling Original Sheet 45  
Effective: January 1, 1997

CENTRAL OFFICE NON-TRANSPORT SERVICE OFFERINGS  
(UNITED TELEPHONE EXCHANGES ONLY)

C. ENHANCED CENTREX SERVICE (Cont'd)

5. Conversion of Basic Centrex Service to Enhanced Centrex Service

a. (Cont'd)

- 1) The customer's system must continue to be served by the same central office equipment or the customer is moved to other central office equipment at the Company's instance.
- 2) There must be no interruption of service.
- 3) There are no moves or changes in existing station lines, terminating arrangements, or optional features requested by the customer.

b. Basic Centrex Services converting to Enhanced Centrex Service must elect a Term Payment Plan of 12, 36 or 60 months as described in C. 6. following.

c. If the customer elects a Term Payment Plan of 12, 36 or 60 months and wishes to add to his system, such additions shall be made within a scheduled period after the conversion at the rates and charges in this and other tariff sections for Enhanced Centrex Service and the associated features and services.

d. A customer converting from Basic to Enhanced Centrex will be given credit on the Enhanced Centrex system establishment charge for any Basic system establishment charge paid.

GENERAL EXCHANGE TARIFF

Embarq Florida, Inc.

By: F. B. Poag  
Director

SECTION A12  
First Revised Sheet 46  
Cancelling Original Sheet 46  
Effective: January 1, 1997

CENTRAL OFFICE NON-TRANSPORT SERVICE OFFERINGS  
(UNITED TELEPHONE EXCHANGES ONLY)

C. ENHANCED CENTREX SERVICE (Cont'd)

6. Payment Schedules

a. General

- 1) Enhanced Centrex service is offered under the following contract periods:
  - 12 Month Term Payment Plan
  - 36 Month Term Payment Plan
  - 60 Month Term Payment Plan
- 2) The following items that may be placed under the Term Payment Plan:
  - Main Station Lines
  - Extension Station Lines
  - Line Feature Options
  - Optional Service Features
  - System Common Equipment
  - Terminating Arrangements
  - Attendant Features
- 3) The monthly rate for Enhanced Centrex service is dependent upon the payment period selected by the customer.
- 4) The monthly rate for Enhanced Centrex service under the Term Payment Plan for the periods of 12, 36 or 60 months is not subject to Company initiated rate increases.

GENERAL EXCHANGE TARIFF

Embarq Florida, Inc.

By: F. B. Poag  
Director

SECTION A12  
First Revised Sheet 47  
Cancelling Original Sheet 47  
Effective: January 1, 1997

CENTRAL OFFICE NON-TRANSPORT SERVICE OFFERINGS  
(UNITED TELEPHONE EXCHANGES ONLY)

C. ENHANCED CENTREX SERVICE (Cont'd)

6. Payment Schedules (Cont'd)

b. Expiration of Contract Period

At the expiration of the term payment plan service period, the subscriber may elect a new term payment service period. If the subscriber does not elect a new term payment service period, the service will automatically renew for successive periods of 12 months each at the then current tariff rates, unless the subscriber provides written or verbal notice of termination at least thirty (30) days in advance of any scheduled renewal.

c. Termination Liability

Contract termination liability for the 12, 36, or 60 month Term Payment Plan is such that if a subscriber terminates their Centrex service prior to the expiration of the Term Payment Plan service period, the subscriber shall immediately pay a termination liability in the amount of 100% of the monthly charges remaining in the term payment period selected.

GENERAL EXCHANGE TARIFF

Embarq Florida, Inc.

By: F. B. Poag  
Director

SECTION A12  
First Revised Sheet 48  
Cancelling Original Sheet 48  
Effective: January 1, 1997

CENTRAL OFFICE NON-TRANSPORT SERVICE OFFERINGS  
(UNITED TELEPHONE EXCHANGES ONLY)

C. ENHANCED CENTREX SERVICE (Cont'd)

6. Payment Schedules (Cont'd)

d. Credits and Surcharges

A surcharge that is equivalent to the multi-line business Subscriber Line Charge (SLC) will apply to each Enhanced Centrex line. For each Enhanced Centrex line a credit will be applied which, when combined with the preceding surcharge, will provide a monthly net SLC billing equal to the SLC multiplied by the number of network access registers.

7. Common Rates and Charges

a. General

1) Station Lines

- a) The rates and charges specified herein for main station lines provide for main station line components. The main station line consists of all facilities including intercommunication outside plant facilities from the system dial switching equipment to the Network Interface of the main station line.
- b) The rates and charges specified herein for main station and extension station lines are applicable to each main station location and extension station location respectively to which a customer-provided instrument can be connected.

GENERAL EXCHANGE TARIFF

Embarq Florida, Inc.

By: F. B. Poag  
Director

SECTION A12  
First Revised Sheet 49  
Cancelling Original Sheet 49  
Effective: January 1, 1997

CENTRAL OFFICE NON-TRANSPORT SERVICE OFFERINGS  
(UNITED TELEPHONE EXCHANGES ONLY)

C. ENHANCED CENTREX SERVICE (Cont'd)

7. Common Rates and Charges (Cont'd)

a. General (Cont'd)

1) Station Lines (Cont'd)

- c) End User charges as specified in the End User Common Access Service Section of the Interstate Access Tariff apply as appropriate.
- d) Rates for the main station lines of Enhanced Centrex customers will be based on the following criteria:
  - (1) Distance from the serving wire center.
  - (2) The type of payment plan selected by the customer.
- e) The total main station category size will consist of main station lines and attendant access lines for all locations served by the same Enhanced Centrex system.
- f) The distance band will be based on airline mileage from the serving wire center to the Network Interface Location at the customer's premises.

GENERAL EXCHANGE TARIFF

Embarq Florida, Inc.

By: F. B. Poag  
Director

SECTION A12  
First Revised Sheet 50  
Cancelling Original Sheet 50  
Effective: January 1, 1997

CENTRAL OFFICE NON-TRANSPORT SERVICE OFFERINGS  
(UNITED TELEPHONE EXCHANGES ONLY)

C. ENHANCED CENTREX SERVICE (Cont'd)

7. Common Rates and Charges (Cont'd)

a. General (Cont'd)

1) Station Lines (Cont'd)

f) (Cont'd)

- (1) Where main stations are in a foreign exchange (FX) or a foreign central office (FCO) area the distance band will be calculated from the FX or the FCO to the Network Interface Location serving those main stations.
- (2) Systems with more than one location served by the same Enhanced Centrex control group will calculate the distance band per location.

g) In a different wire center serving area of a multi-office exchange:

- (1) The rate for Enhanced Centrex Service in an FX or FCO area is the monthly rate for the Enhanced Centrex service desired, plus an FX or FCO mileage charge as specified in Section A9 of this Tariff.



GENERAL EXCHANGE TARIFF

Embarq Florida, Inc.

By: F. B. Poag  
Director

SECTION A12  
First Revised Sheet 51  
Cancelling Original Sheet 51  
Effective: January 1, 1997

CENTRAL OFFICE NON-TRANSPORT SERVICE OFFERINGS  
(UNITED TELEPHONE EXCHANGES ONLY)

C. ENHANCED CENTREX SERVICE (Cont'd)

7. Common Rates and Charges (Cont'd)

a. General (Cont'd)

1) Station Lines (Cont'd)

g) (Cont'd)

(2) When Enhanced Centrex main station lines are connected by facilities which are routed between two or more wire centers in the same exchange, the foreign central office mileage charge is calculated separately on an airline basis between the wire center from which the system is served and the wire center from which exchange service normally would be rendered.

h) Rates, charges, liabilities and additional regulations if applicable may be developed on an individual basis for main station lines exceeding two (2) airline miles from the serving central office.

i) Exchange Access

(1) Exchange Access is provided by means of Network Access Registers.

(2) Presubscription of a Carrier of Preference is specified in Section 13 of Interstate Access Tariff and Section E13 of the Intrastate Access Tariff.

GENERAL EXCHANGE TARIFF

Embarq Florida, Inc.

By: F. B. Poag  
Director

SECTION A12  
First Revised Sheet 52  
Cancelling Original Sheet 52  
Effective: January 1, 1997

CENTRAL OFFICE NON-TRANSPORT SERVICE OFFERINGS  
(UNITED TELEPHONE EXCHANGES ONLY)

C. ENHANCED CENTREX SERVICE (Cont'd)

7. Common Rates and Charges (Cont'd)

b. Nonrecurring Charges

The following nonrecurring charges for service are in addition to any applicable service connection, move, change and installation charges provided for in other sections of this Tariff.

1) Service Establishment Charge-Per system, per customer premises location

26-75 line system	\$1,100.00
76-150 line system	\$2,300.00

2) Feature Add or Change Charge

- a) These charges apply as specified, when a feature is added or changed. These charges apply in addition to other applicable non-recurring charges.

GENERAL EXCHANGE TARIFF

Embarq Florida, Inc.

By: F. B. Poag  
Director

SECTION A12  
Second Revised Sheet 53  
Cancelling First Revised Sheet 53  
Effective: May 29, 1997

CENTRAL OFFICE NON-TRANSPORT SERVICE OFFERINGS  
(UNITED TELEPHONE EXCHANGES ONLY)

RESERVED FOR FUTURE USE

GENERAL EXCHANGE TARIFF

Embarq Florida, Inc.

By: F. B. Poag  
Director

SECTION A12  
First Revised Sheet 54  
Cancelling Original Sheet 54  
Effective: January 1, 1997

CENTRAL OFFICE NON-TRANSPORT SERVICE OFFERINGS  
(UNITED TELEPHONE EXCHANGES ONLY)

C. ENHANCED CENTREX SERVICE (Cont'd)

7. Common Rates and Charges (Cont'd)

b. Nonrecurring Charges (Cont'd)

2) Feature Add or Change Charge (Cont'd)

(b) One or more features may be provided at the same time and in such instances the specified feature establishment charge will apply per request per station.

Per standard instrument	\$ 5.75
Per Business Set	8.35
Per attendant console	15.75

3) Installation charges are in addition to other appropriate nonrecurring charges for the service.

4) Service Connection Charges as specified for Business Service in Section A4 of this Tariff are applicable to each main station line, console access loop, extension station line, etc.

GENERAL EXCHANGE TARIFF

Embarq Florida, Inc.

By: F. B. Poag  
Director

SECTION A12  
Fourth Revised Sheet 55  
Cancelling Third Revised Sheet 55  
Effective: November 1, 2005

CENTRAL OFFICE NON-TRANSPORT SERVICE OFFERINGS  
(UNITED TELEPHONE EXCHANGES ONLY)

C. ENHANCED CENTREX SERVICE (Cont'd)

7. Common Rates and Charges (Cont'd)

c. Recurring charges

1) Network Access Registers  
- per Register

	Rate Groups				
(a) United Telephone	1	2	3	4	5
Monthly Rate	\$17.70	19.70	21.45	23.20	25.70

(b) Monthly rate for Useppa Island and North Captiva Island can be found in Section A3.

2) Directory Listings Monthly Rate  
See Section A6,  
Additional Directory Listings

3) Off-Premises Extension See Section A13 of  
this Tariff or  
appropriate Private  
Line tariff for  
Extension Line  
Mileage.

(a) Located on different premises from main station line on non-continuous property, each

4) Main Station Line \$ 35.00  
terminated as a PBX trunk, each

GENERAL EXCHANGE TARIFF

Embarq Florida, Inc.

By: F. B. Poag  
Director

SECTION A12  
Second Revised Sheet 56  
Cancelling First Revised Sheet 56  
Effective: March 1, 2003

CENTRAL OFFICE NON-TRANSPORT SERVICE OFFERINGS  
(UNITED TELEPHONE EXCHANGES ONLY)

C. ENHANCED CENTREX SERVICE (Cont'd)

7. Common Rates and Charges (Cont'd)

d. Miscellaneous Line Terminations

Each of the rate elements shown provide only the basic auxiliary digital line termination equipment and facilities located at the central office where the basic service is provided and is in addition to other rates and charges applicable for the associated services (Private Line Service and Channels, WATS, FX, etc.)

1) Interexchange Carrier Access Line

One Feature Establishment Charge applies when any number of miscellaneous lines of the same type are installed at the same time, per occasion, per same group.

		Feature Establishment Charge	Term Payment Plan		
			12 Months	36 Months	60 Months
(a)	Per Simulated Facilities Group	\$47.00	\$ -	\$ -	\$ -
(b)	Per Termination via Simulated Facilities Group	-	1.30	1.05	.80
(c)	Per Dedicated Termination	42.50	19.60	18.10	16.60

GENERAL EXCHANGE TARIFF

Embarq Florida, Inc.

By: F. B. Poag  
Director

SECTION A12  
Third Revised Sheet 57  
Cancelling Second Revised Sheet 57  
Effective: October 24, 2003

CENTRAL OFFICE NON-TRANSPORT SERVICE OFFERINGS  
(UNITED TELEPHONE EXCHANGES ONLY)

C. ENHANCED CENTREX SERVICE (Cont'd)

7. Common Rates and Charges (Cont'd)

d. Miscellaneous Line Terminations (Cont'd)

2) Other Access Terminals

a) Tie Lines

Tie Lines terminations are furnished to connect a system to Enhanced Private Switched Communications Service (EPSCS) Type A Channels.

		Feature Establishment Charge	Term Payment Plan		
			12 Months	36 Months	60 Months
(1)	Per Termination, Analog	51.00	34.30	32.80	31.30
(2)	Per Termination, Digital	42.50	22.60	21.10	18.60

GENERAL EXCHANGE TARIFF

Embarq Florida, Inc.

By: F. B. Poag  
Director

SECTION A12  
Third Revised Sheet 58  
Cancelling Second Revised Sheet 58  
Effective: March 1, 2003

CENTRAL OFFICE NON-TRANSPORT SERVICE OFFERINGS  
(UNITED TELEPHONE EXCHANGES ONLY)

C. ENHANCED CENTREX SERVICE (Cont'd)

7. Common Rates and Charges (Cont'd)

d. Miscellaneous Line Terminations (Cont'd)

2) Other Access Terminals (Cont'd)

b) Foreign Exchange (FX) and Foreign Central Office (FCO) Lines

The type of termination (Analog or Digital) will vary and will be determined by the terminating central office.

	Feature Establishment Charge	Term Payment Plan		
		12 Months	36 Months	60 Months
Per Termination	\$42.50	\$21.00	\$19.00	\$18.00
(c) Outward WATS				
Per simulated facilities group	47.00	-	-	-
Per outward WATS line terminated via simulated facilities group	-	6.60	6.30	6.00
(d) Toll Free Code (TFC) Service				
Per simulated facilities group	47.00	-	-	-
Per TFC Service line terminated via simulated facilities group	-	1.50	1.40	1.35



GENERAL EXCHANGE TARIFF

Embarq Florida, Inc.

By: F. B. Poag  
Director

SECTION A12  
Second Revised Sheet 59  
Cancelling First Revised Sheet 59  
Effective: May 29, 1997

CENTRAL OFFICE NON-TRANSPORT SERVICE OFFERINGS  
(UNITED TELEPHONE EXCHANGES ONLY)

RESERVED FOR FUTURE USE

GENERAL EXCHANGE TARIFF

Embarq Florida, Inc.

By: F. B. Poag  
Director

SECTION A12  
First Revised Sheet 60  
Cancelling Original Sheet 60  
Effective: January 1, 1997

CENTRAL OFFICE NON-TRANSPORT SERVICE OFFERINGS  
(UNITED TELEPHONE EXCHANGES ONLY)

C. ENHANCED CENTREX SERVICE (Cont'd)

8. Rates and Charges

a. Main Station Lines

The Enhanced Centrex main station rate will be a combination of the intercom charge, the applicable wire center line charge and the station activation charge as appropriate.

	<u>Installation Charge</u>	<u>Term Payment Plan</u>		
		<u>12 Months</u>	<u>36 Months</u>	<u>60 Months</u>
1) Intercom Charge - per Main Station	\$ --	\$ 6.10	\$ 6.00	\$ 5.95
2) Wire Center Line Mileage Charge - Each Main Station - (Airline mileage from the network interface location to the serving central office location.)				
a) 1/4 mile	--	5.80	4.90	4.45
b) 1/2 mile	--	6.95	5.90	5.35
c) 3/4 mile	--	8.10	6.90	6.25
d) 1 mile	--	10.00	8.90	8.10
e) 1 1/2 miles	--	11.40	10.90	9.90
f) 2 miles	--	12.95	12.80	12.65

GENERAL EXCHANGE TARIFF

Embarq Florida, Inc.

By: F. B. Poag  
Director

SECTION A12  
First Revised Sheet 61  
Cancelling Original Sheet 61  
Effective: November 12, 2004

CENTRAL OFFICE NON-TRANSPORT SERVICE OFFERINGS  
(UNITED TELEPHONE EXCHANGES ONLY)

C. ENHANCED CENTREX SERVICE (Cont'd)

8. Rates and Charges (Cont'd)

a. Main Station Lines (Cont'd)

	<u>Installation Charge</u>	<u>Term Payment Plan</u>		
		<u>12 Months</u>	<u>36 Months</u>	<u>60 Months</u>
3) Station Activation Charge				
per standard instrument line	7.05	--	--	--
per Business Set line	14.10	5.00	5.00	5.00
per attendant console				
per customer group	75.00	175.00	170.00	165.00
per console	25.00	250.00	240.00	235.00

b. Station Features

1) General

- a) Station features are offered where facilities permit. This will be dependent on the serving central office.
- b) All features may not be offered from all central offices.
- c) Feature operation may vary based on the serving central office.

GENERAL EXCHANGE TARIFF

Embarq Florida, Inc.

BY: F. B. Poag  
Director

SECTION A12  
Second Revised Sheet 62  
Cancelling First Revised Sheet 62  
Effective: October 13, 2002

CENTRAL OFFICE NON-TRANSPORT SERVICE OFFERINGS  
(UNITED TELEPHONE EXCHANGES ONLY)

C. ENHANCED CENTREX SERVICE (Cont'd)

8. Rates and Charges (Cont'd)

b. Station Features (Cont'd)

2) Rates and Charges

		Term Payment Plan			
		12	36	60	
		<u>Months</u>	<u>Months</u>	<u>Months</u>	
		<u>Nonrecurring Charge</u>			
a)	Call Park				
	per block of 50	-	\$11.00	\$ 8.25	\$ 5.50
	per line	-	.15	.10	.05
b)	Conference (Maximum of 6 Conferees)				
	per line	-	2.75	2.70	2.65
	per system	-	-	-	-
c)	Multiple Appearance Directory Number				
	Single Call Arrangement				
	per block of 50	-	10.75	10.60	10.50
	per line	-	.30	.25	.20
	Multiple Call Arrangement				
	per block of 50	-	15.00	12.75	11.65
	per line	-	2.00	1.95	1.90

GENERAL EXCHANGE TARIFF

Embarq Florida, Inc.

By: F. B. Poag  
Director

SECTION A12  
Second Revised Sheet 63  
Cancelling First Revised Sheet 63  
Effective: May 29, 1997

CENTRAL OFFICE NON-TRANSPORT SERVICE OFFERINGS  
(UNITED TELEPHONE EXCHANGES ONLY)

8. Rates and Charges (Cont'd)

b. Station Features (Cont'd)

2) Rates and Charges (Cont'd)

		Term Payment Plan			
		<u>Nonrecurring Charge</u>	<u>12 Months</u>	<u>36 Months</u>	<u>60 Months</u>
d)	Class-of-Service Restrictions				
	Fully Restricted Station				
	per line	-	\$ 4.80	\$ 4.75	\$ 4.70
	Semi-Restricted Station				
	per line	-	2.40	2.35	2.30
	Toll Restriction				
	per line	-	.55	.50	.45
e)	Data Call Protection				
	per line	-	.50	.45	.40
f)	Hunting				
	per block of 50	-	15.00	12.75	11.65
	per line	-	2.00	1.95	1.90
g)	Call Forward - All Calls				
	per block of 50	-	11.00	8.25	5.50
	per line	-	.15	.10	.05

GENERAL EXCHANGE TARIFF

Embarq Florida, Inc.

By: F. B. Poag  
Director

SECTION A12  
Second Revised Sheet 64  
Cancelling First Revised Sheet 64  
Effective: May 29, 1997

CENTRAL OFFICE NON-TRANSPORT SERVICE OFFERINGS  
(UNITED TELEPHONE EXCHANGES ONLY)

RESERVED FOR FUTURE USE

GENERAL EXCHANGE TARIFF

Embarq Florida, Inc.

BY: F. B. Poag  
Director

SECTION A12  
Third Revised Sheet 65  
Canceling Second Revised Sheet 65  
Effective: October 13, 2002

CENTRAL OFFICE NON-TRANSPORT SERVICE OFFERINGS  
(UNITED TELEPHONE EXCHANGES ONLY)

C. ENHANCED CENTREX SERVICE (Cont'd)

8. Rates and Charges (Cont'd)

b. Station Features (Cont'd)

2) Rates and Charges (Cont'd)

		<u>Nonrecurring Charge</u>	<u>Term Payment Plan</u>		
			<u>12 Months</u>	<u>36 Months</u>	<u>60 Months</u>
h)	Call Forward - Busy	-	\$15.00	\$12.75	\$11.65
	per block of 50	-			
	per line	-	2.00	1.95	1.90
i)	Call Forward - No Answer	-	10.75	10.60	10.50
	per block of 50	-			
	per line	-	.20	.15	.10
j)	Call Pickup	-	9.75	9.50	9.25
	per block of 50	-			
	per line	-	.30	.25	.20
k)	Call Waiting Terminating	-	5.90	5.00	4.95
	per block of 50	-			
	per line	-	.15	.10	.05
l)	Call Waiting Originating	-	28.75	28.00	27.75
	per block of 50	-			
	per line	-	.50	.45	.40
m)	Three-Way Calling	-	1.75	1.50	1.25
	per line	-			

GENERAL EXCHANGE TARIFF

Embarq Florida, Inc.

By: F.B. Poag  
Director

SECTION A12  
Second Revised Sheet 66  
Cancelling First Revised Sheet 66  
Effective: May 29, 1997

CENTRAL OFFICE NON-TRANSPORT SERVICE OFFERINGS  
(UNITED TELEPHONE EXCHANGES ONLY)

C. ENHANCED CENTREX SERVICE (Cont'd)

8. Rates and Charges (Cont'd)

b. Station Features (Cont'd)

2) Rates and Charges (Cont'd)

		Term Payment Plan			
		<u>Nonrecurring Charge</u>	<u>12 Months</u>	<u>36 Months</u>	<u>60 Months</u>
(n)	Permanent Hold per line	\$ -	\$ .55	\$ .50	\$ .45
(o)	Ring Again per line	-	.50	.45	.40
(p)	Speed Calling-Group Long List- 30 per list	.50	-	-	-
	each additional line	-	.15	.10	.05
	Speed Calling-Group Long List- 50 per list	1.00	-	-	-
	each additional line	-	.20	.15	.10



GENERAL EXCHANGE TARIFF

Embarq Florida, Inc.

By: F. B. Poag  
Director

SECTION A12  
Second Revised Sheet 67  
Cancelling First Revised Sheet 67  
Effective: May 29, 1997

CENTRAL OFFICE NON-TRANSPORT SERVICE OFFERINGS  
(UNITED TELEPHONE EXCHANGES ONLY)

C. ENHANCED CENTREX SERVICE (Cont'd)

8. Rates and Charges (Cont'd)

b. Station Features (Cont'd)

2) Rates and Charges (Cont'd)

		Term Payment Plan			
		12	36	60	
		<u>Months</u>	<u>Months</u>	<u>Months</u>	
		<hr/>			
		Nonrecurring			
		<u>Charge</u>			
q)	Speed Calling-Individual Long list - 30 per line	\$ -	\$ .40	\$ .35	\$ .30
	Speed Calling-Individual Long List - 50 per line	-	.60	.55	.50
r)	Station Speed Calling per line	-	.20	.15	.10
s)	Executive Busy Override per line	-	1.00	.95	.90
t)	Last Number Redial per line	-	.15	.10	.05

GENERAL EXCHANGE TARIFF

Embarq Florida, Inc.

BY: F. B. Poag  
Director

SECTION A12  
Third Revised Sheet 68  
Cancelling Second Revised Sheet 68  
Effective: October 13, 2002

CENTRAL OFFICE NON-TRANSPORT SERVICE OFFERINGS  
(UNITED TELEPHONE EXCHANGES ONLY)

C. ENHANCED CENTREX SERVICE (Cont'd)

8. Rates and Charges (Cont'd)

b. Station Features (Cont'd)

2) Rates and Charges (Cont'd)

		<u>Nonrecurring Charge</u>	<u>Term Payment Plan</u>		
			<u>12 Months</u>	<u>36 Months</u>	<u>60 Months</u>
v)	Automatic Line per line	-	\$ .20	\$ .15	\$ .10
w)	Group Intercom per group	-	2.50	.95	.80
	per line	-	.25	.10	.05
x)	Make Set Busy per line	-	.15	.10	.05
y)	Privacy Release per line	-	.35	.30	.25
z)	Call Hold per block of 50	-	4.50	4.30	4.25
	per line	-	.05	.05	.05
aa)	Dial Call Waiting per line	-	.25	.20	.15
bb)	Direct Call Pickup Non Barge-In per line	-	.20	.15	.10

GENERAL EXCHANGE TARIFF

Embarq Florida, Inc.

By: F. B. Poag  
Director

SECTION A12  
Second Revised Sheet 69  
Cancelling First Revised Sheet 69  
Effective: May 29, 1997

CENTRAL OFFICE NON-TRANSPORT SERVICE OFFERINGS  
(UNITED TELEPHONE EXCHANGES ONLY)

C. ENHANCED CENTREX SERVICE (Cont'd)

8. Rates and Charges (Cont'd)

b. Station Features (Cont'd)

2) Rates and Charges (Cont'd)

	Nonrecurring Charge	Term Payment Plan		
		12 Months	36 Months	60 Months
cc) Call Transfer per line	-	\$ .85	\$ .75	\$ .65
dd) Deny Call Forward per line	-	.15	.10	.05
ee) Deny Terminating Service per line	-	.15	.10	.05
ff) Deny Incoming per line	-	.15	.10	.05
gg) Autovon Terminating per line	-	.75	.70	.60
hh) Executive Busy Override Exempt per line	-	1.10	1.05	1.00
ii) Deny Originating Service per line	-	.20	.15	.10

GENERAL EXCHANGE TARIFF

Embarq Florida, Inc.

By: F. B. Poag  
Director

SECTION A12  
Second Revised Sheet 70  
Cancelling First Revised Sheet 70  
Effective: May 29, 1997

CENTRAL OFFICE NON-TRANSPORT SERVICE OFFERINGS  
(UNITED TELEPHONE EXCHANGES ONLY)

C. ENHANCED CENTREX SERVICE (Cont'd)

9. Optional Service Features

a. Attendant Features Package - Data Link Console  
Operation

1) General

- a) Central office attendant console operation is offered only when all console functions are performed at the expense of the subscriber utilizing customer-provided compatible terminal equipment.
- b) Such consoles may be utilized only where the central office serving the Enhanced Centrex system has been arranged for use with such consoles.
- c) Control channels are required for various console optional features as indicated and are provided at the rates and charges specified in Section A20 of this Tariff.
- d) The feature establishment charge for Data Link Console operation includes the following attendant features provided the customer-provided terminal equipment meets the technical specifications for interface with the DMS 100 switcher.

GENERAL EXCHANGE TARIFF

Embarq Florida, Inc.

By: F. B. Poag  
Director

SECTION A12  
Second Revised Sheet 71  
Cancelling First Revised Sheet 71  
Effective: May 29, 1997

CENTRAL OFFICE NON-TRANSPORT SERVICE OFFERINGS  
(UNITED TELEPHONE EXCHANGES ONLY)

C. ENHANCED CENTREX SERVICE (Cont'd)

9. Optional Service Features (Cont'd)

a. Attendant Features Package - Data Link Console Operation  
(Cont'd)

1) General (Cont'd)

d) (Cont'd)

Attendant to Recorded Announcement  
Automatic Recall  
Call Hold  
Call Transfer  
Attendant Release Upon Completion of Dialing  
Camp-On  
Flexible Console Alerting  
Lockout  
Secrecy  
Serial Call  
Interposition Call Transfer  
Call Selection  
Console Display  
Locked Loop Operation  
Console Test  
Two-Way Splitting  
Switched Loop Operation  
Trunk Answer from Any Station

GENERAL EXCHANGE TARIFF

Embarq Florida, Inc.

By: F. B. Poag  
Director

SECTION A12  
Second Revised Sheet 72  
Cancelling First Revised Sheet 72  
Effective: May 29, 1997

CENTRAL OFFICE NON-TRANSPORT SERVICE OFFERINGS  
(UNITED TELEPHONE EXCHANGES ONLY)

C. ENHANCED CENTREX SERVICE (Cont'd)

9. Optional Service Features (Cont'd)

a. Attendant Features Package - Data Link Console  
Operation (Cont'd)

2) Rates and Charges

	Feature Establishment Charge	Term Payment Plan		
		12 Months	36 Months	60 Months
Optional Attendant Features				
a) Busy Verification - Stations per console	\$ -	\$ 8.00	\$7.95	\$7.90
b) Busy Verification - Trunks per console	-	7.50	7.45	7.40
c) Multiple Console Operation per console	-	3.50	3.45	3.40
d) Position Busy per console	-	7.00	6.95	6.90
e) Supervisory Console per console	-	3.50	3.45	3.40
f) Trunk Access Control per console	-	8.00	7.95	7.90
g) Trouble Key on Console per console	-	3.50	3.45	3.40

GENERAL EXCHANGE TARIFF

Embarq Florida, Inc.

By: F. B. Poag  
Director

SECTION A12  
Second Revised Sheet 73  
Cancelling First Revised Sheet 73  
Effective: May 29, 1997

CENTRAL OFFICE NON-TRANSPORT SERVICE OFFERINGS  
(UNITED TELEPHONE EXCHANGES ONLY)

C. ENHANCED CENTREX SERVICE (Cont'd)

9. Optional Service Features (Cont'd)

a. Attendant Features Package - Data Link Console  
Operation (Cont'd)

2) Rates and Charges (Cont'd)

		Term Payment Plan			
		12	36	60	
		Months	Months	Months	
		<hr/>			
	Feature Establishment Charge				
Optional Attendant Features (Cont'd)					
h)	Trunk Group Busy Indication per console	-	\$ 8.00	\$ 7.95	\$ 7.90
i)	Wildcard Key per console	-	4.00	3.95	3.90
j)	Attendant Autodial per line arranged, per console	-	10.00	9.95	9.90
k)	Time per console	-	.80	.70	.60
l)	Night Service - Fixed per customer group	-	4.50	4.45	4.40
m)	Night Service - Flexible per customer group	-	7.00	6.95	6.90

GENERAL EXCHANGE TARIFF

Embarq Florida, Inc.

By: F. B. Poag  
Director

SECTION A12  
Second Revised Sheet 74  
Cancelling First Revised Sheet 74  
Effective: May 29, 1997

CENTRAL OFFICE NON-TRANSPORT SERVICE OFFERINGS  
(UNITED TELEPHONE EXCHANGES ONLY)

C. ENHANCED CENTREX SERVICE (Cont'd)

9. Optional Service Features (Cont'd)

a. Attendant Features Package - Data Link Console  
Operation (Cont'd)

2) Rates and Charges (Cont'd)

		Feature Establishment Charge	Term Payment Plan		
			12 Months	36 Months	60 Months
Optional Attendant Features (Cont'd)					
(n)	Activate/Deactivate Call Forwarding per console	\$ -	\$ 3.50	\$ 3.45	\$ 3.40
(o)	Group Trunk Group Busy per trunk group	-	8.00	7.95	7.90
(p)	Aggregate Trunk Access Control per trunk group	-	8.00	7.95	7.90
(q)	Priority Console Alert per console	-	28.00	27.00	26.45
(r)	Attendant Call Detail Entry per console	-	5.00	4.80	4.70
(s)	Attendant Verification and Recording per console	-	4.70	4.60	4.50



GENERAL EXCHANGE TARIFF

Embarq Florida, Inc.

By: F. B. Poag  
Director

SECTION A12  
Second Revised Sheet 75  
Cancelling First Revised Sheet 75  
Effective: May 29, 1997

CENTRAL OFFICE NON-TRANSPORT SERVICE OFFERINGS  
(UNITED TELEPHONE EXCHANGES ONLY)

C. ENHANCED CENTREX SERVICE (Cont'd)

9. Optional Service Features (Cont'd)

a. Attendant Features Package - Data Link Console  
Operation (Cont'd)

2) Rates and Charges (Cont'd)

	Feature Establishment Charge	Term Payment Plan		
		12 Months	36 Months	60 Months
Optional Attendant Features (Cont'd)				
t) Global Virtual Facility Group Access Control per console	\$ -	\$ .65	\$ .60	\$ .50
u) Global Virtual Facility Group Busy per console	-	.65	.60	.50
v) Virtual Facility Group Access Control per console	-	.65	.60	.50
w) Virtual Facility Group Busy per console	-	.65	.60	.50
x) Group Trunk Access Control per console	-	.20	.15	.10
y) Display Queued Calls per console	-	3.50	3.40	3.30

GENERAL EXCHANGE TARIFF

Embarq Florida, Inc.

By: F. B. Poag  
Director

SECTION A12  
Second Revised Sheet 76  
Cancelling First Revised Sheet 76  
Effective: May 29, 1997

CENTRAL OFFICE NON-TRANSPORT SERVICE OFFERINGS  
(UNITED TELEPHONE EXCHANGES ONLY)

C. ENHANCED CENTREX SERVICE (Cont'd)

9. Optional Service Features (Cont'd)

b. Central Office Features Associated with Customer Provided Electronic Telephone Sets

1) General

Access to the following features via customer provided station equipment will be provided according to the interface specifications for the DMS 100 central office switcher.

2) Regulations

- a) Each station location will require a main station access line charge as specified in Section A3 of this tariff.
- b) Main station lines terminated in customer provided electronic telephone sets must be via non-loaded facilities.
- c) Each main station set must have a primary Directory Number associated with it.
- d) Features associated with the electronic set only will be charged per main station.
- e) Features associated with the Directory Number(s) terminated on the main station will be charged per Directory Number activated.

GENERAL EXCHANGE TARIFF

Embarq Florida, Inc.

By: F. B. Poag  
Director

SECTION A12  
Second Revised Sheet 77  
Cancelling First Revised Sheet 77  
Effective: May 29, 1997

CENTRAL OFFICE NON-TRANSPORT SERVICE OFFERINGS  
(UNITED TELEPHONE EXCHANGES ONLY)

C. ENHANCED CENTREX SERVICE (Cont'd)

9. Optional Service Features (Cont'd)

b. Central Office Features Associated with Customer Provided Electronic Telephone Sets  
(Cont'd)

2) Regulations (Cont'd)

- f) Features assigned to keys on an electronic set must also have the feature assigned to the main station line.
- g) Features associated with a dedicated key on the electronic set will be charged per key assigned.
- h) A main station set may have a Private Business Line (PBL) appearing as one of the Directory Number keys.
- i) Rates and Charges for an individual business line service as specified in Section A3 of this Tariff will apply for the Private Business Line. The number assigned to a PBL will be outside the Enhanced Centrex station range. The PBL cannot use the code access features available on the main station set. Services such as Custom Calling cannot be assigned to a PBL.

GENERAL EXCHANGE TARIFF

Embarq Florida, Inc.

By: F. B. Poag  
Director

SECTION A12  
Second Revised Sheet 78  
Cancelling First Revised Sheet 78  
Effective: May 29, 1997

CENTRAL OFFICE NON-TRANSPORT SERVICE OFFERINGS  
(UNITED TELEPHONE EXCHANGES ONLY)

C. ENHANCED CENTREX SERVICE (Cont'd)

9. Optional Service Features (Cont'd)

b. Central Office Features Associated with Customer Provided Electronic Telephone Sets (Cont'd)

3) Rates and Charges

a) These rates and charges will apply per electronic set provided.

	Feature Establishment Charge	Term Payment Plan		
		12 Months	36 Months	60 Months
Private Business Line - per line	See Section A4	See Section A3		
b) Electronic Telephone Set Display Features - standard package rate per line equipped -	1.75	.75	.70	.65
Display Called Number	-	-	-	-
Display Calling Number	-	-	-	-
Feature Display	-	-	-	-
Query Time Key	-	-	-	-

GENERAL EXCHANGE TARIFF

Embarq Florida, Inc.

By: F. B. Poag  
Director

SECTION A12  
Second Revised Sheet 79  
Cancelling First Revised Sheet 79  
Effective: May 29, 1997

CENTRAL OFFICE NON-TRANSPORT SERVICE OFFERINGS  
(UNITED TELEPHONE EXCHANGES ONLY)

C. ENHANCED CENTREX SERVICE (Cont'd)

9. Optional Service Features (Cont'd)

b. Central Office Features Associated with Customer Provided Electronic Telephone Sets (Cont'd)

3) Rates and Charges

a) These rates and charges will apply per electronic set provided.

	Feature Establishment Charge	Term Payment Plan		
		12 Months	36 Months	60 Months
(c) Additional Features				
Add-on Module Software per set	75.00	-	-	-
Auto Answer Back per set	-	3.00	2.95	2.90
Intercom - Individual per set	-	.40	.35	.30
Automatic Dial per set	-	.25	.20	.15
Fictitious Directory Numbers per directory number	-	2.50	2.25	2.00

GENERAL EXCHANGE TARIFF

Embarq Florida, Inc.

By: F. B. Poag  
Director

SECTION A12  
Second Revised Sheet 80  
Cancelling First Revised Sheet 80  
Effective: May 29, 1997

CENTRAL OFFICE NON-TRANSPORT SERVICE OFFERINGS  
(UNITED TELEPHONE EXCHANGES ONLY)

C. ENHANCED CENTREX SERVICE (Cont'd)

9. Optional Service Features (Cont'd)

c. Station Message Detail Recording (SMDR)

1) General

- a) Station Message detail recording (SMDR) is an arrangement to provide a record, by main station line number, of originating intercity traffic routing over dial type tie lines, WATS, CCSA, interexchange carrier access lines and/or the Toll Network.
- b) The station message detail will include the calling main station line number, the called number, date, time of day, duration of call and the type of facility used. The record will be provided on magnetic tape to customers requiring message detail for cost allocation and telecommunications system management purposes. The detail will be provided on all facilities in routes selected by the customer for Station Message Detail Recording.

2) Regulations

- a) Station Message Detail Recording (SMDR) may be offered to main station lines of customers where facilities permit and where the Company's message billing process has been arranged to provide this optional feature.

GENERAL EXCHANGE TARIFF

Embarq Florida, Inc.

By: F. B. Poag  
Director

SECTION A12  
Second Revised Sheet 81  
Cancelling First Revised Sheet 81  
Effective: May 29, 1997

CENTRAL OFFICE NON-TRANSPORT SERVICE OFFERINGS  
(UNITED TELEPHONE EXCHANGES ONLY)

C. ENHANCED CENTREX SERVICE (Cont'd)

9. Optional Service Features (Cont'd)

c. Station Message Detail Recording (Cont'd)

2) Regulations (Cont'd)

- b) Station Message Detail Recording is not represented to be a provision of billing detail.
- c) Station Message details will be provided on magnetic tape. The tape density and number of tracks will be that used by the program and data processing system in use by the Company's accounting center furnishing the tape. The format may be changed at the discretion of the Company in which case the customer will be responsible for making the tape compatible with his data processing equipment.
- d) Station Message details may be provided on all facilities subscribed to by the customer including Message Telecommunications Service (MTS), but will not include intercom calls originated by the station users. The customer may designate the group or groups of facilities on which SMDR is to be provided. Where the facility designated by the customer is the MTS network, the magnetic tape file will include a record of each message itemized on the customer's bill; e.g., messages received collect or billed to the customer as third number billing will be on the tape file in addition to DDD messages originated by the station user.

GENERAL EXCHANGE TARIFF

Embarq Florida, Inc.

By: F. B. Poag  
Director

SECTION A12  
Second Revised Sheet 82  
Cancelling First Revised Sheet 82  
Effective: May 29, 1997

CENTRAL OFFICE NON-TRANSPORT SERVICE OFFERINGS  
(UNITED TELEPHONE EXCHANGES ONLY)

C. ENHANCED CENTREX SERVICE (Cont'd)

9. Optional Service Features (Cont'd)

b. Central Office Features Associated with Customer Provided Electronic Telephone Sets  
(Cont'd)

3) Rates and Charges (Cont'd)

	Feature Establishment Charge	Term Payment Plan		
		12 Months	36 Months	60 Months
a) Authorization Codes per block of 50	25.00	\$ 9.50	\$ 8.95	\$ 8.60
b) Account Codes per block of 50	25.00	8.00	7.95	7.80
c) Direct Inward System Access	-	10.00	9.90	9.80
d) Station Message Detail Recording, per system per recorded announcement	450.00 -	42.50 .0025	41.00 .0025	40.00 .0025
e) Station Message Detail Transfer to Tape per request	110.00	--	-	
f) Blank Magnetic Tape per tape	14.50	--	-	
g) Recorded Announcement per account authorization code	-	5.00	4.95	4.90



GENERAL EXCHANGE TARIFF

Embarq Florida, Inc.

By: F. B. Poag  
Director

SECTION A12  
Second Revised Sheet 83  
Cancelling First Revised Sheet 83  
Effective: May 29, 1997

CENTRAL OFFICE NON-TRANSPORT SERVICE OFFERINGS  
(UNITED TELEPHONE EXCHANGES ONLY)

C. ENHANCED CENTREX SERVICE (Cont'd)

9. Optional Service Features (Cont'd)

d. Trunk Queuing

The Trunk Queuing package consists of several features and enhancements as follows:

	Feature Establishment Charge	Term Payment Plan		
		12 Months	36 Months	60 Months
1) Off-Hook Queuing - will wait to process a call until an inexpensive route is available.				
per system	\$ -	\$ 5.45	\$ 5.40	\$ 5.35
2) Call-Back Queuing - will notify the caller when a trunk becomes idle; then automatically connects to the called number.				
per system	-	1.45	1.40	1.35
e. Uniform Call Distribution				
per group	-	33.00	31.00	29.90
per line	-	2.00	2.00	2.00
announcement per group	-	5.00	4.95	4.90
f. Automatic Route Selection and Expensive Route Warning Tone				
1) Automatic Route Selection - trunk route lists are automatically searched for an idle outgoing trunk.				
per system	-	26.00	26.00	24.90
2) Expensive Route Warning Tone - provides a warning tone to indicate the selection of an expensive route.				
per system	-	18.00	16.00	14.90

GENERAL EXCHANGE TARIFF

Embarq Florida, Inc.

By: F. B. Poag  
Director

SECTION A12  
Second Revised Sheet 84  
Cancelling First Revised Sheet 84  
Effective: May 29, 1997

CENTRAL OFFICE NON-TRANSPORT SERVICE OFFERINGS  
(UNITED TELEPHONE EXCHANGES ONLY)

C. ENHANCED CENTREX SERVICE (Cont'd)

9. Optional Service Features (Cont'd)

	Feature Establishment Charge	Term Payment Plan		
		12 Months	36 Months	60 Months
g. Message Service				
1) Station Message Waiting - permits the user to access the attendant for a message. Also allows the user to activate message waiting lamp.				
per line	\$ -	\$1.65	\$1.55	\$1.50
2) Stuttered Dial Tone for Message Waiting - notifies a user of a message waiting with a stuttered dial tone.				
per line	-	1.00	.90	.80
3) Attendant Message Waiting - permits the attendant console to be used as a message center.				
per console	-	2.00	1.90	1.80
4) Business Set Message Waiting - notifies a user of a message waiting with an indicator lamp.				
per business set	-	1.00	.90	.80

GENERAL EXCHANGE TARIFF

Embarq Florida, Inc.

By: F. B. Poag  
Director

SECTION A12  
Second Revised Sheet 85  
Cancelling First Revised Sheet 85  
Effective: May 29, 1997

CENTRAL OFFICE NON-TRANSPORT SERVICE OFFERINGS  
(UNITED TELEPHONE EXCHANGES ONLY)

C. ENHANCED CENTREX SERVICE (Cont'd)

9. Optional Service Features (Cont'd)

	Feature Establishment Charge	Term Payment Plan		
		12 Months	36 Months	60 Months
h. Electronic Switched Network (ESN) - Basic Standard Package)				
per system	\$2500.00	\$ 75.00	\$ 75.00	\$75.00
ESN Connections				
per interoffice connection	42.50	19.60	18.10	16.60

The basic ESN network package includes the following features:

- 1) Network Class of Service - determines call privileges for calls transversing the network.
- 2) Network Information Signals - proprietary signaling that provides compatibility between switches equipped with the ESN signaling package and within a customer's private network.
- 3) Network-Wide Automatic Route Selection - provides for effective use of available network resources through the use of routing strategies.

GENERAL EXCHANGE TARIFF

Embarq Florida, Inc.

By: F. B. Poag  
Director

SECTION A12  
Second Revised Sheet 86  
Cancelling First Revised Sheet 86  
Effective: May 29, 1997

CENTRAL OFFICE NON-TRANSPORT SERVICE OFFERINGS  
(UNITED TELEPHONE EXCHANGES ONLY)

C. ENHANCED CENTREX SERVICE (Cont'd)

9. Optional Service Features (Cont'd)

	Feature Establishment Charge	Term Payment Plan		
		12 Months	36 Months	60 Months
i. Network Speed Calling (Standard Package) - allows a customer group to define and access up to 1000 Network Speed Calling numbers.				
per system	\$ -	\$ 28.00	\$ 26.00	\$ 24.90
j. Time-of-Day Routing (Standard Package) - permits cost-effective use of call route choices based on the time of day.				
per system	-	115.00	105.00	99.90
k. Time-of-Day Network Class of Service Routing (Standard Package) - provides for conditional call routing based on Class-of-Service and time of day.				
per system	-	170.00	155.00	149.90
l. Random Conditional Routing (Standard Package) - provides the capability to distribute calls over several lists of trunk groups on a percentage basis when Automatic Route Selection is provided.				
per system	-	11.50	10.50	9.90

GENERAL EXCHANGE TARIFF

Embarq Florida, Inc.

By: F. B. Poag  
Director

SECTION A12  
Second Revised Sheet 87  
Cancelling First Revised Sheet 87  
Effective: May 29, 1997

CENTRAL OFFICE NON-TRANSPORT SERVICE OFFERINGS  
(UNITED TELEPHONE EXCHANGES ONLY)

C. ENHANCED CENTREX SERVICE (Cont'd)

9. Optional Service Features (Cont'd)

	Feature Establishment Charge	Term Payment Plan		
		12 Months	36 Months	60 Months
m. Access to Customer Provided Services				
1) Code Calling				
per line termination	\$25.00	\$13.00	\$12.95	\$12.90
per trunk termination	30.00	25.00	24.90	24.80
2) Loudspeaker Paging				
per line termination	35.00	13.00	12.90	12.80
per trunk termination	15.00	6.80	6.75	6.70
3) Radio Paging				
per line termination	25.00	13.00	12.90	12.80
per trunk termination	15.00	6.80	6.75	6.70
4) Dictation				
per trunk termination	25.00	10.00	9.90	9.80

GENERAL EXCHANGE TARIFF

Embarq Florida, Inc.

By: F. B. Poag  
Director

SECTION A12  
Second Revised Sheet 88  
Cancelling First Revised Sheet 88  
Effective: May 29, 1997

CENTRAL OFFICE NON-TRANSPORT SERVICE OFFERINGS  
(UNITED TELEPHONE EXCHANGES ONLY)

C. ENHANCED CENTREX SERVICE (Cont'd)

9. Optional Service Features (Cont'd)

	Feature Establishment Charge	Term Payment Plan		
		12 Months	36 Months	60 Months
n. System Features				
1) Code Restrictions per system	\$ -	\$12.50	\$12.25	\$11.90
2) Dial Pulse Conversion per system	-	54.00	51.00	49.90
3) Cut through Dialing per system	-	34.00	30.00	29.00
4) Intergroup Calling per system	-	19.75	18.00	17.00
5) Distinctive Call Waiting per system	-	34.00	31.00	30.00
o. Conference Features				
1) Meet-Me Conference - per conference bridge	-	15.00	14.95	14.90
2) Station Controlled - Conference - Large per conference bridge	-	15.00	14.95	14.90
per line	-	.30	.25	.25
3) Attendant Conference - Large per conference bridge	-	15.00	14.95	14.90
per line	-	.15	.15	.10

GENERAL EXCHANGE TARIFF

Embarq Florida, Inc.

By: F. B. Poag  
Director

SECTION A12  
Second Revised Sheet 89  
Cancelling First Revised Sheet 89  
Effective: May 29, 1997

CENTRAL OFFICE NON-TRANSPORT SERVICE OFFERINGS  
(UNITED TELEPHONE EXCHANGES ONLY)

C. ENHANCED CENTREX SERVICE (Cont'd)

9. Optional Service Features (Cont'd)

	Feature Establishment Charge	Term Payment Plan		
		12 Months	36 Months	60 Months
p. Music-On-Hold, Per system				
26 - 75 lines	-	\$45.00	\$42.50	\$41.00
76 - 150 lines	-	\$65.00	\$62.50	\$61.00

D. EXPRESSTOUCH CENTREX FEATURES

1. General

ExpressTouch Centrex features are central office call management features offered to Centrex Basic and Enhanced customers in addition to the optional features offered previously in Section A12 of the tariff.

2. Regulations of Service

a. The following regulations apply to the features listed in D.3.:

- 1) ExpressTouch Centrex features are provided subject to the availability of facilities. Additionally, the features described will only operate on calls originating and terminating within the Custom Local Area Signaling Services (CLASS) serving areas.
- 2) ExpressTouch Centrex features are available to both Basic and Enhanced Centrex Service subscribers.

GENERAL EXCHANGE TARIFF

Embarq Florida, Inc.

By: F. B. Poag  
Director

SECTION A12  
Second Revised Sheet 90  
Cancelling First Revised Sheet 90  
Effective: May 29, 1997

CENTRAL OFFICE NON-TRANSPORT SERVICE OFFERINGS  
(UNITED TELEPHONE EXCHANGES ONLY)

D. EXPRESSTOUCH CENTREX FEATURES (Cont'd)

2. Regulations of Service (Cont'd)

a. The following regulations apply to the features listed in D.3.: (Cont'd)

3) In no event shall the Company be held liable for any losses or damages arising from the unavailability or failure of its equipment or facilities, or for any act, omission or failure of performance by the Company or its employees or agents in connection with this service.

b. The following regulations apply to the Caller ID feature only, in addition to the regulations listed in a. preceding:

1) If an incoming call is from a caller utilizing a PBX trunk or a rotary line group, the telephone number displayed may be the main number of that PBX or rotary group rather than the directory number accessed by the caller.

2) The Company will deliver all numbers, subject to the technical limitations defined in this tariff, including telephone numbers associated with Non- Published Listing Service as described in Section A6 of this tariff.

3) Telephone numbers transmitted via Caller ID are intended solely for the use of the Caller ID subscriber. Resale of this information is prohibited by this tariff.

4) Calling numbers will not be displayed on operator-handled calls, access lines where Calling Number Delivery Blocking has been activated, or with calls originating outside of the CLASS serving area as specified in Section A13.



GENERAL EXCHANGE TARIFF

Embarq Florida, Inc.

By: F. B. Poag  
Director

SECTION A12  
Second Revised Sheet 91  
Cancelling First Revised Sheet 91  
Effective: May 29, 1997

CENTRAL OFFICE NON-TRANSPORT SERVICE OFFERINGS  
(UNITED TELEPHONE EXCHANGES ONLY)

D. EXPRESSTOUCH CENTREX FEATURES (Cont'd)

3. Features

- a. Repeat Dialing - When activated, Repeat Dialing automatically redials the last number the customer attempted to call. If the called line is not busy, the call will be placed and the caller will be notified with a distinctive ring.
- b. Call Return - Call Return enables a customer to place a call to the telephone number associated with the most recent call received, whether or not the call was answered.
- c. Caller ID - This feature enables the customer to view on a display unit the directory number of an incoming telephone call. The display unit may be an ancillary device which is attached to the customer's telephone set or may be a special telephone set with the display unit built-in. The calling number will display between the first and second ring.
- d. Calling Number Delivery Blocking - This service is provided at no charge to the subscriber. The service will be provided as described in Section A13.
- e. Call Tracing
  - 1) Call Tracing enables the customer to initiate an automatic trace of the last call received. A usage charge will be assessed on a per-occasion basis for each successful trace made. A trace is considered successful when the customer is informed by the voice response unit that the Call Tracing has been successfully completed. Certain types of calls, e.g., out of the area long distance, cannot be traced using this feature.

GENERAL EXCHANGE TARIFF

Embarq Florida, Inc.

By: F. B. Poag  
Director

SECTION A12  
Second Revised Sheet 92  
Cancelling First Revised Sheet 92  
Effective: May 29, 1997

CENTRAL OFFICE NON-TRANSPORT SERVICE OFFERINGS  
(UNITED TELEPHONE EXCHANGES ONLY)

D. EXPRESSTOUCH CENTREX FEATURES (Cont'd)

3. Features (Cont'd)

e. Call Tracing (Cont'd)

- 2) Upon activation by the customer, the call tracing information (calling and called number, the time the call was received, and the time the trace was activated) is recorded and stored until requested by an authorized law enforcement agency. The information collection process is instantaneous and the customer using this feature will be notified immediately if the trace was successful and will then be instructed to contact the local law enforcement agency if they wish to file a complaint. The customer is not provided the traced number.
- 3) If the customer receives another call prior to activating the trace, or receives a Call Waiting indication during the call to be traced, Call Tracing will not record the correct number.

GENERAL EXCHANGE TARIFF

Embarq Florida, Inc.

SECTION A12

BY: F. B. Poag  
Director

Third Revised Sheet 93  
Cancelling Second Revised Sheet 93  
Effective: October 13, 2002

CENTRAL OFFICE NON-TRANSPORT SERVICE OFFERINGS  
(UNITED TELEPHONE EXCHANGES ONLY)

D. EXPRESSTOUCH CENTREX FEATURES (Cont'd)

3. Features (Cont'd)

- f. Call Tracing Denial - This service allows the Call Tracing feature to be blocked. To initiate the blocking feature the customer must contact the Company. The Company will then install the blocking feature on the customer's line. The blocking feature cannot be deactivated by the customer. This feature is provided at no charge to the customer.

4. Rates and Charges

	<u>12</u> <u>Months</u>	<u>36</u> <u>Months</u>	<u>60</u> <u>Months</u>
a. Basic Centrex			
1) Repeat Dialing, per line	\$ 2.00	-	-
2) Return Call, per line	2.50	-	-
3) Caller ID, per line	7.00	-	-
b. Enhanced Centrex			
1) Repeat Dialing, per line	\$ 1.50	\$ 1.25	\$ 1.00
2) Return Call, per line	2.25	2.00	1.75
3) Caller ID, per line	5.50	5.25	5.00
c. Call Tracing	\$4.00 per successful trace		

GENERAL EXCHANGE TARIFF

Embarq Florida, Inc.

SECTION A13

By: F. B. Poag  
Director

Second Revised Contents Sheet 1  
Cancelling First Revised Contents Sheet 1  
Effective: January 1, 1998

MISCELLANEOUS SERVICE ARRANGEMENTS

CONTENTS

	<u>SHEET</u>
A. GENERAL	1
B. AUTOMATIC TIME/TEMPERATURE/WEATHER ANNOUNCEMENT SYSTEMS (UNITED TELEPHONE EXCHANGES ONLY)	1
1. General	1
2. Rates and Charges	5
C. RESERVED FOR FUTURE USE	
D. TOUCH TONE	15
1. General	15
2. Rates and Charges	16
E. CUSTOM CALLING FEATURES	16
1. General	16
2. Feature Descriptions	17
3. Rates and Charges	29

GENERAL EXCHANGE TARIFF

Embarq Florida, Inc.

By: F. B. Poag  
Director

SECTION A13  
First Revised Contents Sheet 2  
Cancelling Original Contents Sheet 2  
Effective: January 1, 1997

MISCELLANEOUS SERVICE ARRANGEMENTS

CONTENTS

	<u>SHEET</u>
F. EXPRESSTOUCH SERVICE	30
1. General	30
2. Feature Descriptions	31
3. Regulations and Limitations of Service	32
4. Rates and Charges	38
5. Caller ID	39
6. Caller ID with Name	43
7. Anonymous Call Rejection (ACR)	46
8. ExpressTouch Blocking Services	47
G. CUSTOM CALLING FEATURE PACKAGES	50
1. General	50
2. Package Descriptions	50
3. Rates and Charges	53
H. SIGNALRING	53
1. General	53
2. Regulations	54
3. Rates and Charges	56
I. REMOTE CALL FORWARDING	56
1. General	56
2. Rates and Charges	58

GENERAL EXCHANGE TARIFF

Embarq Florida, Inc.

SECTION A13

By: F. B. Poag  
Director

Fifth Revised Contents Sheet 3  
Cancelling Fourth Revised Contents Sheet 3  
Effective: October 24, 2003

MISCELLANEOUS SERVICE ARRANGEMENTS

CONTENTS

	<u>SHEET</u>
J. RESERVED FOR FUTURE USE	
K. SPECIAL BILLING/REPORTING SERVICES	62
1. Special Billing Service	62
2. Magnetic Tape Toll Billing	64
3. SUNCOM (CCSA) Message Tape for Florida State University, Tallahassee, Florida - Central Telephone	65
4. Duplicate Bill Charges	66
5. Billing Breakdown Charge	66.1
L. CALL SCREENING SERVICES.	67
1. Residence and Business Operator Screening	67
2. Billed Number Screening - United Telephone exchanges	68
3. Billed Number Screening - Central Telephone exchanges	69
4. Answer Supervision	73
M. BLOCKING SERVICES	74
1. 976/900/N11	74
2. Custom Code Restrictions (CCR) - United Telephone Exchanges	74
3. Restricted Sent-Paid Service (RSPS) – Central Telephone Exchanges	79
4. Call Aggregator Screening Service: Central Office Blocking with Operator Screening - Central Telephone Exchanges	85
5. Third Party Block Service	88
6. Toll and Casual Dialing Restriction Service	88.2

GENERAL EXCHANGE TARIFF

Embarq Florida, Inc.

By: F. B. Poag  
Director

SECTION A13  
Second Revised Contents Sheet 4  
Cancelling First Revised Contents Sheet 4  
Effective: June 5, 1998

MISCELLANEOUS SERVICE ARRANGEMENTS

CONTENTS

SHEET

N.	SIMPLIFIED MESSAGE DESK INTERFACE (SMDI) SERVICE	89
	1. General	89
	2. Regulations	90
	3. Rates and Charges	91
O.	SINGLE PARTY ACCESS LINE FEATURE (CUTOFF ON DISCONNECT)	92
	1. General	92
	2. Rates and Charges	92
P.	TELECOMMUNICATIONS SERVICE PRIORITY (TSP) SERVICE	93
	1. General	93
	2. Rates and Charges	97
Q.	RESERVED FOR FUTURE USE	
R.	ENHANCED DATA TRANSMISSION SERVICE (EDTS)	99
	1. General	99
	2. Regulations	100
	3. Rates and Charges	101

GENERAL EXCHANGE TARIFF

Embarq Florida, Inc.

SECTION A13

By: F. B. Poag  
Director

Third Revised Contents Sheet 5  
Cancelling Second Revised Contents Sheet 5  
Effective: June 1, 1997

MISCELLANEOUS SERVICE ARRANGEMENTS

CONTENTS

	<u>SHEET</u>
S. OFF-PREMISES EXTENSION SERVICE	102
1. General	102
2. Types and Descriptions	104
3. Rates and Charges	105
4. Service Connection Charges	107
T. HOT LINE SERVICE - CENTRAL TELEPHONE EXCHANGES	109
1. General	109
2. Rates and Charges	110
U. TOLL TERMINAL SERVICE	111
1. General	111
2. Rates for Toll Terminal Service Trunks	113
V. DIRECTORY NUMBER TRANSFER - UNITED TELEPHONE EXCHANGES	113
1. General	113
2. Rates and Charges	114
W. EXTENSION LINE MILEAGE	115
1. General	115
2. Rates and Charges	116
X. TOLL BLOCK/PAYMENT ARRANGEMENTS	117



GENERAL EXCHANGE TARIFF

Embarq Florida, Inc.

By: F. B. Poag  
Director

SECTION A13  
Ninth Revised Contents Sheet 6  
Cancelling Eighth Revised Contents Sheet 6  
Effective: November 1, 2005

MISCELLANEOUS SERVICE ARRANGEMENTS

CONTENTS

	<u>SHEET</u>
Y. PRIVACY ID	118
1. General	118
2. Terms and Conditions	118
3. Rates and Charges	118
Z. TALKING CALL WAITING	119
1. General	119
2. Terms and Conditions	119
3. Rates and Charges	119

GENERAL EXCHANGE TARIFF

Embarq Florida, Inc.

By: F. B. Poag  
Director

SECTION A13  
First Revised Sheet 1  
Cancelling Original Sheet 1  
Effective: January 1, 1997

MISCELLANEOUS SERVICE ARRANGEMENTS

A. GENERAL

1. The following monthly rates and charges with their associated regulations apply for the equipment and facilities listed following.
2. For work functions required on miscellaneous equipment items that are connected, moved or changed, a secondary service Ordering Charge for residence or business, as appropriate to the service with which it is associated, will be applicable in addition to the charges specified in this section of the tariff, except as provided hereafter.

B. AUTOMATIC TIME/TEMPERATURE/WEATHER ANNOUNCEMENT SYSTEMS  
UNITED TELEPHONE EXCHANGES ONLY

1. General
  - a. The Company will provide facilities, when available, in the exchanges specified herein, for customers for their use in providing automatic announcements by telephone to calling parties simultaneously.
  - b. The Company will furnish all facilities required for such announcements, including the automatic announcement equipment, associated apparatus and announcement lines. The automatic announcement equipment shall be located on the premises of the Company unless the Company agrees to a location elsewhere.

GENERAL EXCHANGE TARIFF

Embarq Florida, Inc.

By: F. B. Poag  
Director

SECTION A13  
First Revised Sheet 2  
Cancelling Original Sheet 2  
Effective: January 1, 1997

MISCELLANEOUS SERVICE ARRANGEMENTS

B. AUTOMATIC TIME/TEMPERATURE/WEATHER ANNOUNCEMENT SYSTEMS  
UNITED TELEPHONE EXCHANGES ONLY (Cont'd)

1. General (Cont'd)

- c. The customer will contract for a unit of such capacity and for as many announcement lines and terminal equipment initially and subsequently as may be required in the judgment of the Company to adequately handle calls to announcement equipment without impairing the Company's general telephone service or telephone plant.
- d. Facilities shall be used for such announcement, together with such other announcement as may be desired by the customer, provided, however, that the contents and length of such announcements shall be subject to the approval of the Company.
- e. The Company will furnish said announcement facilities to its customers for use by such customers in providing announcements, only within the limits of the local service area serving the customer, including the limits of other local service areas having access to the location of the announcement facilities on a local service basis. This limitation, however, is not intended to preclude the completion of any incoming sent paid message toll calls placed to the time announcement number.
- f. Telephone users calling the announcement numbers are automatically disconnected after elapsing of time for one full announcement.

GENERAL EXCHANGE TARIFF

Embarq Florida, Inc.

By: F. B. Poag  
Director

SECTION A13  
First Revised Sheet 3  
Cancelling Original Sheet 3  
Effective: January 1, 1997

MISCELLANEOUS SERVICE ARRANGEMENTS

B. AUTOMATIC TIME/TEMPERATURE/WEATHER ANNOUNCEMENT SYSTEMS  
UNITED TELEPHONE EXCHANGES ONLY (Cont'd)

1. General (Cont'd)

- g. The customer indemnifies and saves the Company harmless against claims for libel, slander, or infringement of copyright arising from the material transmitted over facilities furnished hereunder; and against all other claims arising out of any act or omission of the customer in connection with facilities provided by the Company.
- h. The liability of the Company for damages arising out of mistakes, omissions, interruptions, delays, or errors or defects in transmission occurring in the course of furnishing service or other facilities and not caused by the negligence of the customer, or of the Company in failing to maintain proper standards of maintenance and operation and to exercise reasonable supervision, shall in no event exceed an amount equivalent to the proportionate charge to the customer for the period of service during which such mistake, omission, interruption, delay, or error or defect in transmission occurs.
- i. One directory listing without charge will be furnished with each service, said listing to appear under the caption heading for the service furnished with the name of the customer listed there under. Additional listings will be furnished at rates shown in the "Directory Listings" section of this tariff.
- j. If requested, a monitoring line may be terminated on the premises of the customer when the announcement equipment is located in the Company's central office. The rate for this service is equal to the mileage charges from the serving central office to the location of the line termination.

GENERAL EXCHANGE TARIFF

Embarq Florida, Inc.

By: F. B. Poag  
Director

SECTION A13  
First Revised Sheet 4  
Cancelling Original Sheet 4  
Effective: January 1, 1997

MISCELLANEOUS SERVICE ARRANGEMENTS

B. AUTOMATIC TIME/TEMPERATURE/WEATHER ANNOUNCEMENT SYSTEMS  
UNITED TELEPHONE EXCHANGES ONLY (Cont'd)

1. General (Cont'd)

- k. The Company is not obligated to furnish record or message strip changes prior to sixty (60) days after the date of an order for such record or message strip changes.
- l. Service will be furnished in any dial exchange where all the necessary facilities, as determined by the Company, are available or can be made available within a reasonable time, at reasonable expense.
- m. Contracts for announcement lines are taken for an initial period of one month.
- n. No material which is prohibited by law or deemed objectionable by the Company may be transmitted over the facilities furnished hereunder.
- o. Contracts for announcement equipment are taken for initial periods of thirty-six (36) months unless otherwise specified. Contracts may be terminated prior to their expiration at any time upon reasonable notice in writing and upon payment of all full monthly charges for the remainder of the initial contract period (i.e., all charges due for the period service has been rendered, plus a termination charge computed by reducing the basic termination charge as appropriate for each month the service has been in effect).

GENERAL EXCHANGE TARIFF

Embarq Florida, Inc.

By: F. B. Poag  
Director

SECTION A13  
Second Revised Sheet 5  
Cancelling First Revised Sheet 5  
Effective: July 21, 1998

MISCELLANEOUS SERVICE ARRANGEMENTS

B. AUTOMATIC TIME/TEMPERATURE/WEATHER ANNOUNCEMENT SYSTEMS  
UNITED TELEPHONE EXCHANGES ONLY (Cont'd)

2. Rates and Charges

Announcement facilities are furnished at the charges as shown below, except that when the equipment is located on the customer's premises, additional charges will apply. Also, when standby equipment is desired by the customer, additional charges will apply. This service is furnished on a where-available basis and is subject to the availability of facilities.

	<u>Installation Charge</u>	<u>Monthly Rate</u>	<u>Basic Termination Charge</u>
a. Announcement Lines		Applicable B-1 Rate	--
b. Access Line Equipment per line		\$6.00	

GENERAL EXCHANGE TARIFF

Embarq Florida, Inc.

BY: F. B. Poag  
Director

SECTION A13  
Second Revised Sheet 6  
Cancelling First Revised Sheet 6  
Effective: July 21, 1998

MISCELLANEOUS SERVICE ARRANGEMENTS

B. AUTOMATIC TIME/TEMPERATURE/WEATHER ANNOUNCEMENT SYSTEMS  
UNITED TELEPHONE EXCHANGES ONLY (Cont'd)

2. Rates and Charges (Cont'd)

	<u>Installation Charge</u>	<u>Monthly Rate</u>	<u>Basic Termination Charge</u>
c. Announcement Equipment			
1) Time			
a) Audichron STM-100 Single Unit	\$ 50.00	\$300.00	As appropriate
b) Audichron M1Z Single Unit	50.00	464.75	As appropriate

GENERAL EXCHANGE TARIFF

Embarq Florida, Inc.

BY: F. B. Poag  
Director

SECTION A13  
First Revised Sheet 7  
Cancelling Original Sheet 7  
Effective: January 1, 1997

MISCELLANEOUS SERVICE ARRANGEMENTS

B. AUTOMATIC TIME/TEMPERATURE/WEATHER ANNOUNCEMENT SYSTEMS  
UNITED TELEPHONE EXCHANGES ONLY (Cont'd)

2. Rates and Charges (Cont'd)

	<u>Installation Charge</u>	<u>Monthly Rate</u>	<u>Basic Termination Charge</u>
c. Announcement Equipment (Cont'd)			
2) Temperature			
a) Audichron STM-100 Single Unit	\$ 50.00	\$135.85	As appropriate
b) Audichron M1Z Single Unit	50.00	164.45	As appropriate
3) Audichron Weather <sup>1</sup>	250.00	235.95	As appropriate

Note 1: Unit includes automatic selective programmer. Rates for the control channel terminal apply as specified in the "Private Line" section of this tariff.



GENERAL EXCHANGE TARIFF

Embarq Florida, Inc.

BY: F. B. Poag  
Director

SECTION A13  
Second Revised Sheet 8  
Cancelling First Revised Sheet 8  
Effective: July 21, 1998

MISCELLANEOUS SERVICE ARRANGEMENTS

B. AUTOMATIC TIME/TEMPERATURE/WEATHER ANNOUNCEMENT SYSTEMS  
UNITED TELEPHONE EXCHANGES ONLY (Cont'd)

2. Rates and Charges (Cont'd)

	<u>Installation Charge</u>	<u>Monthly Rate</u>	<u>Basic Termination Charge</u>
c. Announcement Equipment (Cont'd)			
4) Time and Temperature Audichron STM-100X	\$ 40.00	\$380.00	As appropriate
5) Time, Temperature, and Weather Audichron M1ZRSX/TLP	50.00	715.00	As appropriate

GENERAL EXCHANGE TARIFF

Embarq Florida, Inc.

BY: F. B. Poag  
Director

SECTION A13  
First Revised Sheet 9  
Cancelling Original Sheet 9  
Effective: January 1, 1997

MISCELLANEOUS SERVICE ARRANGEMENTS

B. AUTOMATIC TIME/TEMPERATURE/WEATHER ANNOUNCEMENT SYSTEMS  
UNITED TELEPHONE EXCHANGES ONLY (Cont'd)

2. Rates and Charges (Cont'd)

Installation Charge

d. Announcement Records

- 1) Additional record drums other than replacements for maintenance purposes, each  
\$ 85.00
- 2) Time records (hour and minute), set  
150.00
- 3) Message record changes made at the same time on a suitable existing record drum (to erase and re-record) per record change.  
90.00
- 4) Change-out on Announcement equipment of a working message record drum to available alternate drum having different messages, each

Installation  
Charge

\$5.00

Monthly  
Rate

--

GENERAL EXCHANGE TARIFF

Embarq Florida, Inc.

BY: F. B. Poag  
Director

SECTION A13  
Second Revised Sheet 10  
Cancelling First Revised Sheet 10  
Effective: January 1, 1998

MISCELLANEOUS SERVICE ARRANGEMENTS

B. AUTOMATIC TIME/TEMPERATURE/WEATHER ANNOUNCEMENT SYSTEMS  
UNITED TELEPHONE EXCHANGES (Cont'd)

2. Rates and Charges (Cont'd)

d. Announcement Records (Cont'd)

- 5) Change from one designated announcement or series to another on the same drum, not requiring a change out-of-drum, each change

<u>Installation Charge</u>	<u>Monthly Rate</u>
\$ 1.50	--

e. Monitoring Line

Extension Line Charges

C. RESERVED FOR FUTURE USE

GENERAL EXCHANGE TARIFF

Embarq Florida, Inc.

BY: F. B. Poag  
Director

SECTION A13  
Third Revised Sheet 11  
Cancelling Second Revised Sheet 11  
Effective: January 1, 1998

MISCELLANEOUS SERVICE ARRANGEMENTS

RESERVED FOR FUTURE USE

GENERAL EXCHANGE TARIFF

Embarq Florida, Inc.

BY: F. B. Poag  
Director

SECTION A13  
Third Revised Sheet 12  
Cancelling Second Revised Sheet 12  
Effective: January 1, 1998

MISCELLANEOUS SERVICE ARRANGEMENTS

RESERVED FOR FUTURE USE

GENERAL EXCHANGE TARIFF

Embarq Florida, Inc.

BY: F. B. Poag  
Director

SECTION A13  
Third Revised Sheet 13  
Cancelling Second Revised Sheet 13  
Effective: January 1, 1998

MISCELLANEOUS SERVICE ARRANGEMENTS

RESERVED FOR FUTURE USE

GENERAL EXCHANGE TARIFF

Embarq Florida, Inc.

BY: F. B. Poag  
Director

SECTION A13  
Second Revised Sheet 14  
Cancelling First Revised Sheet 14  
Effective: January 1, 1998

MISCELLANEOUS SERVICE ARRANGEMENTS

RESERVED FOR FUTURE USE

GENERAL EXCHANGE TARIFF

Embarq Florida, Inc.

BY: F. B. Poag  
Director

SECTION A13  
Fourth Revised Sheet 15  
Cancelling Third Revised Sheet 15  
Effective: March 1, 2003

MISCELLANEOUS SERVICE ARRANGEMENTS

RESERVED FOR FUTURE USE



GENERAL EXCHANGE TARIFF

Embarq Florida, Inc.

BY: F. B. Poag  
Director

SECTION A13  
Sixth Revised Sheet 16  
Cancelling Fifth Revised Sheet 16  
Effective: August, 1, 2005

MISCELLANEOUS SERVICE ARRANGEMENTS

D. CUSTOM CALLING FEATURES

1. General

- a. Custom calling features consist of optional central office features which are intended to provide subscribers with a greater efficiency of the use of their telephone service.
- b. Custom calling features are limited to those areas served by electronically controlled central offices equipped for custom calling features, and will be offered as available.
- c. Custom calling features are furnished only in connection with individual line service and rotary line service when available, exclusive of pay telephone service.
- d. Call Forwarding services and Three-Way Calling Service contemplate that normal transmission performance quality cannot be guaranteed on all calls and cannot be effected in all instances depending on the distance and routing necessary to complete the call(s) involved.
- e. When custom calling features are furnished in connection with rotary line service, charges apply for each rotary line that the subscriber requests to be so equipped.

GENERAL EXCHANGE TARIFF

Embarq Florida, Inc.

BY: F. B. Poag  
Director

SECTION A13  
Third Revised Sheet 17  
Cancelling Second Revised Sheet 17  
Effective: August, 1, 2005

MISCELLANEOUS SERVICE ARRANGEMENTS

E. CUSTOM CALLING FEATURES (Cont'd)

2. Feature Descriptions

a. Call Forward Features

Call Forward Features permit the forwarding of incoming calls under a variety of conditions to another telephone number either by dialing an activation code or via pre-programming by the Company. Calls may be forwarded to any number subject to the availability of the necessary facilities in the central office from which the calls are to be transferred. The customer subscribing to this service is responsible for applicable usage charges. Only one call forwarding arrangement, consisting of a single calling path, will be provided per exchange service line for which the customer subscribes to this feature.

Call Forward Features shall not be used to extend calls on a planned and continuing basis to intentionally avoid the payment in whole or in part, of usage charges that would regularly be applicable between the station originating the call and the station to which the call is ultimately transferred.

## GENERAL EXCHANGE TARIFF

Embarq Florida, Inc.

BY: F. B. Poag  
Director

SECTION A13  
Third Revised Sheet 18  
Cancelling Second Revised Sheet 18  
Effective: August, 1, 2005

### MISCELLANEOUS SERVICE ARRANGEMENTS

#### E. CUSTOM CALLING FEATURES (Cont'd)

##### 2. Feature Descriptions (Cont'd)

###### a. Call Forward Features (Cont'd)

###### 1. Call Forwarding

This feature permits the manual forwarding of incoming calls to another telephone number. When activated, all calls will forward; calls cannot be answered from a line with Call Forwarding activated. Call Forwarding overrides Call Forward No Answer and Call Forward Busy, but those features resume functionality when Call Forwarding is deactivated.

- a) Call Forwarding (FCF1FLC) – Provides a customer the capability to control activation/deactivation and the forward-to number of the service by using dialing tones.
- b) Call Forward Fixed (FCF1FLC FIX) - Provides a customer the capability to control activation/deactivation of the service by using dialing tones. The customer selected forward-to number is preprogrammed by the Company at the time service is established and can only be changed via service order.

###### 2. Call Forward No Answer

This feature permits the automatic forwarding of an incoming call to another telephone number when the called telephone remains unanswered for a predetermined number of rings, usually four or five.

Where facilities are available, this feature also includes Call Forwarding of Call Waiting when the customer is also subscribed to Call Waiting or Enhanced Call Waiting. Call Forwarding of Call Waiting forwards unanswered waiting calls to a customer-designated telephone number using Call Waiting and Call Forward No Answer. An incoming call to a busy line first receives a Call Waiting tone. If the call is not answered within a set period of time, the incoming call is forwarded to a customer-designated telephone number.

- a) Call Forward No Answer-Fixed (FCD1FLC) – This feature is activated and the customer selected forward-to number is preprogrammed by the Company at the time service is established and can only be changed via service order.
- b) Call Forward No Answer-Customer Programmable (FCD1FLC PRG) – Provides a customer the capability to control activation/deactivation and the forward-to number of the service by using dialing tones.
- c) Call Forward No Answer-Customer Controlled (FCD1FLC CC) – Provides a customer the capability to control activation/deactivation of the service by using dialing tones. The customer selected forward-to number is preprogrammed by the Company at the time service is established and can only be changed via service order.

GENERAL EXCHANGE TARIFF

Embarq Florida, Inc.

BY: F. B. Poag  
Director

SECTION A13  
Third Revised Sheet 19  
Cancelling Second Revised Sheet 19  
Effective: August, 1, 2005

MISCELLANEOUS SERVICE ARRANGEMENTS

E. CUSTOM CALLING FEATURES (Cont'd)

2. Feature Descriptions (Cont'd)

a. Call Forward Features (Cont'd)

3. Call Forward Busy

This feature permits the automatic forwarding of an incoming call to another telephone number when the called telephone is already in use. Call Forward Busy shall not be used to extend calls on a planned and continuing basis to intentionally avoid the payment of Rotary Line/Hunting Service.

- a) Call Forward Busy-Fixed (FCB1FLC) – This feature is activated and the customer selected forward-to number is preprogrammed by the Company at the time service is established and can only be changed via service order.
- b) Call Forward Busy-Customer Programmable (FCB1FLC PRG) – Provides a customer the capability to control activation/deactivation and the forward-to number of the service by using dialing tones.
- c) Call Forward Busy-Customer Controlled (FCB1FLC CC) – Provides a customer the capability to control activation/deactivation of the service by using dialing tones. The customer selected forward-to number is preprogrammed by the Company at the time service is established and can only be changed via service order.

GENERAL EXCHANGE TARIFF

Embarq Florida, Inc.

BY: F. B. Poag  
Director

SECTION A13  
Fifth Revised Sheet 20  
Cancelling Fourth Revised Sheet 20  
Effective: August, 1, 2005

MISCELLANEOUS SERVICE ARRANGEMENTS

E. CUSTOM CALLING FEATURES (Cont'd)

2. Feature Descriptions (Cont'd)

a. Call Forward Features (Cont'd)

4. Call Forward Remote Activation (FCG1FLC)

This feature allows the Call Forwarding subscriber to change the Call Forwarding status of their telephone line from a remote location using a touch-tone telephone. To redirect Call Forwarding from a remote location, the subscriber dials a remote-access directory number. Once the subscriber's authorization code is verified, the subscriber can activate, deactivate, or change call forwarding to a new destination.

- b. Three-Way Calling Service - This service permits an existing call to be held, and by dialing, a second telephone call can be established and added to the connection.

Three-Way Calling is available on a flat rate or a usage sensitive basis. The usage sensitive option is only available to residence and business single line customers. Under the usage sensitive option, the customer will incur an activation charge on a completed call. The provision of this service on a usage sensitive basis is subject to technical limitations and is provided on a where available basis.

GENERAL EXCHANGE TARIFF

Embarq Florida, Inc.

BY: F. B. Poag  
Director

SECTION A13  
First Revised Sheet 20.1  
Cancelling Original Sheet 20.1  
Effective: March 8, 1997

MISCELLANEOUS SERVICE ARRANGEMENTS

E. CUSTOM CALLING FEATURES (Cont'd)

2. Feature Descriptions (Cont'd)

- e. Call Waiting Service - This service provides a tone signal to indicate to a customer who is using his/her telephone that another party is attempting to call him/her. It also permits the customer to answer the incoming call while holding the original call.

GENERAL EXCHANGE TARIFF

Embarq Florida, Inc.

BY: F. B. Poag  
Director

SECTION A13  
Second Revised Sheet 21  
Cancelling First Revised Sheet 21  
Effective: August 1, 2005

MISCELLANEOUS SERVICE ARRANGEMENTS

E. CUSTOM CALLING FEATURES (Cont'd)

2. Feature Descriptions (Cont'd)

- f. Enhanced Call Waiting - This service combines the features of call waiting and the cancel call waiting feature which allows the customer to defer the call waiting feature to prevent call waiting tones from interrupting calls or disrupting data transmissions. Cancel call waiting can be activated before or during a call by dialing an access code and the cancellation stays in effect for the duration of the call. Incoming calls receive a busy signal while cancel call waiting is in effect.
- g. Speed Calling Service (Abbreviated Dialing Service) - This service permits a customer to call certain other predetermined telephone numbers by dialing an abbreviated code rather than the entire 7 or 10 digit telephone number. The arrangement available is an 8-number capacity (8-code).
- h. Reserved for Future Use

GENERAL EXCHANGE TARIFF

Embarq Florida, Inc.

BY: F.B. Poag  
Director

SECTION A13  
Fourth Revised Sheet 22  
Cancelling Third Revised Sheet 22  
Effective: August 14, 2003

MISCELLANEOUS SERVICE ARRANGEMENTS

E. CUSTOM CALLING FEATURES (Cont'd)

2. Feature Descriptions (Cont'd)

i. Three-Way Calling with Transfer - This feature allows a business customer to hold an in-progress call and complete a second call while maintaining privacy from the first call, or to add on the previously held call for a three-way conference. Incoming calls may be transferred to another access arrangement on an inter- or intra-switch basis, except as specified in Section A13.E.2.i.3) following.

1) The subscriber can transfer the caller to the secondary destination in one of three ways:

a) Blind Transfer

By placing the original caller on hold, dialing the secondary destination, and upon hearing the ring, hang up, resulting in the original caller being connected to the secondary destination.

b) Announced Transfer

By placing the original caller on hold, dialing the secondary destination, and upon the party at the secondary destination answering the phone, the subscriber announces the transfer of the call (on hold at the time) and hangs up (on hook), resulting in the original caller being connected to the secondary destination.

c) Three-Way Conferencing with Option to Transfer

By placing the original caller on hold, dialing the secondary destination, and upon the party at the secondary destination answering the phone, taking the original caller off-hold; resulting in a three way connection. The subscriber can then hang up, resulting in the original caller continuing to be connected to the caller at the secondary destination.

2) The subscriber of Three-Way Calling with Transfer can receive or originate the initial call. Three-Way Calling with Transfer allows the subscriber to originate both legs of a three-way connection and subsequently disconnect, enabling the other parties to remain connected.

3) Where the subscriber originates both legs of a three-way call, those legs will remain bridged together when the subscriber goes on hook when at least one of the legs is a call for which both the originating and terminating points are served by the same switch. Where the subscriber originates two inter-switch legs of a three-way call, both legs remain bridged when the subscriber goes on hook where the serving switch is not a 5ESS switch. For such calls in a 5ESS switch, both inter-switch legs are disconnected when the subscriber goes on hook.



GENERAL EXCHANGE TARIFF

Embarq Florida, Inc.

BY: F. B. Poag  
Director

SECTION A13  
Fifth Revised Sheet 23  
Cancelling Fourth Revised Sheet 23  
Effective: August 14, 2003

MISCELLANEOUS SERVICE ARRANGEMENTS

E. CUSTOM CALLING FEATURES (Cont'd)

2. Feature Descriptions (Cont'd)

i. Three-Way Calling with Transfer (Cont'd)

- 4) This feature shall not be used to extend calls on a planned and continuing basis to intentionally avoid the payment in whole or in part of message charges, toll or otherwise, that would regularly be applicable between the stations bridged together by the subscriber.
- 5) The Three-Way Calling with Transfer subscriber is responsible for all applicable local and toll usage charges for calls originated by the subscriber, including connections which continue after the subscriber exits the call.

GENERAL EXCHANGE TARIFF

Embarq Florida, Inc.

BY: F. B. Poag  
Director

SECTION A13  
Fourth Revised Sheet 24  
Cancelling Third Revised Sheet 24  
Effective: June 28, 2000

MISCELLANEOUS SERVICE ARRANGEMENTS

RESERVED FOR FUTURE USE

GENERAL EXCHANGE TARIFF

Embarq Florida, Inc.

BY: F. B. Poag  
Director

SECTION A13  
Third Revised Sheet 25  
Cancelling Second Revised Sheet 25  
Effective: June 28, 2000

MISCELLANEOUS SERVICE ARRANGEMENTS

E. CUSTOM CALLING FEATURES (Cont'd)

2. Feature Descriptions (Cont'd)

- j. Call Waiting ID alerts the subscriber that there is another call by providing a call waiting tone and the display unit or screen phone will display the number of the calling party. At that time, the customer can decide whether to answer the call or not.
  - 1) Utilization of this feature requires the use of a specific display unit or screen phone station at the subscriber's premises. The installation and maintenance of this CPE is the responsibility of the subscriber.
  - 2) The Company assumes no liability, and will be held harmless, for any incompatibility between the subscriber's equipment and this feature.
  - 3) All terms and conditions, including rates, for the other features associated with the line are as described in the feature-specific sections of this tariff. Those features must be ordered separately.

GENERAL EXCHANGE TARIFF

Embarq Florida, Inc.

BY: F. B. Poag  
Director

SECTION A13  
First Revised Sheet 26  
Cancelling Original Sheet 26  
Effective: January 1, 1997

MISCELLANEOUS SERVICE ARRANGEMENTS

E. CUSTOM CALLING FEATURES (Cont'd)

2. Feature Descriptions (Cont'd)

j. Call Waiting ID (Cont'd)

4) This service is furnished on a where-available basis and is subject to the availability of facilities. The service is only available to single-line business and residence customers. It is not available to Centrex, DID or Coin telephone services. It will be available only to certain types of PBX systems depending on the customer's equipment, as well as the central office limitations.

5) Subscribers to this service must also subscribe to Touch Tone service.

6) Service Charges for the establishment of this service do not apply.

k. Call Waiting Options allows the customer more control of incoming calls by offering five options, using the specialized display unit or screen phone, in an easy-to-use format. The five options are as follows:

1) Talk2nd - Places the current caller on hold while the incoming call is answered.

2) Drop1st - Ends the current call and answers the incoming call.

GENERAL EXCHANGE TARIFF

Embarq Florida, Inc.

BY: F. B. Poag  
Director

SECTION A13  
First Revised Sheet 27  
Cancelling Original Sheet 27  
Effective: January 1, 1997

MISCELLANEOUS SERVICE ARRANGEMENTS

E. CUSTOM CALLING FEATURES (Cont'd)

2. Feature Descriptions (Cont'd)

k. Call Waiting Options (Cont'd)

- 3) HoldMsg - Sends the incoming caller to a prerecorded message saying that their call will be answered in a moment and then places the caller on hold until the call can be answered.
- 4) Add2nd - Places both the current caller and the incoming caller on the line into a three-way conference.
- 5) TakeMsg - Forwards the incoming caller to voicemail or an answering service. This option is offered on a where-available basis.
- 6) Regulations
  - a) Utilization of this feature requires the use of a specific display unit or screen phone station at the customer's premises. The installation and maintenance of this CPE is the responsibility of this customer.
  - b) The Company assumes no liability, and will be held harmless, for any incompatibility between the customer's equipment and this feature.
  - c) All terms and conditions, including rates, for the other features associated with the line are as described in the feature-specific sections of this tariff. Those features must be ordered separately.

GENERAL EXCHANGE TARIFF

Embarq Florida, Inc.

BY: F. B. Poag  
Director

SECTION A13  
First Revised Sheet 28  
Cancelling Original Sheet 28  
Effective: January 1, 1997

MISCELLANEOUS SERVICE ARRANGEMENTS

E. CUSTOM CALLING FEATURES (Cont'd)

2. Feature Descriptions (Cont'd)

k. Call Waiting Options (Cont'd)

6) Regulations (Cont'd)

d) This service is furnished on a where-available basis and is subject to the availability of facilities. The service is only available to single-line business and residence customers. It is not available to Centrex, DID or Coin telephone services. It will be available only to certain types of PBX systems depending on the customer's equipment, as well as the central office limitations.

7) Subscribers to this service must also subscribe to Touch Tone service.

8) Service charges for the establishment of this service do not apply.

GENERAL EXCHANGE TARIFF

Embarq Florida, Inc.

BY: F. B. Poag  
Director

SECTION A13  
Thirteenth Revised Sheet 29  
Cancelling Twelfth Revised Sheet 29  
Effective: August 1, 2005

MISCELLANEOUS SERVICE ARRANGEMENTS

E. CUSTOM CALLING FEATURES (Cont'd)

3. Rates and Charges (per central office line equipped)

Per Feature

<u>Residence</u>	<u>Monthly Rate</u>
Call Forwarding	\$ 4.00
Call Forward No Answer	
- Fixed	1.25
- Customer Programmable	1.25
- Customer Controlled	1.25
Call Forward Busy	
- Fixed	1.25
- Customer Programmable	1.25
- Customer Controlled	1.25
Call Forward Remote Activation	2.00
Three-Way Calling	
- Flat Rate	4.00
- Usage Sensitive	1.25
Call Waiting	6.50
Enhanced Call Waiting	6.50
Speed Calling 8	3.00
Speed Calling 30	4.00
Call Waiting ID	2.00
Call Waiting Options	6.00

GENERAL EXCHANGE TARIFF

Embarq Florida, Inc.

BY: F. B. Poag  
Director

SECTION A13  
Thirteenth Revised Sheet 30  
Cancelling Twelfth Revised Sheet 30  
Effective: October 4, 2005

MISCELLANEOUS SERVICE ARRANGEMENTS

E. CUSTOM CALLING FEATURES (Cont'd)

3. Rates and Charges (per central office line equipped) (Cont'd)

Per Feature	Monthly Rate
<u>Business</u>	
Call Forwarding	\$ 6.00
Call Forward No Answer	
- Fixed	1.50
- Customer Programmable	1.50
- Customer Controlled	1.50
Call Forward Busy	
- Fixed	1.50
- Customer Programmable	1.50
- Customer Controlled	1.50
Call Forward Remote Activation	5.00
Three-Way Calling	
- Flat Rate	5.00
- Usage Sensitive	1.25
Call Waiting	6.00
Enhanced Call Waiting	6.00
Speed Calling	4.00
Three-Way Calling with Transfer -	5.00
Call Waiting ID	2.00
Call Waiting Options	6.00

F. EXPRESSTOUCH SERVICE<sup>1</sup>

1. General

ExpressTouch Service is a group of central office call management features offered in addition to basic telephone service and is an enhanced Custom Calling Feature package.

<sup>1</sup>Previously called Custom Calling II Service in Central Telephone exchanges.



GENERAL EXCHANGE TARIFF

Embarq Florida, Inc.

BY: F. B. Poag  
Director

SECTION A13  
First Revised Sheet 31  
Cancelling Original Sheet 31  
Effective: January 1, 1997

MISCELLANEOUS SERVICE ARRANGEMENTS

F. EXPRESSTOUCH SERVICE (Cont'd)

2. Feature Descriptions

a. Return Call

- 1) This feature enables a customer to place a call to the telephone number associated with the most recent call received, whether or not the call was answered or the number is known.
- 2) The customer must dial a code to request that the network place the call. Where facilities permit, upon activation of the feature, the customer will receive a voice announcement stating that Return Call has been accessed. In addition, the announcement will provide the Directory Number (DN) of the last incoming call. The Return Call user will then be prompted to enter an additional digit to continue with the feature activation, or to hang up to abort the activation. If the called line is not busy, the call is placed. If the called line is busy, a confirmation announcement is heard, the customer hangs up, and a queuing process begins. For the next 30 minutes, both the calling and called lines are checked periodically for availability to complete the call. If during this queuing process the called line becomes idle, the customer is notified, via a distinctive ring, that the network is ready to place the call. When the customer picks up the telephone handset the call will automatically be placed.

GENERAL EXCHANGE TARIFF

Embarq Florida, Inc.

BY: F. B. Poag  
Director

SECTION A13  
Second Revised Sheet 32  
Cancelling First Revised Sheet 32  
Effective: July 17, 1997

MISCELLANEOUS SERVICE ARRANGEMENTS

F. EXPRESSTOUCH SERVICE (Cont'd)

2. Feature Descriptions (Cont'd)

a. Return Call (Cont'd)

- 3) This feature is not available on operator handled calls. In connection with Return Call, the Company will deliver all numbers, subject to technical limitations, including telephone numbers associated with Non-Published Listing Service.
- 4) If the last incoming call originated from a telephone where delivery of the number was suppressed, either via per call or per line blocking, the Return Call subscriber will receive an announcement stating the last incoming call was private and the call cannot be returned.

If the last incoming call number is unavailable for any reason other than suppression via blocking, the Return Call subscriber will receive an announcement stating that Return Call cannot be activated at this time because the telephone number is not in the Company's serving area. In this instance, Return Call will not be activated.

- 5) If the incoming call is from a caller served by a PBX, only the main number of the PBX is transmitted and available for the voice announcement.
- 6) If the incoming call is from a SignalRing customer, the telephone number transmitted and available for voice announcement will be the main Directory Number rather than any dependent SignalRing service number.
- 7) If the incoming call originates from a multi-line hunt group, the telephone number transmitted and available for the voice announcement will always be the main number of the hunt group, unless the telephone numbers are identified within the group.

GENERAL EXCHANGE TARIFF

Embarq Florida, Inc.

BY: F. B. Poag  
Director

SECTION A13  
Fourth Revised Sheet 33  
Cancelling Third Revised Sheet 33  
Effective: May 27, 2004

MISCELLANEOUS SERVICE ARRANGEMENTS

F. EXPRESSTOUCH SERVICE (Cont'd)

2. Feature Descriptions (Cont'd)

a. Return Call (Cont'd)

- 8) Return Call is available on a flat rate or a usage sensitive basis. Under the usage sensitive basis, whether the customer chooses to advance the call or abandon the call, the usage sensitive activation charge will apply. The provision of this service on a usage sensitive basis is subject to technical limitations and is provided on a where available basis.

b. Repeat Dialing

- 1) Repeat Dialing, when activated, automatically redials the last number the customer attempted to call. If the called line is not busy, the call will be placed.

When a caller receives a busy condition, where technically feasible the service will automatically play an announcement offering the caller the option, by entering the activation code, of having the service complete the call when the called line becomes available.

- 2) If the called line is busy, a confirmation announcement is heard, the customer hangs up and a queuing process begins. For the next 30 minutes, both the calling and called lines are checked periodically for availability to complete the call. If during this queuing process the called line becomes idle, the customer is notified, via a distinctive ring, that the network is ready to place the call. When the customer picks up the telephone handset the call will automatically be placed.

GENERAL EXCHANGE TARIFF

Embarq Florida, Inc.

BY: F. B. Poag  
Director

SECTION A13  
Third Revised Sheet 34  
Cancels Second Revised Sheet 34  
Effective: May 27, 2004

MISCELLANEOUS SERVICE ARRANGEMENTS

F. EXPRESSTOUCH SERVICE (Cont'd)

2. Feature Descriptions (Cont'd)

b. Repeat Dialing (Cont'd)

- 3) Repeat Dialing is available on a flat rate or a usage sensitive basis. Under the usage sensitive basis, the customer will incur an activation charge whether the customer chooses to advance or abandon the call. The provision of this service on a usage sensitive basis is subject to technical limitations and is provided on a where available basis .

c. Call Tracing

- 1) Call Tracing enables the customer to initiate an automatic trace of the last call received. A usage charge will be assessed on a per occasion basis for each successful trace made. A trace is considered successful when the customer is informed by the voice response unit that the Call Tracing has been successfully completed. Certain types of calls, i.e., out of the area long distance, cannot be traced using this feature.
- 2) Upon activation by the customer, the call tracing information (calling and called number, the time the call was received, and the time the trace was activated) is recorded and stored until requested by an authorized law enforcement agency. The information collection process is instantaneous and the customer using this feature will be notified immediately if the trace was successful and will then be instructed to contact the local law enforcement agency if they wish to file a complaint. The customer is not provided the traced number.

GENERAL EXCHANGE TARIFF

Embarq Florida, Inc.

BY: F. B. Poag  
Director

SECTION A13  
Third Revised Sheet 35  
Cancelling Second Revised Sheet 35  
Effective: March 31, 2004

MISCELLANEOUS SERVICE ARRANGEMENTS

F. EXPRESSTOUCH SERVICE (Cont'd)

2. Feature Descriptions (Cont'd)

c. Call Tracing (Cont'd)

- 3) If the customer receives another call prior to activating the trace, or receives a Call Waiting indication during the call to be traced, Call Tracing will not record the correct number.
- 4) In situations where the Call Tracing functionality is initiated by a subscriber, information pertaining to nonpublished numbers will be provided to any authorized law enforcement agency upon request.

d. Selective Call Ring

- 1) Selective Call Ring allows the customer to define up to twelve telephone numbers which, when calling, will ring differently from a regular telephone call.
- 2) The customer creates a screening list through an interactive dialing process for up to twelve telephone numbers. When a call is received from one of the programmed numbers, the customer is alerted with a distinctive ring. Calls from numbers not programmed will ring normally. The numbers on the list may be changed or reprogrammed at any time by the customer.

e. Selective Call Rejection

- 1) Selective Call Rejection allows the customer to create a list of up to twelve numbers which, when calling, will be blocked from ringing the customer's telephone and will be sent to an appropriate recording.

GENERAL EXCHANGE TARIFF

Embarq Florida, Inc.

BY: F. B. Poag  
Director

SECTION A13  
Third Revised Sheet 36  
Cancelling Second Revised Sheet 36  
Effective: May 2, 2001

MISCELLANEOUS SERVICE ARRANGEMENTS

F. EXPRESSTOUCH SERVICE (Cont'd)

2. Feature Descriptions (Cont'd)

e. Selective Call Rejection (Cont'd)

- 2) The feature enables the customer to prevent incoming calls from up to twelve specific telephone numbers by allowing the customer to program twelve telephone numbers into a screening list. When a call is received from a number on the screening list, and if Selective Call Rejection is activated, the call is forwarded to a recording. If Selective Call Rejection is not activated, the call is completed as usual. Numbers may be added or deleted by the customer at any time.

f. Selective Call Forward

- 1) Selective Call Forward allows subscribers to give priority treatment to certain calls by transferring only those calls originating from a subscriber-designated list of telephone numbers. The subscriber may include up to twelve telephone numbers from the ExpressTouch® service area on the Selective Call Forward list. The feature screens incoming calls against the subscriber's list. Calls coming from a number on the subscriber's list are forwarded to another telephone number designated by the subscriber.
- 2) Subscribers activate and deactivate the feature by dialing an access code. Automatic announcements tell subscribers whether the feature is activated or deactivated, what directory numbers are on the screening list, and the forward-to directory number. Subscribers can modify this information in response to prompts from the Company's central office equipment.

g. Selective Call Acceptance

- 1) Selective Call Acceptance screens incoming calls against a list of subscriber-specified directory numbers and accepts only those calls from numbers on the list. Calls from other numbers within the ExpressTouch® service area are denied access to the subscriber's line; callers receive an announcement stating that the called party is not accepting calls at this time. Calls from outside the ExpressTouch® service area will ring normally.
- 2) This feature also controls access to computer lines for security reasons by restricting directory numbers that can terminate to computer lines.
- 3) Subscribers can include up to twelve numbers from within the ExpressTouch® service area on the Selective Call Acceptance list. Subscribers dial an access code to activate or deactivate the feature, determine status of the feature, review the Selective Call Acceptance list, and add or delete numbers from the list.

GENERAL EXCHANGE TARIFF

Embarq Florida, Inc.

BY: F. B. Poag  
Director

SECTION A13  
Second Revised Sheet 37  
Cancelling First Revised Sheet 37  
Effective: May 2, 2001

MISCELLANEOUS SERVICE ARRANGEMENTS

F. EXPRESSTOUCH SERVICE (Cont'd)

3. Regulations and Limitations of Service

a. The following limitations apply:

- 1) ExpressTouch Service is provided subject to the availability of facilities. Additionally, the features described will only operate on calls originating and terminating within the Customer Local Area Signaling Services (CLASS) serving areas.
- 2) The service will not be provided to pay telephone service, toll terminals, PBX trunks, or from some remote switching locations.
- 3) ExpressTouch Service is available to single line residence and business customers, as well as rotary line customers.
- 4) Return Call and Repeat Dialing will be offered on both flat rate and usage basis. Call Tracing is offered on a usage sensitive basis only. The remaining ExpressTouch features are offered on a flat rate basis only.
- 5) ExpressTouch features are eligible to receive Vacation service.
- 6) In no event shall the Company be held liable for any losses or damages arising from the unavailability or failure of its equipment or facilities, or for any act, omission or failure of performance by the Company or its employees or agents in connection with this service.

GENERAL EXCHANGE TARIFF

Embarq Florida, Inc.

BY: F. B. Poag  
Director

SECTION A13  
Sixth Revised Sheet 38  
Cancelling Fifth Revised Sheet 38  
Effective: November 12, 2004

MISCELLANEOUS SERVICE ARRANGEMENTS

F. EXPRESSTOUCH SERVICE (Cont'd)

4. Rates and Charges		Monthly <u>Rate</u>
a.	Return Call	
1)	Flat Rate	
	Residential	\$4.50
	Business	5.00
2)	Usage Sensitive	
	Residential	1.25
	Business	1.25
b.	Repeat Dialing	
1)	Flat Rate	
	Residential	4.50
	Business	5.00
2)	Usage Sensitive	
	Residential	1.25
	Business	1.25



GENERAL EXCHANGE TARIFF

Embarq Florida, Inc.

BY: F. B. Poag  
Director

SECTION A13  
Ninth Revised Sheet 39  
Cancelling Eighth Revised Sheet 39  
Effective: November 12, 2004

MISCELLANEOUS SERVICE ARRANGEMENTS

F. EXPRESSTOUCH SERVICE (Cont'd)

4. Rates and Charges (Cont'd)

c. Call Tracing

a) Call Tracing - Usage Sensitive

Residential	\$9.75
Business	\$9.75

Monthly  
Rate

d. Selective Call Ring

Residential	\$5.00
Business	\$5.00

e. Selective Call Rejection

Residential	\$5.00
Business	\$5.00

f. Selective Call Forward

Residential	\$5.00
Business	\$5.00

g. Selective Call Acceptance

Residential	\$5.00
Business	\$6.00

5. Caller ID

a. General

- 1) This feature enables the customer to view on a display unit the directory number of an incoming telephone call. The display unit may be an ancillary device, which is attached to the customer's telephone set or may be a special telephone set with the display unit built-in.

GENERAL EXCHANGE TARIFF

Embarq Florida, Inc.

BY: F. B. Poag  
Director

SECTION A13  
Second Revision Sheet 40  
Cancelling First Revision Sheet 40  
Effective: April 1, 1997

MISCELLANEOUS SERVICE ARRANGEMENTS

F. EXPRESSTOUCH<sup>SM</sup> SERVICE (Cont'd)

5. Caller ID (Cont'd)

a. General (Cont'd)

- 2) When Caller ID is activated on a customer's line, the number of an incoming call is revealed on the display unit between the first and second ring.
- 3) Any customer subscribing to Caller ID will be responsible for the provision of the display unit which will be located on the customer's premises. The installation, repair and technical capability of that equipment to function in conjunction with the feature specified herein will be the responsibility of the customer. The Company assumes no liability and will be held harmless for any incompatibility of this equipment to perform satisfactorily with the network features described herein.

b. Regulations and Limitations

- 1) Caller ID is provided subject to the availability of Company facilities. Additionally, the feature will only operate on calls originating and terminating within Custom Local Area Signaling Service (CLASS) equipped offices.
- 2) Caller ID is available to single line residence and business customers. The service will not be provided to pay telephone service, toll terminals, PBX trunks or from some remote switching locations.

GENERAL EXCHANGE TARIFF

Embarq Florida, Inc.

By: F. B. Poag  
Director

SECTION A13  
Second Revised Sheet 41  
Cancelling First Revised Sheet 41  
Effective: July 13, 1997

MISCELLANEOUS SERVICE ARRANGEMENTS

F. EXPRESSTOUCH SERVICE (Cont'd)

5. Caller ID (Cont'd)

b. Regulations and Limitations (Cont'd)

- 3) RESERVED FOR FUTURE USE
- 4) Caller ID is not eligible for vacation Service unless the main service associated with Caller ID is also on Vacation Service.
- 5) In no event shall the Company be held liable for any losses or damages arising from the unavailability or failure of its equipment or facilities, or for any act, omission or failure of performance by the Company or its employees or agents in connection with this service.
- 6) If an incoming call is from a caller utilizing a PBX trunk or a rotary line group, the telephone number displayed may be the main number of that PBX or rotary group rather than the directory number accessed by the caller.
- 7) The Company will deliver all numbers, subject to the technical limitations defined in this tariff, including telephone numbers associated with Non-Published Listing service as described in Section A6 of this tariff.

GENERAL EXCHANGE TARIFF

Embarq Florida, Inc.

By: F. B. Poag  
Director

SECTION A13  
Sixth Revised Sheet 42  
Cancelling Fifth Revised Sheet 42  
Effective: October 24, 2003

MISCELLANEOUS SERVICE ARRANGEMENTS

F. EXPRESSTOUCH SERVICE (Cont'd)

5. Caller ID (Cont'd)

b. Regulations and Limitations (Cont'd)

- 8) Telephone numbers transmitted via Caller ID are intended solely for the use of the Caller ID subscriber. Resale of this information is prohibited by this tariff.
- 9) Calling Numbers will not be displayed on operator-handled calls or calls from access lines where Calling Number Delivery Blocking has been activated.

c. Rates and Charges

	Monthly <u>Rate</u>
Caller ID	
Residential	\$ 9.50
Business	10.50

GENERAL EXCHANGE TARIFF

Embarq Florida, Inc.

By: F. B. Poag  
Director

SECTION A13  
First Revised Sheet 43  
Cancelling Original Sheet 43  
Effective: January 1, 1997

MISCELLANEOUS SERVICE ARRANGEMENTS

F. EXPRESSTOUCH SERVICE (Cont'd)

6. Caller ID with Name

a. General

- 1) This feature enables the customer to view on a display unit the directory name and telephone number of an incoming telephone call. The display unit may be an ancillary device which is attached to the customer's telephone set or may be a special telephone set with the display unit built-in.
- 2) When Caller ID With Name is activated on a customer's line, the name and telephone number of an incoming call is revealed on the display unit between the first and second ring.
- 3) Any customer subscribing to Caller ID With Name will be responsible for the provision of the display unit which will be located on the customer's premises. The installation, repair and technical capability of that equipment to function in conjunction with the feature specified herein will be the responsibility of the customer. The Company assumes no liability and will be held harmless for any incompatibility of this equipment to perform satisfactorily with the network feature described herein.

GENERAL EXCHANGE TARIFF

Embarq Florida, Inc.

By: F. B. Poag  
Director

SECTION A13  
Fourth Revised Sheet 44  
Cancelling Third Revised Sheet 44  
Effective: December 29, 2003

MISCELLANEOUS SERVICE ARRANGEMENTS

F. EXPRESSTOUCH SERVICE (Cont'd)

6. Caller ID with Name (Cont'd)

b. Regulations and Limitations

- 1) This service is provided subject to the availability of Company facilities. Additionally, the feature described will only operate on calls originating and terminating with Custom Local Area Signaling Service (CLASS) offices equipped for Caller ID With Name service. Caller ID with Name will be provided on Inter- and IntraLATA calls on a where technically available basis.
- 2) Caller ID With Name is available to single line residence and business customers. The service will not be provided to pay telephone service, toll terminals, PBX trunks or from some remote switching locations.
- 3) Caller ID With Name is not eligible for Vacation Service unless the main service associated with Caller ID is also on Vacation Service.
- 4) In no event shall the Company be held liable for any losses or damages arising from the unavailability or failure of its equipment or facilities, or for any omission or failure of performance by the Company or its employees or agents connection

GENERAL EXCHANGE TARIFF

Embarq Florida, Inc.

By: F. B. Poag  
Director

SECTION A13  
Second Revised Sheet 45  
Cancelling First Revised Sheet 45  
Effective: December 29, 2003

MISCELLANEOUS SERVICE ARRANGEMENTS

F. EXPRESSTOUCH SERVICE (Cont'd)

6. Caller ID with Name (Cont'd)

b. Regulations and Limitations (Cont'd)

- 7) If an incoming call is from a caller utilizing a PBX trunk or a rotary line group, the telephone name and number-displayed may be the name listed in the Company's records and main number of that PBX or rotary group rather than the directory name and number accessed by the caller.
- 8) The Company will deliver all names and numbers, subject to the technical limitations defined in this tariff, including telephone names and numbers associated with Non-Published Listing service as described in Section A6 of this tariff.
- 9) Telephone names and numbers transmitted via Caller ID With name are intended solely for the use of the Caller ID With Name subscriber. Resale of this information is prohibited by this tariff.
- 10) Calling Names and Numbers will not be displayed on operator-handled calls or calls from access lines where Calling Number Delivery Blocking has been activated.

GENERAL EXCHANGE TARIFF

Embarq Florida, Inc.

SECTION A13

By: F. B. Poag  
Director

Fifth Revised Sheet 46  
Cancelling Fourth Revised Sheet 46  
Effective: October 24, 2003

MISCELLANEOUS SERVICE ARRANGEMENTS

F. EXPRESSTOUCH SERVICE (Cont'd)

6. Caller ID with Name (Cont'd)

c. Rates and Charges

Caller ID With Name	Monthly <u>Rate</u>
Residential	\$ 9.50
Business	10.50

7. Anonymous Call Rejection (ACR)

- a. This feature allows customers to automatically reject incoming calls when the call originates from a telephone number which has invoked a blocking feature that prevents the delivery of their number to the called party. When ACR is activated on the customer's line and an incoming call marked private is received, the called party's telephone will not ring. The call will be routed to an announcement and subsequently terminated. The announcement informs the calling party that the person he/she is trying to reach will not accept the call as long as the calling number is not delivered. Incoming calls are checked for acceptance or rejection by ACR regardless of the current state of the ACR customer's line (i.e., off-hook or idle).
- b. This service will be offered where technically available.



GENERAL EXCHANGE TARIFF

Embarq Florida, Inc.

By: F. B. Poag  
Director

SECTION A13  
Second Revised Sheet 47  
Cancelling First Revised Sheet 47  
Effective: July 13, 1997

MISCELLANEOUS SERVICE ARRANGEMENTS

F. EXPRESSTOUCH SERVICE (Cont'd)

7. Anonymous Call Rejection (Cont'd)

c. Rates and Charges

	<u>Monthly Rate</u>
1) Per Line	\$4.00
2) A service order is required to establish or discontinue ACR. Subsequent to establishment, the feature can be activated and deactivated at the customer's discretion through the use of preassigned feature access codes.	

8. ExpressTouch Blocking Services

a. Calling Number Delivery Blocking

- 1) Calling Number Delivery Blocking (CNDB) enables the subscriber to block transmission of his/her telephone number on outgoing calls to subscribers of Caller ID and/or Caller ID With name. The subscriber must activate the feature on a per-call basis by entering a three-digit code before dialing the caller number.
- 2) Per line blocking of Caller ID and/or Caller ID With Name is available upon request to the following entities only:
  - a) private, non-profit, tax-exempt, domestic violence intervention agencies

GENERAL EXCHANGE TARIFF

Embarq Florida, Inc.

By: F. B. Poag  
Director

SECTION A13  
Second Revised Sheet 48  
Cancelling First Revised Sheet 48  
Effective: May 29, 1997

MISCELLANEOUS SERVICE ARRANGEMENTS

F. EXPRESSTOUCH<sup>SM</sup> SERVICE (Cont'd)

8. ExpressTouch Blocking Services (Cont'd)

a. Calling Number Delivery Blocking (Cont'd)

2) (Cont'd)

b) federal, state and local law enforcement agencies

c) employees of the agencies in a) and b) previous

Per line blocking is in operation on a continuous basis and can only be deactivated by entering a three-digit code before dialing the called number. The feature is applicable to all outgoing calls placed from the customer's line. This service is available to the listed agencies only. Individuals employed by the agencies are also eligible for per line blocking of their residential access lines, where available.

3) CNDB is available only as specified in 6.b.1) preceding.

4) The Company's limits of liability are described in Section A2 of this tariff.

5) No monthly recurring rates or usage charges apply to the provision of this service. Service order charges are not applicable.

GENERAL EXCHANGE TARIFF

Embarq Florida, Inc.

By: F. B. Poag  
Director

SECTION A13  
First Revised Sheet 49  
Cancelling Original Sheet 49  
Effective: January 1, 1997

MISCELLANEOUS SERVICE ARRANGEMENTS

F. EXPRESSTOUCH SERVICE (Cont'd)

8. ExpressTouch Blocking Services (Cont'd)

b. Call Tracing Denial

- 1) The Call Tracing Denial feature enables the subscriber to block the initiation of the Call Tracing feature.
- 2) The customer must request that the Call Tracing Denial feature be installed on his/her line(s), as Call Tracing is inherent to the Company's network. The feature will then be in operation on a continuous basis and will not be able to be deactivated by the subscriber. If subscribers wish to utilize the Call Tracing feature, they must again contact the Company to remove the Call Tracing Denial feature from their line(s).
- 3) This feature is available only as specified in 3.a.1) preceding.
- 4) The Company's limits of liability are described in Section A2 of this tariff.
- 5) No monthly recurring rates or usage charge applies to the provision of this service. Service order charges are not applicable.

GENERAL EXCHANGE TARIFF

Embarq Florida, Inc.

BY: F.B. Poag  
Director

SECTION A13  
Sixth Revised Sheet 50  
Cancelling Fifth Revised Sheet 50  
Effective: August 1, 2005

MISCELLANEOUS SERVICE ARRANGEMENTS

G. CUSTOM CALLING FEATURE PACKAGES

1. General

- a. Custom Calling Feature Packages combine certain custom calling and ExpressTouch feature options into packages at rates which provide a monthly savings over the rates that would apply if the features were purchased individually.
- b. The packaged features are offered individually in Sections A13 E. and F. of this tariff. All descriptions, rules and regulations specified in those sections apply to these packages also.
- c. All packages will be offered on a where available basis.
- d. Individual features may not be available in all service areas. Therefore, package content may vary according to the technical availability of certain features. While package content may vary, the package pricing will remain the same. As the switches are upgraded and the features become available, they will be added to the packages.

2. Package Descriptions:

- a. Package 1 includes:
  - Enhanced Call Waiting
  - Three-Way Calling
  - Call Forwarding
  - Call Forward Busy-Fixed
  - Call Forward No Answer-Fixed
- b. Package 2 includes:
  - Enhanced Call Waiting
  - Three-Way Calling
  - Return Call
  - Call Forward Busy-Fixed
  - Call Forward No Answer-Fixed

GENERAL EXCHANGE TARIFF

Embarq Florida, Inc.

BY: F.B. Poag  
Director

SECTION A13  
Fifth Revised Sheet 51  
Cancelling Fourth Revised Sheet 51  
Effective: August 1, 2005

MISCELLANEOUS SERVICE ARRANGEMENTS

G. CUSTOM CALLING FEATURE PACKAGES (Cont'd)

2. Package Descriptions: (Cont'd)

c. Package 3 includes:

Enhanced Call Waiting  
Three-Way Calling  
Return Call  
Repeat Dialing  
Call Forwarding  
Call Forward Busy-Fixed  
Call Forward No Answer-Fixed

d. Package 5 includes:

Enhanced Call Waiting  
Three-Way Calling  
Return Call  
Repeat Dialing  
Call Forwarding  
Selective Call Rejection  
Caller ID With Name(including Anonymous Call Rejection)\*  
Call Waiting ID\*  
Call Forward Busy-Fixed  
Call Forward No Answer-Fixed

\* These features provided on a "where available" basis as a part of these packages.

GENERAL EXCHANGE TARIFF

Embarq Florida, Inc.

By: F. B. Poag  
Director

SECTION A13  
Seventh Revised Sheet 52  
Cancelling Sixth Revised Sheet 52  
Effective: February 16, 2006

MISCELLANEOUS SERVICE ARRANGEMENTS

G. CUSTOM CALLING FEATURE PACKAGES (Cont'd)

2. Package Descriptions (Cont'd)

e. Package 8 includes:

Three-Way Calling  
Return Call  
Call Forwarding  
Caller ID With Name (including Anonymous Call Rejection)\*  
Call Forward-Busy-Fixed  
Call Forward No Answer-Fixed

f. Package 9 includes:

Call Forwarding  
Call Forward Busy-Fixed  
Call Forward No Answer-Fixed  
Enhanced Call Waiting  
Caller ID with Name (including Anonymous Call Rejection)\*

\* These features provided on a "where available" basis as a part of these packages.

GENERAL EXCHANGE TARIFF

Embarq Florida, Inc.

By: F. B. Poag  
Director

SECTION A13  
Third Revised Sheet 52.1  
Cancelling Second Revised Sheet 52.1  
Effective: August 1, 2005

MISCELLANEOUS SERVICE ARRANGEMENTS

G. CUSTOM CALLING FEATURE PACKAGES (Cont'd)

RESERVED FOR FUTURE USE

GENERAL EXCHANGE TARIFF

Embarq Florida, Inc.

By: F. B. Poag  
Director

SECTION A13  
Fourteenth Revised Sheet 53  
Cancelling Thirteenth Revised Sheet 53  
Effective: February 16, 2006

MISCELLANEOUS SERVICE ARRANGEMENTS

G. CUSTOM CALLING FEATURE PACKAGES (Cont'd)

3. Rates and Charges

Feature, per month	<u>Residential</u>	<u>Business</u>
Package 1	\$11.00	\$11.00
Package 2	13.00	12.00
Package 3	14.00	14.00
Package 5	20.00	19.00
Package 8	18.00	17.00
Package 9	N/A	14.00

H. SIGNALRING

1. General

- a. SignalRing service will enable a subscriber to have up to three telephone numbers associated with a single access line. Subscribers to this service will be able to receive calls dialed to two or three separate telephone numbers without having a second or third line.
- b. A distinctive ringing pattern will be provided for each of the additional telephone numbers to facilitate identification of incoming calls.



GENERAL EXCHANGE TARIFF

Embarq Florida, Inc.

SECTION A13

By: F. B. Poag  
Director

Third Revised Sheet 54  
Cancelling Second Revised Sheet 54  
Effective: May 29, 1997

MISCELLANEOUS SERVICE ARRANGEMENTS

H. SIGNALRING (Cont'd)

1. General (Cont'd)

- c. A distinctive call waiting tone for each additional telephone number will also be provided to customers subscribing to Call Waiting service where facilities permit. Only one Call Waiting feature is required for the service to work on all SignalRing numbers assigned to the customer.
- d. Subscribers to SignalRing may select the service in one of two arrangements. SignalRing I consists of one additional telephone number associated with a single access line. SignalRing II consists of two additional telephone numbers associated with a single access line.

2. Regulations

- a. This service is available to individual line residence and business customers only in areas equipped with digital switches that are provisioned with the software necessary to provide SignalRing.
- b. SignalRing service is not offered in conjunction with Centrex service, PBX trunk service, pay telephone service, lines equipped with rotary or hunting arrangements, foreign exchange or foreign central office service, or with access lines terminating in customer premises switching or key equipment. SignalRing service may not be compatible with all types of customer provided telephone equipment.

GENERAL EXCHANGE TARIFF

Embarq Florida, Inc.

By: F. B. Poag  
Director

SECTION A13  
First Revised Sheet 55  
Cancelling Original Sheet 55  
Effective: January 1, 1997

MISCELLANEOUS SERVICE ARRANGEMENTS

H. SIGNALRING (Cont'd)

2. Regulations (Cont'd)

- c. SignalRing is provided subject to the availability of facilities. Additionally, SignalRing II service may not be available in all central offices equipped to provide SignalRing I service.
- d. SignalRing subscribers will be entitled to one listing with each SignalRing number at no additional charge. Listings for SignalRing are subject to regulations specified in Section A6 for Directory Listings. Other listings may also be provided under the terms, rates and conditions described in Section A6 of this tariff.
- e. All telephone numbers associated with a line equipped with SignalRing must originate from the same central office switching machine.
- f. When establishing SignalRing service, customers who also subscribe to Call Forwarding service must choose one of the following options.
  - 1) All telephone numbers associated with the line will be forwarded to a single number when Call Forwarding service is activated. Only one Call Forwarding feature is required for the service to work on all SignalRing numbers assigned to the customer.
  - 2) The main telephone number will only be forwarded when Call Forwarding service is activated. The additional SignalRing service numbers will continue to ring and may be answered at the subscriber's premises.

GENERAL EXCHANGE TARIFF

Embarq Florida, Inc.

BY: F. B. Poag  
Director

SECTION A13  
Eighth Revised Sheet 56  
Cancelling Seventh Revised Sheet 56  
Effective: October 24, 2003

MISCELLANEOUS SERVICE ARRANGEMENTS

H. SIGNALRING (Cont'd)

3. Rates and Charges

<u>Monthly Rate Per Line</u>	<u>Residential</u>	<u>Business</u>
SignalRing I	\$4.50	\$7.00
SignalRing II	5.50	9.00

I. REMOTE CALL FORWARDING (RCF)

1. General

- a. Remote Call Forwarding (RCF) is a service whereby a call placed from an originating number (Calling Party) to a customer's Remote Call Forwarding (RCF customer) telephone number (the call forwarding location) is automatically forwarded by Company central office equipment to another telephone number (the terminating number) designated by the RCF customer.

2. Regulations

- a. RCF service is offered only from suitably equipped central offices and is subject to the availability of facilities.
- b. Each RCF service allows for forwarding one call at a given time. A subsequent RCF service or path is necessary for each additional call to be forwarded simultaneously.
- c. RCF service will be provided on the condition that the customer subscribes to sufficient facilities to adequately handle calls without interfering with or impairing any services offered by the Company.
- d. When the RCF number is to be located in a multi-office exchange, the Company will determine the serving office.
- e. Customers are prohibited from using Remote Call Forwarding for the purpose of bypassing toll service (e.g. Long Distance Message Telecommunications Service and/or Extended Calling Service (ECS) Routes).
- f. Transmission characteristics may vary depending on the distance and routing necessary to complete the forwarded call.
- g. RCF service is not represented as suitable for satisfactory transmission of data.
- h. RCF service is not offered when the terminating number for a forwarded call is a Pay Telephone access line service.

GENERAL EXCHANGE TARIFF

Embarq Florida, Inc.

By: F. B. Poag  
Director

SECTION A13  
Third Revised Sheet 57  
Cancelling Second Revised Sheet 57  
Effective: March 15, 2002

MISCELLANEOUS SERVICE ARRANGEMENTS

I. REMOTE CALL FORWARDING (RCF) (Cont'd)

2. Regulations (Cont'd)

- i. The Company will not provide identification of the originating telephone number to the RCF customer.
- j. One listing in the alphabetical section of the Directory covering the exchange in which the RCF central office is located is provided without additional charge. Additional listings as shown in Section A6 may be subscribed to.
- k. Neither RCF nor Call Forwarding will be available as a feature on the RCF terminating number.
- l. If the use of RCF Service is primarily or substantially of business, professional, institutional, or otherwise occupational nature, i.e., nonresidential, or if the listing used is such as to indicate nonresidential use, then calls will not be forwarded to any telephone number for which residential rates apply.
- m. RCF Service may not be used, switched, or otherwise connected through a Cellular Mobile Carrier's RCF Service for the provision of through calling from a landline telephone to another landline telephone.
- n. RCF is not eligible for Vacation Service.
- o. The minimum contract period for this service is one month.

GENERAL EXCHANGE TARIFF

Embarq Florida, Inc.

By: F. B. Poag  
Director

SECTION A13  
Fourth Revised Sheet 58  
Cancelling Third Revised Sheet 58  
Effective: November 12, 2004

MISCELLANEOUS SERVICE ARRANGEMENTS

I. REMOTE CALL FORWARDING (RCF) (Cont'd)

3. Rates and Charges

- a. The subscriber to RCF is responsible for all applicable local and long distance charges between the RCF central office and the terminating number.
  - 1) Appropriate long distance message detail will be provided to the subscriber for toll calls from the RCF central office to the terminating telephone number.
  - 2) Message detail is not provided for local calls when RCF is used on a local basis.
- b. The calling party will be responsible for any applicable local or long distance charges from the originating number to the RCF telephone number that is being called.
- c. The following monthly rates for RCF allows for forwarding one call at a given time. An additional RCF path is required for each additional call to be forwarded simultaneously.

<u>Remote Call Forwarding</u>	<u>Monthly Rate</u>
Per initial call path	\$21.50
Per additional call path	\$21.50

- d. The following measured rate is in addition to the monthly rate when the central office which forwards the calls and the terminating number are in the same local calling area. Calls terminating to a number outside the local calling area will be billed the monthly rate plus the applicable toll rate.
  - 1) Measured rates – UNITED ONLY  
Per minute of use \$ .03
- e. Service charges as shown in Section A4 of this tariff apply as follows:
  - 1) For the initial or subsequent installation of RCF a Primary Service Order Charge shall apply.
  - 2) To change the number at the RCF location, the number for the terminating location or both numbers on the same order, a Secondary Service Order Charge shall apply.

GENERAL EXCHANGE TARIFF

Embarq Florida, Inc.

By: F. B. Poag  
Director

SECTION A13  
Fifth Revised Sheet 59  
Cancelling Fourth Revised Sheet 59  
Effective: March 15, 2002

MISCELLANEOUS SERVICE ARRANGEMENTS

RESERVED FOR FUTURE USE

GENERAL EXCHANGE TARIFF

Embarq Florida, Inc.

By: F. B. Poag  
Director

SECTION A13  
Second Revised Sheet 60  
Cancelling First Revised Sheet 60  
Effective: March 15, 2002

MISCELLANEOUS SERVICE ARRANGEMENTS

RESERVED FOR FUTURE USE

GENERAL EXCHANGE TARIFF

Embarq Florida, Inc.

By: F. B. Poag  
Director

SECTION A13  
Fourth Revised Sheet 61  
Cancelling Third Revised Sheet 61  
Effective: March 15, 2002

MISCELLANEOUS SERVICE ARRANGEMENTS

RESERVED FOR FUTURE USE



GENERAL EXCHANGE TARIFF

Embarq Florida, Inc.

By: F. B. Poag  
Director

SECTION A13  
Third Revised Sheet 62  
Cancelling Second Revised Sheet 62  
Effective: April 9, 1999

MISCELLANEOUS SERVICE ARRANGEMENTS

K. SPECIAL BILLING/REPORTING SERVICES

1. Special Billing Service

a. General

- 1) A special billing numbering plan may be furnished customers in order to associate originating long distance calls with specific stations, departments, projects, etc., at the rates specified below.
- 2) Persons or firms utilizing this service must subscribe to our Local Exchange Service as a prerequisite for the issuance of a special billing number.

GENERAL EXCHANGE TARIFF

Embarq Florida, Inc.

By: F. B. Poag  
Director

SECTION A13  
First Revised Sheet 63  
Cancelling Original Sheet 63  
Effective: January 1, 1997

MISCELLANEOUS SERVICE ARRANGEMENTS

K. SPECIAL BILLING/REPORTING SERVICES (Cont'd)

I. Special Billing Service (Cont'd)

b. Rates and Charges

1) United Telephone Exchanges Only

Monthly Rate

Special Billing number, each

\$ 3.05

2) Central Telephone exchanges only

Monthly Rate

(a) Each group of 20 telephone stations or special billing numbering codes (whichever is the greater), or fraction thereof, minimum.

\$ 25.00

(b) Each group of 20 telephone stations or special billing numbering codes or fraction thereof in addition to first group of 20 numbers.

3.00

GENERAL EXCHANGE TARIFF

Embarq Florida, Inc.

By: F. B. Poag  
Director

SECTION A13  
First Revised Sheet 64  
Cancelling Original Sheet 64  
Effective: January 1, 1997

MISCELLANEOUS SERVICE ARRANGEMENTS

K. SPECIAL BILLING/REPORTING SERVICES (Cont'd)

2. Magnetic Tape Toll Billing

a. General

- 1) Magnetic tape billing of current long distance message charges billed the subscriber by the Company will be furnished upon request on the following basis:
  - a) The magnetic tape will be prepared in the format normally used by the Company.
  - b) No attempt will be made by the Company to sort long distance messages into preferred classifications or groups.
  - c) A minimum of two weeks notice must be provided the Company prior to the subscriber's billing date.
- 2) The customer may furnish the blank magnetic tape or the Company will furnish the tape at the rates listed in K.2.b.

GENERAL EXCHANGE TARIFF

Embarq Florida, Inc.

By: F. B. Poag  
Director

SECTION A13  
First Revised Sheet 65  
Cancelling Original Sheet 65  
Effective: January 1, 1997

MISCELLANEOUS SERVICE ARRANGEMENTS

K. SPECIAL BILLING/REPORTING SERVICES (Cont'd)

2. Magnetic Tape Toll Billing (Cont'd)

b. Rates and Charges

1) United Telephone exchanges only

Magnetic tape preparations, per Access Line, per occasion	\$55.00
---	---------

Call detail listing, per each call listed	.001
---	------

Blank magnetic tape, per tape	15.95
-------------------------------	-------

2) Central Telephone exchanges only

Monthly Rate

(a) Local service and equipment records	\$40.00
---	---------

(b) Other charge and credit records	40.00
-------------------------------------	-------

(c) Long distance message records	40.00
-----------------------------------	-------

3. SUNCOM (CCSA) Message Tape for Florida State University, Tallahassee, Florida (Central Telephone exchanges only)

	<u>Nonrecurring Charges</u>	<u>Monthly Rate</u>
Message tape will \$2,000.00 provide a 100% sample of SUNCOM messages originating from the Florida State University 644 NXX	\$ 635.00	

GENERAL EXCHANGE TARIFF

Embarq Florida, Inc.

By: F. B. Poag  
Director

SECTION A13  
Fourth Revised Sheet 66  
Cancelling Third Revised Sheet 66  
Effective: December 3, 1997

MISCELLANEOUS SERVICE ARRANGEMENTS

K. SPECIAL BILLING/REPORTING SERVICES (Cont'd)

4. Duplicate Bill Charges

a. General

- 1) A Duplicate Bill Charge is applicable whenever a subscriber, or authorized agent of the subscriber, requests duplicate copies of the telephone bill except as provided in 2) following. The Duplicate Bill Charge is not eligible for employee concession.
- 2) A Duplicate Bill Charge is not applicable when:
  - a) customers programmatically receive additional copies with each billing,
  - b) customers request a copy due to non-receipt of the original bill following service establishment or transfer of service,
  - c) the billing address is found to be incorrect,
  - d) customers request a copy of a toll credit limit bill or a final bill, or
  - e) the request is for a copy of the current month's bill.

b. Charges per copy of bill requested

	Residence	Business
1) Previous month-six months	\$4.00	\$5.30
2) 7 months or older	4.90	6.20

GENERAL EXCHANGE TARIFF

Embarq Florida, Inc.

BY: F. B. Poag  
Director

SECTION A13  
First Revised Sheet 66.1  
Cancelling Original Sheet 66.1  
Effective: November 4, 1997

MISCELLANEOUS SERVICE ARRANGEMENTS

K. SPECIAL BILLING/REPORTING SERVICES (Cont'd)

5. Billing Breakdown Charge

a. General

- 1) A Billing Breakdown describes the products and services being charged on the local monthly bill. The breakdown reflects the customer billing name, telephone number and address. It provides the local service offering name and description of the product or service, including the quantity and rate of the product or service.
- 2) A Billing Breakdown Charge is applicable whenever a subscriber, or authorized agent of the subscriber, requests a breakdown of the billing record.
- 3) The Billing Breakdown will be provided only to the customer of record, regardless of whether the request is received from the actual subscriber or an authorized agent of the subscriber.
- 4) The Billing Breakdown Charge will be applied per billing number.
- 5) The Billing Breakdown Charge is not eligible for employee concession.

Business

b. Charge per Billing Number \$ 5.00

GENERAL EXCHANGE TARIFF

Embarq Florida, Inc.

By: F. B. Poag  
Director

SECTION A13  
Third Revised Sheet 67  
Cancelling Second Revised Sheet 67  
Effective: November 4, 1997

MISCELLANEOUS SERVICE ARRANGEMENTS

L. CALL SCREENING SERVICES

1. Residence and Business Operator Screening - United Telephone Exchanges Only
  - a. Operator screening enables a single line residence customer, business customer, or PATS provider subscribing to the flat rate option, by means of telephone company operator identification, to restrict outgoing telephone calls from station users to only those calls which are placed as credit card, third party billed or collect to the called telephone. This applies to all 0+ and 0- calls as specified following. Operator Screening for PBX trunks is located in Section A11 of this tariff.
  - b. All calls to Company numbers such as Repair Service, Directory Assistance and Public Emergency Service numbers (911) will be permitted from the originating station unless the customer also subscribes to specific Custom Code Restrictions.
  - c. Operator Screening is limited to those areas served by central offices arranged for this service and is subject to the availability of facilities at rates following.

GENERAL EXCHANGE TARIFF

Embarq Florida, Inc.

By: F. B. Poag  
Director

SECTION A13  
Third Revised Sheet 68  
Cancelling Second Revised Sheet 68  
Effective: September 3, 1997

MISCELLANEOUS SERVICE ARRANGEMENTS

L. CALL SCREENING SERVICES (Cont'd)

1. Residence and Business Operator Screening -  
United Telephone Exchanges Only (Cont'd)

d. Operator Screening is provided for intraLATA calling through Company operators. Screening for interLATA calling is the responsibility of the interLATA carriers who choose to acknowledge the network screening signals passed to them.

e. The Company will not be responsible for screening calls placed by the caller which are not routed through a Company operator. Calls routed through Alternate Operator Services cannot be screened by the Company.

f. Rates and Charges

1) Operator Screening, per line, per month \$4.00

2) Service Ordering Charges in Section A4 are also applicable.

2. Billed Number Screening - United Telephone Exchanges Only

a. General

1) Billed Number Screening is a service which, through Operator Screening, prevents third number and collect calls from being billed to a telephone line.

2) Billed Number Screening is available to all classes of residence and single line business services, and PATS providers subscribing to the flat rate option, which utilize the public switched network for long distance calling.



GENERAL EXCHANGE TARIFF

Embarq Florida, Inc.

BY: F. B. Poag  
Director

SECTION A13  
Eighth Revised Sheet 69  
Cancelling Seventh Revised Sheet 69  
Effective: October 24, 2003

MISCELLANEOUS SERVICE ARRANGEMENTS

L. CALL SCREENING SERVICES (Cont'd)

2. Billed Number Screening - United Telephone Exchanges Only (Cont'd)

a. General (Cont'd)

- 3) Operator screening of collect, third number, and international collect calls cannot be guaranteed; therefore, charges for any such calls will be the responsibility of the customer.
- 4) Billed Number Screening for Cellular Carriers, PATS providers and PBX trunks can be found in Sections A25, A7 and A16 respectively.

b. Rates and Charges

	<u>Monthly Rate</u>
Billed Number Screening, per line - Residence	\$3.50
Billed Number Screening, per line - Business	\$2.50

3. Billed Number Screening - Central Telephone Exchanges Only

a. General

- 1) Billed Number Screening (BNS) is a service offering providing for the automatic blocking of third number billing or collect billing to a customer's access line.
- 2) Where an NXX exclusively serves a particular subscriber and there is a need to screen all numbers in the NXX, charges as shown in A13.L.3.b.3) of this section will apply.

GENERAL EXCHANGE TARIFF

Embarq Florida, Inc.

By: F. B. Poag  
Director

SECTION A13  
Second Revised Sheet 70  
Cancelling First Revised Sheet 70  
Effective: May 29, 1997

MISCELLANEOUS SERVICE ARRANGEMENTS

L. CALL SCREENING SERVICES (Cont'd)

3. Billed Number Screening - Central Telephone Exchanges Only (Cont'd)

a. General (Cont'd)

- 3) Where a customer subscribes to a block of numbers associated with DID or similar type service, and those numbers are in consecutive order, BNS options may be applied per consecutive number block screened at the rates shown in A13.L.3.b.4).
- 4) Special equipment serving the originating caller's location is necessary to make this feature operable. The Company does not guarantee all third number or collect calls will be screened. The customer is responsible for charges made from locations where such special equipment is not installed.

b. Rates and Charges

- 1) Service charges as shown in Section A4 of this tariff apply as follows:
  - a) For the initial installation of BNS when ordered with a new access line, regular service charges apply.
  - b) When BNS is added to an existing access line, only a secondary service ordering charge shall apply.

GENERAL EXCHANGE TARIFF

Embarq Florida, Inc.

BY: F. B. Poag  
Director

SECTION A13  
Eighth Revised Sheet 71  
Cancelling Seventh Revised Sheet 71  
Effective: October 24, 2003

MISCELLANEOUS SERVICE ARRANGEMENTS

L. CALL SCREENING SERVICES (Cont'd)

3. Billed Number Screening - Central Telephone Exchanges Only (Cont'd)

b. Rates and Charges (Cont'd)

2) Monthly Charges for BNS per line screened:

		<u>Monthly Rate</u>	
		<u>Residence</u>	<u>Business</u>
a)	Option A - No third number or collect billing per line screened	\$3.50	\$2.50
b)	Option B - No third number billing, per line screened	2.50	2.50
c)	Option C - No collect billing, per line screened	2.50	2.50

3) Charges for BNS per NXX screened:

		<u>NRC</u>	<u>Monthly Rate</u>
a)	Option A - No third number or collect billing per NXX screened.	\$395.00	\$190.00

GENERAL EXCHANGE TARIFF

Embarq Florida, Inc.

By: F. B. Poag  
Director

SECTION A13  
Second Revised Sheet 72  
Cancelling First Revised Sheet 72  
Effective: May 29, 1997

MISCELLANEOUS SERVICE ARRANGEMENTS

L. CALL SCREENING SERVICES (Cont'd)

3. Billed Number Screening - Central Telephone Exchanges Only (Cont'd)

b. Rates and Charges (Cont'd)

3) Charges for BNS per NXX screened: (Cont'd)

	<u>NRC</u>	<u>Monthly Rate</u>
b) Option B - No third number billing per NXX screened.	395.00	190.00
c) Option C - No collect billing per NXX screened.	395.00	190.00

4) Charges for BNS per Block of Consecutive Numbers Screened

a) Option A - No third number or collect per blocked screened.	39.50	19.00
b) Option B - No third number billing per block screened.	39.50	19.00
c) Option C - No collect billing per block screened.	39.50	19.00

GENERAL EXCHANGE TARIFF

Embarq Florida, Inc.

By: F. B. Poag  
Director

SECTION A13  
First Revised Sheet 73  
Cancelling Original Sheet 73  
Effective: January 1, 1997

MISCELLANEOUS SERVICE ARRANGEMENTS

L. CALL SCREENING SERVICES (Cont'd)

4. Answer Supervision

a. General

- 1) This feature provides the capability of delivering "off hook" supervisory signals from the subscriber's serving central office to a line interface at the customer's premises. These supervisory signals indicate when the called party has answered an incoming call (gone "off hook").
- 2) Answer Supervision is furnished only from central offices arranged to provide this service and is provided subject to the availability of facilities.
- 3) This feature is available to line side terminations only. PATS providers are eligible for this service. It is not available with residence or business lines, digital facilities or to any trunk-sided termination facilities, such as DID or Trunk Side Access facilities.

b. Rates and Charges

	<u>Nonrecurring Charge</u>	<u>Recurring</u>
Answer Supervision, Per line	Secondary Service Order Charge	\$4.00

GENERAL EXCHANGE TARIFF

Embarq Florida, Inc.

By: F. B. Poag  
Director

SECTION A13  
Second Revised Sheet 74  
Cancelling First Revised Sheet 74  
Effective: May 29, 1997

MISCELLANEOUS SERVICE ARRANGEMENTS

M. BLOCKING SERVICES

1. 976/900/N11
  - a. 976/900/N11 Blocking Service will provide a dialing restriction for all 1+900, 976, 1+976 and N11 calls placed from access lines so arranged for the Service.
  - b. 976/900/N11 Blocking Service is available to basic exchange customers with single-party residence service, business service, PATS service and PBX service.
  - c. Calls to 1+900, 976 and 1+976, and N11 from subscribers to this blocking service will be forwarded to a recorded announcement. It will be the responsibility of the subscriber to inform users of his/her services that these type calls cannot be reached for any reason.
  - d. This blocking service is furnished only from central offices which have been arranged to provide the service and it will be subject to the availability of services.
  - e. The Company shall not be liable to any person for damages of any kind or nature arising out of, resulting from, or in connection with the provision of this blocking service.
  - f. Per the Commission's Order No. 25252 in Docket No. 910060-TP, the Company will provide blocking of 976/900 calls at the customer's request at no charge. Blocking of N11 calls will also be provided at no charge.
  - g. When a customer refuses to pay a disputed 976/900/N11 call charge and the Company determines the charge is valid, the Company may implement 976/900/N11 Blocking Service on all the customer's lines at the same location at no charge.

GENERAL EXCHANGE TARIFF

Embarq Florida, Inc.

By: F. B. Poag  
Director

SECTION A13  
Second Revised Sheet 75  
Cancelling First Revised Sheet 75  
Effective: June 23, 1997

MISCELLANEOUS SERVICE ARRANGEMENTS

M. BLOCKING SERVICES (Cont'd)

1. 976/900/N11 (Cont'd)

- h. If a customer with 976/900/N11 Blocking Service requests removal of the blocking, any calls placed to 976, 900 or N11 programs on or after the date of the request will be due and payable by the customer.

2. Custom Code Restrictions (CCR) - United Telephone exchanges

a. General

- 1) Custom Code Restrictions (CCR) will provide a choice of code restriction options for selected outgoing calls. Where available, each option will permit local calls, nonchargeable calls to Company numbers such as repair service, emergency numbers (911), and Toll Free Code (TFC) calling.
- 2) CCR will be available to basic exchange customers with individual line residence, business, PATS or PBX trunks in either flat-rate, message-rate, or measured rate environments.
- 3) Subscribers dialing restricted codes in the CCR Dialing Plan will be sent to an appropriate recorded announcement.

GENERAL EXCHANGE TARIFF

Embarq Florida, Inc.

By: F. B. Poag  
Director

SECTION A13  
Second Revised Sheet 76  
Cancelling First Revised Sheet 76  
Effective: May 29, 1997

MISCELLANEOUS SERVICE ARRANGEMENTS

M. BLOCKING SERVICES (Cont'd)

2. Custom Code Restrictions (CCR) - United Telephone Exchanges Only (Cont'd)

a. General (Cont'd)

- 4) Custom Code Restrictions are furnished only from central offices which have been arranged to provide these services. The services are provided subject to the availability of facilities.
- 5) Customers subscribing to the CCR Service will be responsible for notifying users of their telephone lines that the lines are restricted.
- 6) The Company shall not be liable to any person for damages of any kind or nature arising out of, resulting from, or in connection with the provision of CCR offered herein, including without limitations, the inability of the station user to access the operator for any purpose, including emergencies. The Company also shall not be liable to any person for damages of any kind or nature arising out of, resulting from or in connection with the provision of CCR offered herein; including the inability of the station users to access any of the restricted codes included in the options listed below.
- 7) Customers may not subscribe to Option 2 unless served by a digital central office, located in a county providing 911/E911 service.



GENERAL EXCHANGE TARIFF

Embarq Florida, Inc.

By: F. B. Poag  
Director

SECTION A13  
Second Revised Sheet 77  
Cancelling First Revised Sheet 77  
Effective: April 29, 1997

MISCELLANEOUS SERVICE ARRANGEMENTS

M. BLOCKING SERVICES (Cont'd)

2. Custom Code Restrictions (CCR) - United Telephone Exchanges Only (Cont'd)

b. Custom Code Restriction Options

1) Option 1

1+ (includes all 1+ dialing except TFC in specific areas)  
411

2) Option 2

1+ (includes all 1+ dialing except TFC in specific areas)  
411  
0 (includes all 0+ and 0- dialing)  
IDDD (includes all international 011+ and 01+ dialing)

3) Option 3

IDDD (includes all international 011+ and 01+ dialing)

4) Option 4

1+ (Includes all 1+ dialing except "TFC" in specific areas)  
0-  
IDD (Includes all International 011+ and 01+ dialing)

5) Option 5 (N)

1+ (Includes all 1+ dialing except TFC in specific Areas)  
411  
0 (Includes all 0+ and 0- dialing)  
1DDD (Includes all international 011+ and 01+ dialing)  
Message Rate Service (\$.25 calls)

GENERAL EXCHANGE TARIFF

Embarq Florida, Inc.

By: F. B. Poag  
Director

SECTION A13  
Eighth Revised Sheet 78  
Cancelling Seventh Revised Sheet 78  
Effective: November 12, 2004

MISCELLANEOUS SERVICE ARRANGEMENTS

M. BLOCKING SERVICES (Cont'd)

2. Custom Code Restrictions (CCR) - United Telephone Exchanges Only (Cont'd)

c. Rates and Charges

The following rates and charges are for Custom Code Restrictions only and are in addition to the applicable service charges, monthly rates, and nonrecurring charges for exchange access lines and other service or equipment with which they are associated.

	<u>Nonrecurring Charge</u>	<u>Monthly Rate</u>
1) Option 1		
a) Residence line, each	\$ 6.00	\$ 3.50
b) Business line, each	6.00	4.75
c) PBX trunk, each	6.00	5.25
d) PATS, each	6.00	4.75
2) Option 2		
a) Residence line, each	\$ 12.00	\$ 3.50
b) Business line, each	12.00	4.75
c) PBX trunk, each	12.00	5.25
d) PATS, each	12.00	4.75

GENERAL EXCHANGE TARIFF

Embarq Florida, Inc.

SECTION A13

By: F. B. Poag  
Director

Eighth Revised Sheet 79  
Cancelling Seventh Revised Sheet 79  
Effective: November 12, 2004

MISCELLANEOUS SERVICE ARRANGEMENTS

M. BLOCKING SERVICES (Cont'd)

2. Custom Code Restrictions (CCR) - United Telephone Exchanges Only (Cont'd)

c. Rates and Charges (Cont'd)

	<u>Nonrecurring Charge</u>	<u>Monthly Rate</u>
3) Option 3		
a) Residence line, each	\$ 6.00	\$3.50
b) Business line, each	6.00	4.75
c) PBX trunk, each	6.00	5.25
d) PATS, each	6.00	4.75
4) Option 4		
a) PATS	\$ 9.00	\$4.75
5) Option 5		
a) Residence line, each	\$12.00	\$3.50
b) Business line, each	12.00	4.75
c) PBX trunk, each	12.00	5.25
d) PATS, each	12.00	4.75

3. Restricted Sent Paid Service (RSPS) - Central Telephone exchanges only

a. General

- 1) Restricted Sent Paid Service (RSPS) enables a customer to restrict outgoing toll calls on his/her access line or trunk to calls that are operator assisted and charged to the called number, a third number, or a credit card.
- 2) Depending on the option chosen by a customer, certain direct dial long distance calls (DDD) from an access line with RSPS will be denied.

GENERAL EXCHANGE TARIFF

Embarq Florida, Inc.

By: F. B. Poag  
Director

SECTION A13  
Third Revised Sheet 80  
Cancelling Second Revised Sheet 80  
Effective: November 19, 1997

MISCELLANEOUS SERVICE ARRANGEMENTS

M. BLOCKING SERVICES (Cont'd)

3. Restricted Sent Paid Service (RSPS) - Central Telephone Exchanges Only (Cont'd)

a. General (Cont'd)

- 3) Local calls and calls to Company numbers such as repair service and emergency service numbers such as 911 will be permitted.
- 4) This service is available to customers served by digital central offices where facilities permit.
- 5) Digital Centrex customers may also be provided the service where central office facilities permit. Digital Centrex Network Class-of-Service (NCOS) features established for the Centel Digital Centrex Customer Group will prevail and be used to route appropriate calls to the RSPS trunk group. This feature can only be provided by Digital Centrex Customer Group and all users within that group will have the feature.

b. Rates and Charges

Service Charges as shown in Section A4 of this tariff apply as follows:

- 1) For initial installation of RSPS (Options 1, 2 and 5) when ordered with a new access line, the service charges associated with a new access line shall apply in addition to the nonrecurring charges shown in b) following.

GENERAL EXCHANGE TARIFF

Embarq Florida, Inc.

By: F. B. Poag  
Director

SECTION A13  
Eighth Revised Sheet 81  
Cancelling Seventh Revised Sheet 81  
Effective: November 12, 2004

MISCELLANEOUS SERVICE ARRANGEMENTS

M. BLOCKING SERVICES (Cont'd)

3. Restricted Sent Paid Service (RSPS) - Central Telephone Exchanges Only (Cont'd)

b. Rates and Charges (Cont'd)

2) When RSPS (Option 1, 4 or 5) is added to an existing access line, a service ordering charge shall apply in addition to the nonrecurring charge shown below.

c. Monthly charges for RSPS are in addition to the applicable rates for access lines or trunks, and are applicable to each line or trunk.

	<u>Nonrecurring Charge</u>	<u>Monthly Rate</u>
Option 1		
Restricted Sent Paid Service Per Line/TRK	\$10.00	\$ 4.25
Restricted Codes		
DDD 1+		
1 + 900, 0 + 900		
1 + 555-1212		
1 + NPA-555-1212		
IDDD 011 +		
N11		

GENERAL EXCHANGE TARIFF

Embarq Florida, Inc.

By: F. B. Poag  
Director

SECTION A13  
Eighth Revised Sheet 82  
Cancelling Seventh Revised Sheet 82  
Effective: October 24, 2003

MISCELLANEOUS SERVICE ARRANGEMENTS

M. BLOCKING SERVICES (Cont'd)

3. Restricted Sent Paid Service (RSPS) - Central Telephone Exchanges Only (Cont'd)

c. (Cont'd)

	<u>Nonrecurring Charge</u>	<u>Monthly Rate</u>
Option 2 <sup>1</sup> Restricted Sent Paid Service Per Line/TRK		
Restricted Codes  1 + 900, 0 + 900, N11		
Option 3 Restricted Codes For Centel Digital Centrex Users Per Line/TRK by NCOS design Per Customer Group	\$10.00	\$ 2.25
Option 4 DDD 1+ 1 + 900, 0 + 900 1 + 555 - 1212 1 + NPA - 555 - 1212 IDDD 011 + N11 Message Rate Service (\$ .20 and \$ .25 calls)	\$10.00	\$ 2.25
Option 5 Restricted Sent Paid Service Per Line/TRK Restricted Codes DDD 1+ 1 + 900, 0 + 900 1 + 555 - 1212 1 + NPA-555-1212 IDDD 011 + N11 411 Message Rate Service (\$ .20 and \$ .25 calls)	\$10.00	\$3.50

Note 1: Service charges are not applicable.

GENERAL EXCHANGE TARIFF

Embarq Florida, Inc.

By: F. B. Poag  
Director

SECTION A13  
Second Revised Sheet 83  
Cancelling First Revised Sheet 83  
Effective: May 29, 1997

MISCELLANEOUS SERVICE ARRANGEMENTS

M. BLOCKING SERVICES (Cont'd)

3. Restricted Sent Paid Service (RSPS) - Central Telephone Exchanges Only (Cont'd)

d. RSPS Charges for NXX Screening Per NXX

	<u>Nonrecurring Charge</u>	<u>Monthly Rate</u>
Option 1	\$395.00	\$190.00
Restricted Codes		
DDD 1+		
1 + 900, 0 + 900		
1 + 555-1212		
1 + NPA-555-1212		
IDDD 011 +		
N11		
Option 2 <sup>1</sup>		
Restricted Codes		
1 + 900, 0 + 900, N11		
Option 3	\$ 39.50	\$ 19.00
Restricted Codes		
For Digital Centrex Users (Central Telephone Areas)		
By NCOS Design		
Per Customer Group		

Note 1: Service Charges are not applicable

GENERAL EXCHANGE TARIFF

Embarq Florida, Inc.

By: F. B. Poag  
Director

SECTION A13  
Second Revised Sheet 84  
Cancelling First Revised Sheet 84  
Effective: May 29, 1997

MISCELLANEOUS SERVICE ARRANGEMENTS

M. BLOCKING SERVICES (Cont'd)

3. Restricted Sent Paid Service (RSPS) - Central Telephone Exchanges Only (Cont'd)

	<u>Nonrecurring Charge</u>	<u>Monthly Rate</u>
-		
e. RSPS Charges per Block of Consecutive Numbers		
Option 1	\$395.00	\$190.00
Restricted Codes		
DDD 1+		
1+900, 0 + 900		
1 + 555-1212		
1 + NPA-555-1212		
IDD 011 +		
Option 2 <sup>1</sup>		
Restricted codes		
1 + 900, 0 + 900, N11		
Option 3	\$ 39.50	\$ 19.00
Restricted Codes		
For Digital Centrex Users		
By NCOS Design		
Per Customer Group		

Note 1: Service charges are not applicable .



GENERAL EXCHANGE TARIFF

Embarq Florida, Inc.

By: F. B. Poag  
Director

SECTION A13  
First Revised Sheet 85  
Cancelling Original Sheet 85  
Effective: January 1, 1997

MISCELLANEOUS SERVICE ARRANGEMENTS

M. BLOCKING SERVICES (Cont'd)

4. Call Aggregator Screening Services: Central Office Blocking with Operator Screening - Central Telephone Exchanges Only
  - a. General
    - 1) Central Office Blocking with Operator Screening service is being offered to provide a choice of restrictions to call aggregators such as correctional institutions, hotels, schools, hospitals and other locations which may be deemed a call aggregator.
    - 2) This feature is offered only in digital central offices where facilities are available.
  - b. Blocking/Screening Options
    - 1) Option C - Two-Way Service. Provides screening information to the operator to prevent operator assisted sent-paid calls from being billed to the line. Provides central office blocking of 011+ calls.
    - 2) Option C1 - Same as Option C except 1+900 and 976 calls are also blocked.

GENERAL EXCHANGE TARIFF

Embarq Florida, Inc.

By: F. B. Poag  
Director

SECTION A13  
Second Revised Sheet 86  
Cancelling First Revised Sheet 86  
Effective: May 29, 1997

MISCELLANEOUS SERVICE ARRANGEMENTS

M. BLOCKING SERVICES (Cont'd)

4. Call Aggregator Screening Services: Central Office Blocking with Operator Screening - Central Telephone Exchanges Only (Cont'd)

b. Blocking/Screening Options (Cont'd)

- 3) Option D<sup>1</sup> - Outward Only Service. Provides screening information to the operator to prevent operator assisted sent-paid calls from being billed to the line. Provides central office blocking of 011 calls.
- 4) Option D1 - Same as Option D except 1+900 and 976 calls are also blocked.
- 5) Option E - Two-Way Service. Provides central office blocking of 7 digit local, 976, 1+DDD and 1+900 calls. Provides screening to the operator to prevent operator assisted sent-paid calls from being billed to the line. Also provides C.O. blocking of 011+ calls.
- 6) Option F<sup>1</sup> - Outward Only Service. Provides central office blocking of 7 digit local, 976, 1+DDD, 1+900, and 011+ calls.

Note 1: Options D, F, and H may only be provided for placement in correctional institutions, schools, hospitals and other locations for which the Public Service Commission may grant a specific exemption.

GENERAL EXCHANGE TARIFF

Embarq Florida, Inc.

By: F. B. Poag  
Director

SECTION A13  
Fourth Revised Sheet 87  
Cancelling Third Revised Sheet 87  
Effective: November 12, 2004

MISCELLANEOUS SERVICE ARRANGEMENTS

M. BLOCKING SERVICES (Cont'd)

4. Call Aggregator Screening Services: Central Office Blocking with Operator Screening - Central Telephone Exchanges Only (Cont'd)

b. Blocking/Screening Options (Cont'd)

- 7) Option G - Two-Way Service. Provides central office blocking of 976, 1+DDD, 1+900 calls and 011+ calls. Provides screening information to the operator to prevent operator assisted sent-paid calls from being billed to the line.
- 8) Option H<sup>1</sup> - Outward Only Service. Provides central office blocking of 976, 1+DDD, 1+900, and 011+ calls. Provides screening information to the operator to prevent operator assisted sent-paid calls from being billed to the line.

c. Rates

<u>Option</u>	<u>Monthly Rate</u>
1) Option C	\$3.50
2) Option C1	3.50
3) Option D	3.50
4) Option D1	3.50
5) Option E	3.50
6) Option F	3.50
7) Option G	3.50
8) Option H	3.50

d. Limitations/Requirements

- 1) Billed Number Screening (BNS) service as provided in Section A13.L. of this tariff is a mandatory service feature for central office blocking with Operator Screening Service - all options.
- 2) Operator Screening is provided for intraLATA calling through Company operators. Screening for interLATA calling is the responsibility of the interLATA carriers who choose to acknowledge the network screening signals passed to them by the Company.

Certain material now residing on this page was previously located in Section 13, First Revised Sheet 88.

Note 1: Options D, F, and H may only be provided for placement in correctional institutions, schools, hospitals, and other locations for which the Public Service Commission may grant a specific exemption.

GENERAL EXCHANGE TARIFF

Embarq Florida, Inc.

By: F. B. Poag  
Director

SECTION A13  
Third Revised Sheet 88  
Cancelling Second Revised Sheet 88  
Effective: March 1, 2001

MISCELLANEOUS SERVICE ARRANGEMENTS

M. BLOCKING SERVICES (Cont'd)

5. Third Party Block Service

a. General

Pursuant to Florida Public Service Commission Order No. PSC-00-1117-FOF-TP, issued June 19, 2000, the Company will offer a service that blocks the placing of monthly recurring charges on customers' telephone bills by third party service providers. This blocking service will give subscribers the ability to prevent unauthorized charges from appearing on their bill by not allowing third party service providers the capability to place monthly recurring charges on customers bills without proper verification.

GENERAL EXCHANGE TARIFF

Embarq Florida, Inc.

By: F. B. Poag  
Director

SECTION A13  
First Revised Sheet 88.1  
Cancelling Original Sheet 88.1  
Effective: March 1, 2001

MISCELLANEOUS SERVICE ARRANGEMENTS

M. BLOCKING SERVICES (Cont'd)

5. Third Party Block Service (Cont'd)

b. Regulations

- 1) The third party service provider may not submit charges to a customer's local exchange carrier without first obtaining a letter of authorization ("LOA") from an authorized individual for the telephone account.
- 2) The Company will not remove a third party service provider block without first calling the customer and obtaining his or her verbal approval.
- 3) Third party blocking is available to all customers at no monthly charge and no service connection charges apply for the installation of the third party block service.
- 4) Customers cannot block charges coming from their preferred local carrier, preferred intraLATA carrier, or preferred interLATA carrier. Customers may choose to block all third party service providers or may selectively block specific third party service providers.
- 5) The Company may not disconnect a customer's regulated local telephone service for non-payment of disputed third party charges.
- 6) Authorized casual billing of toll calls such as collect, third party and calls to a carrier's toll access number as well as authorized charges for directory advertising, are excluded from this blocking service. In addition, monthly recurring charges related to casual toll billing cannot be blocked (e.g., surcharges such as Universal Service Fund).

c. Limitations

- 1) The Company does not guarantee that by placing a bill block on the subscriber's account that unauthorized third party charges cannot be billed to the subscriber's account. The Company shall not be liable for any damages that may occur if unauthorized third party charges are billed to the subscriber as long as the Company has fully complied with the requirements specified in the Tariff.
- 2) Due to billing system limitations, charges from some third party service providers billed through billing aggregators or billing clearinghouses can only be blocked by blocking the billing aggregator or billing clearinghouse thereby effectively blocking all other third party service providers billing through that aggregator or clearinghouse.
- 3) Charges billed prior to the placement of a block may appear on subsequent customer bills because many such charges are billed in arrears.

GENERAL EXCHANGE TARIFF

Embarq Florida, Inc.

By: F. B. Poag  
Director

SECTION A13  
First Revised Sheet 88.2  
Cancelling Original Sheet 88.2  
Effective: October 24, 2003

MISCELLANEOUS SERVICE ARRANGEMENTS

M. BLOCKING SERVICES (Cont'd)

6. Toll and Casual Dialing Restriction Service

1. Description

- a. Where central office facilities permit, Toll and Casual Dialing Restriction prevents the completion of certain types of calls. Toll and Casual Dialing Restriction may be provided with individual line residence and business exchange services in exchanges equipped to program Toll and Casual Dialing Restriction without alteration of the central office equipment.

2. Terms and Conditions

- a. Toll and Casual Dialing Restriction Options 1 and 2 restrict access to 1+, 0+ 0-, and 00-, and restrict access to 01/011+ numbers outside of the North American Numbering Plan. Access to 900, 976, 500 and 700 numbers is also restricted in addition to Directory Assistance and the casual dialing of toll calls (by preceding the telephone number with 101XXXX+). Option 1 additionally restricts access to Toll Free Code numbers. Option 3 only restricts access to 01/011+ numbers outside of the North American Numbering Plan.
- b. Restriction of access to operator services prevents the customer from dialing an operator for all purposes, including emergencies, assistance and the placing of toll calls. Operator Services will not be accessible from a line with Toll and Casual Dialing Restriction Option 1 or 2. The customer indemnifies and saves harmless the Company from any and all claims, losses, or damages caused by restriction of access to operator services.
- c. Directory Assistance (411, 1411, 555-1212, 1-555-1212, or 1-NPA-555-1212) will not be accessible from a line with Toll and Casual Dialing Restriction Option 1 or 2.
- d. All local calls and non-chargeable calls to Company numbers (such as repair service) will be permitted.
- e. Where facilities allow, N11 (except 411) will only be restricted with Option 1 and 2 if the call terminates outside the local calling area or to a non-toll-free number.
- f. Toll and Casual Dialing Restriction does not restrict calls to 911 emergency reporting service or to 1+710 Government Emergency Telecommunications Service Calls.
- g. Customers are responsible for calls charged to their number via third number billing, collect or credit card.

GENERAL EXCHANGE TARIFF

Embarq Florida, Inc.

By: F. B. Poag  
Director

SECTION A13  
First Revised Sheet 88.3  
Cancelling Original Sheet 88.3  
Effective: October 24, 2003

MISCELLANEOUS SERVICE ARRANGEMENTS

M. BLOCKING SERVICES (Cont'd)

6. Toll and Casual Dialing Restriction Service (Cont'd)

2. Terms and Conditions (Cont'd)

- h. Listed following are the Toll and Casual Dialing Restriction options as determined by the Company. These options may be changed or new options added as determined appropriate by the Company. A customer may select one of the following Toll and Casual Dialing Restriction options:

Option #1      1+ DDD  
0-, 0+, 00-  
01/011+DDD to numbers outside the  
North American Numbering Plan  
Directory Assistance (411, 1411, 555-1212,  
1-555-1212, 1-NPA-555-1212)  
101XXXX access to toll numbers  
Extended Calling Service  
Toll Free Code numbers (1 + 800, 1 + 888, etc.)  
N11, 500, 700, 900, 976  
(Allows 1+710 and 911 calls)

Option #2      1+ DDD  
0-, 0+, 00-  
01/011+DDD to numbers outside the  
North American Numbering Plan  
Directory Assistance (411, 1411, 555-1212,  
1-555-1212, 1-NPA-555-1212)  
101XXXX access to toll numbers  
Extended Calling Service  
N11, 500, 700, 900, 976  
(Allows toll free, 1+710 and 911 calls.)

Option #3      01/011+DDD to numbers outside the  
North American Numbering Plan  
101XXXX access to 01/011+DDD to numbers  
outside the North American Numbering Plan

GENERAL EXCHANGE TARIFF

Embarq Florida, Inc.

By: F. B. Poag  
Director

SECTION A13  
First Revised Sheet 88.4  
Cancelling Original Sheet 88.4  
Effective: October 24, 2003

MISCELLANEOUS SERVICE ARRANGEMENTS

M. BLOCKING SERVICES (Cont'd)

6. Toll and Casual Dialing Restriction Service (Cont'd)

3. Rates

The following rates and charges are for Toll and Casual Dialing Restriction Service only and are in addition to the applicable service charges, monthly rates, and nonrecurring charges for exchange access lines and other service or equipment with which they are associated.

	<u>Nonrecurring Charge</u>	<u>Monthly Rate</u>
Option #1		
a) Residence line, each	\$ 6.00	\$3.50
b) Business line, each	6.00	4.25
Option #2		
a) Residence line, each	\$ 6.00	\$3.50
b) Business line, each	6.00	4.25
Option #3		
a) Residence line, each	\$ 6.00	\$3.50
b) Business line, each	6.00	4.25



GENERAL EXCHANGE TARIFF

Embarq Florida, Inc.

By: F. B. Poag  
Director

SECTION A13  
First Revised Sheet 89  
Cancelling Original Sheet 89  
Effective: January 1, 1997

MISCELLANEOUS SERVICE ARRANGEMENTS

N. SIMPLIFIED MESSAGE DESK INTERFACE (SMDI) SERVICE

1. General

- a. Simplified Message Desk Interface (SMDI) is a feature available to providers of voice messaging systems and secretarial in-dialing services. SMDI provides an integrated, automated interface for the transport of call-related information regarding the origin and destination of messages for end-user clients of voice messaging systems and secretarial in-dialing services.
- b. SMDI is provided on an intra office basis. Call-related information is passed to the provider's system via a data link from the SMDI central office to the provider's premises.
- c. SMDI provides the voice mail system and in-dialing service with the following information on intra office calls:
  - 1) called and calling numbers identification
  - 2) call forward reasons, i.e., no answer, busy
  - 3) a request to activate the client's message waiting indicator
- d. End-user clients who are subscribers to a voice messaging system or in-dialing service with SMDI are notified of messages by an audible message waiting indicator (stuttered dial tone).
- e. Queuing can be provided as an option to SMDI. Queue announcements are also available with either Company- or customer-provided recordings.

GENERAL EXCHANGE TARIFF

Embarq Florida, Inc.

By: F. B. Poag  
Director

SECTION A13  
Second Revised Sheet 90  
Cancelling First Revised Sheet 90  
Effective: May 29, 1997

MISCELLANEOUS SERVICE ARRANGEMENTS

N. SIMPLIFIED MESSAGE DESK INTERFACE (SMDI) SERVICE (Cont'd)

2. Regulations

- a. The system provider must subscribe to rotary service access lines from the same SMDI central office as the data link. The rotary service access lines are arranged for terminating traffic only.
- b. SMDI queuing is available as an optional feature on an intra office basis where available.
- c. Stuttered dial tone is included in each SMDI system at no additional charge.
- d. Optional queuing provides for one queued call for each incoming access line arranged for queuing.
  - 1) Queuing may include both an initial and a continued delay announcement.
  - 2) The queue announcements may be provided by the Company or the customer at the rates specified following.
- e. The system provider may subscribe to additional blocks of telephone numbers to serve as addresses for voice mail boxes at the rates for DID numbers in Section A16 of this tariff.
- f. The Company will not be a party to any controversies which may arise between the SMDI subscriber and the end-user client regarding the quality of service provided by the voice messaging system or the options which may or may not be selected by the SMDI subscriber.

GENERAL EXCHANGE TARIFF

Embarq Florida, Inc.

BY: F. B. Poag  
Director

SECTION A13  
Second Revised Sheet 91  
Cancelling First Revised Sheet 91  
Effective: July 21, 1998

MISCELLANEOUS SERVICE ARRANGEMENTS

N. SIMPLIFIED MESSAGE DESK INTERFACE (SMDI) SERVICE (Cont'd)

3. Rates and Charges

- a. Charges applicable to the voice messaging system or secretarial in-dialing service provider:

	<u>Nonrecurring Charge</u>	<u>Monthly Rate</u>
SMDI common equipment, per data line, per SMDI central office	\$500.00	\$300.00
SMDI access line	Access line Charge-See Section A4	Applicable Business Rotary Line Rate
Data Link	See Section A20	
Queuing		
Per system --	\$ 33.00	
Per SMDI, access line	--	2.00
Queue announcements		
Initial --	5.00	
Continued delay	--	5.00
Company provided recording		
Initial or both announcements		
Generic	\$ 25.00	
Customized	250.00	
Customer provided recording		
Initial or both announcements	10.00	

GENERAL EXCHANGE TARIFF

Embarq Florida, Inc.

By: F. B. Poag  
Director

SECTION A13  
Third Revised Sheet 92  
Cancelling Second Revised Sheet 92  
Effective: August 13, 1999

MISCELLANEOUS SERVICE ARRANGEMENTS

N. SIMPLIFIED MESSAGE DESK INTERFACE (SMDI) SERVICE (Cont'd)

3. Rates and Charges (Cont'd)

a. (Cont'd)

Additional telephone numbers

See Section A16

- b. Primary and Secondary Service Order Charges are not applicable to the provider for the initial request for SMDI. Subsequent requests and additions are subject to appropriate service connection charges.

O. SINGLE PARTY ACCESS LINE FEATURE (CUTOFF ON DISCONNECT) (UNITED TELEPHONE EXCHANGES ONLY)

1. General

- a. The standard single-line residence and business access line is a loop-start, two-wire circuit.
- b. Reverse battery or ground start features, either singly or in any combinations, are available to residence and business customers only.
- c. The rate is per feature per access line equipped.

2. Rates and Charges

- a. Per Month \$5.00
- b. Appropriate service connection charges will apply.

GENERAL EXCHANGE TARIFF

Embarq Florida, Inc.

By: F. B. Poag  
Director

SECTION A13  
First Revised Sheet 93  
Cancelling Original Sheet 93  
Effective: January 1, 1997

MISCELLANEOUS SERVICE ARRANGEMENTS

P. TELECOMMUNICATIONS SERVICE PRIORITY (TSP) SERVICE

1. General

- a. The Telecommunications Service Priority (TSP) System was developed to satisfy the requirements of the National Communications System (NCS) of the federal government and provides the regulatory, administrative and operational procedures authorizing the priority installation and/or priority restoration of National Security Emergency Preparedness (NSEP) telecommunications services. TSP applies only to NSEP telecommunications services and authorizes the Company to take priority action in the provision and restoration of such services. Installation and/or restoration of services not receiving TSP designation which affect public health and safety will be provisioned and maintained in accordance with Rule 25-4.070(4), Florida Administrative Code.
- b. Priority installation and/or priority restoration of NSEP telecommunications services shall be provided in accordance with Part 64.401, Appendix A, of the Federal Communications Commission's (FCC's) Rules and Regulations, and in accordance with the guidelines set forth in the TSP System for NSEP Service Vendor Handbook (NCS Handbook 3-1-2), dated July 11, 1989.
- c. The customer requesting TSP service must be the same customer for which the associated telecommunications service is provided.

GENERAL EXCHANGE TARIFF

Embarq Florida, Inc.

By: F. B. Poag  
Director

SECTION A13  
First Revised Sheet 94  
Cancelling Original Sheet 94  
Effective: January 1, 1997

MISCELLANEOUS SERVICE ARRANGEMENTS

P. TELECOMMUNICATIONS SERVICE PRIORITY (TSP) SERVICE (Cont'd)

1. General (Cont'd)

- d. Certain conditions may require that one or more customer services with a lower or no restoration priority be preempted in order to install or restore NSEP telecommunications service(s) of a higher priority. When such preemption is necessary, the Company will make every reasonable effort to notify the preempted customer of the action to be taken. Credit allowances for such service preemption shall be made according to the provisions set forth in A2 preceding.
- e. In obtaining TSP, the customer authorizes the Company to provide certain customer record information to the manager, NCS, of the federal government so that the government can maintain and administer its TSP system. This customer record information will include only the customer's name, TSP authorization code, Company circuit ID, customer telephone number and customer mailing address.
- f. In order to provide priority restoration service in compliance with Part 64.401, Appendix A, of the FCC's rules and regulations, the Company may be unable to notify the customer in advance where additional labor charges apply, as set forth in A2 preceding, before the required additional labor is undertaken. The customer, in obtaining a restoration priority, recognizes that quoting charges and obtaining permission to proceed with the restoration of certain telecommunications services will cause unnecessary delays and, as a result, would be contrary to the aforementioned Rules and Regulations.

GENERAL EXCHANGE TARIFF

Embarq Florida, Inc.

By: F. B. Poag  
Director

SECTION A13  
Second Revised Sheet 95  
Cancelling First Revised Sheet 95  
Effective: May 29, 1997

MISCELLANEOUS SERVICE ARRANGEMENTS

P. TELECOMMUNICATIONS SERVICE PRIORITY (TSP) SERVICE (Cont'd)

1. General (Cont'd)

f. (Cont'd)

In subscribing to TSP, the customer recognizes this condition and grants the Company the right to quote charges after the restoration has been completed.

g. When an assigned restoration priority is discontinued or revoked, and the associated telecommunications service is continued in service, no charge applies for such discontinuance.

h. Credit allowance provisions for an interruption in priority restoration are the same as those for which the telecommunications service with which it is associated, as set forth in A2 preceding.

i. When a customer requests that a priority installation be expedited (i.e., essential and emergency services), the regulations, rates and charges set forth in Section A5.C.1. for the service for which the priority installation is required shall also apply.

j. In the event that the Company must utilize specially constructed facilities in the priority installation of a service, the regulations, rates and charges set forth in A5 of this tariff, for the service for which priority installation is required, shall also apply.

GENERAL EXCHANGE TARIFF

Embarq Florida, Inc.

By: F. B. Poag  
Director

SECTION A13  
First Revised Sheet 96  
Cancelling Original Sheet 96  
Effective: January 1, 1997

MISCELLANEOUS SERVICE ARRANGEMENTS

P. TELECOMMUNICATIONS SERVICE PRIORITY (TSP) SERVICE (Cont'd)

1. General (Cont'd)

- k. The activities performed by the Company in the provision of TSP are included in the following rate elements:
- 1) Priority Installation - includes provision of confirmation information to the manager, NCS, of the federal government, verification of TSP code assignments, and installation preemption, if necessary.
  - 2) Priority Restoration Implementation - includes provision of confirmation information to the manager, NCS, of the federal government and verification of TSP code assignment.
  - 3) Priority Restoration Change - includes provision of confirmation information and TSP code verification when a priority restoration level is changed on an associated telecommunications service.
  - 4) Priority Restoration Maintenance and Administration - includes TSP system administration and maintenance reconciliation of TSP code levels, and restoration preemption, if necessary.



GENERAL EXCHANGE TARIFF

Embarq Florida, Inc.

By: F. B. Poag  
Director

SECTION A13  
Second Revised Sheet 97  
Cancelling First Revised Sheet 97  
Effective: May 29, 1997

MISCELLANEOUS SERVICE ARRANGEMENTS

P. TELECOMMUNICATIONS SERVICE PRIORITY (TSP) SERVICE (Cont'd)

2. Rates and Charges

The following rates and charges are in addition to all other rates and charges applicable for other services furnished under the provisions of this tariff which operate in conjunction with the TSP system. This includes, but is not limited to, Trouble Location Charges, as found in Section A4 of this tariff.

	<u>Nonrecurring Charges</u>	<u>Monthly Rates</u>
Priority Installation	\$ 85.00	None
Priority Restoration Implementation	47.00	None
Priority Restoration Charge	45.00	None
Priority Restoration Maintenance And Administration	None	\$ 6.00

When a service is ordered with both Priority Installation and Priority Restoration Implementation, the associated nonrecurring charge for each applies.

GENERAL EXCHANGE TARIFF

Embarq Florida, Inc.

By: F. B. Poag  
Director

SECTION A13  
Third Revised Sheet 98  
Cancelling Second Revised Sheet 98  
Effective: June 5, 1998

MISCELLANEOUS SERVICE ARRANGEMENTS

RESERVED FOR FUTURE USE

GENERAL EXCHANGE TARIFF

Embarq Florida, Inc.

By: F. B. Poag  
Director

SECTION A13  
Third Revised Sheet 99  
Cancelling Second Revised Sheet 99  
Effective: June 5, 1998

MISCELLANEOUS SERVICE ARRANGEMENTS

R. ENHANCED DATA TRANSMISSION SERVICE (EDTS)

1. General

- a. Enhanced Data Transmission Service (ETDS) is an enhancement to Residential and Business single line services applicable only to the local loop and provides higher transmission standards than normally provided for voice transmission. It is designed for customers requesting a better grade of service for data transmission. Lines conditioned with this level of service may also be used for normal voice communication. This service is offered subject to the availability of suitable facilities.

GENERAL EXCHANGE TARIFF

Embarq Florida, Inc.

By: F. B. Poag  
Director

SECTION A13  
First Revised Sheet 100  
Cancelling Original Sheet 100  
Effective: January 1, 1997

MISCELLANEOUS SERVICE ARRANGEMENTS

R. ENHANCED DATA TRANSMISSION SERVICE (EDTS) (Cont'd)

2. Regulations

- a. The quality of the line is conditioned only between the customer point of demarcation and the serving central office switch. No assurances are made as to error rates or transmission rates. This is due to the varying features and functions of different customer premises equipment at both termination points as well as the other facilities which will be necessary to complete the end-to-end transmission path. The service parameters are listed as follows:

	<u>Parameters</u>	<u>EDTS</u>	<u>Voice</u>
1)	LINE CURRENT	Not less than 23ma	Not less than 23 ma
2)	CIRCUIT NOISE	Not greater than 20 dBrc	Not greater than 20 dBrc
3)	CIRCUIT LOSS @ 1004 Hz	Not greater than -8.5 dBrc	None
4)	ATTENUATION DISTORTION (Loss deviation at 1004 Hz and 2804 Hz)	Loaded Pair - Not greater than 8 dB  Non-Loaded Pair – Not greater than 7 dB	None  None
5)	POWER INFLUENCE 80 dB	Not greater than 80 dB	Not greater than

GENERAL EXCHANGE TARIFF

Embarq Florida, Inc.

By: F. B. Poag  
Director

SECTION A13  
Second Revised Sheet 101  
Cancelling First Revised Sheet 101  
Effective: May 29, 1997

MISCELLANEOUS SERVICE ARRANGEMENTS

R. ENHANCED DATA TRANSMISSION SERVICE (EDTS) (Cont'd)

2. Regulations (Cont'd)

b. Enhanced Data Transmission Service (EDTS) may not be compatible with other services offered in this Tariff, such as Call Waiting and SignalRing, and is not offered in conjunction with the following:

- 1) PBX Trunks or stations
- 2) Foreign Exchange Service
- 3) Off-Premises Extensions
- 4) Foreign Central Office Service
- 5) Outward WATS

3. Rates and Charges

a. The following charges are in addition to the recurring monthly rates and Nonrecurring charges for the appropriate Exchange Access Line specified in Sections A3 and A4 of this tariff.

b. Per Exchange Access Line:

	<u>Nonrecurring Charge</u>	<u>Monthly Rate</u>
1) Residence line, each	\$100.00	\$ 5.00
2) Business line, each	100.00	5.00

GENERAL EXCHANGE TARIFF

Embarq Florida, Inc.

By: F. B. Poag  
Director

SECTION A13  
Fourth Revised Sheet 102  
Cancelling Third Revised Sheet 102  
Effective: November 27, 1998

MISCELLANEOUS SERVICE ARRANGEMENTS

S. OFF-PREMISES EXTENSION SERVICE

United Telephone Exchanges Only

1. General

- a. Extension service provides the capability of originating or receiving calls from locations in addition to the location of the main service.
- b. Extension service will be provided in connection with all classes of main service, excluding pay telephone service. Extension service may be provided in connection with pay telephone service for the exclusive use of the subscriber for answering purposes only.
- c. In the case of individual line subscribers' service, extension service may be located on other premises under the following conditions, provided facilities are available and technical equipment limitations in each specific case permit:
  - 1) Where two or more premises of the same subscriber are used in the conduct of one establishment or business; or
  - 2) Where the extension service is located on other than the subscriber's premises for the purpose of answering calls at such time as the subscriber is not available at the main location, provided that separate exchange service is also provided on these other premises.

GENERAL EXCHANGE TARIFF

Embarq Florida, Inc.

By: F. B. Poag  
Director

SECTION A13  
Second Revised Sheet 103  
Cancelling First Revised Sheet 103  
Effective: May 29, 1997

MISCELLANEOUS SERVICE ARRANGEMENTS

S. OFF-PREMISES EXTENSION SERVICE (Cont'd)

1. General (Cont'd)

United Telephone Exchanges Only

- d. The provision of circuits required to connect main and extension line service is subject to the regulations and charges shown under "Extension Line Mileage" following in this tariff section.

Central Telephone Exchanges Only

- e) Offered to subscribers in conjunction with basic residence or business exchange service, Off-Premises Extension (OPX) Service provides for speech communications within the specifications and limits as stated in A13.S.2. following.
- f) OPX service is offered under this section if it is located on other premises and meets the following conditions; provided facilities are available and technical equipment limitations in each specific case permit, and provided that residence extension service is not located on business premises:
  - 1) Where two or more "premises" of the same subscriber are used in the conduct of one establishment or business, or
  - 2) Where the extension service is located on other than the subscriber's premises for the purpose of answering calls at such time as the subscriber is not available at the main station, provided that separate exchange service is also provided on these other premises.

GENERAL EXCHANGE TARIFF

Embarq Florida, Inc.

SECTION A13

By: F. B. Poag  
Director

Third Revised Sheet 104  
Cancelling Second Revised Sheet 104  
Effective: September 3, 1997

MISCELLANEOUS SERVICE ARRANGEMENTS

S. OFF-PREMISES EXTENSION SERVICE (Cont'd)

1. General (Cont'd)

Central Telephone Exchanges Only

- g) Where supporting structure or underground conduit is necessary for the purpose of furnishing extension lines on the subscriber's premises, such supporting structure or underground conduit is furnished by the subscriber as provided for under "Construction on Private Property" in Section A5.

2. Types and Descriptions - Central Telephone Exchanges Only (Cont'd)

- a. These channels are furnished for operation on a two-point basis for service seven (7) days per week, 24 hours per day, for a minimum period of one (1) month. The transmission characteristics and various types of services furnished within this category of service are as follows:

- 1) Basic Parameters and Specifications are described for the end-to-end operations as follows:

a) Net Loss

Limit as specified in the following Channel description as shown in a.2). Losses or gains present in station equipment have not been included.

b) Frequency Response (Referenced to the 1000 Hz Loss)

300-3000 Hz	-3db to + 12 db
50-2500 Hz	-2db to + 8 db



GENERAL EXCHANGE TARIFF

Embarq Florida, Inc.

By: F. B. Poag  
Director

SECTION A13  
Third Revised Sheet 105  
Cancelling Second Revised Sheet 105  
Effective: September 3, 1997

MISCELLANEOUS SERVICE ARRANGEMENTS

S. OFF-PREMISES EXTENSION SERVICE (Cont'd)

a. (Cont'd)

2. Types and Descriptions - Central Telephone Exchanges Only (Cont'd)

2) Type 2110 Channels are described following: Channels which provide auxiliary features, Tie Line Service and PBX Extension Station service are now located in Section A20 of this tariff.

a) Type 2110

A two-wire interface with effective two-wire facilities engineered for a 1004 Hz net loss of 0 to 10db. Generally furnished for voice transmission for off-premises residence or business extension use.

3) If the extension station is served from a serving wire center different from the main station, interoffice mileage charges from Section A9 (Foreign Central Office) of this tariff will apply.

3. Rates and Charges

a. For Local Channels which are routed via the central office.

	<u>Nonrecurring Charge</u>
1) Type 2110 <sup>1</sup>	\$ 24.50

Note 1: Monthly rates, as contained in 2) following for the serving exchange rate group, are applicable.

GENERAL EXCHANGE TARIFF

Embarq Florida, Inc.

BY: F. B. Poag  
Director

SECTION A13  
Seventh Revised Sheet 106  
Cancelling Sixth Revised Sheet 106  
Effective: November 12, 2004

MISCELLANEOUS SERVICE ARRANGEMENTS

S. OFF-PREMISES EXTENSION SERVICE (Cont'd)

3. Rates and Charges (Cont'd)

a. (Cont'd)

2) Monthly Rate, per Rate Group

<u>Rate Group</u>	<u>Monthly Rate</u>	
	<u>Residence</u>	<u>Business</u>
1	\$ 10.00	\$ 25.00
2	10.00	25.00
3	10.00	25.00
4	10.00	25.00
5	10.00	25.00

3) Monthly rate for Useppa Island and North Captiva Island can be found in Section A3.

b. For inter-building channels not routed via the central office utilizing Telephone Company owned facilities (limited to channels not more than one air mile in length).

	<u>Nonrecurring Charge</u>	<u>Monthly Rate</u>	
		<u>Residence</u>	<u>Business</u>
1) Type 2110	\$24.50	\$ 5.40	\$14.00

GENERAL EXCHANGE TARIFF

Embarq Florida, Inc.

By: F. B. Poag  
Director

SECTION A13  
First Revised Sheet 107  
Cancelling Original Sheet 107  
Effective: January 1, 1997

MISCELLANEOUS SERVICE ARRANGEMENTS

S. OFF-PREMISES EXTENSION SERVICE (Cont'd)

4. Service Connection Charges

a. General

- 1) Service Ordering Charges are applicable per service order for receiving and recording information and/or taking action in connection with a customer's request and processing the necessary data. These charges include the engineering design function. Only one Service Ordering Charge applies when more than one channel service of the same type is ordered for termination at the same premises at the same time.
- 2) Premises Visit Charges are applicable for the termination of any 2110 Channel, or for inside moves. Only one Premises Visit Charge applies when more than one channel service of the same type is terminated at the same premises at the same time.
- 3) Channel Connection Charges are applicable for the connection and testing of any 2110 Channel and for inside moves of this service in addition to the connection charge reflected in A13.S.4.a.4)a).

GENERAL EXCHANGE TARIFF

Embarq Florida, Inc.

By: F. B. Poag  
Director

SECTION A13  
Second Revised Sheet 108  
Cancelling First Revised Sheet 108  
Effective: May 29, 1997

MISCELLANEOUS SERVICE ARRANGEMENTS

S. OFF-PREMISES EXTENSION SERVICE (Cont'd)

4. Service Connection Charges (Cont'd)

a. General (Cont'd)

4) Connection Charge

	<u>Nonrecurring Charge</u>
a) Inside Moves	\$ 24.50

Changing from one type of service to another type of service is considered as a disconnect and a new connect and not an inside move.

T. HOT LINE SERVICE (HLS) (CENTRAL TELEPHONE EXCHANGES ONLY)

1. General

a. HLS is a central office arrangement whereby a prearranged local or toll number is automatically dialed when the calling party's instrument receiver is taken off-hook. The arrangement is a feature available with Business one-party local exchange service.

b. HLS will be provided under the following conditions:

- 1) Service is offered subject to availability of suitable facilities in central offices equipped with this feature.
- 2) Service is not offered where the station at which calls will be answered is a coin telephone.

GENERAL EXCHANGE TARIFF

Embarq Florida, Inc.

By: F. B. Poag  
Director

SECTION A13  
First Revised Sheet 109  
Cancelling Original Sheet 109  
Effective: January 1, 1997

MISCELLANEOUS SERVICE ARRANGEMENTS

T. HOT LINE SERVICE (HLS) - CENTRAL TELEPHONE EXCHANGES ONLY (Cont'd)

I. General (Cont'd)

- 3) Service for the local exchange access line associated with this feature will be non-published.
- 4) Local exchange access lines arranged with this feature will be taken with the understanding that absolutely no other calls can be originated by the associated station except to the prearranged number.
- 5) Exchange access lines associated with HLS are also capable of receiving calls, the charges for which are the full responsibility of the customer.
- 6) HLS is provided on the condition that the customer subscribes to sufficient arrangements and terminating telephone numbers to adequately handle calls from the HLS-arranged line without interfering with or impairing any service offered by the Telephone Company. If in the opinion of the Telephone Company additional arrangements or terminating telephone numbers are required, the customer will be responsible for subscribing to such additional arrangements or terminating telephone numbers or the HLS feature shall be subject to termination.

GENERAL EXCHANGE TARIFF

Embarq Florida, Inc.

By: F. B. Poag  
Director

SECTION A13  
Second Revised Sheet 110  
Cancelling First Revised Sheet 110  
Effective: May 29, 1997

MISCELLANEOUS SERVICE ARRANGEMENTS

T. HOT LINE SERVICE (HLS) - CENTRAL TELEPHONE EXCHANGES ONLY (Cont'd)

2. Rates and Charges

- a. Service Charges as shown in Section A4 of this tariff shall apply as follows:
  - 1) For the initial arrangement of HLS only the regular service charges associated with the new installation of an exchange access line shall apply.
  - 2) When HLS is added to an existing exchange access line, or when the number to which calls are to be automatically dialed is changed, only a Secondary Service Ordering Charge shall apply.
- b. Message charges shall apply based on the appropriate tariffs and rates in effect at the time calls are placed or accepted.
- d. Monthly service for HLS is in addition to the applicable tariff rates for Business one-party local exchange service.

Monthly Rate

Hot Line Service

\$ 7.40

GENERAL EXCHANGE TARIFF

Embarq Florida, Inc.

By: F. B. Poag  
Director

SECTION A13  
First Revised Sheet 111  
Cancelling Original Sheet 111  
Effective: January 1, 1997

MISCELLANEOUS SERVICE ARRANGEMENTS

U. TOLL TERMINAL SERVICE - CENTRAL TELEPHONE EXCHANGES ONLY

1. General

- a. Toll Terminal Service consists of Company facilities specifically arranged to complete only outward long distance toll calls. The Company will provide either of the following pre-arranged Toll Terminal Services.
  - 1) Wholly Operator Assisted - on each and every call (whether "0+, 0-, or 1+") an operator will enter the call process to obtain pertinent billing information from the caller, and then complete the call.
  - 2) Operator Assisted, with Direct Distance Dialing Option either of two general types of calls may be placed over this type of service:
    - a) Operator Assisted - Calls will be directed to a Company Operator (via "0+ or 0-" dialing) who will enter the call process to obtain pertinent billing information from the caller, and then complete the call, or
    - b) Direct Distance Dialing (DDD) Option - Calls will be completed and billed at sent-paid, station-to- station rates where the customer allows guests or others to dial DDD (via 1 + 7 or 10 digits) on toll calls.
- b. Toll terminals may not be used for completing incoming calls or outgoing local exchange calls.

GENERAL EXCHANGE TARIFF

Embarq Florida, Inc.

By: F. B. Poag  
Director

SECTION A13  
Second Revised Sheet 112  
Cancelling First Revised Sheet 112  
Effective: May 29, 1997

MISCELLANEOUS SERVICE ARRANGEMENTS

U. TOLL TERMINAL SERVICE - CENTRAL TELEPHONE EXCHANGES ONLY (Cont'd)

1. General (Cont'd)

- c. Toll Terminal Service will be furnished dependent upon availability of facilities and offered only in connection with (1) hotel/motel or hospital switchboard service, or (2) other customer types when also subscribing to Autoquote (Centel Telephone Areas only) service when Wholly Operator Assisted Service is taken.
- d. Concurrent with the effective date of this sheet all Toll Terminal Service customers will be required to subscribe to Autoquote when new service, additions, or changes are requested and the customer has Wholly Operator Assisted Service.
- e. Any call completed via Operator Assistance will be billed at the current tariff rates for Operator Handled calls.
- f. "Time and Charge Quotations" will not be rendered on any call placed via the Direct Distance Dialing Option, and customers utilizing this service are required to provide their own methods of call accounting or a call rating system.



GENERAL EXCHANGE TARIFF

Embarq Florida, Inc.

By: F. B. Poag  
Director

SECTION A13  
Third Revised Sheet 113  
Cancelling Second Revised Sheet 113  
Effective: September 1, 2001

MISCELLANEOUS SERVICE ARRANGEMENTS

U. TOLL TERMINAL SERVICE - CENTRAL TELEPHONE EXCHANGES ONLY (Cont'd)

2. Rates for Toll Terminal Service Trunks

Long Distance toll terminal service trunk, each, per month, are 100% of the applicable business individual line flat-rate service, as found in Section A3.

V. DIRECTORY NUMBER TRANSFER - UNITED TELEPHONE EXCHANGES

1. General

- a) This service is only available in certain exchanges and will be offered on an as available basis.
- b) Directory number transfer, where available, is an arrangement by which a subscriber to individual line service may transfer incoming calls from that line while unattended to another pre-selected individual line in the serving central office or to another central office if housed in the same building. The transfer arrangement is activated through operation of a customer-provided key or switch at the main station of the line to be switched.

GENERAL EXCHANGE TARIFF

Embarq Florida, Inc.

By: F. B. Poag  
Director

SECTION A13  
First Revised Sheet 114  
Cancelling Original Sheet 114  
Effective: January 1, 1997

MISCELLANEOUS SERVICE ARRANGEMENTS

V. DIRECTORY NUMBER TRANSFER - UNITED TELEPHONE EXCHANGES ONLY (Cont'd)

1. General (Cont'd)

c) Directory number transfer is not available in electronically controlled central offices.

2. Rates

	<u>Installation Charge</u>	<u>Monthly Rate</u>
Directory number transfer arrangement	\$ 4.00	\$ 4.17 <sup>1</sup>

Note 1: The installation charge will apply for changing lines associated with the Directory Number Transfer arrangement.

GENERAL EXCHANGE TARIFF

Embarq Florida, Inc.

By: F. B. Poag  
Director

SECTION A13  
Second Revised Sheet 115  
Cancelling First Revised Sheet 115  
Effective: September 3, 1997

MISCELLANEOUS SERVICE ARRANGEMENTS

W. EXTENSION LINE MILEAGE - United Telephone Exchanges Only

1. General

- a. Where extension lines are provided at other than the same building as the main access line, and for other circuit extensions of similar character, extension line mileage charges are applicable, in addition to the basic rates applicable to the particular service against which mileage charges are assessed.
- b. Where, for the purpose of furnishing extension lines, it is necessary to lay underground conduit or to set poles on the subscriber's premises, the subscriber may be required to provide and install such underground conduit and to provide and erect such poles, or the Company will do the work at the subscriber's expense. Where the work is performed by the subscriber, it must be in accordance with the standard specifications of the Company.
- c. When it is known or realized that the life of all or part of the outside circuit extensions will be shorter than the normal life of the plant, or the cost of providing the plant is such as to render inadequate the mileage charges quoted herein, the plant required to furnish such service will be provided on the following basis:
  - 1) The subscriber may be required to pay construction and installation charges based upon the costs incurred in addition to mileage charges.

GENERAL EXCHANGE TARIFF

Embarq Florida, Inc.

By: F. B. Poag  
Director

SECTION A13  
Second Revised Sheet 116  
Cancelling First Revised Sheet 116  
Effective: September 3, 1997

MISCELLANEOUS SERVICE ARRANGEMENTS

W. EXTENSION LINE MILEAGE - United Telephone Exchanges Only (Cont'd)

1. General (Cont'd)

- d. When the practical manner of providing necessary circuits to outside stations requiring two or more circuits per station is by means of placing cable or multi-pair drop wire specifically for this purpose, the monthly charges, as stated in 2. following, will be applicable for each circuit used.

2. Rates and Charges

- a. Where extension lines are provided between different buildings on the same premises as the main access line or between buildings on different premises (where the extension line is located on other than the same premises as the main access line), the rates are applicable as set forth in Section A20, Type 2231, Voice Grade, Local Channel of this tariff, as appropriate.

GENERAL EXCHANGE TARIFF

Embarq Florida, Inc.

By: F. B. Poag  
Director

SECTION A13  
First Revised Sheet 117  
Cancelling Original Sheet 117  
Effective: June 1, 1997

MISCELLANEOUS SERVICE ARRANGEMENTS

X. TOLL BLOCK/PAYMENT ARRANGEMENT  
(Limited service offering)

1. Customers will be provided access to the local network with toll blocking provided at no charge, when payment arrangements on the following situations are applicable:
  - a. Existing customers requiring payment arrangements
  - b. New customers who can not afford to pay a deposit
  - c. New customers who have an outstanding final bill
2. This service offering will be available in the Fort Myers End Office only and will be effective for a six-month period from June 1, 1997 to December 31, 1997.
3. At the end of the six-month period, the Company may cancel the offering with no penalty.

GENERAL EXCHANGE TARIFF

Embarq Florida, Inc.

By: F. B. Poag  
Director

SECTION A13  
Ninth Revised Sheet 118  
Cancelling Eighth Revised Sheet 118  
Effective: March 16, 2005

MISCELLANEOUS SERVICE ARRANGEMENTS

Y. PRIVACY ID

1. General

- a. Privacy ID provides Caller ID subscribers with the ability to identify unavailable, unknown, blocked and private numbers. Privacy ID intercepts all unidentified calls before the subscriber's telephone rings then asks the caller to state their name or company. Once the calling party has responded, the service rings the subscriber and announces the calling party's information. The subscriber has the option to accept the call, reject the call, play an announcement to the calling party or forward the call to voicemail.
- b. The Privacy ID subscriber may provide calling parties with a Caller's Access Code. Use of this access code allows the calling party to bypass Privacy ID.

2. Terms and Conditions

- a. Privacy ID is provided subject to availability of facilities.
- b. Privacy ID is not offered in conjunction with ISDN, Centrex, Payphone Line and PBX Service.
- c. When the Call Trace and Return Call features are activated on calls intercepted by Privacy ID, the telephone number captured is that of the Service Node, which performs Privacy ID, not the telephone number of the calling party.
- d. Caller ID Service is required in order to subscribe to Privacy ID.

3. Rates and Charges

	<u>S&amp;E Code</u>	<u>Monthly Rate</u>	
		<u>Residence</u>	<u>Business</u>
a. Privacy ID	(FPI1FLC)	\$5.25	\$5.95
b. Privacy ID is available as an add-on to Personal II Solution and Special Plan Bundle for a monthly recurring rate of \$4.00			

GENERAL EXCHANGE TARIFF

Embarq Florida, Inc.

By: F. B. Poag  
Director

SECTION A13  
Second Revised Sheet 118.1  
Cancelling First Revised Sheet 118.1  
Effective: June 5, 2001

MISCELLANEOUS SERVICE ARRANGEMENTS

RESERVED FOR FUTURE USE

GENERAL EXCHANGE TARIFF

Embarq Florida, Inc.

SECTION A13

By: F. B. Poag  
Director

Seventh Revised Sheet 119  
Cancelling Sixth Revised Sheet 119  
Effective: April 17, 2006

MISCELLANEOUS SERVICE ARRANGEMENTS

Z. TALKING CALL WAITING

1. General

- a. Talking Call Waiting allows customers to know who is calling while they are on the telephone with another party. Talking Call Waiting enhances Call Waiting by allowing the customer to hear who is calling after hearing the call waiting tone while the customer is on the line. Any and all names will be voiced to the subscriber. This includes "private" or "unavailable" to be voiced in the appropriate situation. Talking Call Waiting Service subscribers will hear both a call waiting tone plus the name of the calling party on an incoming call. The customer then presses the switch hook or flash button to place the current call on hold and talk to the call waiting party.

2. Terms and Conditions

- a. Talking Call Waiting is provided subject to availability of facilities.
- b. Talking Call Waiting is available on a monthly subscription basis. This service requires no additional adjunct or telephone display equipment.
- c. Talking Call Waiting is available to single-line business and residence customers.
- d. Talking Call Waiting is not offered in conjunction with Centrex, DID, PBX, ISDN, Pay Telephone Service or Coin Line Service.
- e. A Call Waiting Custom Calling Feature, including but not limited to, Call Waiting Service, Enhanced Call Waiting, Call Waiting Options or any package containing the Call Waiting feature, is required in order to subscribe to Talking Call Waiting Service.

3. Rates and Charges

- a. Service charges and monthly rates for exchange access lines and other services with which this service is associated apply, as appropriate.

Monthly Rate

Per Residence Line	\$2.95
Per Business Line	\$2.95

- b. Sprint Talking Call Waiting is available as an add-on to Package 5, Package 7, Ideal Solution, Sure Solution II, Sprint Home II Solution and Progressive Plan. The monthly recurring charge is \$2.00 for Residence or Business.



GENERAL EXCHANGE TARIFF

Embarq Florida, Inc.

By: F. B. Poag  
Director

SECTION A13  
Fourth Revised Sheet 120  
Cancelling Third Revised Sheet 120  
Effective: March 16, 2005

MISCELLANEOUS SERVICE ARRANGEMENTS

RESERVED FOR FUTURE USE

GENERAL EXCHANGE TARIFF

Embarq Florida, Inc.

By: F. B. Poag  
Director

SECTION A13  
Fifth Revised Sheet 121  
Cancelling Fourth Revised Sheet 121  
Effective: November 1, 2005

MISCELLANEOUS SERVICE ARRANGEMENTS

RESERVE FOR FUTURE USE

GENERAL EXCHANGE TARIFF

Embarq Florida, Inc.

SECTION A13  
Second Revised Sheet 122  
Cancelling First Revised Sheet 122  
Effective: November 1, 2005

By: F. B. Poag  
Director

MISCELLANEOUS SERVICE ARRANGEMENTS

RESERVE FOR FUTURE USE

GENERAL EXCHANGE TARIFF

Embarq Florida, Inc.

By: F. B. Poag  
Director

SECTION A13  
Second Revised Sheet 124  
Cancelling First Revised Sheet 124  
Effective: November 1, 2005

MISCELLANEOUS SERVICE ARRANGEMENTS

RESERVE FOR FUTURE USE

GENERAL EXCHANGE TARIFF

Embarq Florida, Inc.

SECTION A14  
Second Revised Contents Sheet 1  
Cancelling First Revised Sheet 1  
Effective: December 1, 1997

By: F. B. Poag  
Director

AUXILIARY EQUIPMENT  
CONTENTS

A.	TELECOMMUNICATIONS DEVICES (TDD's), HANDSETS AND SIGNALING EQUIPMENT FOR THE HEARING IMPAIRED .....	1
1.	General .....	1
2.	Rates and Charges (United Telephone exchanges only) .....	3
3.	Rates and Charges (Central Telephone exchanges only) .....	4
B.	BREAK IN ROTARY NUMBER GROUP.....	4
1.	General .....	4
2.	Rates and Charges.....	5

GENERAL EXCHANGE TARIFF

Embarq Florida, Inc.

By: F. B. Poag  
Director

SECTION A14  
First Revised Sheet 1  
Cancelling Original Sheet 1  
Effective: January 1, 1997

AUXILIARY EQUIPMENT

A. TELECOMMUNICATIONS DEVICES (TDD's), HANDSETS AND SIGNALING EQUIPMENT FOR THE HEARING IMPAIRED

1. General

- a. A telecommunications device (TDD) is a portable unit which permits a hearing impaired individual to communicate over the telephone network with other persons using compatible equipment. Handsets and signaling equipment provided in this section is of special design for use by the hearing impaired and for the most part is portable in nature.
- b. TDD units and other items are available for purchase or lease as specified below and at the rates shown in 2. following.
  - 1) Purchase - a one-time payment. The customer is responsible for all maintenance and repairs. Manufacturer's warranty, if any, applies.
    - a) Cash in full at time of purchase.
    - b) To qualifying customers, payment in full when billed on the customer's telephone bill.
  - 2) Installment Plan - Payment on an installment basis as established for a specific product in Rates following. The customer is responsible for all maintenance and repairs. Manufacturer's warranty, if any, applies.

GENERAL EXCHANGE TARIFF

Embarq Florida, Inc.

By: F. B. Poag  
Director

SECTION A14  
First Revised Sheet 2  
Cancelling Original Sheet 2  
Effective: January 1, 1997

AUXILIARY EQUIPMENT

- A. TELECOMMUNICATIONS DEVICES (TDD's), HANDSETS AND SIGNALING EQUIPMENT FOR THE HEARING IMPAIRED (Cont'd)
1. General (Cont'd)
    - b. Cont'd.
      - 3) Lease - Customer can lease with maintenance included in the monthly rate. The customer pays a recurring monthly lease rate and a recurring monthly maintenance service charge for the period the subscriber has the equipment.
    - c. The customer is responsible for the security of a leased unit. In case of loss or damage to the unit, the customer may be liable for the replacement costs as determined by the Company or as covered elsewhere in this tariff.
    - d. TDD units and other items will be ordered from the manufacturer upon purchase or lease. Delivery time will depend upon manufacturer's availability of equipment.
    - e. All other charges applicable to additional service in conjunction with equipment sold are in addition to the equipment price.

GENERAL EXCHANGE TARIFF

Embarq Florida, Inc.

By: F. B. Poag  
Director

SECTION A14  
First Revised Sheet 3  
Cancelling Original Sheet 3  
Effective: January 1, 1997

AUXILIARY EQUIPMENT

A. TELECOMMUNICATIONS DEVICES (TDD's), HANDSETS AND SIGNALING EQUIPMENT FOR THE HEARING IMPAIRED (Cont'd)

2. Rates and Charges (United Telephone exchanges only)

a. Purchase price does not include applicable sales taxes.

b. Telecommunications Devices (TDD's)

Installment Plan

	<u>Purchase Price</u>	<u>12 Months</u>	<u>24 Months</u>	<u>36 Months</u>	<u>Lease with Maintenance</u>
1) Superprint 4425 - A portable unit with 32K memory, 20-character display, GA/SK keys, relay voice announcer, TDD announcer, built-in printer with three type sizes	\$401.19	\$ 40.65	\$ 22.91	\$ 16.82	\$ 14.83
2) Handsets for Hearing Impaired - This equipment may be used with all standard instruments and is designed to amplify audible incoming voice transmission through an adjustable volume control wheel	\$ 31.76	\$ 2.65	\$ 1.33	\$ .89	\$ 1.58
3) Extension Gong - a very loud bell for people with severely impaired hearing.	\$ 20.07	\$ 1.68	\$ .84	\$ .56	\$ 1.00
4) Visual Indicator Lamp - a separately-mounted lamp that flashes on ringing current	\$ 3.45	\$ .29	\$ .15	\$ .10	\$ .16
5) Modular telephone strobe - a visual ring indicator that emits a high intensity light. AC connection required	\$ 66.70	\$ 5.56	\$ 2.78	\$ 1.86	\$ 3.32



GENERAL EXCHANGE TARIFF

Embarq Florida, Inc.

By: F. B. Poag  
Director

SECTION A14  
First Revised Sheet 4  
Cancelling Original Sheet 4  
Effective: January 1, 1997

AUXILIARY EQUIPMENT

A. TELECOMMUNICATIONS DEVICES (TDD's), HANDSETS AND SIGNALING EQUIPMENT FOR THE HEARING IMPAIRED (Cont'd)

3. Rates and Charges (Central Telephone exchanges only)

a. Prices do not include applicable sales taxes.

	<u>Purchase Price</u>	<u>Number of Installments</u>	<u>Monthly Payment</u>	<u>Monthly Lease Rate with Maintenance</u>
Ring Alert	\$ 80.58	12	\$ 7.18	\$ 3.95
Amplified Headset	45.05	12	4.21	1.43
Tone Ringer	60.60	12	5.05	3.05
Superprint 4425	401.19	12	40.65	14.83
		24	22.91	
		36	16.82	

B. BREAK IN ROTARY NUMBER GROUP

1. General

a. Break in rotary number group is an arrangement whereby certain central office lines or trunks may be temporarily removed from the rotary number group and caused to operate independently by means of a key or associated equipment at the customer's premises which, through the use of a signaling channel, operates control equipment in the central office. Private Line Channel charges for the signaling channel shall apply in addition to the rates listed following.

GENERAL EXCHANGE TARIFF

Embarq Florida, Inc.

By: F. B. Poag  
Director

SECTION A14  
First Revised Sheet 5  
Cancelling Original Sheet 5  
Effective: January 1, 1997

AUXILIARY EQUIPMENT

B. BREAK IN ROTARY NUMBER GROUP

1. General (Cont'd)

b. This service is not available in all United Telephone exchanges and, therefore, will be provided on a where available basis.

2. Rates and Charges

	<u>NRC</u>	<u>Monthly Rates</u>
a. Common equipment at the customer's premises and in the central office, including key to control up to the first ten lines		
Central Telephone exchanges only	\$30.00	\$ 9.45
United Telephone exchanges only	n/c	13.75
b. For each additional ten lines or fraction thereof		
Central Telephone exchanges only	n/c	6.60
United Telephone exchanges only	n/c	9.55
c. Change in point of break in rotary number groups or relocation of equipment on customer premises		
Central Telephone exchanges only	n/c	n/c
United Telephone exchanges only	\$ 3.50	n/c

GENERAL EXCHANGE TARIFF

Embarq Florida, Inc.

By: F. B. Poag  
Director

SECTION A14  
First Revised Sheet 6  
Cancelling Original Sheet 6  
Effective: January 1, 1997

AUXILIARY EQUIPMENT

B. BREAK IN ROTARY NUMBER GROUP (Cont'd)

2. Rates and Charges (Cont'd)

d. Signaling Channel

Rates as specified in Private  
Line section of this tariff

e. A Five Year Basic Termination Charge is applicable to United Telephone exchanges only -- for a. preceding it is \$280.00 and for b. preceding it is \$200.00.

GENERAL EXCHANGE TARIFF

Embarq Florida, Inc.

SECTION A15

By: F.B. Poag  
Director

First Revised Contents Sheet 1  
Cancelling Original Contents Sheet 1  
Effective: January 1, 1997

CONNECTIONS OF CUSTOMER-PROVIDED TERMINAL  
EQUIPMENT AND COMMUNICATIONS SYSTEMS

CONTENTS

A.	REGULATIONS .....	1
1.	General Provisions .....	1
2.	Connections of Registered Equipment.....	10
3.	Connections of Grandfathered Terminal Equipment and Grandfathered Communications Systems .....	18
4.	Acoustic or Inductive Connections .....	34
5.	Connections of Customer-Provided Communications Systems Not Subject to Part 68 of FCC Rules and Regulations.....	37
6.	Connections of Customer-Provided Terminal Equipment Specifically Exempted from the FCC Registration Program .....	38
7.	Connections of Certain Facilities of Power, Pipe Line, and Railroad Companies .....	39
8.	Connections of Certain Facilities of the National Aeronautics and Space Administration .....	43
9.	Connections of Certain Facilities of the U.S. Army, Navy, and Air Force .....	44
10.	Connections of Customer-Provided Station Lines and Facilities in Hazardous or Inaccessible Locations .....	46
11.	U. S. Coast Guard and U. S. Army National Guard .....	46

GENERAL EXCHANGE TARIFF

Embarq Florida, Inc.

By: F.B. Poag  
Director

SECTION A15  
First Revised Contents Sheet 2  
Cancelling Original Contents Sheet 2  
Effective: January 1, 1997

CONNECTIONS OF CUSTOMER-PROVIDED TERMINAL  
EQUIPMENT AND COMMUNICATIONS SYSTEMS

CONTENTS

B.	CUSTOMER-PROVIDED TERMINAL EQUIPMENT .....	47
1.	Data Transmitting and/or Receiving Terminal Equipment.....	47
2.	Rates and Charges.....	49
3.	U.S. Government Executive Departments and Agencies .....	49
4.	Connection of Customer-Provided Voice Transmitting/- Receiving Terminal Equipment for Recording of Telephone Conversations.....	50
5.	Alarm Detection and Reporting Equipment .....	51

GENERAL EXCHANGE TARIFF

Embarq Florida, Inc.

By: F.B. Poag  
Director

SECTION A15  
First Revised Sheet 1  
Cancelling Original Sheet 1  
Effective: January 1, 1997

CONNECTIONS OF CUSTOMER-PROVIDED TERMINAL  
EQUIPMENT AND COMMUNICATIONS SYSTEMS

A. REGULATIONS

1. General Provisions

a. General

Terminal equipment and communications systems provided by the customer may be connected at the customer's premises to telecommunications services furnished by the Company where such connections are made in accordance with the provisions of this section. Telecommunications services as used herein include exchange service, Long Distance Message Telecommunications Service (LDMTS), and Wide Area Telecommunications Service (WATS).

b. Responsibility of the Customer

- 1) The customer shall be responsible for the installation, operation, and maintenance of any customer-provided terminal equipment or communications systems. No combination of customer-provided terminal equipment or communications systems shall require change in or alteration of the equipment or services of the Company, cause electrical hazards to Company personnel, damage to Company equipment, malfunction of Company billing equipment, or degradation of service to persons other than the user of the subject terminal equipment or communications system, his calling or called party. Upon notice from the Company that a customer-provided terminal equipment or communications system is causing such hazard, damage, malfunction, or degradation of service, the customer shall make such changes as shall be necessary to remove or prevent such hazard, damage, malfunction, or degradation of service.

GENERAL EXCHANGE TARIFF

Embarq Florida, Inc.

By: F.B. Poag  
Director

SECTION A15  
First Revised Sheet 2  
Cancelling Original Sheet 2  
Effective: January 1, 1997

CONNECTIONS OF CUSTOMER-PROVIDED TERMINAL  
EQUIPMENT AND COMMUNICATIONS SYSTEMS

A. REGULATIONS (Cont'd)

1. General Provisions (Cont'd)

b. Responsibility of the Customer (Cont'd)

- 2) The customer shall be responsible for the payment of a Trouble Location Charge as covered in Section A4 of this tariff, for visits by a Company employee to the customer's premises when a service difficulty or trouble report results from the use of customer-provided terminal equipment or communications system.

c. Responsibility of the Company

- 1) Telecommunications services are not represented as adapted to the use of customer-provided terminal equipment or communications systems. Where customer-provided terminal equipment or communications systems are used with telecommunications services, the responsibility of the Company shall be limited to the furnishing of service components suitable for telecommunications services and to the maintenance and operation of service components in a manner proper for such services. Subject to this responsibility the Company shall not be responsible for (1) the through transmission of signals generated by the Customer-provided terminal equipment or communications systems or for the quality of, or defects in, such transmission, or (2) the reception of signals by customer-provided terminal equipment or communications systems, or (3) address signaling where such signaling is performed by customer-provided signaling equipment.

GENERAL EXCHANGE TARIFF

Embarq Florida, Inc.

By: F.B. Poag  
Director

SECTION A15  
First Revised Sheet 3  
Cancelling Original Sheet 3  
Effective: January 1, 1997

CONNECTIONS OF CUSTOMER-PROVIDED TERMINAL  
EQUIPMENT AND COMMUNICATIONS SYSTEMS

A. REGULATIONS (Cont'd)

1. General Provisions (Cont'd)

c. Responsibility of the Company (Cont'd)

- 2) The Company will, at the customer's request, provide information concerning interface parameters, including the number of ringers which may be connected to a particular telephone line, needed to permit customer-provided terminal equipment to operate in a manner compatible with telecommunications services.
- 3) The Company may make changes in its telecommunications services, equipment, operations or procedures, where such action is consistent with Part 68 of the Federal Communications Commission's Rules and Regulations. If such changes can be reasonably expected to render any customer's terminal equipment or communications system incompatible with telecommunications services, or require modification or alteration of such customer-provided terminal equipment or communications systems, or otherwise materially affect its use or performance, the customer will be given adequate notice, in writing, to allow the customer an opportunity to maintain uninterrupted service.



GENERAL EXCHANGE TARIFF

Embarq Florida, Inc.

By: F.B. Poag  
Director

SECTION A15  
First Revised Sheet 4  
Cancelling Original Sheet 4  
Effective: January 1, 1997

CONNECTIONS OF CUSTOMER-PROVIDED TERMINAL  
EQUIPMENT AND COMMUNICATIONS SYSTEMS

A. REGULATIONS (Cont'd)

1. General Provisions (Cont'd)

d. Recording of Telephone Conversations

Telecommunications services furnished by the Company are not represented as adapted to the recording of telephone conversations. However, when customer-provided voice recording equipment is directly, acoustically or inductively connected with telecommunications services, the customer-provided voice recording equipment shall be so arranged that at the will of the user, it can be activated or deactivated. In addition, the following condition must apply.

- 1) All parties to the telephone conversation must give their prior consent to the recording of the conversation and the prior consent must be obtained in writing or be part of, and obtained at the start of the recording.
- 2) Requirements for the condition as specified in 1.d.1) preceding are not required:
  - a) When used by a Federal Communications Commission licensed broadcast station customer for recording of telephone conversations solely for broadcast over the air.

GENERAL EXCHANGE TARIFF

Embarq Florida, Inc.

By: F.B. Poag  
Director

SECTION A15  
First Revised Sheet 5  
Cancelling Original Sheet 5  
Effective: January 1, 1997

CONNECTIONS OF CUSTOMER-PROVIDED TERMINAL  
EQUIPMENT AND COMMUNICATIONS SYSTEMS

A. REGULATIONS (Cont'd)

1. General Provisions (Cont'd)

d. Recording of Telephone Conversations

2) (Cont'd)

- b) When used by the United States Secret Service of the Department of Treasury for recording of telephone conversations which concern the safety and security of the person of the President of the United States, members of his immediate family, or the White House and its grounds.
- c) When used by a broadcast network or by a cooperative programming effort composed exclusively of Federal Communications Commission broadcast licensees to record telephone conversations solely for broadcast over the air by a licensed broadcast station.
- d) When used for recording at United States Department of Defense Command Centers of emergency communications transmitted over the Department of Defense's private line system when connected to telecommunications services.
- e) When used for incoming calls made to telephone numbers publicized for emergencies (such as, but not limited to, fire, health care and police) and outgoing calls made in immediate response.

GENERAL EXCHANGE TARIFF

Embarq Florida, Inc.

By: F.B. Poag  
Director

SECTION A15  
First Revised Sheet 6  
Cancelling Original Sheet 6  
Effective: January 1, 1997

CONNECTIONS OF CUSTOMER-PROVIDED TERMINAL  
EQUIPMENT AND COMMUNICATIONS SYSTEMS

A. REGULATIONS (Cont'd)

1. General Provisions (Cont'd)

d. Recording of Telephone Conversations

2) (Cont'd)

- f) When used by the United States Nuclear Regulatory Commission of the Department of Energy with respect to the telephone systems located at its Operations Center for recording of telephone conversations.
- g) When used by an automatic telephone answering service known by the general public to record telephone messages for its subscribers.
- h) When used for the recording of calls made for patently unlawful purposes, such as bomb threats, kidnap ransom requests, and obscene telephone calls and outgoing calls made in immediate response.
- i) When used by federal, state or local law enforcement authorities acting under color of law.

GENERAL EXCHANGE TARIFF

Embarq Florida, Inc.

By: F.B. Poag  
Director

SECTION A15  
First Revised Sheet 7  
Cancelling Original Sheet 7  
Effective: January 1, 1997

CONNECTIONS OF CUSTOMER-PROVIDED TERMINAL  
EQUIPMENT AND COMMUNICATIONS SYSTEMS

A. REGULATIONS (Cont'd)

1. General Provisions (Cont'd)

e. Violation of Regulations

When any customer-provided terminal equipment or communications system is used with telecommunications services in violation of any of the provisions in this section, the Company will take such immediate action as necessary for the protection of the telecommunications network and Company employees, and will promptly notify the Customer of the violation.

The customer shall discontinue such use of the terminal equipment or communications system or correct the violation and shall confirm in writing to the Company within 10 days, following the receipt of written notice from the Company, that such use has ceased or that the violation has been corrected. Failure of the customer to discontinue such use or to correct the violation and to give the required written confirmation to the Company within the time stated above shall result in suspension of the customer's service until such time as the customer complies with the provisions of this tariff.

GENERAL EXCHANGE TARIFF

Embarq Florida, Inc.

By: F.B. Poag  
Director

SECTION A15  
First Revised Sheet 8  
Cancelling Original Sheet 8  
Effective: January 1, 1997

CONNECTIONS OF CUSTOMER-PROVIDED TERMINAL  
EQUIPMENT AND COMMUNICATIONS SYSTEMS

A. REGULATIONS (Cont'd)

1. General Provisions (Cont'd)

f. Definitions

Grandfathered Connections of Communications Systems

The term "Grandfathered Connections of Communications Systems" as used in this section denotes connections via Company-provided connecting arrangements of customer-provided communications systems (including their equipment and premises wiring) at the customer's premises, in accordance with any telephone company's tariffs, and that are considered to be grandfathered under Part 68 of the Federal Communications Commission's Rules and Regulations because such connections to the Telecommunications network are made via Company-provided connecting arrangements prior to January 1, 1980, and such connecting arrangements are of a type of connecting arrangement connected to the telecommunications network as of June 1, 1978.

Grandfathered Communications Systems

The term "Grandfathered Communications Systems" as used in this section denotes customer-provided communications systems (including their equipment, premises wiring and protective circuitry if any) connected at the customer's premises, in

GENERAL EXCHANGE TARIFF

Embarq Florida, Inc.

By: F.B. Poag  
Director

SECTION A15  
First Revised Sheet 9  
Cancelling Original Sheet 9  
Effective: January 1, 1997

CONNECTIONS OF CUSTOMER-PROVIDED TERMINAL  
EQUIPMENT AND COMMUNICATIONS SYSTEMS

A. REGULATIONS (Cont'd)

1. General Provisions (Cont'd)

f. Definitions

Grandfathered Connections of Communications Systems (Cont'd)

accordance with any telephone Company's tariffs, and that are considered to be grandfathered under Part 68 of the Federal Communications Commission's Rules and Regulations because such systems are connected to the telecommunications network prior to January 1, 1980, and are of a type of system which was directly connected (i.e., without Telephone Company-provided connecting arrangements) to the telecommunications network as of June 1, 1978.

Grandfathered Terminal Equipment

The term "Grandfathered Terminal Equipment" as used in this section denotes customer-provided terminal equipment (including protective circuitry if any) connected at the customer's premises in accordance with any telephone company's tariffs, and that is considered to be grandfathered under Part 68 of the Federal Communications Commission's Rules and Regulations because such terminal equipment was connected to the telecommunications network prior to July 1, 1979, and is of a type of terminal equipment which was directly connected i.e., without Company-provided connecting arrangements) to the telecommunications network as of October 17, 1977.

GENERAL EXCHANGE TARIFF

Embarq Florida, Inc.

By: F.B. Poag  
Director

SECTION A15  
First Revised Sheet 10  
Cancelling Original Sheet 10  
Effective: January 1, 1997

CONNECTIONS OF CUSTOMER-PROVIDED TERMINAL  
EQUIPMENT AND COMMUNICATIONS SYSTEMS

A. REGULATIONS (Cont'd)

1. General Provisions (Cont'd)

f. Definitions (Cont'd)

Grandfathered Connections of Terminal Equipment

The term "Grandfathered Connections of Terminal Equipment" as used in this section denotes connections via Company-provided terminal equipment connected at the Customer's premises., in accordance with any telephone company's tariffs, and that are considered to be grandfathered under Part 68 of the Federal Communications Commission's Rules and Regulations because such connections to the telecommunications network were made via Company-provided connecting arrangements connected to the telecommunications network as of October 17, 1977.

Registered Equipment

The term "Registered Equipment" as used in this section denotes equipment which complies and has been approved within the Registration provisions of Part 68 of the Federal Communications Commission's Rules and Regulations.

2. Connections of Registered Equipment

- a. Customer-provided Registered Terminal Equipment, Registered Protective Circuitry and Registered Communications systems.

GENERAL EXCHANGE TARIFF

Embarq Florida, Inc.

By: F.B. Poag  
Director

SECTION A15  
First Revised Sheet 11  
Cancelling Original Sheet 11  
Effective: January 1, 1997

CONNECTIONS OF CUSTOMER-PROVIDED TERMINAL  
EQUIPMENT AND COMMUNICATIONS SYSTEMS

A. REGULATIONS (Cont'd)

2. Connections of Registered Equipment (Cont'd)

a. (Cont'd)

Customer-provided registered terminal equipment, registered protective circuitry, and registered communications systems may be directly connected at the customer's premises or designated PATS location to the telecommunications network, subject to Part 68 of the Federal Communications Rules and Regulations, A.1. preceding and the following:

- 1) All combinations of registered equipment and associated non-registered terminal equipment (including but not limited to wiring) shall be installed, operated, and maintained so that the requirements of Part 68 of the Federal Communications Commissions' Rules and Regulations are continually satisfied.

The Company may discontinue service or impose other remedies as provided for in Part 68 of the Federal Communications Commissions' Rules and Regulations for failure to comply with these provisions.

- 2) The customer shall notify the Company of each line to which registered equipment is to be connected in advance of such connection and shall notify the Company when such registered equipment is permanently disconnected. The customer shall provide the Company the Registration Number for the registered equipment.



GENERAL EXCHANGE TARIFF

Embarq Florida, Inc.

By: F.B. Poag  
Director

SECTION A15  
First Revised Sheet 12  
Cancelling Original Sheet 12  
Effective: January 1, 1997

CONNECTIONS OF CUSTOMER-PROVIDED TERMINAL  
EQUIPMENT AND COMMUNICATIONS SYSTEMS

A. REGULATIONS (Cont'd)

2. Connections of Registered Equipment (Cont'd)

a. (Cont'd)

- 3) The customer shall not connect registered equipment to a company Line, if:
  - a) The Ringer Equivalence of such equipment in combination with the total Ringer Equivalence of other equipment connected to the same line exceeds the allowable maximum of five or otherwise determined by the Company, or
  - b) The ringer is not a ringer type designated by the Company as suitable for that particular line.
- 4) Except as otherwise provided in 5) following, all connections of registered equipment to services furnished by the Company shall be made through standard network interface devices; or, in the case of registered communications systems, through standard network interface devices wired in other than a standard manner, when nonstandard wiring is agreed to by the Company.
- 5) Registered equipment which is in hazardous or inaccessible locations may, in lieu of 4) preceding, be connected in accordance with A.10. following.

GENERAL EXCHANGE TARIFF

Embarq Florida, Inc.

By: F.B. Poag  
Director

SECTION A15  
First Revised Sheet 13  
Cancelling Original Sheet 13  
Effective: January 1, 1997

CONNECTIONS OF CUSTOMER-PROVIDED TERMINAL  
EQUIPMENT AND COMMUNICATIONS SYSTEMS

A. REGULATIONS (Cont'd)

2. Connections of Registered Equipment (Cont'd)

a. (Cont'd)

6) Such telecommunications service or customer-provided communications system is utilized for the origination or termination or communications at the customer's premises where the connection is made.

b. Premises Wiring Associated with Registered Communications Systems

1) Premises Wiring is wiring which connects separately-housed equipment entities or system components to one another, or wiring which connects an equipment entity or system component with the telephone network interface, located at the customer's premises and not within an equipment housing.

a) Fully-Protected Premises Wiring is premises wiring which is:

(1) No greater than 25 feet in length (measured linearly between the point where it leaves equipment or connector housings) and registered as a component of and supplied to the user with the registered terminal equipment or protective circuitry with which it is to be used.

GENERAL EXCHANGE TARIFF

Embarq Florida, Inc.

By: F.B. Poag  
Director

SECTION A15  
First Revised Sheet 14  
Cancelling Original Sheet 14  
Effective: January 1, 1997

CONNECTIONS OF CUSTOMER-PROVIDED TERMINAL  
EQUIPMENT AND COMMUNICATIONS SYSTEMS

A. REGULATIONS (Cont'd)

2. Connections of Registered Equipment (Cont'd)

b. Premises Wiring Associated with Registered Communications Systems (Cont'd)

1) (Cont'd)

a) (Cont'd)

- (2) A cord which complies with 1) preceding and which is extended once by a registered extension cord, Extension cords may not be used as a substitute for wiring which for safety reasons should be affixed to or embedded in a building's structure.
- (3) Wiring located in an equipment room with restricted access, provided that this wiring remains exposed for inspection and is not concealed or embedded in the building's structure, and that it conforms to Part 68 of the Federal Communications Commission's Rules and Regulations.
- (4) Electrically behind registered equipment, system components, or protective circuitry which assure that electrical contact between the wiring and commercial power wiring or earth ground will not result in hazardous voltages or excessive longitudinal imbalance at the telephone network interface.

GENERAL EXCHANGE TARIFF

Embarq Florida, Inc.

By: F.B. Poag  
Director

SECTION A15  
First Revised Sheet 15  
Cancelling Original Sheet 15  
Effective: January 1, 1997

CONNECTIONS OF CUSTOMER-PROVIDED TERMINAL  
EQUIPMENT AND COMMUNICATIONS SYSTEMS

A. REGULATIONS (Cont'd)

2. Connections of Registered Equipment (Cont'd)

b. Premises Wiring Associated with Registered Communications Systems (Cont'd)

1) (Cont'd)

(b) Protected Premises Wiring Requiring Acceptance Testing for Imbalance is premises wiring which is electrically behind registered equipment, system components or circuitry which assure that electrical contact between the wiring and commercial power wiring will not result in hazardous voltages at the telephone network interface.

(c) Unprotected Premises Wiring is all other premises wiring.

2) Customers who intend to connect premises wiring other than Fully-Protected Premises Wiring to the telephone network shall give advance notice to the Company in accordance with the procedures specified in Part 68 of the Federal Communication's Rules and Regulations or as otherwise authorized by the Federal Communications Commission.

GENERAL EXCHANGE TARIFF

Embarq Florida, Inc.

By: F.B. Poag  
Director

SECTION A15  
First Revised Sheet 16  
Cancelling Original Sheet 16  
Effective: January 1, 1997

CONNECTIONS OF CUSTOMER-PROVIDED TERMINAL  
EQUIPMENT AND COMMUNICATIONS SYSTEMS

A. REGULATIONS (Cont'd)

2. Connections of Registered Equipment (Cont'd)

b. Premises Wiring Associated with Registered Communications Systems (Cont'd)

3) The Company may invoke extraordinary procedures specified in Part 68 of the Federal Communications Commission's Rules and Regulations where one or more of the following conditions are present:

- (a) Advance notice information provided in accordance with A.2.b.2) preceding gives reason to believe that a violation of Part 68 of the Federal Communications Commission's Rules and Regulations is likely.
- (b) A failure has occurred during acceptance testing for imbalance.
- (c) Harm has occurred, and there is reason to believe that this harm was a result of wiring operations performed under Part 68 of the Federal Communications Commission's Rules and Regulations.

In addition, the Company may monitor or participate in acceptance testing for imbalance, or may inspect other than Fully-Protected Premises Wiring installations as set forth in Part 68 of the Federal Communications Rules and Regulations.

GENERAL EXCHANGE TARIFF

Embarq Florida, Inc.

By: F.B. Poag  
Director

SECTION A15  
First Revised Sheet 17  
Cancelling Original Sheet 17  
Effective: January 1, 1997

CONNECTIONS OF CUSTOMER-PROVIDED TERMINAL  
EQUIPMENT AND COMMUNICATIONS SYSTEMS

A. REGULATIONS (Cont'd)

2. Connections of Registered Equipment (Cont'd)

c. Connections Involving National Defense and Security

- 1) In certain cases Part 68 of the Federal Communications Commission's Rules and Regulations permit the connection of non-registered terminal equipment or communications systems to the telecommunications network, provided that:
  - a) The Secretary of Defense; the head of any other governmental department (having requisite Federal Communications Commission approval); or their authorized representative certifies in writing to the Company that:
    - (1) The connection is required in the interest of the national defense and security;
    - (2) The equipment to be connected either complies with the technical requirements of Part 68, or will not cause harm to the telecommunications network or Company employees; and
    - (3) The work is supervised by an installation supervisor who meets the qualifications stated in Part 68.

GENERAL EXCHANGE TARIFF

Embarq Florida, Inc.

By: F.B. Poag  
Director

SECTION A15  
First Revised Sheet 18  
Cancelling Original Sheet 18  
Effective: January 1, 1997

CONNECTIONS OF CUSTOMER-PROVIDED TERMINAL  
EQUIPMENT AND COMMUNICATIONS SYSTEMS

A. REGULATIONS (Cont'd)

3. Connections of Grandfathered Terminal Equipment and Grandfathered Communications Systems

a. Direct Connections

1) Grandfathered Terminal Equipment

Grandfathered terminal equipment may remain directly connected and be moved and reconnected to the telecommunications network for the life of the equipment without registration and may be modified only in accordance with Part 68 of the Federal Communications Commission's Rules and Regulations, subject to the following:

- a) The customer shall notify the Company when such grandfathered terminal equipment is to be connected and shall notify the Company when such grandfathered terminal equipment is to be permanently disconnected; such notification shall include a description of the equipment including the manufacturer's name, model number, and type of equipment;
- b) All such connections are made through a standard network interface.
- c) All such connections shall comply with the minimum protection criteria set forth in A.3.c. following.

GENERAL EXCHANGE TARIFF

Embarq Florida, Inc.

By: F.B. Poag  
Director

SECTION A15  
First Revised Sheet 19  
Cancelling Original Sheet 19  
Effective: January 1, 1997

CONNECTIONS OF CUSTOMER-PROVIDED TERMINAL  
EQUIPMENT AND COMMUNICATIONS SYSTEMS

A. REGULATIONS (Cont'd)

3. Connections of Grandfathered Terminal Equipment and Grandfathered Communications Systems (Cont'd)

a. Direct Connections (Cont'd)

2) Grandfathered Communications Systems

a) Grandfathered communications systems, directly connected to the telecommunications network on June 1, 1978, may remain connected for the life of the equipment without registration, and may be modified only in accordance with Part 68 of the Federal Communications Commission's Rules and Regulations, subject to the following:

(1) All such connections shall comply with the minimum protection criteria set forth in A.3.c following.

(2) No changes may be made to equipment so connected except by the manufacturer thereof, or a duly authorized agent of the manufacturer.

b) Until January 1, 1980, new installations of communications systems of a type which have been grandfathered may be connected to the telecommunications network, subject to the following:



GENERAL EXCHANGE TARIFF

Embarq Florida, Inc.

By: F.B. Poag  
Director

SECTION A15  
First Revised Sheet 20  
Cancelling Original Sheet 20  
Effective: January 1, 1997

CONNECTIONS OF CUSTOMER-PROVIDED TERMINAL  
EQUIPMENT AND COMMUNICATIONS SYSTEMS

A. REGULATIONS (Cont'd)

3. Connections of Grandfathered Terminal Equipment and Grandfathered Communications Systems (Cont'd)

a. Direct Connections (Cont'd)

2) Grandfathered Communications Systems

b) (Cont'd)

- (1) The customer shall notify the Company when such communications systems are to be connected and shall notify the Company when such communications systems are to be permanently disconnected; such notification shall include a description of the equipment including the manufacturer's name, model number, and type of equipment;
- (2) All such connections are made through a standard network interface.
- (3) All such connections shall comply with the minimum protection criteria set forth in A.3.c following; and,
- (4) No changes may be made to equipment so connected except by the manufacturer thereof, or a duly authorized agent of the manufacturer.

GENERAL EXCHANGE TARIFF

Embarq Florida, Inc.

By: F.B. Poag  
Director

SECTION A15  
First Revised Sheet 21  
Cancelling Original Sheet 21  
Effective: January 1, 1997

CONNECTIONS OF CUSTOMER-PROVIDED TERMINAL  
EQUIPMENT AND COMMUNICATIONS SYSTEMS

A. REGULATIONS (Cont'd)

3. Connections of Grandfathered Terminal Equipment and Grandfathered Communications Systems (Cont'd)

a. Direct Connections (Cont'd)

2) Grandfathered Communications Systems (Cont'd)

c) Additions to systems specified in (1) and (2) preceding may be made:

- (1) Until January 1, 1980, where the equipment being added is of a type which has been grandfathered and
- (2) After January 1, 1980, where the equipment being added is grandfathered.

Such additions are subject to the provisions of b) (1) through (4) preceding. Additions to grandfathered equipment of registered equipment are subject to A.2. preceding.

- d) Systems connected pursuant to a) through c) preceding may remain connected and be moved and reconnected to the telecommunications network, in accordance with b) (1) through (5) preceding, for the life of the equipment and may be modified only in accordance with Part 68 of the Federal Communications Commission's Rules and Regulations.

GENERAL EXCHANGE TARIFF

Embarq Florida, Inc.

By: F.B. Poag  
Director

SECTION A15  
First Revised Sheet 22  
Cancelling Original Sheet 22  
Effective: January 1, 1997

CONNECTIONS OF CUSTOMER-PROVIDED TERMINAL  
EQUIPMENT AND COMMUNICATIONS SYSTEMS

A. REGULATIONS (Cont'd)

3. Connections of Grandfathered Terminal Equipment and Grandfathered Communications Systems (Cont'd)
  - a. Direct Connections (Cont'd)
    - 2) Grandfathered Communications Systems (Cont'd)
      - e) Such telecommunications service or customer-provided communications system is utilized for the origination or termination of communications at the customer's premises where the connection is made.
    - 3) Customer-provided terminal equipment and customer-provided communications systems connected to the telecommunications network via customer-provided grandfathered protective circuitry are subject to the provisions of 1) and 2) preceding.

GENERAL EXCHANGE TARIFF

Embarq Florida, Inc.

By: F.B. Poag  
Director

SECTION A15  
First Revised Sheet 23  
Cancelling Original Sheet 23  
Effective: January 1, 1997

CONNECTIONS OF CUSTOMER-PROVIDED TERMINAL  
EQUIPMENT AND COMMUNICATIONS SYSTEMS

A. REGULATIONS (Cont'd)

3. Connections of Grandfathered Terminal Equipment and Grandfathered Communications Systems (Cont'd)

b. Connections Through Connecting Arrangements Provided by the Company

1) General

a) Basis of Connection

- (1) Grandfathered connections of terminal equipment and grandfathered connections of communications systems made in accordance with A.3.b. 2) and 3) following respectively may remain connected and be moved and reconnected for the life of the equipment and may be modified only in accordance with Part 68 of the Federal Communications Commission's Rules and Regulations. Connecting arrangements used for such moves and reconnections will continue to be provided by the Company subject to their availability at the rates and charges specified in A115 following.
- (2) Until January 1, 1980, the Company will provide connecting arrangements, in accordance with A.3.b.3) following, for installations of new communications systems which are subject to Part 68 of the Federal Communications Commission's Rules and Regulations.

GENERAL EXCHANGE TARIFF

Embarq Florida, Inc.

By: F.B. Poag  
Director

SECTION A15  
First Revised Sheet 24  
Cancelling Original Sheet 24  
Effective: January 1, 1997

CONNECTIONS OF CUSTOMER-PROVIDED TERMINAL  
EQUIPMENT AND COMMUNICATIONS SYSTEMS

A. REGULATIONS (Cont'd)

3. Connections of Grandfathered Terminal Equipment and Grandfathered Communications Systems (Cont'd)

b. Connections Through Connecting Arrangements Provided by the Company (Cont'd)

1) General (Cont'd)

a) Basis of Connection (Cont'd)

- (3) Until January 1, 1980, the Company will provide connecting arrangements in accordance with the provisions of section A.1. for installations of new customer-provided devices or system components connected at the customer's premises to terminal equipment or communications systems provided by the Company (that is, equipment-to-equipment connections). Equipment-to-equipment connections made prior to January 1, 1980, may remain connected and be moved and reconnected for the life of such devices or system components (and may be modified only in accordance with Part 68 of the Federal Communications Commission's Rules and Regulations), or for the life of the Company-provided terminal equipment or communications system.

GENERAL EXCHANGE TARIFF

Embarq Florida, Inc.

By: F.B. Poag  
Director

SECTION A15  
First Revised Sheet 25  
Cancelling Original Sheet 25  
Effective: January 1, 1997

CONNECTIONS OF CUSTOMER-PROVIDED TERMINAL  
EQUIPMENT AND COMMUNICATIONS SYSTEMS

A. REGULATIONS (Cont'd)

3. Connections of Grandfathered Terminal Equipment and Grandfathered Communications Systems (Cont'd)

b. Connections Through Connecting Arrangements Provided by the Company (Cont'd)

1) General (Cont'd)

a) Basis of Connection (Cont'd)

(3) (Cont'd)

Connecting arrangements used for reconnection of such customer-provided devices or system components will continue to be provided by the Company, subject to their availability, at the rates and charges specified in A115 following:

- (4) Customer-provided communications systems which are not subject to Part 68 of the Federal Communications Commission's Rules and Regulations may be connected in accordance with A.7 following. Company-provided connecting arrangements are furnished for the connection of such systems at the rates and charges specified in A115 following.

GENERAL EXCHANGE TARIFF

Embarq Florida, Inc.

By: F.B. Poag  
Director

SECTION A15  
First Revised Sheet 26  
Cancelling Original Sheet 26  
Effective: January 1, 1997

CONNECTIONS OF CUSTOMER-PROVIDED TERMINAL  
EQUIPMENT AND COMMUNICATIONS SYSTEMS

A. REGULATIONS (Cont'd)

3. Connections of Grandfathered Terminal Equipment and Grandfathered Communications Systems (Cont'd)

b. Connections Through Connecting Arrangements Provided by the Company (Cont'd)

1) General (Cont'd)

a) Basis of Connection (Cont'd)

(5) Customer-provided terminal equipment may be connected in accordance with A.8 following to services of the Company specifically exempted from the Federal Communications Commission's Registration Program. Company-provided connecting arrangements are furnished for the connection of such equipment at the rates and charges specified in A115 following.

(6) Separate, identifiable, and discrete protective circuitry (i.e., connecting arrangements) used for grandfathered connections of communications systems to the telecommunications network may be removed or replaced with apparatus of lesser protective function, provided that any equipment whose classification is changed thereby, conforms to Part 68 of the Federal Communications Commission's Rules and Regulations.

GENERAL EXCHANGE TARIFF

Embarq Florida, Inc.

By: F.B. Poag  
Director

SECTION A15  
Second Revised Sheet 27  
Cancelling First Revised Sheet 27  
Effective: March 1, 2003

CONNECTIONS OF CUSTOMER-PROVIDED TERMINAL  
EQUIPMENT AND COMMUNICATIONS SYSTEMS

A. REGULATIONS (Cont'd)

3. Connections of Grandfathered Terminal Equipment and Grandfathered Communications Systems (Cont'd)

b. Connections Through Connecting Arrangements Provided by the Company (Cont'd)

1) General (Cont'd)

b) Network Control Signaling

Network control signaling shall be performed by equipment furnished, installed, and maintained by the Company, except that:

- 1) Signaling functions may be performed by customer-provided Conforming Answering Devices.



GENERAL EXCHANGE TARIFF

Embarq Florida, Inc.

By: F.B. Poag  
Director

SECTION A15  
First Revised Sheet 28  
Cancelling Original Sheet 28  
Effective: January 1, 1997

CONNECTIONS OF CUSTOMER-PROVIDED TERMINAL  
EQUIPMENT AND COMMUNICATIONS SYSTEMS

A. REGULATIONS (Cont'd)

3. Connections of Grandfathered Terminal Equipment and Grandfathered Communications Systems (Cont'd)

b. Connections Through Connecting Arrangements Provided by the Company (Cont'd)

2) Grandfathered Connections of Terminal Equipment

a) Data Terminal Equipment

Subject to the provisions of 1)a)(1) and (5) preceding, customer-provided data terminal equipment (including telephotograph equipment) may be connected at the customer's premises to the telecommunications network through a network control signaling unit and a data access arrangement provided by the Company in accordance with the following:

- (1) The customer shall furnish the equipment which performs the functions of:

Conditioning the data signals generated by the customer-provided terminal equipment to signals suitable for transmission by means of Company services, and

Conditioning signals transmitted by means of Company services to data signals suitable for reception by customer-provided equipment.

GENERAL EXCHANGE TARIFF

Embarq Florida, Inc.

By: F.B. Poag  
Director

SECTION A15  
First Revised Sheet 29  
Cancelling Original Sheet 29  
Effective: January 1, 1997

CONNECTIONS OF CUSTOMER-PROVIDED TERMINAL  
EQUIPMENT AND COMMUNICATIONS SYSTEMS

A. REGULATIONS (Cont'd)

3. Connections of Grandfathered Terminal Equipment and Grandfathered Communications Systems (Cont'd)

b. Connections Through Connecting Arrangements Provided by the Company (Cont'd)

2) Grandfathered Connections of Terminal Equipment

a) Data Terminal Equipment (Cont'd)

(2) The customer-provided data terminal equipment must comply with the minimum protection criteria specified in A.3.c. following.

(3) Where a data access arrangement is furnished in connection with customer-provided terminal equipment and such terminal equipment is used for both voice and data communication, the data access arrangement may be used to connect the customer-provided terminal equipment for voice communication.

b) Voice Terminal Equipment

Subject to the provisions of (1)a) (1) and (5) preceding customer provided voice terminal equipment may be connected at the customer's premises to the telecommunications network in accordance with the following:

GENERAL EXCHANGE TARIFF

Embarq Florida, Inc.

By: F.B. Poag  
Director

SECTION A15  
First Revised Sheet 30  
Cancelling Original Sheet 30  
Effective: January 1, 1997

CONNECTIONS OF CUSTOMER-PROVIDED TERMINAL  
EQUIPMENT AND COMMUNICATIONS SYSTEMS

A. REGULATIONS (Cont'd)

3. Connections of Grandfathered Terminal Equipment and  
Grandfathered Communications Systems (Cont'd)

b. Connections Through Connecting Arrangements Provided by the Company (Cont'd)

2) Grandfathered Connections of Terminal Equipment (Cont'd)

b) Voice Terminal Equipment (Cont'd)

- (1) The connection shall be made through a network control signaling unit and a connecting arrangement furnished by the Company. In accordance with d) and e) following, a connecting arrangement is not required for the connection of Attested Equipment or Conforming Answering Devices.
- (2) Where a data access arrangement is furnished in connection with customer-provided terminal equipment and such terminal equipment is used for both voice and data communication, the data access arrangement may be used to connect the customer-provided terminal equipment for voice communication.
- (3) The customer-provided voice terminal equipment must comply with the minimum protection criteria specified in c. following.

GENERAL EXCHANGE TARIFF

Embarq Florida, Inc.

By: F.B. Poag  
Director

SECTION A15  
First Revised Sheet 31  
Cancelling Original Sheet 31  
Effective: January 1, 1997

CONNECTIONS OF CUSTOMER-PROVIDED TERMINAL  
EQUIPMENT AND COMMUNICATIONS SYSTEMS

A. REGULATIONS (Cont'd)

3. Connections of Grandfathered Terminal Equipment and Grandfathered Communications Systems (Cont'd)

b. Connections Through Connecting Arrangements Provided by the Company (Cont'd)

3) Grandfathered Connections of Communications Systems

Subject to the provisions of 1)a)(1) and (2) preceding, customer-provided communications systems may be connected at the customer's premises to telecommunications services in accordance with the following:

- a) Such telecommunications service or customer-provided communications system is utilized for the origination or termination of communications at the customer's premises where the connection is made.
- b) The connection shall be through a network control signaling unit and connecting arrangement furnished by the Company.
- c) The provisions relating to minimum protection criteria set forth in c. following shall apply to the connection of customer-provided communications systems. As related to minimum protection criteria and when applied to the connection of customer-provided communications systems, the term "Customer's Premises" shall include any premises on which the customer-provided communications system is terminated.

GENERAL EXCHANGE TARIFF

Embarq Florida, Inc.

By: F.B. Poag  
Director

SECTION A15  
First Revised Sheet 32  
Cancelling Original Sheet 32  
Effective: January 1, 1997

CONNECTIONS OF CUSTOMER-PROVIDED TERMINAL  
EQUIPMENT AND COMMUNICATIONS SYSTEMS

A. REGULATIONS (Cont'd)

3. Connections of Grandfathered Terminal Equipment and Grandfathered Communications Systems (Cont'd)

c. Minimum Protection Criteria for Electrical Connections

- 1) To prevent excessive noise and crosstalk in the network, it is necessary that the power of the signal at the central office not exceed 12dB below one milliwatt when averaged over any three second interval. To insure that this limit is not exceeded, the power of the signal which may be applied by the customer-provided equipment to the Company interface located on the customer's premises will be specified for each customer location but in no case shall it exceed one milliwatt.
- 2) To protect other services, it is necessary that the signal which is applied by the customer-provided equipment to the Company interface located on the customer's premises meet the following limits:
  - a) The power in the band from 3,995 Hertz to 4,005 Hertz shall be at least 18dB below the power of the signal as specified in 1) above.
  - b) The power in the band from 4,005 to 10,000 Hertz shall not exceed 16dB below 1 milliwatt.
  - c) The power in the band from 10,000 Hertz to 25,000 Hertz shall not exceed 36dB below 1 milliwatt.

GENERAL EXCHANGE TARIFF

Embarq Florida, Inc.

By: F.B. Poag  
Director

SECTION A15  
First Revised Sheet 33  
Cancelling Original Sheet 33  
Effective: January 1, 1997

CONNECTIONS OF CUSTOMER-PROVIDED TERMINAL  
EQUIPMENT AND COMMUNICATIONS SYSTEMS

A. REGULATIONS (Cont'd)

3. Connections of Grandfathered Terminal Equipment and Grandfathered Communications Systems (Cont'd)

c. Minimum Protection Criteria for Electrical Connections' (Cont'd)

2) (Cont'd)

d) The power in the band from 25,000 Hertz to 40,000 Hertz shall not exceed 36dB below 1 milliwatt.

e) The power in the band above 40,000 Hertz shall not exceed 50dB below 1 milliwatt.

3) To prevent the interruption or disconnection of a call, or interference with network control signaling, it is necessary that the signal applied by the customer-provided equipment to the Company interface located on the customer's premises at no time have energy solely in the 2450 to 2750 Hertz band. If signal power is in the 2450 to 2750 Hertz band, it must not exceed the power present at the same time in the 800 to 2450 Hertz band.

d. Connections Under Certification Programs

Equipment that was connected under the following programs is also considered grandfathered as of their expiration date:

1) Attestation Program, which expired July 1, 1980.

2) Conformance Program, which expired July 1, 1979.

GENERAL EXCHANGE TARIFF

Embarq Florida, Inc.

By: F.B. Poag  
Director

SECTION A15  
First Revised Sheet 34  
Cancelling Original Sheet 34  
Effective: January 1, 1997

CONNECTIONS OF CUSTOMER-PROVIDED TERMINAL  
EQUIPMENT AND COMMUNICATIONS SYSTEMS

A. REGULATIONS (Cont'd)

4. Acoustic or Inductive Connections

a. General

- 1) Customer-provided voice or data terminal equipment (including telephotograph equipment) and customer-provided communications systems may be acoustically or inductively connected at the customer's premises to the telecommunications network provided the acoustic or inductive connection is made externally to the network control signaling unit when such unit is provided by the Company.
- 2) Customer-provided tone-type address signaling is permitted through such connections, however, the services of the Company are not designed for such use and the Company makes no representation as to the reliability of address signaling which is performed in such manner.

b. Minimum Protection Criteria

- 1) To prevent excessive noise and crosstalk in the network, it is necessary that the power of the signal which is applied by the customer-provided equipment to the network control signaling unit, located on the customer's premises, be limited so that the signal power at the output of the network control signaling unit (i.e., at the input to the Company line) does not exceed 9dB below 1 milliwatt when averaged over any 3 second interval.

GENERAL EXCHANGE TARIFF

Embarq Florida, Inc.

By: F.B. Poag  
Director

SECTION A15  
First Revised Sheet 35  
Cancelling Original Sheet 35  
Effective: January 1, 1997

CONNECTIONS OF CUSTOMER-PROVIDED TERMINAL  
EQUIPMENT AND COMMUNICATIONS SYSTEMS

A. REGULATIONS (Cont'd)

4. Acoustic or Inductive Connections (Cont'd)

b. Minimum Protection Criteria (Cont'd)

1) (Cont'd)

However, to permit each customer, independent of distance from the central office to supply signal power which at the central office approximates 12dB below 1 milliwatt when averaged over any 3 second interval, the Company, at the customer's request, will specify, for each customer location, the signal power at the output of the network control signaling unit, which in no case exceed 1 milliwatt.

2) To protect other services, it is necessary that the signal which is applied by the customer-provided equipment to the network control signaling unit located on the Customer's premises meet the following limits at the output of the network control signaling unit:

- a) The power in the band from 3,995 Hertz to 4,005 Hertz shall be at least 18dB below the power of the signal as specified in 1) preceding.
- b) The power in the band from 4,005 Hertz to 10,000 Hertz shall not exceed 16dB below 1 milliwatt.
- c) The power in the band from 10,000 Hertz to 25,000 Hertz shall not exceed 24dB below 1 milliwatt.



GENERAL EXCHANGE TARIFF

Embarq Florida, Inc.

By: F.B. Poag  
Director

SECTION A15  
First Revised Sheet 36  
Cancelling Original Sheet 36  
Effective: January 1, 1997

CONNECTIONS OF CUSTOMER-PROVIDED TERMINAL  
EQUIPMENT AND COMMUNICATIONS SYSTEMS

A. REGULATIONS (Cont'd)

4. Acoustic or Inductive Connections (Cont'd)

b. Minimum Protection Criteria (Cont'd)

2) (Cont'd)

d) The power in the band from 25,000 Hertz to 40,000 Hertz shall not exceed 36dB below 1 milliwatt.

e) The power in the band above 40,000 Hertz shall not exceed 50dB below 1 milliwatt.

3) To prevent the interruption or disconnection of a call, or interference with network control signaling, it is necessary that the signal applied by the customer-provided equipment to the network control signaling unit located on the customer's premises be limited so that the signal at the output of the network control signaling unit (i.e., at the input to the Company line) shall at no time have energy solely in the 2450 to 2750 Hertz band. If there is signal power at the output of the network control signaling unit in the 2450 to 2750 Hertz band, it must not exceed the power present at the same time in the 800 to 2450 Hertz band.

GENERAL EXCHANGE TARIFF

Embarq Florida, Inc.

By: F.B. Poag  
Director

SECTION A15  
First Revised Sheet 37  
Cancelling Original Sheet 37  
Effective: January 1, 1997

CONNECTIONS OF CUSTOMER-PROVIDED TERMINAL  
EQUIPMENT AND COMMUNICATIONS SYSTEMS

A. REGULATIONS (Cont'd)

5. Connections of Customer-Provided Communications Systems Not Subject to Part 68 of FCC Rules and Regulations.

Customer-provided communications systems not subject to Part 68 of the Federal Communications Commission's Rules and Regulations may be connected with telecommunications services in accordance with this Tariff. These communications systems (including channels derived from such systems), not exceeding voice grade, may be connected at the customer's premises provided that:

- a. Such telecommunications service or customer-provided communications system is utilized for the origination or termination of communications at the customer's premises where the connection is made.
- b. The connection shall be through a network control signaling unit and connecting arrangement furnished by the Company.
- c. The connection shall be made through switching equipment provided by the customer.
- d. The provisions relating to minimum protection criteria set forth in A.3.c. preceding shall apply to the connection of customer-provided communications systems. As related to minimum protection criteria and when applied to the connection of customer-provided communications systems, the term "Customer's premises" shall include any premises on which the customer-provided communications system is terminated.

GENERAL EXCHANGE TARIFF

Embarq Florida, Inc.

By: F.B. Poag  
Director

SECTION A15  
First Revised Sheet 38  
Cancelling Original Sheet 38  
Effective: January 1, 1997

CONNECTIONS OF CUSTOMER-PROVIDED TERMINAL  
EQUIPMENT AND COMMUNICATIONS SYSTEMS

A. REGULATIONS (Cont'd)

5. Connections of Customer-Provided Communications Systems Not Subject to Part 68 of FCC Rules and Regulations. (Cont'd)

d. (Cont'd)

Where the telecommunications service is used in the provision of a composite data service for others and connection of such service is made to a communications system provided by a customer and the connection is made through customer-provided data switching equipment, the provisions of a. and c. above do not apply.

6. Connections of Customer-Provided Terminal Equipment Specifically Exempted from the FCC Registration Program

Customer-provided terminal equipment may be connected at the customer's premises to individual line service.

GENERAL EXCHANGE TARIFF

Embarq Florida, Inc.

By: F.B. Poag  
Director

SECTION A15  
First Revised Sheet 39  
Cancelling Original Sheet 39  
Effective: January 1, 1997

CONNECTIONS OF CUSTOMER-PROVIDED TERMINAL  
EQUIPMENT AND COMMUNICATIONS SYSTEMS

A. REGULATIONS (Cont'd)

7. Connections of Certain Facilities of Power, Pipe Line, and Railroad Companies.

a. General

- 1) Except as otherwise provided in b) following, telephone facilities of an electric power company, an oil, oil products, or natural gas pipe line company, or a railroad company provided primarily to communicate with points located along a right-of-way (including premises of such company anywhere in cities, towns, or villages along the right-of-way) owned or controlled by such company may, in lieu of the provisions of A.3 and A.5. preceding, be connected with the telecommunications network, for the following purposes:
  - a) In cases of emergency involving safety of life or property.
  - b) In cases of calls originated by railroad employees under circumstances indicating need for prompt action to secure or maintain the safety, continuity, or reliability of railroad service to the public, and related to the movement of passengers, mail, property, or equipment by railroad, or the repair, maintenance, or construction of railroad rights-of-way, structures, or equipment.
  - c) In cases where the customer facilities serve locations where it is impracticable because of hazard or inaccessibility for the Company to furnish its facilities; and

GENERAL EXCHANGE TARIFF

Embarq Florida, Inc.

By: F.B. Poag  
Director

SECTION A15  
First Revised Sheet 40  
Cancelling Original Sheet 40  
Effective: January 1, 1997

CONNECTIONS OF CUSTOMER-PROVIDED TERMINAL  
EQUIPMENT AND COMMUNICATIONS SYSTEMS

A. REGULATIONS (Cont'd)

7. Connections of Certain Facilities of Power, Pipe Line, and Railroad Companies. (Cont'd)

a. General (Cont'd)

1) (Cont'd)

- d) During an interim period in cases where the customer has arranged for replacement of said customer facilities with facilities of the Company.
- e) Such customer telephone facilities will be connected to PBX switchboards or other telephone switching or terminal equipment located in the same or different local service areas, for communications with stations and private line facilities associated with said switching or terminal equipment; provided, however, that within the same local service area, a PBX switchboard or other telephone switching or terminal equipment for telecommunications service will not be connected with telephones of the customer except telephones associated with party line right-of-way circuits requiring line termination at the PBX, nor with private telephone switching equipment of the customer except where such private telephone switching equipment is used exclusively for dispatching or line switching equipment not connected with customer-provided telephones within the same local service area.

GENERAL EXCHANGE TARIFF

Embarq Florida, Inc.

By: F.B. Poag  
Director

SECTION A15  
First Revised Sheet 41  
Cancelling Original Sheet 41  
Effective: January 1, 1997

CONNECTIONS OF CUSTOMER-PROVIDED TERMINAL  
EQUIPMENT AND COMMUNICATIONS SYSTEMS

A. REGULATIONS (Cont'd)

7. Connections of Certain Facilities of Power, Pipe Line, and Railroad Companies. (Cont'd)

a. General (Cont'd)

1) (Cont'd)

f) Facilities of the Company, when connected with facilities of the customer, will not be used for communications of other than the customer, except that such facilities may be used for the communications of, and be connected with facilities furnished by the Company to, other companies which:

- (1) Are operated with the customer as part of an integrated electric power, oil, oil products, or natural gas system or railroad system under direct or common ownership or control; or
- (2) Own or operate electric power or pipe line or railroad system jointly with the customer; or
- (3) Own or operate electric power or pipe line or railroad facilities interconnected with those of the customer.

GENERAL EXCHANGE TARIFF

Embarq Florida, Inc.

By: F.B. Poag  
Director

SECTION A15  
First Revised Sheet 42  
Cancelling Original Sheet 42  
Effective: January 1, 1997

CONNECTIONS OF CUSTOMER-PROVIDED TERMINAL  
EQUIPMENT AND COMMUNICATIONS SYSTEMS

A. REGULATIONS (Cont'd)

7. Connections of Certain Facilities of Power, Pipe Line, and Railroad Companies. (Cont'd)

a. General (Cont'd)

- 2) Telephone circuits of such companies will be connected to a local or toll central office line to form a through connection only through manual switching equipment, or an attendant's position of dial PBX equipment. Such equipment or position may be located at either or both ends of the customer's circuit.
- 3) Connection of a telephone circuit of such companies as specified in 1)b), c), or d) preceding may be established at either end of such circuit, but shall not be established at both ends simultaneously.

- b. Effective January 1, 1980, new installations of, or additions to customer-provided terminal equipment and communications systems subject to Part 68 of the Federal Communications Commission's Rules and Regulations, connected to the telecommunications network in accordance with a. preceding, must conform with Part 68 of the Federal Communications Commission's Rules and Regulations.

GENERAL EXCHANGE TARIFF

Embarq Florida, Inc.

By: F.B. Poag  
Director

SECTION A15  
First Revised Sheet 43  
Cancelling Original Sheet 43  
Effective: January 1, 1997

CONNECTIONS OF CUSTOMER-PROVIDED TERMINAL  
EQUIPMENT AND COMMUNICATIONS SYSTEMS

A. REGULATIONS (Cont'd)

8. Connections of Certain Facilities of the National Aeronautics and Space Administration

- a. Except as otherwise provided in b. following, telephone facilities of the National Aeronautics and Space Administration may, in lieu of the provisions of A.3 and A.5 preceding, be connected by means of switching equipment to a PBX switchboard or other telephone switching or terminal equipment for communication with stations and private line facilities associated with said switching or terminal equipment, where the Administrator of the National Aeronautics and Space Administration or his authorized representative notifies the Company in writing that such connection is required for the control of space vehicles. Such Department telephone facilities will be connected to the telecommunications network only in cases of emergency involving safety of life or property, unless the aforesaid Department facilities are in locations where it is impracticable for the Company to furnish its facilities.
- b. Effective January 1, 1980, new installations of, or additions to customer-provided terminal equipment and communications systems subject to Part 68 of the Federal Communications Commission's Rules and Regulations, connected to the telecommunications network in accordance with a. preceding, must conform with Part 68 of the Federal Communications Commission's Rules and Regulations.



GENERAL EXCHANGE TARIFF

Embarq Florida, Inc.

By: F.B. Poag  
Director

SECTION A15  
First Revised Sheet 44  
Cancelling Original Sheet 44  
Effective: January 1, 1997

CONNECTIONS OF CUSTOMER-PROVIDED TERMINAL  
EQUIPMENT AND COMMUNICATIONS SYSTEMS

A. REGULATIONS (Cont'd)

9. Connections of Certain Facilities of the U.S. Army, Navy, and Air Force

a. General

- 1) Except as otherwise provided in b. following, facilities of a telephone system of the U.S. Department of the Army, Navy, or Air Force which serves an establishment operated and administered under the direction of the Department and commanded by authorities of such establishment, may, in lieu of the provisions of A.3. and A.5. preceding, be connected to the telecommunications network where the Secretary of the appropriate Department certifies in writing that reasons of military necessity require that the establishment be served by a telephone system of the Department.

In addition, the facilities of a temporary telephone system of such Department located off a permanent establishment of the Department for maneuvers, mobilization tests, or technical service tests will be so connected.

GENERAL EXCHANGE TARIFF

Embarq Florida, Inc.

By: F.B. Poag  
Director

SECTION A15  
First Revised Sheet 45  
Cancelling Original Sheet 45  
Effective: January 1, 1997

CONNECTIONS OF CUSTOMER-PROVIDED TERMINAL  
EQUIPMENT AND COMMUNICATIONS SYSTEMS

A. REGULATIONS (Cont'd)

9. Connections of Certain Facilities of the U.S. Army, Navy, and Air Force (Cont'd)

a. General (Cont'd)

2) Except as otherwise provided in b. following, telephone facilities of the U.S. Department of Army, Navy, or Air Force, other than those described in 1) preceding, may, in lieu of the provisions of A.3. and A.5. preceding, be connected by means of switching or connecting equipment furnished by the Company, to a PBX switchboard, or other telephone switching or terminal equipment, where the Secretary of the appropriate Department or his authorized representative notifies the Company in writing that such connection is required for reasons of military necessity. Such Department telephone facilities will be connected to the telecommunications network only in cases of emergency involving safety of life or property, unless the aforesaid Department facilities are in locations where it is impracticable for the Company to furnish its facilities.

b. Effective January 1, 1980, new installations of, or additions to customer-provided terminal equipment and communications systems subject to Part 68 of the Federal Communications Commission's Rules and Regulations, connected to the telecommunications network in accordance with a. preceding must conform with Part 68 of the Federal Communications Commission's Rules and Regulations.

GENERAL EXCHANGE TARIFF

Embarq Florida, Inc.

By: F.B. Poag  
Director

SECTION A15  
First Revised Sheet 46  
Cancelling Original Sheet 46  
Effective: January 1, 1997

CONNECTIONS OF CUSTOMER-PROVIDED TERMINAL  
EQUIPMENT AND COMMUNICATIONS SYSTEMS

A. REGULATIONS (Cont'd)

10. Connections of Customer-Provided Station Lines and Facilities in Hazardous or Inaccessible Locations

- a. Except as otherwise provided in b. following, service station lines, and facilities furnished by the customer which involve hazardous or inaccessible locations, may be connected to the telecommunications network.
- b. Effective January 1, 1980, new installations of or additions to customer-provided terminal equipment and communications systems subject to Part 68 of the Federal Communications Commission's Rules and Regulations, connected to the telecommunications network in accordance with a. preceding, must conform with Part 68 of the Federal Communications Commission's Rules and Regulations.

11. U.S. Coast Guard and U.S. Army National Guard

- a. Telephone facilities of the U.S. Coast Guard, provided primarily to serve Coast Guard Stations in coastal areas as an aid in saving and protecting life and property, will be connected to facilities of the Company for telecommunications service.

Radio facilities of the U.S. Army National Guard, provided for two way point-to-point communications in times of natural disasters or other emergencies when local and toll facilities of the Company are out of service at or between either of the service points, may be connected to facilities of the Company for telecommunications service.

GENERAL EXCHANGE TARIFF

Embarq Florida, Inc.

By: F.B. Poag  
Director

SECTION A15  
First Revised Sheet 47  
Cancelling Original Sheet 47  
Effective: January 1, 1997

CONNECTIONS OF CUSTOMER-PROVIDED TERMINAL  
EQUIPMENT AND COMMUNICATIONS SYSTEMS

A. REGULATIONS (Cont'd)

11. U.S. Coast Guard and U.S. Army National Guard (Cont'd)

- b. Effective January 1, 1980, new installations of or additions to customer-provided terminal equipment and communications systems subject to Part 68 of the Federal Communications Commission's Rules and Regulations, connected to the telecommunications network in accordance with a. preceding must conform with Part 68 of the Federal Communications Commission's Rules and Regulations.

B. CUSTOMER-PROVIDED TERMINAL EQUIPMENT

1. Data Transmitting and/or Receiving Terminal Equipment

Customer-provided data transmitting and/or receiving terminal equipment, (including telephotograph equipment), which involves direct electrical connection to the facilities furnished by the Company may be used with such facilities for telecommunications service either through a data set, or a data access arrangement, provided by the Company as described below in a. and b. respectively. Use of such service is on a two-point basis.

GENERAL EXCHANGE TARIFF

Embarq Florida, Inc.

By: F.B. Poag  
Director

SECTION A15  
First Revised Sheet 48  
Cancelling Original Sheet 48  
Effective: January 1, 1997

CONNECTIONS OF CUSTOMER-PROVIDED TERMINAL  
EQUIPMENT AND COMMUNICATIONS SYSTEMS

B. CUSTOMER-PROVIDED TERMINAL EQUIPMENT

1. Data Transmitting and/or Receiving Terminal Equipment (Cont'd)

a. Data Set

Where the customer elects to use customer-provided data transmitting and/or receiving terminal equipment with a data set furnished by the Company, the data set shall perform the functions of:

- 1) Network control signaling
- 2) Conditioning the data signals generated by the customer-provided equipment to signals suitable for transmission by means of Company facilities, and
- 3) Conditioning signals transmitted by means of Company facilities to data signals suitable for reception by customer-provided equipment.

b. Data access Arrangement

Network Protection Criteria

Where the customer elects to use customer-provided data transmitting and/or receiving terminal equipment through a data access arrangement, regulations specified in A.3.b. are applicable.

GENERAL EXCHANGE TARIFF

Embarq Florida, Inc.

By: F.B. Poag  
Director

SECTION A15  
First Revised Sheet 49  
Cancelling Original Sheet 49  
Effective: January 1, 1997

CONNECTIONS OF CUSTOMER-PROVIDED TERMINAL  
EQUIPMENT AND COMMUNICATIONS SYSTEMS

- B. CUSTOMER-PROVIDED TERMINAL EQUIPMENT (Cont'd)
2. Rates and Charges  
See A115 following
  3. U.S. Government Executive Departments and Agencies
    - a. Equipment of a department or agency of the Executive Branch of the U.S. Government used for the purpose of disguising or concealing the contents or meaning of communications may be connected to Company facilities subject to the regulations and conditions stated below:
      - 1) The head of the department or agency whose equipment is to be connected, or his authorized representative, shall notify the Company in writing that such connection is necessary to safeguard official information which requires protection in the interests of national defense or other confidential official information disclosure of which to unauthorized persons would be detrimental to the public interest.
      - 2) The connection shall be made by means of connecting equipment or arrangements furnished by the Company.
    - b. Effective January 1, 1980, new installations of, or additions to customer-provided terminal equipment and communications systems subject to Part 68 of the Federal Communications Commission's Rules and Regulations, connected to the telecommunications network in accordance with a. preceding, must conform with Part 68 of the Federal Communications Commission's Rules and Regulations.

GENERAL EXCHANGE TARIFF

Embarq Florida, Inc.

By: F.B. Poag  
Director

SECTION A15  
First Revised Sheet 50  
Cancelling Original Sheet 50  
Effective: January 1, 1997

CONNECTIONS OF CUSTOMER-PROVIDED TERMINAL  
EQUIPMENT AND COMMUNICATIONS SYSTEMS

B. CUSTOMER-PROVIDED TERMINAL EQUIPMENT (Cont'd)

4. Connection of Customer-Provided Voice Transmitting/Receiving Terminal Equipment for  
Recording of Telephone Conversations

a. Regulations

1) General

Telecommunications service furnished by the Company is not represented as adapted to the recording of telephone conversations. However, customer-provided recording equipment may be used in connection with telecommunications service subject to the regulations specified in A.1.d. and A.3.b.

- a) (Filed in compliance with order, dated May 20, 1948, of the Federal Communications Commission in Docket No. 6787)

Connection of customer-provided voice recording equipment with facilities of the Company for the recording of telephone conversations is permitted by means of a direct electrical connection or a connecting arrangement for additions to Grandfathered Terminal Equipment or Communications Systems.

- b) The customer-provided voice recording equipment must comply with the minimum network protection criteria set forth for direct electrical connection of customer-provided voice terminal equipment in A.3.c. preceding.

GENERAL EXCHANGE TARIFF

Embarq Florida, Inc.

By: F.B. Poag  
Director

SECTION A15  
First Revised Sheet 51  
Cancelling Original Sheet 51  
Effective: January 1, 1997

CONNECTIONS OF CUSTOMER-PROVIDED TERMINAL  
EQUIPMENT AND COMMUNICATIONS SYSTEMS

B. CUSTOMER-PROVIDED TERMINAL EQUIPMENT (Cont'd)

5. Alarm Detection and Reporting Equipment

a. Regulations

1) General

- a) Connection of customer-provided alarm detection and reporting equipment with the facilities of the Company shall be made only through a network interface furnished by the Company.
- b) Customer-provided alarm detection and reporting equipment shall not be used to interconnect any line or channel of the Company with any other line or channel of the Company or any other person.
- c) Connections are subject to regulations specified in A.3.b.



GENERAL EXCHANGE TARIFF

Embarq Florida, Inc.

By: F. B. Poag  
Director

SECTION A16  
First Revised Contents Sheet 1  
Cancelling Original Contents Sheet 1  
Effective: January 1, 1997

PRIVATE BRANCH EXCHANGE SERVICE

	<u>Sheet</u>
A. DIRECT IN DIALING (DID) SERVICE .....	1
1. General.....	1
2. Rates and Charges.....	3
B. CALL SCREENING SERVICES FOR PBX TRUNKS.....	4
1. Operator Screenings .....	4
2. Billed Number Screening.....	5
3. Rates for Call Screening Services.....	5

## GENERAL EXCHANGE TARIFF

Embarq Florida, Inc.

By: F. B. Poag  
Director

SECTION A16  
Second Revised Sheet 1  
Cancelling First Revised Sheet 1  
Effective: November 20, 2004

### PRIVATE BRANCH EXCHANGE SERVICE

#### A. DIRECT INWARD DIALING (DID) SERVICE

##### 1. General

- a. DID service permits calls incoming to Customer Premises Equipment requiring outpulsing of digits from the network to reach a specific station line without the assistance of an attendant. DID service is provided subject to the availability of facilities and telephone numbers and other conditions as specified in Section A2, General Regulations and Section A15, Connections Of Customer-Provided Terminal Equipment And Communications Systems, of this tariff.
- b. The rates specified herein are in addition to the rates shown elsewhere in the tariff for the services with which this offering is associated (e.g., central office PBX Trunks, ISDN-PRI Service, Shared Tenant Service, Digital Trunking Service, etc.).
- c. DID service includes central office switching equipment necessary for in-dialing from the network directly to stations associated with customer premises switching equipment. Subscribers to DID service will be required to maintain an adequate number of trunks as determined by the Company in order to provide quality grade of service and prevent network degradation.
- d. The service must be provided on all lines in a trunk group arranged for inward service. Where DID is required on more than one group of trunks or central office lines, each such group shall be considered as a separate DID service.
- e. The assignment of telephone numbers and the sequence of the numbers assigned to a DID service is made at the discretion of the Company. Where the equipment configuration requires the assignment of blocks of telephone numbers or where the customer requests additional blocks of telephone numbers held in reserve for future use, rates and charges as shown in Section A16.A.2.a)1)(b) are applicable for each unused block of telephone numbers.
- f. The rates herein contemplate the use of standard Company equipment and serving arrangements. When equipment or service of a special type arrangement is requested and provided, rates and charges are based on the costs involved to meet the individual requirements of each case.
- g. Operational characteristics of interface signals between the Company-provided connecting arrangements and the customer-provided switching equipment must conform to the rules and regulations the Company considers necessary to maintain proper standards of service.

## GENERAL EXCHANGE TARIFF

Embarq Florida, Inc.

By: F. B. Poag  
Director

SECTION A16  
Second Revised Sheet 2  
Cancelling First Revised Sheet 2  
Effective: November 20, 2004

### PRIVATE BRANCH EXCHANGE SERVICE

#### A. DIRECT INWARD DIALING (DID) SERVICE (Cont'd)

##### 1. General (Cont'd)

- h. The Company shall not be responsible to the customer or authorized user if changes in protection criteria or in any of the facilities, operations, or procedures of the Company render any of the facilities provided by a customer or authorized user obsolete or require modification or alteration of such equipment or system or otherwise affect its use or performance.
- i. Directory listings will be provided in accordance with the regulations of Section A6, Directory Listings, of this tariff for PBX Trunks. DID numbers furnished herein are not entitled to directory listings without charge. Where clients of a subscriber to DID service have no local exchange service but want to list one of these numbers, Interconnection of Local Exchange Services to Shared Tenant Services in Section A26, of this tariff will be applicable.
- j. All switching systems must be arranged by the customer to provide for the intercepting of assigned but unused station numbers.
- k. At the customer's request and at the discretion of the Company, subject to operating limits and the availability of facilities, DID service may be provided outside the customer's normal serving central office. Where a DID trunk group is served from a central office other than the customer's normal serving central office, the appropriate rates for Foreign Exchange service and Foreign Central Office service, per trunk will apply.
- l. In addition to the rates and charges specified in Section A16.A.2, appropriate Service Charges are applicable to the establishment or rearrangement of trunks and numbers in connection with providing DID service.
- m. Installation charges for DID central office switching equipment are not applicable if the customer presently subscribes to DID service and changes the type of customer premises switching equipment. The following provisions apply:
  - 1) The customer must maintain at least the same level of DID service requirements.
  - 2) The replacing customer premises equipment must be served by the same central office as the existing customer premises equipment.
  - 3) Central office switching equipment additions or modifications must not be required in order to provide DID service to the replacing customer premises switching equipment.
  - 4) Rates and charges are applicable to additional DID service requirements which exceed the customer's existing level of DID arrangements.

GENERAL EXCHANGE TARIFF

Embarq Florida, Inc.

By: F. B. Poag  
Director

SECTION A16  
Fifth Revised Sheet 3  
Cancelling Fourth Revised Sheet 3  
Effective: November 20, 2004

PRIVATE BRANCH EXCHANGE SERVICE

A. DIRECT INWARD DIALING (DID) SERVICE (Cont'd)

1. General (Cont'd)

- n. The removal of one or more numbers from a DID number block is offered subject to the availability of facilities at the charge specified in A16.A.2.a)1)(d) following. In such cases, the customer shall continue to pay the appropriate rate for the original block of DID numbers.

The re-instatement of one or more numbers to a DID number block is offered, subject to the availability of facilities, at the charge specified in A16.A.2.a)1)(e) following.

- o. A DID customer may reuse his DID numbers for non-DID purposes when the customer's DID service is disconnected. Rates and charges will be determined by the appropriate tariffs for the new services.
- p. In cases where a customer converts a larger block of numbers into one or more smaller blocks of numbers, or converts one or more smaller blocks of numbers into a larger block of numbers, it will constitute a disconnection and the appropriate installation charges will apply to establish the new number block(s). However, the customer may be required to accept different numbers from those in the original number block(s).
- q. Special steps are required for PBX customers to have 9-1-1 service features consistent with those provided to other end users in the same 9-1-1 service area. Automatic Number Identification, Automatic Location Identification and/or Selective Routing are only available through coordination with the governmental agency responsible for 9-1-1 service within the area served by the PBX in accordance with the provisions of Section A10, N11 Services, of this tariff.

GENERAL EXCHANGE TARIFF

Embarq Florida, Inc.

By: F. B. Poag  
Director

SECTION A16  
First Revised Sheet 3.1  
Cancelling Original Sheet 3.1  
Effective: November 20, 2004

PRIVATE BRANCH EXCHANGE SERVICE

A. DIRECT INWARD DIALING (DID) SERVICE (Cont'd)

2. Rates and Charges

a) Central Office Components

1) Direct Inward Dialing (DID) Service<sup>1</sup>:

	<u>Installation Charge</u>	<u>Monthly Rate</u>
(a) Establish DID Trunk Group	\$100.00	\$0.00
(b) Block of Numbers		
1. Individual Numbers, per number <sup>2</sup>	10.00	1.50
2. Block of 20 DID Numbers	10.00	10.00
3. Block of 100 DID Numbers	10.00	50.00
4. Block of 200 or more DID numbers	ICB	ICB
(c) DID Trunk Termination, Per trunk <sup>3</sup>	0.00	35.00
		<u>Nonrecurring Charge</u>
(d) Removal of a number from DID number block, per Number per order		\$25.00
(e) Re-instatement of a number to a DID number block, per Number per order		\$25.00

Note<sup>1</sup>: In addition to the rates and charges for the DID service, rates and charges for PBX Trunks as specified in Section A3, Basic Local Exchange Service, of this tariff apply as appropriate.

Note<sup>2</sup>: Individual numbers apply to ISDN-PRI Service only.

Note<sup>3</sup>: DID Trunk Termination charges are not applicable with ISDN-PRI Service or Digital Trunking Service applications.

GENERAL EXCHANGE TARIFF

Embarq Florida, Inc.

By: F. B. Poag  
Director

SECTION A16  
First Revised Sheet 4  
Cancelling Original Sheet 4  
Effective: January 1, 1997

PRIVATE BRANCH EXCHANGE SERVICE

B. CALL SCREENING SERVICES FOR PBX TRUNKS

1. Operator Screenings

- a. Operator Screening enables a customer, by means of telephone company operator identification, to restrict outgoing telephone calls from station users to only those calls which are placed as credit card, third party billed or collect to the called telephones. This applies to all 0+ and 0- calls as specified in d. And e. following.
- b. All calls to Company numbers such as Repair Service, Directory Assistance and Public Emergency Service numbers (911) will be permitted from the originating station.
- c. Operator Screening is limited to those areas served by central offices arranged for this service and is subject to the availability of facilities at rates as specified following.
- d. Operator Screening is provided for Company-provided intraLATA calling through Company operators. Screening for intraLATA and interLATA calling not carried by the Company is the responsibility of the intraLATA and interLATA carriers who chose to acknowledge the network screening signals passed to them.
- e. The Company will not be responsible for screening calls placed by the PBX customer which are not routed through a Company operator. Calls routed through Alternate Operator Services cannot be screened by the Company.

GENERAL EXCHANGE TARIFF

Embarq Florida, Inc.

By: F. B. Poag  
Director

SECTION A16  
Second Revised Sheet 5  
Cancelling First Revised Sheet 5  
Effective: August 13, 1999

PRIVATE BRANCH EXCHANGE SERVICE

B. CALL SCREENING SERVICES FOR PBX TRUNKS

2. Billed Number Screening

- a. Billed Number Screening is a service which, through operator screening, prevents third number and collect calls from being billed to the PBX customer.
- b. The screening of collect, third number and international collect calls cannot be guaranteed; therefore, charges for any such calls will be the responsibility of the customer.
- c. Billed Number Screening for other classes of service can be found in Sections A13 and A25 of this tariff.

3. Rates for Call Screening Services

a. UNITED TELEPHONE AREA

- 1) Operator Screening  
Per trunk, per month \$ 5.00
- 2) Billed Number Screening
  - a) Service Establishment Charge  
Per request \$15.00  
Per number to be screened \$ .10
  - b) Recurring Charge  
Per trunk, per month \$ 5.00

GENERAL EXCHANGE TARIFF

Embarq Florida, Inc.

By: F. B. Poag  
Director

SECTION A16  
Second Revised Sheet 6  
Cancelling First Revised Sheet 6  
Effective: November 27, 1998

PRIVATE BRANCH EXCHANGE SERVICE

B. CALL SCREENING SERVICES FOR PBX TRUNKS (Cont'd)

3. Rates for Call Screening Services (Cont'd)

b. CENTRAL TELEPHONE AREA

1) Operator Screening See Section A13.L.

2) Billed Number Screening See Section A13.L.

c. Service order charges in Section A4 are applicable.



GENERAL EXCHANGE TARIFF

Embarq Florida, Inc.

Section A17

By: F. B. Poag  
Director

First Revised Contents Sheet 1  
Cancelling Original Contents Sheet 1  
Effective: January 1, 1997

PERSONAL DIAL PAGING SERVICES  
CONTENTS

A.	DEFINITIONS .....	1
B.	SERVICE LIMITATIONS .....	1
C.	SERVICE AREAS .....	1
D.	OBLIGATIONS OF THE CUSTOMER .....	2
E.	RATES AND CHARGES .....	2

GENERAL EXCHANGE TARIFF

Embarq Florida, Inc.

By: F. B. Poag  
Director

Section A17  
First Revised Sheet 1  
Cancelling Original Sheet 1  
Effective: January 1, 1997

PERSONAL DIAL PAGING SERVICES

A. Definitions

1. Personal Dial Paging Service

A communication service which provides a paging signal originating at any dial telephone and carried over a radio channel to a miniature pocket radio receiver carried by a customer.

2. Mem-o-lert Deferred Paging

An optional feature of certain miniature pocket radio receivers which enables the customer to defer the paging signal (beep tone portion only) until a later time.

B. Service Limitations

Service is available only to pocket receivers equipped for service, when within range of a base station through which such service is furnished, subject to transmission, atmospheric and like limitations.

C. Service Areas

Personal dial paging service is offered only at the following locations where the service has been installed and is available:

Tallahassee, Florida  
Fort Walton Beach, Florida

GENERAL EXCHANGE TARIFF

Embarq Florida, Inc.

By: F. B. Poag  
Director

Section A17  
First Revised Sheet 2  
Cancelling Original Sheet 2  
Effective: January 1, 1997

PERSONAL DIAL PAGING SERVICES

D. Obligations of the Customer

1. Customers will not receive a directory listing for the names or receiver number.
2. A personal dial paging service agreement shall be executed prior to the establishment of service.
3. Customers engaged in the business of renting radio receivers to others may do so upon the condition that use of the Company's service shall not be made subject to any charge in addition to the monthly rates set forth in this tariff.
4. Customer-owned pocket receivers shall be suitable for operations with the Company's Personal Dial Paging Service ("Motorola Metro 2, Terminal Code B.W. System"). All expenses to equip and maintain the customer-provided pocket receivers are borne by the customer.

E. Rates and Charges

1. Monthly Recurring Charges
  - a. Access line for Tone-only Pocket Receiver, each \$18.45
  - b. Access line for Tone and Voice Pocket Receiver, each \$20.41

GENERAL EXCHANGE TARIFF

Embarq Florida, Inc.

By: F. B. Poag  
Director

SECTION A18  
Six Revised Contents Sheet 1  
Cancelling Fifth Revised Contents Sheet 1  
Effective: November 28, 2002

LONG DISTANCE MESSAGE TELECOMMUNICATIONS SERVICE

CONTENTS

	<u>SECTION</u>
A. APPLICATION.....	1
B. GENERAL .....	1
C. AIRLINE MILEAGE BETWEEN RATE CENTERS .....	2
1. General.....	2
2. Determination of Airline Mileages.....	3
3. List of Rate Centers.....	6
D. TWO-POINT SERVICE .....	11
1. Service Between Land Wire Telephones .....	11
2. Service Through Mobile Telephone Service Base Stations .....	25
3. Sense Local Toll .....	27
4. Business Sense Local Toll .....	30
5. Enterprise Service .....	33
6. VALU-PAK Service.....	35
7. Telesaver Service .....	38
9. Simply Five .....	41.3
10. Payphone Surcharge .....	41.5
E. CONFERENCE SERVICE (United Telephone Only) .....	42
1. General. ....	42
2. Rate and Charge Application.....	42
3. Rates and Charges.....	44

GENERAL EXCHANGE TARIFF

Embarq Florida, Inc

By: F. B. Poag  
Director

SECTION A18  
Second Revised Contents Sheet 2  
Cancelling First Revised Contents Sheet 2  
Effective: June 5, 1998

LONG DISTANCE MESSAGE TELECOMMUNICATIONS SERVICE

CONTENTS

	<u>SECTION</u>
F. INTRALATA LONG DISTANCE VERIFICATION AND EMERGENCY INTERRUPT SERVICE	45
1. General	45
2. Rates and Charges	46
G. DIRECTORY ASSISTANCE SERVICE	48
1. General	48
2. Rates and Charges	48
H. DIRECTORY ASSISTANCE CALL COMPLETION (DACC)	49
1. General	49
2. Rates and Charges	52

GENERAL EXCHANGE TARIFF

Embarq Florida, Inc

By: F. B. Poag  
Director

SECTION A18  
Second Revised Sheet 1  
Cancelling First Revised Sheet 1  
Effective: January 30, 1998

LONG DISTANCE MESSAGE TELECOMMUNICATIONS SERVICE

A. APPLICATION

This tariff applies to long distance message telecommunications service furnished or made available by the Company and its connecting companies between two or more points which are located in the same Local Access and Transport Area (LATA) within the State of Florida where the respective rate centers of such points also are located in said state.

B. GENERAL

1. Long distance message telecommunications service is that of furnishing facilities for communications between stations in different rate centers for either two-point or conference service.
2. Rates for service between points are based on airline mileage between rate centers. In general, each point is designated as a rate center except that certain small towns or communities are assigned adjacent rate centers with which they are closely associated for communications purposes or by community of interest. Airline mileages between rate centers are determined as proved in Section A18.C. following.
3. In case a shortage of facilities exists at any time, either for temporary or protracted periods, the establishment of long distance message telecommunications service shall take precedence over all others.

GENERAL EXCHANGE TARIFF

Embarq Florida, Inc

By: F. B. Poag  
Director

SECTION A18  
Second Revised Sheet 2  
Cancelling First Revised Sheet 2  
Effective: January 30, 1998

LONG DISTANCE MESSAGE TELECOMMUNICATIONS SERVICE

C. AIRLINE MILEAGE BETWEEN RATE CENTERS

1. General

- a. For the purposes of determining airline mileages vertical, and horizontal grid lines have been established across the State of Florida. The spacing between adjacent vertical grid lines and between horizontal grid lines represents a distance of one coordinate unit. This unit is the square root of 0.1, expressed in airline miles. A vertical (V) and horizontal (H) coordinate is computed for each rate center from its latitude and longitude location by use of appropriate map-projection equations. These rate centers and the V and H coordinates are shown in Section A18.C.3. A pair of V-H coordinates locates a rate center, for determining airline mileages, at a particular intersection of an established vertical grid line with an established horizontal grid line. The distance between any two rate centers is the airline mileage computed as explained in Section A18.C.2. following.
- b. The rate centers in this Tariff are listed alphabetically in Section A18.C.3. following, with columns headed "V" and "H" which contain the vertical and horizontal coordinates for each of these rate centers.

GENERAL EXCHANGE TARIFF

Embarq Florida, Inc

By: F. B. Poag  
Director

SECTION A18  
First Revised Sheet 3  
Cancelling Original Sheet 3  
Effective: January 1, 1997

LONG DISTANCE MESSAGE TELECOMMUNICATIONS SERVICE

C. AIRLINE MILEAGE BETWEEN RATE CENTERS (Cont'd)

2. Determination of Airline Mileages

a. To determine the rate distance between any two rate centers proceed as follows:

- 1) Obtain the V and H coordinates for each rate center.
- 2) Obtain the difference between the V coordinates of the two rate centers. Obtain the difference between the H coordinates.<sup>1</sup>
- 3) Divide each of the differences obtained in Step 2) by three, rounding each quotient to the nearest integer.
- 4) Square these two integers and add the two squares. If the sum of the squares is greater than 1777, divide the integers obtained in Step 3) by three and repeat Step 4). Repeat this process until the sum of the squares obtained is less than 1778.

<sup>1</sup> The difference is always obtained by subtracting the smaller coordinate from the larger coordinate.



GENERAL EXCHANGE TARIFF

Embarq Florida, Inc

By: F. B. Poag  
Director

SECTION A18  
First Revised Sheet 4  
Cancelling Original Sheet 4  
Effective: January 1, 1997

LONG DISTANCE MESSAGE TELECOMMUNICATIONS SERVICE

C. AIRLINE MILEAGE BETWEEN RATE CENTERS (Cont'd)

2. Determination of Airline Mileages (Cont'd)

a. (Cont'd)

- 5) The number of successive divisions by three in Steps 3) and 4) determines the value of "N". Multiply the final sum of the two squares obtained in Step 4) by the multiplier specified in the following table for the value of "N" preceding.

<u>N</u>	<u>Multiplier</u>	<u>Minimum Rate Mileage</u>
1	0.9	-
2	8.1	41
3	72.9	121
4	656.1	361
5	5,904.9	1,081
6	53,144.1	3,241

- 6) Obtain the square root of the product in 5), and, with any resulting fraction, round up to the next higher integer. This is the message rate mileage except that when the mileage so obtained is less than the minimum rate mileage shown in 5) preceding, the minimum rate mileage corresponding to the "N" value is applicable.

a) Example:

1) City One	$\frac{V}{8539}$	$\frac{H}{0904}$
City Two	8246	0796
2) Difference	113	108

GENERAL EXCHANGE TARIFF

Embarq Florida, Inc

By: F. B. Poag  
Director

SECTION A18  
Second Revised Sheet 5  
Cancelling First Revised Sheet 5  
Effective: January 30, 1998

LONG DISTANCE MESSAGE TELECOMMUNICATIONS SERVICE

C. AIRLINE MILEAGE BETWEEN RATE CENTERS (Cont'd)

2. Determination of Airline Mileages (Cont'd)

a. (Cont'd)

6. (Cont'd)

b) Divide each difference by three and round to the nearest integer =

$$113 / 3 = 37.6, \text{ round to } 38$$

$$108 / 3 = 36$$

c) Square integers and add  $38 \times 38 = 1,444$

$$36 \times 38 = 1,296$$

$$2,740$$

d) Sum of integers is greater than 1777, so divide integers obtained in Step 3) by 3 and repeat Step 4):

$$\text{Divide by 3: } 38 / 3 = 12.67, \text{ round to } 13$$

$$36 / 3 = 12$$

$$\text{Square: } 13 \times 13 = 169$$

$$12 \times 12 = \underline{144}$$

$$\text{Sum of squares: } 313$$

e) The sum of the squared integers is now less than 1777 and was obtained after two successive divisions by 3; therefore,  $N = 2$ .

GENERAL EXCHANGE TARIFF

Embarq Florida, Inc

By: F. B. Poag  
Director

SECTION A18  
Second Revised Sheet 6  
Cancelling First Revised Sheet 6  
Effective: January 30, 1998

LONG DISTANCE MESSAGE TELECOMMUNICATIONS SERVICE

C. AIRLINE MILEAGE BETWEEN RATE CENTERS (Cont'd)

2. Determination of Airline Mileages (Cont'd)

a. (Cont'd)

6) (Cont'd)

- f) Multiply the final sum of the squared integers by a factor of 8.1 (corresponding to  $N = 2$ ).

$$\begin{array}{r} 313 \\ \times 8.1 \\ \hline 2535.3 \end{array}$$

- g) The square root of 2535.3 = 50.35, which is rounded up to 51 miles (fractional miles being considered full miles). The 51 miles is larger than the minimum of 41 rate miles applicable when  $N = 2$ , so the message rate mileage is 51 miles.

3. List of Rate Centers

UNITED TELEPHONE

<u>Rate Center</u>	<u>LATA</u>	<u>V</u>	<u>H</u>
Apopka	Orlando	7940	1068
Arcadia	Fort Myers	8251	0967
Astor	Gainesville	7856	1127
Avon Park	Fort Myers	8145	0948
Belleview	Gainesville	7924	1202
Beverly Hills	Gainesville	7988	1252
Boca Grande	Fort Myers	8381	0983
Bonita Springs	Fort Myers	8410	0858
Bowling Green	Fort Myers	8169	1005
Bushnell	Gainesville	8003	1166

GENERAL EXCHANGE TARIFF

Embarq Florida, Inc

SECTION A18

By: F. B. Poag  
Director

First Revised Sheet 7  
Cancelling Original Sheet 7  
Effective: January 1, 1997

LONG DISTANCE MESSAGE TELECOMMUNICATIONS SERVICE

C. AIRLINE MILEAGE BETWEEN RATE CENTERS (Cont'd)

3. List of Rate Centers (Cont'd)

UNITED TELEPHONE

<u>Rate Center</u>	<u>LATA</u>	<u>V</u>	<u>H</u>
Cape Coral	Fort Myers	8383	0908
Cape Haze	Fort Myers	8362	1001
Clermont	Gainesville	7990	1098
Clewiston	Fort Myers	8243	0757
Crystal River	Gainesville	8006	1271
Dade City	Gainesville	8068	1148
Eustis	Gainesville	7925	1116
Everglades	Fort Myers	8458	0739
Forest	Gainesville	7885	1187
Fort Meade	Fort Myers	8144	1014
Fort Myers	Fort Myers	8359	0904
Fort Myers Beach	Fort Myers	8405	0899
Groveland	Gainesville	7999	1113
Homosassa Springs	Gainesville	8025	1259
Howey-In-The-Hills	Gainesville	7963	1116
Immokalee	Fort Myers	8357	0805
Inverness	Gainesville	7995	1223
Kenansville	Orlando	8040	0894
Kissimmee	Orlando	8002	1009
LaBelle	Fort Myers	8294	0848
Lady Lake	Gainesville	7937	1164
Lake Placid	Fort Myers	8187	0891
Leesburg	Gainesville	7954	1143
Lehigh Acres	Fort Myers	7344	0864
Marco Island	Fort Myers	8476	0806

GENERAL EXCHANGE TARIFF

Embarq Florida, Inc

SECTION A18

By: F. B. Poag  
Director

Third Revised Sheet 8  
Cancelling Second Revised Sheet 8  
Effective: June 15, 2000

LONG DISTANCE MESSAGE TELECOMMUNICATIONS SERVICE

C. AIRLINE MILEAGE BETWEEN RATE CENTERS (Cont'd)

3. List of Rate Centers (Cont'd)

UNITED TELEPHONE

<u>Rate Center</u>	<u>LATA</u>	<u>V</u>	<u>H</u>
Montverde	Orlando	7972	1087
Moore Haven	Fort Myers	8246	0796
Mount Dora	Gainesville	7929	1102
Naples	Fort Myers	8447	0840
North Cape Coral	Fort Myers	8369	0918
North Fort Myers	Fort Myers	8357	0911
North Naples	Fort Myers	8425	0855
Ocala	Gainesville	7908	1227
Okeechobee	Fort Myers	8142	0796
Oklawaha	Gainesville	7915	1178
Orange City	Orlando	7869	1063
Pine Island	Fort Myers	8389	0944
Port Charlotte	Fort Myers	8324	0983
Punta Gorda	Fort Myers	8324	0968
Reedy Creek	Orlando	8014	1049
Saint Cloud	Orlando	7999	0984
Salt Springs	Gainesville	7836	1181
San Antonio	Gainesville	8080	1160
Sanibel-Captiva	Fort Myers	8412	0912
Sebring	Fort Myers	8155	0927
Silver Springs Shores	Gainesville	7913	1196
Spring Lake	Fort Myers	8159	0905
Tavares	Gainesville	7939	1119
Trilacoochee	Gainesville	8049	1157

GENERAL EXCHANGE TARIFF

Embarq Florida, Inc

SECTION A18

By: F. B. Poag  
Director

Third Revised Sheet 9  
Cancelling Second Revised Sheet 9  
Effective: August 31, 2000

LONG DISTANCE MESSAGE TELECOMMUNICATIONS SERVICE

C. AIRLINE MILEAGE BETWEEN RATE CENTERS (Cont'd)

3. List of Rate Centers (Cont'd)

UNITED TELEPHONE

<u>Rate Center</u>	<u>LATA</u>	<u>V</u>	<u>H</u>
Umatilla	Gainesville	7910	1123
Wauchula	Fort Myers	8183	0995
Weirsdale	Gainesville	7919	1162
West Kissimmee	Orlando	8002	1029
Wildwood	Gainesville	7958	1176
Williston	Gainesville	7900	1302
Windermere	Orlando	7978	1053
Winter Garden	Orlando	7970	1069
Winter Park	Orlando	7941	1034
Zolfo Springs	Fort Myers	8191	0987

CENTRAL TELEPHONE

<u>Rate Center</u>	<u>LATA</u>	<u>V</u>	<u>H</u>
Alford	Panama City	7930	1925
Cherry Lake	Tallahassee	7771	1590
Cottondale	Panama City	7910	1935
Crawfordville	Tallahassee	7936	1703
Crestview	Pensacola	8025	2128
Destin	Pensacola	8085	2080
Eglin Air Force Base	Pensacola	8094	2097
Fort Walton Beach	Pensacola	8094	2097
Grand Ridge	Panama City	7892	1866
Greenville	Tallahassee	7810	1611

GENERAL EXCHANGE TARIFF

Embarq Florida, Inc

SECTION A18

By: F. B. Poag  
Director

Third Revised Sheet 10  
Cancelling Second Revised Sheet 10  
Effective: June 15, 2000

LONG DISTANCE MESSAGE TELECOMMUNICATIONS SERVICE

C. AIRLINE MILEAGE BETWEEN RATE CENTERS (Cont'd)

3. List of Rate Centers (Cont'd)

UNITED TELEPHONE

<u>Rate Center</u>	<u>LATA</u>	<u>V</u>	<u>H</u>
Greenwood	Panama City	7877	1907
Kingsley Lake	Jacksonville	7746	1293
Lawtey	Jacksonville	7741	1314
Lee	Tallahassee	7789	1552
Madison	Tallahassee	7790	1575
Malone	Panama City	7859	1916
Marianna	Panama City	7901	1907
Monticello	Tallahassee	819	1658
Panacea	Tallahassee	7964	1690
Saint Marks	Tallahassee	7923	1672
Santa Rosa Beach	Pensacola	8067	2034
Seagrove Beach	Pensacola	8069	2007
Shalimar	Pensacola	8087	2098
Sneads	Panama City	7886	1850
Sopchoppy	Tallahassee	7968	1712
Starke	Jacksonville	7764	1306
Tallahassee	Tallahassee	7876	1715
Valparaiso	Pensacola	8066	2088

GENERAL EXCHANGE TARIFF

Embarq Florida, Inc

By: F. B. Poag  
Director

SECTION A18  
First Revised Sheet 11  
Cancelling Original Sheet 11  
Effective: January 1, 1997

LONG DISTANCE MESSAGE TELECOMMUNICATIONS SERVICE

D. TWO-POINT SERVICE

1. Service Between Land Wire Telephones

a. Classes of Service

Service is offered on a Station-to-Station or Person-to-Person basis. The Station-to-Station class of service is furnished on a Customer Dialed Calling Card basis, an Operator Handled basis or on a Direct Dialing basis.

1) Dial Station-to-Station

a) Dial Station-to-Station rates apply only to sent-paid, station-to-station dial type telephone communication.

b) Dial type telephone communication denotes a call dialed and completed by the customer from a residence or business telephone without the assistance of an operator and the call is not billed to a number other than the originating number. The services of an operator will not be used in connection with completing a call, or in furnishing any information or assistance relating to billing or charges for such call, except that an operator will:

(1) Reestablish a call which has been interrupted after the called number has been reached or,



GENERAL EXCHANGE TARIFF

Embarq Florida, Inc

By: F. B. Poag  
Director

SECTION A18  
Second Revised Sheet 12  
Cancelling First Revised Sheet 12  
Effective: April 1, 1997

LONG DISTANCE MESSAGE TELECOMMUNICATIONS SERVICE

D. TWO-POINT SERVICE (Cont'd)

1. Service Between Land Wire Telephones (Cont'd)

a. Classes of Service (Cont'd)

1) Dial Station-to-Station (Cont'd)

b) (Cont'd)

(2) Reach the called telephone number where facilities are not available for customer dial completion.

(3) Record the originating telephone number where no automatic recording equipment is available.

(4) Record a special identification number issued by the Company for its billing purposes to students who reside at dormitories of educational institutions served by a Dormitory Service, or a PBX equipped with Direct Inward Dialing (DID) and Identified Outward Dial (IOD) service for a call dialed from a dormitory station.

(5) Place a call for a calling party who identifies himself as being handicapped and unable to dial the call because of his handicap.

c) Dial Station-to-Station rates do not apply on calls from a pay telephone.

GENERAL EXCHANGE TARIFF

Embarq Florida, Inc

By: F. B. Poag  
Director

SECTION A18  
First Revised Sheet 13  
Cancelling Original Sheet 13  
Effective: January 1, 1997

LONG DISTANCE MESSAGE TELECOMMUNICATIONS SERVICE

D. TWO-POINT SERVICE (Cont'd)

1. Service Between Land Wire Telephones (Cont'd)

a. Classes of Service (Cont'd)

2) Station-to-Station and Person-to-Person Operator Handled Calls

- a) Operator Station-to-Station is that Station-to-Station service where the person originating the call gives to the operator the telephone number of the desired telephone, Miscellaneous Common Carrier connecting circuit, branch exchange system, or branch exchange attendant, or gives only the name and address under which the number of the desired telephone, Miscellaneous Common Carrier connecting circuit, or branch exchange system is listed, and does not specify a particular person to be reached, nor a particular mobile station to be reached through a Miscellaneous Common Carrier, nor a particular station, department or office to be reached through a branch exchange attendant.
- b) Customer Dialed Calling Card is that Station-to-Station service where the person originating the call dials and completes the call without the assistance of an operator, except; that an operator will record the Company Calling Card number; or where the operator reaches the called telephone number where facilities are not available for dial completion.

GENERAL EXCHANGE TARIFF

Embarq Florida, Inc

By: F. B. Poag  
Director

SECTION A18  
Second Revised Sheet 14  
Cancelling First Revised Sheet 14  
Effective: July 21, 1998

LONG DISTANCE MESSAGE TELECOMMUNICATIONS SERVICE

D. TWO-POINT SERVICE (Cont'd)

1. Service Between Land Wire Telephones (Cont'd)

a. Classes of Service (Cont'd)

3) Person-to-Person Service

- a) Person-to-Person service is that service where the person originating the call specifies to the operator a particular person to be reached, a particular mobile station to be reached through a Miscellaneous Common Carrier operator or a particular station, department or office to be reached through a branch exchange attendant.
- b) When, after the telephone, Miscellaneous Common Carrier mobile radio system, or branch exchange system called has been reached, the person originating the call requests or agrees to talk to any other person, mobile unit, station department or office other than the one specified, the classification of the call remains Person-to- Person.

(D)

GENERAL EXCHANGE TARIFF

Embarq Florida, Inc

By: F. B. Poag  
Director

SECTION A18  
Third Revised Sheet 15  
Cancelling Second Revised Sheet 15  
Effective: July 21, 1998

LONG DISTANCE MESSAGE TELECOMMUNICATIONS SERVICE

- D. TWO-POINT SERVICE (Cont'd)
  - 1. Service Between Land Wire Telephones (Cont'd)
    - b. RESERVED FOR FUTURE USE

GENERAL EXCHANGE TARIFF

Embarq Florida, Inc

By: F. B. Poag  
Director

SECTION A18  
Second Revised Sheet 16  
Cancelling First Revised Sheet 16  
Effective: January 30, 1998

LONG DISTANCE MESSAGE TELECOMMUNICATIONS SERVICE

D. TWO-POINT SERVICE (Cont'd)

1. Service Between Land Wire Telephones (Cont'd)

c. Timing of Messages

- 1) The time when connection is established, as provided in Section A18.D.1.c 2) through Section A18.D.1.c 5) following, determined in accordance with the time - standard or daylight saving - observed at the location of the rate center of the calling station, determines what rate schedule applies. This rule applies whether the call is originated as paid or collect.
- 2) On Station-to-Station calls, chargeable time begins when connection is established between the calling station and the called telephone station, Miscellaneous Common Carrier mobile radio system or branch exchange system.
- 3) On Person-to-Person calls, chargeable time begins when connection is established between the calling person and the particular person or station specified or an agreed alternate.
- 4) Chargeable time ends when the calling station "hangs up" thereby releasing the network connection. If the called station "hangs up" but the calling station does not, chargeable time ends when the network connection is released either by automatic timing equipment in the telephone network or by the operator.
- 5) Chargeable time does not include time lost because of faults or defects in the service.

GENERAL EXCHANGE TARIFF

Embarq Florida, Inc

By: F. B. Poag  
Director

SECTION A18  
Second Revised Sheet 17  
Cancelling First Revised Sheet 17  
Effective: January 30, 1998

LONG DISTANCE MESSAGE TELECOMMUNICATIONS SERVICE

D. TWO-POINT SERVICE (Cont'd)

1. Service Between Land Wire Telephones (Cont'd)

d. Reversal of Charges

- 1) Collect calls are permissible for all telephone calls except calls to which Dial Station-to-Station rates apply.
- 2) The regularly established Operator Station-to-Station and Person-to-Person rates apply.

e. Collection of Charges at Coin Telephones

Charges for calls to be collected at the coin box telephones will be the total charge as provided in Section A18.D.1.h. following computed and rounded to the nearest multiple of \$.05.

f. Rates Applicable on Certain Holidays

On Christmas Day (December 25) and on New Year's Day (January 1), Independence Day (July 4), Thanksgiving Day and Labor Day the rate applicable is the Evening rate unless a lower rate would normally apply.

g. Rates for Hearing or Speech Impaired Persons

- 1) Rates for certain MTS calls are reduced for a customer who meets the following requirements:
  - a) The customer is certified to the Company as having a hearing or speech impairment that prevents telephone voice communication.

GENERAL EXCHANGE TARIFF

Embarq Florida, Inc

By: F. B. Poag  
Director

SECTION A18  
Second Revised Sheet 18  
Cancelling First Revised Sheet 18  
Effective: January 30, 1998

LONG DISTANCE MESSAGE TELECOMMUNICATIONS SERVICE

D. TWO-POINT SERVICE (Cont'd)

1. Service Between Land Wire Telephones (Cont'd)

g. Rates for Hearing or Speech Impaired Persons (Cont'd)

1) (Cont'd)

b) The customer uses a telecommunications device for the deaf (TDD) or other non-voice equipment for telecommunications.

c) The customer makes written application to the Company for the reduced MTS rates.

d) The customer designates to the Company one and only one telephone number associated with that customer's service and telecommunications device. Reduced rates apply only to calls originated from this telephone number.

e) The reduced rates specified in Section A18.D.1.g.4) following apply for all Dial Station-to-Station Day and Evening calls originated from the designated telephone number.

2) Rates for certain MTS calls are reduced for an agency or business that assists hearing or speech impaired persons under the following conditions:

a) The agency or business provides non-voice telecommunications equipment (TDD) solely for the use of hearing or speech impaired persons or persons who communicate with hearing or speech impaired persons.

GENERAL EXCHANGE TARIFF

Embarq Florida, Inc

By: F. B. Poag  
Director

SECTION A18  
Second Revised Sheet 19  
Cancelling First Revised Sheet 19  
Effective: January 30, 1998

LONG DISTANCE MESSAGE TELECOMMUNICATIONS SERVICE

D. TWO-POINT SERVICE (Cont'd)

1. Service Between Land Wire Telephones (Cont'd)

g. Rates for Hearing or Speech Impaired Persons (Cont'd)

2) (Cont'd)

- b) The agency or business makes written application to the Company for the reduced MTS rates.
- c) The reduced rates are given as a credit on a subsequent bill.
- d) The reduced rates specified in Section A18.D.1.g.4) following apply for all Dial Station-to-Station Day and Evening calls placed between TDD's.

3) Rates for certain MTS calls are reduced for individuals equipped with TDD's for communicating with hearing or speech impaired persons under the following conditions:

- a) The customer uses a TDD or other non-voice equipment for communicating with other TDD's or non-voice equipment.
- b) The customer makes written application to the Company for reduced MTS rates.
- c) The reduced rates are given as a credit on a subsequent bill.
- d) The reduced rates specified in Section A18.D.1.g.4) following apply for all Dial Station-to-Station Day and Evening calls placed between TDD's



GENERAL EXCHANGE TARIFF

Embarq Florida, Inc

By: F. B. Poag  
Director

SECTION A18  
Second Revised Sheet 20  
Cancelling First Revised Sheet 20  
Effective: January 30, 1998

LONG DISTANCE MESSAGE TELECOMMUNICATIONS SERVICE

D. TWO-POINT SERVICE (Cont'd)

1. Service Between Land Wire Telephones (Cont'd)

g. Rates for Hearing or Speech Impaired Persons (Cont'd)

4) Applicable discounts

- a) A qualified call made in the Day rate period is rated at the Evening rate specified in Section A18.D.1.h following.
- b) A qualified call made in the Evening rate period is rated at the Night rate specified in Section A18.D.1.h following.

5) Telecommunications Relay Service

- a) In accordance with the Telecommunications Access System Act of 1991, calls to or from hearing and/or speech impaired persons may be completed through the Telecommunications Relay Service.
- b) The Relay Service may be accessed 24 hours per day from any location within the state via an 800 access number.
- c) Through assistance of a Relay Service Communications Assistant, the Relay Service will provide communication between persons using a Telecommunications Device for the Deaf (TDD) or ASCII device and persons using standard telephones through on-line translations.

GENERAL EXCHANGE TARIFF

Embarq Florida, Inc

By: F. B. Poag  
Director

SECTION A18  
Second Revised Sheet 21  
Cancelling First Revised Sheet 21  
Effective: January 30, 1998

LONG DISTANCE MESSAGE TELECOMMUNICATIONS SERVICE

D. TWO-POINT SERVICE (Cont'd)

1. Service Between Land Wire Telephones (Cont'd)

g. Rates for Hearing or Speech Impaired Persons (Cont'd)

5) Telecommunications Relay Service (Cont'd)

- d) MTS calls completed through the Relay Service will receive a 50% discount from the otherwise applicable rate with the exception of calls placed to or from persons with both hearing and visual impairments; calls placed to or from persons with dual impairments will receive a 60% discount from the otherwise applicable rate. These discounts apply only to the time sensitive elements of the MTS charges and shall not apply to optional surcharges such as any operator surcharge.

h. Rate Table

Rates shown in the following tables are applicable to intraLATA intrastate business between all points within the same LATA and within the State

GENERAL EXCHANGE TARIFF

Embarq Florida, Inc

SECTION A18

By: F. B. Poag  
Director

Ninth Revised Sheet 22  
Cancelling Eighth Revised Sheet 22  
Effective: November 12, 2004

LONG DISTANCE MESSAGE TELECOMMUNICATIONS SERVICE

D. TWO-POINT SERVICE (Cont'd)

1. Service Between Land Wire Telephones (Cont'd)

h. Rate Table (Cont'd)

1) Basic Rate Table for All Classes of Service

	<u>Day</u>	<u>Evening</u>	<u>Night</u>
<u>Rate Mileage</u>			
0 - 22	\$ .25	\$ .19	\$ .19
23 +	\$ .33	\$ .28	\$ .28

Rate Application

	<u>Mon</u>	<u>Tues</u>	<u>Wed</u>	<u>Thurs</u>	<u>Fri</u>	<u>Sat</u>	<u>Sun</u>
8:00 a.m. to 5:00 p.m. <sup>1</sup>	Day Rate	Day Rate	Day Rate	Day Rate	Day Rate	Night Rate	Night Rate
5:00 p.m. to 11:00 p.m. <sup>1</sup>	Evening Rate	Evening Rate	Evening Rate	Evening Rate	Evening Rate	Night Rate	Evening Rate
11:00 p.m. to 8:00 a.m. <sup>1</sup>	Night Rate	Night Rate	Night Rate	Night Rate	Night Rate	Night Rate	Night Rate

<sup>1</sup>To, but not including

GENERAL EXCHANGE TARIFF

Embarq Florida, Inc

BY: F. B. Poag  
Director

SECTION A18  
Sixth Revised Sheet 23  
Cancelling Fifth Revised Sheet 23  
Effective: October 24, 2003

LONG DISTANCE MESSAGE TELECOMMUNICATIONS SERVICE

D. TWO-POINT SERVICE (Cont'd)

1. Service Between Land Wire Telephones (Cont'd)

h. Rate Table (Cont'd)

2) Additional Charges

a) The following charges are in addition to the Basic Rate Table preceding when the call is placed using the following operator services:

(1) Station	<u>Charge Per Call</u>
(a) Customer Dialed Calling Card	\$ 1.00
(b) All other	1.50
(2) Person	
(a) All Calls	4.00

GENERAL EXCHANGE TARIFF

Embarq Florida, Inc

By: F. B. Poag  
Director

SECTION A18  
Fourth Revised Sheet 24  
Cancelling Third Revised Sheet 24  
Effective: July 21, 1998

LONG DISTANCE MESSAGE TELECOMMUNICATIONS SERVICE

RESERVED FOR FUTURE USE

GENERAL EXCHANGE TARIFF

Embarq Florida, Inc

By: F. B. Poag  
Director

SECTION A18  
Fourth Revised Sheet 25  
Cancelling Third Revised Sheet 25  
Effective: July 21, 1998

LONG DISTANCE MESSAGE TELECOMMUNICATIONS SERVICE

D. TWO-POINT SERVICE (Cont'd)

2. Service Through Mobile Telephone Service Base Stations

a. General

- 1) The regulations and rates set forth below apply for long distance message mobile telephone service furnished through the mobile telephone service base stations specified in Section A18.D.2.a 2) of this Tariff. Such service is in addition to that offered in Section A25., Interconnection of Mobile Services.
- 2) Long distance message mobile telephone service is a communication service through a base station between a mobile unit and a land wire telephone located outside the mobile service area associated with such base station, or between two mobile units served through different base stations having different rate centers.

GENERAL EXCHANGE TARIFF

Embarq Florida, Inc

By: F. B. Poag  
Director

SECTION A18  
First Revised Sheet 26  
Cancelling Original Sheet 26  
Effective: January 1, 1997

LONG DISTANCE MESSAGE TELECOMMUNICATIONS SERVICE

D. TWO-POINT SERVICE (Cont'd)

2. Service Through Mobile Telephone Service Base Stations (Cont'd)

a. General (Cont'd)

- 3) Long distance message mobile telephone service also includes service through a mobile telephone service base station between a land wire telephone or mobile unit, and another station which is authorized by the Federal Communications Commission to communicate with the mobile telephone service base station, or between two such other stations.
- 4) In the application of regulations and rates, stations other than mobile units which are authorized by the Federal Communications Commission to communicate with a mobile telephone service base station are considered as mobile units.
- 5) The party on the mobile unit placing or receiving a long distance call shall inform the mobile service operator, upon request, as to the state in which the mobile unit is located at the time of placing or receiving the call.
- 6) Mobile telephone service is available to mobile units equipped for this service when within range of a base station through which such service is furnished and subject to transmission, atmospheric and like limitations.

GENERAL EXCHANGE TARIFF

Embarq Florida, Inc

By: F. B. Poag  
Director

SECTION A18  
Fourth Revised Sheet 27  
Cancelling Third Revised Sheet 27  
Effective: February 1, 1999

LONG DISTANCE MESSAGE TELECOMMUNICATIONS SERVICE

D. TWO-POINT SERVICE (Cont'd)

2. Service Through Mobile Telephone Service Base Stations (Cont'd)

b. Rates

- 1) The rates between the applicable land wire telephone rate center and the rate center of the serving base station, or between the rate centers of two base stations are the schedules of rates as set forth in Section A18.D.1.h. of this Tariff. Such service is in addition to that offered in Section A25., Interconnection of Mobile Services.

3. Consumer Sense Local Toll

a. General

The Company's Consumer Sense Local Toll is furnished for Dial Station-to-Station intraLATA long distance calls originated in the Company's exchanges and is available in connection with individual residence and business lines. Customers subscribing to Consumer Sense Local Toll will be charged based on the Peak/Off Peak rate schedule specified below.

Customers subscribing to the Consumer Sense Local Toll plan may not subscribe to any other Optional Calling Plan offered by the Company



GENERAL EXCHANGE TARIFF

Embarq Florida, Inc

By: F. B. Poag  
Director

SECTION A18  
Second Revised Sheet 28  
Cancelling First Revised Sheet 28  
Effective: April 1, 1997

LONG DISTANCE MESSAGE TELECOMMUNICATIONS SERVICE

D. TWO-POINT SERVICE (Cont'd)

3. Consumer Sense Local Toll (Cont'd)

b. Regulations

- 1) Consumer Sense Local Toll applies to all intraLATA DDD long distance messages originated in the Company's exchanges.
- 2) The service will be ordered and billed on a per primary billing number (i.e., per account) basis. All applicable calls placed from lines associated with the same primary billing number will be included in the service.
- 3) Message details are included in the charges specified in Section A18.D.3.d. following.
- 4) The service is furnished for a minimum period of one month.
- 5) Changes to and from Consumer Sense Local Toll may be effective only on the subscriber's next bill date.
- 6) Consumer Sense Local Toll is not available to a customer who subscribes to any other Company-offered optional calling plan or for use with pay telephone service.

GENERAL EXCHANGE TARIFF

Embarq Florida, Inc

BY: F. B. Poag  
Director

SECTION A18  
Sixth Revised Sheet 29  
Cancelling Fifth Revised Sheet 29  
Effective: October 24, 2003

LONG DISTANCE MESSAGE TELECOMMUNICATIONS SERVICE

D. TWO-POINT SERVICE (Cont'd)

3. Consumer Sense Local Toll (Cont'd)

c. Applicability

The discounts offered under this Service apply to:

- 1) All direct-dialed intraLATA Message Telephone Service (MTS) originating calls in any of the Company's exchanges during a billing period.
- 2) The applicable discount amount is determined on the basis of intraLATA billed revenue to a single billing number.
- 3) Surcharges associated with Operator handled intraLATA toll traffic, as specified in Section A18.D.1.h. 2) will still be enforced.

d. Rates and Charges

- 1) The following rate schedule will apply:

	<u>Time Frame</u>	<u>Weekdays</u>	<u>Rate Per Minute</u>
Peak	7:00 a.m to 7:00 p.m.*	Monday-Friday	\$ .15 /Minute
Off-Peak	7:00 p.m. to 7:00 a.m.*	Monday-Friday	.15 /Minute
	All Hours	Saturday & Sunday	

\* Up to but not including.

GENERAL EXCHANGE TARIFF

Embarq Florida, Inc

SECTION A18

By: F. B. Poag  
Director

Third Revised Sheet 30  
Cancelling Second Revised Sheet 30  
Effective: November 27, 1998

LONG DISTANCE MESSAGE TELECOMMUNICATIONS SERVICE

D. TWO-POINT SERVICE (Cont'd)

4. Business Sense Local Toll

a. General

The Company's Business Sense Local Toll Service is furnished for Dial Station-to-Station intraLATA long distance calls originated in the Company's exchanges and is available in connection with business lines and work at home lines. Customers subscribing to Business Sense Local Toll Service will be charged based on a single flat-rate as specified in the schedule below. Customers subscribing to Business Sense Local Toll may not subscribe to any other Optional Calling Plan offered by the Company.

b. Regulations

- 1) Business Sense Local Toll applies to all intraLATA DDD long distance messages originated in the Company's exchanges.
- 2) The service will be ordered and billed on a per primary billing number (i.e., per account) basis. All applicable calls placed from lines associated with the same primary billing number will be included in the service.
- 3) Message details are included in the charges specified in Section A18.D.4.d. following.

GENERAL EXCHANGE TARIFF

Embarq Florida, Inc

SECTION A18

By: F. B. Poag  
Director

Third Revised Sheet 31  
Cancelling Second Revised Sheet 31  
Effective: November 27, 1998

LONG DISTANCE MESSAGE TELECOMMUNICATIONS SERVICE

D. TWO-POINT SERVICE (Cont'd)

4. Business Sense Local Toll (Cont'd)

b. Regulations (Cont'd)

- 4) The service is furnished with two monthly minimum commitments levels: \$50 a month and \$200 a month. If the customer's in-service level falls below the commitment level, the Company reserves the right to bill the customer for the entire commitment level. For example, a customer that commits to a \$200 monthly minimum, but only spends \$175 in a given month, may be billed \$200 for the month.
- 5) The service is furnished with an option of three term periods: no-term (i.e., month-to-month), one year and two years. The minimum period for the non-term plan is one month. The minimum period for the one year plan is 12 consecutive months. The minimum period for the two year plan is 24 months. If a customer chooses to discontinue participation on the plan prior to the expiration of the one year or two year term periods, the Company reserves the right to assess Termination Liability charges. The assessed charges would be based on the number of months remaining in the term plan and the minimum monthly commitment level agreed to by the customer.
- 6) Changes to and from Business Sense Local Toll Service may be effective only on the subscriber's next bill date.
- 7) Business Sense Local Toll is not available to a customer who subscribes to any other Company-offered optional calling plan or for use with pay telephone service.

GENERAL EXCHANGE TARIFF

Embarq Florida, Inc

By: F. B. Poag  
Director

SECTION A18  
Fifth Revised Sheet 32  
Cancelling Fourth Revised Sheet 32  
Effective: August 13, 1999

LONG DISTANCE MESSAGE TELECOMMUNICATIONS SERVICE

D. TWO-POINT SERVICE (Cont'd)

4. Business Sense Local Toll (Cont'd)

c. Applicability

The discounts offered under this Service apply to:

- 1) All direct-dialed intraLATA Message Telephone Service (MTS) originating calls in any of the Company's exchanges during a billing period.
- 2) The applicable discount number is determined on the basis of intraLATA billed revenue to a single billing number.

d. Rates and Charges

- 1) The following rate schedule will apply:

Business Sense Local Toll  
Rate Schedule

<u>Monthly Minimum Commitment Level</u>	<u>(Full Minute Rates*)</u>		
	<u>Non-Term</u>	<u>One Year</u>	<u>Two Year</u>
\$ 0	\$ .14	\$ .13	\$ .12
50.00	.13	.12	.11
200.00	.10	.09	.08

Time Frame: 24 Hours/Day, 7 Days/Week

\*Note: The above full minute rates bill in first 18 second minimum and additional 6 second increments.

GENERAL EXCHANGE TARIFF

Embarq Florida, Inc

By: F. B. Poag  
Director

SECTION A18  
Second Revised Sheet 33  
Cancelling First Revised Sheet 33  
Effective: April 1, 1997

LONG DISTANCE MESSAGE TELECOMMUNICATIONS SERVICE

D. TWO-POINT SERVICE (Cont'd)

5. Enterprise Service

a. General

- 1) Enterprise service is an arrangement whereby charges for toll messages will be reversed to the called customer without specific request of the calling party. It is not available for calls to a pay telephone.
- 2) The Company assigns a special call number designation for the use of patrons in each exchange (or group of exchanges for which telephone directories have been merged into one alphabetical list) in which the service is to be furnished. One directory listing in the alphabetical section is provided without charge for each such exchange (or group of exchanges for which telephone directories have been merged into one alphabetical list). Additional directory listings are provided a charges shown in the "Directory Listings" section of this tariff.
- 3) Calls for the special number designation are accepted only on a station-to-station basis and when originated at telephones located in the exchange(s) to which the special number has been assigned. Only those toll calls placed by calling the special number are considered as coming within the scope of service.
- 4) Customers subscribing to Enterprise Service assume all charges for completed calls made to their special numbers.

GENERAL EXCHANGE TARIFF

Embarq Florida, Inc

By: F. B. Poag  
Director

SECTION A18  
First Revised Sheet 34  
Cancelling Original Sheet 34  
Effective: January 1, 1997

LONG DISTANCE MESSAGE TELECOMMUNICATIONS SERVICE

D. TWO-POINT SERVICE (Cont'd)

5. Enterprise Service (Cont'd)

a. General (Cont'd)

- 5) Enterprise Service shall be retained for the full directory period where listings are published in a directory issue, and notice of discontinuance shall be given 30 days in advance of the closing date of subsequent directory issue.
- 6) Enterprise Service shall be retained for a minimum of one month where the service is listed in the Company's directory assistance files only.
- 7) The subscriber may request his service be nonpublished at the approved tariff rate, and thereby restrict Enterprise Service to such group of customers as he may advise.
- 8) If listings are desired, they are to be listed as follows:

Example:

Keller Music Co., 1206 W. Main Street, Leesburg, Fla, Dial "0" and ask for Leesburg Enterprise 787-3581 No toll charge for Enterprise Call

b. Rates and Charges

- 1) Each completed call is charged for at the established rate for a completed sent-paid station-to-station call.

GENERAL EXCHANGE TARIFF

Embarq Florida, Inc

By: F. B. Poag  
Director

SECTION A18  
Second Revised Sheet 35  
Cancelling First Revised Sheet 35  
Effective: January 30, 1998

LONG DISTANCE MESSAGE TELECOMMUNICATIONS SERVICE

D. TWO-POINT SERVICE (Cont'd)

5. Enterprise Service (Cont'd)

b. Rates and Charges (Cont'd)

2) In addition, a service charge applies as follows:

	Monthly Rate
For service from an exchange for which the directory listings are contained in an individual alphabetical list in the directory, or for service from one exchange in a group of exchanges which have been merged into one alphabetical list in the directory, per exchange	\$ 6.00

For service from any two or more of those exchanges for which the directory listings have been merged into one alphabetical list in the directory, per exchange	6.00
---	------

6. VALU-PAK Service (United Telephone Only)

a. General

VALU-PAK Service is an optional service which is available to all individual residence subscribers on which the calling number is automatically identified. The service permits these subscribers to place DDD intraLATA intrastate toll calls within certain specified hours at an additional 50 percent discount from the rated charge during the hours shown in Section A18.D.1.h. 3) following. This tariff in effect provides a 75 percent discount from the applicable Day rates shown in Section A18.D.1.h 1) preceding.



GENERAL EXCHANGE TARIFF

Embarq Florida, Inc

By: F. B. Poag  
Director

SECTION A18  
Second Revised Sheet 36  
Cancelling First Revised Sheet 36  
Effective: January 30, 1998

LONG DISTANCE MESSAGE TELECOMMUNICATIONS SERVICE

D. TWO-POINT SERVICE (Cont'd)

6. VALU-PAK Service (United Telephone Only) (Cont'd)

b. Regulations (Cont'd)

- 1) The service applies only to direct dial station-to-station intraLATA, intrastate toll messages originating from the subscriber's residence.
- 2) The service applies to calls placed during the hours of 11 p.m. to 8 a.m.<sup>1</sup> all days and 8 a.m. to 11 p.m.<sup>1</sup> Saturday.
- 3) The time at which connection is established governs whether message toll telephone rates or VALU-PAK Service rates apply.
- 4) Message details are not included in the charges specified in Section A18.D.1.h.
- 5) All usage of a multi line subscriber with one billing number is included in the service.
- 6) The service is furnished for a minimum period of one month.
- 7) Changes to and from VALU-PAK Service may be effective only on the subscriber's bill date.
- 8) The monthly rates for VALU-PAK Service will not be prorated except when the subscriber's service is connected or disconnected during a billing period.

<sup>1</sup> To, but not including.

GENERAL EXCHANGE TARIFF

Embarq Florida, Inc

By: F. B. Poag  
Director

SECTION A18  
Second Revised Sheet 37  
Cancelling First Revised Sheet 37  
Effective: January 30, 1998

LONG DISTANCE MESSAGE TELECOMMUNICATIONS SERVICE

D. TWO-POINT SERVICE (Cont'd)

6. VALU-PAK Service (United Telephone Only) (Cont'd)

c. Method of Determining Charges

- 1) All messages placed during the hours specified in Section A18.D.6.b. 2) preceding will be rated at the prevailing toll rate and accumulated throughout the subscriber's billing period.
- 2) At the end of the billing period the accumulated toll charges will be discounted and compared with the minimum monthly charge to determine if additional charges are applicable.
- 3) Additional charges will be applicable once the minimum charge has been exceeded.

d. Rates and Charges

- 1) Service Ordering Charges, as specified in Section A4 of this tariff, apply as appropriate when the service is ordered.

GENERAL EXCHANGE TARIFF

Embarq Florida, Inc

SECTION A18

By: F. B. Poag  
Director

Third Revised Sheet 38  
Cancelling Second Revised Sheet 38  
Effective: November 27, 1998

LONG DISTANCE MESSAGE TELECOMMUNICATIONS SERVICE

D. TWO-POINT SERVICE (Cont'd)

6. VALU-PAK Service (United Telephone Only) (Cont'd)

d. Rates and Charges (Cont'd)

2) The following monthly rates are applicable to VALU-PAK Service.

	<u>Monthly Charge</u>
a) Minimum Monthly Charge - Due in Advance	\$ 1.00
b) Charges beyond the minimum charge are payable on demand <sup>1</sup>	

7. Telesaver Service

a. General

Telesaver Service is an optional intraLATA long distance message service which is available in connection with individual residence, business and Centrex lines, as well as PBX trunks on which the calling number is automatically identified. The service permits these customers to place DDD intraLATA intrastate toll calls at a per minute flat-rate charge regardless of time of day or mileage, and without initial/additional minute rate distinction. In addition, Telesaver Service is available to customers who subscribe to the Company's Remote Call Forwarding arrangement.

<sup>1</sup> Additional charges will be rated at 50 percent of the rated charge during the hours specified in Section A18.D.6.b.2) preceding.

GENERAL EXCHANGE TARIFF

Embarq Florida, Inc

By: F. B. Poag  
Director

SECTION A18  
Third Revised Sheet 39  
Cancelling Second Revised Sheet 39  
Effective: November 27, 1998

LONG DISTANCE MESSAGE TELECOMMUNICATIONS SERVICE

D. TWO-POINT SERVICE (Cont'd)

7. Telesaver Service (Cont'd)

b. Regulations

- 1) Telesaver Service applies to all intraLATA intrastate DDD long distance messages.
- 2) The service will be ordered and billed on a per primary billing number (i.e., per account) basis. All applicable calls placed from lines associated with the same primary billing number will be included in the service.
- 3) Message details are included in the charges specified in Section A18.D.7.e. following.
- 4) The service is furnished for a minimum period of one month.
- 5) Changes to and from Telesaver Service may be effective only on the subscriber's next bill date.
- 6) The monthly rate for Telesaver Service will not be prorated except when the subscriber's service is connected or disconnected during a billing period.
- 7) Telesaver Service is not available to a customer who subscribes to any other Company-offered optional calling plan or for use with pay telephone service.

GENERAL EXCHANGE TARIFF

Embarq Florida, Inc

SECTION A18

By: F. B. Poag  
Director

Third Revised Sheet 40  
Cancelling Second Revised Sheet 40  
Effective: November 27, 1998

LONG DISTANCE MESSAGE TELECOMMUNICATIONS SERVICE

D. TWO-POINT SERVICE (Cont'd)

7. Telesaver Service (Cont'd)

b. Regulations (Cont'd)

- 8) This tariff sets forth the minimum, maximum and current rates for Telesaver Service. Following a 30-day notice to the Commission and existing subscribers, the Company may increase or decrease rates within the ranges specified in this tariff unless denied or suspended by the Commission.

c. Method of Determining Usage Charges

Usage is accumulated on a per message basis and rounded to the next whole minute. These minutes are aggregated for the billing period.

d. Rate Regulations

- 1) The fixed monthly rate (i.e., the per account minimum) in Section A18.D.7.e. following is billed in advance on a prorated basis for any partial month's service. The proration is calculated as the number of days the plan is in service divided by 30 days.
- 2) Additional usage, in excess of the minimum, is billed on a per minute of use basis.

GENERAL EXCHANGE TARIFF

Embarq Florida, Inc

By: F. B. Poag  
Director

SECTION A18  
Fourth Revised Sheet 41  
Cancelling Third Revised Sheet 41  
Effective: November 12, 2004

LONG DISTANCE MESSAGE TELECOMMUNICATIONS SERVICE

D. TWO-POINT SERVICE (Cont'd)

7. Telesaver Service (Cont'd)

e. Rates and Charges (Cont'd)

- 1) Service Ordering Charges, as specified in Section A4 of this tariff, apply as appropriate when the service is ordered.
- 2) The following rates and charges are applicable to Telesaver Service:

Monthly Recurring Rate

Residence	
60 minutes (1 hr)*	\$ 8.00
ea. additional minute	.15
Business	
120 minutes (2 hrs)*	17.00
ea. additional minute	.15
600 minutes (10 hrs)*	70.00
ea. additional minute	.13
1500 minutes (25 hrs)*	160.00
ea. additional minute	.12

\* Minimum per account, per month

GENERAL EXCHANGE TARIFF

Embarq Florida, Inc

By: F. B. Poag  
Director

SECTION A18  
Second Revised Sheet 41.1  
Cancelling First Revised Sheet 41.1  
Effective: November 28, 2002

LONG DISTANCE MESSAGE TELECOMMUNICATIONS SERVICE

D. TWO-POINT SERVICE (Cont'd)

8. Reserved for Future Use

GENERAL EXCHANGE TARIFF

Embarq Florida, Inc

By: F. B. Poag  
Director

SECTION A18  
Second Revised Sheet 41.2  
Cancelling First Revised Sheet 41.2  
Effective: November 28, 2002

LONG DISTANCE MESSAGE TELECOMMUNICATIONS SERVICE

D. TWO-POINT SERVICE (Cont'd)

8. Reserved for Future Use



GENERAL EXCHANGE TARIFF

Embarq Florida, Inc

By: F. B. Poag  
Director

SECTION A18  
First Revised Sheet 41.3  
Cancelling Original Sheet 41.3  
Effective: October 15, 1998

LONG DISTANCE MESSAGE TELECOMMUNICATIONS SERVICE

D. TWO-POINT SERVICE (Cont'd)

9. Simply Five

a. General

- 1) The Company's Simply Five is an optional Intrastate IntraLATA long distance flat rated service with rates which are non-distance sensitive. Simply Five is available only to subscribers who have selected The Company as the subscriber's primary intraLATA long distance carrier. Simply Five is available to residence and business customers. Customers subscribing to Simply Five will be charged the rates listed in A18.D.9.d. following.

b. Regulations

- 1) Simply Five applies to all IntraLATA 1+ Direct Distance Dialed (DDD), Station-to-Station long distance messages originating in the Company's exchanges.
- 2) The service will be ordered and billed on a per primary billing number (i.e., per account) basis. All applicable calls placed from lines associated with the same primary billing number will be included in the service.
- 3) Message details are included in the charges specified in A18.D.9.d. following.

c. Applicability

- 1) The service is furnished for a minimum period of one month.
- 2) Simply Five is not available to a customer who subscribes to any other Company offered optional calling plan or for use with pay telephone service.

GENERAL EXCHANGE TARIFF

Embarq Florida, Inc

SECTION A18

By: F. B. Poag  
Director

Second Revised Sheet 41.4  
Cancelling First Revised Sheet 41.4  
Effective: October 27, 1999

LONG DISTANCE MESSAGE TELECOMMUNICATIONS SERVICE

D. TWO-POINT SERVICE (Cont'd)

9. Simply Five (Cont'd)

c. Applicability (Cont'd)

- 3) This service allows a maximum monthly billed usage of 200, 500 or 2000 minutes. Monthly usage exceeding those amounts will be billed at the applicable Consumer Sense Local Toll Off-Peak rate, Section A18.D.3.d.1 or the Business Sense Local Toll \$0 Monthly Minimum Commitment Level, Non-Term rate, Section A18.D.4.d.1.

d. Rates and Charges

The following rate schedule shall apply 24 hours per day 7 days per week:

<u>Monthly Billed Minutes</u>	<u>Monthly Recurring Rate</u>	<u>Rate Per Minute<sup>1</sup></u>	<u>SAE Code</u>
1 to 200 201+	\$ 4.95	\$ .05 *	ASBEASC (5CE)
1 to 500 501+	\$14.95	\$ .05 *	ASBEASC (5C1)
1 to 2000 2001+	\$49.95	\$ .05 *	ASBEASC (5C2)

<sup>1</sup> Per minute applies to any minute or fraction thereof.

\* Consumer Sense Local Toll Off-Peak rate, Section A18.D.3.d.1 or Business Sense Local Toll \$0 Monthly Minimum Commitment Level, Non-Term rate, Section A18.D.4.d.1.

GENERAL EXCHANGE TARIFF

Embarq Florida, Inc

By: F. B. Poag  
Director

SECTION A18  
Second Revised Sheet 41.5  
Cancelling First Revised Sheet 41.5  
Effective: November 28, 2002

LONG DISTANCE MESSAGE TELECOMMUNICATIONS SERVICE

D. TWO-POINT SERVICE (Cont'd)

10. Reserved for Future Use

GENERAL EXCHANGE TARIFF

Embarq Florida, Inc

By: F. B. Poag  
Director

SECTION A18  
First Revised Sheet 42  
Cancelling Original Sheet 42  
Effective: January 1, 1997

LONG DISTANCE MESSAGE TELECOMMUNICATIONS SERVICE

E. CONFERENCE SERVICE (United Telephone Only)

1. General

- a. Long distance message telecommunications conference service is that of furnishing connections between three or more land telephone numbers within the same LATA on one connection at the same time.
- b. Service is furnished where and to the extent that facilities permit.
- c. All stations on a conference connection may be so interconnected that each may communicate with all the others or arrangements may be made whereby one station will be the transmitting station and all others receiving stations.
- d. One class of service only is offered whether the call is to specified persons or specified stations.
- e. The Company, upon request, will attempt to arrange for the establishment of a conference call at a specified time.

2. Rate and Charge Application

- a. The initial period is one minute or any fraction thereof and the additional period is one minute or fraction thereof.
- b. Rate airline distances are determined as provided in Section A18.E following.

GENERAL EXCHANGE TARIFF

Embarq Florida, Inc

By: F. B. Poag  
Director

SECTION A18  
Second Revised Sheet 43  
Cancelling First Revised Sheet 43  
Effective: January 30, 1998

LONG DISTANCE MESSAGE TELECOMMUNICATIONS SERVICE

E. CONFERENCE SERVICE (United Telephone Only) (Cont'd)

2. Rate and Charge Application (Cont'd)

c. Timing of Messages

1) Timing of messages as specified in Section A18.D.1.c. preceding will apply for conference service except:

a) Chargeable time begins when connection is established between all the persons or specified stations on the conference.

b) Chargeable time ends on a given two-point connection of a conference call when the connection is terminated by the originating station or the called party.

d. Charges for conference calls may, upon request, be reversed provided the total charge will be billed against one called station and the charge is accepted at the designated station.

e. Rates Applicable of Certain Holidays

On Christmas Day (December 25) and on New Year's Day (January 1), Independence Day (July 4), Thanksgiving Day and Labor Day the rate applicable is the Evening rate unless a lower rate would normally apply.

GENERAL EXCHANGE TARIFF

Embarq Florida, Inc

By: F. B. Poag  
Director

SECTION A18  
Second Revised Sheet 44  
Cancelling First Revised Sheet 44  
Effective: January 30, 1998

LONG DISTANCE MESSAGE TELECOMMUNICATIONS SERVICE

E. CONFERENCE SERVICE (United Telephone Only) (Cont'd)

3. Rates and Charges (Cont'd)

a. The total charge for the conference connection is the sum of:

- 1) The two-point Initial minute and Additional minute charges determined in accordance with Section A18.D.1.h.1) preceding for a call between the originating station and each called station on the conference.
- 2) The Person Additional Charge as determined in Section A18.D.1.h.2) for each called station.

GENERAL EXCHANGE TARIFF

Embarq Florida, Inc

By: F. B. Poag  
Director

SECTION A18  
First Revised Sheet 45  
Cancelling Original Sheet 45  
Effective: January 1, 1997

LONG DISTANCE MESSAGE TELECOMMUNICATIONS SERVICE

F. INTRALATA LONG DISTANCE VERIFICATION AND EMERGENCY INTERRUPT SERVICE

1. General

Verification and Emergency Interrupt Service is furnished where and to the extent that facilities permit. The customer shall indemnify and save the Company harmless against all claims that may arise from either party to the interrupted call or any person.

a. Verification

- 1) The Company furnishes Verification Service for the purpose of aiding subscribers with legitimate call completion problems. Upon request, the operator will verify and provide the line status condition of a subscriber line within the intraLATA calling area but outside the local calling area.
- 2) A subscriber-originated request for verification of an intraLATA long distance number other than an emergency agency number is a chargeable verification request if a Company operator determines that the line is in use. No charge applies if the line is out of order.

GENERAL EXCHANGE TARIFF

Embarq Florida, Inc

By: F. B. Poag  
Director

SECTION A18  
First Revised Sheet 46  
Cancelling Original Sheet 46  
Effective: January 1, 1997

LONG DISTANCE MESSAGE TELECOMMUNICATIONS SERVICE

G. INTRALATA LONG DISTANCE VERIFICATION AND EMERGENCY INTERRUPT SERVICE  
(Cont'd)

1. General (Cont'd)

b. Emergency Interrupt Service

- 1) The Company furnishes Emergency Interrupt Service when a subscriber who has originated a verification request to a line which has been found in a busy talking state informs the operator that an urgent or emergency situation exists and requests that the operator have the busy line cleared.
- 2) A subscriber-originated request for Emergency Interrupt to an intraLATA long distance number other than an emergency agency number is a chargeable Emergency Interrupt request.

2. Rates and Charges

- a. No charge will apply if the requesting customer identifies that the call is to or from an official public emergency agency. An official public emergency agency is defined as a government agency which is operated by the federal, state or local government, and has the capability and legal authority to provide prompt and direct aid to the public in emergency situations. Such agencies include the local police, state police, fire department, licensed hospitals, etc.



GENERAL EXCHANGE TARIFF

Embarq Florida, Inc

BY: F. B. Poag  
Director

SECTION A18  
Fifth Revised Sheet 47  
Cancelling Fourth Revised Sheet 47  
Effective: October 13, 2002

LONG DISTANCE MESSAGE TELECOMMUNICATIONS SERVICE

F. INTRALATA LONG DISTANCE VERIFICATION AND EMERGENCY INTERRUPT SERVICE  
(Cont'd)

2. Rates and Charges (Cont'd)

- b. Charges may not be billed on a collect basis or on a third-number basis to the number being verified or interrupted.
- c. If a number verified is not in use, or as a result of interrupt the line is cleared, and, at the calling party's request, the operator completes the call, the charges as specified in Section A18.D.1.h of this tariff apply in addition to the applicable verification and emergency interrupt charges.

	Nonrecurring <u>Charge</u>
d. Verification Request	
1) Each Request	\$2.00
e. Emergency Interrupt Request <sup>1</sup>	2.00

<sup>1</sup>A charge for Verification Request also applies.

GENERAL EXCHANGE TARIFF

Embarq Florida, Inc

By: F. B. Poag  
Director

SECTION A18  
Seventh Revised Sheet 48  
Cancelling Sixth Revised Sheet 48  
Effective: October 24, 2003

LONG DISTANCE MESSAGE TELECOMMUNICATIONS SERVICE

G. DIRECTORY ASSISTANCE SERVICE

1. General

The Company furnishes directory assistance for the purpose of aiding subscribers in obtaining telephone numbers.

When customers in Florida request assistance in obtaining telephone numbers of subscribers who are located outside their local calling area, the charges set forth following apply.

Directory Assistance Service for Outside the Local / Home Numbering Plan Area is not available for Pay Telephone Service as described in Section A7 of this tariff or Type 1 Mobile Service as described in Section A25 of this tariff.

2. Rates and Charges

a. A charge is applicable for each call to directory assistance except as noted following. (Maximum of two requested telephone numbers per call.)

1. Directory Assistance

	<u>Rate</u>
a) Home Numbering Plan Area	See Section A3. Directory Assistance
b) Outside Local/ Home Numbering Plan Area	See Section A3. Directory Assistance

b. There is no charge for Home Numbering Plan Area Directory Assistance calls received from customers with a physical or mental impairment rendering them unable to use the telephone directory.

c. In locations where the customer has the technical capability to direct dial Directory Assistance but places the call by dialing "0", Operator Assisted Station-to-Station Charges listed in Section A3.H.3.b. will apply, in addition to the Directory Assistance Service Charge.

GENERAL EXCHANGE TARIFF

Embarq Florida, Inc

By: F. B. Poag  
Director

SECTION A18  
Second Revised Sheet 49  
Cancelling First Revised Sheet 49  
Effective: June 3, 1997

LONG DISTANCE MESSAGE TELECOMMUNICATIONS SERVICE

H. DIRECTORY ASSISTANCE CALL COMPLETION (DACC)

1. General

- a. Directory Assistance Call Completion (DACC) provides an incoming Directory Assistance customer requesting an intraLATA number, a mechanized announcement offering call completion to the listed number requested. The call is completed on a sent-paid basis which is paid for by the calling customer, except on 0+HNPA+555 which will allow Calling Card and Billed To Third number Charges.
- b. The mechanized announcement will instruct the caller that for an additional charge they may have the call automatically completed by depressing a specific digit on the touch-tone key pad. All completed calls will be charged the DACC charge, in addition to any other appropriate charges. Customers may request blocking of DACC calls originating from their telephone lines by contacting the local Company business office.
- c. The Telephone Company assumes no responsibility or liability for any errors in the information furnished. The caller shall indemnify the Telephone Company and hold it free and harmless of and from any and all claims, demands or damages that shall arise from the use of the service.

(1) This service is furnished solely for the telephone calling purposes of the caller.

GENERAL EXCHANGE TARIFF

Embarq Florida, Inc

By: F. B. Poag  
Director

SECTION A18  
Second Revised Sheet 50  
Cancelling First Revised Sheet 50  
Effective: June 3, 1997

LONG DISTANCE MESSAGE TELECOMMUNICATIONS SERVICE

H. DIRECTORY ASSISTANCE CALL COMPLETION (DACC) (Cont'd)

1. General (Cont'd)

c. (Cont'd)

(2) Additional provisions concerning limitations of liability and allowance for interruption of service are set forth in Section A2 of this Tariff.

d. This offering provides call completion on a Local Access and Transport Area (LATA) basis.

e. DACC will be furnished only where facilities permit and where the service used by the customer can support all billing requirements for the service.

f. Only the second provided Directory Assistance telephone number may be dialed and completed by DACC if two Directory Assistance requests are made during the same call.

g. DACC is not available for the following:

(1) Alternately billed calls, e.g., Collect, Calling Card\*, or Billed to Third Number\*

(2) Any PBX type customer who requires real-time notification of charges; i.e., hotels/motels, hospitals, etc.

\* On 0+HNPA+555 calls, Calling Card and Billed to Third Number Charges will be allowed.

GENERAL EXCHANGE TARIFF

Embarq Florida, Inc

SECTION A18

By: F. B. Poag  
Director

Third Revised Sheet 51  
Cancelling Second Revised Sheet 51  
Effective: August 7, 2002

LONG DISTANCE MESSAGE TELECOMMUNICATIONS SERVICE

H. DIRECTORY ASSISTANCE CALL COMPLETION (DACC) (Cont'd)

1. General (Cont'd)

g. (Cont'd)

- (3) Any special lines; i.e., prisons/inmate, colleges/universities, etc.
- (4) 900/976 directory assistance number requests
- (5) Calls from tandems where the end user cannot be identified.
- (6) Calls from pay telephone stations
- (7) InterLATA long distance calls
- (8) Cellular providers/mobile telephone users
- (9) Independent telephone companies that access the Company's directory assistance service.
- (10) WATS

h. Individual message detail is not included as part of this service.

i. DACC is not subject to concessions.

GENERAL EXCHANGE TARIFF

Embarq Florida, Inc

By: F. B. Poag  
Director

SECTION A18  
Fourth Revised Sheet 52  
Cancelling Third Revised Sheet 52  
Effective: August 13, 1999

LONG DISTANCE MESSAGE TELECOMMUNICATIONS SERVICE

H. DIRECTORY ASSISTANCE CALL COMPLETION (DACC) (Cont'd)

2. Rates and Charges

- a. The DACC service charge specified will be applicable to all subscribers; except, DACC service charges are not applicable to handicapped customers who are exempt from Directory Assistance charges.
- b. For charging purposes, a completed call is as defined in Section A1 of this Tariff.
- c. Service Charges

	<u>Rate</u>
DACC service charge per completed call	\$ .50

GENERAL EXCHANGE TARIFF

Embarq Florida, Inc

By: F. B. Poag  
Director

SECTION A18  
Third Revised Sheet 53  
Cancelling Second Revised Sheet 53  
Effective: June 5, 1998

LONG DISTANCE MESSAGE TELECOMMUNICATIONS SERVICE

RESERVED FOR FUTURE USE

GENERAL EXCHANGE TARIFF

Embarq Florida, Inc

By: F. B. Poag  
Director

SECTION A18  
Fourth Revised Sheet 54  
Cancelling Third Revised Sheet 54  
Effective: June 5, 1998

LONG DISTANCE MESSAGE TELECOMMUNICATIONS SERVICE

RESERVED FOR FUTURE USE



GENERAL EXCHANGE TARIFF

Embarq Florida, Inc.

SECTION A19

By: F. B. Poag  
Director

First Revised Contents Sheet 1  
Original Contents Sheet 1  
Effective: January 1, 1997

WIDE AREA TELECOMMUNICATIONS SERVICE

CONTENTS

	<u>SHEET</u>
A. GENERAL .....	1
B. USE OF THE SERVICE .....	4
C. LIMITATION OF SERVICE .....	5
D. RATES AND CHARGES.....	7
1. Recurring Rate Structure.....	7
2. Rate Tables .....	10
3. Method of Determining Usage Charges.....	17
4. Fractional Periods .....	19
5. Installation Charges.....	20
6. Four-Wire Termination Arrangement .....	29
7. Access Line Terminations .....	29
8. Access Line Extensions .....	30
9. Minimum Average Time Requirement.....	31
10. Minimum Service Period .....	32
11. Allowance for Interruptions.....	32
12. Timing of Calls.....	34
13. Directory Listing (TFC Service Only).....	35
E. OPPORTUNITY 800 SERVICE .....	36
1. Description .....	36
2. Regulations .....	36
3. Rates and Charges .....	39

GENERAL EXCHANGE TARIFF

Embarq Florida, Inc.

By: F. B. Poag  
Director

SECTION A19  
First Revised Contents Sheet 2  
Original Contents Sheet 2  
Effective: January 1, 1997

WIDE AREA TELECOMMUNICATIONS SERVICE

CONTENTS

	<u>SHEET</u>
F. EXPEDITED ORDER CHARGE FOR WATS/800 SERVICES.....	40
1. General.....	40
2. Company Critical Dates.....	42
3. Provisioning Table.....	45

## GENERAL EXCHANGE TARIFF

Embarq Florida, Inc.

By: F. B. Poag  
Director

SECTION A19  
Second Revised Sheet 1  
Cancelling First Revised Sheet 1  
Effective: May 29, 1997

### WIDE AREA TELECOMMUNICATIONS SERVICE

#### A. GENERAL

1. Wide Area Telecommunications Service (WATS) is the furnishing of facilities by the Company and, when applicable, an interLATA carrier for dial type telecommunications between a station associated with a WATS access line and stations using the public switched network within the State of Florida in accordance with the regulations and schedule of charges specified in this tariff and, when applicable, the tariff of the interLATA carrier. The WATS charges set forth in this tariff are in payment for the service furnished between the calling and called stations within Florida. For Combined Toll Free Code (TFC) Service the intraLATA and interLATA portions are only offered in combination with each other and may not be subscribed to separately. For Outward WATS, the intraLATA service may be subscribed to separately, or may be offered in combination with an interLATA WATS. For bi-jurisdictional WATS Access Line "1+" and "0" intraLATA usage, refer to D.1.e following.
  - a. The rates and charges specified herein for WATS provide for a WATS access line. The WATS access line consists of all Central Office line equipment and all outside plant facilities up to and including the Company provided Network Interface as defined in Section A1 of this tariff.
  - b. WATS access line extensions associated with an intraLATA WATS access line must be located within the same LATA as the WATS access line.<sup>1</sup> WATS access line extensions associated with an intraEAEA WATS access line must be located within the same EAEA<sup>2</sup> as the WATS access line.
  - c. Jack charges for Company provided jacks, other than the Network Interface used in association with WATS will be provided on a deregulated basis.

Note 1: Refer to the interLATA carrier's tariff for rates and charges applicable to WATS access line extensions terminated in a LATA other than the WATS access line.

Note 2: Refer to Section E10.2.2 of the Florida Access Service Tariff for the definition of EAEA.

GENERAL EXCHANGE TARIFF

Embarq Florida, Inc.

By: F. B. Poag  
Director

SECTION A19  
First Revised Sheet 2  
Original Sheet 2  
Effective: January 1, 1997

WIDE AREA TELECOMMUNICATIONS SERVICE

A. GENERAL (Cont'd)

2. Dial type telecommunications as specified in Section A1 preceding, is a call dialed and completed from or to a WATS access line without the assistance of a Company Operator, except that a Company operator will reestablish a call which has been interrupted after the called number has been reached.
3. Each WATS access line will be arranged at the customer's option for either outward WATS or TFC service but not for both, subject to the provisions and regulations outlined herein and in Section A2 of this tariff.
4. WATS arranged for statewide<sup>1</sup> or combined outward service provides for the origination of calls from a station associated with WATS for telecommunications with stations within this State by way of the WATS access line and the public switched network.
5. WATS arranged for intraLATA only outward service provides for the origination of calls from a station associated with WATS for telecommunications with stations within the same LATA within Florida by way of the WATS access line and the public switched network.
6. WATS arranged for intraEAEA only outward service provides for the origination of calls from a station associated with WATS for telecommunications with stations within the same EAEA within Florida by way of the WATS access line and the public switched network.
7. WATS arranged for interLATA only outward service provides for the origination of calls from a station associated with WATS for telecommunications with stations in a different LATA and the same state by way of the WATS access line and the public switched network.<sup>1</sup>

Note 1: Refer to the interLATA carrier's tariff for rates applicable to interLATA usage. Refer to the statewide carrier's tariff for rates applicable to statewide usage.

GENERAL EXCHANGE TARIFF

Embarq Florida, Inc.

By: F. B. Poag  
Director

SECTION A19  
First Revised Sheet 3  
Original Sheet 3  
Effective: January 1, 1997

WIDE AREA TELECOMMUNICATIONS SERVICE

A. GENERAL (Cont'd)

8. Combined intraLATA/interLATA TFC service provides for the termination of calls from stations within this State, for telecommunications with a station associated with a TFC service access line located within this State. The interLATA and statewide carrier's tariff should be referred to for rates applicable to interLATA usage.
9. WATS is furnished only if the necessary facilities are available in the offices technically capable of providing the service.
10. Combined outward WATS is furnished only in offices where the interLATA carrier has purchased appropriate Feature Groups C or D access facilities.
11. Directory Assistance Service for customers requesting telephone numbers of subscribers who are located outside their local calling area but within the same Number Plan Area is furnished under the provision of Section A18 of this tariff. Such calls will be included in the determination of WATS usage charges.
12. Service groups
  - a. The term "Service Group" as used in connection with outward WATS denotes one or more Outward WATS access lines for the same service area terminated in the same multi-line terminating system at the same premises.
  - B. The term "Service Group" as used in connection with TFC Service denotes the access lines arranged in Central Office equipment furnished by the Company as part of a given hunting arrangement.

GENERAL EXCHANGE TARIFF

Embarq Florida, Inc.

By: F. B. Poag  
Director

SECTION A19  
First Revised Sheet 4  
Original Sheet 4  
Effective: January 1, 1997

WIDE AREA TELECOMMUNICATIONS SERVICE

B. USE OF THE SERVICE

1. WATS is provided for use by the subscriber and may be used by others, when so authorized by the subscriber, providing that all such usage shall be subject to the provisions of this tariff.
2. Orders, including installation, rearrangements, or discontinuance of service, will be accepted by the Company only from the customer.
3. Resale or shared use of WATS is permitted. Exchange access to such resold or shared services will be provided via business exchange service at rates and charges for flat rate PBX trunks as specified in Section A3 of this tariff. Entities reselling intrastate WATS are required to obtain a Certificate of Public Convenience and Necessity from the Florida Public Service Commission.
4. The service is furnished subject to the condition that all applicable regulations stipulated in Section A2 of this tariff will be adhered to and that there will be no abuse or fraudulent use of the service. Abuse or fraudulent use of the service includes:
  - a. The placing or acceptance of a WATS call by a WATS subscriber, his agent, employee, or representative, in response to an uncompleted long distance call which was not completed in order to transmit or receive intelligence without payment of the applicable long distance charge.
  - b. The obtaining, or attempting to obtain, or assisting another to obtain, or to attempt to obtain, WATS by arranging, tampering with, or making connection with any facilities of the Company, or by any trick, scheme, false representation, or false credit device, or by or through any other fraudulent means or device whatsoever, with intent to avoid the payment, in whole or in part, of the regular charge for such service.

GENERAL EXCHANGE TARIFF

Embarq Florida, Inc.

By: F. B. Poag  
Director

SECTION A19  
First Revised Sheet 5  
Original Sheet 5  
Effective: January 1, 1997

WIDE AREA TELECOMMUNICATIONS SERVICE

B. USE OF THE SERVICE (Cont'd)

5. WATS is available for use with customer-provided data transmitting and receiving equipment, including telewriter equipment, and teletypewriter equipment for the transmission and reception of data signals.
6. TFC service facilities are available for use with Public Announcement Services and are subject to the provisions and regulations outlined herein and in Section A2 of this tariff.

C. LIMITATION OF SERVICE

1. WATS does not include person-to-person, collect, conference, or other calls requiring operator handling except as provided in A.2. preceding.
2. WATS is not represented as adapted for connection to other services of the Company. This service contemplates the provision of satisfactory transmission only between the access line and the called or calling station.
3. Extensions from WATS access lines are restricted to the use of the subscriber, his representatives and associates and are furnished only on the same or different premises of the same subscriber except that extensions from TFC service may be located on other than the subscriber's premises for the purpose of answering calls when the subscriber is not available at the main station and except that WATS access line extensions may be shared, provided those extension lines are located on the customer's premises.
4. Connection of WATS to other services is permitted on a switched basis only. No permanent connection between WATS and other service may be established. However, satisfactory transmission cannot be assured when the WATS access line is connected to other Company services or to customer-provided equipment or services.

GENERAL EXCHANGE TARIFF

Embarq Florida, Inc.

By: F. B. Poag  
Director

SECTION A19  
First Revised Sheet 6  
Original Sheet 6  
Effective: January 1, 1997

WIDE AREA TELECOMMUNICATIONS SERVICE

C. LIMITATION OF SERVICE (Cont'd)

5. WATS may be terminated at a premises where telecommunications management functions are performed on behalf of the customer only if the customer has a requirement to communicate over the WATS line to or from premises of that customer located in the State of Florida. In such cases the premises where telecommunications management functions are performed will be considered a customers premises. WATS access lines and extensions will be terminated only at premises located within this State.
6. TFC service is furnished upon condition that the customer accepts and makes use of the terminations or connections provided in accordance with A.5. preceding, and that the customer obtain a sufficient number of access lines to prevent the percent of calls completed to calls attempted (including busy and unanswered calls) from falling below 50% for two consecutive months. Customers falling below the 50% level of completions will be required to subscribe to additional access lines to handle the incoming calls with at least a 50% completion level. Should the customer refuse to subscribe to these lines, the Company, without incurring any liability, may terminate the TFC service, provided that, in case of termination by mail or in person of the Company's intention to terminate the service for such cause.
7. Any arrangement permitting customer control of the number of calls completed to a TFC service access line is not permitted.



GENERAL EXCHANGE TARIFF

Embarq Florida, Inc.

By: F. B. Poag  
Director

SECTION A19  
First Revised Sheet 7  
Original Sheet 7  
Effective: January 1, 1997

WIDE AREA TELECOMMUNICATIONS SERVICE

C. LIMITATION OF SERVICE (Cont'd)

D. RATES AND CHARGES

1. Recurring Rate Structure

- a. The separate recurring usage rate structures of the Company and the interLATA carrier providing combined intraLATA/interLATA outward WATS or TFC Service are based in separate identification of intraLATA and interLATA usage as directed by the Commission.
- b. For TFC service combined outward WATS, and intraLATA outward WATS, the intraLATA usage is applied to the Schedule of Monthly Usage Charges In D.2.c. following, and the interLATA usage is applied to the approved tariff rates of the interLATA carrier. For intraEAEA outward WATS, the intraEAEA usage is applied to the schedule of Monthly Usage Charges in D.2.c. following.
- c. The schedule of Monthly Usage Charges in D.2.c. requires a separate monthly charge for each access line in a service group independent of usage on that line or service group.

GENERAL EXCHANGE TARIFF

Embarq Florida, Inc.

By: F. B. Poag  
Director

SECTION A19  
Second Revised Sheet 8  
Cancelling First Revised Sheet 8  
Effective: May 29, 1997

WIDE AREA TELECOMMUNICATIONS SERVICE

D. RATES AND CHARGES (Cont'd)

1. Recurring Rate Structure (Cont'd)

- d. Monthly usage charges for a service group are computed on an average usage per line basis according to the tapered schedule. Hourly rates for each additional hour of use decrease at defined levels of use called taper points.
- e. WATS Access Lines Arranged for Bi-jurisdictional Use

The following parameters apply only to WATS access lines arranged for bi-jurisdictional use.

- 1) Central Telephone Only. "1+" and "0" intraLATA usage carried over WATS access lines, having both intra- and interstate capability (bi-jurisdictional) and provided from the Interstate Access Tariff, will be completed over Company facilities at Company intraLATA WATS rates and subject to rules and regulations applicable to Company intraLATA WATS. The "1+" and "0" intraLATA usage will be billed to the customer (end user or IXC) where the closed end of the bi-jurisdictional WATS access line is terminated. Customer billing information must be provided to the Company at the time the bi-jurisdictional WATS access line is ordered. Local calling and seven digit access to originating intrastate Feature Groups A and B are prohibited.

GENERAL EXCHANGE TARIFF

Embarq Florida, Inc.

By: F. B. Poag  
Director

SECTION A19  
First Revised Sheet 9  
Original Sheet 9  
Effective: January 1, 1997

WIDE AREA TELECOMMUNICATIONS SERVICE

D. RATES AND CHARGES (Cont'd)

1. Recurring Rate Structure (Cont'd)

e. WATS Access Lines Arranged for Bi-jurisdictional Use (Cont'd)

The following parameters apply only to WATS access lines arranged for bi-jurisdictional use. (Cont'd)

- 2) United Telephone Only. "1+" and "0" intraLATA usage carried over WATS access lines, having both intra- and interstate capability (bi-jurisdictional) and provided from the Interstate Access Tariff, will be completed over LEC facilities at LEC intraLATA WATS rates and subject to rules and regulations applicable to LEC intraLATA WATS. The "1+" and "0" intraLATA usage will be billed to the customer (end user or IXC) where the closed end of the bi-jurisdictional WATS access line is terminated. Customer billing information must be provided to the Company at the time the bi-jurisdictional WATS access line is ordered.
- 3) Local calling and seven digit access to originating FGA and FGB are prohibited.

GENERAL EXCHANGE TARIFF

Embarq Florida, Inc.

By: F. B. Poag  
Director

SECTION A19  
Second Revised Sheet 10  
Cancelling First Revised Sheet 10  
Effective: May 29, 1997

WIDE AREA TELECOMMUNICATIONS SERVICE

D. RATES AND CHARGES (Cont'd)

2. Rate Tables

a. Access Line Charges <sup>1,2</sup>

United Telephone Only

Monthly  
Rate

1) Outward, complex

- |  |         |
|--|---------|
| a) For combined intraLATA/interLATA service with the assistance of a Company Operator <sup>3</sup> , each    | \$38.00 |
| b) For combined intraLATA/interLATA service without the assistance of a Company Operator <sup>3</sup> , each | \$38.00 |
| c) For intraLATA service only, each  | \$38.00 |
| d) For intraEAEA service only <sup>4</sup> , each  | \$38.00 |
| e) For statewide carrier service, each   | \$38.00 |

Note 1: For access line charges applicable to interLATA service, refer to Florida Access Service Tariff Section E6.8.4.A.1.

Note 2: The dedicated access line monthly rates will be reduced by the amount of the gross receipts tax for certified vendors of telecommunications services.

Note 3: See A.2.

Note 4: The technical capability to provide this service is not available at this time. This service is included in this tariff per the Florida Public Service Commission Order No. 14621.

GENERAL EXCHANGE TARIFF

Embarq Florida, Inc.

By: F. B. Poag  
Director

SECTION A19  
First Revised Sheet 11  
Original Sheet 11  
Effective: January 1, 1997

WIDE AREA TELECOMMUNICATIONS SERVICE

D. RATES AND CHARGES (Cont'd)

2. Rate Tables (Cont'd)

a. Access Line Charges <sup>1,2</sup> (Cont'd)

United Telephone Only

	<u>Monthly Rate</u>
2) Outward, simple	
a) For combined intraLATA/interLATA service with the assistance of a Company operator <sup>3</sup> , each	\$37.45
b) For combined intraLATA/interLATA service without the assistance of a Company operator <sup>3</sup> , each	\$37.45
c) For intraLATA service only, each	\$37.45
d) For intraEAEA service only <sup>4</sup> , each	\$37.45
e) For statewide carrier service, each	\$37.45

Note 1: For access line charges applicable to interLATA service, refer to Florida Access Service Tariff Section E6.8.3.

Note 2: The dedicated access line monthly rates will be reduced by the amount of the gross receipts tax for certified vendors of telecommunications services.

Note 3: See A.2.

Note 4: The technical capability to provide this service is not available at this time. This service is included in this tariff per the Florida Public Service Commission Order No. 14621.

GENERAL EXCHANGE TARIFF

Embarq Florida, Inc.

By: F. B. Poag  
Director

SECTION A19  
First Revised Sheet 12  
Original Sheet 12  
Effective: January 1, 1997

WIDE AREA TELECOMMUNICATIONS SERVICE

D. RATES AND CHARGES (Cont'd)

2. Rate Tables (Cont'd)

a. Access Line Charges <sup>1,2</sup> (Cont'd)

3) TFC service, complex

For statewide service in conjunction with  
an interLATA carrier, each \$38.00

4) TFC service, simple

For statewide service in conjunction with  
an interLATA carrier, each \$37.45

Central Telephone

5) All WATS services<sup>3</sup>

	<u>Monthly Rate</u>
a) IntraLATA WATS, each	\$38.00
b) InterLATA WATS, each	\$38.00
c) IntraEAEA WATS, each	\$38.00
d) Combined intraLATA/interLATA, each	\$38.00

Note 1: For access line charges applicable to interLATA service, refer to Florida Access Service Tariff Section E6.8.3.

Note 2: The dedicated access line monthly rates will be reduced by the amount of the gross receipts tax for certified vendors of telecommunications services.

Note 3: In the Central Telephone area, the published rate will be reduced by 1.5% when charged to another vendor of telecommunications services pursuant to Docket No. 820537-TP, Order No. 15590, issued January 27, 1986.

GENERAL EXCHANGE TARIFF

Embarq Florida, Inc.

By: F. B. Poag  
Director

SECTION A19  
First Revised Sheet 13  
Original Sheet 13  
Effective: January 1, 1997

WIDE AREA TELECOMMUNICATIONS SERVICE

D. RATES AND CHARGES (Cont'd)

2. Rate Tables (Cont'd)

Central Telephone (Cont'd)

a. Access Line Charges<sup>1,2</sup> (Cont'd)

	<u>Monthly Rate</u>
5) All WATS services <sup>3</sup> (Cont'd)	
e) Combined intraLATA/interLATA TFC service, each	\$38.00
f) IntraLATA TFC service, each	\$38.00
g) InterLATA TFC service, each	\$38.00

Note 1: For access line charges applicable to interLATA service, refer to Florida Access Service Tariff Section E6.8.3.

Note 2: The dedicated access line monthly rates will be reduced by the amount of the gross receipts tax for certified vendors of telecommunications services.

Note 3: In the Central Telephone area, the published rate will be reduced by 1.5% when charged to another vendor of telecommunications services pursuant to Docket No. 820537-TP, Order No. 15590, issued January 27, 1986.

GENERAL EXCHANGE TARIFF

Embarq Florida, Inc.

By: F. B. Poag  
Director

SECTION A19  
First Revised Sheet 14  
Original Sheet 14  
Effective: January 1, 1997

WIDE AREA TELECOMMUNICATIONS SERVICE

D. RATES AND CHARGES (Cont'd)

2. Rate Tables (Cont'd)

b. Rate Periods

Rates applicable are based on the time of day, day of week as follows:

1) Business Day Period

8 AM to 5 PM, Monday through Friday.

2) Evening Period

5 PM to 11 PM Sunday through Friday, and holidays (New Year's Day, Independence Day, Thanksgiving Day, and Christmas Day).

3) Night/Weekend Period

11 PM to 8 AM all days  
8 AM to 11 PM Saturday  
8 AM to 5 PM Sunday.



GENERAL EXCHANGE TARIFF

Embarq Florida, Inc.

By: F. B. Poag  
Director

SECTION A19  
First Revised Sheet 15  
Original Sheet 15  
Effective: January 1, 1997

WIDE AREA TELECOMMUNICATIONS SERVICE

D. RATES AND CHARGES (Cont'd)

2. Rate Tables (Cont'd)

c. Monthly Usage Charges

The hourly rates apply to the average usage of each access line for each rate period within a service group rounded to the nearest tenth of an hour.

1) Outward WATS - intraLATA portion, per hour of use<sup>1</sup>

	<u>Day</u>	<u>Evening</u>	<u>N/Wknd</u>
<u>United Telephone Only</u>			
0 - 10 hours	\$14.97	\$10.33	\$5.99
10.1 - 25 hours	13.61	9.39	5.99
25.1 - 50 hours	12.25	8.45	5.99
50.1 - 80 hours	10.89	7.51	5.99
Over 80 hours	9.53	6.57	5.99
<u>Central Telephone Only</u>			
0 - 10 hours	\$13.20	\$9.10	\$5.30
10.1 - 25 hours	12.00	8.30	5.30
25.1 - 50 hours	10.80	7.45	5.30
50.1 - 80 hours	9.60	6.60	5.30
Over 80 hours	8.40	5.80	5.30

Note 1: For combined outward WATS, the interLATA usage charge as contained in the interLATA carrier's tariff will apply to the interLATA usage.

GENERAL EXCHANGE TARIFF

Embarq Florida, Inc.

By: F. B. Poag  
Director

SECTION A19  
First Revised Sheet 16  
Original Sheet 16  
Effective: January 1, 1997

WIDE AREA TELECOMMUNICATIONS SERVICE

D. RATES AND CHARGES (Cont'd)

2. Rate Tables (Cont'd)

c. Monthly Usage Charges (Cont'd)

2) Outward WATS - intraEAEA portion, per hour of use<sup>1</sup>

	<u>Day</u>	<u>Evening</u>	<u>N/Wknd</u>
<u>United Telephone Only</u>			
0 - 10 hours	\$14.97	\$10.33	\$5.99
10.1 - 25 hours	13.61	9.39	5.99
25.1 - 50 hours	12.25	8.45	5.99
50.1 - 80 hours	10.89	7.51	5.99
Over 80 hours	9.53	6.57	5.99
<u>Central Telephone Only</u>			
0 - 10 hours	\$13.20	\$9.10	\$5.30
10.1 - 25 hours	12.00	8.30	5.30
25.1 - 50 hours	10.80	7.45	5.30
50.1 - 80 hours	9.60	6.60	5.30
Over 80 hours	8.40	5.80	5.30

Note 1: The technical capability to provide this service is not available at this time. This service is included in this tariff per the Florida Public Service Commission Order No. 14621.

GENERAL EXCHANGE TARIFF

Embarq Florida, Inc.

By: F. B. Poag  
Director

SECTION A19  
First Revised Sheet 17  
Original Sheet 17  
Effective: January 1, 1997

WIDE AREA TELECOMMUNICATIONS SERVICE

D. RATES AND CHARGES (Cont'd)

2. Rate Tables (Cont'd)

c. Monthly Usage Charges (Cont'd)

3) TFC Service - intraLATA portion, per hour of use

	<u>Day</u>	<u>Evening</u>	<u>N/Wknd</u>
<u>United Telephone Only</u>			
0 - 10 hours	\$15.94	\$11.28	\$6.53
10.1 - 25 hours	14.02	9.84	6.53
25.1 - 50 hours	11.95	8.36	6.53
50.1 - 80 hours	11.04	7.73	6.53
Over 80 hours	10.08	7.15	6.53
<u>Central Telephone Only</u>			
0 - 10 hours	\$14.95	\$10.60	\$6.10
10.1 - 25 hours	13.15	9.25	6.10
25.1 - 50 hours	11.20	7.85	6.10
50.1 - 80 hours	10.35	7.25	6.10
Over 80 hours	9.45	6.70	6.10

3. Method of determining usage charges

a. For combined intraLATA/interLATA outward WATS or intraLATA outward WATS, apply the following to the intraLATA calls and usage. For intraEAEA WATS, apply the following to the intraEAEA calls and usage. For statewide TFC service provided in conjunction with an interLATA carrier, apply the following to only the intraLATA TFC calls and usage.

1) Determine the total number of completed calls for the service group for each rate period.

GENERAL EXCHANGE TARIFF

Embarq Florida, Inc.

By: F. B. Poag  
Director

SECTION A19  
First Revised Sheet 18  
Original Sheet 18  
Effective: January 1, 1997

WIDE AREA TELECOMMUNICATIONS SERVICE

D. RATES AND CHARGES (Cont'd)

3. Method of determining usage charges (Cont'd)

a. (Cont'd)

- 2) Determine the equivalent hours used for each rate period by applying the minimum average time requirement of 30 seconds (1 call x 30 seconds).
- 3) Determine the total actual hours used for each rate period for each service group, rounded to the nearest tenth (one decimal place).
- 4) Determine the total chargeable hours for each rate period for each service group. This is the greater of D.3.a.(2) or D.3.a.(3) preceding, rounded to the nearest tenth (one decimal place).
- 5) Determine the number of access lines, within each service group, in service during the month. Access lines in service for a fraction of a month are based on the number of days in service divided by 30 days. The result is rounded to the nearest hundredth (two decimal places). The same number of access lines is used for each rate period.
- 6) Determine the average usage for each rate period for each access line in each service group by dividing chargeable hours in D.3.a.(4) preceding by the number of access lines in D.3.a.(5) preceding.

GENERAL EXCHANGE TARIFF

Embarq Florida, Inc.

By: F. B. Poag  
Director

SECTION A19  
First Revised Sheet 19  
Original Sheet 19  
Effective: January 1, 1997

WIDE AREA TELECOMMUNICATIONS SERVICE

D. RATES AND CHARGES (Cont'd)

3. Method of determining usage charges (Cont'd)

a. (Cont'd)

- 7) Determine the usage charge per rate period for each access line by multiplying the hourly rate in the appropriate taper(s) by the number of hours used in each taper and totaling these charges.<sup>1, 2</sup>
- 8) Determine the total usage charge for each rate period for each service group by multiplying the usage charge per rate period in D.3.a.(7) preceding by the number of access lines in D.3.a.(5) preceding.
- 9) Determine the total usage charge in a service group for all rate periods by adding the results from each rate period in D.3.a.(8) preceding.

4. Fractional Periods

- a. The charges for a fractional part of a month will be a proportionate part of the monthly recurring charge based on the actual number of days the service is provided plus the usage charges applicable for that month.

Note 1: If the subscriber had service for a fraction of a month, the usage charge applicable will be the actual usage charge divided by 30 days times the number of days of service.

Note 2: To the preceding usage charge must be added the appropriate monthly WATS access line charge as specified in D.3.a. preceding to arrive at the total minimum charge.

GENERAL EXCHANGE TARIFF

Embarq Florida, Inc.

By: F. B. Poag  
Director

SECTION A19  
First Revised Sheet 20  
Original Sheet 20  
Effective: January 1, 1997

WIDE AREA TELECOMMUNICATIONS SERVICE

D. RATES AND CHARGES (Cont'd)

4. Fractional Periods (Cont'd)

- b. For the purpose of administering this regulation with respect to the determination of charges for a fractional part of a month, every month is considered to have 30 days.

5. Installation Charges

a. Definitions

- 1) Service Ordering Charge - The charge that applies for work performed by the Company in connection with the receiving, recording, and processing of customer requests for service.
- 2) Central Office Work Charge (United Telephone Only) - Charge for work associated with establishing or changing each WATS access line or access line extension connection.
- 3) New Line Connection Charge - Charge for work associated with establishing or changing each WATS access line or access line extension connection.
- 4) Premises Visit Charge - The charge that applies for a visit to the customer's premises to perform work, other than disconnect work, requested by the customer.
- 5) Premises Work Charge - Simple Service (United Telephone Only) - see D.6. following.

GENERAL EXCHANGE TARIFF

Embarq Florida, Inc.

By: F. B. Poag  
Director

SECTION A19  
First Revised Sheet 21  
Original Sheet 21  
Effective: January 1, 1997

WIDE AREA TELECOMMUNICATIONS SERVICE

D. RATES AND CHARGES (Cont'd)

5. Installation Charges (Cont'd)

b. For installation of WATS access lines, extensions, or four-wire terminating arrangements

1) Access lines and Extension Lines

	<u>Nonrecurring Charge</u>
<u>United Telephone exchanges only</u>	
a) Service Ordering - primary, each order	\$35.00
b) Service Ordering - secondary, each order	16.00
c) Central Office Work charge <sup>1</sup> , each	19.50
d) New Line Connection charge <sup>1</sup> , each	35.00
e) Premises Visit, each visit	19.00
<u>Central Telephone exchanges only</u>	
f) Service Ordering - Primary, each order	\$30.00
g) Service Ordering - Secondary, each order	14.00
h) New Line Connection charge <sup>2</sup> , each	35.00
i) Premises Visit, each visit	30.00

Note 1: Central office work charge is applicable for all new access lines connected in the United Telephone area.

Note 2: New line connection charge is applicable for all new access lines or additional access lines over and above the number previously installed at a premises.

GENERAL EXCHANGE TARIFF

Embarq Florida, Inc.

By: F. B. Poag  
Director

SECTION A19  
First Revised Sheet 22  
Original Sheet 22  
Effective: January 1, 1997

WIDE AREA TELECOMMUNICATIONS SERVICE

D. RATES AND CHARGES (Cont'd)

5. Installation Charges (Cont'd)

b. For installation of WATS access lines, extensions, or four-wire terminating arrangements (Cont'd)

2) Four-wire terminating arrangements

This charge is in addition to the access line nonrecurring charges.

	Nonrecurring <u>Charge</u>
<u>United Telephone exchanges only</u>	
each arrangement	\$17.00
<u>Central Telephone exchanges only</u>	
each arrangement	\$21.15
c. For moving a dedicated access line or extension line	
1) Inside move - network interface	
<u>United Telephone</u>	
a) Service ordering, each order <sup>1</sup>	\$16.00
b) Premises visit, each visit	19.00
<u>Central Telephone</u>	
a) Service ordering, each order <sup>1</sup>	\$14.00
b) Premises visit, each visit	30.00

Note 1: In addition to the service ordering charge, time and material work charges apply as specified in D.5.d.(6). following, Premises Work Charges.



GENERAL EXCHANGE TARIFF

Embarq Florida, Inc.

By: F. B. Poag  
Director

SECTION A19  
Second Revised Sheet 23  
Cancelling First Revised Sheet 23  
Effective: May 29, 1997

WIDE AREA TELECOMMUNICATIONS SERVICE

D. RATES AND CHARGES (Cont'd)

5. Installation Charges (Cont'd)

c. For moving a dedicated access line or extension line (Cont'd)

2) Outside move, different building

Moves to a different building will be treated as a disconnect of the existing access line or extension and installation charges as specified in D.5.b. preceding will be applicable.

d. Conversion Charges

1) Changing the TFC service telephone number to a different number at the request of the customer.

Nonrecurring  
Charge

United Telephone exchanges only

a) Service ordering, each order \$16.00

b) Central office work charge, each<sup>1</sup> \$19.50

Central Telephone exchanges only

a) Service ordering, each order \$14.00

b) Line connection charge, each 35.00

Note 1: Central Office Work charges are applicable for all access lines connected in the United Telephone area.

GENERAL EXCHANGE TARIFF

Embarq Florida, Inc.

By: F. B. Poag  
Director

SECTION A19  
Second Revised Sheet 24  
Cancelling First Revised Sheet 24  
Effective: May 29, 1997

WIDE AREA TELECOMMUNICATIONS SERVICE

D. RATES AND CHARGES (Cont'd)

5. Installation Charges (Cont'd)

d. Conversion Charges (Cont'd)

- 2) Separating an existing TFC service into two or more hunting arrangements which contain the same TFC service access lines as the original hunting arrangement.

	<u>Nonrecurring Charge</u>
<u>United Telephone</u>	
a) Service ordering, each order	\$16.00
b) Central office work charge, each <sup>1</sup>	19.50

Central Telephone

a) Service ordering, each order	\$14.00
b) Line connection charge, each	35.00

- 3) Combining two or more TFC service hunting arrangements into a single hunting arrangement containing the same TFC service access lines.

United Telephone

a) Service ordering, each order	\$16.00
b) Central office work charge, each <sup>1</sup>	19.50

Central Telephone

a) Service Ordering, each order	\$14.00
b) Line connection charge, each	35.00

Note 1: Central Office Work Charges are applicable for all access lines connected in the United Telephone Area

GENERAL EXCHANGE TARIFF

Embarq Florida, Inc.

By: F. B. Poag  
Director

SECTION A19  
Second Revised Sheet 25  
Cancelling First Revised Sheet 25  
Effective: May 29, 1997

WIDE AREA TELECOMMUNICATIONS SERVICE

D. RATES AND CHARGES (Cont'd)

5. Installation Charges (Cont'd)

d. Conversion Charges (Cont'd)

	<u>Nonrecurring Charge</u>
4) Conversion to a four-wire termination arrangement	
<u>United Telephone</u> each arrangement	\$ 85.75
<u>Central Telephone</u> each arrangement	107.19
5) Change Primary Interexchange Carrier (PIC) - United Telephone Only	
a) For interLATA portion of combined outward WATS	
(1) Initial line	\$ 11.00
(2) Additional line, each, same Order as initial line	3.00
6) Premises Work Charge - Simple Service - United Telephone Only	

Simple premises work charges are nonrecurring charges in the United Telephone area only, based on the installation labor time and miscellaneous materials required to complete the installation of customer requested rearrangements on the customer's premises. Billable premises work is that work performed by a Company representative on a customer's premises which includes, but is not limited to, customer requests for rearrangements of a drop wire, protector, and/or network interface. Premises work does not include the work required to establish network access.

GENERAL EXCHANGE TARIFF

Embarq Florida, Inc.

By: F. B. Poag  
Director

SECTION A19  
Second Revised Sheet 26  
Cancelling First Revised Sheet 26  
Effective: May 29, 1997

WIDE AREA TELECOMMUNICATIONS SERVICE

D. RATES AND CHARGES (Cont'd)

5. Installation Charges (Cont'd)

d. Conversion Charges (Cont'd)

6) Premises Work Charge - Simple Service (United Telephone only) (Cont'd)

a) Regulations of Time and Materials Charging

- (1) The premises work charge applies to all customer requested installation, move, and change work done by the Company in the United Telephone area only on the customer's premises exclusive of establishing or reestablishing network access or as otherwise specified in D.5.d.6)a)(1) following.
- (2) The premises work charge applies in addition to all other applicable rates and charges for United Telephone area services
- (3) If for Company reasons, more than one Company technician is involved in performing billable premises work on the same service order, only one premises visit charge will apply. Premises work charges will be calculated by totaling the billable work time performed by all technicians.
- (4) United Telephone residence customers with PBX, Centrex, or key equipment are subject to applicable complex charges in lieu of simple service premises work charges.

GENERAL EXCHANGE TARIFF

Embarq Florida, Inc.

By: F. B. Poag  
Director

SECTION A19  
Second Revised Sheet 27  
Cancelling First Revised Sheet 27  
Effective: May 29, 1997

WIDE AREA TELECOMMUNICATIONS SERVICE

D. RATES AND CHARGES (Cont'd)

5. Installation Charges (Cont'd)

d. Conversion Charges (Cont'd)

6) Premises Work Charge - Simple Service (United Telephone only) (Cont'd)

a) Regulations of Time and Materials Charging (Cont'd)

(5) Premises work charges do not apply to the following work: (Cont'd)

- (a) To rearrange a customer's telephone service if required or initiated by the Company.
- (b) To install or rearrange telephone equipment located on a customer's premises but used exclusively by the Company for maintenance or training activities.
- (c) The "from" portion of work involved in a transfer of service from one premises to another.
- (d) Disconnection and/or removal, of the following items of service or equipment, providing no other work subject to service charges is involved.
  - Main or extension station telephones
  - Directory listings and directory services
  - Access line services
- (e) For the complete cancellation of the service order before any billable premises work is performed.

GENERAL EXCHANGE TARIFF

Embarq Florida, Inc.

By: F. B. Poag  
Director

SECTION A19  
Second Revised Sheet 28  
Cancelling First Revised Sheet 28  
Effective: May 29, 1997

WIDE AREA TELECOMMUNICATIONS SERVICE

D. RATES AND CHARGES (Cont'd)

5. Installation Charges (Cont'd)

d. Conversion Charges (Cont'd)

6) Premises Work Charge - Simple Service (United Telephone only) (Cont'd)

b) Rates and Charges

(1) Premises work charges apply as follows:

Each 15-minute increment of billable premises work rounded to the nearest 15-minute increment

Nonrecurring  
Charge

Simple Service

Schedule 1	\$11.80
Schedule 2	13.40
Schedule 3	15.40

- (2) Schedule 1 is applicable to work performed Monday through Friday, between 8:00 a.m. and 5:00 p.m.
- (3) Schedule 2 is applicable to work performed Monday through Friday at hours other than Schedule 1 and all day Saturday.
- (4) Schedule 3 is applicable to work performed on Sundays and holidays, including New Year's Day, Good Friday, Memorial Day, Independence Day, Labor Day, Veterans Day, Thanksgiving Day, and Christmas Day.

GENERAL EXCHANGE TARIFF

Embarq Florida, Inc.

By: F. B. Poag  
Director

SECTION A19  
First Revised Sheet 29  
Cancelling Original Sheet 29  
Effective: January 1, 1997

WIDE AREA TELECOMMUNICATIONS SERVICE

D. RATES AND CHARGES (Cont'd)

6. Four Wire Terminating Arrangement

a. The Four Wire Terminating Arrangement charge is in addition to the monthly recurring charges.

1) Four Wire Terminating Arrangement charge

	<u>Monthly Rate</u>
Per arrangement	\$10.00

7. Access Line Terminations

a. The terminating point of a WATS access line is the standard network interface. The first termination is the WATS access line; all other terminations on the same line are WATS access line extensions.

b. The WATS access line may terminate in one of the following:

- 1) To terminal equipment, multiline terminating systems or a communication system on the customer's premises.
- 2) To switching equipment in the Company central office.
- 3) To an Other Common Carrier (OCC) or Central Office Connection Facility (COCF) channel in the Company central office.

GENERAL EXCHANGE TARIFF

Embarq Florida, Inc.

By: F. B. Poag  
Director

SECTION A19  
Second Revised Sheet 30  
Cancelling First Revised Sheet 30  
Effective: May 29, 1997

WIDE AREA TELECOMMUNICATIONS SERVICE

D. RATES AND CHARGES (Cont'd)

8. Access Line Extensions

a. Located in the same exchange as main termination

- 1) First extension termination on different premises from main termination

	<u>Monthly Rate</u>
Each	\$25.00

- 2) Additional termination in same building as main or other extension termination

	<u>Nonrecurring Charge</u>
Each	-

- 3) First extension termination in different building, same premises as main or other extension termination

	<u>Monthly Rate</u>
Each	\$9.25

b. Located in different exchange from main termination

Interexchange channel mileage charges and channel terminal charges apply as specified for series 2000 channels in BellSouth Telecommunications, Inc.'s, Private Line Tariff plus:

	<u>Monthly Rate</u>
1) First termination	\$25.00



GENERAL EXCHANGE TARIFF

Embarq Florida, Inc.

By: F. B. Poag  
Director

SECTION A19  
Second Revised Sheet 31  
Cancelling First Revised Sheet 31  
Effective: May 29, 1997

WIDE AREA TELECOMMUNICATIONS SERVICE

D. RATES AND CHARGES (Cont'd)

8. Access Line Extensions (Cont'd)

b. Located in different exchange from main termination (Cont'd)

Interexchange channel mileage charges and channel terminal charges apply as specified for series 2000 channels in BellSouth Telecommunications, Inc.'s Private Line Tariff plus: (Cont'd)

		<u>Monthly Rate</u>
2)	Additional termination in same building with first or other extension termination, (United Telephone only)	each <sup>1</sup>
3)	Additional termination in different Building, same premises as first or other extension termination,	each \$ 9.25
4)	Additional termination on different premises, same exchange as first termination, each	\$25.00
9. Minimum Average Time Requirement		
a.	For combined intraLATA/interLATA outward WATS, intraLATA outward WATS, or TFC service, usage is subject to an average of 30 seconds per completed call for each billing period in each service group for each rate period.	
b.	If the average duration of all such calls is less than thirty seconds, the total use for the service group equals the number of calls multiplied by thirty seconds.	

Note 1: A nonrecurring charge applies.

GENERAL EXCHANGE TARIFF

Embarq Florida, Inc.

By: F. B. Poag  
Director

SECTION A19  
First Revised Sheet 32  
Cancelling Original Sheet 32  
Effective: January 1, 1997

WIDE AREA TELECOMMUNICATIONS SERVICE

D. RATES AND CHARGES (Cont'd)

10. Minimum Service Period

The minimum service period for WATS is one day.

11. Allowance for Interruptions

Allowance for interruptions applies to each WATS access line as set forth in 1 - 6 following.

a. When the WATS access line is interrupted for a period of less than two (2) hours, no credit applies.

b. When the WATS access line is interrupted for a period of two hours to 24 hours, a per day credit applies as set forth in (a) through (c) following.

1) An interruption allowance is determined by (a) first calculating the rate for one full day (minimum monthly rate divided by 30), then (b) multiplying the result of (a) by the number of days credited as specified below.

2) In determining the interruption allowance, the "proportionate part of the day credited" applies as set forth below.

a) Interruptions of 24 hours or less

Proportionate  
Part of Day  
Credited

Length of interruption  
- Less than two (2) hours  
- Two (2) hours up to 24 hours  
inclusive

None

One day

GENERAL EXCHANGE TARIFF

Embarq Florida, Inc.

By: F. B. Poag  
Director

SECTION A19  
First Revised Sheet 33  
Cancelling Original Sheet 33  
Effective: January 1, 1997

WIDE AREA TELECOMMUNICATIONS SERVICE

D. RATES AND CHARGES (Cont'd)

11. Allowance for Interruptions (Cont'd)

Allowance for interruptions applies to each WATS access line as set forth in 1 - 6 following.  
(Cont'd)

b. (Cont'd)

2) (Cont'd)

b) Interruption over 24 hours

Credit will be allowed in one day multiples for each two hour period of interruption, not to exceed one full day's credit for any period of 24 hours.

3) For the purpose of determining the amount of the above credit allowances, every month is considered to have 30 days.

a) None of the above credit allowances will be made for:

(1) Non-completion of WATS messages due to busy network conditions.

(2) Interruption of service due to customer provided equipment or systems.

(3) Interruption of service due to negligence of the customer.

(4) Interruption of service during any period in which the Company is not afforded access to the premises at which the WATS access line is terminated.

GENERAL EXCHANGE TARIFF

Embarq Florida, Inc.

By: F. B. Poag  
Director

SECTION A19  
First Revised Sheet 34  
Cancelling Original Sheet 34  
Effective: January 1, 1997

WIDE AREA TELECOMMUNICATIONS SERVICE

D. RATES AND CHARGES (Cont'd)

11. Allowance for Interruptions (Cont'd)

Allowance for interruptions applies to each WATS access line as set forth in 1 - 6 following.  
(Cont'd)

b. (Cont'd)

3) (Cont'd)

a) (Cont'd)

(5) Interruption of service during any period when the customer has released the WATS access line to the Company for maintenance purposes, or implementation of a customer order for a change in service arrangement.

b) Long distance message telecommunications service furnished at a customer's request, when his WATS is interrupted, is charged for at the long distance telecommunications rates.

12. Timing of Calls

a. Chargeable time begins when connection is established between a station associated with the WATS access line and the calling or called station, and ends when the calling station "hangs up" thereby releasing the network connection. If the called station "hangs up" but the calling station does not, chargeable time ends when the network connection is released by automatic timing equipment in the telephone network.

b. When a connection is established in one rate period and ends in another, the rate in effect for each rate period applies to the portion of the connection occurring during that rate period.

GENERAL EXCHANGE TARIFF

Embarq Florida, Inc.

By: F. B. Poag  
Director

SECTION A19  
Second Revised Sheet 35  
Cancelling First Revised Sheet 35  
Effective: May 29, 1997

WIDE AREA TELECOMMUNICATIONS SERVICE

D. RATES AND CHARGES (Cont'd)

12. Timing of Calls (Cont'd)

- c. The rate charged is determined by the day and time (standard or daylight savings) at the WATS access line location.
- d. When TFC service is directly connected (i.e., not connected through a Multiline Terminating System) at a customer's premises to a communications system, chargeable time begins when the TFC service call terminates in or passes through the first multiline terminating system or terminal equipment on that communications system. It is the Customer's responsibility to furnish appropriate answer supervision to the point of connection with the TFC service so that chargeable time may begin.

13. Directory Listing (TFC Service Only)

Directory listings are provided at rates applicable for additional business listings as covered in Section A6 of this tariff.

a. Directory Listing Charge (TFC service)

	<u>Monthly Rate</u>
<u>United Telephone</u> each directory listing	\$-
<u>Central Telephone</u> each directory listing	\$1.25

GENERAL EXCHANGE TARIFF

Embarq Florida, Inc.

By: F. B. Poag  
Director

SECTION A19  
Third Revised Sheet 36  
Cancelling Second Revised Sheet 36  
Effective: May 29, 1997

WIDE AREA TELECOMMUNICATIONS SERVICE

E. Opportunity 800 Service (UNITED TELEPHONE EXCHANGES ONLY) (Cont'd)

1. Description

- a. Opportunity 800 Service is a common line termination service that provides, where facilities are available, for the termination of intraLATA TFC calls on residence and business local exchange access lines.
- b. Opportunity 800 Service provides reverse charge dial-type telecommunications to a local exchange access line arranged for Opportunity 800 Service from other stations within the customer's LATA using the public switched network.
- c. Opportunity 800 Service may be established on a new or existing local exchange access line.

2. Regulations

- a. The Opportunity 800 Service customer is furnished with a TFC service number to be associated with an individual line or trunk. Opportunity 800 Service is not an access line.
- b. Opportunity 800 Service terminating on common line is subject to the regulations of local exchange access lines as specified elsewhere in this tariff.
- c. An Opportunity 800 Service subscriber may not have more than one TFC telephone number terminating on the same local exchange telephone number.
- d. Opportunity 800 Service is furnished subject to the availability of the service.
- e. Opportunity 800 Service is not available on pay telephone or remote call forwarding services.
- f. Opportunity 800 Service provides for termination of calls only.

GENERAL EXCHANGE TARIFF

Embarq Florida, Inc.

By: F. B. Poag  
Director

SECTION A19  
Second Revised Sheet 37  
Cancelling First Revised Sheet 37  
Effective: May 29, 1997

WIDE AREA TELECOMMUNICATIONS SERVICE

E. OPPORTUNITY 800 SERVICE (UNITED TELEPHONE EXCHANGES ONLY) (Cont'd)

2. Regulations (Cont'd)

- g. Opportunity 800 Service calls must be dialed and completed without the assistance of a Company operator except when the facilities or conditions do not allow for a customer dialed call completion or to reestablish a bad connection. Person-to-person, collect, conference, or other calls requiring operator handling are not permitted to be completed to the Opportunity 800 Service telephone number.
- h. An Opportunity 800 Service call must originate and terminate within the same LATA.
- i. Opportunity 800 Service can be provided to a customer by the Company on a complementary basis with an Interexchange Carrier (IXC) in order to furnish a statewide or national TFC service. The rates and charges for the TFC number(s) and intraLATA usage are billed as specified herein. All interLATA usage is subject to the rates and charges specified in the tariff of the IXC.
- j. Connection of Opportunity 800 Service to other services is permitted on a switched basis only. No permanent connection between Opportunity 800 Service and other services may be established.
- k. An Opportunity 800 Service customer must subscribe to and make use of a sufficient number of exchange access lines so that use of the service does not interfere with another customer's service or proper operation of the public switched network as described in C.6. preceding.
- l. Opportunity 800 Service directory listings are provided at rates applicable for additional listings as covered in Section A6 of this tariff.

GENERAL EXCHANGE TARIFF

Embarq Florida, Inc.

By: F. B. Poag  
Director

SECTION A19  
Second Revised Sheet 38  
Cancelling First Revised Sheet 38  
Effective: May 29, 1997

WIDE AREA TELECOMMUNICATIONS SERVICE

E. OPPORTUNITY 800 SERVICE (UNITED TELEPHONE EXCHANGES ONLY) (Cont'd)

2. Regulations(Cont'd)

- m. All rules and regulations applicable for the class of service with which Opportunity 800 Service is associated will be specified in this and other sections of this tariff.
- n. In the provisioning of Opportunity 800 Service, the Company will be the responsible organization (RESPORG). The Company will require the ten-digit POTS number for intraLATA screening.
  - 1) The RESPORG provides for the assignment and administration of ten-digit TFC number(s), i.e., TFC+NXX+XXX, to the Opportunity 800 Service customer. As the RESPORG, the Company will select the TFC number(s) to be assigned to the customer unless the customer requests a specific TFC number. If the requested number is available, the Company will make a reasonable effort to comply with the customer's request for a specific TFC number in accordance with the Number Administration Service Center guidelines.
  - 2) The RESPORG will not reserve TFC numbers for customers that will not be activated within a one month period.
  - 3) The Company will assign TFC numbers on a first come, first serve basis. The Company will not be party to or take part in controversies between Opportunity 800 Service customers regarding the assignment of specific TFC numbers.



GENERAL EXCHANGE TARIFF

Embarq Florida, Inc.

By: F. B. Poag  
Director

SECTION A19  
Second Revised Sheet 39  
Cancelling First Revised Sheet 39  
Effective: May 29, 1997

WIDE AREA TELECOMMUNICATIONS SERVICE

E. OPPORTUNITY 800 SERVICE (UNITED TELEPHONE EXCHANGES ONLY) (Cont'd)

3. Rates and Charges

- a. Monthly Opportunity 800 Service usage rates are based upon the total number of minutes of use according to a discounted rate schedule (see Section A19.F.3.h.) There is no minimum usage requirement. There is no charge to the originator of the call.
- b. Total minutes of use for each Opportunity 800 Service customer will be rated at the per minute rate based upon the discounted rate schedule. Any remaining fractions of a minute will be rounded to the nearest tenth of a minute and will be rated based upon the percentage of a minute used multiplied by the per minute rate.
- c. The rate schedule requires a separate monthly charge for each TFC telephone number independent of usage.
- d. A service order charge, as covered in Section A4, will apply for each change or addition required as a result of Opportunity 800 Service.
- e. Chargeable time begins when a connection is established between an access line associated with Opportunity 800 Service and the calling access line.
- f. Chargeable time ends when the calling access line "hangs up" thereby releasing the network connection. If the called access line "hangs up" but the calling access line does not, chargeable time ends when the network connection is released by automatic timing equipment in the telecommunications network.

GENERAL EXCHANGE TARIFF

Embarq Florida, Inc.

By: F. B. Poag  
Director

SECTION A19  
Third Revised Sheet 40  
Cancelling Second Revised Sheet 40  
Effective: November 12, 2004

WIDE AREA TELECOMMUNICATIONS SERVICE

E. OPPORTUNITY 800 SERVICE (UNITED TELEPHONE EXCHANGES ONLY) (Cont'd)

3. Rates and Charges (Cont'd)

g. Monthly Charges

	Monthly Rate
Per termination associated with each TFC telephone number	\$7.00

h. Monthly Usage Rate Table

	Monthly Rate
0 - 5 hours, per minute of use	\$ .19
Over 5 -25 hours, per minute of use	\$ .18
Over 25 hours, per minute of use	\$ .17

i. Rates and charges found in E10 preceding will apply for access line extensions.

F. EXPEDITED ORDER CHARGE FOR WATS/TFC SERVICES (UNITED TELEPHONE EXCHANGES ONLY)

1. General

- a. If a customer desires that WATS or TFC Service be provided on an earlier date than that which has been established for the installation of the service, the customer may request that service be provided on an expedited basis. If the Company agrees to provide the service on an expedited basis, an Expedited Order Charge will apply.
- b. If the Company is subsequently unable to meet an agreed upon expedited service date, no Expedited Order Charge will apply unless the missed service date was caused by the customer.

GENERAL EXCHANGE TARIFF

Embarq Florida, Inc.

By: F. B. Poag  
Director

SECTION A19  
Second Revised Sheet 41  
Cancelling First Revised Sheet 41  
Effective: May 29, 1997

WIDE AREA TELECOMMUNICATIONS SERVICE

F. EXPEDITED ORDER CHARGE FOR WATS/TFC SERVICES (UNITED TELEPHONE EXCHANGES ONLY) (Cont'd)

1. General (Cont'd)

- c. If the Company receives a request for an expedited service date at the time a service order is placed, the Expedited Order Charge is calculated by summing all the nonrecurring charges associated with the provisioning of the service and then dividing this total by the number of days in the standard provisioning interval. The charge is then applied on a per day of improvement basis, per order.
- d. When the Company receives a request for expediting a pending order, the Expedited Order Charge is based on the extent to which the service order has been processed at the time the Company agrees to the service date improvement and is calculated as follows:
  - (1) Based on the critical dates associated with the provisioning of a service, as defined in G.2.b. following, the Company will determine which critical date will be completed next in the provisioning interval.
  - (2) Using the table in G.3. following and the critical date as determined preceding, the Company will determine the percent of the provisioning interval not yet completed by subtracting the percentage associated with the last completed critical date from one hundred percent.
  - (3) The Company will apply this percentage to the sum of all the nonrecurring charges associated with the provisioning of the service and will divide the result by the number of days remaining in the original provisioning interval.
  - (4) The per day charges so developed will then be applied on a per day of improvement basis, per order.

GENERAL EXCHANGE TARIFF

Embarq Florida, Inc.

By: F. B. Poag  
Director

SECTION A19  
Second Revised Sheet 42  
Cancelling First Revised Sheet 42  
Effective: May 29, 1997

WIDE AREA TELECOMMUNICATIONS SERVICE

F. EXPEDITED ORDER CHARGE FOR WATS/TFC SERVICES (UNITED TELEPHONE EXCHANGES ONLY) (Cont'd)

2. Company Critical Dates

- a. Certain Company critical dates are associated with the standard service order provisioning interval. These dates are used by the Company to monitor the progress of the provisioning process. At any point in the service order provisioning interval, the Company is able to determine which critical date was last completed and can thus determine what percentage of the Company's provisioning costs have been incurred as of that critical date.
- b. The critical dates tracked by the Company are as follows:
  - Application Date (APP): The date the customer provides to the Company (a) a firm commitment for service and (b) sufficient information to enable the Company to begin service provisioning. This is also the order date.
  - Scheduled Issue Date (SID): The date that the order is to be entered in the Company's order distribution system.

GENERAL EXCHANGE TARIFF

Embarq Florida, Inc.

By: F. B. Poag  
Director

SECTION A19  
Second Revised Sheet 43  
Cancelling First Revised Sheet 43  
Effective: May 29, 1997

WIDE AREA TELECOMMUNICATIONS SERVICE

F. EXPEDITED ORDER CHARGE FOR WATS/TFC SERVICES (UNITED TELEPHONE EXCHANGES ONLY) (Cont'd)

2. Company Critical Dates (Cont'd)

b. The critical dates tracked by the Company are as follows: (Cont'd)

- Local Channel Assignment Make-Up (LCAM): The date by which Special Services Engineering is to receive the information regarding the assignment of local physical cable pairs from Outside Plant Engineering.
- Records Issue Date (RID): The date that all design and assignment information is to be sent to the Central Office and installation forces.
- Material Issue Date (MID): The date by which the Material and Supply department must issue material required for special circuit installation.
- Designed, Verified, and Assigned Date (DVA): The date by which the field forces are to have received all material and paperwork.

GENERAL EXCHANGE TARIFF

Embarq Florida, Inc.

By: F. B. Poag  
Director

SECTION A19  
Second Revised Sheet 44  
Cancelling First Revised Sheet 44  
Effective: May 29, 1997

WIDE AREA TELECOMMUNICATIONS SERVICE

F. EXPEDITED ORDER CHARGE FOR WATS/TFC SERVICES (UNITED TELEPHONE EXCHANGES ONLY) (Cont'd)

2. Company Critical Dates (Cont'd)

b. The critical dates tracked by the Company are as follows: (Cont'd)

- Wired and Office Tested Date (WOT): The date by which all intraoffice wiring is to be completed, all plug-ins placed, plug-in options set and aligned, frame continuity established, and the interoffice facilities, if applicable, tested. In addition, switching equipment, including translation loading, is to be installed and tested.
- Plant Test Date (PTD): The date on which overall testing of the service is to be started.
- Service Date (DD): The date on which service is to be made available to the customer. This is sometimes referred to as the Due Date.

GENERAL EXCHANGE TARIFF

Embarq Florida, Inc.

By: F. B. Poag  
Director

SECTION A19  
Second Revised Sheet 45  
Cancelling First Revised Sheet 45  
Effective: May 29, 1997

WIDE AREA TELECOMMUNICATIONS SERVICE

F. EXPEDITED ORDER CHARGE FOR WATS/TFC SERVICES (UNITED TELEPHONE EXCHANGES ONLY) (Cont'd)

3. Provisioning Table

The critical dates and percentages of costs associated with the provisioning of a service are as follows:

a. WATS/TFC Primary Service - Engineering Required

Last Critical Date Completed

	<u>APP</u>	<u>SID</u>	<u>LCAM</u>	<u>RID</u>	<u>MID</u>	<u>DVA</u>	<u>WOT</u>	<u>PTD</u>	<u>DD</u>
% Completed:	0	8	24	29	34	56	78	99	100

WATS/TFC Primary Service - No Engineering Required

Last Critical Date Completed

	<u>APP</u>	<u>SID</u>	<u>DVA</u>	<u>PTD</u>	<u>DD</u>
% Completed:	0	34	78	99	100

b) WATS/TFC Secondary Service

Last Critical Date Completed

	<u>APP</u>	<u>SID</u>	<u>DVA</u>	<u>PTD</u>	<u>DD</u>
% Completed:	0	34	78	99	100

Example: An example of the calculation for the Expedited Order Charge if the request to expedite is received the seventh day of the provisioning process is shown below.<sup>1</sup>

NOTE 1: A list of standard provisioning intervals may be obtained from the Company by request.

GENERAL EXCHANGE TARIFF

Embarq Florida, Inc.

By: F. B. Poag  
Director

SECTION A19  
Second Revised Sheet 46  
Cancelling First Revised Sheet 46  
Effective: May 29, 1997

WIDE AREA TELECOMMUNICATIONS SERVICE

F. EXPEDITED ORDER CHARGE FOR WATS/TFC SERVICES (UNITED TELEPHONE EXCHANGES ONLY) (Cont'd)

3. Provisioning Table (Cont'd)

Example: (Cont'd)

<u>[TOTAL NRC x %Provisioning Not Completed]:Working Days Remaining =</u>			Per Day Charge
\$105	76	8	\$9.98
<u>Number Days Improved x Per Day Charge = Expedited Order Charge</u>			
	5	\$9.98	\$49.90



GENERAL EXCHANGE TARIFF

Embarq Florida, Inc.

SECTION A20

By: F. B. Poag  
Director

Fourth Revised Contents Sheet 1  
Cancelling Third Revised Contents Sheet 1  
Effective: January 6, 2003

PRIVATE LINE SERVICE

CONTENTS

	SHEET
A. PRIVATE LINE SERVICES.....	1
1. General Regulations .....	1
2. Liability of the Company.....	2
3. Allowance for Interruptions.....	3
4. Provision of Facilities .....	4
5. Regulations Applicable to Private Line Services.....	4
6. Provision of Service .....	7
8. Rate Regulations.....	12
9. Regulations Applicable to Channels .....	29
10. Service Descriptions .....	40
11. Rates and Charges .....	73
B. DIGITAL ACCESS CROSS CONNECT SERVICE .....	98
1. General.....	98
2. Definitions.....	98
3. Connections .....	99
4. Rates and Charges .....	100
C. D-4 CHANNEL SERVICE.....	101
1. General.....	101
2. Rates and Charges .....	101
D. RESERVED FOR FUTURE USE .....	103
E. EXPEDITED ORDER CHARGE.....	114
1. General.....	114
2. Expedited Order Charge Billing Percentages .....	116

GENERAL EXCHANGE TARIFF

Embarq Florida, Inc.

SECTION A20

By: F. B. Poag  
Director

Third Revised Contents Sheet 2  
Cancelling Second Revised Contents Sheet 2  
Effective: January 6, 2003

PRIVATE LINE SERVICE

CONTENTS

	SHEET
F. RESERVED FOR FUTURE USE	
G. OPTIPOINT SERVICE	
1. REGULATIONS .....	130
2. TERM PLAN.....	142
3. TERMINATION LIABILITY CHARGES .....	143
4. MONTHLY RATE CATEGORIES .....	144
5. NONRECURRING CHARGE CATEGORIES .....	146
6. APPLICATION OF RATES .....	147
7. MONTHLY RATES.....	148
8. NONRECURRING CHARGES.....	153
H. SONET RING SERVICE	
1. REGULATIONS .....	154
2. TERM PLAN.....	166
3. TERMINATION LIABILITY CHARGES .....	167
4. APPLICATION OF RATES .....	168
5. MONTHLY RATES.....	169
6. NONRECURRING CHARGES.....	174

## GENERAL EXCHANGE TARIFF

Embarq Florida, Inc.

By: F. B. Poag  
Director

SECTION A20  
Second Revised Sheet 1  
Cancelling First Revised Sheet 1  
Effective: January 6, 2003

### PRIVATE LINE SERVICES

#### A. PRIVATE LINE SERVICES

##### 1. General Regulations

- a. The following regulations and rates apply to both intraexchange and interexchange private line service and channels furnished or made available by the Company over facilities between two or more points. Services consisting of Local Channels, Interoffice Channels, and Optional Features and Functions are classified by series. The various series are sub-divided into different types and are described in terms of circuit characteristics and use. The Channel Services are Voice Grade (Series 2000).
- b. Customers may order local channels which are designed to meet specific communications requirements. The customer is responsible for determining that terminal equipment is compatible with the service provided by the Company.
- c. Where multi-point service is furnished, the local channels are bridged in the wire center.
- d. When the Company receives a request for service which will follow a route over loaded facilities, then the customer may request these facilities be unloaded or the service requested may require unloaded facilities. Accordingly, there will be a charge for the arrangement based on the current cost of labor, plus materials, should the Company agree to do so.
- e. Entities purchasing Intraexchange or Interexchange Private Line Services for the purpose of resale must purchase the service or any portion of the service from the Company's Dedicated Access Service Tariff, Section 7.
  - 1) Entities purchasing Intraexchange Private Line Service for the purpose of resale must hold Alternative Access Vendor (AAV) or Alternative Local Exchange Company (ALEC) certification. (Intraexchange Private Line Service provides a dedicated transmission path between two end-users within the same exchange.)

## GENERAL EXCHANGE TARIFF

Embarq Florida, Inc.

By: F. B. Poag  
Director

SECTION A20  
Second Revised Sheet 1  
Cancelling First Revised Sheet 1  
Effective: January 6, 2003

### PRIVATE LINE SERVICES

#### A. PRIVATE LINE SERVICES

##### 1. General Regulations

- a. The following regulations and rates apply to both intraexchange and interexchange private line service and channels furnished or made available by the Company over facilities between two or more points. Services consisting of Local Channels, Interoffice Channels, and Optional Features and Functions are classified by series. The various series are sub-divided into different types and are described in terms of circuit characteristics and use. The Channel Services are Voice Grade (Series 2000).
- b. Customers may order local channels which are designed to meet specific communications requirements. The customer is responsible for determining that terminal equipment is compatible with the service provided by the Company.
- c. Where multi-point service is furnished, the local channels are bridged in the wire center.
- d. When the Company receives a request for service which will follow a route over loaded facilities, then the customer may request these facilities be unloaded or the service requested may require unloaded facilities. Accordingly, there will be a charge for the arrangement based on the current cost of labor, plus materials, should the Company agree to do so.
- e. Entities purchasing Intraexchange or Interexchange Private Line Services for the purpose of resale must purchase the service or any portion of the service from the Company's Dedicated Access Service Tariff, Section 7.
  - 1) Entities purchasing Intraexchange Private Line Service for the purpose of resale must hold Alternative Access Vendor (AAV) or Alternative Local Exchange Company (ALEC) certification. (Intraexchange Private Line Service provides a dedicated transmission path between two end-users within the same exchange.)

GENERAL EXCHANGE TARIFF

Embarq Florida, Inc.

By: F. B. Poag  
Director

SECTION A20  
First Revised Sheet 2  
Cancelling Original Sheet 2  
Effective: January 1, 1997

PRIVATE LINE SERVICES

A. PRIVATE LINE SERVICES (Cont'd)

1. General Regulations (Cont'd)

e. (Cont'd)

- 2) Entities purchasing Interexchange Private Line Service for the purpose of resale must hold Alternate Access Vendor (AAV), Alternative Local Exchange Company (ALEC) or Interexchange Carrier (IXC) certification. (Interexchange Private Line Service provides a dedicated transmission path between two end users in different exchanges.)

2. Liability of the Company

- a. In view of the fact that the customer has exclusive control of his communications over the facilities furnished him by the Company, and of the other uses for which facilities may be furnished him by the Company, and because of unavailability of errors incident to the services and to the use of such facilities of the Company, the services and facilities furnished by the Company are subject to the terms, conditions and limitations herein specified and to such particular terms, conditions and limitations as are set out in the other sections of this tariff applicable to particular services and facilities.
- b. The liability of the Company for damages arising out of service provided to its subscribers such as defects or failures in facilities furnished by the Company or mistakes, omissions, preemptions, interruptions, delays, errors, or defects in the provision of its services set forth herein or any portion of its services, occurring in the course of furnishing such facilities or service, and not caused by the negligence of the customer, or of the Company in failing to maintain proper standards of maintenance and operating and to exercise reasonable supervision, shall, in no event, exceed an amount equivalent to the proportionate charge to the customer for the period of service during which such mistake, omission, preemption, interruption, delay, error or defect in the facilities or services occurs.

GENERAL EXCHANGE TARIFF

Embarq Florida, Inc.

By: F. B. Poag  
Director

SECTION A20  
First Revised Sheet 3  
Cancelling Original Sheet 3  
Effective: January 1, 1997

PRIVATE LINE SERVICES

A. PRIVATE LINE SERVICES (Cont'd)

2. Liability of the Company (Cont'd)

b. (Cont'd)

The Company shall not be liable for damages arising out of mistakes, omissions, preemptions, interruptions, delays, errors or defects in transmission or other injury, including but not limited to injuries to person or property from voltages or currents transmitted over the service of the Company, (1) caused by customer-provided equipment (except where a contributing cause is malfunctioning of a Company-provided connecting arrangement, in which event the liability of the Company shall not exceed an amount equal to a proportional amount of the Company billing for the period of service during which such mistakes, omissions, preemptions, interruptions, delays, errors or defects in transmission or other injury occurs), and (2) not prevented by customer-provided equipment but which would have been prevented had Company-provided equipment been used.

c. In the event that a shortage of facilities exists, either for temporary or protracted periods, the establishment of Exchange and Long Distance Message Telecommunications Services will take precedence over all other services.

3. Allowance for interruptions

No allowance is made for interruptions of less than 24 hours. For interruptions of 24 hours or more, credit is allowed for the proportionate part of the monthly charge in multiples of 1 day for each 24 hours or major fraction thereof, or interruption for the portion of the facilities rendered inoperative by reason of the interruption.

GENERAL EXCHANGE TARIFF

Embarq Florida, Inc.

By: F. B. Poag  
Director

SECTION A20  
First Revised Sheet 4  
Cancelling Original Sheet 4  
Effective: January 1, 1997

PRIVATE LINE SERVICES

A. PRIVATE LINE SERVICES (Cont'd)

4. Provision of Facilities

The Company will provide, maintain and repair all facilities and equipment necessary for Private Line Service with the exception that the customer or authorized user may provide his own equipment, communications systems, and station apparatus for use with such service.

5. Regulations Applicable to Private Line Services

a. The Service

Private line service is that of furnishing the requisite facilities, including channels, to enable the customer or authorized user to communication between specified locations for continuous use, or, for the customer and authorized users only, for regularly recurring periods at stated hours; it is furnished on a contract basis, subject to the availability of such facilities and the requirements of the Company's telephone service.

b. Use of the Service

The service is intended only for communications in which the customer or an authorized user has a direct interest. The service shall not be used for any purpose for which a payment or other compensation shall be received by either the customer or any authorized user from any other person, firm or corporation for use, or in the collection, transmission or delivery of any communication for others. This provision does not prohibit an arrangement between the customer and the authorized users to share the cost of the private line service. The contract or any rights acquired there under by the customer may not be assigned or in any manner transferred.

GENERAL EXCHANGE TARIFF

Embarq Florida, Inc.

By: F. B. Poag  
Director

SECTION A20  
First Revised Sheet 5  
Cancelling Original Sheet 5  
Effective: January 1, 1997

PRIVATE LINE SERVICES

A. PRIVATE LINE SERVICES (Cont'd)

5. Regulations Applicable to Private Line Services (Cont'd)

c. Provision of Equipment

- 1) The customer is responsible for the provision of space, supporting structures and on-premises conduit for Company equipment located on the premises of the customer or authorized users when such equipment is provided for educational television systems.
- 2) The customer is responsible for the provision, installation and maintenance of sealed conduit with explosive proof fittings between equipment furnished by the Company in explosive atmospheres and points outside the hazardous areas where connection may be made with regular facilities of the Company, and may be required to install and maintain company equipment within the hazardous area if, in the opinion of the Company, injury or damage to Company employees or property might result from installation or maintenance by the Company.

d. Ownership and Use of Equipment

Equipment, facilities and lines on the premises of a customer or authorized user furnished by the Company, are the property of the Company, whose agents and employees shall have the right to enter said premises at any reasonable hour for the purpose of installing, inspecting or repairing the facilities and lines, or upon termination of the service, for the purpose of removing such facilities and lines.



GENERAL EXCHANGE TARIFF

Embarq Florida, Inc.

By: F. B. Poag  
Director

SECTION A20  
First Revised Sheet 6  
Cancelling Original Sheet 6  
Effective: January 1, 1997

PRIVATE LINE SERVICES

A. PRIVATE LINE SERVICES (Cont'd)

5. Regulations Applicable to Private Line Services (Cont'd)

e. Maintenance and Repairs

- 1) All ordinary expense of maintenance and repair, in connection with equipment, facilities, and services furnished by the Company, unless otherwise specified in the Company's tariffs, is borne by the Company. In case of damage, loss or destruction of any of the Company's equipment or facilities due to the negligence or willful act of the customer or authorized user and not due to ordinary wear and tear, fire or other causes beyond the control of the customer, the customer shall be responsible for the cost of replacing the equipment destroyed or for the cost of restoring the equipment to its original condition. A customer or authorized user may not rearrange, disconnect, remove or attempt to repair or permit others to rearrange, disconnect, remove or attempt to repair any equipment or facilities installed by the Company, except upon the written consent of the Company.
- 2) The customer shall be responsible for obtaining permission for Company agents or employees to enter the premises of the customer or authorized user at any reasonable hour for the purpose of installing, inspecting, repairing, or, upon termination of the service, removing the facilities of the Company.
- 3) The customer will make Company facilities available periodically for maintenance purposes at a time agreeable to both the Company and the customer. No allowance will be made for the period during which the service is interrupted for such purposes.

GENERAL EXCHANGE TARIFF

Embarq Florida, Inc.

By: F. B. Poag  
Director

SECTION A20  
Second Revised Sheet 7  
Cancelling First Revised Sheet 7  
Effective: October 15, 1998

PRIVATE LINE SERVICES

A. PRIVATE LINE SERVICES (Cont'd)

6. Provision of Service

a. Rate Categories

1) Local Channels

a) A local channel provides for a communications path between a designated customer premises and the serving wire center of that premises. One local channel charge applies per channel termination.

b) When service is provided by non-wire center connected channels, a non-wire center connected channel charge applies in lieu of local channel charges.

2) Interoffice Channels

This rate category provides for the transmission facilities between serving wire centers associated with two customer premises, between serving wire centers associated with a customer premises and a Company hub, or between two Company hubs.

Interoffice mileage consists of a flat rate and a rate per mile. For contract rates, interoffice mileage is portrayed in mileage bands. A flat-rate and a rate per mile applies to each band. For method of determining mileage, see Section A20.A.8.c.

3) Non-Wire Center Connected Channels

Served Direct channels are provided on a direct basis and are limited to one airline mile in length. These channels will be provided only at the option of the Company.

4) Optional Features and Functions

This rate category provides for features and functions which may be added to a service to improve its quality or utility to meet specific communications requirements.

GENERAL EXCHANGE TARIFF

Embarq Florida, Inc.

By: F. B. Poag  
Director

SECTION A20  
First Revised Sheet 8  
Cancelling Original Sheet 8  
Effective: January 1, 1997

PRIVATE LINE SERVICES

A. PRIVATE LINE SERVICES (Cont'd)

6. Provision of Service (Cont'd)

a. Rate Categories (Cont'd)

4) Optional Features and Functions (Cont'd)

These are not specific equipment, but rather represent the end result in terms of the performance characteristics which may be obtained. This category includes a) and b) following:

a) Hub Functions

A hub is a Company designated wire center where bridging or multiplexing functions are performed i.e., connecting three or more customer premises in a multipoint arrangement or channelizing analog or digital services requiring a lower capacity or bandwidth.

b) Provides for such things as signaling, conditioning, bridging, etc.

b. Service Configurations

1) There are two types of service configurations which can be provided. These are described as follows:

a) Two-Point Service

A two-point service connects two customer premises either directly through a serving wire center(s) or through a Company hub where additional functions are performed. A two-point service may utilize non-wire center connected channels only at the option of the Company.

GENERAL EXCHANGE TARIFF

Embarq Florida, Inc.

By: F. B. Poag  
Director

SECTION A20  
First Revised Sheet 9  
Cancelling Original Sheet 9  
Effective: January 1, 1997

PRIVATE LINE SERVICES

A. PRIVATE LINE SERVICES (Cont'd)

6. Provision of Service (Cont'd)

b. Service Configurations ((Cont'd)

1) There are two types of service configurations which can be provided. These are described as follows: (Cont'd)

b) Multipoint Service

(1) Multipoint service connects three or more customer premises through a Company hub.

(2) There is no limitation on the number of mid-links available with Multipoint Service. However, when more than three mid-links are provided in tandem, the quality of the service may be degraded. A mid-link is a channel between hubs (i.e., bridging locations).

(3) Voice Grade (Series 2000) Multipoint Channel services for data use have a limit of 6 two-wire facility type local channels or 20 four-wire facility type local channels when used with customer-provided station equipment.

(4) The types of service available for multipoint applications are designated in the service descriptions set forth in Section A20.A.10.b.(2). following.

c. Special Routing of Channels

1) The private line services furnished in the tariff are provided over such routes as the Company may elect.

2) Special routing is involved where, in order to comply with requirements specified by the customer, the Company furnishes the private line service in a manner which includes one or both of the following conditions.

GENERAL EXCHANGE TARIFF

Embarq Florida, Inc.

By: F. B. Poag  
Director

SECTION A20  
Second Revised Sheet 10  
Cancelling First Revised Sheet 10  
Effective: January 6, 2003

PRIVATE LINE SERVICES

A. PRIVATE LINE SERVICES (Cont'd)

6. Provision of Service (Cont'd)

c. Special Routing of Channels (Cont'd)

2) (Cont'd)

- a) Where two or more private lines must be furnished over different physical routes.
- b) Where a private line must be furnished on a route which avoids specified geographical locations.
- 3) When special routing of services is furnished to a customer, the rates will be determined on an individual case basis.

GENERAL EXCHANGE TARIFF

Embarq Florida, Inc.

By: F. B. Poag  
Director

SECTION A20  
Third Revised Sheet 11  
Cancelling Second Revised Sheet 11  
Effective: January 6, 2003

PRIVATE LINE SERVICES

RESERVED FOR FUTURE USE

GENERAL EXCHANGE TARIFF

Embarq Florida, Inc.

By: F. B. Poag  
Director

SECTION A20  
First Revised Sheet 12  
Cancelling Original Sheet 12  
Effective: January 1, 1997

PRIVATE LINE SERVICES

A. PRIVATE LINE SERVICES (Cont'd)

8. Rate Regulations

a. Types of Rates and Charges

1) Monthly Rates

Monthly Rates are recurring charges that apply each month or fraction thereof that a service is provided. For billing purposes, each month is considered to have 30 days.

2) Nonrecurring Charges

Nonrecurring Charges are one-time charges that apply for a specific work activity. The three types of charges that apply are installation of service, installation of features and functions and service rearrangements.

a) Installation of Service

Nonrecurring charges apply for each service terminated at the customer's premises. For the installation of local channels when more than one of the same type of service, between the locations, for the same customer is ordered and installed at the same time, one at each location is billed at the First Service Installed rate and the others are billed at the Additional Service Installed rate. If additional services are installed at a later date, then the First Service Installed rate and the Additional Service rated would apply to those services regardless of what service already existed.

The nonrecurring charges for the Installation of Services are set forth in Section A20.11 following as Nonrecurring Charges for the Local Channel and Interoffice Channel rate elements.

GENERAL EXCHANGE TARIFF

Embarq Florida, Inc.

By: F. B. Poag  
Director

SECTION A20  
First Revised Sheet 13  
Cancelling Original Sheet 13  
Effective: January 1, 1997

PRIVATE LINE SERVICES

A. PRIVATE LINE SERVICES (Cont'd)

8. Rate Regulations

a. Types of Rates and Charges (Cont'd)

2) Nonrecurring Charges (Cont'd)

b) Installation of Optional Features and Functions

Nonrecurring charges apply for the installation of features and functions available with the various services. For some features and functions there is a lower charge if installed coincident with the service and a higher charge if installed subsequent to the service. The "Initial" nonrecurring charge applies when the feature or function is installed at the same time as the service is installed. If the feature or function is installed after the service is established, then the "Subsequent" nonrecurring charge applies.

c) Service Rearrangements

- (1) Service rearrangements are changes to existing (installed) services which do not result in either a change in the minimum period requirements or a change in the physical location of the point of termination at a customer premises. Changes which result in the establishment of new minimum period obligations are treated as disconnects and starts. Changes in the physical location of the point of termination are treated as moves and are described and charged for as set forth in Section A20.A.8.a 2).c.(2).

The charge to the customer for the service rearrangement is dependent on whether the change is administrative only in nature or involves actual physical change to the service.



GENERAL EXCHANGE TARIFF

Embarq Florida, Inc.

By: F. B. Poag  
Director

SECTION A20  
First Revised Sheet 14  
Cancelling Original Sheet 14  
Effective: January 1, 1997

PRIVATE LINE SERVICES

A. PRIVATE LINE SERVICES (Cont'd)

8. Rate Regulations (Cont'd)

a. Types of Rates and Charges (Cont'd)

2) Nonrecurring Charges (Cont'd)

c) Service Rearrangements (Cont'd)

(1) (Cont'd)

Administrative changes will be made without charge(s) to the customer. Such changes require the continued provision and billing of the Private Line Service to the same entity (i.e., customer remains responsible for all outstanding indebtedness for the service). Administrative changes are as follows:

- Change of customer name (i.e., the customer of record does not change but rather the customer of record changes name).
- Change of customer or customer's premises address when the change of address is not a result of a physical relocation or equipment.
- Change in billing data (name, address or contact name or telephone number).

(2) All other service rearrangements will be charged for as follows:

- If the change involves the addition of other customer designated premises to an existing multipoint service, the nonrecurring charge for the local channel rate element will apply. The charges will apply only for the location(s) that is being added.

GENERAL EXCHANGE TARIFF

Embarq Florida, Inc.

By: F. B. Poag  
Director

SECTION A20  
First Revised Sheet 15  
Cancelling Original Sheet 15  
Effective: January 1, 1997

PRIVATE LINE SERVICES

A. PRIVATE LINE SERVICES (Cont'd)

8. Rate Regulations (Cont'd)

a. Types of Rates and Charges (Cont'd)

2) Nonrecurring Charges (Cont'd)

c) Service Rearrangements (Cont'd)

(2) All other service rearrangements will be charged for as follows:  
(Cont'd)

- If the change involves the addition of an optional feature or function which has a separate nonrecurring charge, that nonrecurring charge will apply.
- If the change involves changing the type of signaling on a voice grade service the subsequent nonrecurring charge will apply for the new type signaling. The charge will apply per service termination affected.
- For all other changes, including a change of the customer of record involving no physical changes to the service provided or the addition of optional features without separate nonrecurring charges, a charge equal to a local channel rate element nonrecurring charge will apply. Only one such charge will apply per service, per change.

GENERAL EXCHANGE TARIFF

Embarq Florida, Inc.

By: F. B. Poag  
Director

SECTION A20  
First Revised Sheet 16  
Cancelling Original Sheet 16  
Effective: January 1, 1997

PRIVATE LINE SERVICES

A. PRIVATE LINE SERVICES (Cont'd)

8. Rate Regulations (Cont'd)

b. Moves

- 1) A move involves a change in the physical location of one of the following:
  - a) The point of interface at the customer premises.
  - b) The customer's premises.
- 2) The charges for the move are dependent on whether the move is to a new location within the same building or to a different building.

a) Moves Within the Same Building

When the move is to a new location within the same building, the charge for the move will be an amount equal to one-half the nonrecurring (i.e., installation) charge for the affected service termination at the customer's premises. There will be no change in the minimum period requirements. If a move is made at the same time a service rearrangement is made, the total charge will never exceed a full nonrecurring charge for the basic service.

b) Moves To a Different Building

Moves to a different building will be treated as a discontinuance and start of service and all associated nonrecurring charges will apply. New minimum period requirements will be established at the new location. The customer will also remain responsible for satisfying all outstanding minimum period charges for the discontinued service.

GENERAL EXCHANGE TARIFF

Embarq Florida, Inc.

By: F. B. Poag  
Director

SECTION A20  
First Revised Sheet 17  
Cancelling Original Sheet 17  
Effective: January 1, 1997

PRIVATE LINE SERVICES

A. PRIVATE LINE SERVICES (Cont'd)

8. Rate Regulations (Cont'd)

c. Mileage Measurements

- 1) When station locations of a private line service are located in different wire center serving areas, interoffice channel charges apply. Charges are based on the direct airline distance measured between the serving wire centers. Mileage is determined in accordance with the following:
  - a) Obtain the "V" and "H" coordinates for each wire center, as listed in the National Exchange Carrier Association Tariff FCC No. 4.
  - b) Obtain the difference between the "V" coordinates of the two wire centers. Obtain the difference between the "H" coordinates. (The difference is always obtained by subtracting the smaller coordinate from the larger coordinate.)
  - c) Square each difference obtained in (b) preceding.
  - d) Add the squares of the "V" difference and the "H" difference obtained in (c) preceding.
  - e) Divide the sum of the squares obtained in (d) preceding by 10.

GENERAL EXCHANGE TARIFF

Embarq Florida, Inc.

By: F. B. Poag  
Director

SECTION A20  
First Revised Sheet 18  
Cancelling Original Sheet 18  
Effective: January 1, 1997

PRIVATE LINE SERVICES

A. PRIVATE LINE SERVICES (Cont'd)

8. Rate Regulations (Cont'd)

c. Mileage Measurements (Cont'd)

1) (Cont'd)

- f) Obtain the square root of the result obtained in (e) preceding. This is the rate distance in miles. (Fractional miles being considered as full miles.)

EXAMPLE: The rate distance is required between City One and City Two

	<u>V</u>	<u>H</u>
City One	7260	2083
City Two	7364	1865
Difference	104	218
Squared	10,816 + 47,524 = 58,340	
	58,340 divided by 10 = 5834	
	Square root of 5834 = 76.38 = 77 Airline Miles	

- 2) When a private line is furnished over facilities which the Company elects to provide on a direct basis and is not routed through a central office, one two-point channel charge will apply. The arrangement is limited to channels not more than one airline mile in length.
- 3) On a multipoint circuit, each channel connecting a hubbing wire center with a serving wire center, or a hubbing wire center with another hubbing wire center or a serving wire center with another serving wire center is considered a separate channel for which a mileage charge is independently computed. The total charge for a multi-point circuit channel is the combination of individual legs that connect all points. Bridging charges apply when three or more channels connect at the same location.

GENERAL EXCHANGE TARIFF

Embarq Florida, Inc.

By: F. B. Poag  
Director

SECTION A20  
First Revised Sheet 19  
Cancelling Original Sheet 19  
Effective: January 1, 1997

PRIVATE LINE SERVICES

A. PRIVATE LINE SERVICES (Cont'd)

8. Rate Regulations (Cont'd)

c. Mileage Measurements (Cont'd)

- 4) For Series 2000 channels the customer may specify the sequence in which the service points are to be connected in which case the rate mileage is the shortest airline mileage determined in accordance with paragraph 3) preceding which will connect the wire centers of the service points in the specified sequence.

d. Service Order Modifications

1) Service Date Change Charge

- a) Service Order service dates for installation of new services or rearrangements of existing services may be changed, but the new service date may not exceed the original service date by more than 30 calendar days.
- b) When, for any reason, the customer indicates that service cannot be accepted for a period not to exceed 30 calendar days, and the Company accordingly delays the start of service, a Service Date Change Charge will apply. If the customer requested service date is more than 30 calendar days after the original service date, the order will be cancelled by the Company and reissued with appropriate cancellation charges applied unless the customer indicates that billing for the service is to commence as set forth in Section A20.A.8.d.2) following.

GENERAL EXCHANGE TARIFF

Embarq Florida, Inc.

By: F. B. Poag  
Director

SECTION A20  
Second Revised Sheet 20  
Cancelling First Revised Sheet 20  
Effective: July 17, 1997

PRIVATE LINE SERVICES

A. PRIVATE LINE SERVICES (Cont'd)

8. Rate Regulations (Cont'd)

d. Service Order Modifications (Cont'd)

1) Service Date Change Charge (Cont'd)

c) A new service date may be established that is prior to the original service date if the Company determines it can accommodate the customer's request without delaying service dates for orders of other customers. If the service date is changed to an earlier date, the customer will be notified by the Company that an Expedited Order Charge as set forth in 2) following will apply. Such charges will apply in addition to the Service Date Change Charge.

d) A Service Date Change Charge will apply, on a per occurrence basis, for each service date changed. The applicable charge is as follows:

	<u>Charge</u>
Per Order	\$27.00

2) Cancellation Charge

a) A customer may cancel a service order for the installation of service at any time prior to notification by the Company that service is available for the customer's use. The cancellation date is the date the Company receives written or verbal notice from the customer that the order is canceled. If a customer is unable to accept service within 30 calendar days after the original service date, the customer has the choice of the following options:

GENERAL EXCHANGE TARIFF

Embarq Florida, Inc.

By: F. B. Poag  
Director

SECTION A20  
Second Revised Sheet 21  
Cancelling First Revised Sheet 21  
Effective: July 17, 1997

PRIVATE LINE SERVICES

A. PRIVATE LINE SERVICES (Cont'd)

8. Rate Regulations (Cont'd)

d. Service Order Modifications (Cont'd)

2) Cancellation Charge (Cont'd)

a) (Cont'd)

- The service order shall be cancelled and charges set for in b) following will apply, or
- Billing for the service will commence.

In any event, the cancellation date or the date billing is to commence (depending on which option is selected by the customer) shall be the 31st day beyond the original service date of the service order.

b) When a customer cancels a service order for the installation of service, a cancellation charge will apply as follows:

- (1) Costs incurred in conjunction with the provision of intraexchange or interexchange start on the Application Date as defined in A20.A.8.d.2)b)(4)(b) following.
- (2) When the customer cancels a service order prior to the Scheduled Issue Date, as defined in A20.A.8.d. 2)b)(4)(b) following, no charges shall apply.
- (3) When the customer cancels a service order on or after the Scheduled Issue Date, a charge equal to the estimated costs incurred by the Company shall apply. Such charge is determined as specified in A20.A.8.d.2 b)(4)(b) following.



GENERAL EXCHANGE TARIFF

Embarq Florida, Inc.

By: F. B. Poag  
Director

SECTION A20  
First Revised Sheet 22  
Cancelling Original Sheet 22  
Effective: January 1, 1997

PRIVATE LINE SERVICES

A. PRIVATE LINE SERVICES (Cont'd)

8. Rate Regulations (Cont'd)

d. Service Order Modifications (Cont'd)

2) Cancellation Charge (Cont'd)

b) Cont'd)

(4) Charges applicable as specified in A20.A.8.d. 2) b) (3) preceding are based on the estimated costs incurred by the Company at the time the order is cancelled. The estimated costs incurred are determined based on the following:

(a) Certain Company critical dates are associated with a service order provisioning interval, whether standard or negotiated. These dates are used by the Company to monitor the progress of the provisioning process. At any point in the service order interval the Company is able to determine which critical date was last and can thus determine what percentage of the Company's provisioning costs have been incurred as of that critical date.

(b) The critical dates tracked by the Company are as follows:

Application Date (APP): The date the customer provides to the Company, (1) a firm commitment for service and (2) sufficient information to enable the Company to begin service provisioning. This is also the order date.

Scheduled Issue Date (SID): The date that the order is to enter the Company's order distribution system.

GENERAL EXCHANGE TARIFF

Embarq Florida, Inc.

By: F. B. Poag  
Director

SECTION A20  
First Revised Sheet 23  
Cancelling Original Sheet 23  
Effective: January 1, 1997

PRIVATE LINE SERVICES

A. PRIVATE LINE SERVICES (Cont'd)

8. Rate Regulations (Cont'd)

d. Service Order Modifications (Cont'd)

2) Cancellation Charge (Cont'd)

b) (Cont'd)

(4) (Cont'd)

- (b) The critical dates tracked by the Company are as follows:  
(Cont'd)

Loop Assignment and Make-up Date (LCAM): The date by which Local Loop Assignment and Make-up information must be available.

Records Issue Date (RID): The date that all design and assignment information is to be sent to the central office and installation forces.

Material Issue Date (MID): The date material is shipped by the warehouse to field personnel for provisioning of the service.

Designed, Verified, and Assigned Date (DVA): The date by which field implementation groups must report that all documents and materials have been received.

Wired and Office Tested Date (WOT): The date by which all intraoffice wiring is to be completed, all plug-ins optioned, aligned, and frame continuity established, and the interoffice facilities, if applicable, tested. In addition, switching equipment, including translations loading, is to be installed and tested.

GENERAL EXCHANGE TARIFF

Embarq Florida, Inc.

By: F. B. Poag  
Director

SECTION A20  
First Revised Sheet 24  
Cancelling Original Sheet 24  
Effective: January 1, 1997

PRIVATE LINE SERVICES

A. PRIVATE LINE SERVICES (Cont'd)

8. Rate Regulations (Cont'd)

d. Service Order Modifications (Cont'd)

2) Cancellation Charge (Cont'd)

b) (Cont'd)

(4) (Cont'd)

- (b) The critical dates tracked by the Company are as follows:  
(Cont'd)

Plant Test Date (PTD): The date on which overall testing of the service is to be started.

Due Date (DD): The date on which service is to be made available to the customer.

- (c) The percentage of the total provisioning cost incurred by the Company at a particular critical date varies by the type of service shown in A20.A.8.d.2 b)(4)(e) following.
- (d) When a customer cancels a service order, or part of a service order, before the service date, the Company will apply cancellation charges to the order. Cancellation charges are calculated by multiplying all the nonrecurring charges associated with the order, or that part of the order being cancelled, by the percentage shown in A20.A.8.d.2 b)(4)(e) following for the critical date last completed on the order.

GENERAL EXCHANGE TARIFF

Embarq Florida, Inc.

By: F. B. Poag  
Director

SECTION A20  
Second Revised Sheet 25  
Cancelling First Revised Sheet 25  
Effective: January 6, 2003

PRIVATE LINE SERVICES

A. PRIVATE LINE SERVICES (Cont'd)

8. Rate Regulations (Cont'd)

d. Service Order Modifications (Cont'd)

2) Cancellation Charge (Cont'd)

b) (Cont'd)

(4) (Cont'd)

(e) Service Order Cancellation Charge Billing Percentages

TYPE SERVICE/ CRITICAL DATES	After:	SID	LCAM	RID	MID	DVA	WOT	PTD	DD
	Before:	LCAM	RID	MID	DVA	WOT	PTD	DD	
VOICE GRADE		7.0	12.0	16.0	20.0	29.0	52.0	84.0	100.0

(f) Cancellation charges for nondesign circuits are calculated by multiplying all the nonrecurring charges associated with the order, or that part of the order being cancelled, by 25% if the order is cancelled after the Application Date but before the Due Date. If the order is cancelled on the Due Date, 100% of the nonrecurring charges will apply.

(g) When a customer cancels an order for the discontinuance of service no charges apply for the cancellation.

GENERAL EXCHANGE TARIFF

Embarq Florida, Inc.

By: F. B. Poag  
Director

SECTION A20  
Second Revised Sheet 26  
Cancelling First Revised Sheet 26  
Effective: January 6, 2003

PRIVATE LINE SERVICES

A. PRIVATE LINE SERVICES (Cont'd)

8. Rate Regulations (Cont'd)

d. Service Order Modifications (Cont'd)

2) Cancellation Charge (Cont'd)

b) (Cont'd)

(4) (Cont'd)

(h) If the Company misses a service date by more than 30 days due to circumstances over which it has no direct control (excluding, e.g., acts of God, governmental requirements, work stoppages and civil commotions), the customer may cancel the service order without incurring cancellation charges.

e. Reserved for Future Use

f. Payment Arrangements and Credit Allowance

1) The minimum period for which month-to-month service is furnished and for which charges are applicable is one month.

2) Suspension of service is not allowed.

GENERAL EXCHANGE TARIFF

Embarq Florida, Inc.

By: F. B. Poag  
Director

SECTION A20  
First Revised Sheet 27  
Cancelling Original Sheet 27  
Effective: January 1, 1997

PRIVATE LINE SERVICES

A. PRIVATE LINE SERVICES (Cont'd)

8. Rate Regulations (Cont'd)

g. Billing of Private Line Service Provided by Multiple Companies Where an Exchange Telephone Company Does Not Concur in This Tariff

- 1) Each company will bill for the portion of the private line service provided by their respective tariff based on their regulations, rates and charges as appropriate.
- 2) The charges billed by each company for the interoffice channel between exchange telephone company central offices, are determined as follows:
  - a) The total mileage for the services is computed using the V&H coordinates set forth in the National Exchange Carrier Associated Tariff FCC No. 4 (NECA No. 4).
  - b) A billing factor is determined from the NECA No. 4 tariff. This factor represents the percentage of the distance between exchange telephone company central offices that will be billed by each company. The billing factor is multiplied by the total charge for all of the miles to determine the amount to be billed by the Company.
  - c) For the Fixed recurring rate element and the Nonrecurring Charge associated with the interoffice channel between exchange telephone company central offices, 50 percent of each company's rate will apply for each end of the interoffice channel provided. If the company does not bill for either end of the interoffice channel, then the fixed recurring charge and nonrecurring charges shall not apply.

GENERAL EXCHANGE TARIFF

Embarq Florida, Inc.

By: F. B. Poag  
Director

SECTION A20  
Third Revised Sheet 28  
Cancelling Second Revised Sheet 28  
Effective: January 6, 2003

PRIVATE LINE SERVICES

RESERVED FOR FUTURE USE

GENERAL EXCHANGE TARIFF

Embarq Florida, Inc.

By: F. B. Poag  
Director

SECTION A20  
First Revised Sheet 29  
Cancelling Original Sheet 29  
Effective: January 1, 1997

PRIVATE LINE SERVICES

A. PRIVATE LINE SERVICES (Cont'd)

9. Regulations Applicable to Channels

a. General Undertaking of the Company

- 1) Channels are electrical paths suitable for the purpose furnished and are to be derived from facilities in such a manner as the Company may elect. The Company will furnish channels for specific purposes, as described hereinafter, on a contract basis, subject to the availability of facilities and the requirements of the Company's telephone service and to such other conditions as are specified in this tariff.
- 2) The customer will provide all station apparatus used with the channels exclusive of the equipment necessary to derive the channel.
- 3) The channels are furnished under contract for use between two or more designated premises. The channels are intended only for communications in which the customer or an authorized user has a direct interest. The service shall not be used for any purpose for which a payment or other compensation shall be received by either the customer or any authorized user from any other person, firm or corporation for such use, or in the collection, transmission or delivery of any communication for others. This provision does not prohibit an arrangement between the customer and the authorized users to share the cost of the private line service. The contract or any rights acquired there under by the customer may not be assigned or in any manner transferred.



GENERAL EXCHANGE TARIFF

Embarq Florida, Inc.

By: F. B. Poag  
Director

SECTION A20  
First Revised Sheet 30  
Cancelling Original Sheet 30  
Effective: January 1, 1997

PRIVATE LINE SERVICES

A. PRIVATE LINE SERVICES (Cont'd)

9. Regulations Applicable to Channels (Cont'd)

b. Channels Used for More than One Purpose or Combination of Channels Used for a Single Purpose

A channel is furnished to a customer for a definite primary purpose of use; the use of a channel for purposes which are incidental to the main use is permitted without additional charge, provided the channel is suitable for such use and unless otherwise indicated. Additional primary uses of the same channel are permitted only at additional charges except as provided in this tariff.

c. Use of Channels by Customer

- 1) The customer may not create additional channels from facilities provided by the Company except as provided in this tariff.
- 2) The magnitude and the character of the voltages and currents impressed on the Company channel by the customer-owned equipment and wiring and the operation and maintenance of such equipment and wiring shall be such as not to interfere with any of the services offered by the Company or interfere with others. The characteristics of the customer -owned apparatus shall be such that its connection to the Company channel does not interfere with service over other Company circuits or channels or impair privacy of conversations over such circuits or channels.
- 3) The Company may, upon suitable notification to the customer, make such tests and inspections as may be necessary to determine that the above requirements are being complied with in the installation, operation and maintenance of customer owned equipment. The Company may interrupt the channel if at any time such action should become necessary in order to protect any of its services because of departure from these requirements.

GENERAL EXCHANGE TARIFF

Embarq Florida, Inc.

By: F. B. Poag  
Director

SECTION A20  
Third Revised Sheet 31  
Cancelling Second Revised Sheet 31  
Effective: January 6, 2003

PRIVATE LINE SERVICES

A. PRIVATE LINE SERVICES (Cont'd)

9. Regulations Applicable to Channels (Cont'd)

c. Use of Channels by Customer (Cont'd)

- 4) The channels and equipment furnished by the Company shall not be connected either directly or indirectly with channel facilities provided other than by the Company except as provided in this tariff, including amendments thereto and successive issues thereof.

GENERAL EXCHANGE TARIFF

Embarq Florida, Inc.

By: F. B. Poag  
Director

SECTION A20  
Second Revised Sheet 32  
Cancelling First Revised Sheet 32  
Effective: January 6, 2003

PRIVATE LINE SERVICES

RESERVED FOR FUTURE USE

GENERAL EXCHANGE TARIFF

Embarq Florida, Inc.

By: F. B. Poag  
Director

SECTION A20  
Second Revised Sheet 33  
Cancelling First Revised Sheet 33  
Effective: January 6, 2003

PRIVATE LINE SERVICES

RESERVED FOR FUTURE USE

GENERAL EXCHANGE TARIFF

Embarq Florida, Inc.

By: F. B. Poag  
Director

SECTION A20  
Second Revised Sheet 34  
Cancelling First Revised Sheet 34  
Effective: January 6, 2003

PRIVATE LINE SERVICES

RESERVED FOR FUTURE USE

GENERAL EXCHANGE TARIFF

Embarq Florida, Inc.

By: F. B. Poag  
Director

SECTION A20  
Second Revised Sheet 35  
Cancelling First Revised Sheet 35  
Effective: January 6, 2003

PRIVATE LINE SERVICES

RESERVED FOR FUTURE USE

GENERAL EXCHANGE TARIFF

Embarq Florida, Inc.

By: F. B. Poag  
Director

SECTION A20  
Second Revised Sheet 36  
Cancelling First Revised Sheet 36  
Effective: January 6, 2003

PRIVATE LINE SERVICES

RESERVED FOR FUTURE USE

GENERAL EXCHANGE TARIFF

Embarq Florida, Inc.

By: F. B. Poag  
Director

SECTION A20  
Second Revised Sheet 37  
Cancelling First Revised Sheet 37  
Effective: January 6, 2003

PRIVATE LINE SERVICES

RESERVED FOR FUTURE USE



GENERAL EXCHANGE TARIFF

Embarq Florida, Inc.

By: F. B. Poag  
Director

SECTION A20  
Second Revised Sheet 38  
Cancelling First Revised Sheet 38  
Effective: January 6, 2003

PRIVATE LINE SERVICES

RESERVED FOR FUTURE USE

GENERAL EXCHANGE TARIFF

Embarq Florida, Inc.

By: F. B. Poag  
Director

SECTION A20  
Second Revised Sheet 39  
Cancelling First Revised Sheet 39  
Effective: January 6, 2003

PRIVATE LINE SERVICES

RESERVED FOR FUTURE USE

GENERAL EXCHANGE TARIFF

Embarq Florida, Inc.

By: F. B. Poag  
Director

SECTION A20  
Second Revised Sheet 40  
Cancelling First Revised Sheet 40  
Effective: July 17, 1997

PRIVATE LINE SERVICES

RESERVED FOR FUTURE USE

GENERAL EXCHANGE TARIFF

Embarq Florida, Inc.

By: F. B. Poag  
Director

SECTION A20  
Second Revised Sheet 41  
Cancelling First Revised Sheet 41  
Effective: July 17, 1997

PRIVATE LINE SERVICES

RESERVED FOR FUTURE USE

GENERAL EXCHANGE TARIFF

Embarq Florida, Inc.

By: F. B. Poag  
Director

SECTION A20  
First Revised Sheet 42  
Cancelling Original Sheet 42  
Effective: January 1, 1997

PRIVATE LINE SERVICES

A. PRIVATE LINE SERVICES (Cont'd)

10. Service Descriptions (Cont'd)

b. Voice Grade Service (Series 2000)

- 1) Series 2000 voice grade service provides for voice and/or data communications on a two-point or multipoint basis for service 7 days per week, 24 hours per day, for a minimum period of one month. Channels which provide Tie Line Service will not be furnished to connect a flat-rate system with a message rate system. The transmission characteristics and various types of services furnished within this Series are described in 2) and 3) following.
- 2) Basic parameters and specifications for Series 2000 voice grade service are described for the end to end operation as follows:

Basic Parameters

For Speech Application

For Data Application

Net Loss

Local Channels used with terminal equipment: Limit as specified in the following Local Channel descriptions. Losses or gains present in CPE have not been included.

DC Resistance

Local Channel limit as specified in the following Local Channel descriptions. Does not imply or guarantee end to end DC continuity.

Frequency Error  
Frequency Response

Plus or Minus 5 Hz  
(Referenced to  
1000 Hz loss)

Plus or Minus 5 Hz

300 - 3000 Hz  
500 - 2500 Hz

-3dB to + 12 dB  
-2dB to + 8 dB

-3dB to + 12 dB  
-2dB to + 8 dB

GENERAL EXCHANGE TARIFF

Embarq Florida, Inc.

By: F. B. Poag  
Director

SECTION A20  
Second Revised Sheet 43  
Cancelling First Revised Sheet 43  
Effective: July 17, 1997

PRIVATE LINE SERVICES

A. PRIVATE LINE SERVICES (Cont'd)

10. Service Descriptions (Cont'd)

b. Voice Grade Service (Series 2000) (Cont'd)

- 2) Basic parameters and specifications for Series 2000 voice grade service are described for the end to end operation as follows: (Cont'd)

<u>Basic Parameters</u>	<u>For Speech Application</u>	<u>For Data Application</u>
Envelope Delay Distortion 800 - 2600 Hz	Not Controlled	Less than 1750 Microseconds
C-Notched Noise (with a -13dBmO 1000 Hz Test Signal)	Not Controlled	Noise Level 24dB below signal level
Impulse Noise	Not Controlled	15 Counts in 15 minutes at a threshold of 6Db below a -13dBmO rms 1000 Hz Signal
Phase Jitter	Not Controlled	10 degrees peak to peak
Non-Linear Distortion 2nd Order Distortion 3rd Order Distortion	Not Controlled Not Controlled Not Controlled	25dB below signal level 30dB below signal level

GENERAL EXCHANGE TARIFF

Embarq Florida, Inc.

By: F. B. Poag  
Director

SECTION A20  
Second Revised Sheet 44  
Cancelling First Revised Sheet 44  
Effective: July 17, 1997

PRIVATE LINE SERVICES

A. PRIVATE LINE SERVICES (Cont'd)

10. Service Descriptions (Cont'd)

b. Voice Grade Service (Series 2000) (Cont'd)

3) Transmission parameters for voice grade service are described following:

- a) Type 2230 (2001/2101) - A two-wire interface with effective two-wire facilities engineered for a 1004 Hz net loss of 0 - 10dB. Generally furnished for voice transmission - Private Line Telephone, Mobile Radio Telephone or Supervisory Control Use. Multipoint service may be provided at charges specified in Section A20. 11. c. 1) following.
- b) Type 2231 (2012/2112) - A two-wire interface with two or four-wire facilities engineered for a 1004 Hz net loss of 0dB to 4.5dB. This is generally used for PBX (or similar system) main or extension station services. Signaling is required for this service.
- c) Type 2432 (2014/2114) - A two or four-wire interface with effective four-wire facilities engineered for tie line service use between PBX's or customer-provided communications systems. Signaling is required for this service.

GENERAL EXCHANGE TARIFF

Embarq Florida, Inc.

By: F. B. Poag  
Director

SECTION A20  
Second Revised Sheet 45  
Cancelling First Revised Sheet 45  
Effective: July 17, 1997

PRIVATE LINE SERVICES

A. PRIVATE LINE SERVICES (Cont'd)

10. Service Descriptions (Cont'd)

b. Voice Grade Service (Series 2000) (Cont'd)

3) (Cont'd)

- d) Type 2434 (2015/2115) - A two or four-wire interface for connection to the serving wire center where loop facilities are not required. This channel is suitable for tie line service (with E&M signaling) between Centrex services, or between Centrex service and ETS service, and may be connected with Type 2432 local channels.
- e) Type 2435 - A four-wire interface with effective four-wire facilities engineered for a 1004 Hz net loss of 0dB to 16dB. Generally furnished for voice transmission. Multipoint service may be provided at charges specified in A20.11.c.1) following.
- f) Type 2260 (2021/2121) - A two-wire<sup>1</sup> interface with effective two-wire facilities engineered for 1004 Hz net loss of 16dB. Generally used in the provision of low speed (1200 baud or less) half duplex data services.
- g) Type 2261 (2040/2140) - A two-wire interface with effective two-wire facilities engineered for use in Dataphone (Data) Select-A-Station Service or Telemetry/Alarm Bridging Service (TABS).

Note 1: Transmission data characteristics can only be met and guaranteed for the two-wire interface when the airline distance from the serving wire center to the customer's premises is one mile or less and the interoffice channel is not greater than 4 airline miles between serving wire centers.



GENERAL EXCHANGE TARIFF

Embarq Florida, Inc.

By: F. B. Poag  
Director

SECTION A20  
First Revised Sheet 46  
Cancelling Original Sheet 46  
Effective: January 1, 1997

PRIVATE LINE SERVICES

A. PRIVATE LINE SERVICES (Cont'd)

10. Service Descriptions (Cont'd)

b. Voice Grade Service (Series 2000) (Cont'd)

3) (Cont'd)

h) Type 2462 (2041/2141) - A four-wire interface with effective four-wire facilities engineered for use in Dataphone Select-A-Station Service, WatchAlert service or Telemetry/Alarm Bridging Service (TABS).

l) Type 2463 (2020/2120) - A four-wire interface with four-wire facilities engineered for a 1004 Hz net loss of 16dB. Generally used in the provision of analog data services. Multipoint service may be provided at charges specified in A20. 11. c. 1) following.

j) Type 2464 (2022/2122) - A two-wire interface with four-wire facilities engineered for a 1004 Hz net loss of 16dB. Generally used in the provision of analog data services. Multipoint service may be provided at charges specified in A20. 11. c. 1) following.

4) Signaling Arrangements

a) Off Premises Stations

(1) For use with PBX (or similar system) off-premises channels for terminal equipment. Signaling arrangements are furnished for grandfathered and registered PBX (or similar) systems in accordance with Part 68 of the FCC Rules and Regulations or for customer-provided communications systems not subject to Part 68 of the FCC Rules and Regulations.

GENERAL EXCHANGE TARIFF

Embarq Florida, Inc.

By: F. B. Poag  
Director

SECTION A20  
First Revised Sheet 47  
Cancelling Original Sheet 47  
Effective: January 1, 1997

PRIVATE LINE SERVICES

A. PRIVATE LINE SERVICES (Cont'd)

10. Service Descriptions (Cont'd)

b. Voice Grade Service (Series 2000) (Cont'd)

4) Signaling Arrangements (Cont'd)

a) Off Premises Stations (Cont'd)

(1) (Cont'd)

Type A - Furnished for use with Class A PBX (or similar) system stations ports capable of operations over loops with resistance in the range of 0-199 ohms.

Type B - Furnished for use with Class B PBX (or similar) system stations ports capable of operation over loops with resistance in the range of 200-899 ohms.

Type C - Furnished for use with Class C PBX (or similar) system stations ports capable of operation over loops with resistance in the range of 900 ohms or more.

- (2) For connections to registered or grandfathered PBX (or similar) system equipment, the customer must specify the equipment capability for use with Type A, B or C Signaling Arrangements.

b) Tie Lines

- (1) E&M signaling is provided for use with tie line channels with E&M signaling interfaces. Signaling arrangements are furnished for grandfathered and registered PBX's in accordance with Part 68 of the FCC Rules and Regulations or for customer-provided communications systems not subject to Part 68 of the FCC Rules and Regulations.

GENERAL EXCHANGE TARIFF

Embarq Florida, Inc.

By: F. B. Poag  
Director

SECTION A20  
First Revised Sheet 48  
Cancelling Original Sheet 48  
Effective: January 1, 1997

PRIVATE LINE SERVICES

A. PRIVATE LINE SERVICES (Cont'd)

10. Service Descriptions (Cont'd)

b. Voice Grade Service (Series 2000) (Cont'd)

4) Signaling Arrangements (Cont'd)

b) Tie Lines (Cont'd)

(1) (Cont'd)

- An E&M Signaling Arrangement is required for each tie line termination, operating in Dial Repeating mode, at a customer's premises with a registered PBX.
- An E&M Signaling Arrangement is required for each tie line termination at a customer's premises with grandfathered PBX's when the tie line is arranged with an E&M signaling interface.
- An E&M Signaling Arrangement is not required with Types 2432 and 2434 channels for additions to or for new installations of grandfathered PBX equipment when not arranged with an E&M signaling interface.
- An E&M Signaling Arrangement is required for each Type 2432 or 2434 channel termination at a customer's premises with a customer-provided communications system not subject to Part 68 of the FCC Rules and Regulations when arranged with an E&M signaling interface.

GENERAL EXCHANGE TARIFF

Embarq Florida, Inc.

By: F. B. Poag  
Director

SECTION A20  
First Revised Sheet 49  
Cancelling Original Sheet 49  
Effective: January 1, 1997

PRIVATE LINE SERVICES

A. PRIVATE LINE SERVICES (Cont'd)

10. Service Descriptions (Cont'd)

b. Voice Grade Service (Series 2000) (Cont'd)

5) Dataphone Select-A-Station Service (Data Service, Analog)

Dataphone Select-A-Station Service is a multi-station, voice grade private line data system designed to establish point-to-point connections rapidly between a master station and a number of remote stations one at a time. This service is suitable for Alarm Service and uses channel types 2261 and 2462 described in 3) preceding. Direct transmission between remote stations is not possible, nor is simultaneous communications from the master to more than one remote station possible.

a) Regulations

The regulations specified herein are in addition to the regulations contained in A20.A.1. of this Section. The service name "Data Service, Analog" previously used in the Central Telephone area will be changed to the service name "Dataphone Select-A-Service" as of the effective date of this tariff.

- (1) Dataphone Select-A-Station Service requires the use of equipment as described herein A20.A.10.b.5)b) and type 2261 and 2462 voice grade channels as described in A20.A.10.b.3) preceding.
- (2) The Company will furnish, subject to availability of facilities, Dataphone Select-A-Station Service channels suitable for voice grade data transmission.

GENERAL EXCHANGE TARIFF

Embarq Florida, Inc.

By: F. B. Poag  
Director

SECTION A20  
First Revised Sheet 50  
Cancelling Original Sheet 50  
Effective: January 1, 1997

PRIVATE LINE SERVICES

A. PRIVATE LINE SERVICES (Cont'd)

10. Service Descriptions (Cont'd)

b. Voice Grade Service (Series 2000) (Cont'd)

5) Dataphone Select-A-Station Service (Data Service, Analog) (Cont'd)

a) Regulations (Cont'd)

(3) Dataphone Select-A-Station Service channels are not provided for alternate voice-data transmission or DC continuity.

(4) The customer shall provide terminal equipment in accordance with interface specifications as described in Technical Reference PUB 41014, "Data Communications Using Dataphone Select-A-Station Service".

b) A Primary Data Station Selector, PDSS, provides the connection between the master station and any one of up to 128 (125 for addressable operations) two-wire or four-wire voice grade data channels. Where more than one DSS is required, the DSS that is directly connected to the master station (SCU) is termed the Primary Data Station Selector (PDSS). Additional DSS's designated Secondary Data Selectors (SDSS) connected to the PDSS, may be provided.

c) A Selector Control Unit SCU, will be provided at the master station location. The SCU is used by the customer to transmit control and/or address signals to the DSS's and to receive supervisory signals from DSS's.

GENERAL EXCHANGE TARIFF

Embarq Florida, Inc.

By: F. B. Poag  
Director

SECTION A20  
First Revised Sheet 51  
Cancelling Original Sheet 51  
Effective: January 1, 1997

PRIVATE LINE SERVICES

A. PRIVATE LINE SERVICES (Cont'd)

10. Service Descriptions (Cont'd)

b. Voice Grade Service (Series 2000) (Cont'd)

5) Dataphone Select-A-Station Service (Data Service, Analog) (Cont'd)

d) Dataphone Select-A-Station Service arranged for the sequential mode of operation requires customer specification, prior to installation, of the order of connections from the DSS to the remote stations. The customer also must specify one of the following three DSS options to accommodate customer operating procedures and circuit structure:

(1) Automatic Step<sup>1</sup>

A DSS option in which the duration and order of connections are fixed.

(2) Automatic Step with Reset

A DSS option in which the duration and order of connections are fixed, but the DSS will reset to the beginning of the connection cycle upon command from the master station.

(3) Controlled Step

A DSS option which allows the customer to have in-service control over the duration of the connection. However, the order of the connections is fixed.

NOTE 1: A DSS optioned for automatic step or automatic step with reset cannot be connected to a secondary DSS.

GENERAL EXCHANGE TARIFF

Embarq Florida, Inc.

By: F. B. Poag  
Director

SECTION A20  
First Revised Sheet 52  
Cancelling Original Sheet 52  
Effective: January 1, 1997

PRIVATE LINE SERVICES

A. PRIVATE LINE SERVICES (Cont'd)

10. Service Descriptions (Cont'd)

b. Voice Grade Service (Series 2000) (Cont'd)

5) Dataphone Select-A-Station Service (Data Service, Analog) (Cont'd)

- e) Dataphone Select-A-Station Service arranged for addressable operation provides for the duration and order of connections to be variables, controlled by the master station.
- f) Access from the PDSS to the SCU is obtained through a Type 2462 local channel. PDSSs located outside of the serving wire center where the SCU is located will require voice grade interoffice channels at charges as contained in Section A20.A.11.b of this tariff.
- g) Access to each remote station from the DSS is obtained through a Type 2261 or 2462 local channel. Remote stations located outside of the serving wire center where the DSS is located will require voice grade interoffice channels at charges as contained in Section A20.11.b of this tariff.
- h) Access to each SDSS from the PDSS is obtained through a Type 2261 or 2462 local channel. A SDSS located outside of the serving wire center where the PDSS is located will require voice grade interoffice channels at charges as contained in Section A20.A.11.b of this tariff.

GENERAL EXCHANGE TARIFF

Embarq Florida, Inc.

By: F. B. Poag  
Director

SECTION A20  
First Revised Sheet 53  
Cancelling Original Sheet 53  
Effective: January 1, 1997

PRIVATE LINE SERVICES

A. PRIVATE LINE SERVICES (Cont'd)

10. Service Descriptions (Cont'd)

b. Voice Grade Service (Series 2000) (Cont'd)

6) Telemetry/Alarm Bridging Service (TABS) (Alarm Service)

a) Regulations

- (1) This tariff section contains the regulations applicable for Telemetry/Alarm Bridging Service (TABS). The service name "Alarm Service" previously used in the Central Telephone area will be changed to the service name "Telemetry/Alarm Bridging Service (TABS)" as of the effective date of this tariff.
- (2) Except as otherwise specified following, the regulations contained herein are in addition to the regulations found in other sections of this tariff.
- (3) TABS requires the use of equipment as specified herein and Type 2261 or 2462 voice grade local channels described in Section A20. 10. b. 3) preceding.
- (4) Terminal equipment provided by the customer for use with TABS must meet specifications for such customer-provided equipment found in other sections of this tariff.
- (5) No more than 128 remote stations may be connected to master station over an individual Split Band Active Bridge.



GENERAL EXCHANGE TARIFF

Embarq Florida, Inc.

By: F. B. Poag  
Director

SECTION A20  
First Revised Sheet 54  
Cancelling Original Sheet 54  
Effective: January 1, 1997

PRIVATE LINE SERVICES

A. PRIVATE LINE SERVICES (Cont'd)

10. Service Descriptions (Cont'd)

b. Voice Grade Service (Series 2000) (Cont'd)

6) Telemetry/Alarm Bridging Service (TABS) (Alarm Service) (Cont'd)

a) Regulations (Cont'd)

- (6) In Split Band Active Bridging arrangements, secondary bridges must be directly connected to the primary bridge via mid-link channels. Secondary bridges cannot be connected through other secondary bridges to allow additional layers of tandeming.
- (7) Secondary bridges, utilized in Split Band Active Bridging arrangements, reduce the two-wire remote station capacity of the primary bridge. The initial secondary bridge reduces the primary bridge capacity by twelve two-wire remote station connections. Each subsequent secondary bridge reduces the primary bridge capacity by four additional two-wire remote station connections.
- (8) Standard multipoint bridging charges as provided in other sections of this tariff are not applicable to TABS.
- (9) Access over four-wire master station channels for Split Band Active Bridging is provided using a Type 2462 local channel.

GENERAL EXCHANGE TARIFF

Embarq Florida, Inc.

By: F. B. Poag  
Director

SECTION A20  
First Revised Sheet 55  
Cancelling Original Sheet 55  
Effective: January 1, 1997

PRIVATE LINE SERVICES

A. PRIVATE LINE SERVICES (Cont'd)

10. Service Descriptions (Cont'd)

b. Voice Grade Service (Series 2000) (Cont'd)

6) Telemetry/Alarm Bridging Service (TABS) (Alarm Service) (Cont'd)

a) Regulations (Cont'd)

(10) Access over remote station channels is provided through a Type 2261 local channel and through the appropriate channel connection as contained in Section A20.A.11.c.1)a)(5) following. Interconnection of remote stations located outside the serving wire center where the bridge to which they are to be connected is located will require interoffice channels at charges contained in Section A20.A.11.b of this tariff.

(11) Access over each four-wire mid-link channel for Split Band Active Bridging is through voice grade interoffice channels at charges contained in Section A20.A.11.c.1)a)(5) following.

b) Service Description

(1) Telemetry/Alarm Bridging Service (TABS) is a multi-station, voice frequency, private line service designed to provide connections between a master station and a number of remote stations simultaneously. Direct transmission between remote stations is not intended. This service is intended for application in multipoint, voice frequency, data or tone signaling arrangements with transmission at rates up to 400 baud.

GENERAL EXCHANGE TARIFF

Embarq Florida, Inc.

By: F. B. Poag  
Director

SECTION A20  
Third Revised Sheet 56  
Cancelling Second Revised Sheet 56  
Effective: January 6, 2003

PRIVATE LINE SERVICES

A. PRIVATE LINE SERVICES (Cont'd)

10. Service Descriptions (Cont'd)

b. Voice Grade Service (Series 2000) (Cont'd)

6) Telemetry/Alarm Bridging Service (TABS) (Alarm Service) (Cont'd)

a) Service Description (Cont'd)

(2) TABS is provided in the following arrangement:

Split Band, Active Bridging - A bridging arrangement providing for a four-wire (master station or mid-link channel) frequency split common port and multiple two-wire (remote station) ports intended for application in multipoint, voice frequency, data or tone signaling arrangements. Two-way (polling) communication between the master station and each remote station is intended.

GENERAL EXCHANGE TARIFF

Embarq Florida, Inc.

By: F. B. Poag  
Director

SECTION A20  
Second Revised Sheet 57  
Cancelling First Revised Sheet 57  
Effective: January 6, 2003

PRIVATE LINE SERVICES

RESERVED FOR FUTURE USE

GENERAL EXCHANGE TARIFF

Embarq Florida, Inc.

By: F. B. Poag  
Director

SECTION A20  
Second Revised Sheet 58  
Cancelling First Revised Sheet 58  
Effective: January 6, 2003

PRIVATE LINE SERVICES

RESERVED FOR FUTURE USE

GENERAL EXCHANGE TARIFF

Embarq Florida, Inc.

By: F. B. Poag  
Director

SECTION A20  
Second Revised Sheet 59  
Cancelling First Revised Sheet 59  
Effective: January 6, 2003

PRIVATE LINE SERVICES

RESERVED FOR FUTURE USE

GENERAL EXCHANGE TARIFF

Embarq Florida, Inc.

By: F. B. Poag  
Director

SECTION A20  
Second Revised Sheet 60  
Cancelling First Revised Sheet 60  
Effective: January 6, 2003

PRIVATE LINE SERVICES

RESERVED FOR FUTURE USE

GENERAL EXCHANGE TARIFF

Embarq Florida, Inc.

By: F. B. Poag  
Director

SECTION A20  
Second Revised Sheet 61  
Cancelling First Revised Sheet 61  
Effective: January 6, 2003

PRIVATE LINE SERVICES

RESERVED FOR FUTURE USE



GENERAL EXCHANGE TARIFF

Embarq Florida, Inc.

By: F. B. Poag  
Director

SECTION A20  
Second Revised Sheet 62  
Cancelling First Revised Sheet 62  
Effective: January 6, 2003

PRIVATE LINE SERVICES

RESERVED FOR FUTURE USE

GENERAL EXCHANGE TARIFF

Embarq Florida, Inc.

By: F. B. Poag  
Director

SECTION A20  
Second Revised Sheet 63  
Cancelling First Revised Sheet 63  
Effective: January 6, 2003

PRIVATE LINE SERVICES

RESERVED FOR FUTURE USE

GENERAL EXCHANGE TARIFF

Embarq Florida, Inc.

By: F. B. Poag  
Director

SECTION A20  
Second Revised Sheet 64  
Cancelling First Revised Sheet 64  
Effective: January 6, 2003

PRIVATE LINE SERVICES

RESERVED FOR FUTURE USE

GENERAL EXCHANGE TARIFF

Embarq Florida, Inc.

By: F. B. Poag  
Director

SECTION A20  
Second Revised Sheet 65  
Cancelling First Revised Sheet 65  
Effective: January 6, 2003

PRIVATE LINE SERVICES

RESERVED FOR FUTURE USE

GENERAL EXCHANGE TARIFF

Embarq Florida, Inc.

By: F. B. Poag  
Director

SECTION A20  
Second Revised Sheet 66  
Cancelling First Revised Sheet 66  
Effective: January 6, 2003

PRIVATE LINE SERVICES

RESERVED FOR FUTURE USE

GENERAL EXCHANGE TARIFF

Embarq Florida, Inc.

By: F. B. Poag  
Director

SECTION A20  
Second Revised Sheet 67  
Cancelling First Revised Sheet 67  
Effective: January 6, 2003

PRIVATE LINE SERVICES

RESERVED FOR FUTURE USE

GENERAL EXCHANGE TARIFF

Embarq Florida, Inc.

By: F. B. Poag  
Director

SECTION A20  
Second Revised Sheet 68  
Cancelling First Revised Sheet 68  
Effective: January 6, 2003

PRIVATE LINE SERVICES

RESERVED FOR FUTURE USE

GENERAL EXCHANGE TARIFF

Embarq Florida, Inc.

By: F. B. Poag  
Director

SECTION A20  
Second Revised Sheet 69  
Cancelling First Revised Sheet 69  
Effective: January 6, 2003

PRIVATE LINE SERVICES

RESERVED FOR FUTURE USE



GENERAL EXCHANGE TARIFF

Embarq Florida, Inc.

By: F. B. Poag  
Director

SECTION A20  
Second Revised Sheet 70  
Cancelling First Revised Sheet 70  
Effective: January 6, 2003

PRIVATE LINE SERVICES

RESERVED FOR FUTURE USE

GENERAL EXCHANGE TARIFF

Embarq Florida, Inc.

By: F. B. Poag  
Director

SECTION A20  
Third Revised Sheet 71  
Cancelling Second Revised Sheet 71  
Effective: January 6, 2003

PRIVATE LINE SERVICES

RESERVED FOR FUTURE USE

GENERAL EXCHANGE TARIFF

Embarq Florida, Inc.

By: F. B. Poag  
Director

SECTION A20  
Second Revised Sheet 72  
Cancelling First Revised Sheet 72  
Effective: January 6, 2003

PRIVATE LINE SERVICES

RESERVED FOR FUTURE USE

GENERAL EXCHANGE TARIFF

Embarq Florida, Inc.

By: F. B. Poag  
Director

SECTION A20  
Eleventh Revised Sheet 73  
Cancelling Tenth Revised Sheet 73  
Effective: May 5, 2005

PRIVATE LINE SERVICES

A. PRIVATE LINE SERVICES (Cont'd)

11. Rates and Charges

a. Local Channels

2) Voice Grade, Series 2000  
Per Point of Termination

	Monthly Rate	Nonrecurring Charge	
		First	Additional
a) Voice			
Type 2230	\$59.00	\$270.00	\$ 87.00
Type 2231	59.00	270.00	87.00
Type 2432	59.00	275.00	97.00
Type 2434	14.00	275.00	133.00
Type 2435	59.00	275.00	110.00
Type 2261	59.00	270.00	110.00
Type 2462	59.00	275.00	110.00
b) Data			
Type 2260	\$59.00	295.00	109.00
Type 2463	59.00	300.00	109.00
Type 2464	59.00	300.00	109.00

GENERAL EXCHANGE TARIFF

Embarq Florida, Inc.

By: F. B. Poag  
Director

SECTION A20  
Eighth Revised Sheet 74  
Cancelling Seventh Revised Sheet 74  
Effective: May 5, 2005

PRIVATE LINE SERVICES

A. PRIVATE LINE SERVICES (Cont'd)

11. Rates and Charges

a. Local Channels (Cont'd)

2) Voice Grade, Series 2000  
Per Point of Termination (Cont'd)

c) Non-Wire Center Connected Channels - both Companies

1. Intra-building Served Direct - Not routed via the central limited to one airline mile or less, per point of termination

	<u>Monthly Rate</u>	<u>Nonrecurring Charge</u>	
		<u>First</u>	<u>Additional</u>
Series 2000	\$13.00	\$135.00	\$47.00

2. Inter-building connected channels not routed via the central office utilizing telephone company owned facilities (limited to channels not more than one air mile in length), per point of termination.

	<u>Monthly Rate</u>	<u>Nonrecurring Charge</u>	
		<u>First</u>	<u>Additional</u>
Series 2000	\$13.00	\$135.00	\$47.00

- a) Service Ordering Charges are applicable per service order issued. These charges include the engineering design function. Only one Service Ordering Charge applies when more than one channel service of the same type is ordered for termination at the same premises at the same time.
- b) Premises Visit Charges are applicable for the termination of Series 2000, inter-building channels not routed via the central office. Only one Premises Visit Charge applies when more than one channel service of this same type is terminated at the same premises at the same time.

GENERAL EXCHANGE TARIFF

Embarq Florida, Inc.

By: F. B. Poag  
Director

SECTION A20  
Fourth Revised Sheet 75  
Cancelling Third Revised Sheet 75  
Effective: April 7, 2002

PRIVATE LINE SERVICES

RESERVED FOR FUTURE USE

GENERAL EXCHANGE TARIFF

Embarq Florida, Inc.

By: F. B. Poag  
Director

SECTION A20  
Ninth Revised Sheet 76  
Cancelling Eighth Revised Sheet 76  
Effective: January 6, 2003

PRIVATE LINE SERVICES

RESERVED FOR FUTURE USE

GENERAL EXCHANGE TARIFF

Embarq Florida, Inc.

By: F. B. Poag  
Director

SECTION A20  
Twelfth Revised Sheet 77  
Cancelling Eleventh Revised Sheet 77  
Effective: May 5, 2005

PRIVATE LINE SERVICES

A. PRIVATE LINE SERVICES (Cont'd)

11. Rates and Charges (Cont'd)

b. Interoffice Channels

	<u>Fixed Monthly Charge</u>	<u>Per Mile Monthly Charge</u>	<u>NRC</u>
2) Voice Grade Service	\$45.00	\$3.00	\$87.00



GENERAL EXCHANGE TARIFF

Embarq Florida, Inc.

By: F. B. Poag  
Director

SECTION A20  
Seventh Revised Sheet 78  
Cancelling Sixth Revised Sheet 78  
Effective: January 6, 2003

PRIVATE LINE SERVICES

RESERVED FOR FUTURE USE

GENERAL EXCHANGE TARIFF

Embarq Florida, Inc.

By: F. B. Poag  
Director

SECTION A20  
Third Revised Sheet 79  
Cancelling Second Revised Sheet 79  
Effective: April 10, 2001

PRIVATE LINE SERVICES

RESERVED FOR FUTURE USE

GENERAL EXCHANGE TARIFF

Embarq Florida, Inc.

By: F. B. Poag  
Director

SECTION A20  
Sixth\_Revised Sheet 80  
Cancelling Fifth\_Revised Sheet 80  
Effective: January 6, 2003

PRIVATE LINE SERVICES

RESERVED FOR FUTURE USE

GENERAL EXCHANGE TARIFF

Embarq Florida, Inc.

By: F. B. Poag  
Director

SECTION A20  
Seventh Revised Sheet 81  
Cancelling Sixth Revised Sheet 81  
Effective: May 5, 2005

PRIVATE LINE SERVICES

A. PRIVATE LINE SERVICES (Cont'd)

11. Rates and Charges (Cont'd)

c. Optional Features and Functions

1) Bridging

Bridging charges are applicable where more than two Local Channels, or one or more Local Channels and more than one Interoffice Channel, or more than one Local Channel and one interoffice Channel are bridged or hubbed at the same wire center.

a) Voice Grade Bridges

	Monthly Rate	Nonrecurring Charge Per Channel
(1) Voice Bridging, per port		
(a) Two-Wire (Type 2230)	\$6.00	\$34.00
(b) Four-Wire (Type 2435)	6.00	34.00
(2) Analog Data Bridging		
(a) Four-Wire (Type 2463 and 2464)	20.00	37.00
(3) Dataphone Select-A-Station Bridging - Primary Data Station Selector (United Telephone)		
(a) Sequential Arrangement Common Equipment	\$114.50	\$240.00
(b) Addressable Arrangement Common Equipment	161.60	270.00

GENERAL EXCHANGE TARIFF

Embarq Florida, Inc.

By: F. B. Poag  
Director

SECTION A20  
Second Revised Sheet 82  
Cancelling First Revised Sheet 82  
Effective: July 17, 1997

PRIVATE LINE SERVICES

A. PRIVATE LINE SERVICES (Cont'd)

11. Rates and Charges (Cont'd)

c. Optional Features and Functions (Cont'd)

1) Bridging (Cont'd)

a) Voice Grade Bridges (Cont'd)

(3) Dataphone Select-A-Station Bridging - Primary Data Station Selector  
(United Telephone) (Cont'd)

(c) Channel Connections	<u>Monthly Rate</u>	<u>Nonrecurring Charge Per Channel</u>
(i) Per Two-Wire Connection	\$2.20	\$33.00
(ii) Per Four-Wire Connection	10.10	37.00

(4) Dataphone Select-A-Station Bridging - Secondary Data Station Selector  
(United Telephone)

(a) Sequential Arrangement Common Equipment	<u>Monthly Rate</u>	<u>Nonrecurring Charge Per Channel</u>
	\$114.50	\$ 240.00
(b) Addressable Arrangement Common Equipment	161.60	270.00
(c) Channel Connections		
(i) Per Two-Wire Connection	2.20	33.00
(ii) Per Four-Wire Connection	10.10	37.00

GENERAL EXCHANGE TARIFF

Embarq Florida, Inc.

By: F. B. Poag  
Director

SECTION A20  
Third Revised Sheet 83  
Cancelling Second Revised Sheet 83  
Effective: July 17, 1997

PRIVATE LINE SERVICES

A. PRIVATE LINE SERVICES (Cont'd)

11. Rates and Charges (Cont'd)

c. Optional Features and Functions (Cont'd)

1) Bridging (Cont'd)

a) Voice Grade Bridges (Cont'd)

(5) Telemetry and Alarm Bridging - Split Band,  
Active Bridging (United Telephone)

(a) Common Equipment, per Central Office

	<u>Monthly Rate</u>	<u>Nonrecurring Charge</u>
(i) First bridging shelf, capacity of 48 two-wire connections	\$69.65	\$375.00
(ii) Additional bridging shelf, capacity of 56 two-wire connections installed subsequent to the first bridging shelf	67.65	340.00

GENERAL EXCHANGE TARIFF

Embarq Florida, Inc.

By: F. B. Poag  
Director

SECTION A20  
Fourth Revised Sheet 84  
Cancelling Third Revised Sheet 84  
Effective: April 13, 2003

PRIVATE LINE SERVICES

A. PRIVATE LINE SERVICES (Cont'd)

11. Rates and Charges (Cont'd)

c. Optional Features and Functions (Cont'd)

1) Bridging (Cont'd)

a) Voice Grade Bridges (Cont'd)

(5) Telemetry and Alarm Bridging - Split Band,  
Active Bridging (United Telephone) (Cont'd)

(a) Common Equipment, per Central Office (Cont'd)

	<u>Monthly Rate</u>	<u>Nonrecurring Charge</u>
(iii) Additional bridging shelf, capacity of 56 two-wire connections installed at the same time as the first bridging shelf	\$23.25	\$210.00
(b) Channel connections, per channel connected		
(i) Remote station channel connection	\$4.00	\$ 33.00
(ii) Mid-link channel connection, first channel	5.60	46.00
(iii) Mid-link channel connection, subsequent channels	4.85	46.00

GENERAL EXCHANGE TARIFF

Embarq Florida, Inc.

By: F. B. Poag  
Director

SECTION A20  
Second Revised Sheet 85  
Cancelling First Revised Sheet 85  
Effective: July 17, 1997

PRIVATE LINE SERVICES

RESERVED FOR FUTURE USE



GENERAL EXCHANGE TARIFF

Embarq Florida, Inc.

By: F. B. Poag  
Director

SECTION A20  
Fifth Revised Sheet 86  
Cancelling Fourth Revised Sheet 86  
Effective: January 6, 2003

PRIVATE LINE SERVICES

RESERVED FOR FUTURE USE

GENERAL EXCHANGE TARIFF

Embarq Florida, Inc.

By: F. B. Poag  
Director

SECTION A20  
Third Revised Sheet 87  
Cancelling Second Revised Sheet 87  
Effective: April 10, 2001

PRIVATE LINE SERVICES

RESERVED FOR FUTURE USE

GENERAL EXCHANGE TARIFF

Embarq Florida, Inc.

By: F. B. Poag  
Director

SECTION A20  
Fifth Revised Sheet 88  
Cancelling Fourth Revised Sheet 88  
Effective: May 5, 2005

PRIVATE LINE SERVICES

A. PRIVATE LINE SERVICES (Cont'd)

11. Rates and Charges (Cont'd)

c. Optional Features and Functions (Cont'd)

2) Signaling Arrangements

Signaling arrangements are provided at the customer's option to arrange channels for suitable signaling. Signaling is required on all off-premises extension channels and tie lined channels associated with PBD (or similar) systems.

UNITED TELEPHONE

		<u>Monthly</u>	<u>Nonrecurring Charge</u>	
			<u>Initial</u>	<u>Subsequent</u>
a)	Per Local Channel			
(1)	Ringdown - Manual (Type 2230/2435 service)	\$18.95	\$40.00	\$185.00
(2)	Ringdown - Automatic (Type 2230/2435 service)	13.00	40.00	173.00
(3)	E & M Type (Type 2432/2434)	13.00	25.00	103.00
(4)	Type A (0-199 ohms) (Type 2231 service)	13.00	44.00	140.00
(5)	Type B (200-899 ohms) (Type 2231 service)	13.00	43.00	140.00

GENERAL EXCHANGE TARIFF

Embarq Florida, Inc.

By: F. B. Poag  
Director

SECTION A20  
Sixth Revised Sheet 89  
Cancelling Fifth Revised Sheet 89  
Effective: May 5, 2005

PRIVATE LINE SERVICES

A. PRIVATE LINE SERVICES (Cont'd)

11. Rates and Charges Cont'd)

c. Optional Features and Functions (Cont'd)

2) Signaling Arrangements (Cont'd)

CENTRAL TELEPHONE

		<u>Monthly</u>	<u>Nonrecurring Charge</u>	
			<u>Initial</u>	<u>Subsequent</u>
b)	Per Local Channel			
(1)	Ringdown - Manual (Type 2230/2435 service)	\$18.95	\$40.00	\$185.00
(2)	Ringdown - Automatic (Type 2230/2435 service)	13.00	40.00	173.00
(3)	E & M Type (Type 2432/2434)	9.50	25.00	103.00
(4)	Type A (0-199 ohms) (Type 2231 service)	8.00	44.00	140.00
(5)	Type B (200-899 ohms) (Type 2231 service)	8.00	43.00	140.00
(6)	Type C (900 or more ohms) (Type 2231 service)	6.95	11.00	140.00

GENERAL EXCHANGE TARIFF

Embarq Florida, Inc.

By: F. B. Poag  
Director

SECTION A20  
First Revised Sheet 90  
Cancelling Original Sheet 90  
Effective: January 1, 1997

PRIVATE LINE SERVICES

A. PRIVATE LINE SERVICES (Cont'd)

11. Rates and Charges (Cont'd)

c. Optional Features and Functions (Cont'd)

3) Conditioning (Voice Grade Services)

Conditioning provides more specific transmission characteristics for data services. There are two types of C-conditioning and one type of D-conditioning, each with different technical specifications. C-Type conditioning controls attenuation distortion and envelope delay distortion. D-Type conditioning controls the signal to C-notched noise ration and intermodulation distortion.

Conditioning is charged for on a per Local Channel basis for two-point and multipoint service. For two-point services the parameters apply to each service. For multipoint services the parameters apply to any path between any two service points.

GENERAL EXCHANGE TARIFF

Embarq Florida, Inc.

By: F. B. Poag  
Director

SECTION A20  
First Revised Sheet 91  
Cancelling Original Sheet 91  
Effective: January 1, 1997

PRIVATE LINE SERVICES

A. PRIVATE LINE SERVICES (Cont'd)

11. Rates and Charges (Cont'd)

c. Optional Features and Functions (Cont'd)

3) Conditioning (Voice Grade Services)

a) The types and descriptions of the available conditioning options are as follows:

<u>Type Conditioning</u>	<u>Frequency Response Specifications</u>	<u>Envelope Delay Distortion Specifications</u>	
C - 1 (two-point or multipoint)	300-2700 Hz, -2 dB to +6 dB 1000-2400 Hz, -1 to +3 dB 300-3000 Hz, 1-dB to +12 dB	1000-2400 Hz, less than 1000 microseconds	
C - 2 (two-point or multipoint)	300-3000Hz, -2 dB to +6 dB 500-2800 Hz, -1 dB to +3 dB)	1000-2600 Hz, less than 500 microseconds 600-2600 Hz, less than 1500 microseconds 500-2800 Hz, less than 3000 microseconds	
		<u>Non-Linear Distortion</u>	
	<u>C-notched Noise</u>	<u>2nd Order Distortion</u>	<u>3rd Order Distortion</u>
D- 1 (two-point)	Noise level 28 dB below signal level	35 dB below signal level	40 dB below signal level

GENERAL EXCHANGE TARIFF

Embarq Florida, Inc.

By: F. B. Poag  
Director

SECTION A20  
Fifth Revised Sheet 92  
Cancelling Fourth Revised Sheet 92  
Effective: May 5, 2005

PRIVATE LINE SERVICES

A. PRIVATE LINE SERVICES (Cont'd)

11. Rates and Charges (Cont'd)

c. Optional Features and Functions (Cont'd)

3) Conditioning (Voice Grade Services) (Cont'd)

b) When a channel is equipped with Type D1 conditioning and is utilized for voice communications, the Company does not undertake to represent that the channel will be suitable for such voice transmission.

c) C-Type Conditioning is available for Types 2463 and 2464.

(1) C-Types of Conditioning, per local channel

	<u>Monthly Rate</u>	<u>Nonrecurring Charge</u>
(a) C1 Type	\$ 5.00	\$ 16.00
(b) C2 Type	5.00	16.00

d) D-Type Conditioning is available for Types 2463 and 2464.

(1) D-Type Conditioning, per local channel

	<u>Monthly Rate</u>	<u>Nonrecurring Charge</u>
(a) D1 Type	\$ 4.00	\$ 18.00

GENERAL EXCHANGE TARIFF

Embarq Florida, Inc.

By: F. B. Poag  
Director

SECTION A20  
Fourth Revised Sheet 93  
Cancelling Third Revised Sheet 93  
Effective: May 5, 2004

PRIVATE LINE SERVICES

RESERVED FOR FUTURE USE



GENERAL EXCHANGE TARIFF

Embarq Florida, Inc.

By: F. B. Poag  
Director

SECTION A20  
Second Revised Sheet 94  
Cancelling First Revised Sheet 94  
Effective: January 6, 2003

PRIVATE LINE SERVICES

RESERVED FOR FUTURE USE

GENERAL EXCHANGE TARIFF

Embarq Florida, Inc.

By: F. B. Poag  
Director

SECTION A20  
Fourth Revised Sheet 95  
Cancelling Third Revised Sheet 95  
Effective: January 6, 2003

PRIVATE LINE SERVICES

RESERVED FOR FUTURE USE

GENERAL EXCHANGE TARIFF

Embarq Florida, Inc.

By: F. B. Poag  
Director

SECTION A20  
Third Revised Sheet 96  
Cancelling Second Revised Sheet 96  
Effective: April 10, 2001

PRIVATE LINE SERVICES

RESERVED FOR FUTURE USE

GENERAL EXCHANGE TARIFF

Embarq Florida, Inc.

By: F. B. Poag  
Director

SECTION A20  
Second Revised Sheet 97  
Cancelling First Revised Sheet 97  
Effective: January 6, 2003

PRIVATE LINE SERVICES

RESERVED FOR FUTURE USE

GENERAL EXCHANGE TARIFF

Embarq Florida, Inc.

By: F. B. Poag  
Director

SECTION A20  
Second Revised Sheet 98  
Cancelling First Revised Sheet 98  
Effective: April 10, 2001

PRIVATE LINE SERVICES

B. DIGITAL ACCESS CROSS CONNECT SERVICE

CENTRAL TELEPHONE ONLY

1. General

- a. Digital Access Cross Connect Service (DACCS) provides for the management and reconfiguration of digital networks. It allows a single digit (DS0) circuit or multiples of up to 24 DS0 circuits.
- b. The basic unit of service is a single 64 kbps (DS0) channel. Services are also provided for DS1 (1.544 Mbps) and DS3 (45 Mbps) digital circuits or synchronous subrate digital circuits (19.2 kbps).
- c. This service is provided only from serving wire centers equipped with a Digital Cross Connect Device (DCD) and is subject to the availability of facilities.
- d. Service must be ordered for a minimum of three months.
- e. Suspension of service is not allowed.

2. Definitions

- a. Digital Cross Connect Device (DCD) - The DCD provides DS0 cross connection. It can connect multiples of up to 24 DS0 circuits.
- b. "DS0" refers to a North American hierarchy of digital signal levels. It means Digital Signal Level 0 which is a 64 kbps signal. Customer bit rates are limited to a 56 kbps signal.
- c. "DS1" refers to a North American hierarchy of digital signal levels. It means Digital Signal Level 1 which is a 1.544 Mbps signal.

GENERAL EXCHANGE TARIFF

Embarq Florida, Inc.

By: F. B. Poag  
Director

SECTION A20  
First Revised Sheet 99  
Cancelling Original Sheet 99  
Effective: January 1, 1997

PRIVATE LINE SERVICES

B. DIGITAL ACCESS CROSS CONNECT SERVICE (Cont'd)

CENTRAL TELEPHONE ONLY

2. Definitions (Cont'd)

- d. "DS3" refers to North American hierarchy of digital signal levels. It means Digital Signal Level 3 which is a 45 Mbps signal.
- e. An Access Line is the circuit between the customer's premises and his serving wire center plus interoffice facilities to the DCD if the DCD is not in the customer's serving wire center.
- f. A Multipoint Channel is any connection which terminates three or more channels on the same bridging port.

3. Connections

- a. This tariff applies to connection between channels at the DS0 level only or 24 consecutive DS0 channels.
- b. DS0, DS1 and DS3 signals as defined in the Company's technical references may be terminated on this service. Other multiplexing formats must be converted at standard D4 format.
- c. A Trouble Location Charge as defined in Section A4 of this tariff will apply if a reported trouble is found to be in the customer's premises equipment.

GENERAL EXCHANGE TARIFF

Embarq Florida, Inc.

By: F. B. Poag  
Director

SECTION A20  
Second Revised Sheet 100  
Cancelling First Revised Sheet 100  
Effective: April 10, 2001

PRIVATE LINE SERVICES

B. DIGITAL ACCESS CROSS CONNECT SERVICE (Cont'd)

4. Rates and Charges

	<u>Monthly Rate</u>	<u>Nonrecurring Charge</u>
a. Service Establishment charge		\$1,700.00
b. DCD Port Charge, per access line		
1) Digital Circuit - DS0	\$ 6.21	
2) Digital Circuit - DS1	\$ 63.34	
3) Digital Circuit - DS3	\$ 750.00	
c. DCD Port Charge, per inter DCD channel		
1) Digital Circuit - DS0	\$ 12.42	
2) Digital Circuit - DS1	\$ 126.84	
3) Digital Circuit - DS3	\$1,500.00	
d. Transactions performed by the Company at the customer's request.		
1) Per customer request		\$ 12.16
2) Per transaction performed within a request		\$ 7.00
e. Multi Junction Unit	\$ 2.50	

GENERAL EXCHANGE TARIFF

Embarq Florida, Inc.

By: F. B. Poag  
Director

SECTION A20  
Second Revised Sheet 101  
Cancelling First Revised Sheet 101  
Effective: April 13, 2003

PRIVATE LINE SERVICES

C. D-4 CHANNEL SERVICE

CENTRAL TELEPHONE

1. General

- a. This tariff is to provide Point-to-Point D-4 channel service.
- b. The service will support DDS-2 service. The service is not speed specific.
- c. The channel unit can be used on an analog or digital circuit and is located at the customer's premises.
- d. The rates shown are in addition to the normal 1.544 Mbps rates shown in Sections A20.A.11.a.5) and A20.A.11.b.4).

2. Rates and Charges

a. D-4 Channel Equipment	<u>Monthly Rate</u>	<u>Nonrecurring Charge</u>
1) D-4 Multiplexer		
a) 24 channel	\$ 88.70	\$ 1,200.00
b) 48 channel	176.40	1,200.00
c) 96 channel	257.10	1,200.00
2) Channel Unit, per equipped channel	28.15	30.00



GENERAL EXCHANGE TARIFF

Embarq Florida, Inc.

By: F. B. Poag  
Director

SECTION A20  
First Revised Sheet 102  
Cancelling Original Sheet 102  
Effective: January 1, 1997

PRIVATE LINE SERVICES

C. D-4 CHANNEL SERVICE (Cont'd)

CENTRAL TELEPHONE

2. Rates and Charges (Cont'd)

	<u>Monthly Rate</u>	<u>Nonrecurring Charge</u>
b. D-4 Channel Equipment - Optional		
1) SU-X Control Maintenance Unit (1 per 48 channels)	\$ 39.90	\$ 30.00
2) DSU-HR Data Port for Fractional T1 Service	21.85	30.00
3) DSU-DP-2 Data Port with Secondary Channel Sync and Async Speeds	22.05	30.00
4) USA-DS0/T0SU Universal Switched Access Data/Voice Card	104.40	30.00

GENERAL EXCHANGE TARIFF

Embarq Florida, Inc.

By: F. B. Poag  
Director

SECTION A20  
Fourth Revised Sheet 103  
Cancelling Third Revised Sheet 103  
Effective: June 12, 2002

PRIVATE LINE SERVICES

RESERVED FOR FUTURE USE

GENERAL EXCHANGE TARIFF

Embarq Florida, Inc.

By: F. B. Poag  
Director

SECTION A20  
Fourth Revised Sheet 104  
Cancelling Third Revised Sheet 104  
Effective: June 12, 2002

PRIVATE LINE SERVICES

RESERVED FOR FUTURE USE

GENERAL EXCHANGE TARIFF

Embarq Florida, Inc.

By: F. B. Poag  
Director

SECTION A20  
Fourth Revised Sheet 105  
Cancelling Third Revised Sheet 105  
Effective: June 12, 2002

PRIVATE LINE SERVICES

RESERVED FOR FUTURE USE

GENERAL EXCHANGE TARIFF

Embarq Florida, Inc.

By: F. B. Poag  
Director

SECTION A20  
Second Revised Sheet 106  
Cancelling First Revised Sheet 106  
Effective: June 12, 2002

PRIVATE LINE SERVICES

RESERVED FOR FUTURE USE

GENERAL EXCHANGE TARIFF

Embarq Florida, Inc.

By: F. B. Poag  
Director

SECTION A20  
Second Revised Sheet 107  
Cancelling First Revised Sheet 107  
Effective: June 12, 2002

PRIVATE LINE SERVICES

RESERVED FOR FUTURE USE

GENERAL EXCHANGE TARIFF

Embarq Florida, Inc.

By: F. B. Poag  
Director

SECTION A20  
Second Revised Sheet 108  
Cancelling First Revised Sheet 108  
Effective: June 12, 2002

PRIVATE LINE SERVICES

RESERVED FOR FUTURE USE

GENERAL EXCHANGE TARIFF

Embarq Florida, Inc.

By: F. B. Poag  
Director

SECTION A20  
Second Revised Sheet 109  
Cancelling First Revised Sheet 109  
Effective: June 12, 2002

PRIVATE LINE SERVICES

RESERVED FOR FUTURE USE



GENERAL EXCHANGE TARIFF

Embarq Florida, Inc.

By: F. B. Poag  
Director

SECTION A20  
Second Revised Sheet 110  
Cancelling First Revised Sheet 110  
Effective: June 12, 2002

PRIVATE LINE SERVICES

RESERVED FOR FUTURE USE

GENERAL EXCHANGE TARIFF

Embarq Florida, Inc.

By: F. B. Poag  
Director

SECTION A20  
Third Revised Sheet 111  
Cancelling Second Revised Sheet 111  
Effective: June 12, 2002

PRIVATE LINE SERVICES

RESERVED FOR FUTURE USE

GENERAL EXCHANGE TARIFF

Embarq Florida, Inc.

By: F. B. Poag  
Director

SECTION A20  
Second Revised Sheet 112  
Cancelling First Revised Sheet 112  
Effective: June 12, 2002

PRIVATE LINE SERVICES

RESERVED FOR FUTURE USE

GENERAL EXCHANGE TARIFF

Embarq Florida, Inc.

By: F. B. Poag  
Director

SECTION A20  
Fourth Revised Sheet 113  
Cancelling Third Revised Sheet 113  
Effective: June 12, 2002

PRIVATE LINE SERVICES

RESERVED FOR FUTURE USE

GENERAL EXCHANGE TARIFF

Embarq Florida, Inc.

By: F. B. Poag  
Director

SECTION A20  
First Revised Sheet 114  
Cancelling Original Sheet 114  
Effective: November 30, 1999

PRIVATE LINE SERVICES

E. EXPEDITED ORDER CHARGE

1. General

- a. If a customer desires that service be provided on an earlier date than that which has been established for the service order, the customer may request that service be provided on an expedited basis. If the Company agrees to provide the service on an expedited basis, an Expedited Order Charge will apply.
- b. If the Company is subsequently unable to meet an agreed upon expedited service date, no Expedited Order Charge will apply unless the missed service date was caused by the customer.
- c. The Expedited Order Charge is based on the extent to which the service order has been processed at the time the Company agrees to the service date improvement and is calculated as follows:
- d. Based on the critical dates associated with the service order, the Company will determine which critical date will be next completed on the order. The critical dates tracked by the Company are as follows:
  - 1) Application Date (APP): The date the customer provides to the Company, (1) a firm commitment of service and (2) sufficient information to enable the Company to begin service provisioning. This is also the order date.
  - 2) Scheduled Issue Date (SID): The date that the order is to enter the Company's order distribution system.
  - 3) Loop Assignment and Make-up Date (LCAM): The date by which Local Loop Assignment and Make-up information must be available.
  - 4) Records Issue Date (RID): The date that all design and assignment information is to be sent to the central office and installation forces.

GENERAL EXCHANGE TARIFF

Embarq Florida, Inc.

By: F. B. Poag  
Director

SECTION A20  
First Revised Sheet 115  
Cancelling Original Sheet 115  
Effective: November 30, 1999

PRIVATE LINE SERVICES

E. EXPEDITED ORDER CHARGE (Cont'd)

1. General (Cont'd)

d. (Cont'd)

- 5) Material Issue Date (MID): The date material is shipped by the warehouse to field personnel for provisioning of service.
  - 6) Designed, Verified, and Assigned Date (DVA): The date by which field implementation groups must report that all documents and materials have been received.
  - 7) Wired and Office Tested Date (WOT): The date by which all intraoffice wiring is to be completed, all plug-ins optioned, aligned, and frame continuity established, and the interoffice facilities, if applicable, tested. In addition, switching equipment, including translation loading, is to be installed and tested.
  - 8) Plant Test Date (PTD): The date on which overall testing of the service is to be started.
  - 9) Due Date (DD): The date on which service is to be made available to the customer.
- e. Using the table in D.2. following and the critical date, as determined preceding, the Company will determine the percent of the provisioning interval not yet completed.
- f. The Company will apply this percentage to the sum of all the nonrecurring charges associated with the order and divide this sum by the number of days remaining in the original service interval.
- g. The per day charges so developed will then be applied on a per day of improvement basis, per order, but in no event shall the charge exceed fifty percent of the total nonrecurring charges associated with the service order.

GENERAL EXCHANGE TARIFF

Embarq Florida, Inc.

By: F. B. Poag  
Director

SECTION A20  
First Revised Sheet 116  
Cancelling Original Sheet 116  
Effective: November 30, 1999

PRIVATE LINE SERVICES

E. EXPEDITED ORDER CHARGE (Cont'd)

2. Expedited Order Charge Billing Percentages

TYPE SERVICE/CRITICAL DATES	After:	SID	LCAM	RID	MID	DVA	WOT	PTD	DD
	Before:	LCAM	RID	MID	DVA	WOT	PTD	DD	
VOICE GRADE		93.0	88.0	84.0	80.0	71.0	48.0	16.0	0.0
TRANSLINK SERVICE		75.0	69.0	65.0	60.0	48.0	33.0	14.0	0.0

- a. When the request for expediting occurs subsequent to the issuance of the service order, a Service Date Change Charge as set forth in A.8.d.1)d) preceding also applies.
- b. The Expedited Order Charge applicable to non-design circuits will be equal to fifty percent of the total nonrecurring charges associated with the service order.

GENERAL EXCHANGE TARIFF

Embarq Florida, Inc.

By: F. B. Poag  
Director

SECTION A20  
Second Revised Sheet 117  
Cancelling First Revised Sheet 117  
Effective: January 6, 2003

PRIVATE LINE SERVICES

RESERVED FOR FUTURE USE



GENERAL EXCHANGE TARIFF

Embarq Florida, Inc.

By: F. B. Poag  
Director

SECTION A20  
Second Revised Sheet 118  
Cancelling First Revised Sheet 118  
Effective: January 6, 2003

PRIVATE LINE SERVICES

RESERVED FOR FUTURE USE

GENERAL EXCHANGE TARIFF

Embarq Florida, Inc.

By: F. B. Poag  
Director

SECTION A20  
Second Revised Sheet 119  
Cancelling First Revised Sheet 119  
Effective: January 6, 2003

PRIVATE LINE SERVICES

RESERVED FOR FUTURE USE

GENERAL EXCHANGE TARIFF

Embarq Florida, Inc.

By: F. B. Poag  
Director

SECTION A20  
Second Revised Sheet 120  
Cancelling First Revised Sheet 120  
Effective: January 6, 2003

PRIVATE LINE SERVICES

RESERVED FOR FUTURE USE

GENERAL EXCHANGE TARIFF

Embarq Florida, Inc.

By: F. B. Poag  
Director

SECTION A20  
Second Revised Sheet 121  
Cancelling First Revised Sheet 121  
Effective: January 6, 2003

PRIVATE LINE SERVICES

RESERVED FOR FUTURE USE

GENERAL EXCHANGE TARIFF

Embarq Florida, Inc.

By: F. B. Poag  
Director

SECTION A20  
Third Revised Sheet 122  
Cancelling Second Revised Sheet 122  
Effective: January 6, 2003

PRIVATE LINE SERVICES

RESERVED FOR FUTURE USE

GENERAL EXCHANGE TARIFF

Embarq Florida, Inc.

By: F. B. Poag  
Director

SECTION A20  
Second Revised Sheet 123  
Cancelling First Revised Sheet 123  
Effective: January 6, 2003

PRIVATE LINE SERVICES

RESERVED FOR FUTURE USE

GENERAL EXCHANGE TARIFF

Embarq Florida, Inc.

By: F. B. Poag  
Director

SECTION A20  
Third Revised Sheet 124  
Cancelling Second Revised Sheet 124  
Effective: January 6, 2003

PRIVATE LINE SERVICES

RESERVED FOR FUTURE USE

GENERAL EXCHANGE TARIFF

Embarq Florida, Inc.

By: F. B. Poag  
Director

SECTION A20  
Second Revised Sheet 125  
Cancelling First Revised Sheet 125  
Effective: January 6, 2003

PRIVATE LINE SERVICES

RESERVED FOR FUTURE USE



GENERAL EXCHANGE TARIFF

Embarq Florida, Inc.

By: F. B. Poag  
Director

SECTION A20  
Second Revised Sheet 126  
Cancelling First Revised Sheet 126  
Effective: January 6, 2003

PRIVATE LINE SERVICES

RESERVED FOR FUTURE USE

GENERAL EXCHANGE TARIFF

Embarq Florida, Inc.

By: F. B. Poag  
Director

SECTION A20  
Second Revised Sheet 127  
Cancelling First Revised Sheet 127  
Effective: January 6, 2003

PRIVATE LINE SERVICES

RESERVED FOR FUTURE USE

GENERAL EXCHANGE TARIFF

Embarq Florida, Inc.

By: F. B. Poag  
Director

SECTION A20  
Third Revised Sheet 128  
Cancelling Second Revised Sheet 128  
Effective: January 6, 2003

PRIVATE LINE SERVICES

RESERVED FOR FUTURE USE

GENERAL EXCHANGE TARIFF

Embarq Florida, Inc.

By: F. B. Poag  
Director

SECTION A20  
Second Revised Sheet 129  
Cancelling First Revised Sheet 129  
Effective: January 6, 2003

PRIVATE LINE SERVICES

RESERVED FOR FUTURE USE

## GENERAL EXCHANGE TARIFF

Embarq Florida, Inc.

By: F. B. Poag  
Director

SECTION A20  
First Revised Sheet 130  
Cancelling Original Sheet 130  
Effective: September 28, 2002

### PRIVATE LINE SERVICES

#### G. OPTIPOINT SERVICE

##### 1. REGULATIONS

###### a. Description of Service

OptiPoint Service consists of a basic channel to which a technical specifications package (customized or predefined), channel interface(s) and, when desired, optional features and functions are added to construct the service desired by the customer. Each of the components of the service is described in this section.

Customized technical specifications packages will be provided where technically feasible. If the Company determines that the requested parameter specifications are not compatible, the customer will be advised and given the opportunity to change the order.

When a customized channel is ordered the customer will be notified whether Additional Labor Charges apply. In such cases, the customer will be given an estimate of the hours to be billed before any further action is taken on the order.

OptiPoint Service provides point-to-point high speed synchronous optical fiber-based full duplex data transmission capabilities for intraLATA intraexchange and interexchange communications. There are two levels of OptiPoint Service: OptiPoint-3 (OC3) is provided at a terminating bit rate of 155.52 Mbps; and OptiPoint-12 (OC12) is provided at a terminating bit rate of 622.08 Mbps.

OptiPoint Service is provided for periods of one, three, or five years. When a customer orders OptiPoint Service, the customer and the Company will work cooperatively to plan, engineer, provision and manage OptiPoint Service.

The required format and interface specifications are contained in Technical Reference Publication GR-253.

###### 1) Channel Termination

OptiPoint Service Channel Terminations may be used to connect the following:

- a customer designated premises to another customer designated premises, configured at wire center locations between the two premises; or
- a customer designated premises to a Company location where service configuration is performed.

a) Based on customer requirements, OC3 service may be provisioned in the following configurations:

- (1) OC3 - three Synchronous Transport Signals (STS1) channels which each contain the following:
  - one DS3 that is STS1 mapped;
  - up to 28 DS1s that are VT mapped;
  - an STS1 channel without constraint to payload mapping when the STS1 channel does not terminate via a service configuration function to DS1 or DS3 services within the network; or

GENERAL EXCHANGE TARIFF

Embarq Florida, Inc.

By: F. B. Poag  
Director

SECTION A20  
First Revised Sheet 131  
Cancelling Original Sheet 131  
Effective: September 28, 2002

PRIVATE LINE SERVICES

G. OPTIPOINT SERVICE (Cont'd)

1. REGULATIONS (Cont'd)

a. Description of Service (Cont'd)

1) Channel Termination (Cont'd)

a) (Cont'd)

(2) A single concatenated OC3c channel that is STS3c mapped.

b) Based on customer requirements, OC12 service may be provisioned in the following configurations:

(1) OC12 - twelve STS1 channels which each contain:

- one DS3 that is STS1 mapped;
- up to 28 DS1s that are VT mapped;
- an STS1 channel without constraint to payload mapping when the STS1 channel does not terminate via a service configuration function to DS1 or DS3 services within the network;

(2) Up to four concatenated OC3c channels that are STS3c mapped;

(3) From one to three OC3c channels that are STS3c mapped and mixed with from three to nine STS1 channels subject to utilization of the total OC12 capacity; or

(4) A single concatenated OC12c channel that is STS12c mapped.

GENERAL EXCHANGE TARIFF

Embarq Florida, Inc.

By: F. B. Poag  
Director

SECTION A20  
First Revised Sheet 132  
Cancelling Original Sheet 132  
Effective: September 28, 2002

PRIVATE LINE SERVICES

G. OPTIPOINT SERVICE (Cont'd)

1. REGULATIONS (Cont'd)

a. Description of Service (Cont'd)

1) Channel Termination (Cont'd)

Current SONET standards do not provide for asynchronous DS3 to DS1 multiplexing. An STS1 channel may be mapped for either one DS3 or 28 DS1s. However, DS1s within a DS3 are not accessible within the SONET architecture, and their performance cannot be guaranteed for this reason. When the customer requests that an OC3 or OC12 service be configured with a combination of DS3 and DS1 channels, a DS3 to DS1 multiplexing arrangement, will be required as set forth in Section A20.F.9.c.1) of this tariff.

Upon ordering OptiPoint Service, the customer is responsible for identifying the STS signal configuration to be contained in each OC3 or OC12 service connection and each STS1, STS3, and/or STS12 payload content. This information is used in determining the route and connection in the network. If a new configuration is requested subsequent to the initial activation, a service reconfiguration charge will apply on a per service basis, as set forth in A20.G.8.b. following. The service reconfiguration charge is in addition to all applicable configuration card charges associated with the new configuration.

OptiPoint Service is provided with electronics that automatically activate in case of failure of the primary electronics. Since OptiPoint is a point-to-point service, SONET ring survivability will not be available. Rates for additional protection options requested by the customer will be quoted on an individual case basis and are in addition to the rates for OC3 and OC12 service.

OptiPoint Channel Terminations provided to a customer's designated premises will be installed in a single, common space under Company control. An OptiPoint entrance facility may not be split between premises or terminated in multiple locations within a premises. The customer must provide suitable floor space, environmental controls and non-switched AC power to support the OptiPoint entrance facility at the customer's premises location.

GENERAL EXCHANGE TARIFF

Embarq Florida, Inc.

By: F. B. Poag  
Director

SECTION A20  
First Revised Sheet 133  
Cancelling Original Sheet 133  
Effective: September 28, 2002

PRIVATE LINE SERVICES

G. OPTIPOINT SERVICE (Cont'd)

1. REGULATIONS (Cont'd)

a. Description of Service (Cont'd)

1) Channel Termination (Cont'd)

OptiPoint Channel Terminations will be provided with or without Company provided terminal equipment at the customer's premises. When a customer elects to furnish its own terminal equipment at the customer's premises, the customer will work cooperatively with the Company to provide a compatible physical interface, and will identify approved equipment types for use in conjunction with Company provided equipment. The customer is responsible for providing all facilities and cabling necessary to connect customer provided equipment to this interface.

OptiPoint Channel Terminations are available only where facilities and operating conditions permit. The Company will work cooperatively with the customer to determine if suitable existing Company SONET based facilities are available to provide the service. The Company will not provision this service on facilities which are not suitable for OptiPoint. Where facilities and/or operating conditions do not permit the provision of OptiPoint Service, and the customer desires the Company to provision OptiPoint Service, Charges Applicable Under Special Conditions, as set forth in Section A5 of this tariff, may apply.

Channel mileage can be connected between serving wire centers at a lower OC-n speed than the Channel Termination, if the channel mileage is between a lower speed configuration function and one of the following:

- another lower speed configuration function;
- another lower speed Channel Termination; or

All of the above terminations must be provided at the same speed as the transport.



GENERAL EXCHANGE TARIFF

Embarq Florida, Inc.

By: F. B. Poag  
Director

SECTION A20  
First Revised Sheet 134  
Cancelling Original Sheet 134  
Effective: September 28, 2002

PRIVATE LINE SERVICES

G. OPTIPOINT SERVICE (Cont'd)

1. REGULATIONS (Cont'd)

a. Description of Service (Cont'd)

2) Service Configuration

- a) Configuration Card - provides for the interface at which a channelized or lower speed service terminates or originates from an OptiPoint optical line terminated at a customer designated premises or a Company central office. DS1, DS3, and OC3 concatenated cards are available for interfacing OptiPoint-3 service with lower level signals. DS1, DS3, OC3, OC3 concatenated, and OC12 concatenated cards are available for interfacing with OptiPoint-12 service.

Whenever a customer requests their OptiPoint Service to be configured for lower level service, card rate elements will apply. Configuration Cards will be required based upon the characteristics of the OptiPoint Service. Monthly rates for the Configuration Cards are set forth in A20.G.7.c. following.

Due to the technical limitations of SONET facilities, additional regeneration equipment may be required for essential detection and retransmission of SONET signals between the customer's premises and the Company serving wire center for that premises. Additional regeneration equipment will only be provided by the Company when the actual fiber facility distance between the customer's premises and serving wire center exceeds SONET design limits. A monthly recurring OptiPoint Regeneration Charge, as set forth in A20.G.7.d. following, will apply for each regenerator required for the provision of OptiPoint Service.

GENERAL EXCHANGE TARIFF

Embarq Florida, Inc.

By: F. B. Poag  
Director

SECTION A20  
First Revised Sheet 135  
Cancelling Original Sheet 135  
Effective: September 28, 2002

PRIVATE LINE SERVICES

G. OPTIPOINT SERVICE (Cont'd)

1. REGULATIONS (Cont'd)

a. Description of Service (Cont'd)

- 3) Multipoint service is not available with OptiPoint Service.
- 4) A Channel Service Unit (CSU) or appropriate termination equipment provided by the customer is required at a customer's or authorized user's premises to perform such functions as:
  - proper termination of the service
  - amplification
  - signal shaping
  - remote loop-back
- 5) The design, maintenance and operation of OptiPoint Service contemplates communications originating and terminating as (1) a customer premises to customer premises channel via the Company's Serving Wire Center and/or through remote Serving Wire Centers; (2) a customer premises to the Serving Wire Center and/or remote Serving Wire Centers - partial channel (link); or (3) a central office to central office (interoffice) partial channel (link).
- 6) Unless specified following, the regulations for OptiPoint Service specified herein apply in addition to the regulations set forth in other sections of this tariff.
- 7) Suspension of Business and Residence Service (Vacation Service) at the customer's request, as defined in Section A2 of this tariff, is not allowed.

GENERAL EXCHANGE TARIFF

Embarq Florida, Inc.

By: F. B. Poag  
Director

SECTION A20  
First Revised Sheet 136  
Cancelling Original Sheet 136  
Effective: September 28, 2002

PRIVATE LINE SERVICES

G. OPTIPOINT SERVICE (Cont'd)

1. REGULATIONS (Cont'd)

a. Description of Service (Cont'd)

8) Service Diagram

The following diagrams depict generic views of the components of OptiPoint Service.

a) OptiPoint Service with Company Provided Terminal Equipment at the Customer Premises

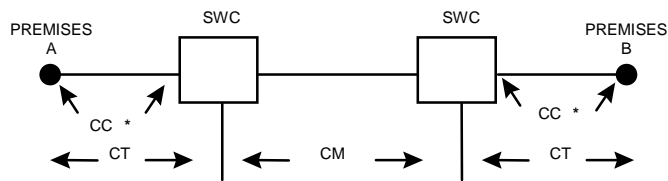

CT - Channel Termination  
CM - Channel Mileage  
SWC - Serving Wire Center  
CC - Configuration Cards

\* WHERE APPLICABLE

b) OptiPoint Service without Company Provided Terminal Equipment at the Customer Premises

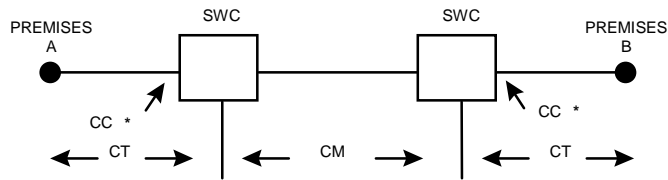

CT - Channel Termination  
CM - Channel Mileage  
SWC - Serving Wire Center  
CC - Configuration Cards

\* WHERE APPLICABLE

GENERAL EXCHANGE TARIFF

Embarq Florida, Inc.

By: F. B. Poag  
Director

SECTION A20  
First Revised Sheet 137  
Cancelling Original Sheet 137  
Effective: September 28, 2002

PRIVATE LINE SERVICES

G. OPTIPOINT SERVICE (Cont'd)

1. REGULATIONS (Cont'd)

b. Definitions

- 1) Channel Mileage - Channel Mileage provides for the end office equipment and the transmission channel between the Serving Wire Centers associated with two customer designated premises. Channel Mileage is comprised of Channel Mileage Facility (per mile) and Channel Mileage Termination (fixed) rates.
  - a) Channel Mileage Facility (Per Mile) - The Channel Mileage Facility (per mile) recovers the cost for the transmission path that extends between the Company Serving Wire Centers and includes primarily outside plant used to provide the facility.
  - b) Channel Mileage Termination (Fixed) - Channel Mileage Termination (fixed) recovers the cost for end office equipment associated with terminating the facility (i.e., basic circuit equipment and terminations at Serving Wire Centers).
- 2) Channel Service Unit (CSU) - The term "Channel Service Unit (CSU)" denotes equipment provided by the customer to terminate a digital facility on the customer's premises.
- 3) Channel Termination - The local facility from the customer's designated premises to the Serving Wire Center.
- 4) OC3 - This denotes a channel service expressed in terms of optical line rates in accordance with North American standards for synchronous optical networks. It has a 155.52 Mbps transmission data rate.
- 5) OC12 - This denotes a channel service expressed in terms of optical line rates in accordance with North American standards for synchronous optical networks. It has a 622.08 Mbps transmission data rate.
- 6) Nonrecurring Charge - A one-time charge for the initial installation, the installation of functions and features and service rearrangements.
- 7) Serving Wire Center - The local telephone central office assigned to subscribers in a predetermined geographic area.

GENERAL EXCHANGE TARIFF

Embarq Florida, Inc.

By: F. B. Poag  
Director

SECTION A20  
First Revised Sheet 138  
Cancelling Original Sheet 138  
Effective: September 28, 2002

PRIVATE LINE SERVICES

G. OPTIPOINT SERVICE (Cont'd)

1. REGULATIONS (Cont'd)

c. Connections

- 1) Customer-Provided Terminal Equipment, Customer-Provided Derivation Equipment and Customer-Provided Communications Systems may be connected to OptiPoint Service when such connection is made in accordance with the provisions specified in 2), 3) and 4) following.
- 2) Responsibility of the Company
  - a) The responsibility of the Company shall be limited to the furnishing and maintenance of OptiPoint Service to a network interface on the customer's premises where provision is made for the connection of local service.
  - b) The Company shall not be responsible for installation, operation or maintenance of any terminal equipment or communications systems provided by the customer. OptiPoint Service is not represented as adapted for the use of such equipment or system. Where such equipment or system is connected to Company facilities, the responsibility of the Company shall be limited to the furnishing of facilities suitable for OptiPoint Service and to the maintenance and operation in a manner proper for such digital service. The Company shall not be responsible for:
    - The through transmission of signals generated by such equipment or system, or for the quality of, or defects in, such transmission, or
    - The reception of signals by such equipment or systems, or
    - Damage to terminal equipment or communications systems provided by a customer or authorized user due to testing.
  - c) The Company shall not be responsible to the customer if changes in any of the facilities, operations or procedures of the Company utilized in the provision of OptiPoint Service render any facilities or equipment provided by a customer obsolete, or require modification or alteration of such equipment or system or otherwise affects its use or performance.

GENERAL EXCHANGE TARIFF

Embarq Florida, Inc.

By: F. B. Poag  
Director

SECTION A20  
First Revised Sheet 139  
Cancelling Original Sheet 139  
Effective: September 28, 2002

PRIVATE LINE SERVICES

G. OPTIPOINT SERVICE (Cont'd)

1. REGULATIONS (Cont'd)

c. Connections (Cont'd)

2) Responsibility of the Company (Cont'd)

d) The Company is responsible for maintaining and repairing the facilities it furnishes. The customer may not rearrange, disconnect, remove or attempt to repair any equipment installed by the Company without prior written consent of the Company.

e) In order to maintain the quality of OptiPoint Service, the Company reserves the right to perform preventative maintenance and software updates to the network. The Company has classified maintenance as follows:

(1) Scheduled Maintenance

Scheduled maintenance is performed for functions such as hardware and software upgrades and network optimization. The Company will perform these tasks in a maintenance window that is anticipated to minimize disruption of customer service and activity. The Company will provide advance notice of all scheduled maintenance.

(2) Demand Maintenance

Demand maintenance may occur as a result of unexpected events and is performed when OptiPoint Service network elements are in jeopardy. The Company will perform this type of maintenance at its discretion. Due to the nature of demand maintenance, prior notification may not be possible; however, the customer will be informed when the maintenance has been completed.

3) Responsibility of the Customer

a) The customer is responsible for installing and testing the customer premises equipment or facilities to insure that when they are connected to OptiPoint Service such equipment or facilities are operating properly.

GENERAL EXCHANGE TARIFF

Embarq Florida, Inc.

By: F. B. Poag  
Director

SECTION A20  
First Revised Sheet 140  
Cancelling Original Sheet 140  
Effective: September 28, 2002

PRIVATE LINE SERVICES

G. OPTIPOINT SERVICE (Cont'd)

1. REGULATIONS (Cont'd)

c. Connections (Cont'd)

3) Responsibility of the Customer (Cont'd)

b) The operating characteristics of the customer premises equipment or facilities shall be such as to not interfere with any of the services offered by the Company. Such use is subject to the further provisions that the equipment provided by a customer does not: endanger the safety of Company employees or the public; damage, require change in or alteration of the equipment or other facilities of the Company; interfere with the proper functioning of such equipment or facilities; impair the operation of the Company's facilities or otherwise injure the public in its use of the Company's services. Upon notice that the equipment provided by a customer is causing or is likely to cause such hazard or interference, the customer shall take such steps as shall be necessary to remove or prevent such hazard or interference.

c) The customer's responsibility shall include cooperative testing with the Company as may be necessary. Where regeneration and/or equalization adjustments or changes may be required to compensate for rearrangements and/or changes in outside plant facilities, the customer will be responsible for all expenses incurred in changes to his customer premises equipment.

4) Connection of Customer-Provided Terminal Equipment, Customer-Provided Derivation Equipment and Customer-Provided Communications Systems

a) The following provisions will apply:

(1) Customer-Provided Terminal Equipment and/or Customer-Provided Communications Systems may be connected at the premises of the customer to OptiPoint Service.

(2) The customers, by use of their own derivation equipment, may create digital bit streams from OptiPoint Service and such equipment may be connected for transmission of such bit streams when connected through a customer-provided CSU.

(3) The undertaking of the Company is to furnish OptiPoint Service as ordered and specified by the customer except as specified in d) following.

GENERAL EXCHANGE TARIFF

Embarq Florida, Inc.

By: F. B. Poag  
Director

SECTION A20  
First Revised Sheet 141  
Cancelling Original Sheet 141  
Effective: September 28, 2002

PRIVATE LINE SERVICES

G. OPTIPOINT SERVICE (Cont'd)

1. REGULATIONS (Cont'd)

c. Connections (Cont'd)

4) Connection of Customer-Provided ... (Cont'd)

b) Connections to Other Services Furnished by the Company to the Same Customer

OptiPoint Service furnished by the Company may be connected by the customer to another service or to other services furnished by the Company as specified in 2) preceding. Connected services are subject to all rules and regulations governing the provisioning of those services.

c) Connections to Other Services Furnished by the Company to Different Customers

The customer may connect at the premises of the customer, to another OptiPoint Service or other services furnished by the Company to different customers as specified in 2) preceding. Connected services are subject to all rules and regulations governing provisioning of those services.

d) Connection of Channel Service Units

A Channel Service Unit (CSU) or appropriate termination equipment must be provided by the customer to connect a Company-provided digital facility. This equipment must comply with the technical requirements outlined in Part 68 of the FCC Rules and Regulations.

e) The customer is responsible for payment of a Trouble Location Charge, as set forth in Section A4 of this tariff, for visits by the Company to the customer's premises when a service difficulty resulting in a trouble report is caused by the use of equipment or facilities provided by the customer.

f) The customer may not rearrange, disconnect, remove or attempt to repair any equipment installed by the Company without the prior written consent of the Company.

g) For maintenance purposes, upon request of the Company, the customer will be responsible for notifying the Company of the type of digital terminating equipment used.



GENERAL EXCHANGE TARIFF

Embarq Florida, Inc.

By: F. B. Poag  
Director

SECTION A20  
Second Revised Sheet 142  
Cancelling First Revised Sheet 142  
Effective: November 16, 2002

PRIVATE LINE SERVICES

G. OPTIPOINT SERVICE (Cont'd)

2. TERM PLAN

- a. The minimum service period is one year. A term plan provides the customer with discounted rates for OptiPoint Service. OptiPoint Service may be ordered under a term plan for fixed periods of one year, three years, or five years. All rate elements within the same OptiPoint Service facility must be ordered under the same commitment period. The customer must order the term plan in writing to the Company.
- b. The customer must specify the length of the initial service period at the time the service is ordered.
- c. At the end of the term plan the customer may subscribe to a new term plan at the prevailing rates set forth in A20.G.7 following. If the customer does not specify renewal terms in writing 90 days prior to the expiration of the three or five year service period, the commitment period and OptiPoint Service rates for the one year term will automatically be applied. If the customer does not specify renewal terms in writing prior to the expiration of the one year service period, the commitment period and the OptiPoint Service rates in effect at the time of expiration will automatically renew. The customer can terminate OptiPoint Service at the end of the minimum commitment period with no penalty or obligation to continue the service.
- d. Rate increases or decreases will automatically be applied to the monthly term plan rates for the remaining term of the term plan. If Company initiated rate increases to any rate element or combination of rate elements causes the charges for the entire OptiPoint Service under the term plan to increase by 10% or more annually, then the customer may cancel the term plan without incurring termination liability charges provided the customer notifies the Company within 30 days after the effective date of the rate increase.
- e. The customer can extend term plan commitment periods at any time during the term of the plan, up to a maximum of five years. The number of remaining months in the original term plan will become part of the total term in the new term plan.

GENERAL EXCHANGE TARIFF

Embarq Florida, Inc.

By: F. B. Poag  
Director

SECTION A20  
First Revised Sheet 143  
Cancelling Original Sheet 143  
Effective: September 28, 2002

PRIVATE LINE SERVICES

G. OPTIPOINT SERVICE (Cont'd)

3. TERMINATION LIABILITY CHARGES

- a. If a customer under a term plan disconnects all or a portion of OptiPoint Service prior to the expiration of the term plan, then a Termination Liability Charge will apply to those services that are disconnected. The Termination Liability Charge will be a one-time charge equal to sum of 50% of the payments remaining for the rest of the term plan.
- b. Customers may move Channel Terminations and not be subject to Termination Liability Charges providing the terms of the term plan are maintained. If charges as specified in A20.G.6.a. following were applied to the service being terminated or moved, any termination or move charges associated with that construction apply, as well as any construction charges at the new location.
- c. Termination Liability Charges will not apply when a service or rate element under a term plan is disconnected prior to the expiration of a selected service period as a result of a change in tariff jurisdiction and/or a customer requested upgrade to a next generation service offering, under the following conditions:
  - 1) The service period of the new term plan for the new service offering is a period equal to or exceeding the remaining service period of the disconnected term plan, and
  - 2) The service orders to install the new service and disconnect the old service are related together, and there is no lapse in service between the installation of the new service and the disconnection of the old service, and
  - 3) The service orders to install the new service and disconnect the old service are for the same customer at the same location.
- d. The Company will determine whether the replacement service qualifies as a next generation service offering.
- e. Nonrecurring charges and Service Charges for the new service will apply according to the requirements of the new service.

GENERAL EXCHANGE TARIFF

Embarq Florida, Inc.

By: F. B. Poag  
Director

SECTION A20  
First Revised Sheet 144  
Cancelling Original Sheet 144  
Effective: September 28, 2002

PRIVATE LINE SERVICES

G. OPTIPOINT SERVICE (Cont'd)

4. MONTHLY RATE CATEGORIES

There are three monthly rate categories which apply to OptiPoint Service:

- Channel Termination
- Channel Mileage
- Configuration Cards

a. Channel Termination

The Channel Termination rate category provides for the communications path between a customer designated premises and the Serving Wire Center. Included as part of the Channel Termination is a standard channel interface arrangement which defines the technical characteristics associated with the type of facilities to which the service is to be connected at the point of termination (POT) and the type of signaling capability if any. The signaling capability itself is provided as a part of this rate category. One Channel Termination charge applies per customer designated premises at which the channel is terminated. The charges applicable to the Channel Termination vary based on distance, as set forth in A20.G.7.a. following.

b. Channel Mileage

The Channel Mileage rate category provides for the end office equipment and the transmission channel between the Serving Wire Centers associated with two customer designated premises. Channel Mileage rates are made up of the Channel Mileage Facility (per mile) rate and the Channel Mileage Termination (fixed) rate. Channel Mileage charges are set forth in A20.G.7.b.

1) Channel Mileage Facility (Per Mile)

The Channel Mileage Facility (per mile) rate recovers the cost for the transmission path, which extends between the Company Serving Wire Centers and includes primarily outside plant used to provide the facility.

2) Channel Mileage Termination (Fixed)

The Channel Mileage Termination (fixed) rate recovers the cost for end office equipment associated with terminating the facility (i.e., basic circuit equipment and terminations at Serving Wire Centers). The Company applies a 50% billing percentage to the channel mileage fixed rate on jointly owned circuits, and applies 100% on wholly owned circuits. When the Channel Mileage Facility (per mile) is zero (i.e., collocated Serving Wire Centers), neither the Channel Mileage Facility (per mile) rate nor the Channel Mileage Termination (fixed) rate will apply.

GENERAL EXCHANGE TARIFF

Embarq Florida, Inc.

By: F. B. Poag  
Director

SECTION A20  
First Revised Sheet 145  
Cancelling Original Sheet 145  
Effective: September 28, 2002

PRIVATE LINE SERVICES

G. OPTIPOINT SERVICE (Cont'd)

4. MONTHLY RATE CATEGORIES (Cont'd)

c. Configuration Card

Configuration Card provides for the interface at which a channelized or lower speed service terminates or originates from an OptiPoint optical line terminated at a customer designated premises or a Company central office. DS1, DS3, and OC3 concatenated cards are available for interfacing OptiPoint-3 service with lower level signals. DS1, DS3, OC3, OC3 concatenated, and OC12 concatenated cards are available for interfacing with OptiPoint-12 service. The charges applicable to Configuration Cards are set forth in A20.G.7.c. following.

d. OptiPoint Regeneration Charge

An OptiPoint Regeneration Charge will be required when the actual fiber facility distance between the customer's premises and serving wire center exceeds SONET design limits. A monthly recurring OptiPoint Regeneration Charge, as set forth in A20.G.7.d. following, will apply for each regenerator required for the provision of OptiPoint Service.

e. Multiplexed Service Connection

A Multiplexed Service Connection is an arrangement that allows one DS1, DS3, OC3, or OC12 channel of a multiplexed Company service to be connected to one DS1, DS3, OC3, or OC12 channel with like signaling of another Company service. For example, the lesser speed may be a LightLink DS3 channel connected between a multiplexed OptiPoint Service. A Multiplexed Service Connection will be provided at all Company locations where Central Office Multiplexing is performed. The charges applicable to the Multiplexed Service Connection are set forth in A20.G.7.e. following.

GENERAL EXCHANGE TARIFF

Embarq Florida, Inc.

By: F. B. Poag  
Director

SECTION A20  
First Revised Sheet 146  
Cancelling Original Sheet 146  
Effective: September 28, 2002

PRIVATE LINE SERVICES

G. OPTIPOINT SERVICE (Cont'd)

5. NONRECURRING CHARGE CATEGORIES

a. OptiPoint- Reconfiguration Charge

If a new configuration is requested subsequent to the initial activation, a OptiPoint Reconfiguration Charge will apply on a per service basis, as set forth in A20.G.8.a. following. The OptiPoint Reconfiguration Charge is in addition to all applicable Configuration Card charges associated with the new configuration.

b. Optical Service Rearrangements

Service rearrangements are changes to existing (installed) services which do not result in either a change in the minimum period requirements or a change in the physical location of the point of termination at a customer designated premises. Changes in the type of service or service termination are treated as disconnects and starts.

For service rearrangements involving OC3 or OC12 OptiPoint Service, a charge equal to one half the Optical Service Charge set forth A20.G.8.b. will apply for each node rearranged.

c. Charges Applicable Under Special Conditions

Charges Applicable Under Special Conditions, as set forth in Section 5 of this tariff, may apply where facilities and/or operating conditions do not permit the provision of OptiPoint Service and the customer desires the Company to provision the OptiPoint Service.

GENERAL EXCHANGE TARIFF

Embarq Florida, Inc.

By: F. B. Poag  
Director

SECTION A20  
First Revised Sheet 147  
Cancelling Original Sheet 147  
Effective: September 28, 2002

PRIVATE LINE SERVICES

G. OPTIPOINT SERVICE (Cont'd)

6. APPLICATION OF RATES

- a. The rates specified for OptiPoint Service in A20.G.7 following contemplate the provision of a digital quality facility utilizing existing interoffice carrier equipment and/or exchange fiber facilities compatible with this service. If equipment, new facilities or changes to existing facilities are required for the provision of this service, then charges as specified in Section 5, Charges Applicable Under Special Conditions, will apply in addition to the rates for OptiPoint Service.
- b. Each OptiPoint Service facility may be comprised of one or two Channel Terminations. Where both customer premises are served by the same Serving Wire Center, the service will consist of two Channel Terminations. Where each customer premises is served by different Serving Wire Centers, the service will consist of two Channel Terminations, one Channel Mileage Termination (fixed) and the Channel Mileage Facility (per mile) between Serving Wire Centers. Where one customer premises is involved, the Channel Termination of a lower bandwidth service can be replaced with an OptiPoint Service Channel Termination. For example, the Local Channel Termination associated with LightLink Service can be replaced with an OptiPoint Service Channel Termination to connect the LightLink Service to the Serving Wire Center of the customer's designated premises.
- c. The Channel Termination rate element for OptiPoint Service will vary based on distance. The mileage used to determine the monthly rate for Channel Terminations located outside a Company central office is the airline distance between the customer's designated premises and the Company's Serving Wire Center. The mileage measurement is determined by utilizing exchange maps and mileage tables located in designated Company offices for such purposes.
- d. Intraexchange channels furnished between company central offices will be charged at rates based on airline distance between the central offices. Interexchange channels will be charged at rates based on airline distance between Company central offices. Fractional mileage will be rounded up to the next full mile.
- e. Whenever facilities are provided jointly by the Company and another telephone company, the regulations, rates and charges of the other telephone company shall apply for the equipment and facilities furnished by the other telephone company for use in connection with OptiPoint Service. The Company applies a 50% billing percentage to the Channel Mileage Termination (fixed) rate on jointly owned circuits, and applies 100% on wholly owned circuits. When the Channel Mileage Facility (per mile) is zero (i.e., collocated Serving Wire Centers), neither the Channel Mileage Facility (per mile) rate nor the Channel Mileage Termination (fixed) rate will apply.

GENERAL EXCHANGE TARIFF

Embarq Florida, Inc.

SECTION A20

By: F. B. Poag  
Director

First Revised Sheet 148  
Cancelling Original Sheet 148  
Effective: September 28, 2002

PRIVATE LINE SERVICES

G. OPTIPOINT SERVICE (Cont'd)

7. MONTHLY RATES

a. Channel Termination  
- Per Point of Termination

1) OptiPoint-3 with Company Provided Terminal Equipment

	<u>S&amp;E Code</u>	<u>Monthly Rate</u>	<u>Installation Nonrecurring Charge</u>
1 Year			
Within CO	PD1CPSP(FW1)	\$1,750.00	\$ 6,000.00
0 - 3 Miles	PD1CPSP(FT1)	2,270.00	6,000.00
Over 3 Miles	PD1CPSP(FV1)	3,665.00	6,000.00
3 Year			
Within CO	PD1CPSP(FW3)	1,575.00	N/A
0 - 3 Miles	PD1CPSP(FT3)	2,045.00	N/A
Over 3 Miles	PD1CPSP(FV3)	3,295.00	N/A
5 Year			
Within CO	PD1CPSP(FW5)	1,485.00	N/A
0 - 3 Miles	PD1CPSP(FT5)	1,930.00	N/A
Over 3 Miles	PD1CPSP(FV5)	3,115.00	N/A

2) OptiPoint-12 with Company Provided Terminal Equipment

	<u>S&amp;E Code</u>	<u>Monthly Rate</u>	<u>Installation Nonrecurring Charge</u>
1 Year			
Within CO	PD1CPSP(GW1)	\$1,970.00	\$9,000.00
0 - 3 Miles	PD1CPSP(GT1)	2,670.00	9,000.00
Over 3 Miles	PD1CPSP(GV1)	4,475.00	9,000.00
3 Year			
Within CO	PD1CPSP(GW3)	1,775.00	N/A
0 - 3 Miles	PD1CPSP(GT3)	2,400.00	N/A
Over 3 Miles	PD1CPSP(GV3)	4,025.00	N/A
5 Year			
Within CO	PD1CPSP(GW5)	1,675.00	N/A
0 - 3 Miles	PD1CPSP(GT5)	2,270.00	N/A
Over 3 Miles	PD1CPSP(GV5)	3,800.00	N/A

GENERAL EXCHANGE TARIFF

Embarq Florida, Inc.

SECTION A20

By: F. B. Poag  
Director

First Revised Sheet 149  
Cancelling Original Sheet 149  
Effective: September 28, 2002

PRIVATE LINE SERVICES

G. OPTIPOINT SERVICE (Cont'd)

7. MONTHLY RATES (Cont'd)

a. Channel Termination (Cont'd)  
- Per Point of Termination

3) OptiPoint-3 without Company Provided Terminal Equipment

	<u>S&amp;E Code</u>	<u>Monthly Rate</u>	<u>Installation Non-Recurring Charge</u>
1 Year			
Within CO	PD1WOSP(FW1)	\$ 875.00	\$4,000.00
0 - 3 Miles	PD1WOSP(FT1)	1,625.00	4,000.00
Over 3 Miles	PD1WOSP(FV1)	2,960.00	4,000.00
3 Year			
Within CO	PD1WOSP(FW3)	785.00	N/A
0 - 3 Miles	PD1WOSP(FT3)	1,460.00	N/A
Over 3 Miles	PD1WOSP(FV3)	2,665.00	N/A
5 Year			
Within CO	PD1WOSP(FW5)	745.00	N/A
0 - 3 Miles	PD1WOSP(FT5)	1,380.00	N/A
Over 3 Miles	PD1WOSP(FV5)	2,520.00	N/A

4) OptiPoint-12 without Company Provided Terminal Equipment

	<u>S&amp;E Code</u>	<u>Monthly Rate</u>	<u>Installation Non-Recurring Charge</u>
1 Year			
Within CO	PD1WOSP(GW1)	\$1,325.00	\$ 5,000.00
0 - 3 Miles	PD1WOSP(GT1)	1,845.00	5,000.00
Over 3 Miles	PD1WOSP(GV1)	3,650.00	5,000.00
3 Year			
Within CO	PD1WOSP(GW3)	1,195.00	N/A
0 - 3 Miles	PD1WOSP(GT3)	1,660.00	N/A
Over 3 Miles	PD1WOSP(GV3)	3,285.00	N/A
5 Year			
Within CO	PD1WOSP(GW5)	1,125.00	N/A
0 - 3 Miles	PD1WOSP(GT5)	1,570.00	N/A
Over 3 Miles	PD1WOSP(GV5)	3,100.00	N/A



GENERAL EXCHANGE TARIFF

Embarq Florida, Inc.

By: F. B. Poag  
Director

SECTION A20  
First Revised Sheet 150  
Cancelling Original Sheet 150  
Effective: September 28, 2002

PRIVATE LINE SERVICES

G. OPTIPOINT SERVICE (Cont'd)

7. MONTHLY RATES (Cont'd)

b. Channel Mileage

	<u>S&amp;E Code</u>	<u>Monthly Rate</u>
1) Termination (Fixed) - Per Circuit		
OptiPoint - 3		
1 Year	PD1POSP(FF1)	\$1,965.00
3 Year	PD1POSP(FF3)	1,765.00
5 Year	PD1POSP(FF5)	1,670.00
OptiPoint – 12		
1 Year	PD1POSP(GF1)	5,400.00
3 Year	PD1POSP(GF3)	5,130.00
5 Year	PD1POSP(GF5)	4,590.00
2) Facility (Per Mile)		
OptiPoint - 3		
1 Year	PD1POSP(FP1)	140.00
3 Year	PD1POSP(FP3)	130.00
5 Year	PD1POSP(FP5)	115.00
OptiPoint – 12		
1 Year	PD1POSP(GP1)	320.00
3 Year	PD1POSP(GP3)	285.00
5 Year	PD1POSP(GP5)	270.00

GENERAL EXCHANGE TARIFF

Embarq Florida, Inc.

SECTION A20

By: F. B. Poag  
Director

Second Revised Sheet 151  
Cancelling First Revised Sheet 151  
Effective: June 25, 2003

PRIVATE LINE SERVICES

G. OPTIPOINT SERVICE (Cont'd)

7. MONTHLY RATES (Cont'd)

c. Configuration Card  
- Per Card

	<u>S&amp;E Code</u>	<u>Monthly Rate</u>
1) OptiPoint - 3		
DS1 Level		
1 Year	PD1CCSP(FL1)	\$25.00
3 Year	PD1CCSP(FL3)	20.00
5 Year	PD1CCSP(FL5)	15.00
DS3 Level		
1 Year	PD1CCSP(FM1)	70.00
3 Year	PD1CCSP(FM3)	60.00
5 Year	PD1CCSP(FM5)	55.00
OC3 Concatenated		
1 Year	PD1CCSP(FN1)	350.00
3 Year	PD1CCSP(FN3)	335.00
5 Year	PD1CCSP(FN5)	320.00
2) OptiPoint – 12		
DS1 Level		
1 Year	PD1CCSP(GL1)	25.00
3 Year	PD1CCSP(GL3)	20.00
5 Year	PD1CCSP(GL5)	15.00
DS3 Level		
1 Year	PD1CCSP(GM1)	65.00
3 Year	PD1CCSP(GM3)	60.00
5 Year	PD1CCSP(GM5)	55.00
OC3 Level		
1 Year	PD1CCSP(GN1)	160.00
3 Year	PD1CCSP(GN3)	120.00
5 Year	PD1CCSP(GN5)	100.00
OC3 Concatenated		
1 Year	PD1CCSP(GO1)	185.00
3 Year	PD1CCSP(GO3)	165.00
5 Year	PD1CCSP(GO5)	150.00
OC12 Concatenated		
1 Year	PD1CCSP(GQ1)	3,100.00
3 Year	PD1CCSP(GQ3)	3,000.00
5 Year	PD1CCSP(GQ5)	2,900.00

GENERAL EXCHANGE TARIFF

Embarq Florida, Inc.

By: F. B. Poag  
Director

SECTION A20  
First Revised Sheet 152  
Cancelling Original Sheet 152  
Effective: September 28, 2002

PRIVATE LINE SERVICES

G. OPTIPOINT SERVICE (Cont'd)

7. MONTHLY RATES (Cont'd)

	<u>S&amp;E Code</u>	<u>Monthly Rate</u>	
d. OptiPoint Regeneration Charges - Per Regeneration			
OC3			
1 Year	PD1RCSP(F1)	\$1,500.00	
3 Year	PD1RCSP(F3)	1,400.00	
5 Year	PD1RCSP(F5)	1,200.00	
OC12			
1 Year	PD1RCSP(G1)	2,600.00	
3 Year	PD1RCSP(G3)	2,500.00	
5 Year	PD1RCSP(G5)	2,200.00	
e. Multiplexed Service Connection			
	<u>S&amp;E Code</u>	<u>Monthly Rate</u>	<u>Nonrecurring Charge</u>
- Per DS1	PD1MSSP(DS1)	\$10.00	\$100.00
- Per DS3	PD1MSSP(DS3)	15.00	100.00
- Per OC3 and OC12	PD1MSSP(OC)	20.00	100.00

GENERAL EXCHANGE TARIFF

Embarq Florida, Inc.

By: F. B. Poag  
Director

SECTION A20  
First Revised Sheet 153  
Cancelling Original Sheet 153  
Effective: September 28, 2002

PRIVATE LINE SERVICES

G. OPTIPOINT SERVICE (Cont'd)

8. NONRECURRING CHARGES

	<u>Nonrecurring Charge</u>
a. OptiPoint Reconfiguration Charge - Per DS3 Equivalent	\$700.00
b. Optical Service Charge - Per Node	
OC3	\$7,500.00
OC12	\$8,500.00
c. Installation Nonrecurring Charge	
<p>The Installation Nonrecurring Charge is applicable for the initial installation of a Channel Termination to a given Serving Wire Center.</p>	
d. Move Charges	
<p>A Move Charge applies for Channel Terminations moved to a new location, even when moved on the same premises. The Move Charge is equal to the Channel Termination Installation Nonrecurring Charge and applies in addition to the Primary Service Order Charge located in Section 4 of this tariff.</p>	
e. Service Charges	
<p>A Primary Service Order Charge as set forth in Section 4 of this tariff is applicable per customer request. Nonrecurring Charges specified in this tariff section are in lieu of all other Service Charges.</p>	

## GENERAL EXCHANGE TARIFF

Embarq Florida, Inc.

By: F. B. Poag  
Director

SECTION A20  
First Revised Sheet 154  
Cancelling Original Sheet 154  
Effective: September 28, 2002

### PRIVATE LINE SERVICES

#### H. SONET RING SERVICE

##### 1. REGULATIONS

###### a. Description of Service

SONET Ring Service is a dedicated high capacity network (bandwidth) designed to provide the customer reliable functionality for the transmission of voice, data, and video via a self-healing ring topology between multiple customer designated locations and Company central offices. SONET Ring Service will only be offered using 2-fiber unidirectional path switch ring (UPSR) topology. The SONET Ring Service network will consist of fiber optic facilities routed through Local, Alternative Central Office, Internodal, and/or Interoffice Channel facilities that transmit DS1, DS3, OC3, OC3c, and OC12 channel services simultaneously over primary and alternative diverse paths between customer designated locations and Company central offices. Continuous monitoring of the DS1, DS3, OC3, OC3c, and/or OC12 service quality will occur. Detection of a failure within the system will result in automatic self-healing around the point of failure to ensure that the DS1, DS3, OC3, OC3c, and/or OC12 services between locations within the SONET Ring Service network will continue.

SONET Ring Service provides survivable facilities and high speed synchronous optical fiber-based full duplex data transmission capabilities. There are two levels of SONET Ring Service: OC3 is provided at a terminating bit rate of 155.52 Mbps; and OC12 is provided at a terminating bit rate of 622.08 Mbps.

SONET Ring Service is provided for periods of one, three, or five years. When a customer orders SONET Ring Service, the customer and the Company will work cooperatively to plan, engineer, provision and manage SONET Ring Service.

The required format and interface specifications are contained in Technical Reference Publication GR-253.

Current SONET standards do not provide for asynchronous DS3 to DS1 multiplexing. An STS1 channel may be mapped for either one DS3 or 28 DS1s. However, DS1s within a DS3 are not accessible within the SONET architecture, and their performance cannot be guaranteed for this reason. When the customer requests that an OC3 or OC12 service be configured with a combination of DS3 and DS1 channels, a DS3 to DS1 multiplexing arrangement, as set forth in Section A20.F.9.c. 1) will be required.

The customer ordering SONET Ring Service must order a minimum of two nodes, one of which must be a Customer Node and one of which must be a Central Office Node. The maximum number of nodes will be determined by the technical characteristics and capability of the ring configuration requested.

GENERAL EXCHANGE TARIFF

Embarq Florida, Inc.

By: F. B. Poag  
Director

SECTION A20  
First Revised Sheet 155  
Cancelling Original Sheet 155  
Effective: September 28, 2002

PRIVATE LINE SERVICES

H. SONET RING SERVICE (Cont'd)

1. REGULATIONS (Cont'd)

a. Description of Service (Cont'd)

Customers of SONET Ring Service will need to provide the Company with a matrix detailing the configuration interface assignments desired among the nodes on the dedicated ring. The matrix must provide detail by node, by STS group. This matrix will assist the Company in ensuring that node to node channels are linked appropriately. Customers must provide suitable floor space, controlled environment, and source of non-switched suitable power to support the service.

1) Customer Node

Customer Nodes provide ring switching capabilities at customer designated locations other than the Company central offices that are part of SONET Ring Service. This rate element offers OC3 and OC12 network capacities and is provided with or without Company provided equipment. Customer Node equipment provided by the customer must be compatible with that of the Company. When a customer elects to furnish its own node equipment at the customer's premises, the Company will install a cross-connect device on the Company side of the demarcation point, allowing the customer to connect their node equipment.

2) Central Office Node

Central Office Nodes provide ring switching capabilities at Company central offices that are part of SONET Ring Service. This rate element offers OC3 and OC12 network capacities.

3) Configuration Card

A Configuration Card provides DS1, DS3 and OC3c electrical channelization and/or OC3 and OC12 optical channelization that may take place at each Customer or Central Office Node located on SONET Ring Service. The Configuration Card rate element applies for every interface capacity that originates or terminates at a Customer or Central Office Node. When the customer elects to furnish its own terminal equipment at the Customer Node, the rate for the Configuration Card at the Customer Node does not apply.

GENERAL EXCHANGE TARIFF

Embarq Florida, Inc.

By: F. B. Poag  
Director

SECTION A20  
First Revised Sheet 156  
Cancelling Original Sheet 156  
Effective: September 28, 2002

PRIVATE LINE SERVICES

H. SONET RING SERVICE (Cont'd)

1. REGULATIONS (Cont'd)

a. Description of Service (Cont'd)

4) Local Channel

The Local Channel provides for the communications path between a Customer Node and the serving wire center of the premises where the Customer Node is located. One Local Channel rate element will apply per customer designated premises for each Local Channel terminated.

Monthly recurring rates for Local Channels apply for each air mile increment of the channel. Air mileage is measured using V&H coordinates between nodes. Fractions of an airline mile are rounded up to the next mile. The minimum charge is one airline mile except when the customer designated premises and the serving wire center are located in the same Company building, or where both customer designated premises are in the same building. In those instances, the Intraoffice Channel charge, as set forth in 8) following, will apply in lieu of the one-mile minimum Local Channel charge.

5) Alternate Central Office Channel

The Alternate Central Office Channel provides for the communications path between a Customer Node and an Alternate Central Office. The primary Central Office Node and any Alternate Central Office Node and applicable Configuration Cards must be associated with the same SONET Ring Service. Monthly recurring rates for Alternative Central Office Channels apply for each air mile increment of the channel. Air mileage is measured using V&H coordinates between nodes. Fractions of an airline mile are rounded up to the next mile. The minimum charge is one airline mile.

6) Interoffice Channel

The Interoffice Channel provides for the communications path between directly connected Company Central Offices located on a SONET Ring Service. This rate element does not apply where Central Office Nodes are adjacently connected in the same central office on the same SONET Ring Service for the purposes of providing additional node capacity. Monthly recurring rates for Interoffice Channels apply for each air mile increment of the channel. Air mileage is measured using V&H coordinates between nodes. Fractions of an airline mile are rounded up to the next mile. The minimum charge is one airline mile.

GENERAL EXCHANGE TARIFF

Embarq Florida, Inc.

By: F. B. Poag  
Director

SECTION A20  
First Revised Sheet 157  
Cancelling Original Sheet 157  
Effective: September 28, 2002

PRIVATE LINE SERVICES

H. SONET RING SERVICE (Cont'd)

1. REGULATIONS (Cont'd)

a. Description of Service (Cont'd)

7) Internodal Channel

The Internodal Channel provides for the communications path between two directly connected Customer Nodes of a given SONET Ring Service located (a) in the same serving wire center area, (b) in the same office park /campus environment or contiguous property located in contiguous serving wire center areas, or (c) in different serving wire center areas. Monthly recurring rates for Internodal Channels apply for each air mile increment of the channel. Air mileage is measured using V&H coordinates between nodes. Fractions of an airline mile are rounded up to the next mile. The minimum charge is one airline mile.

8) Intraoffice Channel

The Intraoffice Channel provides for the communications path when the customer designated premises and the serving wire center are located in the same Company building, or where both customer designated premises are in the same building. Flat rated monthly recurring rates apply for each Intraoffice Channel.

9) SONET Ring Service Reconfiguration Charge

SONET Ring Service Reconfiguration Charge allows the customer to request that the Company reallocate Configuration Cards located at each Customer or Central Office Node subsequent to the initial service installation.

If a new configuration is requested at the Customer or Central Office Node subsequent to the initial activation, a SONET Ring Service Reconfiguration Charge will apply on a per service basis, as set forth in A20.H.6.a. following. The SONET Ring Service Reconfiguration Charge is in addition to all applicable Configuration Card charges associated with the new configuration.

10) SONET Ring Service Regeneration Charges

Due to the technical limitations of SONET facilities, additional regeneration equipment may be required for essential detection and retransmission of SONET signals between nodes. Additional regeneration equipment will only be provided by the Company when the actual fiber facility distance between the nodes exceeds SONET design limits. A monthly recurring SONET Ring Service Regeneration Charge, as set forth in A20.H.5.e. following, will apply for each regenerator required for the provision of SONET Ring Service.



GENERAL EXCHANGE TARIFF

Embarq Florida, Inc.

By: F. B. Poag  
Director

SECTION A20  
First Revised Sheet 158  
Cancelling Original Sheet 158  
Effective: September 28, 2002

PRIVATE LINE SERVICES

H. SONET RING SERVICE (Cont'd)

1. REGULATIONS (Cont'd)

a. Description of Service (Cont'd)

11) SONET Ring Service Rearrangements

For service rearrangements involving OC3 or OC12 SONET Ring Service, a charge equal to one half the Optical Service Charge set forth A20.H.6.b. will apply for each Customer or Central Office Node rearranged. The Optical Service Charge recovers the labor involved with designing, provisioning, and installing Customer and Central Office Nodes.

Service rearrangements are changes to existing (installed) services which do not result in either a change in the minimum period requirements or a change in the physical location of the point of termination at a customer designated premises. Changes in the type of service or service termination are treated as disconnects and starts. Changes in the physical location of the point of the termination are treated as moves and are described and charged for as set forth in A20.H.6.d. following.

12) Multiplexed Service Connection

A Multiplexed Service Connection is an arrangement that allows one DS1, DS3, OC3, or OC12 channel of a multiplexed Company service to be connected to one DS1, DS3, OC3, or OC12 channel with like signaling of another Company service. For example, the lesser speed may be a LightLink DS3 channel connected between a multiplexed SONET Ring Service. A Multiplexed Service Connection will be provided at all Company locations where Central Office Multiplexing is performed.

13) Multipoint service is not available with SONET Ring Service.

14) A Channel Service Unit (CSU) or appropriate termination equipment provided by the customer is required at a customer's or authorized user's premises to perform such functions as:

- proper termination of the service
- amplification
- signal shaping
- remote loop-back

15) Unless specified following, the regulations for SONET Ring Service specified herein apply in addition to the regulations set forth in other sections of this tariff.

16) Suspension of Business and Residence Service (Vacation Service) at the customer's request, as defined in Section A2 of this tariff, is not allowed.

GENERAL EXCHANGE TARIFF

Embarq Florida, Inc.

By: F. B. Poag  
Director

SECTION A20  
First Revised Sheet 159  
Cancelling Original Sheet 159  
Effective: September 28, 2002

PRIVATE LINE SERVICES

H. SONET RING SERVICE (Cont'd)

1. REGULATIONS (Cont'd)

a. Description of Service (Cont'd)

17) Service Diagram

The following diagrams depict generic views of SONET Ring Service:

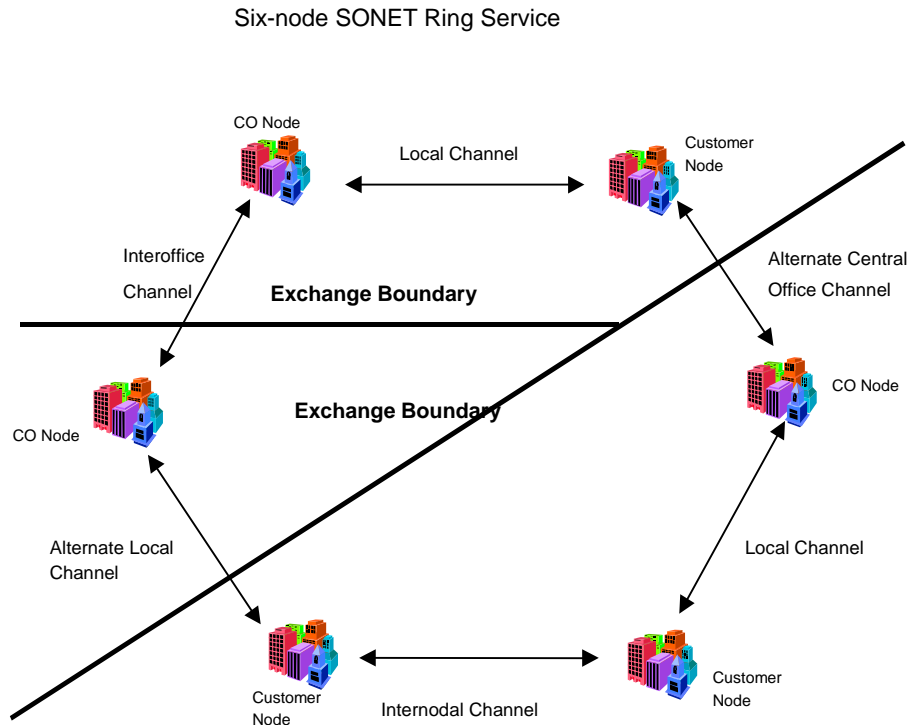

A Configuration Card may apply at each node. The rate element applies for capacity that originates or terminates at a node. A Configuration Card provides for electrical (DS1, DS3, OC3c or optical (OC3 and OC12).

GENERAL EXCHANGE TARIFF

Embarq Florida, Inc.

By: F. B. Poag  
Director

SECTION A20  
First Revised Sheet 160  
Cancelling Original Sheet 160  
Effective: September 28, 2002

PRIVATE LINE SERVICES

H. SONET RING SERVICE (Cont'd)

1. REGULATIONS (Cont'd)

a. Description of Service (Cont'd)

17) Service Diagram (Cont'd)

Two-node SONET Ring Service

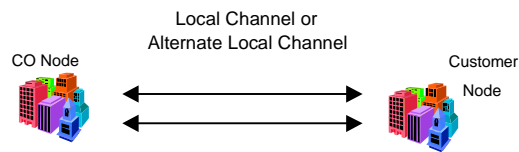

A Configuration Card may apply at each node. The rate element applies for capacity that originates or terminates at a node. A Configuration Card provides for electrical (DS1, DS3, OC3c) or optical (OC3 and OC12).

GENERAL EXCHANGE TARIFF

Embarq Florida, Inc.

By: F. B. Poag  
Director

SECTION A20  
First Revised Sheet 161  
Cancelling Original Sheet 161  
Effective: September 28, 2002

PRIVATE LINE SERVICES

H. SONET RING SERVICE (Cont'd)

1. REGULATIONS (Cont'd)

b. Definitions

- 1) Channel Service Unit (CSU) - The term "Channel Service Unit (CSU)" denotes equipment provided by the customer to terminate a digital facility on the customer's premises.
- 2) OC3 - This denotes a channel service expressed in terms of its digitally encoded data bit rate in accordance with the North American hierarchy of digital signal levels. It has a 155.52 Mbps transmission data rate.
- 3) OC12 - This denotes a channel service expressed in terms of its digitally encoded data bit rate in accordance with the North American hierarchy of digital signal levels. It has a 622.08 Mbps transmission data rate.
- 4) Nonrecurring Charge - A one-time charge for the initial installation, the installation of functions and features and service rearrangements.
- 5) Serving Wire Center - The local telephone central office assigned to subscribers in a predetermined geographic area.

GENERAL EXCHANGE TARIFF

Embarq Florida, Inc.

By: F. B. Poag  
Director

SECTION A20  
First Revised Sheet 162  
Cancelling Original Sheet 162  
Effective: September 28, 2002

PRIVATE LINE SERVICES

H. SONET RING SERVICE (Cont'd)

1. REGULATIONS (Cont'd)

c. Connections

- 1) Customer-Provided Terminal Equipment, Customer-Provided Derivation Equipment and Customer-Provided Communications Systems may be connected to SONET Ring Service when such connection is made in accordance with the provisions specified in 2), 3) and 4) following.
- 2) Responsibility of the Company
  - a) The responsibility of the Company shall be limited to the furnishing and maintenance of SONET Ring Service to a network interface on the customer's premises where provision is made for the connection of local service.
  - b) The Company shall not be responsible for installation, operation or maintenance of any terminal equipment or communications systems provided by the customer. SONET Ring Service is not represented as adapted for the use of such equipment or system. Where such equipment or system is connected to Company facilities, the responsibility of the Company shall be limited to the furnishing of facilities suitable for SONET Ring Service and to the maintenance and operation in a manner proper for such digital service. The Company shall not be responsible for:
    - The through transmission of signals generated by such equipment or system, or for the quality of, or defects in, such transmission, or
    - The reception of signals by such equipment or systems, or
    - Damage to terminal equipment or communications systems provided by a customer or authorized user due to testing.
  - c) The Company shall not be responsible to the customer if changes in any of the facilities, operations or procedures of the Company utilized in the provision of SONET Ring Service render any facilities or equipment provided by a customer obsolete, or require modification or alteration of such equipment or system or otherwise affects its use or performance.

GENERAL EXCHANGE TARIFF

Embarq Florida, Inc.

By: F. B. Poag  
Director

SECTION A20  
First Revised Sheet 163  
Cancelling Original Sheet 163  
Effective: September 28, 2002

PRIVATE LINE SERVICES

H. SONET RING SERVICE (Cont'd)

1. REGULATIONS (Cont'd)

c. Connections (Cont'd)

2) Responsibility of the Company (Cont'd)

d) The Company is responsible for maintaining and repairing the facilities it furnishes. The customer may not rearrange, disconnect, remove or attempt to repair any equipment installed by the Company without prior written consent of the Company.

e) In order to maintain the quality of SONET Ring Service, the Company reserves the right to perform preventative maintenance and software updates to the network. The Company has classified maintenance as follows:

(1) Scheduled Maintenance

Scheduled maintenance is performed for functions such as hardware and software upgrades and network optimization. The Company will perform these tasks in a maintenance window that is anticipated to minimize disruption of customer service and activity. The Company will provide advance notice of all scheduled maintenance.

(2) Demand Maintenance

Demand maintenance may occur as a result of unexpected events and is performed when SONET Ring Service network elements are in jeopardy. The Company will perform this type of maintenance at its discretion. Due to the nature of demand maintenance, prior notification may not be possible; however, the customer will be informed when the maintenance has been completed.

3) Responsibility of the Customer

a) The customer is responsible for installing and testing the customer premises equipment or facilities to insure that when they are connected to SONET Ring Service such equipment or facilities are operating properly.

GENERAL EXCHANGE TARIFF

Embarq Florida, Inc.

By: F. B. Poag  
Director

SECTION A20  
First Revised Sheet 164  
Cancelling Original Sheet 164  
Effective: September 28, 2002

PRIVATE LINE SERVICES

H. SONET RING SERVICE (Cont'd)

1. REGULATIONS (Cont'd)

c. Connections (Cont'd)

3) Responsibility of the Customer (Cont'd)

b) The operating characteristics of the customer premises equipment or facilities shall be such as to not interfere with any of the services offered by the Company. Such use is subject to the further provisions that the equipment provided by a customer does not: endanger the safety of Company employees or the public; damage, require change in or alteration of the equipment or other facilities of the Company; interfere with the proper functioning of such equipment or facilities; impair the operation of the Company's facilities or otherwise injure the public in its use of the Company's services. Upon notice that the equipment provided by a customer is causing or is likely to cause such hazard or interference, the customer shall take such steps as shall be necessary to remove or prevent such hazard or interference.

c) The customer's responsibility shall include cooperative testing with the Company as may be necessary. Where regeneration and/or equalization adjustments or changes may be required to compensate for rearrangements and/or changes in outside plant facilities, the customer will be responsible for all expenses incurred in changes to his customer premises equipment.

4) Connection of Customer-Provided Terminal Equipment, Customer-Provided Derivation Equipment and Customer-Provided Communications Systems

a) The following provisions will apply:

(1) Customer-Provided Terminal Equipment and/or Customer-Provided Communications Systems may be connected at the premises of the customer to SONET Ring Service.

(2) The customers, by use of their own derivation equipment, may create digital bit streams from SONET Ring Service and such equipment may be connected for transmission of such bit streams when connected through a customer-provided CSU.

(3) The undertaking of the Company is to furnish SONET Ring Service as ordered and specified by the customer except as specified in d) following.

GENERAL EXCHANGE TARIFF

Embarq Florida, Inc.

By: F. B. Poag  
Director

SECTION A20  
First Revised Sheet 165  
Cancelling Original Sheet 165  
Effective: September 28, 2002

PRIVATE LINE SERVICES

H. SONET RING SERVICE (Cont'd)

1. REGULATIONS (Cont'd)

c. Connections (Cont'd)

4) Connection of Customer-Provided ... (Cont'd)

b) Connections to Other Services Furnished by the Company to the Same Customer

SONET Ring Service furnished by the Company may be connected by the customer to another service or to other services furnished by the Company as specified in 2) preceding. Connected services are subject to all rules and regulations governing the provisioning of those services.

c) Connections to Other Services Furnished by the Company to Different Customers

The customer may connect at the premises of the customer, to another SONET Ring Service or other services furnished by the Company to different customers as specified in 2) preceding. Connected services are subject to all rules and regulations governing provisioning of those services.

d) Connection of Channel Service Units

A Channel Service Unit (CSU) or appropriate termination equipment must be provided by the customer to connect a Company-provided digital facility. This equipment must comply with the technical requirements outlined in Part 68 of the FCC Rules and Regulations.

e) The customer is responsible for payment of a Trouble Location Charge, as set forth in Section A4 of this tariff, for visits by the Company to the customer's premises when a service difficulty resulting in a trouble report is caused by the use of equipment or facilities provided by the customer.

f) The customer may not rearrange, disconnect, remove or attempt to repair any equipment installed by the Company without the prior written consent of the Company.

g) For maintenance purposes, upon request of the Company, the customer will be responsible for notifying the Company of the type of digital terminating equipment used.



GENERAL EXCHANGE TARIFF

Embarq Florida, Inc.

SECTION A20

By: F. B. Poag  
Director

Second Revised Sheet 166  
Cancelling First Revised Sheet 166  
Effective: November 16, 2002

PRIVATE LINE SERVICES

H. SONET RING SERVICE (Cont'd)

2. TERM PLAN

- a. The minimum service period is one year. A term plan provides the customer with discounted rates for SONET Ring Service. SONET Ring Service may be ordered under a term plan for fixed periods of one year, three years, or five years. All rate elements within the same SONET Ring Service facility must be ordered under the same commitment period. The customer must order the term plan in writing to the Company.
- b. The customer must specify the length of the initial service period at the time the service is ordered.
- c. At the end of the term plan the customer may subscribe to a new term plan at the prevailing rates set forth in A20.H.5 following. If the customer does not specify renewal terms in writing 90 days prior to the expiration of the three or five year service period, the commitment period and SONET Ring Service rates for the one year term will automatically be applied. If the customer does not specify renewal terms in writing prior to the expiration of the one year service period, the commitment period and the SONET Ring Service rates in effect at the time of expiration will automatically renew. The customer can terminate SONET Ring Service at the end of the minimum commitment period with no penalty or obligation to continue the service.
- d. Rate increases or decreases will automatically be applied to the monthly term plan rates for the remaining term of the term plan. If Company initiated rate increases to any rate element or combination of rate elements causes the charges for the entire SONET Ring Service under the term plan to increase by 10% or more annually, then the customer may cancel the term plan without incurring termination liability charges provided the customer notifies the Company within 30 days after the effective date of the rate increase.
- e. The customer can extend term plan commitment periods at any time during the term of the plan, up to a maximum of five years. The number of remaining months in the original term plan will become part of the total term in the new term plan.

GENERAL EXCHANGE TARIFF

Embarq Florida, Inc.

By: F. B. Poag  
Director

SECTION A20  
First Revised Sheet 167  
Cancelling Original Sheet 167  
Effective: September 28, 2002

PRIVATE LINE SERVICES

H. SONET RING SERVICE (Cont'd)

3. TERMINATION LIABILITY CHARGES

- a. If a customer under a term plan disconnects all or a portion of SONET Ring Service prior to the expiration of the term plan, then a Termination Liability Charge will apply to those services that are disconnected. The Termination Liability Charge will be a one-time charge equal to sum of 50% of the payments remaining for the rest of the term plan.
- b. Customers may move Customer Nodes and/or Central Office Nodes on the SONET Ring Service and not be subject to Termination Liability Charges providing the terms of the term plan are maintained. If charges as specified in A20.H.4.a. following were applied to the service being terminated or moved, any termination or move charges associated with that construction apply, as well as any construction charges at the new location.
- c. Termination Liability Charges will not apply when a service or rate element under a term plan is disconnected prior to the expiration of a selected service period as a result of a change in tariff jurisdiction and/or a customer requested upgrade to a next generation service offering, under the following conditions:
  - 1) The service period of the new term plan for the new service offering is a period equal to or exceeding the remaining service period of the disconnected term plan, and
  - 2) The service orders to install the new service and disconnect the old service are related together, and there is no lapse in service between the installation of the new service and the disconnection of the old service, and
  - 3) The service orders to install the new service and disconnect the old service are for the same customer and central office locations.
- d. The Company will determine whether the replacement service qualifies as a next generation service offering.
- e. Nonrecurring charges and Service Charges for the new service will apply according to the requirements of the new service.

GENERAL EXCHANGE TARIFF

Embarq Florida, Inc.

By: F. B. Poag  
Director

SECTION A20  
First Revised Sheet 168  
Cancelling Original Sheet 168  
Effective: September 28, 2002

PRIVATE LINE SERVICES

H. SONET RING SERVICE (Cont'd)

4. APPLICATION OF RATES

- a. The rates specified for SONET Ring Service in A20.H.5 following contemplate the provision of a digital quality facility utilizing existing interoffice carrier equipment and/or exchange cable facilities compatible with this service. If equipment, new facilities or changes to existing facilities are required for the provision of this service, then charges as specified in Section 5, Charges Applicable Under Special Conditions, will apply in addition to the rates for SONET Ring Service.
- b. The rates and charges for SONET Ring Service are set forth in A20.H.5, following, and are in addition to any applicable rates and charges set forth in other sections of this tariff. The applicable rates for SONET Ring Service include monthly recurring rates and nonrecurring charges, both of which are billed in advance.
- c. Monthly recurring rates for Local, Alternative Central Office Interoffice, and Internodal Channels apply for each air mile increment of the channel. Air mileage is measured using V&H coordinates between nodes. Fractions of an airline mile are rounded up to the next mile. The minimum charge is one airline mile, except when the customer designated premises and the serving wire center are collocated in the Company building, or where both customer designated premises are in the same building. In those instances, the Intraoffice Channel monthly recurring rate would apply rather than the initial one mile minimum.
- d. For Internodal Channels, monthly recurring charges apply, as appropriate, for the same serving wire center area or contiguous serving wire center areas. Monthly recurring rates for Customer and Central Office Nodes apply per node and are based upon the capacity of the ring configuration.
- e. Monthly recurring rates for Configuration Cards apply for each origination and each termination of an activated DS1, DS3, OC3, OC3c, and/or OC12 at the Customer or Central Office Node.
- f. The service period for SONET Ring Service is one, three or five years.
- g. Charges Applicable Under Special Conditions, as set forth in Section 5 of this tariff, may apply where facilities and/or operating conditions do not permit the provision of SONET Ring Service and the customer desires the Company to provision the SONET Ring Service.
- h. Customers may be required to pay Charges Applicable Under Special Conditions when a four fiber optical service configuration is requested in lieu of the two fiber UPSR topology for SONET Ring Service.

Where dual entrance facilities currently exist to a customer premises, special construction charges will not be assessed when the customer requests connection at both entrance facilities.

GENERAL EXCHANGE TARIFF

Embarq Florida, Inc.

By: F. B. Poag  
Director

SECTION A20  
Second Revised Sheet 169  
Cancelling First Revised Sheet 169  
Effective: June 25, 2003

PRIVATE LINE SERVICES

H. SONET RING SERVICE (Cont'd)

5. MONTHLY RATES

a. Customer Node  
- Per Node

1) With Telephone Company Provided Terminal Equipment

	<u>S&amp;E Code</u>	<u>Monthly Rate</u>	<u>Installation Nonrecurring Charge</u>
OC3			
1 Year	PD1CUSN(FR1)	\$1,545.00	\$8,000.00
3 Year	PD1CUSN(FR3)	1,390.00	N/A
5 Year	PD1CUSN(FR5)	1,310.00	N/A
OC12			
1 Year	PD1CUSN(GR1)	2,085.00	10,000.00
3 Year	PD1CUSN(GR3)	1,875.00	N/A
5 Year	PD1CUSN(GR5)	1,775.00	N/A

2) Without Telephone Company Provided Terminal Equipment

OC3			
1 Year	PD1CUSN(FS1)	115.00	4,500.00
3 Year	PD1CUSN(FS3)	105.00	N/A
5 Year	PD1CUSN(FS5)	95.00	N/A
OC12			
1 Year	PD1CUSN(GS1)	130.00	5,500.00
3 Year	PD1CUSN(GS3)	120.00	N/A
5 Year	PD1CUSN(GS5)	110.00	N/A

GENERAL EXCHANGE TARIFF

Embarq Florida, Inc.

By: F. B. Poag  
Director

SECTION A20  
First Revised Sheet 170  
Cancelling Original Sheet 170  
Effective: September 28, 2002

PRIVATE LINE SERVICES

H. SONET RING SERVICE (Cont'd)

5. MONTHLY RATES (Cont'd)

b. Central Office Node  
- Per Node

	<u>S&amp;E Code</u>	<u>Monthly Rate</u>	<u>Installation Nonrecurring Charge</u>
OC3			
1 Year	PD1COSN(F1)	\$1,250.00	\$4,500.00
3 Year	PD1COSN(F3)	1,125.00	N/A
5 Year	PD1COSN(F5)	1,065.00	N/A
OC12			
1 Year	PD1COSN(G1)	1,800.00	5,500.00
3 Year	PD1COSN(G3)	1,620.00	N/A
5 Year	PD1COSN(G5)	1,530.00	N/A

GENERAL EXCHANGE TARIFF

Embarq Florida, Inc.

By: F. B. Poag  
Director

SECTION A20  
First Revised Sheet 171  
Cancelling Original Sheet 171  
Effective: September 28, 2002

PRIVATE LINE SERVICES

H. SONET RING SERVICE (Cont'd)

5. MONTHLY RATES (Cont'd)

c. Configuration Card  
- Per Interface

	<u>S&amp;E Code</u>	<u>Monthly Rates</u>
1) OC3		
DS1 Level		
1 Year	PD1CCSN(FL1)	\$25.00
3 Year	PD1CCSN(FL3)	20.00
5 Year	PD1CCSN(FL5)	15.00
DS3 Level		
1 Year	PD1CCSN(FM1)	65.00
3 Year	PD1CCSN(FM3)	60.00
5 Year	PD1CCSN(FM5)	55.00
2) OC12		
DS1 Level		
1 Year	PD1CCSN(GL1)	25.00
3 Year	PD1CCSN(GL3)	20.00
5 Year	PD1CCSN(GL5)	15.00
DS3 Level		
1 Year	PD1CCSN(GM1)	65.00
3 Year	PD1CCSN(GM3)	60.00
5 Year	PD1CCSN(GM5)	55.00
OC3 Level		
1 Year	PD1CCSN(GN1)	120.00
3 Year	PD1CCSN(GN3)	100.00
5 Year	PD1CCSN(GN5)	85.00
OC3 Concatenated		
1 Year	PD1CCSN(GP1)	180.00
3 Year	PD1CCSN(GP3)	165.00
5 Year	PD1CCSN(GP5)	145.00

GENERAL EXCHANGE TARIFF

Embarq Florida, Inc.

By: F. B. Poag  
Director

SECTION A20  
First Revised Sheet 172  
Cancelling Original Sheet 172  
Effective: September 28, 2002

PRIVATE LINE SERVICES

H. SONET RING SERVICE (Cont'd)

5. MONTHLY RATES (Cont'd)

d. Channel Charges

	<u>S&amp;E Code</u>	<u>Monthly Rates</u>
1) Local Channel		
- Per Mile		
1 Year	PD1POSN(B1)	\$270.00
3 Year	PD1POSN(B3)	250.00
5 Year	PD1POSN(B5)	230.00
2) Alternate Central Office Channel		
- Per Mile		
1 Year	PD1POSN(A1)	315.00
3 Year	PD1POSN(A3)	285.00
5 Year	PD1POSN(A5)	245.00
3) Interoffice Channel (Per Mile)		
- Per Mile		
1 Year	PD1POSN(C1)	275.00
3 Year	PD1POSN(C2)	250.00
5 Year	PD1POSN(C3)	225.00
4) Internodal Channel		
- Per Mile		
1 Year	PD1POSN(D1)	370.00
3 Year	PD1POSN(D3)	310.00
5 Year	PD1POSN(D5)	250.00
5) Intraoffice Channel		
- Per OC3		
1 Year	PD1POSN(E1)	160.00
3 Year	PD1POSN(E2)	150.00
5 Year	PD1POSN(E3)	140.00

GENERAL EXCHANGE TARIFF

Embarq Florida, Inc.

By: F. B. Poag  
Director

SECTION A20  
First Revised Sheet 173  
Cancelling Original Sheet 173  
Effective: September 28, 2002

PRIVATE LINE SERVICES

H. SONET RING SERVICE (Cont'd)

5. MONTHLY RATES (Cont'd)

e. SONET Ring Service Regeneration Charge  
- Per Regeneration

	<u>S&amp;E Code</u>	<u>Monthly Rates</u>
OC3		
1 Year	PD1RCSN(F1)	\$1,400.00
3 Year	PD1RCSN(F3)	1,300.00
5 Year	PD1RCSN(F5)	1,100.00
OC12		
1 Year	PD1RCSN(G1)	2,700.00
3 Year	PD1RCSN(G3)	2,400.00
5 Year	PD1RCSN(G5)	2,100.00

f. Multiplexed Service Connection

	<u>S&amp;E Code</u>	<u>Monthly Rate</u>	<u>Nonrecurring Charge</u>
- Per DS1	PD1MSSN(DS1)	\$ 5.00	\$100.00
- Per DS3	PD1MSSN(DS3)	10.00	100.00
- Per OC3 and OC12	PD1MSSN(OC)	15.00	100.00



GENERAL EXCHANGE TARIFF

Embarq Florida, Inc.

By: F. B. Poag  
Director

SECTION A20  
First Revised Sheet 174  
Cancelling Original Sheet 174  
Effective: September 28, 2002

PRIVATE LINE SERVICES

H. SONET RING SERVICE (Cont'd)

6. NONRECURRING CHARGES

	<u>Nonrecurring Charge</u>
a. SONET Ring Service Reconfiguration Charge - Per DS3 Equivalent	\$700.00
b. Optical Service Charge - Per Node	
OC3	\$7,500.00
OC12	\$8,500.00
c. Initial Nonrecurring Charge	
The Installation Nonrecurring Charge is applicable for the initial installation of a Customer Node and/or Central Office Node.	
d. Move Charges	
A Move Charge applies for Customer and/or Central Office Nodes moved to a new location, even when moved on the same premises. The Move Charge is equal to the Customer Node and/or Central Office Node Installation Nonrecurring Charge and applies in addition to the Primary Service Order Charge located in Section 4 of this tariff.	
e. Service Charges	
A Primary Service Order Charge as set forth in Section 4 of this tariff is applicable per customer request. Nonrecurring Charges specified in this tariff section are in lieu of all other Service Charges.	

GENERAL EXCHANGE TARIFF

Embarq Florida, Inc.

By: F. B. Poag  
Director

SECTION A21  
First Revised Contents Sheet 1  
Cancelling Original Contents Sheet 1  
Effective: January 6, 2003

LINK SERVICES

CONTENTS

	SHEET
A. LINK SERVICES .....	1
1. General Regulations .....	1
2. Regulations .....	2
3. Term Discount Plan (TDP) .....	13
4. Termination Liability Charges.....	14
5. Rate Categories .....	15
6. Application of Rates .....	20
7. Rates and Charges .....	23

## GENERAL EXCHANGE TARIFF

Embarq Florida, Inc.

BY: F. B. Poag  
Director

SECTION A21  
First Revised Sheet 1  
Cancelling Original Sheet 1  
Effective: January 6, 2003

### LINK SERVICES

#### A. LINK SERVICES

##### 1. GENERAL

- a. DigiLink, TransLink, and LightLink Services are furnished for Private Line IntraLATA Intraexchange and Interexchange communications by the Company.
- b. DigiLink, TransLink, and LightLink Services are for the transmission of digital signals and uses digital transmission facilities.
- c. DigiLink Service provides for the simultaneous two-way transmission of synchronous digital signals at speeds of 19.2 Kbps, 56.0 Kbps, and 64.0 Kbps, where facilities exist.

TransLink Service provides for the simultaneous two-way transmission of isochronous digital signals at speeds of 128 Kbps, 256 Kbps, 384 Kbps, 512 Kbps, and 1.544 Mbps (DS1), where facilities exist.

LightLink Service provides for the simultaneous two-way transmission of isochronous digital signals at speeds of 44.736 Mbps (DS3), where facilities exist.

- d. To ensure satisfactory operation, the terminal equipment provided by the customer must be compatible with the DigiLink, TransLink, and LightLink Service channel facility provided by the Company.
- e. Unless specified following, the regulations for DigiLink, TransLink, and LightLink Services specified herein apply in addition to the regulations set forth in other sections of this tariff.
- f. The rates specified for DigiLink, TransLink, and LightLink Services in A.7. following contemplate the provision of a digital quality facility utilizing existing interoffice carrier equipment and/or exchange cable facilities compatible with this service. If equipment, new facilities or changes to existing facilities are required for the provision of this service, then charges as specified in Section 5, Charges Applicable Under Special Conditions , will apply in addition to the rates for DigiLink, TransLink, and LightLink Services.
- g. Suspension of Service (Vacation Service) as defined in Section 2 of this tariff, is not allowed.
- h. The minimum period for which DigiLink and TransLink Services are furnished and for which charges are applicable is six (6) months. The minimum period for LightLink Service is twelve (12) months.

GENERAL EXCHANGE TARIFF

Embarq Florida, Inc.

BY: F. B. Poag  
Director

SECTION A21  
First Revised Sheet 1  
Cancelling Original Sheet 1  
Effective: January 6, 2003

LINK SERVICES

A. LINK SERVICES

2 REGULATIONS

a. Description of Service

DigiLink Service

- (1) DigiLink Service is furnished for the simultaneous two-way transmission of digital signals at synchronous rates of 19.2 Kbps, 56.0 Kbps, and 64.0 Kbps between two or more points located within a LATA. The required format and interface specifications are contained in Technical Reference Publications TR-NWT-000341 and MDP-326-726.
- (2) DigiLink is furnished for duplex operation only.
- (3) Multipoint service is available with DigiLink Service and involves applications requiring three or more locations.

TransLink Service

- (4) TransLink Service provides a high capacity channel for the transmission of 1.544 Mbps isochronous serial data having a line code of Bipolar Return-to-Zero (BPRZ). TransLink Service is provided between two points located within a LATA. The required format and interface specifications are contained in Technical Reference Publications GR-54 and GR-342.
- (5) Fractional DS1 channels are also available and provide simultaneous, two-way transmission at contiguous bit rates of 128, 256, 384 and 512 Kbps. Fractional DS1 Channels operate over the combined bandwidth of adjacent channels to create a contiguous bit rate. Due to technical limitations associated with the provision of Fractional DS1 Channels, this service will be offered only in end offices where a compatible channel bank exists and the distance between the central office and the customer designated premises is less than or equal to twelve thousand (12,000) feet.
- (6) Multipoint service is not available with TransLink Service.

LightLink Service

- (7) LightLink Service provides a high capacity channel for the transmission of 44.736 Mbps isochronous serial data having a line code of bipolar three zero substitution (B3ZS). LightLink Service is provided between two points located within a LATA. LightLink Service is available utilizing an electrical interface. The interface will have the characteristics of its respective signal at the point of demarcation. The required format and interface specifications are contained in Technical Reference Publication 62508 and 62411, and the associated Addendum TR-INS-000342 and TR-NPL-000054.
- (8) Multipoint service is not available with LightLink Service.

GENERAL EXCHANGE TARIFF

Embarq Florida, Inc.

BY: F. B. Poag  
Director

SECTION A21  
First Revised Sheet 3  
Cancelling Original Sheet 3  
Effective: January 6, 2003

LINK SERVICES

A. LINK SERVICES

2 REGULATIONS

a. Description of Service (Cont'd)

DigiLink, TransLink, and LightLink Services

(9) A Channel Service Unit (CSU) or appropriate termination equipment provided by the customer is required at a customer's or authorized user's premises to perform such functions as:

- proper termination of the service
- amplification
- signal shaping
- remote loop-back

(10) The design, maintenance and operation of DigiLink, TransLink, and LightLink Services contemplate communications originating and terminating as, (1) a customer premises to customer premises channel via the Company's Serving Wire Center and/or through remote Serving Wire Centers; (2) a customer premises to the Serving Wire Center and/or remote Serving Wire Centers - partial channel (link); or (3) a central office to central office (interoffice) partial channel (link).

GENERAL EXCHANGE TARIFF

Embarq Florida, Inc.

BY: F. B. Poag  
Director

SECTION A21  
First Revised Sheet 4  
Cancelling Original Sheet 4  
Effective: January 6, 2003

LINK SERVICES

A. LINK SERVICES

2 REGULATIONS

a. Description of Service (Cont'd)

DigiLink, TransLink, and LightLink Services

(11) Service Configurations

There are two types of service configurations over which Link Services are provided: two-point service and multipoint service.

Two-Point Service

A two-point service connects two customer designated premises, either on a directly connected basis or through a hub where multiplexing functions are performed or a customer designated premises.

Applicable rate elements are:

- Channel Terminations
- Channel Mileage (as applicable)
- Optional Features and Functions (when applicable)

The following diagram depicts a two-point service connecting two customer designated premises located 15 miles apart.

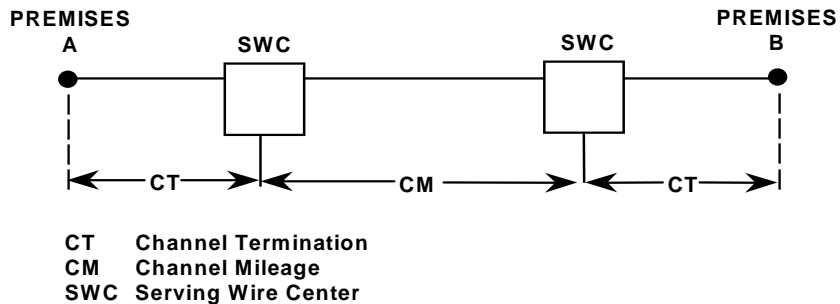

Applicable rate elements are:

- Channel Terminations (2 applicable)
- Channel Mileage (1 Termination and 15 Facility)

GENERAL EXCHANGE TARIFF

Embarq Florida, Inc.

BY: F. B. Poag  
Director

SECTION A21  
First Revised Sheet 5  
Cancelling Original Sheet 5  
Effective: January 6, 2003

LINK SERVICES

A. LINK SERVICES

2 REGULATIONS

a. Description of Service (Cont'd)

DigiLink, TransLink, and LightLink Services (Cont'd)

(11) Service Configurations (Cont'd)

Multipoint Service

Multipoint service connects three or more customer designated premises through a Company hub. There is no limitation on the number of mid-links available with multipoint service. However, when more than three mid-links are provided in tandem, the quality of the service may be degraded. A mid-link is a channel between hubs (i.e., bridging locations).

Applicable rate elements are:

- Channel Terminations (one per customer designated premises)
- Channel Mileage (as applicable between each designated customer premises and the hub, and between hubs)
- Additional Optional Features and Functions (when applicable)

The following diagram depicts a service connecting four customer premises via two customer specified bridging hubs.

GENERAL EXCHANGE TARIFF

Embarq Florida, Inc.

BY: F. B. Poag  
Director

SECTION A21  
First Revised Sheet 6  
Cancelling Original Sheet 6  
Effective: January 6, 2003

LINK SERVICES

A. LINK SERVICES

2 REGULATIONS

a. Description of Service (Cont'd)

DigiLink, TransLink, and LightLink Services (Cont'd)

(11) Service Configurations (Cont'd)

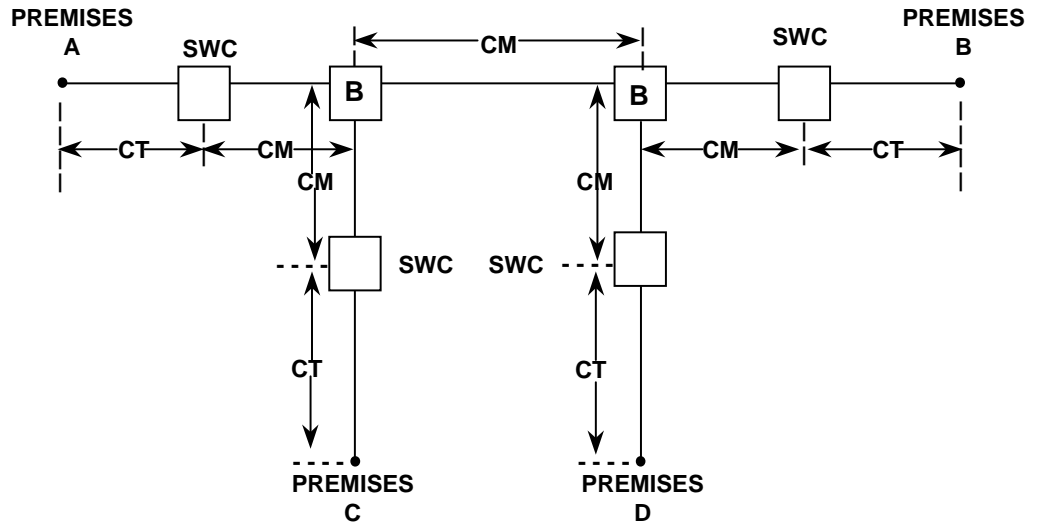

- CT** - Channel Termination
- CM** - Channel Mileage
- B** - Bridging
- SWC** - Serving Wire Center

Applicable rate elements are:

- Channel Terminations (4 applicable)
- Channel Mileage (5 sections, Termination and Facility as appropriate)
- Bridging (6 applicable, i.e., each bridge port)



## GENERAL EXCHANGE TARIFF

Embarq Florida, Inc.

BY: F. B. Poag  
Director

SECTION A21  
First Revised Sheet 7  
Cancelling Original Sheet 7  
Effective: January 6, 2003

### LINK SERVICES

#### A. LINK SERVICES (Cont'd)

##### 2 REGULATIONS (Cont'd)

##### b. Definitions

- (1) Central Office Bridging Capability - Provides for the parallel connection of one virtual circuit to another virtual circuit without interrupting the integrity or continuity of the first. This service is only available from a Company-designated digital hub.
- (2) Channel Mileage - Channel Mileage provides for the end office equipment and the transmission channel between the Serving Wire Centers associated with two customer designated premises, between a Serving Wire Center associated with a customer designated premises and a Company hub, or between two Company hubs. Channel Mileage is comprised of Channel Mileage Facility (per mile) and Channel Mileage Termination (fixed) rates.
  - (a) Channel Mileage Facility (Per Mile) - The Channel Mileage Facility (per mile) recovers the cost for the transmission path that extends between the Company Serving Wire Centers and/or hub(s) and includes primarily outside plant used to provide the facility.
  - (b) Channel Mileage Termination (Fixed) - Channel Mileage Termination (fixed) recovers the cost for end office equipment associated with terminating the facility (i.e., basic circuit equipment and terminations at Serving Wire Centers).
- (3) Channel Service Unit (CSU) - The term "Channel Service Unit (CSU)" denotes equipment provided by the customer which performs one or more of the following functions: termination of a digital facility, regeneration of digital signals, detection and/or correction of signal format errors and remote loop back.
- (4) Channel Termination – The local facility from the customer's designated premises to the Serving Wire Center.
- (5) Data Amplification – Data Amplification provides for data transmission when the customer is located beyond the normal range for high speed digital data service. Channel Terminations greater than five (5) cable route miles in length for 19.2 Kbps service or three (3) miles in length for 56 Kbps and 64 Kbps service may require circuit repeaters and associated equipment be installed to regenerate the digital signal in order for accurate and acceptable data transmission to occur. The distances given are an indication of the potential requirement for Data Amplification. The actual distance is dependent on decibel (db) loss and not just physical loop length and is a function of the specific Company cable between the Serving Wire Center and the customer's location.

GENERAL EXCHANGE TARIFF

Embarq Florida, Inc.

BY: F. B. Poag  
Director

SECTION A21  
First Revised Sheet 8  
Cancelling Original Sheet 8  
Effective: January 6, 2003

LINK SERVICES

A. LINK SERVICES (Cont'd)

2. REGULATIONS (Cont'd)

b. Definitions (Cont'd)

- (6) Clear Channel Capability (CCC) - The term "Clear Channel Capability" denotes the transport of twenty-four, 64 Kbps channels over a 1.544 Mbps TransLink Service via B8ZS line code format.
- (7) Customer Designated Premises - The term "Customer Designated Premises" denotes the premises specified by the customer for the provision of Link Services.
- (8) DS3 - This denotes a channel service expressed in terms of its digitally encoded data bit rate in accordance with the North American hierarchy of digital signal levels. It has a 44.736 Mbps transmission data rate, and provides for the two-way simultaneous transmission of randomized Non-Return-to-Zero (NRZ) signals with B3ZS format.
- (9) Hub - A hub is a Company designated Serving Wire Center at which bridging or multiplexing functions are performed. The bridging functions performed may be used to connect three or more customer designated premises in a multipoint arrangement. The multiplexing functions are to channelize digital facilities to individual services requiring a lower capacity or bandwidth.
- (10) Multipoint Service - Multipoint service connects three or more customer designated premises through a Company hub. There is no limitation on the number of mid-links available with multipoint service. However, when more than three mid-links are provided in tandem, the quality of the service may be degraded. A mid-link is a channel between hubs (i.e., bridging locations).
- (11) Nonrecurring Charge - A one-time charge for the initial installation, the installation of functions and features and service rearrangements.
- (12) Serving Wire Center - The term "Serving Wire Center" denotes the wire center from which the customer designated premises would normally obtain dial tone from the Company.
- (13) Two-Point Service - A two-point service connects two customer designated premises, either on a directly connected basis or through a hub where multiplexing functions are performed or a customer designated premises.

GENERAL EXCHANGE TARIFF

Embarq Florida, Inc.

BY: F. B. Poag  
Director

SECTION A21  
First Revised Sheet 9  
Cancelling Original Sheet 9  
Effective: January 6, 2003

LINK SERVICES

A. LINK SERVICES (Cont'd)

2. REGULATIONS (Cont'd)

c. Connections

- (1) Customer-Provided Terminal Equipment, Customer-Provided Derivation Equipment and Customer-Provided Communications Systems may be connected to DigiLink, TransLink and LightLink Services when such connection is made in accordance with the provisions specified in (2), (3) and (4) following.
- (2) Responsibility of the Company
  - (a) The responsibility of the Company shall be limited to the furnishing and maintenance of DigiLink, TransLink and LightLink Services to a network interface on the customer's premises where provision is made for the connection of local service.
  - (b) The Company shall not be responsible for installation, operation or maintenance of any terminal equipment or communications systems provided by the customer. DigiLink, TransLink and LightLink Services is not represented as adapted for the use of such equipment or system. Where such equipment or system is connected to Company facilities, the responsibility of the Company shall be limited to the furnishing of facilities suitable for DigiLink, TransLink and LightLink Services and to the maintenance and operation in a manner proper for such digital service. The Company shall not be responsible for:
    - The through transmission of signals generated by such equipment or system, or for the quality of, or defects in, such transmission, or
    - The reception of signals by such equipment or systems, or
    - Damage to terminal equipment or communications systems provided by a customer or authorized user due to testing.

GENERAL EXCHANGE TARIFF

Embarq Florida, Inc.

BY: F. B. Poag  
Director

SECTION A21  
First Revised Sheet 10  
Cancelling Original Sheet 10  
Effective: January 6, 2003

LINK SERVICES

A. LINK SERVICES (Cont'd)

2. REGULATIONS (Cont'd)

c. Connections (Cont'd)

(2) Responsibility of the Company (Cont'd)

(c) The Company shall not be responsible to the customer if changes in any of the facilities, operations or procedures of the Company utilized in the provision of DigiLink, TransLink and LightLink Services render any facilities or equipment provided by a customer obsolete, or require modification or alteration of such equipment or system or otherwise affects its use or performance.

(d) The Company is responsible for maintaining and repairing the facilities it furnishes. The customer may not rearrange, disconnect, remove or attempt to repair any equipment installed by the Company without prior written consent of the Company.

(e) DigiLink, TransLink and LightLink Services are designed to meet or exceed a performance objective of 99% error-free seconds of transmission per 1000 seconds on a daily basis and 99.9% availability on an annual basis when measured through the digital termination equipment.

(f) In order to maintain the quality of DigiLink, TransLink and LightLink Services, the Company reserves the right to perform preventative maintenance and software updates to the network. The Company has classified maintenance as follows:

(i) Scheduled Maintenance

Scheduled maintenance is performed for functions such as hardware and software upgrades and network optimization. The Company will perform these tasks in a maintenance window that is anticipated to minimize disruption of customer service and activity. The Company will provide advance notice of all scheduled maintenance.

(ii) Demand Maintenance

Demand maintenance may occur as a result of unexpected events and is performed when DigiLink, TransLink and LightLink Services network elements are in jeopardy. The Company will perform this type of maintenance at its discretion. Due to the nature of demand maintenance, prior notification may not be possible; however, the customer will be informed when the maintenance has been completed.

GENERAL EXCHANGE TARIFF

Embarq Florida, Inc.

BY: F. B. Poag  
Director

SECTION A21  
First Revised Sheet 11  
Cancelling Original Sheet 11  
Effective: January 6, 2003

LINK SERVICES

A. LINK SERVICES (Cont'd)

2. REGULATIONS (Cont'd)

c. Connections (Cont'd)

(3) Responsibility of the Customer

(a) The customer is responsible for installing and testing the customer premises equipment or facilities to insure that when they are connected to DigiLink, TransLink and LightLink Services such equipment or facilities are operating properly.

(b) The operating characteristics of the customer premises equipment or facilities shall be such as to not interfere with any of the services offered by the Company. Such use is subject to the further provisions that the equipment provided by a customer does not: endanger the safety of Company employees or the public; damage, require change in or alteration of the equipment or other facilities of the Company; interfere with the proper functioning of such equipment or facilities; impair the operation of the Company's facilities or otherwise injure the public in its use of the Company's services. Upon notice that the equipment provided by a customer is causing or is likely to cause such hazard or interference, the customer shall take such steps as shall be necessary to remove or prevent such hazard or interference.

(c) The customer's responsibility shall include cooperative testing with the Company as may be necessary. Where regeneration and/or equalization adjustments or changes may be required to compensate for rearrangements and/or changes in outside plant facilities, the customer will be responsible for all expenses incurred in changes to his customer premises equipment.

(4) Connection of Customer-Provided Terminal Equipment, Customer-Provided Derivation Equipment and Customer-Provided Communications Systems

(a) The following provisions will apply:

(i) Customer-Provided Terminal Equipment and/or Customer-Provided Communications Systems may be connected at the premises of the customer to DigiLink, TransLink and LightLink Services.

GENERAL EXCHANGE TARIFF

Embarq Florida, Inc.

BY: F. B. Poag  
Director

SECTION A21  
First Revised Sheet 12  
Cancelling Original Sheet 12  
Effective: January 6, 2003

LINK SERVICES

A. LINK SERVICES (Cont'd)

2. REGULATIONS (Cont'd)

c. Connections (Cont'd)

(4) Connection of Customer-Provided ... (Cont'd)

(a) The following provisions will apply: (Cont'd)

(ii) The customers, by use of their own derivation equipment, may create digital bit streams from DigiLink, TransLink and LightLink Services and such equipment may be connected for transmission of such bit streams when connected through a customer-provided CSU.

(iii) The undertaking of the Company is to furnish DigiLink, TransLink and LightLink Services as ordered and specified by the customer except as specified in (d) following.

(b) Connections to Other Services Furnished by the Company to the Same Customer

DigiLink, TransLink and LightLink Services furnished by the Company may be connected by the customer to another service or to other services furnished by the Company as specified in (2) preceding. Connected services are subject to all rules and regulations governing the provisioning of those services.

(c) Connections to Other Services Furnished by the Company to Different Customers

The customer may connect at the premises of the customer, to another DigiLink, TransLink and LightLink Services or other services furnished by the Company to different customers as specified in (2) preceding. Connected services are subject to all rules and regulations governing provisioning of those services.

(d) Connection of Channel Service Units

A Channel Service Unit (CSU) or appropriate termination equipment must be provided by the customer to connect a Company-provided digital facility. This equipment must comply with the technical requirements outlined in Part 68 of the FCC Rules and Regulations.

## GENERAL EXCHANGE TARIFF

Embarq Florida, Inc.

BY: F. B. Poag  
Director

SECTION A21  
Second Revised Sheet 13  
Cancelling First Revised Sheet 13  
Effective: November 11, 2003

### LINK SERVICES

#### A. LINK SERVICES (Cont'd)

##### 2. REGULATIONS (Cont'd)

##### c. Connections (Cont'd)

##### (4) Connection of Customer-Provided ... (Cont'd)

- (e) The customer shall be responsible for payment of a trouble location charge, as set forth in Section A4 of this tariff, for visits by the Company to the Customer's premises where the service difficulty or trouble report results from the use of equipment or facilities provided by the Customer.
- (f) The customer may not rearrange, disconnect, remove or attempt to repair any equipment installed by the Company without the prior written consent of the Company.
- (g) For maintenance purposes, upon request of the Company, the customer will be responsible for notifying the Company of the type of digital terminating equipment used.

##### 3. TERM DISCOUNT PLAN (TDP)

- a. A Term Discount Plan (TDP) provides the customer with discounted rates for DigiLink, TransLink and LightLink Services. DigiLink, TransLink and LightLink Service may be ordered under a TDP for fixed periods of 12 - 23 months, 24 - 35 months, 36 - 59 months, and 60 - 84 months. For LightLink Service, month-to-month rates may apply only after the expiration of a TDP. All rate elements within the same DigiLink, TransLink and LightLink Service facilities must be ordered under the same commitment period and under the same service date. The customer must order the TDP in writing to the Company. A TDP may be ordered in one-month increments, (e.g. a 28-month commitment period or a 37-month commitment period).
- b. The customer must specify the length of the initial service period at the time the service is ordered. When a customer converts to a TDP, Nonrecurring Charges do not apply toward facilities in-service at that time. If a customer converts from month-to-month rates to a TDP or upgrades from one TDP to another, Nonrecurring Charges and Service Ordering Charges do not apply.
- c. At the end of the TDP the customer may subscribe to a new TDP at the prevailing rates set forth in A.7. following. If the customer does not select a new TDP, the rates will convert to the prevailing month-to-month rates.

## GENERAL EXCHANGE TARIFF

Embarq Florida, Inc.

BY: F. B. Poag  
Director

SECTION A21  
First Revised Sheet 14  
Cancelling Original Sheet 14  
Effective: January 6, 2003

### LINK SERVICES

#### A. LINK SERVICES (Cont'd)

##### 3. TERM DISCOUNT PLAN (TDP) (Cont'd)

- d. Rate increases or decreases will automatically be applied to the monthly term plan rates for the remaining term of the TDP. If Company initiated rate increases to any rate element or combination of rate elements causes the charges for the entire DigiLink, TransLink or LightLink Service under the TDP to increase by 10% or more annually, then the customer may cancel the TDP without incurring termination liability charges provided the customer notifies the Company within 30 days after the effective date of the rate increase.
- e. The customer can extend TDP commitment periods at any time during the term of the plan, up to a maximum of 84 months. The number of remaining months in the original term plan will become part of the total term in the new term plan.

##### 4. TERMINATION LIABILITY CHARGES

- a. If a customer under a Term Discount Plan (TDP) disconnects all or a portion of DigiLink, TransLink or LightLink Service prior to the expiration of the TDP, then a Termination Liability Charge will apply to those services that are disconnected. The Termination Liability Charge will be a one-time charge equal to sum of 50% of the payments remaining for the rest of the TDP.
- b. Customers may move Channel Terminations and not be subject to Termination Liability Charges providing the terms of the TDP are maintained. If charges as specified in A.1.f. were applied to the service being terminated or moved, any termination or move charges associated with that construction apply, as well as any construction charges at the new location.
- c. Termination Liability Charges will not apply when a service or rate element under a TDP is disconnected prior to the expiration of a selected service period as a result of a change in tariff jurisdiction and/or a customer requested upgrade to a next generation service offering, under the following conditions:
  - (1) The service period of the new TDP for the new service offering is a period equal to or exceeding the remaining service period of the disconnected TDP, and
  - (2) The service orders to install the new service and disconnect the old service are related together, and there is no lapse in service between the installation of the new service and the disconnection of the old service, and
  - (3) The service orders to install the new service and disconnect the old service are for the same customer at the same location.
- d. The Company will determine whether the replacement service qualifies as a next generation service offering.
- e. Nonrecurring charges and Service Ordering Charges for the new service will apply according to the requirements of the new service.



GENERAL EXCHANGE TARIFF

Embarq Florida, Inc.

BY: F. B. Poag  
Director

SECTION A21  
First Revised Sheet 15  
Cancelling Original Sheet 15  
Effective: January 6, 2003

LINK SERVICES

A. LINK SERVICES (Cont'd)

5. RATE CATEGORIES

DIGILINK SERVICE

There are two rate categories which apply to DigiLink Service:

- Channel Termination
- Channel Mileage

a. Channel Termination

The Channel Termination rate category provides for the communications path between a customer designated premises and the Serving Wire Center. Included as part of the Channel Termination is a standard channel interface arrangement which defines the technical characteristics associated with the type of facilities to which the service is to be connected at the point of termination (POT) and the type of signaling capability if any. The signaling capability itself is provided as a part of this rate category. One Channel Termination charge applies per customer designated premises at which the channel is terminated. Channel Termination charges are set forth in A.7.a.

b. Channel Mileage

The Channel Mileage rate category provides for the end office equipment and the transmission channel between the Serving Wire Centers associated with two customer designated premises, between a Serving Wire Center associated with a customer designated premises and a Company hub, or between two Company hubs. Channel Mileage rates are made up of the Channel Mileage Facility (per mile) rate and the Channel Mileage Termination (fixed) rate. Channel Mileage charges are set forth in A.7.b.

(1) Channel Mileage Facility (Per Mile)

The Channel Mileage Facility (per mile) rate recovers the cost for the transmission path, which extends between the Company Serving Wire Centers and/or hub(s) and includes primarily outside plant used to provide the facility.

(2) Channel Mileage Termination (Fixed)

The Channel Mileage Termination (fixed) rate recovers the cost for end office equipment associated with terminating the facility (i.e., basic circuit equipment and terminations at Serving Wire Centers). The Company applies a 50% billing percentage to the channel mileage fixed rate on jointly owned circuits, and applies 100% on wholly owned circuits. When the Channel Mileage Facility (per mile) is zero (i.e., collocated Serving Wire Centers), neither the Channel Mileage Facility (per mile) rate nor the Channel Mileage Termination (fixed) rate will apply.

GENERAL EXCHANGE TARIFF

Embarq Florida, Inc.

BY: F. B. Poag  
Director

SECTION A21  
First Revised Sheet 16  
Cancelling Original Sheet 16  
Effective: January 6, 2003

LINK SERVICES

A. LINK SERVICES (Cont'd)

5. RATE CATEGORIES (Cont'd)

TRANSLINK SERVICE

There are two rate categories which apply to TransLink Service:

- Channel Termination
- Channel Mileage

c. Channel Termination

The Channel Termination rate category provides for the communications path between a customer designated premises and the Serving Wire Center. Included as part of the Channel Termination is a standard channel interface arrangement which defines the technical characteristics associated with the type of facilities to which the service is to be connected at the point of termination (POT) and the type of signaling capability if any. The signaling capability itself is provided as a part of this rate category. One Channel Termination charge applies per customer designated premises at which the channel is terminated. Channel Termination charges are set forth in A.7.a.

d. Channel Mileage

The Channel Mileage rate category provides for the end office equipment and the transmission channel between the Serving Wire Centers associated with two customer designated premises, between a Serving Wire Center associated with a customer designated premises and a Company hub, or between two Company hubs. Channel Mileage rates are made up of the Channel Mileage Facility (per mile) rate and the Channel Mileage Termination (fixed) rate. Channel Mileage charges are set forth in A.7.b.

(1) Channel Mileage Facility (Per Mile)

The Channel Mileage Facility (per mile) rate recovers the cost for the transmission path, which extends between the Company Serving Wire Centers and/or hub(s) includes primarily outside plant used to provide the facility.

(2) Channel Mileage Termination (Fixed)

The Channel Mileage Termination (fixed) rate recovers the cost for end office equipment associated with terminating the facility (i.e., basic circuit equipment and terminations at Serving Wire Centers). The Company applies a 50% billing percentage to the channel mileage fixed rate on jointly owned circuits, and applies 100% on wholly owned circuits. When the Channel Mileage Facility (per mile) is zero (i.e., collocated Serving Wire Centers), neither the Channel Mileage Facility (per mile) rate nor the Channel Mileage Termination (fixed) rate will apply.

## GENERAL EXCHANGE TARIFF

Embarq Florida, Inc.

BY: F. B. Poag  
Director

SECTION A21  
First Revised Sheet 17  
Cancelling Original Sheet 17  
Effective: January 6, 2003

### LINK SERVICES

#### A. LINK SERVICES (Cont'd)

##### 5. RATE CATEGORIES (Cont'd)

###### LIGHTLINK SERVICE

There are two rate categories which apply to LightLink Service:

- Channel Termination
- Channel Mileage

###### e. Channel Termination

The Channel Termination rate category provides for the communications path between a customer designated premises and the Serving Wire Center. Included as part of the Channel Termination is a standard channel interface arrangement which defines the technical characteristics associated with the type of facilities to which the service is to be connected at the point of termination (POT) and the type of signaling capability if any. The signaling capability itself is provided as a part of this rate category. One Channel Termination charge applies per customer designated premises at which the channel is terminated. The charges applicable to the Channel Termination vary based on distance, as set forth in A.7.a. following.

###### f. Channel Mileage

The Channel Mileage rate category provides for the end office equipment and the transmission channel between the Serving Wire Centers associated with two customer designated premises, between a Serving Wire Center associated with a customer designated premises and a Company hub, or between two Company hubs... Channel Mileage rates are made up of the Channel Mileage Facility (per mile) rate and the Channel Mileage Termination (fixed) rate. Channel Mileage charges are set forth in A.7.b.

###### (1) Channel Mileage Facility (Per Mile)

The Channel Mileage Facility (per mile) rate recovers the cost for the transmission path, which extends between the Company Serving Wire Centers and/or hub(s) includes primarily outside plant used to provide the facility.

###### (2) Channel Mileage Termination (Fixed)

The Channel Mileage Termination (fixed) rate recovers the cost for end office equipment associated with terminating the facility (i.e., basic circuit equipment and terminations at Serving Wire Centers). The Company applies a 50% billing percentage to the channel mileage fixed rate on jointly owned circuits, and applies 100% on wholly owned circuits. When the Channel Mileage Facility (per mile) is zero (i.e., collocated Serving Wire Centers), neither the Channel Mileage Facility (per mile) rate nor the Channel Mileage Termination (fixed) rate will apply.

GENERAL EXCHANGE TARIFF

Embarq Florida, Inc.

BY: F. B. Poag  
Director

SECTION A21  
First Revised Sheet 18  
Cancelling Original Sheet 18  
Effective: January 6, 2003

LINK SERVICES

A. LINK SERVICES (Cont'd)

5. RATE CATEGORIES (Cont'd)

g. Optional Features and Functions - Applicable to TransLink and LightLink Service

Optional Features and Functions may be added to improve the quality or utility to meet the customer's specific communications requirements. These are not necessarily identifiable with specific equipment, but rather represent the end result in terms of performance characteristics, which may be obtained. These characteristics may be obtained by using various combinations of equipment. Optional Features and Functions that are available include the following:

(1) Central Office Multiplexing

DS3 to DS1 - An arrangement that converts a 44.736 Mbps channel to 28 DS1 channels using digital time division multiplexing. Central Office Multiplexing is not available at the customer's premises.

DS1 to DS0 - An arrangement that converts a 1.544 Mbps channel to 24 64.0 Kbps channels utilizing digital time division multiplexing. Central Office Multiplexing is not available at the customer's premises.

(2) Clear Channel Capability (CCC)

Clear Channel Capability (CCC) is an arrangement that alters a DS1/1.544 Mbps signal with unconstrained information bits to meet pulse density requirements outlined in Technical Reference Publications GR-54 and GR-342. This will allow a customer to transport an all zero octet over a DS1/1.544 Mbps channel providing an available combined maximum 1.536 Mbps data rate. This arrangement requires the customer signal at the channel interface to conform to Bipolar with 8 Zero Substitution (B8ZS) line code as described in Technical Reference Publications GR-54 and GR-342.

CCC is provided on DS1/1.544 Mbps channels of a TransLink and LightLink Service facility between two customer designated premises and is subject to the availability of facilities. This optional feature may be ordered at the same time the TransLink and LightLink Service channel is ordered, or it may be ordered as an additional feature of an existing TransLink and LightLink Service channel.

GENERAL EXCHANGE TARIFF

Embarq Florida, Inc.

BY: F. B. Poag  
Director

SECTION A21  
First Revised Sheet 19  
Cancelling Original Sheet 19  
Effective: January 6, 2003

LINK SERVICES

A. LINK SERVICES (Cont'd)

5. RATE CATEGORIES (Cont'd)

g. Optional Features and Functions - Applicable to TransLink and LightLink Service (Cont'd)

(3) Extended Superframe Format (ESF)

The ESF optional feature is available at suitably equipped end offices, and passes a customer provided framing format for 1.544 Mbps service. ESF extends the customer's 1.544 Mbps framing structure from twelve (12) to twenty-four (24) frames and divides the 8 Kbps 193rd bit position pattern into three distinct functionalities: 2 Kbps for frame synchronization, 2 Kbps for cyclic redundancy checking, and 4 Kbps used primarily for performance monitoring information.

(4) Multiplexed Service Connection

For TransLink Service, a Multiplexed Service Connection is an arrangement that allows one DS0 channel of a multiplexed Company service to be connected to one DS0 channel with like signaling of another Company service. A Multiplexed Service Connection will be provided at all Company locations where Central Office Multiplexing is performed.

For LightLink Service, a Multiplexed Service Connection is an arrangement that allows one DS1 channel of a multiplexed Company service to be connected to one DS1 channel with like signaling of another Company service. For example, the lesser speed may be an ISDN-PRI DS1 channel connected between a multiplexed DS3 service. A Multiplexed Service Connection will be provided at all Company locations where Central Office Multiplexing is performed.

## GENERAL EXCHANGE TARIFF

Embarq Florida, Inc.

BY: F. B. Poag  
Director

SECTION A21  
First Revised Sheet 20  
Cancelling Original Sheet 20  
Effective: January 6, 2003

### LINK SERVICES

#### A. LINK SERVICES (Cont'd)

##### 6. APPLICATION OF RATES

###### DIGILINK SERVICE

- a. Each DigiLink Service facility may be comprised of two or more Channel Terminations. Where both customer premises are served by the same Serving Wire Center, the service will consist of two or more Channel Terminations. Where each customer premises is served by different Serving Wire Centers, the service will consist of two or more Channel Terminations, one Channel Mileage Termination (fixed) and the Channel Mileage Facility (per mile) between Serving Wire Centers and/or hub(s).
- b. Intraexchange channels furnished between Company central offices will be charged at rates based on airline distance between the central offices. Interexchange channels will be charged at rates based on airline distance between Company central offices. Fractional mileage will be rounded up to the next full mile. The mileage measurement is determined by utilizing exchange maps and mileage tables located in designated Company offices for such purposes.
- c. Whenever facilities are provided jointly by the Company and another telephone company, the regulations, rates and charges of the other telephone company shall apply for the equipment and facilities furnished by the other telephone company for use in connection with DigiLink Service. The Company applies a 50% billing percentage to the Channel Mileage Termination (fixed) rate on jointly owned circuits, and applies 100% on wholly owned circuits. When the Channel Mileage Facility (per mile) is zero (i.e., collocated Serving Wire Centers), neither the Channel Mileage Facility (per mile) rate nor the Channel Mileage Termination (fixed) rate will apply.
- d. Data Amplification provides for data transmission when the customer is located beyond the normal range for high speed digital data service. Local channel terminations greater than five (5) cable route miles in length for 19.2 Kbps service or three (3) miles in length for 56 Kbps and 64 Kbps service may require circuit repeaters and associated equipment be installed to regenerate the digital signal in order for accurate and acceptable data transmission to occur. The distances given are an indication of the potential requirement for Data Amplification. The actual distance is dependent on decibel (db) loss and not just physical loop length and is a function of the specific Company cable between the serving wire center and the customer's location. Applications requiring Data Amplification may also require special construction charges, Charges Applicable Under Special Conditions, as specified in Section A5 of this tariff.
- e. One Central Office Bridging Capability charge applies per port. When more than one Serving Wire Center is involved, the origin of the bridge(s) will dictate if there are additional interoffice transport charges (i.e., Channel Mileage Facility, Per Mileage). Refer to diagrams in A.2.a.(11) preceding.

GENERAL EXCHANGE TARIFF

Embarq Florida, Inc.

BY: F. B. Poag  
Director

SECTION A21  
First Revised Sheet 21  
Cancelling Original Sheet 21  
Effective: January 6, 2003

LINK SERVICES

A. LINK SERVICES (Cont'd)

6. APPLICATION OF RATES (Cont'd)

TRANSLINK SERVICE

- f. Each TransLink Service facility is comprised of two Channel Terminations. Where both customer premises are served by the same Serving Wire Center, the service will consist of two Channel Terminations. Where each customer premises is served by different Serving Wire Centers, the service will consist of two Channel Terminations, one Channel Mileage Termination (fixed) and the Channel Mileage Facility (per mile) between Serving Wire Centers and/or hub(s).
- g. Intraexchange channels furnished between Company central offices will be charged at rates based on airline distance between the central offices. Interexchange channels will be charged at rates based on airline distance between Company central offices. Fractional mileage will be rounded up to the next full mile. The mileage measurement is determined by utilizing exchange maps and mileage tables located in designated Company offices for such purposes.
- h. Whenever facilities are provided jointly by the Company and another telephone company, the regulations, rates and charges of the other telephone company shall apply for the equipment and facilities furnished by the other telephone company for use in connection with TransLink Service. The Company applies a 50% billing percentage to the Channel Mileage Termination (fixed) rate on jointly owned circuits, and applies 100% on wholly owned circuits. When the Channel Mileage Facility (per mile) is zero (i.e., collocated Serving Wire Centers), neither the Channel Mileage Facility (per mile) rate nor the Channel Mileage Termination (fixed) rate will apply.

## GENERAL EXCHANGE TARIFF

Embarq Florida, Inc.

BY: F. B. Poag  
Director

SECTION A21  
First Revised Sheet 22  
Cancelling Original Sheet 22  
Effective: January 6, 2003

### LINK SERVICES

#### A. LINK SERVICES (Cont'd)

##### 6. APPLICATION OF RATES (Cont'd)

##### LIGHTLINK SERVICE

- i. Each LightLink Service facility may be comprised of one or two Channel Terminations. Where both customer premises are served by the same Serving Wire Center, the service will consist of two Channel Terminations. Where each customer premises is served by different Serving Wire Centers, the service will consist of two Channel Terminations, one Channel Mileage Termination (fixed) and the Channel Mileage Facility (per mile) between Serving Wire Centers and/or hub(s). Where one customer premises is involved, the Channel Termination of a lower bandwidth service can be replaced with a LightLink Service Channel Termination. For example, the Channel Termination associated with ISDN-PRI Service, referred to as an ISDN-PRI Primary Rate Access Line, can be replaced with a LightLink Service Channel Termination to connect the ISDN-PRI Service to the Serving Wire Center of the customer's designated premises.
- j. The Channel Termination rate element for LightLink Service will vary based on distance. The mileage used to determine the monthly rate for Channel Terminations located outside a Company central office is the airline distance between the customer's designated premises and the Company's Serving Wire Center. The mileage measurement is determined by utilizing exchange maps and mileage tables located in designated Company offices for such purposes.
- k. Intraexchange channels furnished between Company central offices will be charged at rates based on airline distance between the central offices. Interexchange channels will be charged at rates based on airline distance between Company central offices. Fractional mileage will be rounded up to the next full mile.
- l. Whenever facilities are provided jointly by the Company and another telephone company, the regulations, rates and charges of the other telephone company shall apply for the equipment and facilities furnished by the other telephone company for use in connection with LightLink Service. The Company applies a 50% billing percentage to the Channel Mileage Termination (fixed) rate on jointly owned circuits, and applies 100% on wholly owned circuits. When the Channel Mileage Facility (per mile) is zero (i.e., collocated Serving Wire Centers), neither the Channel Mileage Facility (per mile) rate nor the Channel Mileage Termination (fixed) rate will apply.



GENERAL EXCHANGE TARIFF

Embarq Florida, Inc.

BY: F. B. Poag  
Director

SECTION A21  
First Revised Sheet 23  
Cancelling Original Sheet 23  
Effective: January 6, 2003

LINK SERVICES

A. LINK SERVICES (Cont'd)

7. RATES AND CHARGES

	<u>Monthly Rate</u>	<u>Nonrecurring Charge Installation</u>	<u>Nonrecurring Charge Rearrangement</u>
a. Channel Termination - DigiLink Service - Per Point of Termination			
19.2 Kbps			
Month to Month	\$75.00	\$250.00	\$150.00
12 - 23 Months	65.00	250.00	150.00
24 - 35 Months	60.00	250.00	150.00
36 - 59 Months	57.50	250.00	150.00
60 - 84 Months	55.00	250.00	150.00
56.0 Kbps, 64.0 Kbps			
Month to Month	\$80.00	\$250.00	\$150.00
12 - 23 Months	70.00	250.00	150.00
24 - 35 Months	65.00	250.00	150.00
36 - 59 Months	62.50	250.00	150.00
60 - 84 Months	60.00	250.00	150.00

GENERAL EXCHANGE TARIFF

Embarq Florida, Inc.

BY: F. B. Poag  
Director

SECTION A21  
Second Revised Sheet 24  
Cancelling First Revised Sheet 24  
Effective: May 5, 2004

LINK SERVICES

A. LINK SERVICES (Cont'd)

7. RATES AND CHARGES

	<u>Monthly Rate</u>	<u>Nonrecurring Charge Installation</u>	<u>Nonrecurring Charge Rearrangement</u>
a. Channel Termination - TransLink Service - Per Point of Termination			
Fractional DS1			
128 Kbps			
Month to Month	\$100.00	\$300.00	\$200.00
12 - 23 Months	95.00	300.00	200.00
24 - 35 Months	92.50	300.00	200.00
36 - 59 Months	90.00	300.00	200.00
60 - 84 Months	88.50	300.00	200.00
256 Kbps			
Month to Month	\$110.00	\$300.00	\$200.00
12 - 23 Months	105.00	300.00	200.00
24 - 35 Months	102.50	300.00	200.00
36 - 59 Months	100.00	300.00	200.00
60 - 84 Months	98.50	300.00	200.00
384 Kbps			
Month to Month	\$120.00	\$300.00	\$200.00
12 - 23 Months	115.00	300.00	200.00
24 - 35 Months	112.50	300.00	200.00
36 - 59 Months	110.00	300.00	200.00
60 - 84 Months	108.50	300.00	200.00
512 Kbps			
Month to Month	\$140.00	\$300.00	\$200.00
12 - 23 Months	135.00	300.00	200.00
24 - 35 Months	132.50	300.00	200.00
36 - 59 Months	130.00	300.00	200.00
60 - 84 Months	128.50	300.00	200.00
	<u>Monthly Rate</u>	<u>Nonrecurring Charge Installation</u>	<u>Nonrecurring Charge Rearrangement</u>
1.544 Mbps			
Month to Month	\$170.00	\$350.00	\$200.00
12 - 23 Months	155.00	350.00	200.00
24 - 35 Months	150.00	350.00	200.00
36 - 59 Months	147.50	350.00	200.00
60 - 84 Months	140.00	350.00	200.00

GENERAL EXCHANGE TARIFF

Embarq Florida, Inc.

BY: F. B. Poag  
Director

SECTION A21  
First Revised Sheet 25  
Cancelling Original Sheet 25  
Effective: January 6, 2003

LINK SERVICES

A. LINK SERVICES (Cont'd)

7. RATES AND CHARGES

	<u>Monthly Rate</u>	<u>Nonrecurring Charge Installation</u>	<u>Nonrecurring Charge Rearrangement</u>
a. Channel Termination - LightLink Service			
- Per Point of Termination			
44.736 Mbps			
Month to Month <sup>1</sup>			
Within CO	\$1,625.00	N/A	\$250.00
0-3 miles	1,775.00	N/A	250.00
Over 3 miles	1,975.00	N/A	250.00
12 - 23 Months			
Within CO	\$1,525.00	\$900.00	\$250.00
0-3 miles	1,675.00	900.00	250.00
Over 3 miles	1,875.00	900.00	250.00
24 - 35 Months			
Within CO	\$1,425.00	\$800.00	\$250.00
0-3 miles	1,575.00	850.00	250.00
Over 3 miles	1,775.00	850.00	250.00
36 - 59 Months			
Within CO	\$1,325.00	\$700.00	\$250.00
0-3 miles	1,475.00	800.00	250.00
Over 3 miles	1,675.00	800.00	250.00
60 - 84 Months			
Within CO	\$1,275.00	\$500.00	\$250.00
0-3 miles	1,375.00	600.00	250.00
Over 3 miles	1,575.00	600.00	250.00

<sup>1</sup>Month-to-month rates are available only after the expiration of one of the Term Discount Plans.

GENERAL EXCHANGE TARIFF

Embarq Florida, Inc.

BY: F. B. Poag  
Director

SECTION A21  
Second Revised Sheet 26  
Cancelling First Revised Sheet 26  
Effective: May 5, 2004

LINK SERVICES

A. LINK SERVICES (Cont'd)

7. RATES AND CHARGES (Cont'd)

	<u>Monthly Rate</u>	<u>Nonrecurring Charge</u>
b. Channel Mileage - DigiLink Service		
(1) Termination (Fixed) - Per Circuit		
19.2 Kbps, 56.0 Kbps, 64.0 Kbps		
Month to Month	\$38.00	\$0.00
12 - 23 Months	32.00	0.00
24 - 35 Months	31.00	0.00
36 - 59 Months	30.00	0.00
60 - 84 Months	29.00	0.00

GENERAL EXCHANGE TARIFF

Embarq Florida, Inc.

BY: F. B. Poag  
Director

SECTION A21  
First Revised Sheet 27  
Cancelling Original Sheet 27  
Effective: January 6, 2003

LINK SERVICES

A. LINK SERVICES (Cont'd)

7. RATES AND CHARGES (Cont'd)

Monthly Rate      Nonrecurring Charge

b. Channel Mileage - TransLink Service

(1) Termination (Fixed)  
- Per Circuit

128 Kbps, 256 Kbps, 384 Kbps, 512 Kbps, 1.544 Mbps

Month to Month	\$75.00	\$0.00
12 - 23 Months	70.00	0.00
24 - 35 Months	65.00	0.00
36 - 59 Months	60.00	0.00
60 - 84 Months	55.00	0.00

GENERAL EXCHANGE TARIFF

Embarq Florida, Inc.

BY: F. B. Poag  
Director

SECTION A21  
First Revised Sheet 28  
Cancelling Original Sheet 28  
Effective: January 6, 2003

LINK SERVICES

A. LINK SERVICES (Cont'd)

7. RATES AND CHARGES (Cont'd)

	<u>Monthly Rate</u>	<u>Nonrecurring Charge</u>
b. Channel Mileage - LightLink Service		
(1) Termination (Fixed) - Per Circuit		
44.736 Mbps Month to Month <sup>1</sup>	\$625.00	N/A
12 - 23 Months	600.00	\$0.00
24 - 35 Months	575.00	0.00
36 - 59 Months	550.00	0.00
60 - 84 Months	525.00	0.00

GENERAL EXCHANGE TARIFF

Embarq Florida, Inc.

BY: F. B. Poag  
Director

SECTION A21  
Second Revised Sheet 29  
Cancelling First Revised Sheet 29  
Effective: May 5, 2004

LINK SERVICES

A. LINK SERVICES (Cont'd)

7. RATES AND CHARGES (Cont'd)

	<u>Monthly Rate</u>	<u>Nonrecurring Charge</u>
b. Channel Mileage - DigiLink Service (Cont'd)		
(2) Facility (Per Mile)		
19.6 Kbps, 56.0 Kbps, 64.0 Kbps		
Month to Month	\$3.75	\$0.00
12 - 23 Months	3.00	0.00
24 - 35 Months	2.80	0.00
36 - 59 Months	2.60	0.00
60 - 84 Months	2.40	0.00

GENERAL EXCHANGE TARIFF

Embarq Florida, Inc.

BY: F. B. Poag  
Director

SECTION A21  
Second Revised Sheet 30  
Cancelling First Revised Sheet 30  
Effective: May 5, 2004

LINK SERVICES

A. LINK SERVICES (Cont'd)

7. RATES AND CHARGES (Cont'd)

	<u>Monthly Rate</u>	<u>Nonrecurring Charge</u>
b. Channel Mileage - TransLink Service (Cont'd)		
(2) Facility (Per Mile)		
128 Kbps, 256 Kbps, 384 Kbps, 512 Kbps, 1.544 Mbps		
Month to Month	\$24.50	\$0.00
12 - 23 Months	20.00	0.00
24 - 35 Months	18.00	0.00
36 - 59 Months	16.00	0.00
60 - 84 Months	14.00	0.00



GENERAL EXCHANGE TARIFF

Embarq Florida, Inc.

BY: F. B. Poag  
Director

SECTION A21  
First Revised Sheet 31  
Cancelling Original Sheet 31  
Effective: January 6, 2003

LINK SERVICES

A. LINK SERVICES (Cont'd)

7. RATES AND CHARGES (Cont'd)

	<u>Monthly Rate</u>	<u>Nonrecurring Charge</u>
b. Channel Mileage - LightLink Service (Cont'd)		
(2) Facility (Per Mile)		
44.736 Mbps Month to Month <sup>1</sup>	\$195.00	N/A
12 - 23 Months	185.00	\$0.00
24 - 35 Months	165.00	0.00
36 - 59 Months	145.00	0.00
60 - 84 Months	125.00	0.00

<sup>1</sup>Month-to-month rates are available only after the expiration of one of the Term Discount Plans.

GENERAL EXCHANGE TARIFF

Embarq Florida, Inc.

BY: F. B. Poag  
Director

SECTION A21  
First Revised Sheet 32  
Cancelling Original Sheet 32  
Effective: January 6, 2003

LINK SERVICES

A. LINK SERVICES (Cont'd)

7. RATES AND CHARGES (Cont'd)

		<u>Monthly Rate</u>	<u>Nonrecurring Charge</u>
c. Optional Features and Functions – TransLink Service			
(1)	Central Office Multiplexing DS1 to DS0 - Per Arrangement		
	Month to Month	\$375.00	\$100.00
	12 – 23 Months	325.00	100.00
	24 – 35 Months	300.00	100.00
	36 – 59 Months	275.00	100.00
	60 – 84 Months	250.00	100.00
(2)	Clear Channel Capability (CCC) - Per Channel Termination	\$0.00	\$275.00
(3)	Extended Superframe Format (ESF) - Per Channel Termination	N/A	N/A
(4)	Multiplexed Service Connection - Per DS0	\$8.00	\$100.00

GENERAL EXCHANGE TARIFF

Embarq Florida, Inc.

BY: F. B. Poag  
Director

SECTION A21  
First Revised Sheet 33  
Cancelling Original Sheet 33  
Effective: January 6, 2003

LINK SERVICES

A. LINK SERVICES (Cont'd)

7. RATES AND CHARGES (Cont'd)

	<u>Monthly Rate</u>	<u>Nonrecurring Charge</u>
c. Optional Features and Functions - LightLink Service		
(1) Central Office Multiplexing DS3 to DS1 - Per Arrangement		
Month to Month <sup>1</sup>	\$475.00	N/A
12 – 23 Months	475.00	\$250.00
24 – 35 Months	475.00	225.00
36 – 59 Months	475.00	200.00
60 – 84 Months	475.00	100.00
(2) Clear Channel Capability (CCC) - Per Channel Termination	\$0.00	\$275.00
(3) Multiplexed Service Connection - Per DS1	\$8.00	\$35.00

<sup>1</sup>Month-to-month rates are available only after the expiration of one of the Term Discount Plans.

GENERAL EXCHANGE TARIFF

Embarq Florida, Inc.

BY: F. B. Poag  
Director

SECTION A21  
First Revised Sheet 34  
Cancelling Original Sheet 34  
Effective: January 6, 2003

LINK SERVICES

A. LINK SERVICE (Cont'd)

7. RATES AND CHARGES (Cont'd)

	<u>Monthly Rate</u>	<u>Nonrecurring Charge</u>
d. Data Amplification <sup>2</sup> - Per Repeater	\$85.00	\$100.00
e. Central Office Bridging Capability <sup>2</sup> - Per Port		
19.2 Kbps, 56.0 Kbps, 64.0 Kbps		
Month to Month	\$25.00	\$100.00
12 - 23 Months	22.00	100.00
24 - 35 Months	20.00	100.00
36 - 59 Months	18.00	100.00
60 - 84 Months	16.00	100.00

<sup>2</sup>Circuit Repeater and Central Office Bridging Capability only apply to DigiLink Service

GENERAL EXCHANGE TARIFF

Embarq Florida, Inc.

BY: F. B. Poag  
Director

SECTION A21  
Second Revised Sheet 35  
Cancelling First Revised Sheet 35  
Effective: November 11, 2003

LINK SERVICES

A. LINK SERVICES (Cont'd)

7. RATES AND CHARGES (Cont'd)

f. Nonrecurring Charge

The Installation Nonrecurring Charge is applicable for the initial installation of a Channel Termination to a given Serving Wire Center. The Rearrangement Nonrecurring Charge is applicable for any rearrangement of an existing Channel Termination.

g. Move Charges

A Move Charge applies for Channel Terminations moved to a new location, even when moved on the same premises. The Move Charge is equal to the Channel Termination Installation Nonrecurring Charge and applies in addition to the Primary Service Ordering Charge located in Section A4 of this tariff.

h. Service Charges

A Primary Service Ordering Charge as set forth in Section A4 of this tariff is applicable per customer request. Nonrecurring Charges specified in this tariff section are in lieu of all other Service Ordering Charges.

GENERAL EXCHANGE TARIFF

Embarq Florida, Inc.

Section A22

By: F.B. Poag  
Director

First Revised Contents Sheet 1  
Cancelling Original Contents Sheet 1  
Effective: January 1, 1997

LOCAL TELEPHONE SERVICE FOR STATE OF FLORIDA  
GOVERNMENTAL AGENCIES (CENTRAL TELEPHONE ONLY)

CONTENTS

	<u>SHEET</u>
A. GENERAL PROVISIONS.....	1
1. General.....	1
2. Service.....	1
3. Right of Ingress and Egress.....	1
4. Conduit and Terminal Boxes.....	2
5. Training.....	2
6. Definitions.....	2
B. DURATION AND TERMINATION.....	2
1. Duration.....	2
2. Termination.....	3
C. SERVICE AND CHARGES.....	3
1. Service Area.....	3
2. Additional Services.....	3
3. System Features.....	3
4. Legislative Appropriation.....	4
D. MISCELLANEOUS PROVISIONS.....	4
1. Maintenance and Repair.....	4
2. Limitation of Service.....	4
3. Indemnification.....	5
4. Transfer of Rights.....	5
5. Verbal Representation.....	5
6. Tariff References.....	5
7. Service Agreement Reference.....	6

GENERAL EXCHANGE TARIFF

Embarq Florida, Inc.

By: F.B. Poag  
Director

Section A22  
First Revised Contents Sheet 2  
Cancelling Original Contents Sheet 2  
Effective: January 1, 1997

LOCAL TELEPHONE SERVICE FOR STATE OF FLORIDA  
GOVERNMENTAL AGENCIES (CENTRAL TELEPHONE ONLY)

CONTENTS

	<u>SHEET</u>
E. RATES AND CHARGES .....	6
1. Access Lines and Trunks .....	6
2. Enhanced Features .....	8
3. Mileage Charges .....	18
4. Installation Charges .....	19
F. SYSTEM FEATURES .....	20
1. Type System.....	20
2. Service Standards .....	20
3. Features.....	20
G. TRUNK EQUIVALENCY FOR SUBSCRIBER LINE CHARGE (SLC) .....	23
1. General.....	23
2. Trunk Equivalency Table .....	23
H. DIGITAL CENTREX SERVICE - SPECIAL ACCESS (CENTRAL TELEPHONE ONLY).....	24
1. General.....	24
2. Rates and Charges.....	25

GENERAL EXCHANGE TARIFF

Embarq Florida, Inc.

By: F.B. Poag  
Director

Section A22  
First Revised Sheet 1  
Cancelling Original Sheet 1  
Effective: January 1, 1997

LOCAL TELEPHONE SERVICE FOR STATE OF FLORIDA  
GOVERNMENTAL AGENCIES (CENTRAL TELEPHONE ONLY)

A. GENERAL PROVISIONS

1. General

This section of the tariff covers the Service Agreement between Embarq Florida, Inc., (the Company) and the Division of Communications of the Department of Management Services of the State of Florida or successor agencies (the Customer or the State) for and in behalf of all state agencies in the Tallahassee exchange, and specifying the arrangement under which local telephone service is furnished to such state agencies. This tariff covers the central office switching and associated peripheral equipment.

2. Service

Service furnished the Customer under this tariff shall be for the exclusive use of the State of Florida, its agencies, their respective officials, employees and others as may be authorized by law. Any service furnished to other tenants or occupants of the premises of the Customer will be furnished under separate agreements between the Company and said tenants or occupants.

3. Right of Ingress and Egress

The Company, its duly authorized agents and employees, shall have the right, free of any rental or charge, of ingress and egress upon State property as may be required by the Company for the furnishing of services and equipment as required by this Section, and all right-of-way on State property as may be required by the Company for the furnishing of services and equipment as required by this Section of the tariff. All right-of-way on State property for distribution of communications facilities required by this tariff shall be furnished free of cost to the Company. Electrical current required to operate Company equipment located on the Customer's premises shall be furnished at no charge to the Company.



GENERAL EXCHANGE TARIFF

Embarq Florida, Inc.

By: F.B. Poag  
Director

Section A22  
First Revised Sheet 2  
Cancelling Original Sheet 2  
Effective: January 1, 1997

LOCAL TELEPHONE SERVICE FOR STATE OF FLORIDA  
GOVERNMENTAL AGENCIES (CENTRAL TELEPHONE ONLY)

A. GENERAL PROVISIONS (Cont'd)

4. Conduit and Terminal Boxes

All conduit, duct, moulding, and terminal boxes necessary on the Customer's premises shall be provided, installed, and maintained at the expense of the Customer. The premises property line is considered the point of connection for outside duct or conduit.

5. Training

The Company shall provide, at no additional cost, centrex access line feature training during the term of the Service Agreement. Terminal equipment training is covered in the Service Agreement.

6. Definitions

"Exchange", "exchange area", "premises" or "Customer Provided Communications Systems", "service charges", "initial nonrecurring charges (I.N.C.s)", and other terms shall have the same meaning as used by the Company in its other tariff sections.

B. DURATION AND TERMINATION

1. Duration

This tariff shall be in full force and effect for a period of seven years commencing on August 1, 1992. Upon completion of this term, this tariff shall remain in effect on a month-to-month basis until the Service Agreement is canceled in writing by either party. During the term of the Service Agreement, Section A22 of this Tariff shall not be changed unless by mutual agreement of the parties or as a result of a Florida Public Service Commission action taken after the commencement date of this Service Agreement.

GENERAL EXCHANGE TARIFF

Embarq Florida, Inc.

By: F.B. Poag  
Director

Section A22  
First Revised Sheet 3  
Cancelling Original Sheet 3  
Effective: January 1, 1997

LOCAL TELEPHONE SERVICE FOR STATE OF FLORIDA  
GOVERNMENTAL AGENCIES (CENTRAL TELEPHONE ONLY)

B. DURATION AND TERMINATION (Cont'd)

2. Termination

The Customer may terminate service covered by this tariff and the Service Agreement, before installation of the services is completed, by payment to the Company of all costs related to the service which have been incurred by the Company at the time of the termination.

C. SERVICE AND CHARGES

1. Service Area

The Company agrees to connect the system with the Company's central offices in Tallahassee, Florida by means of central office facilities and to furnish service in the Tallahassee exchange area.

2. Additional Services

Additional equipment and services ordered after the effective date of the Service Agreement shall be furnished at rates and charges to be determined at the time the additional services and equipment are ordered.

3. System Features

Service furnished to the Customer by the Company shall consist of a system with options and features as listed in A22.F of this tariff. This tariff covers switching equipment only, telephone instruments and/or other terminal equipment may be provided under a separate contract or agreement. The rates contained in this tariff do not include any applicable taxes, including but not limited to, the Florida Gross Receipts Tax.

GENERAL EXCHANGE TARIFF

Embarq Florida, Inc.

By: F.B. Poag  
Director

Section A22  
First Revised Sheet 4  
Cancelling Original Sheet 4  
Effective: January 1, 1997

LOCAL TELEPHONE SERVICE FOR STATE OF FLORIDA  
GOVERNMENTAL AGENCIES (CENTRAL TELEPHONE ONLY)

C. SERVICE AND CHARGES (Cont'd)

4. Legislative Appropriation

The State of Florida's performance and obligation to pay under this contract is contingent upon an annual appropriation by the Legislature.

D. MISCELLANEOUS PROVISIONS

1. Maintenance of Repair

All ordinary expense of maintenance and repairs, unless otherwise specified in this tariff is borne by the Company. In case of damage, loss, theft, or destruction of any of the Company's property due to the negligence or willful act of the subscriber, and not due to ordinary wear and tear or causes beyond the control of the subscriber, the subscriber shall be required to pay the expense incurred by the Company in connection with the replacement of the property damaged, lost, stolen, or destroyed, or the expense incurred in restoring it to its original condition, subject to the limitations of Section 768.28, Florida Statutes (1985).

2. Limitation of Service

Service and equipment shall be provided on conditions agreed to by the Customer and the Company governing the manner and type of use by the Customer. The Customer is limited by statute, regulation and tariffs from using service or equipment illegally or to the detriment of other persons, the telephone network or the equipment itself.

GENERAL EXCHANGE TARIFF

Embarq Florida, Inc.

By: F.B. Poag  
Director

Section A22  
First Revised Sheet 5  
Cancelling Original Sheet 5  
Effective: January 1, 1997

LOCAL TELEPHONE SERVICE FOR STATE OF FLORIDA  
GOVERNMENTAL AGENCIES (CENTRAL TELEPHONE ONLY)

D. MISCELLANEOUS PROVISIONS (Cont'd)

3. Indemnification

The Company shall not be responsible to the Customer for any and all claims of third parties which arise from the provision, interruption, or use of service equipment or listings.

4. Transfer of Rights

The Customer shall not assign, transfer, pledge or hypothecate its rights hereunder without prior written consent of the Company.

5. Verbal Representation

The Customer agrees that no verbal representation of any salesman, agent, officer or employee of the Company shall operate to vary the written terms hereof.

6. Tariff References

References made to other specific tariff sections and sheets refer to the reference location in effect on the date the Service Agreement was signed.

Tariff reference locations may be subsequently changed due to format or content changes approved by the Florida Public Service Commission.

GENERAL EXCHANGE TARIFF

Embarq Florida, Inc.

By: F.B. Poag  
Director

Section A22  
Second Revised Sheet 6  
Cancelling First Revised Sheet 6  
Effective: March 1, 2003

LOCAL TELEPHONE SERVICE FOR STATE OF FLORIDA  
GOVERNMENTAL AGENCIES (CENTRAL TELEPHONE ONLY)

D. MISCELLANEOUS PROVISIONS (Cont'd)

7. Service Agreement Reference

The Service Agreement between the State of Florida Department of Management Services and Embarq Florida, Inc., (Central Telephone Company of Florida), dated August 1, 1992, provides further detail regarding the terms and conditions of this tariff.

E. RATES AND CHARGES

1. Access Lines and Trunks	<u>Monthly Rate</u>
a. Access line, each <sup>1,2</sup> Basic line rate includes all classes of service. Does not include station or terminal equipment.	\$ 12.50
b. LEN line, each <sup>1,2</sup> (Line Equipment Number) Centrex Access line without a Primary Directory Number.	12.50

Note 1: Basic line/trunk rate includes SMDI features/functions, SMDI interface port, utilization of Centrex software numbers (telephone numbers in DMS-100/SL-100 programming which are not connected to a LEN or cable pair). Basic line and trunk rates do not include the subscriber line charge.

Note 2: Monthly billing units for access lines, LEN lines and Access trunks combined will not be less than 16,000 for the duration of the Service Agreement.

GENERAL EXCHANGE TARIFF

Embarq Florida, Inc.

By: F.B. Poag  
Director

Section A22  
Second Revised Sheet 7  
Cancelling First Revised Sheet 7  
Effective: March 1, 2003

LOCAL TELEPHONE SERVICE FOR STATE OF FLORIDA  
GOVERNMENTAL AGENCIES (CENTRAL TELEPHONE ONLY)

E. RATES AND CHARGES (Cont'd)

1. Access Lines and Trunks		<u>Monthly Rate</u>
c.	Access trunk, each <sup>1,2</sup> Basic trunk only, does include DID adder for numbers or terminations. DID numbers and terminations are shown in Section A11 of this tariff.	(Installed before 8/1/92) 25.00 (Installed on or after 8/1/92) 37.50

Note 1: Basic line/trunk rate includes SMDI features/functions, SMDI interface port, utilization of Centrex software numbers (telephone numbers in DMS-100/SL-100 programming which are not connected to a LEN or cable pair). Basic line and trunk rates do not include the subscriber line charge.

Note 2: Monthly billing units for access lines, LEN lines and Access trunks combined will not be less than 16,000 for the duration of the Service Agreement.

GENERAL EXCHANGE TARIFF

Embarq Florida, Inc.

By: F.B. Poag  
Director

Section A22  
First Revised Sheet 8  
Cancelling Original Sheet 8  
Effective: January 1, 1997

LOCAL TELEPHONE SERVICE FOR STATE OF FLORIDA  
GOVERNMENTAL AGENCIES (CENTRAL TELEPHONE ONLY)

D. RATE AND CHARGES (Cont'd)

2. Enhanced Features

These charges are in addition to the access line or trunk rate. Terminal equipment is not included.

	<u>Monthly Rate</u>
a. Voice Mail <sup>1</sup>	
Per Voice Mail Box	
(1-500 Boxes)	\$ 6.35
(501-750 Boxes)	5.08
(Above 750 Boxes)	3.63
b. Meridian Digital Centrex Business Set	1.50
c. Data Path - Central Office Line Card	2.15
d. Data Pooling	8.25

Note 1: As the number of voice mail boxes increases to the discounted rate, existing users will experience the rate reduction.

GENERAL EXCHANGE TARIFF

Embarq Florida, Inc.

By: F.B. Poag  
Director

Section A22  
First Revised Sheet 9  
Cancelling Original Sheet 9  
Effective: January 1, 1997

LOCAL TELEPHONE SERVICE FOR STATE OF FLORIDA  
GOVERNMENTAL AGENCIES (CENTRAL TELEPHONE ONLY)

E. RATES AND CHARGES (Cont'd)

2. Enhanced Features (Cont'd)

e. Automatic Call Distribution (ACD)

This feature provides incoming call distribution to the next available line. When all lines are busy the incoming call will be placed on hold, the customer will receive a message explaining all lines are busy, and when a line becomes free the call will be switched to the free line.

	<u>NRC</u>	<u>Monthly Rate</u>
1) ACD per access line equipped	--	\$ 1.50
2) ACD access port, each. One required for printer, one required for CRT. <sup>1</sup>	\$200.00	47.15
3) Generic Recorded Message, each	\$150.00	34.10

Note 1: Customer must provide printer or CRT.



GENERAL EXCHANGE TARIFF

Embarq Florida, Inc.

By: F.B. Poag  
Director

Section A22  
First Revised Sheet 10  
Cancelling Original Sheet 10  
Effective: January 1, 1997

LOCAL TELEPHONE SERVICE FOR STATE OF FLORIDA  
GOVERNMENTAL AGENCIES (CENTRAL TELEPHONE ONLY)

E. RATES AND CHARGES (Cont'd)

2. Enhanced Features (Cont'd)

f. UCD Queue-Status Lamp

When assigned to a Uniform Call Distribution (UCD) group, this option provides an indication at the customer's premises of how long the first call in the incoming call queue has been waiting for an agent.<sup>1</sup>

	Monthly <u>Rate</u>
Rate Per Lamp	\$ 2.05

g. Customer Specific Recorded Announcements

In offices equipped with the technology and capacity; digital recorded announcement machines may be utilized to program announcements for use in conjunction with such features as Uniform Call Distribution (UCD), Automatic Call Distribution (ACD), Enhanced UCD and Enhanced ACD. The rate is based on each "one-second" of announcement time and the Company reserves the right to limit the length of the announcement based upon available capacity. The subscriber is responsible for providing the desired announcement phraseology; however, the subscriber shall exclude from the message or announcement any matter the dissemination of which is prohibited by law, including, but not limited to, any communication which is prohibited by Section 365.161, Florida Statutes.

	<u>NRC</u>	Monthly <u>Rate</u>
Per Announcement Second	---	\$ 6.04

Note 1: Charges for a dedicated facility, as noted in Section A20, shall also apply.

GENERAL EXCHANGE TARIFF

Embarq Florida, Inc.

By: F.B. Poag  
Director

Section A22  
First Revised Sheet 11  
Cancelling Original Sheet 11  
Effective: January 1, 1997

LOCAL TELEPHONE SERVICE FOR STATE OF FLORIDA  
GOVERNMENTAL AGENCIES (CENTRAL TELEPHONE ONLY)

E. RATES AND CHARGES (Cont'd)

2. Enhanced Features (Cont'd)

h. Enhanced Automatic Call Distribution (ACD)

This ACD option provides the ACD user with Management Information System (MIS) and Load Management built-in features that provide real-time management information and full ACD operational control. This feature is offered under the conditions specified in A12.1.1.b.<sup>1</sup>

	<u>NRC</u>	<u>Monthly Rate</u>
a) Enhanced ACD per Access Line Equipped	---	\$ 8.50
b) Access Port (One Each Required Per Customer Group)	200.00	240.00
c) Generic Recorded Announcement, each	150.00	34.10

Note 1: Charges for a dedicated facility, as noted in Section A20 of this tariff, shall also apply.

GENERAL EXCHANGE TARIFF

Embarq Florida, Inc.

By: F.B. Poag  
Director

Section A22  
First Revised Sheet 12  
Cancelling Original Sheet 12  
Effective: January 1, 1997

LOCAL TELEPHONE SERVICE FOR STATE OF FLORIDA  
GOVERNMENTAL AGENCIES (CENTRAL TELEPHONE ONLY)

E. RATES AND CHARGES (Cont'd)

2. Enhanced Features (Cont'd)

i. Direct Station Selection/Busy Lamp Filed (DSS/BLF)

This feature adds new attendant console style functions to the MBS station by providing the MBS user the ability to monitor station status of a directory number (DN) through the use of MBS lamp states, and by providing direct dialing to a monitored DN by means of a feature key.

	<u>NPA - NXX</u>	<u>Monthly Rate</u>
DSS/BLF (Per station equipped, up to 500 stations)	904-599, 904-487 904-488, 904-922	\$ 9.05
DSS/BLF (Per station equipped, up to 40 stations)	904-833 <sup>1</sup>	11.05

Note 1: Initial feature installation date will be determined by the Company in conjunction with a scheduled BCS load.

GENERAL EXCHANGE TARIFF

Embarq Florida, Inc.

By: F.B. Poag  
Director

Section A22  
First Revised Sheet 13  
Cancelling Original Sheet 13  
Effective: January 1, 1997

LOCAL TELEPHONE SERVICE FOR STATE OF FLORIDA  
GOVERNMENTAL AGENCIES (CENTRAL TELEPHONE ONLY)

E. RATES AND CHARGES (Cont'd)

2. Enhanced Features (Cont'd)

j. Thirty Port Conference - Department of Transportation

This feature is provided for the use of the Department of Transportation and can accommodate up to thirty conferees. The feature is activated when the first caller dials a designated directory number at a specified time, establishes a connection, and is then joined by other callers from remote locations.

	<u>NRC</u>	<u>Monthly Rate</u>
Feature Rate	---	\$960.00

k. Call Controller<sup>1</sup>

Call Controller is a fully featured, multi-level automated attendant system. The caller utilizes Call Controller by listening to voice menus and entering telephone keypad responses. The Call Controller System has the ability to interface with telephone instruments, Voice Mail, and Voice Bulletin Boards.

Note 1: All non-recurring charges are in addition to the applicable service ordering charges contained in Section A4 of this Tariff. If additional cells are installed coincident with initial installation, the \$50 NRC does not apply. When multiple additional cells are installed on the same order, on the same due date, at the same location and on the same automated attendant, only one NRC of \$50 is applicable.

GENERAL EXCHANGE TARIFF

Embarq Florida, Inc.

By: F.B. Poag  
Director

Section A22  
Second Revised Sheet 14  
Cancelling First Revised Sheet 14  
Effective: July 1, 1997

LOCAL TELEPHONE SERVICE FOR STATE OF FLORIDA  
GOVERNMENTAL AGENCIES (CENTRAL TELEPHONE ONLY)

E. RATES AND CHARGES (Cont'd)

2. Enhanced Features (Cont'd)

k. Call Controller<sup>1</sup> (Cont'd)

Each automated attendant application must have port access to the Digital Sound Infomail System. Basic automated attendant service includes five primary programming options called "cells": Greeting/Defaults, Rerecord, Key Error, Tree Error, and Schedule/Transfer. Additional cells may be ordered to further refine the basic automated attendant service.

	<u>NRC</u>	<u>Monthly Rate</u>
1) Port Access, per Basic Automated Attendant	---	\$ 125.00
2) Basic Automated Attendant	\$150.00	50.00
3) Additional Cell, each	50.00	5.00

Note 1: All non-recurring charges are in addition to the applicable service ordering charges contained in Section A4 of this Tariff. If additional cells are installed coincident with initial installation, the \$50 NRC does not apply. When multiple additional cells are installed on the same order, on the same due date, at the same location and on the same automated attendant, only one NRC of \$50 is applicable.

GENERAL EXCHANGE TARIFF

Embarq Florida, Inc.

By: F.B. Poag  
Director

Section A22  
First Revised Sheet 15  
Cancelling Original Sheet 15  
Effective: January 1, 1997

LOCAL TELEPHONE SERVICE FOR STATE OF FLORIDA  
GOVERNMENTAL AGENCIES (CENTRAL TELEPHONE ONLY)

E. RATES AND CHARGES (Cont'd)

2. Enhanced Features (Cont'd)

I. Voice Forms<sup>1</sup>

This feature enables the subscriber to collect information from callers through a series of interactive prompts and either dialed or vocal responses by the caller. Callers may be directed to a Voice Form either by dialing a number directly or as a part of a Call Controller application as described in A22.E.2.k. of this tariff.

	<u>NRC</u>	<u>Monthly Rate</u>
Voice Form Application, each	---	\$ 10.90

m. Faxback Service

1. Faxback Service allows state agencies the assignment of a DID number which can be called to request a fax. Each assigned DID number may be configured as a stand-alone or tree configuration.
  - a) In the stand-alone configuration, one faxbox is assigned to each DID number. The faxbox contains a document. Callers will be able to dial the DID number and get a recording which will prompt them to enter their fax number. The system will then fax the document back to the caller.

Note 1: Service ordering charges contained in Section A4 of this tariff are also applicable.

GENERAL EXCHANGE TARIFF

Embarq Florida, Inc.

By: F.B. Poag  
Director

Section A22  
First Revised Sheet 16  
Cancelling Original Sheet 16  
Effective: January 1, 1997

LOCAL TELEPHONE SERVICE FOR STATE OF FLORIDA  
GOVERNMENTAL AGENCIES (CENTRAL TELEPHONE ONLY)

E. RATES AND CHARGES (Cont'd)

2. Enhanced Features (Cont'd)

m. Faxback Service (Cont'd)

- b) In a tree configuration, a DID number is assigned as a main greeting mailbox with multiple faxboxes assigned as options to be selected under the main greeting mailbox. Each faxbox option under a tree configuration is considered to be an individual faxbox containing a single document. Callers will dial the DID number, get a main greeting directing the caller to select from a series of options. Once an option is selected, the caller will be prompted to enter their fax number. The system will then fax the document back to the caller.
  - 2) Directory listings will not be provided with this service.
  - 3) The Company reserves the right to provide this service at its discretion.
  - 4) There are no standard service level guarantees on incoming or outgoing traffic associated with this service. In no event shall the Company be held liable for any losses or damages arising from the unavailability or failure of its equipment or facilities, or for any act, omission or failure of performance by the Company or its employees or agents in connection with this service.

GENERAL EXCHANGE TARIFF

Embarq Florida, Inc.

By: F.B. Poag  
Director

Section A22  
First Revised Sheet 17  
Cancelling Original Sheet 17  
Effective: January 1, 1997

LOCAL TELEPHONE SERVICE FOR STATE OF FLORIDA  
GOVERNMENTAL AGENCIES (CENTRAL TELEPHONE ONLY)

E. RATES AND CHARGES (Cont'd)

2. Enhanced Features (Cont'd)

m. Faxback Service (Cont'd)

5) If the service, at any time, unreasonably interferes with or impairs other services rendered to the public by the Company or other subscribers, the Company reserves the right to institute protective measures up to and including termination of the service.

6) Rates<sup>1</sup>

(a) Stand-alone Faxbox Configuration, per faxbox

	<u>Nonrecurring Charges</u>	<u>Recurring Charges</u>
2-5 pages, including cover	\$ 186.30	\$ 63.25
6-11 pages, including cover	194.75	79.70

(b) Tree Faxbox Configuration

2-5 pages, first faxbox	186.30	\$ 63.25
each additional faxbox		74.50

Note 1: Service ordering charges contained in Section A4 of this tariff are also applicable



GENERAL EXCHANGE TARIFF

Embarq Florida, Inc.

By: F.B. Poag  
Director

Section A22  
First Revised Sheet 18  
Cancelling Original Sheet 18  
Effective: January 1, 1997

LOCAL TELEPHONE SERVICE FOR STATE OF FLORIDA  
GOVERNMENTAL AGENCIES (CENTRAL TELEPHONE ONLY)

E. RATES AND CHARGES (Cont'd)

2. Enhanced Features (Cont'd)

m. Faxback Service (Cont'd)

6) Rates<sup>1</sup> (Cont'd)

(a) Stand-alone Faxbox Configuration, per faxbox (Cont'd)

	<u>Nonrecurring Charges</u>	<u>Recurring Charges</u>
(b) (Cont'd)		
6-11 pages, first faxbox	194.75	79.70
each additional faxbox		77.90
(c) Main greeting - 1 minute		9.95
Main greeting - 2 minutes		19.95

These rates do not include any long distance charges which may be applicable as a result of the use of this Faxback service.

3. Mileage Charges

- a. Mileage charges will not apply for access lines terminating within the Tallahassee exchange.

Note 1: Service ordering charges contained in Section A4 of this tariff are also applicable

GENERAL EXCHANGE TARIFF

Embarq Florida, Inc.

By: F.B. Poag  
Director

Section A22  
First Revised Sheet 19  
Cancelling Original Sheet 19  
Effective: January 1, 1997

LOCAL TELEPHONE SERVICE FOR STATE OF FLORIDA  
GOVERNMENTAL AGENCIES (CENTRAL TELEPHONE ONLY)

E. RATES AND CHARGES (Cont'd)

3. Mileage Charges (Cont'd)

- b. Extension mileage charges as shown in Section A13 of this tariff, will apply for extension stations located within the Tallahassee exchange but terminated in a different premises than the access line. Extension mileage charges may be revised by tariff changes approved by the Florida Public Service Commission.
- c. Foreign exchange mileage charges, as noted in Section A9 of this tariff, will apply for main stations located outside the Tallahassee exchange. Foreign exchange mileage rates may be revised by tariff changes approved by the Florida Public Service Commission.

4. Installation Charges

Regular installation charges as shown in Section A4 of this tariff, shall apply for the installation or relocation of access lines and trunks. Installation charges may be revised by tariff changes approved by the Florida Public Service Commission; however, installation charges will not apply for the addition of central office equipment required to increase the number of access lines.

GENERAL EXCHANGE TARIFF

Embarq Florida, Inc.

By: F.B. Poag  
Director

Section A22  
First Revised Sheet 20  
Cancelling Original Sheet 20  
Effective: January 1, 1997

LOCAL TELEPHONE SERVICE FOR STATE OF FLORIDA  
GOVERNMENTAL AGENCIES (CENTRAL TELEPHONE ONLY)

F. SYSTEM FEATURES

1. Type System

Service shall be provided by a Northern Telecom DMS-100 Digital Centrex System and shall have the capability to provide the features as listed below. The features listed in A22.F.3. following are included in the basic assess line or trunk rate.

The software feature package identifiers listed in A22.F.3. are in accordance with Northern Telecom feature descriptions, through BCS-32 Supplement, Issue 4, and are included as the basic features during the length of the Service Agreement. The Company will continue to update the basic feature packages through the Northern Telecom BCS software upgrade process (enhancements to existing features). New or future software features required by the State will be added in accordance with the Service Agreement between the State and the Company.

2. The system shall conform to service standards as defined by the Florida Public Service Commission rules and regulations.

3. Features

NTX100AA MDC Basic<sup>1</sup>  
NTX101AA MDC Enhanced Business Services  
NTX102AA MDC Station Message Detail Recording  
NTX103AA MDC Station Message Detail Recording Enhanced

Note 1: Fifty 6-port conference circuits are installed in the DMS-100 switch for use with all conference features.

GENERAL EXCHANGE TARIFF

Embarq Florida, Inc.

By: F.B. Poag  
Director

Section A22  
First Revised Sheet 21  
Cancelling Original Sheet 21  
Effective: January 1, 1997

LOCAL TELEPHONE SERVICE FOR STATE OF FLORIDA  
GOVERNMENTAL AGENCIES (CENTRAL TELEPHONE ONLY)

F. SYSTEM FEATURES (Cont'd)

3. Features (Cont'd)

NTX103BA	MDC Station - Specific Authorization Code
NTX105AA	MDC Trunk Queuing
NTX106AA	MDC Business Set Features
NTX108AA	MDC Business Set Display Features
NTX111AA	MDC Large Conference Features <sup>1</sup>
NTX112AB	MDC Virtual Facility Groups
NTX119AA	MDC Message Service
NTX250AA	MDC Basic Data Path
NTX251AA	MDC Modem Pooling
NTX260AA	MDC Preset Conference <sup>1</sup>
NTX262AA	MDC Priority Console Alerting
NTX407AB	MDC Automatic Call Distribution Call Processing Control
NTX413AA	MDC Enhanced Call Forwarding
NTX415AA	MDC Automatic Call Distribution Basic
NTX416AF	MDC Automatic Call Distribution Automatic
NTX431AA	MDC Cut-Through Dialing
NTX432AA	MDC Meridian Switched Network - Network Speed Calling
NTX433AA	MDC Time-Of-Day Routing
NTX434AA	MDC Meridian Switched Network - Class of Service (NCOS) Routing
NTX435AA	MDC Superset
NTX436AA	MDC Enhanced Dial Plan

GENERAL EXCHANGE TARIFF

Embarq Florida, Inc.

By: F.B. Poag  
Director

Section A22  
First Revised Sheet 22  
Cancelling Original Sheet 22  
Effective: January 1, 1997

LOCAL TELEPHONE SERVICE FOR STATE OF FLORIDA  
GOVERNMENTAL AGENCIES (CENTRAL TELEPHONE ONLY)

F. SYSTEM FEATURES (Cont'd)

3. Features (Cont'd)

NTX437AA	MDC Random Conditional Routing
NTX727AA	MDC Automatic Call Distribution - Load Management
NTX732AA	MDC Simplified Message Desk Interface (SMDI)
NTX820AA	MDC Enhanced Three-Way Calling
NTX824AB	MDC Enhanced Call Waiting
NTX857AA	MDC Call Forwarding Special
NTX878AB	MDC Enhanced Business Set Services
NTX898AA	MDC Variable Speed-Call Access Code
NTX946AB	MDC Calling Name Display
NTX991AC	MDC ACD-Management Reports - Two-Way Data Stream
NTXA27AA	MDC Executive Conference
NTXA35AA	MDC Network Number Display
NTXA52AB	MDC Automatic Call Distribution - Remote Load Management
NTXA77AA	MDC Enhanced Uniform Call Distribution (UCD)
NTXA80AA	MDC Network Name Display
NTXA84AA	MDC Meridian Business Set: Music On Hold
NTXE09AA	MDC Automatic Call Distribution 2500 Sets
NTXE46AA	MDC Calling Name/Number Delivery Blocking
NTXJ97AA	MDC Direct Station Selection/Busy Lamp Field For Meridian Sets

Note 1: Fifty 6-port conference circuits are installed in the DMS-100 switch for use with all conference features.

GENERAL EXCHANGE TARIFF

Embarq Florida, Inc.

By: F.B. Poag  
Director

Section A22  
Fourth Revised Sheet 23  
Cancelling Third Revised Sheet 23  
Effective: March 31, 1999

LOCAL TELEPHONE SERVICE FOR STATE OF FLORIDA  
GOVERNMENTAL AGENCIES (CENTRAL TELEPHONE ONLY)

G. TRUNK EQUIVALENCY FOR SUBSCRIBER LINE CHARGE (SLC)

1. General

In compliance with Section 4 of the Interstate Access Tariff for Digital Centrex Subscriber Line Charges (Central Telephone), but to achieve rates based on a trunk equivalency basis, the Customer's SLC will be adjusted to reflect the rates as shown in the Trunk Equivalency Table. The SLC is in addition to the monthly rate for the access line. In cases where the number of virtual trunks provided exceeds the equivalent number of trunks shown in the table for a customer's corresponding line quantity, the customer will be billed one SLC for each virtual trunk provided.

2. Trunk Equivalency Table for Subscriber Line Charge

<u>No. of Lines</u>	<u>No. of Trunks</u>	<u>Equivalent No. of SLC Charges*</u>	<u>Equivalent</u>
1		1	1
2-6		2	2
7-15		3	3
16-21		4	4
22-28		5	5
29-36		6	6
37-45		7	7
46-54		8	8
55-64		9	9
65-75		10	10
76-86		11	11
87-98		12	12
99-111		13	13
112-125		14	14

\*For rates, see End User Common Line Charges in Section 4 of the Interstate Access Tariff.

GENERAL EXCHANGE TARIFF

Embarq Florida, Inc.

By: F.B. Poag  
Director

Section A22  
Fourth Revised Sheet 24  
Cancelling Third Revised Sheet 24  
Effective: March 31, 1999

LOCAL TELEPHONE SERVICE FOR STATE OF FLORIDA  
GOVERNMENTAL AGENCIES (CENTRAL TELEPHONE ONLY)

G. TRUNK EQUIVALENCY FOR SUBSCRIBER LINE CHARGE (SLC)

2. Trunk Equivalency Table for Subscriber Line Charge

<u>No. of Lines</u>	<u>Equivalent No. of Trunks</u>	<u>Equivalent No. of SLC Charges*</u>
126-139	15	15
140-155	16	16
156-171	17	17
172-189	18	18
190-207	19	19
208-225	20	20
226-243	21	21
244-262	22	22
263-281	23	23
282-300	24	24
Each Add'l 15 Lines	+1	+1

H. DIGITAL CENTREX SERVICE - SPECIAL ACCESS (CENTRAL TELEPHONE)

1. General

- a) This service provides for the interconnection of Special Access and/or Private Line facilities to Embarq Florida, Inc.'s Digital Centrex Service for the State of Florida Governmental Agencies for the purpose of interfacing with subscribers to Digital Centrex service (Central Telephone) and users of Special Access and/or Private Line services.

\*For rates, see End User Common Line Charges in Section 4 of the Interstate Access Tariff.

GENERAL EXCHANGE TARIFF

Embarq Florida, Inc.

By: F.B. Poag  
Director

Section A22  
First Revised Sheet 25  
Cancelling Original Sheet 25  
Effective: January 1, 1997

LOCAL TELEPHONE SERVICE FOR STATE OF FLORIDA  
GOVERNMENTAL AGENCIES (CENTRAL TELEPHONE ONLY)

H. DIGITAL CENTREX SERVICE - SPECIAL ACCESS (CENTRAL TELEPHONE) (Cont'd)

1. General (Cont'd)

- b) This service is furnished subject to the availability of facilities and features from digital central office switching equipment located in a central office building owned or leased by the Company.
- c) The rates in Section A22.1.2 following are applicable to each Digital Centrex interconnection (Central Telephone). The Special Access and/or Private Line facility is not included in the interconnection charge.

2. Rates and Charges

	<u>NRC</u>	<u>Monthly Rate</u>
a) Voice Grade to Digital Centrex (Each Channel)	\$ 50.00	\$ 53.00
b) DS1 to Digital Centrex (Per 24 Channels)	200.00	315.00
c) DS1 to Digital Centrex to Digital PBX (Per 24 Channels)	300.00	570.00
d) DS1 to Digital Centrex Centrex to Analog PBX <sup>1</sup> (Per 24 Channels)	300.00	570.00

Note 1: When DS1 interface via Digital Centrex (Central Telephone) to an analog PBX is required, rates for D-4 channel equipment shown in Section A2.6 of this tariff shall also apply.



GENERAL EXCHANGE TARIFF

Embarq Florida, Inc.

By: F.B. Poag  
Director

SECTION A23  
Fifth Revised Contents Sheet 1  
Cancelling Fourth Revised Contents Sheet 1  
Effective: May 10, 2002

RESERVED FOR FUTURE USE

GENERAL EXCHANGE TARIFF

Embarq Florida, Inc.

By: F.B. Poag  
Director

SECTION A23  
Third Revised Sheet 1  
Cancelling Second Revised Sheet 1  
Effective: May 10, 2002

RESERVED FOR FUTURE USE

GENERAL EXCHANGE TARIFF

Embarq Florida, Inc.

By: F.B. Poag  
Director

SECTION A23  
Third Revised Sheet 2  
Cancelling Second Revised Sheet 2  
Effective: May 10, 2002

RESERVED FOR FUTURE USE

GENERAL EXCHANGE TARIFF

Embarq Florida, Inc.

By: F.B. Poag  
Director

SECTION A23  
Third Revised Sheet 3  
Cancelling Second Revised Sheet 3  
Effective: May 10, 2002

RESERVED FOR FUTURE USE

GENERAL EXCHANGE TARIFF

Embarq Florida, Inc.

By: F.B. Poag  
Director

SECTION A23  
Third Revised Sheet 4  
Cancelling Second Revised Sheet 4  
Effective: May 10, 2002

RESERVED FOR FUTURE USE

GENERAL EXCHANGE TARIFF

Embarq Florida, Inc.

By: F.B. Poag  
Director

SECTION A23  
Third Revised Sheet 5  
Cancelling Second Revised Sheet 5  
Effective: May 10, 2002

RESERVED FOR FUTURE USE

GENERAL EXCHANGE TARIFF

Embarq Florida, Inc.

By: F.B. Poag  
Director

SECTION A23  
Third Revised Sheet 6  
Cancelling Second Revised Sheet 6  
Effective: May 10, 2002

RESERVED FOR FUTURE USE

GENERAL EXCHANGE TARIFF

Embarq Florida, Inc.

By: F.B. Poag  
Director

SECTION A23  
Fourth Revised Sheet 7  
Cancelling Third Revised Sheet 7  
Effective: May 10, 2002

RESERVED FOR FUTURE USE



GENERAL EXCHANGE TARIFF

Embarq Florida, Inc.

By: F.B. Poag  
Director

SECTION A23  
Sixth Revised Sheet 8  
Cancelling Fifth Revised Sheet 8  
Effective: May 10, 2002

RESERVED FOR FUTURE USE

GENERAL EXCHANGE TARIFF

Embarq Florida, Inc.

By: F.B. Poag  
Director

SECTION A23  
Second Revised Sheet 8.1  
Cancelling First Revised Sheet 8.1  
Effective: May 10, 2002

RESERVED FOR FUTURE USE

GENERAL EXCHANGE TARIFF

Embarq Florida, Inc.

By: F.B. Poag  
Director

SECTION A23  
Third Revised Sheet 9  
Cancelling Second Revised Sheet 9  
Effective: May 10, 2002

RESERVED FOR FUTURE USE

GENERAL EXCHANGE TARIFF

Embarq Florida, Inc.

By: F.B. Poag  
Director

SECTION A23  
Third Revised Sheet 10  
Cancelling Second Revised Sheet 10  
Effective: May 10, 2002

RESERVED FOR FUTURE USE

GENERAL EXCHANGE TARIFF

Embarq Florida, Inc.

By: F.B. Poag  
Director

SECTION A23  
Fourth Revised Sheet 11  
Cancelling Third Revised Sheet 11  
Effective: May 10, 2002

RESERVED FOR FUTURE USE

GENERAL EXCHANGE TARIFF

Embarq Florida, Inc.

Section A24

By: F.B. Poag  
Director

Second Revised Contents Sheet 1  
Cancelling First Revised Contents Sheet 1  
Effective: July 31, 1997

LOCAL TELEPHONE SERVICE FOR FLORIDA STATE UNIVERSITY  
(CENTRAL TELEPHONE)

CONTENTS

	SHEET
A. GENERAL PROVISIONS.....	1
1) General .....	1
2) Service .....	1
3) Right of Ingress and Egress .....	1
4) Conduit and Terminal Boxes .....	2
5) Training .....	2
6) Definitions .....	2
B. DURATION AND TERMINATION .....	2
1) Duration .....	2
2) Service Availability.....	3
3) Termination .....	3
C. SERVICE AND CHARGES .....	3
1) Service Area .....	3
2) Additional Services .....	3
3) System Features .....	3
4) Legislative Appropriation .....	3.1
5) 311 Service .....	3.1
D. MISCELLANEOUS PROVISIONS .....	4
1) Maintenance and Repair .....	4
2) Limitations of Service .....	4
3) Indemnification .....	5
4) Transfer of Rights .....	5
5) Verbal Representation.....	5
6) Tariff References .....	5

GENERAL EXCHANGE TARIFF

Embarq Florida, Inc.

Section A24

By: F.B. Poag  
Director

First Revised Contents Sheet 2  
Cancelling Original Contents Sheet 2  
Effective: January 1, 1997

LOCAL TELEPHONE SERVICE FOR FLORIDA STATE UNIVERSITY  
(CENTRAL TELEPHONE)

CONTENTS

	SHEET
E. RATES.....	6
1) Access Lines.....	6
2) Mileage Charges .....	7
3) Installation Charges.....	8
F. SYSTEM FEATURES .....	8
1. Type System.....	8
2. Service Standards .....	10
3. Features .....	11
4. Rates .....	21
G. TRUNK EQUIVALENCY FOR SUBSCRIBER LINE CHARGE (SLC) .....	22
1. General .....	22
2. Trunk Equivalency Table for Subscriber Line Charge .....	22
H. SERVICE AREA .....	23
1. General .....	23
2. Description of Service Area .....	24
3. Map of Florida State University Service Area.....	25
I. DIGITAL CENTREX SERVICE - SPECIAL ACCESS (CENTRAL TELEPHONE).....	26
1. General .....	26
2. Rates and Charges.....	27

GENERAL EXCHANGE TARIFF

Embarq Florida, Inc.

By: F.B. Poag  
Director

Section A24  
Second Revised Sheet 1  
Cancelling First Revised Sheet 1  
Effective: July 31, 1997

LOCAL TELEPHONE SERVICE FOR FLORIDA STATE UNIVERSITY  
(CENTRAL TELEPHONE)

A. GENERAL PROVISIONS

1. General

This section of the tariff covers an Agreement (as amended, if necessary, to provide 311 Service) between Embarq Florida, Inc. (the Company) and Florida State University or its successor agencies (the Customer or the University) specifying the arrangement under which local telephone service is furnished to Florida State University.

2. Service

Service furnished the Customer under this tariff shall be for the exclusive use of the University, its agencies, their respective officials, employees and others as may be authorized by law (including 311 Service). Any service furnished to other tenants or occupants of the premises of the Customer will be furnished under separate Agreements between the Company and said tenants or occupants.

3. Right of Ingress and Egress

The Company, its duly authorized agents and employees, shall have the right of ingress and egress upon University property as may be required by the Company for the furnishing of services as required by this section, and all right of way on University property as may be required by the Company for the furnishing of services and equipment as required by this section of the tariff. All right of way on University property for distribution of communications facilities required by this tariff shall be furnished free of cost to the Company.



GENERAL EXCHANGE TARIFF

Embarq Florida, Inc.

By: F.B. Poag  
Director

Section A24  
Second Revised Sheet 2  
Cancelling First Revised Sheet 2  
Effective: July 31, 1997

LOCAL TELEPHONE SERVICE FOR FLORIDA STATE UNIVERSITY  
(CENTRAL TELEPHONE)

A. GENERAL PROVISIONS (Cont'd)

4. Conduit and Terminal Boxes

All conduit, duct, molding, and terminal boxes necessary on the Customer's premises shall be provided, installed, and maintained at the expense of the Customer. The premises property line is considered the point of connection for outside duct or conduit.

5. Training

The Company shall provide additional training for new system features. The customer, however, shall be solely responsible for all training associated with any aspect of implementation or operation of 311 Service. The Company shall have no responsibility whatsoever for the training of the customer or the end users of customer provided 311 Service.

6. Definitions

"Exchange", "exchange area", "premises" or "Customer provided communications systems", "service charges", "initial non recurring charges (I.N.C.s)", and other terms shall have the same meaning as used by the Company in its other tariff sections.

B. DURATION AND TERMINATION

1. Duration

This tariff shall be in full force and effect for a period of six years commencing July 1, 1994, or from the date of approval by the Florida Public Service Commission. Upon completion of this term, this tariff shall remain in effect on a month-to-month basis until the Memorandum of Understanding is cancelled in writing by either party. During the term of Agreement the tariff shall not be changed unless by mutual agreement of the parties or as a result of a Florida Public Service Commission action taken after the commencement date of this Service Agreement.

GENERAL EXCHANGE TARIFF

Embarq Florida, Inc.

By: F.B. Poag  
Director

Section A24  
First Revised Sheet 3  
Cancelling Original Sheet 3  
Effective: January 1, 1997

LOCAL TELEPHONE SERVICE FOR FLORIDA STATE UNIVERSITY  
(CENTRAL TELEPHONE)

B. DURATION AND TERMINATION (Cont'd)

2. Service Availability

The Company agrees to provide the basic service and enhanced services as listed in paragraph A24.F.1 of this tariff as they become available from the manufacturer.

3. Termination

The Customer may terminate service covered by this tariff before installation of the services is completed, by payment to the Company of all costs related to the service which have been incurred by the Company at the time of the termination.

C. SERVICE AND CHARGES

1. Service Area

The Company agrees to connect the system with the Company's central offices in Tallahassee, Florida by means of central office facilities and to furnish service in the Tallahassee exchange area.

2. Additional Services

Additional equipment and services ordered after the effective date of the service agreement shall be furnished at rates and charges to be determined at the time the additional services and equipment are ordered.

3. System Features

Service furnished to the Customer by the Company shall consist of a system with options and features as those defined in paragraph A24.F.1 of this tariff.

GENERAL EXCHANGE TARIFF

Embarq Florida, Inc.

By: F.B. Poag  
Director

Section A24  
First Revised Sheet 3.1  
Cancelling Original Sheet 3.1  
Effective: July 31, 1997

LOCAL TELEPHONE SERVICE FOR FLORIDA STATE UNIVERSITY  
(CENTRAL TELEPHONE)

C. SERVICES AND CHARGES (Cont'd)

4. Legislative Appropriation

The University's performance and obligation to pay under this contract is contingent upon an annual appropriation by the Legislature.

5. 311 Service

- a. The Company shall furnish the capability of all 644 and 853 telephone numbers served under this section and located in the 311 Service Area as defined in A24 H.3. following to dial 311, and through appropriate translations, to reach the designated answering point within the Florida State University Police Station.
- b. The service shall be provided in accordance with FCC Order Number 97-51, issued February 19, 1997. Responsibility for compliance with the requirements of Order 97-51 shall be solely the customers. Continuing availability of the service for the customer's use shall be subject to Florida Public Service Commission determination, in the event a conflict arises with another jurisdiction entitled to use of the 311 code under Order 97-51.
- c. The Company has no responsibility to provide 311 Service for calls originating from a CMRS provider (as defined in 47 CFR 20.3).
- d. The Company's responsibility to provide 311 Service through pay telephone calls placed within the 311 Service areas shall be limited to providing the appropriate Centrex translations for lines serving such payphones.

GENERAL EXCHANGE TARIFF

Embarq Florida, Inc.

By: F.B. Poag  
Director

Section A24  
First Revised Sheet 3.2  
Cancelling Original Sheet 3.2  
Effective: July 31, 1997

LOCAL TELEPHONE SERVICE FOR FLORIDA STATE UNIVERSITY  
(CENTRAL TELEPHONE)

C. SERVICES AND CHARGES (Cont'd)

5. 311 Service (Cont'd)

- e. The Company will have no responsibility for the delivery of Automatic Number Identification (ANI), Automatic Location Identification (ALI), or Calling Party Number (CPN) as part of the provision of 311 Service. The Company will have no responsibility for any regulatory compliance associated with the delivery or blocking of CPN.
- f. The service is furnished to municipalities and other governmental agencies only for the purpose of voice reporting events by the public in accordance with FCC Order 97-51.
- g. This service is offered solely as an aid in handling non-emergency assistance calls in accordance with FCC Order Number 97-51 and does not create any relationship or obligation, direct or indirect, to any person other than the customer contracting for 311 Service. In the event of any interruption of the service, the Company shall not be liable to any person, corporation or other entity for any loss or damage in an amount greater than an amount equal to the pro rata allowance of the tariff rate for the service or facilities provided to the customer for the time such interruption continues, after notice to the Company. No allowance shall be made if the interruption is due to the negligence or willful act of the customer of the service.

GENERAL EXCHANGE TARIFF

Embarq Florida, Inc.

Section A24

By: F.B. Poag  
Director

First Revised Sheet 3.3  
Cancelling Original Sheet 3.3  
Effective: July 24, 1997

LOCAL TELEPHONE SERVICE FOR FLORIDA STATE UNIVERSITY  
(CENTRAL TELEPHONE)

C. SERVICES AND CHARGES (Cont'd)

5. 311 Service (Cont'd)

g. (Cont'd)

Further, the customer agrees to release, indemnify, defend, and hold harmless the Company from any and all loss, claims, demands, suits or other action, or any liability whatsoever, whether suffered, made, instituted or asserted by the customer or by any other party or person, for any personal injury to or death of any person or persons, or for any loss, damage or destruction of any property, whether owned by the customer or others, or for any infringement or invasion of the right of privacy of any person or persons, caused or claimed to have been caused, directly or indirectly, by the installation, operation, failure to operate, maintenance, removal, presence, condition, location or use of 311 Service features and the equipment associated therewith or by any services which are or may be furnished by the Company in connection therewith, including but not limited to the identification of the telephone number, address or name associated with the telephone used by the party or parties accessing 311 Service hereunder, and which arise out of the negligence or other wrongful act of the Company, the customer, its user agencies or employees or agents of any one of them.

GENERAL EXCHANGE TARIFF

Embarq Florida, Inc.

By: F.B. Poag  
Director

Section A24  
First Revised Sheet 3.4  
Cancelling Original Sheet 3.4  
Effective: July 31, 1997

LOCAL TELEPHONE SERVICE FOR FLORIDA STATE UNIVERSITY  
(CENTRAL TELEPHONE)

C. SERVICES AND CHARGES (Cont'd)

5. 311 Service (Cont'd)

- h. The provision of 311 Service does not contemplate the constant monitoring or inspection of facilities to discover errors, defects, and malfunctions in the service, nor does the Company undertake such responsibility. The customer shall make such operational tests as, in the judgment of the customer, are required to determine whether the system is functioning properly for its use. The customer shall be responsible for determining whether facilities are adequate to handle the volume of calls received and for the ordering of any additional facilities or services under this tariff or elsewhere.
- i. The Company's entire liability to any person for interruption or failure of 311 Service shall be limited to the terms set forth in this section and other sections of this Tariff.
- j. Where a 311 call is placed by the calling party via interconnection with a carrier other than the Company, the Company cannot guarantee the completion of said 311 call, the quality of the call or any features that may otherwise be provided with 311 Service.

GENERAL EXCHANGE TARIFF

Embarq Florida, Inc.

By: F.B. Poag  
Director

Section A24  
First Revised Sheet 4  
Cancelling Original Sheet 4  
Effective: July 31, 1997

LOCAL TELEPHONE SERVICE FOR FLORIDA STATE UNIVERSITY  
(CENTRAL TELEPHONE)

D. MISCELLANEOUS PROVISIONS

1. Maintenance and Repair

All ordinary expense of maintenance and repairs of the system, unless otherwise specified in this tariff is borne by the Company. In case of damage, loss, theft, or destruction of any of the Company's property due to the negligence or willful act of the subscriber, and not due to ordinary wear and tear or causes beyond the control of the subscriber, the subscriber shall be required to pay the expense incurred by the Company in connection with the replacement of the property damaged, lost, stolen, or destroyed, or the expense incurred in restoring it to its original condition, subject to the limitations of Section 768.28, Florida Statutes (1985).

2. Limitations of Service

Service shall be provided on conditions agreed to by the Customer and the Company governing the manner and type of use by the Customer. The Customer is limited by statute, regulation and tariffs from using service or equipment illegally or to the detriment of other persons, the telephone network or the equipment itself.

GENERAL EXCHANGE TARIFF

Embarq Florida, Inc.

By: F.B. Poag  
Director

Section A24  
First Revised Sheet 5  
Cancelling Original Sheet 5  
Effective: January 1, 1997

LOCAL TELEPHONE SERVICE FOR FLORIDA STATE UNIVERSITY  
(CENTRAL TELEPHONE)

D. MISCELLANEOUS PROVISIONS (Cont'd)

3. Indemnification

The Company shall not be responsible to the Customer for any and all claims of third parties which arise from the provision, interruption, or use of service equipment or listings.

4. Transfer of Rights

The Customer shall not assign, transfer, pledge or hypothecate its rights hereunder without prior written consent of the Company.

5. Verbal Representation

The Customer agrees that no verbal representation of any salesman, agent, officer or employee of the Company shall operate to vary the written terms hereof.

6. Tariff References

References made to other specific tariff sections and sheets refer to those in effect on the date the Agreement was signed for this section.

Reference locations may be subsequently changed due to format or content changes approved by the Florida Public Service Commission.



GENERAL EXCHANGE TARIFF

Embarq Florida, Inc.

By: F.B. Poag  
Director

Section A24  
First Revised Sheet 6  
Cancelling Original Sheet 6  
Effective: January 1, 1997

LOCAL TELEPHONE SERVICE FOR FLORIDA STATE UNIVERSITY  
(CENTRAL TELEPHONE)

E. RATES AND CHARGES

1. Access Lines	<u>Monthly Rate</u>
a. Access line, each	\$ 12.44
b. LEN line, each (Line Equipment Number)	12.44
c. Access trunk, each Basic trunk only, does not include Digital Centrex (Central Telephone) features. Does not include DID adder for numbers or terminations. DID numbers and terminations are shown in Section A11.2.2.d. (1207-ACCTRKFSU)	37.32

Note: The University will subscribe to a minimum of 7,200 access lines.

- d. Enhanced features will be provided on a per line basis at a rate to be determined when the University orders the feature.

Note: Basic line/trunk rate includes SMDI features/-functions, SMDI interface port, utilization of Centrex software numbers (telephone numbers in SL-100 programming which are not connected to a LEN or cable pair) and touch call capability. Basic line and trunk rates do not include the subscriber line charge.

GENERAL EXCHANGE TARIFF

Embarq Florida, Inc.

By: F.B. Poag  
Director

Section A24  
First Revised Sheet 7  
Cancelling Original Sheet 7  
Effective: January 1, 1997

LOCAL TELEPHONE SERVICE FOR FLORIDA STATE UNIVERSITY  
(CENTRAL TELEPHONE)

E. RATES AND CHARGES (Cont'd)

2. Mileage Charges

- a. Areas other than the main campus as defined in Section A24.H.1 of this tariff that are leased, rented, or purchased in the future and are not contiguous, but are served out of the same central office as the main campus, will be provided Centrex access line service, with no minimum number of Centrex access service lines required. An additional monthly charge of \$ 9.15, excluding applicable taxes and fees, will be added to the monthly Centrex access line rate for these locations. A site which requires a minimum of 75 lines will also be considered a part of the main campus, whether contiguous or not. The additional monthly charge of \$9.15 is not applicable to such locations. The Company will also provide Centrex Service, with no additional rate or mileage charges to Innovation Park (the farm).
- b. Foreign exchange mileage charges will apply for main stations located outside the Leon County Service Area. Foreign exchange mileage rates as shown in the General Customer Services Tariff Section A9, Sheet 2 shall apply. Foreign exchange mileage rates may be revised by tariff changes approved by the Florida Public Service Commission. The Company will also provide Centrex service, with no additional rate or mileage charges to those sites at Innovation Park (the farm) for users which are Florida State University's employees or agents.

GENERAL EXCHANGE TARIFF

Embarq Florida, Inc.

By: F.B. Poag  
Director

Section A24  
Second Revised Sheet 8  
Cancelling First Revised Sheet 8  
Effective: July 31, 1997

LOCAL TELEPHONE SERVICE FOR FLORIDA STATE UNIVERSITY  
(CENTRAL TELEPHONE)

E. RATES AND CHARGES (Cont'd)

3. Installation Charges

Regular installation charges as shown in Section A4 of this tariff, shall apply for the installation or relocation of access lines. Installation charges may be revised by tariff changes approved by the Florida Public Service Commission. Installation charges will not apply for the addition of central office equipment required to increase the number of access lines. The Company will bill one applicable service order charge (primary or secondary) per Communication Service Authorization (CSA)/Florida State University budget number. The budget number identifies the department receiving service. In addition, only one (1) premises visit charge will apply per trip to the campus area as defined in Section A24.H.1 of this tariff.

4. 311 Service

a. The provision and charges for 311 Service under this section are based on the unique circumstances of the Digital Centrex Service provided under this section.

b. Nonrecurring Charge \$95.00

F. SYSTEM FEATURES

1. Type System

Services shall be provided by a Northern Telecom digital multiplex system with applicable remote line modules configured to operate as an integrated system. Additional remote line modules may be provided as required at locations mutually agreeable to the University and the Company. The system will have the capability to provide the features as listed below. Features listed but not currently available will be provided as the features are made available by the manufacturer.

GENERAL EXCHANGE TARIFF

Embarq Florida, Inc.

Section A24

By: F.B. Poag  
Director

First Revised Sheet 9  
Cancelling Original Sheet 9  
Effective: January 1, 1997

LOCAL TELEPHONE SERVICE FOR FLORIDA STATE UNIVERSITY  
(CENTRAL TELEPHONE)

F. SYSTEM FEATURES (Cont'd)

1. Type System (Cont'd)

Features

NTX100AA	Basic
NTX101AA	Enhanced Business Services
NTX102AA	Station Message Detail Recording
NTX103AA	Station Message Detail Recording Enhanced
NTX103BA	Station-Specific Authorization Code
NTX105AA	Trunk Queuing
NTX106AA	Business Set Features
NTX108AA	Business Set Display Features
NTX111AA	Large Conference Features
NTX112AB	Virtual Facility Groups
NTX119AA	Message Service
NTX250AA	Basic Data Path
NTX251AA	Modern Pooling
NTX260AA	Preset Conference
NTX262AA	Priority Console Alerting
NTX407AB	Automatic Call Distribution Call Process Control
NTX413AA	Enhanced Call Forwarding
NTX415AA	Automatic Call Distribution Basic
NTX416AF	Automatic Call Distribution Automatic
NTX431AA	Cut-Through Dialing
NTX432AA	Switched Network-Network Speed Calling
NTX433AA	Time-of-Day Routing
NTX434AA	Time-of-Day Network - Class of Service (NCOS) Routing
NTX435AA	Three Way Calling
NTX436AA	Enhanced Dial Plan
NTX437AA	Random Conditional Routing
NTX727AA	Automatic Call Distribution
NTX732AA	Simplified Message Desk Interface (SMDI)

GENERAL EXCHANGE TARIFF

Embarq Florida, Inc.

By: F.B. Poag  
Director

Section A24  
First Revised Sheet 10  
Cancelling Original Sheet 10  
Effective: January 1, 1997

LOCAL TELEPHONE SERVICE FOR FLORIDA STATE UNIVERSITY  
(CENTRAL TELEPHONE)

F. SYSTEM FEATURES (Cont'd)

1. Type System (Cont'd)

Features (Cont'd)

NTX820AA	Enhanced Three-Way Calling
NTX824AB	Enhanced Call Waiting
NTX857AA	Call Forwarding Special
NTX878AB	Enhanced Business Set Services
NTX898AA	Variable Speed-Call Access Code
NTX946AB	Enhanced Set Services
NTX991AC	ACD-Management Reports
NTXA27AA	Executive Conference
NTXA35AA	Network Number Display
NTXA52AB	Automatic Call Distribution-Remote Load Management
NTXA77AA	Enhanced Uniform Call Distribution (UCD)
NTXA80AA	Network Name Display
NTXA84AA	Meridian Business Set: Music on Hold
NTXE09AA	Automatic Call Distribution 2500 Sets
NTXE46AA	Calling Name/Number Delivery Blocking
NTX197AA	Direct Station Selection/Busy Lamp Field

2. Service Standards

The system shall conform to service standards as defined by the Florida Public Service Commission rules and regulations.

GENERAL EXCHANGE TARIFF

Embarq Florida, Inc.

Section A24

By: F.B. Poag  
Director

First Revised Sheet 11  
Cancelling Original Sheet 11  
Effective: January 1, 1997

LOCAL TELEPHONE SERVICE FOR FLORIDA STATE UNIVERSITY  
(CENTRAL TELEPHONE)

F. SYSTEM FEATURES (Cont'd)

3. Features (Cont'd)

a. ATTENDANT FEATURES

ATTENDANT	ACCESS TO PAGING
ATTENDANT	AUTODIAL
ATTENDANT	CALL PARK RECALL TIMER
ATTENDANT	CALL SELECTION
ATTENDANT	CAMP-ON
ATTENDANT	CONFERENCE (MAXIMUM SIX CONFEREES)
ATTENDANT	CONSOLE DISPLAY
ATTENDANT	CONTROL OF TRUNK GROUP ACCESS
ATTENDANT	LOCKED LOOP OPERATION
ATTENDANT	RELEASE UPON COMPLETION OF DIALING
ATTENDANT	SPEED CALLING
ATTENDANT	TO RECORDED ANNOUNCEMENT
ATTENDANT	TRANSFER
AUTOMATIC	RECALL

GENERAL EXCHANGE TARIFF

Embarq Florida, Inc.

By: F.B. Poag  
Director

Section A24  
First Revised Sheet 12  
Cancelling Original Sheet 12  
Effective: January 1, 1997

LOCAL TELEPHONE SERVICE FOR FLORIDA STATE UNIVERSITY  
(CENTRAL TELEPHONE)

F. SYSTEM FEATURES (Cont'd)

3. Features (Cont'd)

a. ATTENDANT FEATURES (Cont'd)

BUSY VERIFICATION

- Busy Verification, Stations
- Busy Verification, Trunks

CALL HOLD

CALL PARK

CODE CALLING LINE TERMINATION

CONSOLE TEST

DELAYED OPERATION

DYNAMIC ATTENDANT CONSOLE SOFTWARE

INTERPOSITION CALLS AND TRANSFERS

LOCKOUT

MAINTENANCE AND ADMINISTRATION POSITION (MAP) DISPLAY  
FOR ATTENDANT OPERATIONAL MEASUREMENTS

MULTIPLE CONSOLE OPERATION

MULTIPLE LISTED DIRECTORY NUMBERS

POSITION BUSY

SECRECY

SERIAL CALL

STRAIGHTFORWARD OUTWARD COMPLETION

SUPERVISORY CONSOLE (BASIC)

SWITCHED LOOP OPERATION

TRUNK GROUP BUSY/TRUNK GROUP ACCESS CONTROL  
THROUGH SPECIAL KEYS

THROUGH DIALING

TIMED RECALL SET TO ZERO

GENERAL EXCHANGE TARIFF

Embarq Florida, Inc.

By: F.B. Poag  
Director

Section A24  
First Revised Sheet 13  
Cancelling Original Sheet 13  
Effective: January 1, 1997

LOCAL TELEPHONE SERVICE FOR FLORIDA STATE UNIVERSITY  
(CENTRAL TELEPHONE)

F. SYSTEM FEATURES (Cont'd)

3. Features (Cont'd)

a. ATTENDANT FEATURES (Cont'd)

TROUBLE KEY ON CONSOLE  
TRUNK GROUP BUSY INDICATION  
TWO-WAY SPLITTING  
UNIFORM CALL DISTRIBUTION FROM QUEUE  
WILD CARD KEY

b. SYSTEM FEATURES

ACCESS

- Common Control Switching Arrangement (CCSA) E&M Types 1 & II
- CO from PBX
- Enhanced Private Switched Communication Service (EPSCS)
- Electronic Tandem Network (ETN)
- Special Service Facilities

ATTENDANT SERVICE

- Local Consoles
- Remote Consoles

ATTENDANT SERVICE (CENTRALIZED, LIMITED - TO HOS AND  
REMOTE LINE EQUIPMENT)

CLASS-OF-SERVICE RESTRICTIONS

- Fully Restricted Service
- Semi-restricted Service
- Toll Restricted Service
- Unrestricted Service

CODE CALL ACCESS



GENERAL EXCHANGE TARIFF

Embarq Florida, Inc.

By: F.B. Poag  
Director

Section A24  
First Revised Sheet 14  
Cancelling Original Sheet 14  
Effective: January 1, 1997

LOCAL TELEPHONE SERVICE FOR FLORIDA STATE UNIVERSITY  
(CENTRAL TELEPHONE)

F. SYSTEM FEATURES (Cont'd)

3. Features (Cont'd)

b. SYSTEM FEATURES (Cont'd)

CODE RESTRICTIONS  
DATA CALL PROTECTION  
DIAL PULSE CONVERSION  
DIAL TONE UPON TRUNK SEIZURE  
DICTATION ACCESS AND CONTROL (DTMF ONLY)  
DIRECT INWARD DIALING (DID)  
DIRECT OUTWARD DIALING (DOD)  
END-TO-END SIGNALING  
ENHANCED SERVICE ORDER  
FLEXIBLE INTERCEPT  
FOREIGN EXCHANGE (FX) LINE - ANALOG  
FOREIGN EXCHANGE (FX) TRUNK DIGITAL TWO-WAY  
HUNTING  
- Directory Number Hunting (DLH)  
- Multiline Hunting (MLH)  
- Distributed Line Hunting (DLH)  
OUTPULSING TO PLAIN ORDINARY TELEPHONE SERVICE (POTS) TRUNKS  
QUANTITY CONTROL (100 LINES)

GENERAL EXCHANGE TARIFF

Embarq Florida, Inc.

Section A24

By: F.B. Poag  
Director

First Revised Sheet 15  
Cancelling Original Sheet 15  
Effective: January 1, 1997

LOCAL TELEPHONE SERVICE FOR FLORIDA STATE UNIVERSITY  
(CENTRAL TELEPHONE)

F. SYSTEM FEATURES (Cont'd)

3. Features (Cont'd)

b. SYSTEM FEATURES (Cont'd)

INCREASE IN NUMBER OF CUSTOMER GROUPS  
INDIVIDUAL LINE BUSINESS SERVICE - PBX APPLICATION  
LOUDSPEAKER AND RADIO PAGING ACCESS  
LOUDSPEAKER PAGING AND LINE TERMINATION - REWRITE  
MULTI CUSTOMER OPERATION  
NIGHT SERVICE  
- Night Service, Fixed  
- Night Service, Flexible  
- Night Service, Trunk Answer From Any Station (TAFAS)  
OFF-PREMISES STATIONS AND EXTENSIONS  
OPERATIONAL MEASUREMENTS - ENHANCED  
QUERY BUSY STATION  
SERVICE ORDER SYSTEM  
SIMPLIFIED DIALING  
SIX-PORT CONFERENCE CIRCUIT USE CONTROL  
SPECIAL INTERCEPT THROUGH SERVICE ORDER  
STATION SPECIFIC AUTHORIZATION CODES  
STATION-TO-STATION CALLING  
STORING OF 24 DIALED DIGITS  
TANDEM SWITCHING OF SPECIAL SERVICE CIRCUITS  
(SENDERIZED OPERATION)  
UNIFORM NUMBERING PLAN CAPABILITY

GENERAL EXCHANGE TARIFF

Embarq Florida, Inc.

Section A24

By: F.B. Poag  
Director

First Revised Sheet 16  
Cancelling Original Sheet 16  
Effective: January 1, 1997

LOCAL TELEPHONE SERVICE FOR FLORIDA STATE UNIVERSITY  
(CENTRAL TELEPHONE)

F. SYSTEM FEATURES (Cont'd)

3. Features (Cont'd)

c. STATION FEATURES

AUTOMATIC LINE

CALL FORWARD

- Call Forward, All Calls
- Call Forward, Busy
- Call Forward, No Answer

CALL PICK-UP

CALL WAITING

CAMP ON

CONSULTATION HOLD

MEET-ME CONFERENCE

RING AGAIN AND RING AGAIN ON HUNT GROUPS

SPEED CALLING (ONE SHORT AND ONE LONG LIST PER  
STATION MAXIMUM)

- Speed Calling Individual - Short List
- Speed Calling Individual - Long List
- Speed Calling Group - Long List

STATION CALL PARK

STATION CONTROLLED CONFERENCE (SIX PORTS MAXIMUM)

THREE WAY CONFERENCE/TRANSFER

- Three Way Conference
- Call Transfer of Incoming Calls
- Call Transfer of Outgoing Calls
- Call Transfer of All Calls

CODE CALL ACCESS

PAGING

AUTODIAL

GENERAL EXCHANGE TARIFF

Embarq Florida, Inc.

By: F.B. Poag  
Director

Section A24  
First Revised Sheet 17  
Cancelling Original Sheet 17  
Effective: January 1, 1997

LOCAL TELEPHONE SERVICE FOR FLORIDA STATE UNIVERSITY  
(CENTRAL TELEPHONE)

F. SYSTEM FEATURES (Cont'd)

3. Features (Cont'd)

c. STATION FEATURES (Cont'd)

CONFERENCE - SIX PARTIES  
CALL TRANSFER  
CALL HOLD  
UNIFORM CALL DISTRIBUTION  
ENHANCED ACD  
ENHANCED CALL WAITING

d. ENHANCED BUSINESS SERVICES - ATTENDANT FEATURES

FLEXIBLE CONSOLE ALERTING

e. ENHANCED BUSINESS SERVICES - SYSTEM FEATURES

AUDIO INPUT ON INCOMING CALLS IN QUEUE (ATTENDANT  
AND UNIFORM CALL DISTRIBUTION)  
DISTINCTIVE RINGING  
DUAL TONE MULTI FREQUENCY (DTMF) OUTPULSING ON A LINE  
ESN - VARIABLE TYPES OF OUTPULSING ON SAME CALL  
EXECUTIVE BUSY OVERRIDE (EBO)  
INTERGROUP CALLING  
MUSIC ON HOLD REWRITE  
UNIFORM CALL DISTRIBUTION (UCD)

GENERAL EXCHANGE TARIFF

Embarq Florida, Inc.

By: F.B. Poag  
Director

Section A24  
First Revised Sheet 18  
Cancelling Original Sheet 18  
Effective: January 1, 1997

LOCAL TELEPHONE SERVICE FOR FLORIDA STATE UNIVERSITY  
(CENTRAL TELEPHONE)

F. SYSTEM FEATURES (Cont'd)

3. Features (Cont'd)

f. ENHANCED BUSINESS SERVICES - STATION

LAST NUMBER REDIAL

g. STATION MESSAGE DETAIL RECORDING (SMDR)

SMDR FOR OPERATOR NUMBER IDENTIFICATION (ONI) LINES  
ESN - ANSWER SUPERVISION GENERATION  
STATION MESSAGE DETAIL RECORDING (SMDR)  
TRUNK IDENTIFIER IN AMA/SMDR RECORD

h. SMDR ENHANCED - ESN

AUTHORIZATION CODES

i. SMDR ENHANCED

ACCOUNT CODE/ACCEPTANCE AND RECORDING  
ATTENDANT CALL DETAIL ENTRY  
AUTHORIZATION CODES - VERIFICATION AND RECORDING  
DIRECT INWARD SYSTEM ACCESS (DISA)  
SEPARATE STATION MESSAGE DETAIL RECORDING (SMDR)  
OUTPUT FILE FOR SMDR AND AUTOMATIC MESSAGE  
ACCOUNTING (AMA)  
SEPARATE STATION MESSAGE DETAIL RECORDING (SMDR)  
OUTPUT FILES BY CUSTOMER GROUP

GENERAL EXCHANGE TARIFF

Embarq Florida, Inc.

By: F.B. Poag  
Director

Section A24  
First Revised Sheet 19  
Cancelling Original Sheet 19  
Effective: January 1, 1997

LOCAL TELEPHONE SERVICE FOR FLORIDA STATE UNIVERSITY  
(CENTRAL TELEPHONE)

F. SYSTEM FEATURES (Cont'd)

3. Features (Cont'd)

j. SMDR ENHANCED - SERVICES

AUTHORIZATION CODE IMMEDIATE DIALING

k. ESN TRUNK QUEUING

AUTOMATIC ROUTE SELECTION (ARS)  
EXPENSIVE ROUTE WARNING TONE (ERWT)  
OFF-HOOK QUEUING (OHQ)  
CALL-BACK QUEUING (CBQ)  
CALL-BACK QUEUING (CBQ ENHANCED)  
OFF-HOOK QUEUING (OHQ) ENHANCED

l. VIRTUAL FACILITY GROUPS

ATTENDANT CONTROL OF VFG  
CLASS 5 INWATS  
CLASS 5 OUTWATS  
OFF-HOOK QUEUE, CALL-BACK QUEUE FOR OUTWATS VIRTUAL  
FACILITY GROUPS (VFG)  
VFG TRUNK GROUP BUSY ON ATTENDANT CONSOLE  
VFG USAGE DATA

GENERAL EXCHANGE TARIFF

Embarq Florida, Inc.

By: F.B. Poag  
Director

Section A24  
First Revised Sheet 20  
Cancelling Original Sheet 20  
Effective: January 1, 1997

LOCAL TELEPHONE SERVICE FOR FLORIDA STATE UNIVERSITY  
(CENTRAL TELEPHONE)

F. SYSTEM FEATURES (Cont'd)

3. Features (Cont'd)

m. MESSAGE SERVICE

ATTENDANT MESSAGE WAITING  
BUSINESS SET MESSAGE WAITING  
MESSAGE WAITING LAMP  
STATION MESSAGE WAITING  
STUTTERED DIAL TONE FOR MESSAGE WAITING

n. TIME-OF-DAY ROUTING

TIME-OF-DAY ROUTING

o. DATAPATH BASIC

DATAPATH - Automatic Line  
DATAPATH - Call Processing  
DATAPATH - ESN Digital Data Connectivity  
DATAPATH - Hunt Groups  
DATAPATH - Ring Again  
DATAPATH - Service Order  
DATAPATH - Speed Calling

p. DATAPATH - MODEM POOLING

- Inbound Modem Pooling
- Modem Pooling Phase II
- Outbound Modem Pooling

q. DIGITAL PHONE M2000-BASIC

INTEGRATED VOICE/DATA

GENERAL EXCHANGE TARIFF

Embarq Florida, Inc.

By: F.B. Poag  
Director

Section A24  
First Revised Sheet 21  
Cancelling Original Sheet 21  
Effective: January 1, 1997

LOCAL TELEPHONE SERVICE FOR FLORIDA STATE UNIVERSITY  
(CENTRAL TELEPHONE)

F. SYSTEM FEATURES (Cont'd)

4. Rates

- a. Input/Output (I/O) Port Card - Included in A24.E.1.b rate

This NT1X67 serial port card supports the operation of data as follows:

- One (1) Terminal at 4800 Baud
- Two (2) Terminals at 2400 Baud
- Four (4) Terminals at 1200 Baud

This rate covers the cost of the card only installed in an existing shelf. The addition of a shelf will be assessed a time and materials NRC per occurrence.

- b. Modem Pooling<sup>1</sup> - Included in A24.E.1.b rate

This feature is comprised of a pool of modems where the hardware is located in the central office. Modem pooling enables a datapath Customer to communicate with the analog world via two types of pooling: inbound and outbound. Inbound Modem Pooling (IMP) is available when a data call from an analog modem or trunk terminates to a data unit. Outbound Modem Pooling (OMP) is available when a data unit subscriber calls an analog modem or when an analog trunk is present in the call path. This feature eliminates the requirement for a modem to be located at the data user's premises.

Note 1: Software feature costs were included in the initial costing of the SL-100. This rate covers the hardware costs required to establish the modem pool circuits. Digital Access Line rates and normal service order charges are in addition to this monthly rate.



GENERAL EXCHANGE TARIFF

Embarq Florida, Inc.

By: F.B. Poag  
Director

Section A24  
Fourth Revised Sheet 22  
Cancelling Third Revised Sheet 22  
Effective: March 31, 1999

LOCAL TELEPHONE SERVICE FOR FLORIDA STATE UNIVERSITY  
(CENTRAL TELEPHONE)

G. TRUNK EQUIVALENCY FOR SUBSCRIBER LINE CHARGE (SLC)

1. General

In compliance with Section 4 of Interstate Access Tariff for Digital Centrex Subscriber Line Charges (Central Telephone) to achieve rates based on a trunk equivalency basis, the Customer's SLC will be adjusted to reflect the rates as shown in the trunk equivalency table. The SLC is in addition to the monthly rate for the access line. In cases where the number of virtual trunks provided exceeds the equivalent number of trunks shown in the table for a customer's corresponding line quantity, the Customer will be billed one SLC for each virtual trunk provided.

2. Trunk Equivalency Table for Subscriber Line Charge

<u>No. of Lines</u>	<u>Equivalent No. of Trunks</u>	<u>Equivalent No. of SLC Charges*</u>
1	1	1
2-6	2	2
7-15	3	3
16-21	4	4
22-28	5	5
29-36	6	6
37-45	7	7
46-54	8	8
55-64	9	9
65-75	10	10
76-86	11	11
87-98	12	12
99-111	13	13
112-125	14	14
126-139	15	15

\* For rates, see End User Common Line Charges in Section 4 of the Interstate Access Tariff.

GENERAL EXCHANGE TARIFF

Embarq Florida, Inc.

Section A24

By: F.B. Poag  
Director

Fourth Revised Sheet 23  
Cancelling Third Revised Sheet 23  
Effective: March 31, 1999

LOCAL TELEPHONE SERVICE FOR FLORIDA STATE UNIVERSITY  
(CENTRAL TELEPHONE)

G. TRUNK EQUIVALENCY FOR SUBSCRIBER LINE CHARGE (SLC)

2. Trunk Equivalency Table for Subscriber Line Charge (Cont'd)

<u>No. of Lines</u>	<u>No. of Trunks</u>	<u>Equivalent No. of SLC Charges*</u>	<u>Equivalent</u>
140-155		16	16
156-171		17	17
172-189		18	18
190-207		19	19
208-225		20	20
226-243		21	21
244-262		22	22
263-281		23	23
282-300		24	24
Each Add'l 15 Lines		+1	+1

H. SERVICE AREA

1. General

The main campus shall be defined as all lands and space owned, leased or rented by Florida State University within Leon County as defined by the service area map in Section A24.H.3 of this tariff. Any lands purchased, leased or rented in the future which are contiguous to the main campus, or which are not contiguous but which require a minimum of 75 lines will also be considered a part of the main campus in Leon County. Mileage and adder charges will not apply to the main campus.

\* For rates, see End User Common Line Charges in Section 4 of the Interstate Access Tariff.

GENERAL EXCHANGE TARIFF

Embarq Florida, Inc.

Section A24

By: F.B. Poag  
Director

Second Revised Sheet 24  
Cancelling First Revised Sheet 24  
Effective: July 31, 1997

LOCAL TELEPHONE SERVICE FOR FLORIDA STATE UNIVERSITY  
(CENTRAL TELEPHONE)

H. SERVICE AREA (Cont'd)

2. Description of Service Area

a. Florida State University Complex

The Flat Rate Area of the Florida State University Complex is that area within a line along the following rights-of way, and beginning at the intersection of the South right-of-way of Call Street and the West right-of-way of Macomb Street and proceeding South to the South right-of-way of Jefferson Street, thence East to the West right-of-way of Boulevard Street, thence South to the North right-of-way to Pensacola Street, thence West to the West right-of-way of Railroad Avenue extended, thence South to the North right-of-way of St. Augustine Road, thence Northwest to the East right-of-way of Copeland Street, thence North to the North right-of-way of Pensacola Street, thence West to the East right-of-way of Woodward Street, thence North to the North right-of-way of Jefferson Street, thence West to the West right-of-way of Dunwoody Street, thence South and continuing as the West right-of-way of Seminole Street to the North right-of-way of Stadium Drive, thence Westerly and Northerly to the South right-of-way of Call Street, thence East to the East right-of-way of Murphree Street extended, thence North to the South right-of-way of Tennessee Street, thence East to the property line extended of the official residence of the University President, thence North, East, and South along those property lines to the North right-of-way of Tennessee Street, thence East to the South right-of-way of Virginia Street and East to the West right-of-way of Dewey Street, thence South to the extended rear lot line between Tennessee Street and Call Street, thence East to the East right-of-way of Copeland Street, thence North to the South right-of-way of Tennessee Street, thence East to the East property line of the Florida State University Fine Arts Building, thence South to the South right-of-way of Call Street, thence East to the point of beginning. Also to include lands within the borders of Macomb Street on the East, Stadium Drive on the West, Gaines Street on the South, Tennessee Street on the North, and future acquisitions of the University that are contiguous at the time of purchase or that become contiguous as a result of another acquisition within Leon County; and Innovation Park.

GENERAL EXCHANGE TARIFF

Embarq Florida, Inc.

By: F.B. Poag  
Director

Section A24  
First Revised Sheet 24.1  
Cancelling Original Sheet 24.1  
Effective: July 31, 1997

LOCAL TELEPHONE SERVICE FOR FLORIDA STATE UNIVERSITY  
(CENTRAL TELEPHONE)

H. SERVICE AREA (Cont'd)

2. Description of Service Area

b. 311 Service Area

The 311 Service Area of the Florida State University Complex is that area within a line along the following rights-of way, and beginning at the intersection of the South right-of-way of Call Street and the West right-of-way of Macomb Street and proceeding South to the South right-of-way of Jefferson Street, thence East to the West right-of-way of Boulevard Street, thence South to the North right-of-way to Pensacola Street, thence West to the West right-of-way of Railroad Avenue extended, thence South to the North right-of-way of St. Augustine Road, thence Northwest to the East right-of-way of Copeland Street, thence North to the North right-of-way of Pensacola Street, thence West to the East right-of-way of Woodward Street, thence North to the North right-of-way of Jefferson Street, thence West to the West right-of-way of Dunwoody Street, thence South and continuing as the West right-of-way of Seminole Street to the North right-of-way of Stadium Drive, thence Westerly and Northerly to the South right-of-way of Call Street, thence East to the East right-of-way of Murphree Street extended, thence North to the South right-of-way of Tennessee Street, thence East to the property line extended of the official residence of the University President, thence North, East, and South along those property lines to the North right-of-way of Tennessee Street, thence East to the South right-of-way of Virginia Street and East to the West right-of-way of Dewey Street, thence South to the extended rear lot line between Tennessee Street and Call Street, thence East to the East right-of-way of Copeland Street, thence North to the South right-of-way of Tennessee Street, thence East to the East property line of the Florida State University Fine Arts Building, thence South to the South right-of-way of Call Street, thence East to the point of beginning. Also to include lands within the borders of Macomb Street on the East, Stadium Drive on the West, Gaines Street on the South, Tennessee Street on the North, and future acquisitions of the University that are contiguous at the time of purchase or that become contiguous as a result of another acquisition within Leon County.

(N)

GENERAL EXCHANGE TARIFF

Embarq Florida, Inc.

Section A24

By: F.B. Poag  
Director

Second Revised Sheet 25  
Cancelling First Revised Sheet 25  
Effective: July 31, 1997

LOCAL TELEPHONE SERVICE FOR FLORIDA STATE UNIVERSITY  
(CENTRAL TELEPHONE)

H. SERVICE AREA (Cont'd)

3. Map of Florida State University Service Area and 311 Service Area

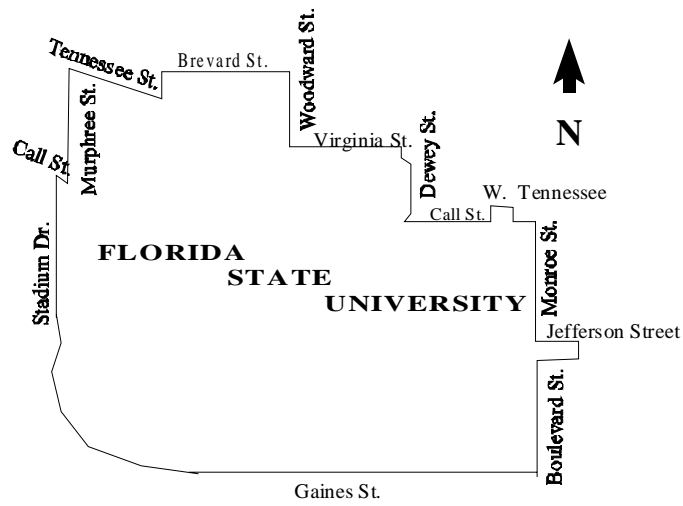

GENERAL EXCHANGE TARIFF

Embarq Florida, Inc.

By: F.B. Poag  
Director

Section A24  
First Revised Sheet 26  
Cancelling Original Sheet 26  
Effective: January 1, 1997

LOCAL TELEPHONE SERVICE FOR FLORIDA STATE UNIVERSITY  
(CENTRAL TELEPHONE)

H. SERVICE AREA (Cont'd)

4. In addition to the area shown in A24.H.3 of this tariff, mileage charges will not apply to Florida State University access lines located at:
  - a. Innovation Park
  - b. WFSU-TV
  - c. Florida State University Golf Course

I. DIGITAL CENTREX SERVICE - SPECIAL ACCESS (CENTRAL TELEPHONE ONLY)

1. General

- a. This service provides for the interconnection of Special Access and/or Private Line facilities to the Digital Centrex Service (Central Telephone Only) for Florida State University for the purpose of interfacing with subscribers to Digital Centrex service (Central Telephone Only). This service is necessary to complete the communication path between end users of Centrex type service and users of Special Access and/or Private Line services.
- b. This service is furnished subject to the availability of facilities and features from digital central office switching equipment located in a central office building owned or leased by the Company.

GENERAL EXCHANGE TARIFF

Embarq Florida, Inc.

By: F.B. Poag  
Director

Section A24  
First Revised Sheet 27  
Cancelling Original Sheet 27  
Effective: January 1, 1997

LOCAL TELEPHONE SERVICE FOR FLORIDA STATE UNIVERSITY  
(CENTRAL TELEPHONE)

I. DIGITAL CENTREX SERVICE - SPECIAL ACCESS (CENTRAL TELEPHONE ONLY) (Cont'd)

1. General (Cont'd)

- c. The rates in Section A11 are applicable to each Digital Centrex (Central Telephone Only) interconnection. The Special Access and/or Private Line facility is not included in the interconnection charge.

2. Rates and Charges

- a. Rates and charges for various applications of this service should be assessed as shown in Section A11.

GENERAL EXCHANGE TARIFF

Embarq Florida, Inc.

By: F. B. Poag  
Director

SECTION A25  
Third Revised Contents Sheet 1  
Cancelling Second Revised Sheet 1  
Effective: October 1, 2005

RESERVED FOR FUTURE USE



GENERAL EXCHANGE TARIFF

Embarq Florida, Inc.

By: F. B. Poag  
Director

SECTION A25  
Second Revised Sheet 1  
Cancelling First Revised Sheet 1  
Effective: October 1, 2005

RESERVED FOR FUTURE USE

GENERAL EXCHANGE TARIFF

Embarq Florida, Inc.

By: F. B. Poag  
Director

SECTION A25  
Second Revised Sheet 2  
Cancelling First Revised Sheet 2  
Effective: October 1, 2005

RESERVED FOR FUTURE USE

GENERAL EXCHANGE TARIFF

Embarq Florida, Inc.

By: F. B. Poag  
Director

SECTION A25  
Second Revised Sheet 3  
Cancelling First Revised Sheet 3  
Effective: October 1, 2005

RESERVED FOR FUTURE USE

GENERAL EXCHANGE TARIFF

Embarq Florida, Inc.

By: F. B. Poag  
Director

SECTION A25  
Fourth Revised Sheet 3.1  
Cancelling Third Revised Sheet 3.1  
Effective: October 1, 2005

RESERVED FOR FUTURE USE

GENERAL EXCHANGE TARIFF

Embarq Florida, Inc.

By: F. B. Poag  
Director

SECTION A25  
Second Revised Sheet 4  
Cancelling First Revised Sheet 4  
Effective: October 1, 2005

RESERVED FOR FUTURE USE

GENERAL EXCHANGE TARIFF

Embarq Florida, Inc.

By: F. B. Poag  
Director

SECTION A25  
Third Revised Sheet 5  
Cancelling Second Revised Sheet 5  
Effective: October 1, 2005

RESERVED FOR FUTURE USE

GENERAL EXCHANGE TARIFF

Embarq Florida, Inc.

By: F. B. Poag  
Director

SECTION A25  
Third Revised Sheet 6  
Cancelling Second Revised Sheet 6  
Effective: October 1, 2005

RESERVED FOR FUTURE USE

GENERAL EXCHANGE TARIFF

Embarq Florida, Inc.

By: F. B. Poag  
Director

SECTION A25  
Third Revised Sheet 7  
Cancelling Second Revised Sheet 7  
Effective: October 1, 2005

RESERVED FOR FUTURE USE



GENERAL EXCHANGE TARIFF

Embarq Florida, Inc.

By: F. B. Poag  
Director

SECTION A25  
Third Revised Sheet 8  
Cancelling Second Revised Sheet 8  
Effective: October 1, 2005

RESERVED FOR FUTURE USE

GENERAL EXCHANGE TARIFF

Embarq Florida, Inc.

By: F. B. Poag  
Director

SECTION A25  
Third Revised Sheet 9  
Cancelling Second Revised Sheet 9  
Effective: October 1, 2005

RESERVED FOR FUTURE USE

GENERAL EXCHANGE TARIFF

Embarq Florida, Inc.

By: F. B. Poag  
Director

SECTION A25  
Third Revised Sheet 10  
Cancelling Second Revised Sheet 10  
Effective: October 1, 2005

RESERVED FOR FUTURE USE

GENERAL EXCHANGE TARIFF

Embarq Florida, Inc.

By: F. B. Poag  
Director

SECTION A25  
Third Revised Sheet 10.1  
Cancelling Second Revised Sheet 10.1  
Effective: October 1, 2005

RESERVED FOR FUTURE USE

GENERAL EXCHANGE TARIFF

Embarq Florida, Inc.

By: B. Poag  
Director

SECTION A25  
Third Revised Sheet 10.2  
Cancelling Second Revised Sheet 10.2  
Effective: October 1, 2005

RESERVED FOR FUTURE USE

GENERAL EXCHANGE TARIFF

Embarq Florida, Inc.

By: F. B. Poag  
Director

SECTION A25  
Third Revised Sheet 11  
Cancelling Second Revised Sheet 11  
Effective: October 1, 2005

RESERVED FOR FUTURE USE

GENERAL EXCHANGE TARIFF

Embarq Florida, Inc.

By: F. B. Poag  
Director

SECTION A25  
Second Revised Sheet 12  
Cancelling First Revised Sheet 12  
Effective: October 1, 2005

RESERVED FOR FUTURE USE

GENERAL EXCHANGE TARIFF

Embarq Florida, Inc.

By: F. B. Poag  
Director

SECTION A25  
Second Revised Sheet 13  
Cancelling First Revised Sheet 13  
Effective: October 1, 2005

RESERVED FOR FUTURE USE



GENERAL EXCHANGE TARIFF

Embarq Florida, Inc.

By: F. B. Poag  
Director

SECTION A25  
Second Revised Sheet 14  
Cancelling First Revised Sheet 14  
Effective: October 1, 2005

RESERVED FOR FUTURE USE

GENERAL EXCHANGE TARIFF

Embarq Florida, Inc.

By: F. B. Poag  
Director

SECTION A25  
Second Revised Sheet 15  
Cancelling First Revised Sheet 15  
Effective: October 1, 2005

RESERVED FOR FUTURE USE

GENERAL EXCHANGE TARIFF

Embarq Florida, Inc.

By: F. B. Poag  
Director

SECTION A25  
Second Revised Sheet 16  
Cancelling First Revised Sheet 16  
Effective: October 1, 2005

RESERVED FOR FUTURE USE

GENERAL EXCHANGE TARIFF

Embarq Florida, Inc.

By: F. B. Poag  
Director

SECTION A25  
Third Revised Sheet 17  
Cancelling Second Revised Sheet 17  
Effective: October 1, 2005

RESERVED FOR FUTURE USE

GENERAL EXCHANGE TARIFF

Embarq Florida, Inc.

By: F. B. Poag  
Director

SECTION A25  
Second Revised Sheet 17.1  
Cancelling First Revised Sheet 17.1  
Effective: October 1, 2005

RESERVED FOR FUTURE USE

GENERAL EXCHANGE TARIFF

Embarq Florida, Inc.

By: F. B. Poag  
Director

SECTION A25  
Second Revised Sheet 18  
Cancelling First Revised Sheet 18  
Effective: October 1, 2005

RESERVED FOR FUTURE USE

GENERAL EXCHANGE TARIFF

Embarq Florida, Inc.

By: F. B. Poag  
Director

SECTION A25  
Fifth Revised Sheet 19  
Cancelling Fourth Revised Sheet 19  
Effective: October 1, 2005

RESERVED FOR FUTURE USE

GENERAL EXCHANGE TARIFF

Embarq Florida, Inc.

By: F. B. Poag  
Director

SECTION A25  
Second Revised Sheet 19.1  
Cancelling First Revised Sheet 19.1  
Effective: October 1, 2005

RESERVED FOR FUTURE USE



GENERAL EXCHANGE TARIFF

Embarq Florida, Inc.

By: F. B. Poag  
Director

SECTION A25  
Third Revised Sheet 20  
Cancelling Second Revised Sheet 20  
Effective: October 1, 2005

RESERVED FOR FUTURE USE

GENERAL EXCHANGE TARIFF

Embarq Florida, Inc.

By: F. B. Poag  
Director

SECTION A25  
Third Revised Sheet 21  
Cancelling Second Revised Sheet 21  
Effective: October 1, 2005

RESERVED FOR FUTURE USE

GENERAL EXCHANGE TARIFF

Embarq Florida, Inc.

By: F. B. Poag  
Director

SECTION A25  
Third Revised Sheet 22  
Cancelling Second Revised Sheet 22  
Effective: October 1, 2005

RESERVED FOR FUTURE USE

GENERAL EXCHANGE TARIFF

Embarq Florida, Inc.

By: F. B. Poag  
Director

SECTION A25  
Third Revised Sheet 23  
Cancelling Second Revised Sheet 23  
Effective: October 1, 2005

RESERVED FOR FUTURE USE

GENERAL EXCHANGE TARIFF

Embarq Florida, Inc.

By: F. B. Poag  
Director

SECTION A25  
Fourth Revised Sheet 24  
Cancelling Third Revised Sheet 24  
Effective: October 1, 2005

RESERVED FOR FUTURE USE

GENERAL EXCHANGE TARIFF

Embarq Florida, Inc.

By: F. B. Poag  
Director

SECTION A25  
Fourth Revised Sheet 25  
Cancelling Third Revised Sheet 25  
Effective: October 1, 2005

RESERVED FOR FUTURE USE

GENERAL EXCHANGE TARIFF

Embarq Florida, Inc.

By: F. B. Poag  
Director

SECTION A25  
Fifth Revised Sheet 26  
Cancelling Fourth Revised Sheet 26  
Effective: October 1, 2005

RESERVED FOR FUTURE USE

GENERAL EXCHANGE TARIFF

Embarq Florida, Inc.

By: F. B. Poag  
Director

SECTION A25  
Third Revised Sheet 26.1  
Cancelling Second Revised Sheet 26.1  
Effective: October 1, 2005

RESERVED FOR FUTURE USE



GENERAL EXCHANGE TARIFF

Embarq Florida, Inc.

By: F. B. Poag  
Director

SECTION A25  
Second Revised Sheet 27  
Cancelling First Revised Sheet 27  
Effective: October 1, 2005

RESERVED FOR FUTURE USE

GENERAL EXCHANGE TARIFF

Embarq Florida, Inc.

By: F. B. Poag  
Director

SECTION A25  
Second Revised Sheet 28  
Cancelling First Revised Sheet 28  
Effective: October 1, 2005

RESERVED FOR FUTURE USE

GENERAL EXCHANGE TARIFF

Embarq Florida, Inc.

By: F. B. Poag  
Director

SECTION A25  
Third Revised Sheet 29  
Cancelling Second Revised Sheet 29  
Effective: October 1, 2005

RESERVED FOR FUTURE USE

GENERAL EXCHANGE TARIFF

Embarq Florida, Inc.

By: F. B. Poag  
Director

SECTION A25  
Second Revised Sheet 30  
Cancelling First Revised Sheet 30  
Effective: October 1, 2005

RESERVED FOR FUTURE USE

GENERAL EXCHANGE TARIFF

Embarq Florida, Inc.

By: F. B. Poag  
Director

SECTION A25  
Third Revised Sheet 31  
Cancelling Second Revised Sheet 31  
Effective: October 1, 2005

RESERVED FOR FUTURE USE

GENERAL EXCHANGE TARIFF

Embarq Florida, Inc.

By: F. B. Poag  
Director

SECTION A25  
Second Revised Sheet 32  
Cancelling First Revised Sheet 32  
Effective: October 1, 2005

RESERVED FOR FUTURE USE

GENERAL EXCHANGE TARIFF

Embarq Florida, Inc.

By: F. B. Poag  
Director

SECTION A25  
Third Revised Sheet 33  
Cancelling Second Revised Sheet 33  
Effective: October 1, 2005

RESERVED FOR FUTURE USE

GENERAL EXCHANGE TARIFF

Embarq Florida, Inc.

By: F. B. Poag  
Director

SECTION A26  
First Revised Contents Sheet 1  
Cancelling Original Contents Sheet 1  
Effective: January 1, 1997

INTERCONNECTION OF LOCAL EXCHANGE SERVICES TO SHARED TENANT SERVICES  
CONTENTS

A.	GENERAL .....	1
B.	DEFINITIONS.....	4
C.	LIMITATIONS.....	6
D.	REGULATIONS.....	6
E.	CLIENT INFORMATION .....	8
F.	RATES AND CHARGES .....	10
G.	PROVISION OF SHARED TENANT SERVICE TO TRANSIENT END USERS .....	20
H.	ALL OTHER SHARING ARRANGEMENTS .....	23



## GENERAL EXCHANGE TARIFF

Embarq Florida, Inc.

By: F. B. Poag  
Director

SECTION A26  
First Revised Sheet 1  
Cancelling Original Sheet 1  
Effective: January 1, 1997

### INTERCONNECTION OF LOCAL EXCHANGE SERVICES TO SHARED TENANT SERVICES

#### A. GENERAL

1. Shared Tenant Service (STS) is a class of resold local exchange service furnished through a common switching or billing arrangement to tenants by a provider other than an existing local exchange telephone company. Such sharing or resale is permitted where facilities permit and within the confines of specifically identified continuous property areas under the control of a single owner or management unit. Areas designated for shared tenant service may be intersected or transversed by public thoroughfares provided the adjacent property segments created by such intersection would be continuous in the absence of the thoroughfare. The designated resale service area must be wholly within the confines of existing wire centers and/or exchange boundaries.
2. The reseller, or STS provider, is a person, firm, partnership, or corporation which has requested and received proper Shared Tenant Service certification from the Florida Public Service Commission. All other arrangements for resale or sharing of local exchange service are not permitted except as specified in G. And H. of this section of the tariff.
3. In an STS arrangement, the Company's subscriber of record/customer of record is the STS provider who orders service and is responsible for paying the telephone bill. The STS tenant, or end user, is a "client" of the STS provider. Service arrangements for the STS client must be made through the STS provider except as defined in D.1. following.

GENERAL EXCHANGE TARIFF

Embarq Florida, Inc.

By: F. B. Poag  
Director

SECTION A26  
First Revised Sheet 2  
Cancelling Original Sheet 2  
Effective: January 1, 1997

INTERCONNECTION OF LOCAL EXCHANGE SERVICES TO SHARED TENANT SERVICES

A. GENERAL (Cont'd)

4. Requests to provide connection to the local exchange network for the purpose of reselling local service, i.e., establishing an STS system, must be provided to the Company in writing.
  - a. Such written requests must contain at a minimum, but are not limited to, the following information:
    - 1) Name and address of STS provider
    - 2) Billing responsibility if different from 1)
    - 3) Florida Public Service Commission certificate number
    - 4) STS technical advisor, if applicable and if different from 1)
    - 5) New building or retrofit
    - 6) A forecast as to the anticipated local exchange access requirements for 60 months following initiation of the STS system.
    - 7) Number of customers, suites/offices in building(s)
    - 8) Name of the agent or representative responsible for placing orders, if different from 1).

GENERAL EXCHANGE TARIFF

Embarq Florida, Inc.

By: F. B. Poag  
Director

SECTION A26  
First Revised Sheet 3  
Cancelling Original Sheet 3  
Effective: January 1, 1997

INTERCONNECTION OF LOCAL EXCHANGE SERVICES TO SHARED TENANT SERVICES

A. GENERAL (Cont'd)

4. Cont'd.

- b. A representative or agent for purposes of this tariff is one who is authorized to act on behalf of another, usually under legal contract. Changes to the STS system or directory listings will be accepted by the Company only from this authority.
5. All STS providers of local service through key systems must be certificated by the FPSC pursuant to Section 364.339 of the Florida Statutes.
- a. Key systems of seven (7) lines or more are required to pay the current rates and charges in effect for STS interconnection. These key systems are subject to the same terms and conditions, specified in this section of the tariff, as STS providers which utilize PBX equipment. They are also required to file tariffs with the Commission reflecting the local rates charged to their clients.
  - b. Key systems of six (6) lines or less are not subject to the STS rates and charges and are not required to file tariffs reflecting the local rates they charge their tenants. However, where directly applicable, they are subject to the same terms and conditions specified in this section of the tariff.

GENERAL EXCHANGE TARIFF

Embarq Florida, Inc.

By: F. B. Poag  
Director

SECTION A26  
First Revised Sheet 4  
Cancelling Original Sheet 4  
Effective: January 1, 1997

INTERCONNECTION OF LOCAL EXCHANGE SERVICES TO SHARED TENANT SERVICES

B. DEFINITIONS

The following definitions are applicable to this section of the tariff:

**AFFILIATED ENTITY** - one that holds in excess of 50% of the stock of the entity which claims to be affiliated.

**HYBRID KEY SYSTEM** - a sophisticated multi-function switching arrangement using either key button telephones or single line non-key instruments. May be programmed at the user's option to function either as a key system or as a PBX system. FCC Registration number contains a suffix of the letters MFE.

**INTERCOMMUNICATION** - an unauthorized arrangement that allows telephone communication between and among unaffiliated clients of an STS system without accessing a central office of the Company.

**KEY SYSTEM** - an arrangement consisting of telephones, usually key button sets, and common equipment which permits users to manually select a specific exchange line for incoming and outgoing calls. Provides a limited number of service features such as pick-up, hold, intercommunications, signaling, etc.

**PBX** - an arrangement of customer premises located switching equipment and associated telephones which permits access to a common group of exchange lines via either automatic selection of the first available trunk or manual, i.e., attendant, selection from all available trunks. Usually provides an extensive selection of sophisticated features for station users.

GENERAL EXCHANGE TARIFF

Embarq Florida, Inc.

By: F. B. Poag  
Director

SECTION A26  
First Revised Sheet 5  
Cancelling Original Sheet 5  
Effective: January 1, 1997

INTERCONNECTION OF LOCAL EXCHANGE SERVICES TO SHARED TENANT SERVICES

B. DEFINITIONS (Cont'd)

**REPRESENTATIVE/AGENT** - one authorized to act on behalf of another, usually under legal contract.

**SERVICE LOCATION** - a single building or multiple commercial or residential buildings located within the confines of specifically identified continuous property areas under the control of a single owner or management unit.

**SHARED TENANT SERVICE (STS)** - a class of resold local exchange service furnished through a common switching or billing arrangement by a provider other than the local exchange telephone company.

**SHARED TENANT SERVICE (STS) CLIENT** - the STS tenant, or end user, who is provided telephone service through a certificated STS arrangement.

**SHARED TENANT SERVICE (STS) PROVIDER** - a person, firm, partnership or corporation which has received proper certification from the Florida Public Service Commission.

**TENANT** - any person entitled to occupy a premises under a rental or lease agreement.

**TRANSIENT** - one temporarily occupying the premises, with occupancy not to exceed nine months.

## GENERAL EXCHANGE TARIFF

Embarq Florida, Inc.

By: F. B. Poag  
Director

SECTION A26  
First Revised Sheet 6  
Cancelling Original Sheet 6  
Effective: January 1, 1997

### INTERCONNECTION OF LOCAL EXCHANGE SERVICES TO SHARED TENANT SERVICES

#### C. LIMITATIONS

1. Shared Tenant Service is limited to service of commercial or residential tenants in a single building or multiple commercial or residential buildings located within the confines of specifically identified continuous property areas under the control of a single owner or management unit.
2. STS providers may arrange for sharing or "pooling" of STS trunks for use by their clients.
3. Suspension of service as provided in Section A2 is not permitted in connection with Shared Tenant Service.

#### D. REGULATIONS

1. Shared Tenant Service providers are required to guarantee access for the Company to any STS client requesting direct service from the Company.
  - a. The Company must be able to gain access to all facilities up to the demarcation point of the building and/or the client's premises. The Company will retain responsibility and maintenance of the network up to that point.
  - b. The Company may construct facilities to directly service the STS client; or, in lieu of Company-owned facilities, the Company may choose to utilize privately owned distribution facilities, including purchase or lease of such facilities from the STS provider.

GENERAL EXCHANGE TARIFF

Embarq Florida, Inc.

By: F. B. Poag  
Director

SECTION A26  
Second Revised Sheet 7  
Cancelling First Revised Sheet 7  
Effective: July 17, 1998

INTERCONNECTION OF LOCAL EXCHANGE SERVICES TO SHARED TENANT SERVICES

D. REGULATIONS (Cont'd)

1. Cont'd.
  - c. Should the Company choose to purchase or lease facilities from the STS provider, the Company will provide reasonable compensation not to exceed what it would have cost the Company to construct its own facilities.
  - d. In no case will the Company be a party to controversies between an STS provider and an STS client desiring direct service from the Company.
2. STS providers must permit client access to the Company operators "zero" (0) for emergencies and for line verification purposes; as well as to 911 where available.
3. Unrestricted access must be provided to all locally available interexchange carriers via Toll Free Codes (TFC), 101XXXX, or 950 and to the intraexchange toll service handled by the Company.
4. An STS provider may not provide shared Wide Area Telephone Service (WATS) unless granted additional authority to do so by the Florida Public Service Commission.
5. Private bypass facilities, i.e., microwave towers, may not be constructed for interconnecting STS locations or systems. Conditions and limitations restricting the resale or sharing of Foreign Exchange Service apply.

GENERAL EXCHANGE TARIFF

Embarq Florida, Inc.

By: F. B. Poag  
Director

SECTION A26  
First Revised Sheet 8  
Cancelling Original Sheet 8  
Effective: January 1, 1997

INTERCONNECTION OF LOCAL EXCHANGE SERVICES TO SHARED TENANT SERVICES

D. REGULATIONS (Cont'd)

6. Customer premises equipment associated with STS and the provisioning thereof is the responsibility of the STS provider.
  - a. All repairs, rearrangements, moves and changes to the STS system beyond the Company's demarcation point or network interface will be the responsibility of the STS provider except as provided in D.1.
  - b. The STS provider will be responsible for payment of a Trouble Location Charge for visits by the Company where a service difficulty or trouble report results from customer-provided equipment or facilities regardless of whether the trouble was reported to Company Repair by the STS provider or an STS client.

E. CLIENT INFORMATION

1. The rates and charges listed herein are those charged the STS provider for resale of local exchange service. The Company will not retain nor provide to any caller the rates charged to the STS client by the STS provider. It is the STS provider's responsibility to disclose such information to the client(s).



GENERAL EXCHANGE TARIFF

Embarq Florida, Inc.

By: F. B. Poag  
Director

SECTION A26  
First Revised Sheet 9  
Cancelling Original Sheet 9  
Effective: January 1, 1997

INTERCONNECTION OF LOCAL EXCHANGE SERVICES TO SHARED TENANT SERVICES

E. CLIENT INFORMATION (Cont'd)

2. Each STS provider is required to inform STS clients of its current rates and charges for resold local exchange service and its quality of service standards. The STS provider must inform each client that the Florida Public Service Commission will not set rates or regulate the service quality standards of the providers STS system.
3. The STS provider is responsible for establishing repair reporting procedures to be used by the STS clients. The Trouble Location Charge will be applicable if an STS client reports trouble to Company Repair and a subsequent premises visit by a Company technician locates the trouble in the STS equipment or facilities.
4. STS arrangements are provided one free directory listing per STS system. Additional directory listings may be furnished at rates and regulations as specified in Section A6 of this tariff.

GENERAL EXCHANGE TARIFF

Embarq Florida, Inc.

By: F. B. Poag  
Director

SECTION A26  
First Revised Sheet 10  
Cancelling Original Sheet 10  
Effective: January 1, 1997

INTERCONNECTION OF LOCAL EXCHANGE SERVICES TO SHARED TENANT SERVICES

E. CLIENT INFORMATION (Cont'd)

5. Additional directory listings for STS clients may be furnished at rates and regulations as specified in Section A6. The STS provider is responsible for determining the client's desired listing arrangement and for conveying that information to the Company in a timely manner.
  - a. The client's listing is provided under the rules and regulations specified in Section A6 of this tariff.
  - b. The Company will not be a party to any controversies which may arise between an STS provider and client(s) due to misspellings, omissions, delays or misunderstandings about the desired listing.

F. RATES AND CHARGES

1. Rates and Charges for PBX Systems or Key Systems of Seven (7) Lines or More

The following rates and charges are applicable only to certificated Shared Tenant Service systems. Rates for all other sharing arrangements, as defined in G. and H. are as specified in the appropriate section of this tariff.

	Installation Charge	Monthly Rate
a. Service establishment Charge, per service location	\$300.00	--

GENERAL EXCHANGE TARIFF

Embarq Florida, Inc.

By: F. B. Poag  
Director

SECTION A26  
First Revised Sheet 11  
Cancelling Original Sheet 11  
Effective: January 1, 1997

INTERCONNECTION OF LOCAL EXCHANGE SERVICES TO SHARED TENANT SERVICES

F. RATES AND CHARGES (Cont'd)

1. Rates and Charges for PBX Systems or Key Systems of Seven (7) Lines or More (Cont'd)

- b. Message Rate - The following rates apply for outward and combination trunks in areas where message rating is available, and for inward trunks in all areas. The monthly rate is equal to 60% of the applicable local exchange trunk rate, plus usage.

<u>Rate Group</u>	<u>United Telephone Exchanges</u>	<u>Central Telephone Exchanges</u>
1	\$18.24	\$20.00
2	\$20.35	\$21.20
3	\$22.48	\$22.25
4	\$24.59	\$23.50
5	\$26.72	\$24.70
6	\$28.84	\$26.10
Exceptions:		
Useppa Island	\$36.72	
North Captiva Island	\$36.72	

Local Usage Charge

On peak charges are \$.03 for the initial minute and \$.015 for each additional minute. On peak charges are for local calls made during times not listed under off peak.

GENERAL EXCHANGE TARIFF

Embarq Florida, Inc.

By: F. B. Poag  
Director

SECTION A26  
First Revised Sheet 12  
Cancelling Original Sheet 12  
Effective: January 1, 1997

INTERCONNECTION OF LOCAL EXCHANGE SERVICES TO SHARED TENANT SERVICES

F. RATES AND CHARGES (Cont'd)

1. Rates and Charges for PBX Systems or Key Systems of Seven (7) Lines or More (Cont'd)

b. Cont'd.

Local Usage Charge

Off peak charges are \$.02 for the initial minute and \$.01 for each additional minute. Off peak times are for local calls placed between 12:00 noon and 2:00 p.m. weekdays; between 9:00 p.m. and 9:00 a.m. all days; and between 9:00 a.m. and 9:00 p.m. Saturdays and Sundays.

- a) Local usage charges do not apply on calls to 911, the Company operator, Company repair (611), or on calls to the Company business office, nor on calls to 976 Service numbers.
- b) Calls to local Directory Assistance (411) will be charged the tariffed rate for such calls as specified in Section A3.

GENERAL EXCHANGE TARIFF

Embarq Florida, Inc.

By: F. B. Poag  
Director

SECTION A26  
First Revised Sheet 13  
Cancelling Original Sheet 13  
Effective: January 1, 1997

INTERCONNECTION OF LOCAL EXCHANGE SERVICES TO SHARED TENANT SERVICES

F. RATES AND CHARGES (Cont'd)

1. Rates and Charges for PBX Systems or Key Systems of Seven (7) Lines or More (Cont'd)

- c. Flat Rate - The following rates apply for outward and combination trunks in those areas where message rate service is not available due to central office equipment capabilities. The monthly rate is equal to 175% of the applicable local exchange trunk rate.

<u>Rate Group</u>	<u>United Telephone Exchanges</u>	<u>Central Telephone Exchanges</u>
1	\$53.20	\$58.30
2	\$59.34	\$61.80
3	\$65.57	\$64.90
4	\$71.72	\$68.60
5	\$77.95	\$72.10
6	\$84.11	\$76.15
Exceptions:		
Useppa Island	\$87.95	
North Captiva Island	\$87.95	

- d. Calls to telephone numbers for which a charge is applicable to the caller, i.e., 900, 976 will be charged for at the appropriate rate.

GENERAL EXCHANGE TARIFF

Embarq Florida, Inc.

By: F. B. Poag  
Director

SECTION A26  
Second Revised Sheet 14  
Cancels First Revised Sheet 14  
Effective: November 20, 2004

INTERCONNECTION OF LOCAL EXCHANGE SERVICES TO SHARED TENANT SERVICES

F. RATES AND CHARGES (Cont'd)

1. Rates and Charges for PBX Systems or Key Systems of Seven (7) Lines or More (Cont'd)

e. When services such as those defined in F.1.b.(4)(b) and d. are utilized, all charges will be billed to the STS provider. The STS provider is responsible for payment of the charges. The Company will make no attempt to determine which client or clients placed the calls.

f. Service connection charges as specified in Section A4 apply as appropriate.

2. Direct Inward Dialing (DID) Service Associated with Shared Tenant Service

For Direct Inward Dialing (DID) Service Associated with Shared Tenant Service, See Section A16 for the applicable regulations and Rates and Charges.

GENERAL EXCHANGE TARIFF

Embarq Florida, Inc.

By: F. B. Poag  
Director

SECTION A26  
Second Revised Sheet 15  
Cancels First Revised Sheet 15  
Effective: November 20, 2004

INTERCONNECTION OF LOCAL EXCHANGE SERVICES TO SHARED TENANT SERVICES

RESERVED FOR FUTURE USE

GENERAL EXCHANGE TARIFF

Embarq Florida, Inc.

By: F. B. Poag  
Director

SECTION A26  
Second Revised Sheet 16  
Cancels First Revised Sheet 16  
Effective: November 20, 2004

INTERCONNECTION OF LOCAL EXCHANGE SERVICES TO SHARED TENANT SERVICES

RESERVED FOR FUTURE USE



GENERAL EXCHANGE TARIFF

Embarq Florida, Inc.

By: F. B. Poag  
Director

SECTION A26  
Second Revised Sheet 17  
Cancels First Revised Sheet 17  
Effective: November 20, 2004

INTERCONNECTION OF LOCAL EXCHANGE SERVICES TO SHARED TENANT SERVICES

RESERVED FOR FUTURE USE

GENERAL EXCHANGE TARIFF

Embarq Florida, Inc.

By: F. B. Poag  
Director

SECTION A26  
Second Revised Sheet 18  
Cancels First Revised Sheet 18  
Effective: November 20, 2004

INTERCONNECTION OF LOCAL EXCHANGE SERVICES TO SHARED TENANT SERVICES

RESERVED FOR FUTURE USE

GENERAL EXCHANGE TARIFF

Embarq Florida, Inc.

By: F. B. Poag  
Director

SECTION A26  
Second Revised Sheet 19  
Cancels First Revised Sheet 19  
Effective: November 20, 2004

INTERCONNECTION OF LOCAL EXCHANGE SERVICES TO SHARED TENANT SERVICES

RESERVED FOR FUTURE USE

GENERAL EXCHANGE TARIFF

Embarq Florida, Inc.

By: F. B. Poag  
Director

SECTION A26  
First Revised Sheet 20  
Cancelling Original Sheet 20  
Effective: January 1, 1997

INTERCONNECTION OF LOCAL EXCHANGE SERVICES TO SHARED TENANT SERVICES

G. PROVISION OF SHARED TENANT SERVICE TO TRANSIENT END USERS

1. For purposes of this tariff, a transient end-user is considered to be one temporarily occupying the premises, with occupancy not to exceed nine months.
2. By virtue of the transient nature of the end-user, certain other sharing arrangements are considered neither duplicative nor competitive with the local exchange service provided by the Company. Therefore, existing rates and service conditions as specified in other sections of this tariff will continue to apply to the following sharing arrangements.
  - a. Airports - sharing is permitted within the airport complex for the safe and efficient transportation of passengers and freight through the airport campus.
    - 1) Sharing may not be extended to other facilities such as hotels, shopping malls and industrial parks unless the airport becomes a certificated STS provider.
    - 2) As an alternative, trunks serving these other entities can be partitioned from the trunks serving the airport campus.

GENERAL EXCHANGE TARIFF

Embarq Florida, Inc.

By: F. B. Poag  
Director

SECTION A26  
First Revised Sheet 21  
Cancelling Original Sheet 21  
Effective: January 1, 1997

INTERCONNECTION OF LOCAL EXCHANGE SERVICES TO SHARED TENANT SERVICES

G. PROVISION OF SHARED TENANT SERVICE TO TRANSIENT END USERS (Cont'd)

2. Cont'd.

- b. Hospitals - sharing is permitted within a hospital for patient rooms and administrative offices due to the critical need for rapid communication of the hospital staff.
  - 1) Sharing may not be extended to physicians in private practice offices unless the hospital becomes a certificated STS provider.
  - 2) As an alternative, trunks serving physicians individual private practice offices can be partitioned from the trunks serving the hospital administrative offices, patient rooms and other private practice offices.
- c. Nursing Homes, Adult Congregate Living Facilities, Continuing Care Facilities, and Retirement Homes - sharing is permitted in facilities which are intended to serve and/or care for the elderly population. Such sharing arrangements are permitted only when at least 75% of the occupants of the homes, communities or facilities are over age 62, or totally or permanently disabled, and the home community or facility has one or more of the following licensed or certificated components:

GENERAL EXCHANGE TARIFF

Embarq Florida, Inc.

By: F. B. Poag  
Director

SECTION A26  
First Revised Sheet 22  
Cancelling Original Sheet 22  
Effective: January 1, 1997

INTERCONNECTION OF LOCAL EXCHANGE SERVICES TO SHARED TENANT SERVICES

G. PROVISION OF SHARED TENANT SERVICE TO TRANSIENT END USERS (Cont'd)

2. Cont'd.

c. Cont'd.

- 1) licensed as a nursing home pursuant to Chapter 400, Florida Statutes, or
- 2) licensed as an adult congregate living facility pursuant to Chapter 400.404, Florida Statutes, or exempted as same pursuant to Section 400, Florida Statutes, or
- 3) certificated as a continuing care facility pursuant to Chapter 651, Florida Statutes, or
- 4) if funded or insured by the United States Department of Housing and Urban Development (HUD) pursuant to the National Housing Act, 12 U.S. Code SS 1701, program designed to aid the elderly.

GENERAL EXCHANGE TARIFF

Embarq Florida, Inc.

By: F. B. Poag  
Director

SECTION A26  
First Revised Sheet 23  
Cancelling Original Sheet 23  
Effective: January 1, 1997

INTERCONNECTION OF LOCAL EXCHANGE SERVICES TO SHARED TENANT SERVICES

H. ALL OTHER SHARING ARRANGEMENTS

1. Certain other sharing arrangements which serve transient end-users as defined in G.1. are considered neither duplicative nor competitive with service furnished by the Company and are therefore permitted to continue under existing rates and service conditions.
2. Reservation service, sub-leased residence service, service to exhibitors in convention halls, service in clubs, yacht basins, time-share facilities, apartment hotels and student dormitories, and composite data services are considered to be in the category of "All Other Sharing Arrangements".

GENERAL EXCHANGE TARIFF

Embarq Florida, Inc.

SECTION A27

By: F. B. Poag  
Director

Third Revised Contents Sheet 1  
Cancelling Second Revised Contents Sheet 1  
Effective: February 24, 2006

SPECIAL PACKAGED OFFERINGS  
CONTENTS

A.	SOLUTIONS - RESIDENCE .....	1
1.	General .....	1
2.	Regulations.....	1
3.	Rates and Charges.....	3
B.	SOLUTIONS - BUSINESS .....	8
1.	General .....	8
2.	Regulations.....	8
3.	Rates and Charges.....	10
C.	PRI BUNDLE .....	11.1
1.	General .....	11.1
2.	Regulations.....	11.1
3.	Rates and Charges.....	11.2
D.	MARKET TRIALS .....	12



## GENERAL EXCHANGE TARIFF

Embarq Florida, Inc.

BY: F. B. Poag  
Director

SECTION A27  
Second Revised Sheet 1  
Cancelling First Revised Sheet 1  
Effective: July 31, 2005

### SPECIAL PACKAGED OFFERINGS

#### A. SOLUTIONS - RESIDENCE

##### 1. General

- a. Solutions is an optional residence service enrollment plan. The Plan permits a customer to receive the following features and services for a flat monthly rate, for each Solutions Package residence line provided. Solutions includes two or more of the following features and services:
  - 1) Flat Rate Local Exchange Service;
  - 2) Either a 60 minute block of time for Message Telecommunications Service (Local Toll), with Consumer Sense Local Toll rates applicable for each additional minute; or the option of subscribing to Consumer Sense Local Toll Service with per minute of use rates applicable for all local toll minutes as specified in Section A18, D.3. of this tariff, and
  - 3) A Custom Calling Feature Package, an individual feature or a group of Custom Calling/ExpressTouch Features. Custom Calling Features and Packages and ExpressTouch features are described in Section A13 of this tariff.

##### 2. Regulations

- a. Solutions customers may terminate their enrollment in this Plan at any time upon notice to the Company.
- b. Unless terminated by the Solutions customer or the Company, a customer will remain enrolled in the Plan, as amended from time-to-time, with any applicable changes in rate, for as long as the Plan continues to be offered by the Company.
- c. The Plan is not available with Residential ISDN-BRI Service lines or to customers who are or become toll restricted.
- d. No more than four (4) residence lines can be enrolled with the Solution option for each customer Billed Telephone Number account.
- e. Service Charges, as described in Section A4 of this tariff, apply to requests for new and additional Solutions lines, and moves of existing lines. Service Charges will not apply when Solutions replaces existing Local Exchange Service or if the customer requests a change from Solutions back to Local Exchange Service.
- f. Solutions customers are not eligible for promotional offerings associated with the Custom Calling Services included in the Plan, unless specifically provided for in a promotional offering.
- g. The Plan may not be combined with any other Residence optional toll calling plan service.

GENERAL EXCHANGE TARIFF

Embarq Florida, Inc.

BY: F. B. Poag  
Director

SECTION A27  
Fourth Revised Sheet 2  
Cancelling Third Revised Sheet 2  
Effective: April 24, 2006

SPECIAL PACKAGED OFFERINGS

A. SOLUTIONS – RESIDENCE (Cont'd)

2. Regulations (Cont'd)

h. Residence customers enrolled in the Plan, who subsequently become subject to Company initiated toll restriction will have all existing Solutions lines converted to the applicable tariff rates. The Service Charges will not apply for those existing lines converted, in-place, due to termination procedures. In addition, any optional services not affected by the termination procedures will convert to their applicable tariff rates. Such customers will not be permitted to re-enroll in the Plan until such time as all associated unpaid balances are satisfactorily paid in full.

j. Customer Referral Program

- 1) Existing residential customers subscribed to one of the following combinations of services who submit a referral via the Company's Internet website will receive a \$25 bill credit if the referral results in the activation of either of the qualifying service combinations by the referred customer within sixty days of the referral:
  - a) Core Solution Package with Embarq Communications, Inc. Solutions Unlimited Long Distance,
  - b) Core Solution Plus Package with Embarq Communications, Inc. Solutions Unlimited Long Distance,
  - c) Personal II Solution Package with Embarq Communications, Inc. Solutions Unlimited Long Distance,
  - d) Home II Solution Package with one required Premium Enhanced Service (LineGuard/Data LineGuard, CPE Warranty Plus or VoiceMail) and Embarq Communications, Inc. Solutions Unlimited Long Distance.
- 2) The referring customer will receive the bill credit within sixty days of the referred customer subscribing to the same services. Multiple credits may be received by the referring customer, with one credit rendered per bill cycle and unused credits rolling over to future months.

GENERAL EXCHANGE TARIFF

Embarq Florida, Inc.

BY: F. B. Poag  
Director

SECTION A27  
Second Revised Sheet 3  
Cancelling First Revised Sheet 3  
Effective: November 1, 2005

SPECIAL PACKAGED OFFERINGS

A. SOLUTIONS - RESIDENCE (Cont'd)

2. Regulations (Cont'd)

- i. Prices of the individual services included in these packages may be higher or lower than the packaged offering.

3. Rates and Charges

a. Solutions Packages

	Monthly Rate
1) <u>Ideal Solution</u> Local Exchange Service, Package 5, @ 60 minutes of Local Toll	\$33.15
2) <u>Sure Solution II†</u> Local Exchange Service, Package 5@	\$28.45
3) <u>Choice Solution</u> Local Exchange Service, Package 1, 60 minutes of Local Toll	\$27.45
4) <u>Standard Solution I</u> Local Exchange Service, Enhanced Call Waiting, 60 minutes of Local Toll	\$23.75
5) <u>Standard Solution II†</u> Local Exchange Service, Package 1	\$21.20
6) <u>Basic Solution</u> Local Exchange Service, Package 8, 60 minutes of Local Toll	\$31.45

† Customers have the option of subscribing to Consumer Sense Local Toll Service with per minute of use rates applicable as specified in Section A18 of this tariff.

@ Talking Call Waiting can be added to this Solutions package at the monthly rate shown in Section A13.Z.

GENERAL EXCHANGE TARIFF

Embarq Florida, Inc.

BY: F. B. Poag  
Director

SECTION A27  
Third Revised Sheet 4  
Cancelling Second Revised Sheet 4  
Effective: November 1, 2005

SPECIAL PACKAGED OFFERINGS

A. SOLUTIONS - RESIDENCE (Cont'd)

3. Rates and Charges - (Cont'd)

a. Solutions Packages - (Cont'd)

	<u>Monthly Rate</u>
7) <u>Classic Solution</u> <sup>1</sup> Local Exchange Service, Package 8	\$27.15
8) <u>Core Solution</u> Local Exchange Service Enhanced Call Waiting - Optional or Talking Call Waiting - Optional Call Forwarding Three-Way Calling Caller ID w/Name Anonymous Call Rejection Repeat Dialing Return Call Call Forward No Answer-Fixed Call Forward Busy-Fixed Speed Calling - 8 Selective Call Acceptance Selective Call Forwarding Selective Call Ring Selective Call Rejection	\$34.70
9) <u>Clear Solution</u> Local Exchange Service Call Forwarding Three-Way Calling Caller ID w/Name Anonymous Call Rejection Repeat Dialing Return Call Call Forward No Answer-Fixed Call Forward Busy-Fixed Speed Calling - 8 Selective Call Acceptance Selective Call Forwarding Selective Call Ring Selective Call Rejection	\$33.50

<sup>1</sup> Customers have the option of subscribing to Consumer Sense Local Toll Service with per minute of use rates applicable as specified in Section A18 of this tariff.

GENERAL EXCHANGE TARIFF

Embarq Florida, Inc.

BY: F. B. Poag  
Director

SECTION A27  
Fourth Revised Sheet 5  
Cancelling Third Revised Sheet 5  
Effective: November 1, 2005

SPECIAL PACKAGED OFFERINGS

A. SOLUTIONS - RESIDENCE (Cont'd)

3. Rates and Charges - (Cont'd)

a. Solutions Packages - (Cont'd)

	Monthly Rate
10) <u>Personal II Solution</u> <sup>1</sup> Local Exchange Service Enhanced Call Waiting - Optional or Talking Call Waiting - Optional Call Waiting ID Call Forwarding Three Way Calling Caller ID w/Name Repeat Dialing Return Call Call Forward No Answer-Fixed Call Forward Busy-Fixed Selective Call Forwarding	\$31.95
11) <u>Home II Solution</u> <sup>2</sup> Local Exchange Service Enhanced Call Waiting - Optional Call Waiting ID Three-Way Calling Caller ID w/Name Call Forward No Answer-Fixed Call Forward Busy-Fixed	\$28.10
12) <u>Safe and Sound II Solution</u> <sup>3</sup> Local Exchange Service Caller ID w/Name	\$19.65

<sup>1</sup> Privacy ID can be added to this Solutions package at the monthly rate shown in Section A13.Y.

<sup>2</sup> Talking Call Waiting can be added to this Solutions package at the monthly rate shown in Section A13.Z.

<sup>3</sup> Customers must purchase the deregulated services LineGuard or Data LineGuard and CPE Warranty Plus.

GENERAL EXCHANGE TARIFF

Embarq Florida, Inc.

BY: F. B. Poag  
Director

SECTION A27  
Third Revised Sheet 6  
Cancelling Second Revised Sheet 6  
Effective: November 1, 2005

SPECIAL PACKAGED OFFERINGS

A. SOLUTIONS - RESIDENCE (Cont'd)

3. Rates and Charges - (Cont'd)

a. Solutions Packages - (Cont'd)

- 13) Core Solution Plus  
Local Exchange Service  
Enhanced Call Waiting - Optional  
or Talking Call Waiting - Optional  
Call Forwarding  
Three-Way Calling  
Caller ID w/Name  
Anonymous Call Rejection  
Repeat Dialing  
Return Call  
Call Forward No Answer-Fixed  
Call Forward Busy-Fixed  
Speed Calling - 8  
Selective Call Acceptance  
Selective Call Forwarding  
Selective Call Ring  
Selective Call Rejection  
Privacy ID

Monthly  
Rate  
\$38.70

GENERAL EXCHANGE TARIFF

Embarq Florida, Inc.

BY: F. B. Poag  
Director

SECTION A27  
Tenth Revised Sheet 7  
Cancels Ninth Revised Sheet 7  
Effective: April 24, 2006

SPECIAL PACKAGED OFFERINGS

A. SOLUTIONS - RESIDENCE (Cont'd)

3. Rates and Charges - (Cont'd)

a. Solutions Packages - (Cont'd)

	Monthly <u>Rate</u>
14) <u>Special Plan Bundle #</u> Local Exchange Service Enhanced Call Waiting or Talking Call Waiting (Optional) Call Forward Busy-Fixed Call Forward No Answer-Fixed Caller ID with Name Anonymous Call Rejection Call Forwarding Call Waiting ID Selective Call Acceptance Repeat Dial Return Call	\$39.95*
15) <u>Progressive Plan</u> <sup>2</sup> Local Exchange Service Enhanced Call Waiting - Optional Call Waiting ID Three-Way Calling Caller ID w/Name Call Forwarding Call Forward No Answer-Fixed Call Forward Busy-Fixed	\$25.45

\* The Special Plan Bundle is available for \$23.20 when customers also subscribe to Embarq Communications, Inc. Solutions Unlimited – Option 1 plus either the Company's High Speed Internet (DSL), DISH Network® Satellite TV (video) or PCS.

# Privacy ID can be added to the Solutions Package at the monthly rate shown in Section 13.

<sup>2</sup> Talking Call Waiting can be added to this Solutions package at the monthly rate shown in Section A13.Z.

## GENERAL EXCHANGE TARIFF

Embarq Florida, Inc.

BY: F. B. Poag  
Director

SECTION A27  
First Revised Sheet 8  
Cancelling Original Sheet 8  
Effective: May 4, 2005

### SPECIAL PACKAGED OFFERINGS

#### B. SOLUTIONS - BUSINESS

##### 1. General

- a. Solutions is an optional business service enrollment plan. The Plan permits a customer to receive features and services for a flat monthly rate, for each Solutions Package business line provided. Solutions includes two or more of the following features and services:
  - 1) Flat Rate Basic Local Exchange Service;
  - 2) Either a 60 minute block of time for Message Telecommunications Service (Local Toll), with Business Sense Local Toll rates applicable for each additional minute; or the option of subscribing to Business Sense Local Toll Service with per minute of use rates applicable for all local toll minutes as specified in Section A18, D.4. of this tariff, and
  - 3) A Custom Calling Feature Package or an individual custom calling feature. Custom Calling Features and Packages are described in Section A13 of this tariff.

##### 2. Regulations

- a. Solutions customers may terminate their enrollment in the Plan at any time upon notice to the Company.
- b. Unless terminated by the Solutions customer or the Company, a customer will remain enrolled in the Plan, as amended from time-to-time, with any applicable changes in rate, for as long as the Plan continues to be offered by the Company.
- c. The Plan is not available with Business ISDN-BRI Service lines, in conjunction with Pay Telephone Service, to customers who are or become toll restricted or to customers with five (5) or more business lines per location. Rotary Hunt Service, as defined in Section A3, is not available in conjunction with the Plan unless Rotary Line Service is included in a specific Solutions Package. The Plan cannot terminate to a Key System, PBX or any other line trunking device. There can be only one business line per Solutions account and no more than three (3) Solutions accounts with the unlimited local calling option per location.
- d. No more than four (4) business lines can be enrolled with the Solutions option for each customer location, except for Sure Solution II, Priority Solution and Rotary Classic Solution with the unlimited local calling option, which may have no more than three (3) lines. Customers with the unlimited local calling option and who also have multiple locations must have each location billed on a separate account.



GENERAL EXCHANGE TARIFF

Embarq Florida, Inc.

BY: F. B. Poag  
Director

SECTION A27  
First Revised Sheet 9  
Cancelling Original Sheet 9  
Effective: May 4, 2005

SPECIAL PACKAGED OFFERINGS

B. SOLUTIONS – BUSINESS (Cont'd)

2. Regulations (Cont'd)

- e. Service Charges, as described in Section A4 of this tariff, apply to requests for new and additional Solutions lines, and moves of existing lines. Service Charges will not apply when Solutions replaces existing Local Exchange Service or if the customer requests a change from Solutions back to Local Exchange Service.
- f. Solutions customers are not eligible for promotional offerings associated with the Custom Calling Services included in the Plan, unless specifically provided for in a promotional offering.
- g. The Plan may not be combined with any other Business optional toll calling plan service.
- h. Business customers enrolled in the Plan, who subsequently become subject to Company initiated toll restriction will have all existing Solutions lines converted to the applicable tariff rates. The Service Charges will not apply for those existing lines converted, in-place, due to termination procedures. In addition, any optional services not affected by the termination procedures will convert to their applicable tariff rates. Such customers will not be permitted to re-enroll in this Plan until such time as all associated unpaid balances are satisfactorily paid in full.
- i. Prices of the individual services included in these packages may be higher or lower than the packaged offering.

GENERAL EXCHANGE TARIFF

Embarq Florida, Inc.

BY: F. B. Poag  
Director

SECTION A27  
Sixth Revised Sheet 10  
Cancelling Fifth Revised Sheet 10  
Effective: April 24, 2006

SPECIAL PACKAGED OFFERINGS

B. SOLUTIONS - BUSINESS (Cont'd)

3. Rates and Charges

a. Solutions Packages

	Monthly Rate*
1) <u>Sure Solution II</u> Local Exchange Service, Package 5, <sup>1</sup>	\$38.95
with unlimited expanded local calling option & measured/message ECS/EAS	\$43.95 <sup>2 3</sup>

\* Measured/message ECS/EAS charges, if applicable, as defined in Section A3 of this tariff, apply per each Solutions Package.

<sup>1</sup> Talking Call Waiting can be added to this Solutions package at the monthly rate shown in Section A13.2.3.b.

<sup>2</sup> Customers who subscribe to this service after 6/16/05 must also purchase the Company's Voicemail Service and Embarq Communications, Inc. Small Business Unlimited Solutions II Long Distance Plan. Customers who subscribed to this service prior to 6/16/05 must continue subscribing to Voicemail and either the grandfathered Embarq Communications, Inc. Small Business Unlimited Long Distance Plan or Small Business Unlimited Solutions II Long Distance Plan.

<sup>3</sup> Sure Solution II is available for \$35.00 when customers also subscribe to, the Company's High Speed Internet under a two-year commitment period and DSL Secure. Customers may add an additional Sure Solution II package with the unlimited local calling option and measured/message ECS/EAS for \$25.00.

GENERAL EXCHANGE TARIFF

Embarq Florida, Inc.

BY: F. B. Poag  
Director

SECTION A27  
Fourth Revised Sheet 11  
Cancelling Third Revised Sheet 11  
Effective: April 24, 2006

SPECIAL PACKAGED OFFERINGS

B. SOLUTIONS - BUSINESS (Cont'd)

3. Rates and Charges (Cont'd)

a. Solutions Packages (Cont'd)

	Monthly Rate*
8) <u>Priority Solution</u> Local Exchange Service, Package 9	\$34.95
with unlimited expanded local calling option & measured/message ECS/EAS)	\$39.93 <sup>2</sup>
9) <u>Economy Solution</u> <sup>1</sup> Local Exchange Service, Choice of two of the following: Call Forwarding Features (Call Forward Busy-Fixed plus Call Forward No Answer-Fixed) Enhanced Call Waiting Caller ID with Name Signal Ring	\$31.95
10) <u>Rotary Classic Solution</u> <sup>2</sup> Business Rotary Exchange Service Package 8 with unlimited expanded local calling option & measured/message ECS/EAS)	\$55.95
11) <u>Economy Bundle II A</u> <sup>1</sup> Local Exchange Service, Choice of three of the following: Call Forwarding Features (Call Forward Busy-Fixed, plus Call Forward No Answer-Fixed) Enhanced Call Waiting Caller ID with Name Three-Way Calling Return Call	\$33.95

\* Measured/message ECS/EAS charges, if applicable, as defined in Section A3 of this tariff, apply per each Solutions Package.

<sup>1</sup> Customers must also purchase any Embarq Communications, Inc. Long Distance Plan.

<sup>2</sup> Customers must also purchase the Company's Voicemail Service and Embarq Communications, Inc. Small Business Unlimited Solutions II Long Distance Plan. Customers who subscribed to this service prior to 6/16/05 must continue subscribing to Voicemail and either the grandfathered Embarq Communications, Inc. Small Business Unlimited Long Distance Plan or Small Business Unlimited Solutions II Long Distance Plan.

## GENERAL EXCHANGE TARIFF

Embarq Florida, Inc.

BY: F. B. Poag  
Director

SECTION A27  
Second Revised Sheet 11.1  
Cancelling First Revised Sheet 11.1  
Effective: April 24, 2006

### SPECIAL PACKAGED OFFERINGS

#### C. PRIMARY RATE INTERFACE (PRI) BUNDLE- BUSINESS

##### 1. General

- a. PRI Bundle is an optional business service enrollment plan. This offering permits a customer to receive features and services for a flat monthly rate for each bundle provided. PRI Bundle includes the following features and services:

- 1) Primary Rate Access Line
- 2) Primary Rate Interface (Two-Way)
- 3) Primary Rate Channels (24 Channels)
- 4) Up to 100 Direct Inward Dial (DID) Numbers (in blocks of 20) -Optional
- 5) Unlimited Extended Area Service (EAS) and Unlimited Extended Calling Scope (ECS) calls.
- 6) ISDN-PRI II Standard Features
- 7) Customers must subscribe to the Embarq Communications, Inc. 5,000 Minutes Block of Time.

##### 2. Regulations

- a. Unless specified otherwise in this section, the regulations for ISDN-PRI II Service, including Service Connection Charges, set forth in Section A29, apply in addition to the regulations herein.
- b. Unless specified otherwise in this section, the regulations for DID Service, including Non-recurring and Installation Charges, set forth in Section A16, apply in addition to the regulations herein.
- c. Service Charges do not apply when PRI Bundle replaces existing Local Exchange Service.
- d. Customers may activate all 100 DID numbers included in the bundle rate concurrent with installation of service or may activate the numbers in blocks of 20. When a customer activates fewer than 100 numbers concurrent with establishment of service, Service Charges do not apply for the initial or subsequent activations of 20-number blocks (up to 100 numbers).
- e. Customers may order additional DID numbers, in excess of 100 for an individual PRI Bundle, subject to availability, at the rates specified in Section A16 of this tariff. Non-recurring and Installation Charges apply for subsequent activation of numbers beyond those included in the bundle.
- f. The Optional Features available for ISDN-PRI II Service are available with PRI Bundle at the rates specified in Section A29.

GENERAL EXCHANGE TARIFF

Embarq Florida, Inc.

BY: F. B. Poag  
Director

SECTION A27  
First Revised Sheet 11.2  
Cancelling Original Sheet 11.2  
Effective: February 24, 2006

SPECIAL PACKAGED OFFERINGS

C. PRIMARY RATE INTERFACE (PRI) BUNDLE- BUSINESS (Continued)

2. Regulations (Continued)

- g. Customers may not use Unlimited EAS/ECS for continuous connection to the Internet or full-time data connections.
- h. PRI Bundle is available under the term commitments of 2 years, 3 years, and 5 years. Termination Liability Charges set forth in Section A-29 apply for PRI Bundle.
- i. Unless terminated by the PRI Bundle customer or the Company, a customer will remain enrolled in the PRI Bundle, as amended from time to time, with any applicable changes in rate, for as long as the PRI Bundle continues to be offered by the Company. If any features or services in the bundle are discontinued by the customer, the remaining features and services will be charged the normal tariff rate or charge.
- j. Customers enrolled in the bundle, who subsequently become subject to Company initiated toll restriction will have all existing PRI Bundle lines converted to the applicable tariff rates. Service Charges will not apply for those existing lines converted, in-place, due to termination procedures. In addition, any optional services not affected by the termination procedures will convert to their applicable tariff rates. Such customers will not be permitted to re-enroll in this bundle until such time as all associated unpaid balances are satisfactorily paid in full.

3. Rates and Charges

1) Term Commitment	Monthly Rate	Nonrecurring Charge
2 years	\$680.70	\$ 0.00
3 years	602.70	0.00
5 years	544.70	0.00

## GENERAL EXCHANGE TARIFF

Embarq Florida, Inc.

BY: F. B. Poag  
Director

SECTION A27  
Second Revised Sheet 12  
Cancelling First Revised Sheet 12  
Effective: February 24, 2006

### SPECIAL PACKAGED OFFERINGS

#### D. MARKET TRIALS

##### .1 Customer Rewards Program Market Trial

###### .a General

The Company will conduct a Customer Rewards Program market trial from November 28, 2005 through December 31, 2005. During the trial, residence customers who are already subscribed to any Solutions Residence Package (Bundle) plus any Embarq Communications, Inc. long distance plan and one or more of the qualifying services listed below will automatically be entered into the Customer Rewards Program. Customers who subscribe to these services during the trial period will also be automatically entered.

Qualifying services include: The Company's High-Speed Internet, DISH Network Satellite TV, PCS, CPE Warranty, LineGuard, Voicemail and Voicemail Plus.

###### .b Terms and Conditions

Customers who have continuously subscribed to all of the required services for six months after their entry into the Customer Rewards Program will receive rewards points as follows, redeemable towards the customers' choice of a gift card or merchandise:

- 1) Bundle plus 1 qualifying service = 25 rewards points;
- 2) Bundle plus 2 qualifying services = 40 rewards points;
- 3) Bundle plus 3 qualifying services = 60 rewards points.

Customers may earn up to 15 additional rewards points during their six-month retention period, through one or more of the following activities which are each worth five bonus points.

- 1) request to receive monthly invoices via e-mail
- 2) upgrade a Solutions package or add a qualifying service
- 3) submit an email address through the company's website opting to receive more information about Company services.

GENERAL EXCHANGE TARIFF

Embarq Florida, Inc.

BY: F. B. Poag  
Director

SECTION A27  
Second Revised Sheet 13  
Cancelling First Revised Sheet 13  
Effective: February 24, 2006

SPECIAL PACKAGED OFFERINGS

D. MARKET TRIALS (Cont'd)

.1 Customer Rewards Program Market Trial (Cont'd)

.c Benefits

- 1) 25 Point Level:
  - Bushnell Binoculars
  - KitchenAid Food Chopper
  - \$25 Brinkers International Gift Card
  - \$25 iTunes Song Download Card
  - \$25 Shell Gift Card
  
- 2) 40 Point Level:
  - SoundGear Sports Armband Radio
  - Thermos 60 can rolling cooler
  - \$40 American Express Gift Card
  - \$40 iTunes Song Download Card
  - \$40 Shell Gift Card
  
- 3) 60 Point Level:
  - Phillips MP3 Player
  - Krups Express Maker
  - \$60 American Express Gift Card
  - \$60 iTunes Song Download Card
  - \$60 Shell Gift Card

GENERAL EXCHANGE TARIFF

Embarq Florida, Inc.

SECTION A28

By: F.B. Poag  
Director

Seventh Revised Contents Sheet 1  
Cancelling Sixth Revised Contents Sheet 1  
Effective: January 6, 2004

DATA TRANSPORT SERVICE

	<u>SHEET</u>
A. 2GMAN - TALLAHASSEE .....	1
1. Description .....	1
2. Definitions .....	1
3. General Regulations .....	2
4. Obligations of the Company .....	4
5. Obligations of the Customer .....	5
6. Term Discount Plan (TDP).....	6
7. Service Components .....	7
8. Optional Features .....	8
9. Rates and Charges.....	10
B. ETHERNET SERVICES .....	13
1. General .....	13
2. Regulations .....	13
3. Term Discount Plan (TDP) .....	21
4. Service Components .....	23
5. Optional Features .....	23
6. Rates and Charges.....	24



## GENERAL EXCHANGE TARIFF

Embarq Florida, Inc.

By: F.B. Poag  
Director

SECTION A28  
Seventh Revised Sheet 1  
Cancelling Sixth Revised Sheet 1  
Effective: August 12, 2005

### DATA TRANSPORT SERVICE

#### A. 2GMAN - TALLAHASSEE

##### 1. Description

- a. 2GMAN - Tallahassee is a high-speed data service, which uses a shared fiber network to allow for the interconnection of Local Area Networks (LAN) across selected metropolitan areas. 2GMAN - Tallahassee delivers 1.544 Mbps, 10 Mbps, or 100 Mbps access from the customer's LAN to the shared 2GMAN - Tallahassee network. 2GMAN - Tallahassee protects data privacy by using specialized screening software, which permits subscribers to access only their data. 2GMAN - Tallahassee is offered for local and intraLATA use where Company facilities exist. 2GMAN - Tallahassee may be offered for intrastate interLATA use where Company facilities exist. This service is only available in the Company exchanges of Clermont, Crestview, Eustis, Fort Walton Beach, Leesburg, Ocala, Shalimar, Tallahassee, and Tavares.
- b. Utilizing the screening software, 2GMAN - Tallahassee inherently provides efficient handling of Internet Protocol (IP) traffic between subscriber locations by using network routers to direct traffic to its intended location within the subscriber's IP Virtual Private Network (VPN). Subscribers who do not utilize IP as their exclusive network protocol may subscribe to the optional Virtual LAN bridging feature. Subscribers who utilize Internetwork Packet Exchange (IPX) Protocol and desire more efficient handling of IPX traffic may subscribe to the optional IPX routing feature. IPX routing is not covered by any VPN policies. The IPX Protocol is provided only to the State of Florida connections.

##### 2. Definitions

Connection – The local loop from the Company serving central office to the customer premises.

IP-VPN – Internet Protocol is a secure connection between one or more multiple end points utilizing Transmission Control Protocol/Internet Protocol (TCP/IP) across a shared network infrastructure. The 2GMAN - Tallahassee inherently provides participation in an IP-VPN across two or more pre-determined subscriber locations. IP-VPN traffic is directed to its intended location by intelligent routing equipment in the 2GMAN - Tallahassee at Layer 3 and above of the Open System Interconnection (OSI) model. Open System Interconnection is a formal identification of all data communications network functions established by the International Standard Organization (ISO).

2GMAN – Tallahassee is a network that uses market-leading virtual private networking technologies to deliver Internet Protocol (IP) in the metropolitan areas of Tallahassee, Clermont, Crestview, Eustis, Fort Walton Beach, Leesburg, Ocala, Shalimar, Tallahassee, and Tavares, Florida.

## GENERAL EXCHANGE TARIFF

Embarq Florida, Inc.

By: F.B. Poag  
Director

SECTION A28  
Fourth Revised Sheet 2  
Cancelling Third Revised Sheet 2  
Effective: January 6, 2004

### DATA TRANSPORT SERVICE

#### A. 2GMAN - TALLAHASSEE<sup>SM</sup> (Cont'd)

##### 2. Definitions (Cont'd)

Local Access and Transport Area (LATA) - Denotes a geographic area established for the provision and administration of communications service. It encompasses one or more designated exchanges that are grouped to serve common social, economic, and other purposes.

Local Area Network (LAN) – A network permitting the interconnection and intercommunication of a group of computers, primarily for the sharing of resources such as data storage devices and printers.

Virtual LAN (VLAN) Bridging – A grouping of computers into a single broadcast domain. A VLAN may exist across multiple physical LAN segments, including multiple locations. The MPNS VLAN Bridging feature provides broadcasting of traffic within a subscriber's predefined group of locations at Layer 2 of the Open Systems Interconnection (OSI) model.

802.3 –. Colloquially known as Ethernet, 802.3 runs over coax, copper, or fiber at 10 megabits per second. It is a part of the body of LAN standards developed by the Institute of Electrical and Electronics Engineers, Inc. (IEEE).

802.3u – Also a LAN standard out of IEEE, known as Fast Ethernet, 802.3u typically runs over copper or fiber at 100 megabits per second.

802.5 – Also a LAN standard out of IEEE, known as Token Ring, 802.5 operates at 4 or 16 megabits per second.

##### 3. General Regulations

- a. The network demarcation point is an 802.3 (Ethernet), 802.3u (Fast Ethernet) or 802.5 (Token Ring) LAN interface on the 2GMAN – Tallahassee equipment at the subscriber premises. 2GMAN – Tallahassee network access for 802.3 and 802.5 interfaces is provided at T1 (1.544 Mbps) or 10 Mbps, while 802.3u network access is provided at 100 Mbps. For 10 Mbps access customers, 2GMAN – Tallahassee provides 802.5 to 802.3 conversion options at the customer's premises for subscribers requiring 802.5 interface to their LAN. IP customers can choose a mix of 802.3, 802.3u, and 802.5. VLAN subscribers must choose between 802.3/802.3u or 802.5 LAN standards.
- b. 2GMAN – Tallahassee is available to customers whose serving central office is equipped with 2GMAN – Tallahassee equipment and is located within 28km or 15 miles from the serving central office.
- c. 2GMAN – Tallahassee is only available through a Term Discount Plan for a fixed period of up to 84 months. The minimum service term for 2GMAN – Tallahassee is 12 months.
- d. Suspension of service at the customer's request, as defined in Section A2 of this tariff is not allowed for 2GMAN – Tallahassee.

GENERAL EXCHANGE TARIFF

Embarq Florida, Inc.

By: F.B. Poag  
Director

SECTION A28  
Seventh Revised Sheet 3  
Cancelling Sixth Revised Sheet 3  
Effective: August 12, 2005

DATA TRANSPORT SERVICE

A. 2GMAN - TALLAHASSEE (Cont'd)

3. General Regulations (Cont'd)

- e. The customer is responsible for providing cabling necessary to hookup to the 2GMAN – Tallahassee equipment and is responsible for placing all facilities and cabling required to get the 2GMAN – Tallahassee demarcation within the building.
- f. The customer will provide the necessary power to the Company with two (2) duplex isolated ground 20 amp. 120v. AC outlets. The outlets are to be within five (5) feet of the equipment. All electrical work must meet the National Electrical Code (NEC).
- g. The customer will provide a 19-inch equipment rack to house the Company provided Ethernet device(s).
- h. Conduit Space
  - (1) Exterior – The customer is responsible to ensure adequate conduit space is available to place fiber from the closest right-of-way into the main telephone room within a building.
  - (2) Interior – If the company provided equipment is to be located in space other than the telephone room, the customer is responsible to provide a two (2) inch interior conduit suitable to run fiber jumpers to the equipment.
- i. Access to Premises – The customer will provide the Company's maintenance personnel or contractors with access to the equipment for regular maintenance and service.
- j. Special Construction Charges, as defined in Section A5 of this tariff, may apply when technical limitations and/or the lack of facilities exist, or if it is necessary to construct facilities to satisfy service requests.

GENERAL EXCHANGE TARIFF

Embarq Florida, Inc.

By: F.B. Poag  
Director

SECTION A28  
Sixth Revised Sheet 4  
Cancelling Fifth Revised Sheet 4  
Effective: January 6, 2004

DATA TRANSPORT SERVICE

A. 2GMAN - TALLAHASSEE (Cont'd)

3. General Regulations (Cont'd)

k. Environment

- (1) Air – The customer is responsible to provide adequate cooling to maintain the equipment operating environment parameters as follows:

Temperature: 55-85 degrees Fahrenheit

Humidity: 70% or less.

- (2) Space – The customer is responsible to provide a clean environment free from flooding for the Company provided equipment.

- l. The sustained throughput for routed 2GMAN - Tallahassee connections may be limited by the standard CPE provided under the offering. Upgraded CPE is available to meet customer needs as required for an additional charge.

- m. The Primary Service Ordering Charge, as described in Section A4 of the General Exchange Tariff, does not apply to installs for 2GMAN-Tallahassee.

4. Obligations of the Company

- a. The responsibility of the Company is limited to furnishing network equipment suitable for 2GMAN – Tallahassee and to the maintenance and operation of such equipment in a manner proper for such service. Subject to this responsibility, the Company is not responsible for the through transmission of signals generated by the CPE or systems, or for the quality of, or defects in, such transmission or the reception of signals by such equipment or systems.
- b. The Company is not responsible for installation, operation or maintenance of any terminal equipment, data unit or communications system provided by a customer or user. The Company is not responsible for adapting 2GMAN – Tallahassee service to the technological requirements of any specific customer equipment.
- c. The Company is not responsible to the customer or user if changes in any of the equipment, operations or procedures of the Company used in the provision of 2GMAN – Tallahassee render any facilities provided by the customer or user obsolete or require modification or alteration of such equipment or system or otherwise affect its use or performance, provided the Company has met any applicable information disclosure requirements otherwise required by law.
- d. In order to maintain the quality of 2GMAN – Tallahassee service, the Company reserves the right to perform preventative maintenance and software updates to the network.

GENERAL EXCHANGE TARIFF

Embarq Florida, Inc.

By: F.B. Poag  
Director

SECTION A28  
Sixth Revised Sheet 5  
Cancelling Fifth Revised Sheet 5  
Effective: January 6, 2004

DATA TRANSPORT SERVICE

A. 2GMAN - TALLAHASSEE (Cont'd)

5. Obligations of the Customer

- a. Where 2GMAN – Tallahassee is available for use in connection with communication systems or equipment provided by a customer or user, the operating characteristics of such systems or equipment shall be such as not to interfere with any services offered by the Company. Such use is subject to the further provisions that the equipment provided by the customer or user does not endanger the safety of Company employees or the public; does not damage, harm, require change in or alteration of the equipment or other services of the Company; does not interfere with the proper operation of the Company's equipment; or does not otherwise injure the public in its use of Company services. Upon notice from the Company that the equipment provided by the customer or user is causing, or is likely to cause, such hazard or interference, the customer shall take the necessary steps to remove or prevent such hazard or interference.
- b. The customer, upon request, shall furnish such CPE information as may be required to permit the Company to design and maintain the 2GMAN – Tallahassee it offers and to assure regulations contained herein.

6. Term Discount Plan (TDP)

- a. The Term Discount Plan (TDP) provides the customer with flexible pricing options for the 2GMAN – Tallahassee Base Service. The customer agrees to a minimum service commitment period when the TDP is established. The customer must order a TDP in writing to the Company: A TDP may be ordered in increments of one month, based upon the following plan options:

Plan A: 12 to 35 months  
Plan B: 36 to 59 months  
Plan C: 60 to 84 months

- b. The customer must specify the length of the initial service period at the time the service is ordered. If a customer upgrades from one TDP to a longer term TDP, no administrative charges are applied.
- c. If a TDP customer under a Term Discount Plan (TDP) disconnects any portion of the 2GMAN – Tallahassee Base Service prior to the expiration of the TDP, then a Termination Liability Charge will apply to those elements that are disconnected. The Termination Liability Charge will be a one-time charge equal to the sum of 50% of the payments for the rest of the TDP. If Charges Applicable Under Special Conditions charges were applied to the service being terminated, any termination charges associated with the Charges Applicable Under Special Conditions will also apply.

GENERAL EXCHANGE TARIFF

Embarq Florida, Inc.

By: F.B. Poag  
Director

SECTION A28  
Sixth Revised Sheet 6  
Cancelling Fifth Revised Sheet 6  
Effective: January 6, 2004

DATA TRANSPORT SERVICE

A. 2GMAN - TALLAHASSEE (Cont'd)

6. Term Discount Plan (TDP) (Cont'd)

- d. Rate increases or decreases will automatically be applied to the remaining term plan rates for the remaining term of the TDP. If Company initiated rate increases to any rate element or combination of rate elements causes the charges for the entire 2GMAN – Tallahassee under the TDP to increase by 10% or more annually, then the customer may cancel the TDP without incurring termination liability charges provided the customer notifies the Company within 30 days after the effective date of the rate increase.
- e. TDP commitment periods can be extended by the customer at any time during the term of the plan, up to a maximum of 84 months. The number of months accrued in the current plan will be applied toward the new plan selected.
- f. Termination Liability Charges will not apply when a service or rate element under a TDP is disconnected prior to the expiration of a selected service period as a result of a change in tariff jurisdiction and/or a customer requested upgrade to a next generation service offering, under the following conditions:
  - (1) The service period of the new TDP for the new service offering is a period equal to or exceeding the remaining service period of the disconnected TDP, and
  - (2) The service orders to install the new service and disconnect the old service are related together, and there is no lapse in service between the installation of the new service and the disconnection of the old service, and
  - (3) The service orders to install the new service and disconnect the old service are for the same customer at the same location.

## GENERAL EXCHANGE TARIFF

Embarq Florida, Inc.

By: F.B. Poag  
Director

SECTION A28  
Fourth Revised Sheet 7  
Cancelling Third Revised Sheet 7  
Effective: January 6, 2004

### DATA TRANSPORT SERVICE

#### A. 2GMAN - TALLAHASSEE (Cont'd)

##### 7. Service Components

- a. Service Establishment Charge – A Service Establishment Charge applies to the initial location a subscriber establishes on 2GMAN – Tallahassee and is designed to reflect the costs of establishing a VLAN or IP-VPN profile and the 2GMAN – Tallahassee network. Subsequent locations that participate in an existing IP-VPN or VLAN do not incur the Service Establishment Charge. An IPX Establishment Charge applies to the initial location a subscriber establishes on 2GMAN – Tallahassee that utilizes IPX routing. Subsequent locations that participate in the existing IPX routing group do not incur the Service Establishment Charge. Nonrecurring charges apply for each service that terminates at the customer's premises except for Plan C.
- b. 2GMAN – Tallahassee Base Service – The 2GMAN – Tallahassee Base Service rates include the elements of demarcation, port electronics at the subscriber's premises, the local channel connection to the Company's 2GMAN – Tallahassee switching system function, and participation in a single IP-VPN. Charges are dependent upon the number of ports per building and the total number of ports per customer.
- c. VLAN Bridging - The VLAN bridging feature is exclusively for IP-VPN. A customer may either have a connection in an IP-VPN or in a VLAN, but not both. IPX, for the State of Florida only, can be added to the base IP-VPN service, but is not available with VLAN bridging. However, VLAN bridging itself will carry any traffic such as IP or IPX; it will not be routable.
- d. IPX Routing – The IPX routing feature may be used as an additional item to the basic service. IPX Establishment Charge applies to the initial location a subscriber establishes on the 2GMAN – Tallahassee that utilizes IPX routing. Subsequent locations that participate in an existing IPX routing group do not incur the Service Establishment Charge. The IPX Protocol is provided only to the State of Florida connections
- e. 802.3 to 802.5 services - 2GMAN – Tallahassee network access for 802.3 and 802.5 interfaces is provided at T1 (1.544 Mbps) or 10 Mbps, while 802.3u network access is provided at 100 Mbps. For 10 Mbps access customers, 2GMAN – Tallahassee provides 802.5 to 802.3 conversion options at the customer's premises for subscribers requiring 802.5 interface to their LAN. IP customers can choose a mix of 802.3, 802.3u, and 802.5. VLAN subscribers must choose between 802.3/802.3u or 802.5 LAN standards. 802.5 VLANs will be serviced by DLSw+, which provides for SNA and Netbios protocols exclusively.

## GENERAL EXCHANGE TARIFF

Embarq Florida, Inc.

By: F.B. Poag  
Director

SECTION A28  
Fourth Revised Sheet 8  
Cancelling Third Revised Sheet 8  
Effective: January 6, 2004

### DATA TRANSPORT SERVICE

#### A. 2GMAN - TALLAHASSEE (Cont'd)

##### 8. Optional Features

- a. Gateway Service – Allows 2GMAN – Tallahassee customer to interconnect to another internet network location. The service is available wherever the Company has established a network interface with another private or public location. Gateway Service is only available where such network connectivity exists or where suitable connectivity arrangements can be made that are acceptable to the Company. A customer utilizing Gateway Service will lose private VPN capability: their routes will by definition need to be globally available for internet access.
- b. 2nd Port for 10 Mb Connection permits the customer to utilize the second port on their CPE to access the single 10 Mb Ethernet connection they have purchased.
- c. 2nd Port for 100 Mb Connection permits the customer to utilize the second port on their CPE to access the single 100 Mb Ethernet connection they have purchased.
- d. 3rd Port for 100 Mb Connection permits the customer to utilize the third port on their CPE to access the single 100 Mb Ethernet connection they have purchased.
- e. Quality of Service (QoS) is an IP feature allowing the Company to mark packets according to their traffic type (usually broken down between voice/video and data), and then give priority across the backbone to the higher precedence packets. This ensures that delay-sensitive traffic such as voice and video will get delivered quickly and delay-insensitive traffic such as data will still get through, but can afford more time.
- f. IP Security (IPSec) is an IP feature that allows the Company to build secure encrypted tunnels between two points. The tunnels require trusted keys at both ends to complete setup. This feature will allow state agencies to meet federal mandates for end-to-end encryption of sensitive data such as criminal, health, and financial records traversing their WAN.
- g. Multicast – This feature will allow a customer to stream video conferences or events across the backbone in a one-to-many fashion, giving significant savings in bandwidth. Rather than create a separate instance for each viewer, one stream is pushed out to all viewers.



## GENERAL EXCHANGE TARIFF

Embarq Florida, Inc.

By: F.B. Poag  
Director

SECTION A28  
Fourth Revised Sheet 9  
Cancelling Third Revised Sheet 9  
Effective: January 6, 2004

### DATA TRANSPORT SERVICE

#### A. 2GMAN - TALLAHASSEE (Cont'd)

##### 8. Optional Features

- h. Network Address Translation (NAT) allows the Company to take private IP addresses (those not officially assigned by an Internet authority) and translate them into official IP addresses (usually assigned by the Company or the state). This allows significant IP address savings – a customer can privately use a large IP block but only have a small block of official IP addresses. This is primarily used for two situations: if the customer has a need for many hosts to connect to the network that will initiate requests only, and for additional security.
- i. Enhanced Filtering – This service will allow customers to design basic access lists, which the Company will then apply to their interfaces. The access lists can prevent certain traffic types from entering or leaving the customer network, or they may prevent certain IP addresses from doing the same. While not considered a true firewall, this feature will allow the customer more security than a wide-open pipe. The Company requires the customers to craft the access list themselves so there is no question of what access is required.
- j. Firewall – This is a Cisco operating system enhancement that gives true firewall features to the router, such as stateful packet inspection. This is the next step after the Enhanced Filtering service above and requirements for customer-crafted security configurations are identical. This feature allows customers to meet official security requirements that may not consider the Enhanced Filtering service to be sufficient.
- k. Dynamic Host Configuration Protocol (DHCP) allows centralized management of IP addressing and better control over limited address space. DHCP requires a client PC to simply set all IP configuration parameters to automatic, and a DHCP server will then supply the client with all pertinent information - IP address, subnet mask, default gateway, and many other possible settings.

If changes to the IP schema are necessary, all that must be updated are the records on the DHCP server. Customers can then reboot or refresh their DHCP information and the new changes will be distributed. DHCP also removes the need for personnel to know how to change their information when bringing a new PC online and/or traveling with a laptop to different network locations.

GENERAL EXCHANGE TARIFF

Embarq Florida, Inc.

By: F.B. Poag  
Director

SECTION A28  
Fifth Revised Sheet 10  
Cancelling Fourth Revised Sheet 10  
Effective: August 12, 2005

DATA TRANSPORT SERVICE

A. 2GMAN - TALLAHASSEE (Cont'd)

9. Rates and Charges<sup>1</sup>

		<u>NRC</u>		
		\$1,200.00		
a.	<u>Service Establishment Charge, per IP-VPN or VLAN</u>			
b.	<u>2GMAN – Tallahassee Base Service</u>	12-35 Month <u>Plan A</u>	36 - 59 Month <u>Plan B</u>	60 - 84 Month <u>Plan C</u>
(1)	<u>1 to 25 subscriber locations</u>			
	1.544 Mbps, Per Month	\$ 550.00	\$ 495.00	\$ 440.00
	1.544 Mbps, NRC	\$ 750.00	\$ 550.00	N/A
	10 Mbps, Per Month	\$ 880.00	\$ 690.00	\$ 605.00
	10 Mbps, NRC	\$ 750.00	\$ 550.00	N/A
	100 Mbps, Per Month	\$1,760.00	\$1,540.00	\$1,375.00
	100 Mbps, NRC	\$ 750.00	\$ 550.00	N/A
(2)	<u>26 to 249 subscriber locations</u>			
	1.544 Mbps, Per Month	\$ 495.00	\$ 445.00	\$ 395.00
	1.544 Mbps, NRC	\$ 750.00	\$ 550.00	N/A
	10 Mbps, Per Month	\$ 795.00	\$ 620.00	\$ 545.00
	10 Mbps, NRC	\$ 750.00	\$ 550.00	N/A
	100 Mbps, Per Month	\$1,585.00	\$1,385.00	\$1,245.00
	100 Mbps, NRC	\$ 750.00	\$ 550.00	N/A
(3)	<u>250 to 450 subscriber locations</u>			
	1.544 Mbps, Per Month	\$ 475.00	\$ 425.00	\$ 375.00
	1.544 Mbps, NRC	\$ 750.00	\$ 550.00	N/A
	10 Mbps, Per Month	\$ 750.00	\$ 585.00	\$ 515.00
	10 Mbps, NRC	\$ 750.00	\$ 550.00	N/A
	100 Mbps, Per Month	\$1,495.00	\$1,310.00	\$1,175.00
	100 Mbps, NRC	\$ 750.00	\$ 550.00	N/A
(4)	<u>Over 450 subscriber locations</u>	ICB	ICB	ICB

<sup>1</sup> The rates and charges listed above only apply to the Company exchanges of Crestview, Eustis, Fort Walton Beach, Shalimar, and Tallahassee. For customers located in the Company exchanges of Clermont, Leesburg, Ocala, and Tavares, the rates and charges will be provided on an Individual Case Basis (ICB).

GENERAL EXCHANGE TARIFF

Embarq Florida, Inc.

By: F.B. Poag  
Director

SECTION A28  
Fifth Revised Sheet 11  
Cancelling Fourth Revised Sheet 11  
Effective: August 12, 2005

DATA TRANSPORT SERVICE

A. 2GMAN - TALLAHASSEE (Cont'd)

9. Rates and Charges<sup>1</sup> (Cont'd)

c. Optional Features

	Monthly Rate	Customer Premises	NRC Central Office
(1) <u>VLAN Bridging location per VLAN</u>	\$ 50.00	NA	NA
Install subsequent to Service Establishment		NA	\$75.00
(2) <u>IPX Routing per location</u>	\$100.00	NA	NA
IPX Establishment Charge Initial location		\$1,500.00	NA
Install subsequent to IPX Establishment		\$ 75.00	NA
(3) <u>802.3 to 802.5 service for 10 Mbps access with 802.5 interface to customer's LAN</u>	\$ 55.00	\$ 75.00	NA
(4) <u>Gateway Service</u>	\$ 10.00	NA	\$ 50.00
(5) <u>2nd Port for 10 Mb Connection</u>	\$180.00	\$ 250.00	NA
(6) <u>2nd Port for 100 Mb Connection</u>	\$350.00	\$ 250.00	NA
(7) <u>3rd Port for 100 Mb Connection</u>	\$250.00	\$ 250.00	NA

<sup>1</sup> The rates and charges listed above only apply to the Company exchanges of Crestview, Eustis, Fort Walton Beach, Shalimar, and Tallahassee. For customers located in the Company exchanges of Clermont, Leesburg, Ocala, and Tavares, the rates and charges will be provided on an Individual Case Basis (ICB).

GENERAL EXCHANGE TARIFF

Embarq Florida, Inc.

By: F.B. Poag  
Director

SECTION A28  
Seventh Revised Sheet 12  
Cancelling Sixth Revised Sheet 12  
Effective: August 12, 2005

DATA TRANSPORT SERVICE

A. 2GMAN - TALLAHASSEE (Cont'd)

9. Rates and Charges<sup>1</sup> (Cont'd)

c. <u>Optional Features</u> (Cont'd)	Monthly <u>Rate</u>	NRC	
		<u>Customer Premises</u>	<u>Central Office</u>
(8) <u>Quality of Service</u>	\$ 35.00	\$100.00	\$250.00
(9) <u>IP Security</u>	\$ 75.00	\$150.00	\$275.00
(10) <u>Multicast</u>	\$ 35.00	\$ 50.00	\$350.00
(11) <u>Network Address Translation</u>	\$ 35.00	\$125.00	N/A
(12) <u>Enhanced Filtering</u>	\$ 35.00	\$150.00	N/A
(13) <u>Firewall</u>	\$ 75.00	\$100.00	\$150.00
(14) <u>Dynamic Host Configuration Protocol</u>	\$ 25.00	\$100.00	\$150.00
(15) <u>100 Mb Service Upgrade</u>	\$125.00	\$350.00	NA

<sup>1</sup> The rates and charges listed above only apply to the Company exchanges of Crestview, Eustis, Fort Walton Beach, Shalimar, and Tallahassee. For customers located in the Company exchanges of Clermont, Leesburg, Ocala, and Tavares, the rates and charges will be provided on an Individual Case Basis (ICB).

## GENERAL EXCHANGE TARIFF

Embarq Florida, Inc.

By: F.B. Poag  
Director

SECTION A28  
Fifth Revised Sheet 13  
Cancelling Fourth Revised Sheet 13  
Effective: August 12, 2005

### DATA TRANSPORT SERVICE

#### B. ETHERNET SERVICES

##### 1. General

- a. Ethernet Services is a high-speed data service, which uses a shared fiber network to allow for the interconnection of Local Area Networks (LAN) across selected metropolitan areas. Ethernet Services delivers 5 Mbps, 10 Mbps, 100 Mbps, 500 Mbps, and 1 Gigabit (1000 Mbps) access from the customer's LAN to the shared Ethernet Services network. Ethernet Services protects data privacy by using specialized screening software, which permits subscribers to access only their data. Ethernet Services is offered for local and intraLATA use where Company facilities exist. Ethernet Services may be offered for interLATA use where Company facilities exist.
- b. Ethernet Services is only available through a Term Discount Plan for a fixed period of up to 84 months. The minimum service term for Ethernet Services is 12 months.
- c. Suspension of service at the customer's request, as defined in Section A2 of this tariff is not allowed for Ethernet Services.
- d. Charges Applicable Under Special Conditions, as defined in Section A5 of this tariff, may apply when technical limitations and/or the lack of facilities exist, or if it is necessary to construct facilities to satisfy service requests.

##### 2. Regulations

###### a. Description of Service

- (1) Ethernet Services is available to customers whose serving central office is equipped with Ethernet Services equipment and is located within 28km or 15 miles from the serving central office.
- (2) The network demarcation point is an 802.3 (Ethernet), 802.3u (Fast Ethernet) or 802.3z (Gigabit Ethernet) LAN interface on the Ethernet Services equipment at the subscriber premises. Ethernet Services network access for 802.3 interface is provided at 10 Mbps, while 802.3u network access is provided at 100 Mbps and 802.3z network access is provided at 1 Gigabit (1000 Mbps). VLAN subscribers must choose between 802.3, 802.3u or 802.3z LAN standards.

## GENERAL EXCHANGE TARIFF

Embarq Florida, Inc.

By: F.B. Poag  
Director

SECTION A28  
Fourth Revised Sheet 14  
Cancelling Third Revised Sheet 14  
Effective: January 6, 2004

### DATA TRANSPORT SERVICE

#### B. ETHERNET SERVICES (Cont'd)

##### 2. Regulations (Cont'd)

###### b. Definitions

- (1) Local Channel Connection – The local loop from the Company's serving central office to the customer premises.
- (2) Local Access and Transport Area (LATA) - Denotes a geographic area established for the provision and administration of communications service. It encompasses one or more designated exchanges that are grouped to serve common social, economic, and other purposes.
- (3) Local Area Network (LAN) – A network permitting the interconnection and intercommunication of a group of computers, primarily for the sharing of resources such as data storage devices and printers.
- (4) 802.3 – Colloquially known as Ethernet, 802.3 runs over fiber at 10 megabits per second. It is a part of the body of LAN standards developed by the Institute of Electrical and Electronics Engineers, Inc. (IEEE).
- (5) 802.3u – A LAN standard out of IEEE, known as Fast Ethernet, 802.3u typically runs over fiber at 100 megabits per second.
- (6) 802.3z – A LAN standard out of IEEE, known as Gigabit Ethernet, 802.3z typically runs over fiber at 1000 megabits per second (1Gigabit).
- (7) Managed Service - Managed Service includes Ethernet Services Basic Transport, Provider Edge Equipment, and Managed Network Service. Basic Transport includes the demarcation, the port electronics at the subscriber's premises, the local channel connection to the Company's Ethernet Services switching system function, and participation in a single Virtual Private Network. Provider Edge Equipment allows for the convergence of multiple service options over one common facility for network aggregation. Managed Network Service provides 24x7 network monitoring and troubleshooting of network facilities.
- (8) VLAN - A VLAN is an identifier assigned to each customer group. VLAN ID's allow multiple customers to share a common infrastructure while maintaining separate LAN domains.

GENERAL EXCHANGE TARIFF

Embarq Florida, Inc.

By: F.B. Poag  
Director

SECTION A28  
Fourth Revised Sheet 15  
Cancelling Third Revised Sheet 15  
Effective: January 6, 2004

DATA TRANSPORT SERVICE

B. ETHERNET SERVICES (Cont'd)

2. Regulations (Cont'd)

c. Connections

- (1) Customer-Provided Terminal Equipment, Customer-Provided Derivation Equipment and Customer-Provided Communications Systems may be connected to Ethernet Services when such connection is made in accordance with the provisions specified in (2), (3) and (4) following.
- (2) Responsibility of the Company
  - (a) The responsibility of the Company shall be limited to the furnishing and maintenance of Ethernet Services to a network interface on the customer's premises where provision is made for the connection of local service.
  - (b) The Company shall not be responsible for installation, operation or maintenance of any terminal equipment or communications systems provided by the customer. Ethernet Services is not represented as adapted for the use of such equipment or system. Where such equipment or system is connected to Company facilities, the responsibility of the Company shall be limited to the furnishing of facilities suitable for Ethernet Services and to the maintenance and operation in a manner proper for such digital service. The Company shall not be responsible for:
    - The through transmission of signals generated by such equipment or system, or for the quality of, or defects in, such transmission, or
    - The reception of signals by such equipment or systems, or
    - Damage to terminal equipment or communications systems provided by a customer or authorized user due to testing.
  - (c) The Company shall not be responsible to the customer if changes in any of the facilities, operations or procedures of the Company utilized in the provision of Ethernet Services render any facilities or equipment provided by a customer obsolete, or require modification or alteration of such equipment or system or otherwise affects its use or performance.

GENERAL EXCHANGE TARIFF

Embarq Florida, Inc.

By: F.B. Poag  
Director

SECTION A28  
Fourth Revised Sheet 16  
Cancelling Third Revised Sheet 16  
Effective: January 6, 2004

DATA TRANSPORT SERVICE

B. ETHERNET SERVICES (Cont'd)

2. Regulations (Cont'd)

c. Connections (Cont'd)

(2) Responsibility of the Company (Cont'd)

(d) The Company is responsible for maintaining and repairing the facilities it furnishes. The customer may not rearrange, disconnect, remove or attempt to repair any equipment installed by the Company without prior written consent of the Company.

(e) In order to maintain the quality of Ethernet Services, the Company reserves the right to perform preventative maintenance and software updates to the network. The Company has classified maintenance as follows:

(i) Scheduled Maintenance

Scheduled maintenance is performed for functions such as hardware and software upgrades and network optimization. The Company will perform these tasks in a maintenance window that is anticipated to minimize disruption of customer service and activity. The Company will provide advance notice of all scheduled maintenance.

(ii) Demand Maintenance

Demand maintenance may occur as a result of unexpected events and is performed when Ethernet Services network elements are in jeopardy. The Company will perform this type of maintenance at its discretion. Due to the nature of demand maintenance, prior notification may not be possible; however, the customer will be informed when the maintenance has been completed.



GENERAL EXCHANGE TARIFF

Embarq Florida, Inc.

BY: F. B. Poag  
Director

SECTION A28  
Fifth Revised Sheet 17  
Cancelling Fourth Revised Sheet 17  
Effective: August 12, 2005

DATA TRANSPORT SERVICE

B. ETHERNET SERVICES (Cont'd)

2. Regulations (Cont'd)

c. Connections (Cont'd)

(3) Responsibility of the Customer

- (a) The customer is responsible for installing and testing the customer premises equipment or facilities to insure that when they are connected to Ethernet Services such equipment or facilities are operating properly.
- (b) The operating characteristics of the customer premises equipment or facilities shall be such as to not interfere with any of the services offered by the Company. Such use is subject to the further provisions that the equipment provided by a customer does not: endanger the safety of Company employees or the public; damage, require change in or alteration of the equipment or other facilities of the Company; interfere with the proper functioning of such equipment or facilities; impair the operation of the Company's facilities or otherwise injure the public in its use of the Company's services. Upon notice that the equipment provided by a customer is causing or is likely to cause such hazard or interference, the customer shall take such steps as shall be necessary to remove or prevent such hazard or interference.
- (c) The customer's responsibility shall include cooperative testing with the Company as may be necessary. Where regeneration and/or equalization adjustments or changes may be required to compensate for rearrangements and/or changes in outside plant facilities, the customer will be responsible for all expenses incurred in changes to his customer premises equipment.
- (d) The customer must provide the necessary power to the Company with two (2) duplex isolated ground 20 amp. 120v. AC outlets. The outlets must be within five (5) feet of the equipment. All electrical work must meet the National Electrical Code (NEC).
- (e) The customer will provide a 19-inch rack to house the Company provided Managed Service Ethernet device(s).

GENERAL EXCHANGE TARIFF

Embarq Florida, Inc.

BY: F. B. Poag  
Director

SECTION A28  
Fourth Revised Sheet 18  
Cancelling Third Revised Sheet 18  
Effective: January 6, 2004

DATA TRANSPORT SERVICE

B. ETHERNET SERVICES (Cont'd)

2. Regulations (Cont'd)

c. Connections (Cont'd)

(3) Responsibility of the Customer (Cont'd)

(f) Conduit Space

- (i) Exterior – The customer is responsible to ensure adequate conduit space is available to place fiber from the closest right-of-way into the main telephone room within a building.
- (ii) Interior – If the Company provided equipment is to be located in space other than the telephone room, the customer is responsible to provide a two (2) inch interior conduit suitable to run fiber jumpers to the equipment.

(g) Environment

- (i) Air – The customer is responsible to provide adequate cooling to maintain the equipment operating environment parameters as follows:

Temperature: 55-85 degrees Fahrenheit  
Humidity: 70% or less.

- (ii) Space – The customer is responsible to provide a clean environment free from flooding for the Company provided equipment.

(4) Connection of Customer-Provided Terminal Equipment, Customer-Provided Derivation Equipment and Customer-Provided Communications Systems

(a) The following provisions will apply:

- (i) Customer-Provided Terminal Equipment and/or Customer-Provided Communications Systems may be connected at the premises of the customer to Ethernet Services.

GENERAL EXCHANGE TARIFF

Embarq Florida, Inc.

BY: F. B. Poag  
Director

SECTION A28  
Fourth Revised Sheet 19  
Cancelling Third Revised Sheet 19  
Effective: January 6, 2004

DATA TRANSPORT SERVICE

B. ETHERNET SERVICES (Cont'd)

2. Regulations (Cont'd)

c. Connections (Cont'd)

(4) Connection of Customer-Provided (Cont'd)

(a) The following provisions will apply: (Cont'd)

(ii) The customers, by use of their own derivation equipment, may create digital bit streams from Ethernet Services and such equipment may be connected for transmission of such bit streams when connected through a customer-provided CSU.

(iii) The undertaking of the Company is to furnish Ethernet Services as ordered and specified by the customer except as specified in (d) following.

(b) Connections to Other Services Furnished by the Company to the Same Customer

Ethernet Services furnished by the Company may be connected by the customer to another service or to other services furnished by the Company as specified in (2) preceding. Connected services are subject to all rules and regulations governing the provisioning of those services.

(c) Connections to Other Services Furnished by the Company to Different Customers

The customer may connect at the premises of the customer, to another Ethernet Services or other services furnished by the Company to different customers as specified in (2) preceding. Connected services are subject to all rules and regulations governing provisioning of those services.

(d) Connection of Channel Service Units

A Channel Service Unit (CSU) or appropriate termination equipment must be provided by the customer to connect a Company-provided digital facility. This equipment must comply with the technical requirements outlined in Part 68 of the FCC Rules and Regulations.

GENERAL EXCHANGE TARIFF

Embarq Florida, Inc.

BY: F. B. Poag  
Director

SECTION A28  
Fourth Revised Sheet 20  
Cancelling Third Revised Sheet 20  
Effective: January 6, 2004

DATA TRANSPORT SERVICE

B. ETHERNET SERVICES (Cont'd)

2. Regulations (Cont'd)

c. Connections (Cont'd)

(4) Connection of Customer-Provided ... (Cont'd)

- (e) The customer shall be responsible for payment of a Trouble Location Charge, as set forth in Section A4 of this tariff, for visits by the Company to the customer's premises where the service difficulty or trouble report results from the use of equipment or facilities provided by the customer.
- (f) The customer may not rearrange, disconnect, remove or attempt to repair any equipment installed by the Company without the prior written consent of the Company.
- (g) For maintenance purposes, upon request of the Company, the customer will be responsible for notifying the Company of the type of digital terminating equipment used.

GENERAL EXCHANGE TARIFF

Embarq Florida, Inc.

By: F.B. Poag  
Director

SECTION A28  
Fourth Revised Sheet 21  
Cancelling Third Revised Sheet 21  
Effective: January 6, 2004

DATA TRANSPORT SERVICE

B. ETHERNET SERVICES (Cont'd)

3. Term Discount Plan (TDP)

- a. The minimum service period is 12 months. A Term Discount Plan (TDP) provides the customer with flexible pricing options for the Ethernet Services. The customer agrees to a minimum service commitment period when the TDP is established. The customer must order a TDP in writing to the Company: A TDP may be ordered in increments of one month, based upon the following plan options:

Plan A: 12 to 35 months  
Plan B: 36 to 59 months  
Plan C: 60 to 84 months

- b. The customer must specify the length of the initial service period at the time the service is ordered. At the end of the term plan the customer may subscribe to a new term plan at the prevailing rates set forth in Section A28.B.6. following. If the customer does not specify renewal terms in writing 90 days prior to the expiration of the 36 to 59 months or the 60 to 84 months service period, the commitment period and Ethernet Services rates for the 12 to 35 months term will automatically be applied. If the customer does not specify renewal terms in writing prior to the expiration of the 12 to 35 months service period, the commitment period and the Ethernet Services rates in effect at the time of expiration will automatically renew. The customer can terminate Ethernet Services at the end of the minimum commitment period with no penalty or obligation to continue the service.
- c. If a TDP customer under a Term Discount Plan (TDP) disconnects any portion of the Ethernet Services prior to the expiration of the TDP, then a Termination Liability Charge will apply to those elements that are disconnected. The Termination Liability Charge will be a one-time charge equal to the sum of 50% of the payments for the rest of the TDP. If Charges Applicable Under Special Conditions charges were applied to the service being terminated, any termination charges associated with the Charges Applicable Under Special Conditions will also apply.

GENERAL EXCHANGE TARIFF

Embarq Florida, Inc.

By: F.B. Poag  
Director

SECTION A28  
Third Revised Sheet 22  
Cancelling Second Revised Sheet 22  
Effective: January 6, 2004

DATA TRANSPORT SERVICE

B. ETHERNET SERVICES (Cont'd)

3. Term Discount Plan (TDP) (Cont'd)

- d. Rate increases or decreases will automatically be applied to the remaining term plan rates for the remaining term of the TDP. If Company initiated rate increases to any rate element or combination of rate elements causes the charges for the entire Ethernet Services under the TDP to increase by 10% or more annually, then the customer may cancel the TDP without incurring termination liability charges provided the customer notifies the Company within 30 days after the effective date of the rate increase.
- e. TDP commitment periods can be extended by the customer at any time during the term of the plan, up to a maximum of 84 months. The number of months accrued in the current plan will be applied toward the new plan selected.
- f. Termination Liability Charges will not apply when a service or rate element under a TDP is disconnected prior to the expiration of a selected service period as a result of a change in tariff jurisdiction and/or a customer requested upgrade to a next generation service offering, under the following conditions:
  - (1) The service period of the new TDP for the new service offering is a period equal to or exceeding the remaining service period of the disconnected TDP, and
  - (2) The service orders to install the new service and disconnect the old service are related together, and there is no lapse in service between the installation of the new service and the disconnection of the old service, and
  - (3) The service orders to install the new service and disconnect the old service are for the same customer at the same location.
- g. The Company will determine whether the replacement service qualifies as a next generation service offering.
- h. Nonrecurring charges and Service Ordering Charges for the new service will apply according to the requirements of the new service.

GENERAL EXCHANGE TARIFF

Embarq Florida, Inc.

By: F.B. Poag  
Director

SECTION A28  
Fourth Revised Sheet 23  
Cancelling Third Revised Sheet 23  
Effective: January 6, 2004

DATA TRANSPORT SERVICE

B. ETHERNET SERVICES (Cont'd)

4. Service Components

- a. Ethernet Services Basic Transport includes the elements of demarcation, port electronics at the subscriber's premises, the local channel connection to the Company's Ethernet Services switching system function, and participation in a single Virtual Private Network. Charges are dependent upon the number of ports per building and the total number of ports per customer.
- b. Managed Service - The components for Managed Service include the following:
  - Ethernet Services Basic Transport at speeds of 5 Mbps, 10 Mbps, 100 Mbps, 500 Mbps, and 1000 Mbps (1 Gigabit)
  - Provider Edge Equipment (Ethernet switch) to be installed at customer's premises
  - Managed Network Services to include 24x7 monitoring and troubleshooting of the network facility

5. Optional Features

- a. Inter-working with Frame Relay Service or ATM Service - This feature allows the customer with a Frame Relay or Asynchronous Transfer Mode local channel to connect with the Ethernet Services network at the Company's central office.

GENERAL EXCHANGE TARIFF

Embarq Florida, Inc.

By: F.B. Poag  
Director

SECTION A28  
Fourth Revised Sheet 24  
Cancelling Third Revised Sheet 24  
Effective: August 12, 2005

DATA TRANSPORT SERVICE

B. ETHERNET SERVICES (Cont'd)

6. Rates and Charges<sup>1</sup>

a. Ethernet Services Basic Transport

	<u>Monthly Rate</u>	<u>Nonrecurring Charge</u>
(1) <u>1 to 3 subscriber locations</u>		
5 Mbps		
12-35 months	\$1,495.00	\$750.00
36-59 months	\$1,395.00	\$0.00
60-84 months	\$1,295.00	\$0.00
10 Mbps		
12-35 months	\$1,795.00	\$750.00
36-59 months	\$1,695.00	\$0.00
60-84 months	\$1,595.00	\$0.00
100 Mbps		
12-35 months	\$2,495.00	\$750.00
36-59 months	\$2,345.00	\$0.00
60-84 months	\$2,195.00	\$0.00
500 Mbps		
12-35 months	\$3,395.00	\$950.00
36-59 months	\$3,195.00	\$0.00
60-84 months	\$2,995.00	\$0.00
1000 Mbps (Gigabit)		
12-35 months	\$4,195.00	\$950.00
36-59 months	\$3,995.00	\$0.00
60-84 months	\$3,795.00	\$0.00
(2) <u>Over 3 subscriber locations</u>	ICB	ICB

<sup>1</sup> Customers who subscribe to this service after August 12, 2005 will be rated on an Individual Case Basis (ICB).



GENERAL EXCHANGE TARIFF

Embarq Florida, Inc.

By: F.B. Poag  
Director

SECTION A28  
Fourth Revised Sheet 25  
Cancelling Third Revised Sheet 25  
Effective: August 12, 2005

DATA TRANSPORT SERVICE

B. ETHERNET SERVICES (Cont'd)

6. Rates and Charges<sup>1</sup> (Cont'd)

b. Managed Service, per VLAN (includes Ethernet Services Basic Transport, Provider Edge Equipment and Managed Network Services)

	<u>Monthly Rate</u>	<u>Nonrecurring Charge</u>
(1) <u>1 to 3 subscriber locations</u>		
5 Mbps		
12-35 months	\$1,595.00	\$750.00
36-59 months	\$1,495.00	\$0.00
60-84 months	\$1,395.00	\$0.00
10 Mbps		
12-35 months	\$1,895.00	\$750.00
36-59 months	\$1,795.00	\$0.00
60-84 months	\$1,695.00	\$0.00
100 Mbps		
12-35 months	\$2,645.00	\$750.00
36-59 months	\$2,495.00	\$0.00
60-84 months	\$2,345.00	\$0.00
500 Mbps		
12-35 months	\$3,545.00	\$950.00
36-59 months	\$3,345.00	\$0.00
60-84 months	\$3,145.00	\$0.00
1000 Mbps ( Gigabit)		
12-35 months	\$4,345.00	\$950.00
36-59 months	\$4,145.00	\$0.00
60-84 months	\$3,945.00	\$0.00
(2) <u>Over 3 subscriber locations</u>	ICB	ICB

<sup>1</sup> Customers who subscribe to this service after August 12, 2005 will be rated on an Individual Case Basis (ICB).

GENERAL EXCHANGE TARIFF

Embarq Florida, Inc.

By: F.B. Poag  
Director

SECTION A28  
Fourth Revised Sheet 26  
Cancelling Third Revised Sheet 26  
Effective: August 12, 2005

DATA TRANSPORT SERVICE

B. ETHERNET SERVICES (Cont'd)

6. Rates and Charges<sup>2</sup> (Cont'd)

c. Optional Features<sup>1</sup>

	<u>Monthly Rate</u>	<u>Nonrecurring Charges</u>
(1) <u>Interworking with Frame Relay or ATM</u>		
(a) 56 Kbps	\$7.00	\$0.00
(b) 128 Kbps	\$10.00	\$0.00
(c) 256 Kbps	\$15.00	\$0.00
(d) 512 Kbps	\$18.00	\$0.00
(e) 1.544 Mbps	\$25.00	\$0.00
(f) 44.736 Mbps	\$665.00	\$0.00

d. Nonrecurring Charge

The Nonrecurring Charge is applicable for the initial installation of a local channel connection to a given serving central office. The Nonrecurring Charge is also applicable for any rearrangement of an existing local channel connection.

e. Move Charge

A Move Charge applies for local channel connection moved to a new location, even when moved on the same premises. The Move Charge is equal to the Nonrecurring Charge and applies in addition to the Primary Service Ordering Charge located in Section A4 of this tariff.

f. Service Charge

A Primary Service Ordering Charge as set forth in Section A4 of this tariff is applicable per customer request. Nonrecurring Charges specified in this tariff section are in lieu of all other Service Ordering Charges.

<sup>1</sup> The Optional Features listed above are only available with Managed Service.

<sup>2</sup> Customers who subscribe to this service after August 12, 2005 will be rated on an Individual Case Basis (ICB).

GENERAL EXCHANGE TARIFF

Embarq Florida, Inc.

By: F.B. Poag  
Director

SECTION A28  
Second Revised Sheet 27  
Cancelling First Revised Sheet 27  
Effective: September 18, 2002

DATA TRANSPORT SERVICE

RESERVED FOR FUTURE USE

GENERAL EXCHANGE TARIFF

Embarq Florida, Inc.

By: F.B. Poag  
Director

SECTION A28  
Second Revised Sheet 28  
Cancelling First Revised Sheet 28  
Effective: September 18, 2002

DATA TRANSPORT SERVICE

RESERVED FOR FUTURE USE

GENERAL EXCHANGE TARIFF

Embarq Florida, Inc.

By: F.B. Poag  
Director

SECTION A28  
Second Revised Sheet 29  
Cancelling First Revised Sheet 29  
Effective: September 18, 2002

DATA TRANSPORT SERVICE

RESERVED FOR FUTURE USE

GENERAL EXCHANGE TARIFF

Embarq Florida, Inc.

By: F.B. Poag  
Director

SECTION A28  
Second Revised Sheet 30  
Cancelling First Revised Sheet 30  
Effective: September 18, 2002

DATA TRANSPORT SERVICE

RESERVED FOR FUTURE USE

GENERAL EXCHANGE TARIFF

Embarq Florida, Inc.

By: F.B. Poag  
Director

SECTION A28  
Second Revised Sheet 31  
Cancelling First Revised Sheet 31  
Effective: September 18, 2002

DATA TRANSPORT SERVICE

RESERVED FOR FUTURE USE

GENERAL EXCHANGE TARIFF

Embarq Florida, Inc.

By: F.B. Poag  
Director

SECTION A28  
Second Revised Sheet 32  
Cancelling First Revised Sheet 32  
Effective: September 18, 2002

DATA TRANSPORT SERVICE

RESERVED FOR FUTURE USE



GENERAL EXCHANGE TARIFF

Embarq Florida, Inc.

By: F.B. Poag  
Director

SECTION A28  
Second Revised Sheet 33  
Cancelling First Revised Sheet 33  
Effective: September 18, 2002

DATA TRANSPORT SERVICE

RESERVED FOR FUTURE USE

GENERAL EXCHANGE TARIFF

Embarq Florida, Inc.

By: F.B. Poag  
Director

SECTION A28  
Second Revised Sheet 34  
Cancelling First Revised Sheet 34  
Effective: September 18, 2002

DATA TRANSPORT SERVICE

RESERVED FOR FUTURE USE

GENERAL EXCHANGE TARIFF

Embarq Florida, Inc.

By: F.B. Poag  
Director

SECTION A28  
Third Revised Sheet 35  
Cancelling Second Revised Sheet 35  
Effective: September 18, 2002

DATA TRANSPORT SERVICE

RESERVED FOR FUTURE USE

GENERAL EXCHANGE TARIFF

Embarq Florida, Inc.

By: F.B. Poag  
Director

SECTION A28  
Second Revised Sheet 36  
Cancelling First Revised Sheet 36  
Effective: September 18, 2002

DATA TRANSPORT SERVICE

RESERVED FOR FUTURE USE

GENERAL EXCHANGE TARIFF

Embarq Florida, Inc.

SECTION A29

By: F. B. Poag  
Director

Sixth Revised Contents Sheet 1  
Cancelling Fifth Revised Contents Sheet 1  
Effective: January 28, 2002

DIGITAL NETWORK SERVICES

CONTENTS

A.	RESERVED FOR FUTURE USE	
B.	INTEGRATED SERVICES DIGITAL NETWORK-PRIMARY RATE INTERFACE (ISDN-PRI) II	24.1
	1. General	24.1
	2. Regulations	24.1
	3. Definitions	24.4
	4. Features	24.5
	5. Service Components	24.7
	6. Application of Rates	24.7.1
	7. Rates and Charges	24.8
C.	INTEGRATED SERVICES DIGITAL NETWORK - BASIC RATE INTERFACE (ISDN-BRI)	25
	1. General	25
	2. Regulations	
	3. System Features	
	4. Rates and Charges	
D.	ASYNCHRONOUS TRANSFER MODE (ATM)	36
	1. Description	36
	2. Definitions	40
	3. General Regulations	46
	4. Obligations of Company	47
	5. Obligations of Customer	48
	6. Term Discount Plan (TDP)	49
	7. Service Components	51
	8. Rates and Charges	53
E.	ENHANCED FRAME RELAY	61
	1. Description	61
	2. Definitions	63
	3. General Regulations	68
	4. Obligations of the Company	70
	5. Obligations of the Customer	71
	6. Term Discount Plan (TDP)	73
	7. Service Components	74
	8. Rates and Charges	77

GENERAL EXCHANGE TARIFF

Embarq Florida, Inc.

By: F. B. Poag  
Director

SECTION A29  
Second Revised Sheet 1  
Cancelling First Revised Sheet 1  
Effective: April 15, 2001

DIGITAL NETWORK SERVICES

RESERVED FOR FUTURE USE

GENERAL EXCHANGE TARIFF

Embarq Florida, Inc.

By: F. B. Poag  
Director

SECTION A29  
Second Revised Sheet 2  
Cancelling First Revised Sheet 2  
Effective: April 15, 2001

DIGITAL NETWORK SERVICES

RESERVED FOR FUTURE USE

GENERAL EXCHANGE TARIFF

Embarq Florida, Inc.

By: F. B. Poag  
Director

SECTION A29  
Second Revised Sheet 3  
Cancelling First Revised Sheet 3  
Effective: April 15, 2001

DIGITAL NETWORK SERVICES

RESERVED FOR FUTURE USE



GENERAL EXCHANGE TARIFF

Embarq Florida, Inc.

By: F. B. Poag  
Director

SECTION A29  
Second Revised Sheet 4  
Cancelling First Revised Sheet 4  
Effective: April 15, 2001

DIGITAL NETWORK SERVICES

RESERVED FOR FUTURE USE

GENERAL EXCHANGE TARIFF

Embarq Florida, Inc.

By: F. B. Poag  
Director

SECTION A29  
Second Revised Sheet 5  
Cancelling First Revised Sheet 5  
Effective: April 15, 2001

DIGITAL NETWORK SERVICES

RESERVED FOR FUTURE USE

GENERAL EXCHANGE TARIFF

Embarq Florida, Inc.

By: F. B. Poag  
Director

SECTION A29  
Second Revised Sheet 6  
Cancelling First Revised Sheet 6  
Effective: April 15, 2001

DIGITAL NETWORK SERVICES

RESERVED FOR FUTURE USE

GENERAL EXCHANGE TARIFF

Embarq Florida, Inc.

By: F. B. Poag  
Director

SECTION A29  
Second Revised Sheet 7  
Cancelling First Revised Sheet 7  
Effective: April 15, 2001

DIGITAL NETWORK SERVICES

RESERVED FOR FUTURE USE

GENERAL EXCHANGE TARIFF

Embarq Florida, Inc.

By: F. B. Poag  
Director

SECTION A29  
Second Revised Sheet 8  
Cancelling First Revised Sheet 8  
Effective: April 15, 2001

DIGITAL NETWORK SERVICES

RESERVED FOR FUTURE USE

GENERAL EXCHANGE TARIFF

Embarq Florida, Inc.

By: F. B. Poag  
Director

SECTION A29  
Second Revised Sheet 9  
Cancelling First Revised Sheet 9  
Effective: April 15, 2001

DIGITAL NETWORK SERVICES

RESERVED FOR FUTURE USE

GENERAL EXCHANGE TARIFF

Embarq Florida, Inc.

By: F. B. Poag  
Director

SECTION A29  
Second Revised Sheet 10  
Cancelling First Revised Sheet 10  
Effective: April 15, 2001

DIGITAL NETWORK SERVICES

RESERVED FOR FUTURE USE

GENERAL EXCHANGE TARIFF

Embarq Florida, Inc.

By: F. B. Poag  
Director

SECTION A29  
Second Revised Sheet 11  
Cancelling First Revised Sheet 11  
Effective: April 15, 2001

DIGITAL NETWORK SERVICES

RESERVED FOR FUTURE USE



GENERAL EXCHANGE TARIFF

Embarq Florida, Inc.

By: F. B. Poag  
Director

SECTION A29  
Second Revised Sheet 12  
Cancelling First Revised Sheet 12  
Effective: April 15, 2001

DIGITAL NETWORK SERVICES

RESERVED FOR FUTURE USE

GENERAL EXCHANGE TARIFF

Embarq Florida, Inc.

By: F. B. Poag  
Director

SECTION A29  
Second Revised Sheet 13  
Cancelling First Revised Sheet 13  
Effective: April 15, 2001

DIGITAL NETWORK SERVICES

RESERVED FOR FUTURE USE

GENERAL EXCHANGE TARIFF

Embarq Florida, Inc.

By: F. B. Poag  
Director

SECTION A29  
Second Revised Sheet 14  
Cancelling First Revised Sheet 14  
Effective: April 15, 2001

DIGITAL NETWORK SERVICES

RESERVED FOR FUTURE USE

GENERAL EXCHANGE TARIFF

Embarq Florida, Inc.

By: F. B. Poag  
Director

SECTION A29  
Second Revised Sheet 15  
Cancelling First Revised Sheet 15  
Effective: November 17, 2001

DIGITAL NETWORK SERVICES

RESERVED FOR FUTURE USE

GENERAL EXCHANGE TARIFF

Embarq Florida, Inc.

By: F. B. Poag  
Director

SECTION A29  
Second Revised Sheet 16  
Cancelling First Revised Sheet 16  
Effective: November 17, 2001

DIGITAL NETWORK SERVICES

RESERVED FOR FUTURE USE

GENERAL EXCHANGE TARIFF

Embarq Florida, Inc.

By: F. B. Poag  
Director

SECTION A29  
Second Revised Sheet 17  
Cancelling First Revised Sheet 17  
Effective: November 17, 2001

DIGITAL NETWORK SERVICES

RESERVED FOR FUTURE USE

GENERAL EXCHANGE TARIFF

Embarq Florida, Inc.

By: F. B. Poag  
Director

SECTION A29  
Third Revised Sheet 18  
Cancelling Second Revised Sheet 18  
Effective: November 17, 2001

DIGITAL NETWORK SERVICES

RESERVED FOR FUTURE USE

GENERAL EXCHANGE TARIFF

Embarq Florida, Inc.

By: F. B. Poag  
Director

SECTION A29  
Second Revised Sheet 19  
Cancelling First Revised Sheet 19  
Effective: November 17, 2001

DIGITAL NETWORK SERVICES

RESERVED FOR FUTURE USE



GENERAL EXCHANGE TARIFF

Embarq Florida, Inc.

By: F. B. Poag  
Director

SECTION A29  
Second Revised Sheet 20  
Cancelling First Revised Sheet 20  
Effective: November 17, 2001

DIGITAL NETWORK SERVICES

RESERVED FOR FUTURE USE

GENERAL EXCHANGE TARIFF

Embarq Florida, Inc.

By: F. B. Poag  
Director

SECTION A29  
Second Revised Sheet 21  
Cancelling First Revised Sheet 21  
Effective: November 17, 2001

DIGITAL NETWORK SERVICES

RESERVED FOR FUTURE USE

GENERAL EXCHANGE TARIFF

Embarq Florida, Inc.

By: F. B. Poag  
Director

SECTION A29  
Second Revised Sheet 22  
Cancelling First Revised Sheet 22  
Effective: November 17, 2001

DIGITAL NETWORK SERVICES

RESERVED FOR FUTURE USE

GENERAL EXCHANGE TARIFF

Embarq Florida, Inc.

By: F. B. Poag  
Director

SECTION A29  
Third Revised Sheet 23  
Cancelling Second Revised Sheet 23  
Effective: November 17, 2001

DIGITAL NETWORK SERVICES

RESERVED FOR FUTURE USE

GENERAL EXCHANGE TARIFF

Embarq Florida, Inc.

By: F. B. Poag  
Director

SECTION A29  
Third Revised Sheet 24  
Cancelling Second Revised Sheet 24  
Effective: November 17, 2001

DIGITAL NETWORK SERVICES

RESERVED FOR FUTURE USE

## GENERAL EXCHANGE TARIFF

Embarq Florida, Inc.

By: F. B. Poag  
Director

SECTION A29  
Third Revised Sheet 24.1  
Cancelling Second Revised Sheet 24.1  
Effective: August 7, 2002

### DIGITAL NETWORK SERVICES

#### B. INTEGRATED SERVICES DIGITAL NETWORK-PRIMARY RATE INTERFACE (ISDN-PRI) II

##### 1. General

- a. Integrated Services Digital Network (ISDN) - Primary Rate Interface (PRI) Service is a local exchange offering supported by the ISDN architecture.
- b. ISDN-PRI Service provides a method of access to the telephone network called Primary Rate Access. Primary Rate Access is an ISDN based, DS1 access link to the telecommunications network and provides integration of multiple voice and data transmission channels on the same line. The service provides connectivity between an ISDN-PBX or other ISDN-compatible CPE and a serving central office. The basic channel structure for Primary Rate Access is twenty-three 64 Kbps B-Channels and one 64 Kbps D-Channel. After purchasing the original 23 B-Channel plus one D-Channel configuration, the customer may purchase another Primary Rate Access Line and another Primary Rate Interface as well as additional B-Channels in increments of 12.

These channels may be used to connect the customer's CPE to the Public Network (i.e., outward, inward, and two-way trunks, and WATS/ 800/866/877/888 Service access lines).

- c. ISDN-PRI Service provides network communication paths providing the end user with access to a variety of network services and features including data, voice and video which conforms to internationally developed, published, and recognized standards generated by the International Telecommunications Union (ITU).
- d. Unless specified, the regulations for ISDN-PRI Service apply in addition to the General Regulations set forth in this tariff.
- e. ISDN-PRI Service and its optional features and functions are provided within a LATA from central offices where appropriate ISDN facilities are available as determined by the Company. Service inquiries will be necessary to determine availability. Charges Applicable Under Special Conditions may apply as specified in Section A5 of this tariff.

##### 2. Regulations

- a. The customer is responsible for providing Customer Premises Equipment (CPE) that is compatible with ISDN-PRI Service.
- b. The Company shall not be responsible if changes in any of the equipment, operations or procedures of the Company utilized in the provisioning of ISDN-PRI Service render any facilities provided by the customer obsolete or require modification or alteration of such equipment or system or otherwise affect its use or performance.

GENERAL EXCHANGE TARIFF

Embarq Florida, Inc.

By: F. B. Poag  
Director

SECTION A29  
Second Revised Sheet 24.2  
Cancelling First Revised Sheet 24.2  
Effective: January 28, 2002

DIGITAL NETWORK SERVICES

B. INTEGRATED SERVICES DIGITAL NETWORK-PRIMARY RATE INTERFACE (ISDN-PRI) II  
(Cont'd)

2. Regulations (Cont'd)

- c. Digital transmission rates at speeds less than those indicated may be accomplished as a function of the particular CPE furnished by the user.
- d. Suspension of service at the customer's request, as defined in Section A2 of this tariff, does not apply to ISDN-PRI Service.
- e. Service Charges specified in Section 4 of this tariff apply to any charges not specified in this section.
- f. The minimum service period for ISDN-PRI Service is six months.
- g. Telephone numbers transmitted via the Optional or Standard Incoming Call Identification feature are intended solely for the use of the ISDN-PRI Service subscriber. Resale of this call identification information is prohibited by this tariff.
- h. Non-Facility Associated Signaling (NFAS) provides the capability to serve multiple DS1's via a single D-Channel. This feature can be ordered where switch capabilities exist as determined by the Company. When NFAS is selected, the customer will order one ISDN-PRI Service arrangement with 23 B-Channels and 1 D-Channel. Additional ISDN-PRI Services arrangements can be ordered with 24 B-Channels as specified in Section A29 B.7. The D-Channel activated on the initial arrangement serves the additional ISDN-PRI arrangements.

After the first 23B + D PRI is purchased, a customer can purchase additional B-Channels in increments of 12. Additional Primary Rate Access Lines may be ordered in a 24B configuration. The Company recommends that the quantity of Primary Rate Access Lines supported by one (1) D-Channel not exceed four (4).

- i. This service is available only from central offices which have the necessary facilities to provide ISDN-PRI on the standard network platform. In the event a customer is served by a non-ISDN capable central office, the Company may provide ISDN-PRI Service from an alternative serving central office, as designated by the Company. The subscriber may be required to accept a foreign NXX. When a foreign NXX is required, all charges applicable to foreign exchange and/or foreign central office services, as specified in Section A9 of this tariff will apply in addition to the rates and charges included in this section. The local calling area may not be the same as the local calling area of the exchange in which the customer is located.

GENERAL EXCHANGE TARIFF

Embarq Florida, Inc.

By: F. B. Poag  
Director

SECTION A29  
First Revised Sheet 24.3  
Cancelling Original Sheet 24.3  
Effective: November 17, 2001

DIGITAL NETWORK SERVICES

B. INTEGRATED SERVICES DIGITAL NETWORK-PRIMARY RATE INTERFACE (ISDN-PRI) II  
(Cont'd)

2. Regulations (Cont'd)

i. (Cont'd)

When ISDN functionality becomes available from the central office that normally serves this subscriber, ISDN-PRI Service will be provided from that office and the subscriber may be required to accept a different NXX. If the subscriber chooses to continue ISDN-PRI Service from the alternative serving central office, all charges applicable to foreign exchange services, as specified in Section A9 of this tariff will apply in addition to the rates and charges included in this section.

Similarly, if a subscriber requests ISDN-PRI Service from an alternative serving central office other than that designated by the Company, all charges applicable to foreign exchange services, as specified in Section A9 of this tariff, will apply in addition to the rates and charges included in this section.

Emergency 911 calls placed over ISDN-PRI Primary Rate Access Lines provisioned via a foreign central office serving this arrangement will be identified as the alternative serving central office NXX and not the non-ISDN capable central office NXX. The Company shall not be liable for any loss or damages arising from emergency calls placed from ISDN-PRI Primary Rate Access Lines provisioned via an alternative serving central office.

j. This service is available only where the customer's service location is within the provisioning limitations as determined prior to installation of the service. Should the customer's service location exceed said limitations, service will be provided where the Company has electronically compatible facilities available, or where existing facilities can be made compatible.

k. Rotary hunt functionality, at no additional charge, is available with ISDN-PRI Service. This functionality increases the likelihood of an incoming call being completed over an ISDN-PRI B-channel. The functionality is exclusively within the B-channels of a single ISDN-PRI service arrangement or between multiple ISDN-PRI service arrangements and is not allowed between ISDN-PRI service arrangements and other services, including but not limited to, Business Individual Line Service. The total number of ISDN-PRI interfaces in a single, standard hunting configuration may not exceed 50.



GENERAL EXCHANGE TARIFF

Embarq Florida, Inc.

By: F. B. Poag  
Director

SECTION A29  
Second Revised Sheet 24.4  
Cancelling First Revised Sheet 24.4  
Effective: September 20, 2003

DIGITAL NETWORK SERVICES

B. INTEGRATED SERVICES DIGITAL NETWORK-PRIMARY RATE INTERFACE (ISDN-PRI) II  
(Cont'd)

2. Regulations (Cont'd)

- I. ISDN-PRI Service is not offered in conjunction with Local Measured Service.
- m. In order to maintain the quality of ISDN-PRI Service, the Company reserves the right to perform preventative maintenance and software updates to the network. The Company has classified this maintenance as indicated below:

Scheduled Maintenance

Scheduled maintenance is used to perform such functions as hardware and software upgrades and network optimization. The Company will perform these tasks in a maintenance window that is anticipated to minimize disruption of customer service and activity. The Company will provide advance notice of all scheduled maintenance.

Demand Maintenance

Demand Maintenance may occur as a result of unexpected events and is used when ISDN-PRI network elements are in jeopardy. The Company will perform this type of maintenance at its discretion. Due to the nature of demand maintenance prior notification may not be possible, however, the customer will be informed when the maintenance has been completed.

- n. One Directory Listing will be provided per D-Channel. Additional Directory Listings are available as specified in Section A6 of this tariff.

3. Definitions

- a. B-Channel - A bi-directional synchronous channel capable of supporting 64 Kbps of digital transmission.
- b. D-Channel - A 64 Kbps digital signaling only channel for call establishment when used with Primary Rate Access.
- c. Primary Rate Access Line – The facility between the serving central office and the customer's premises. Provides transport for up to twenty-four (24) 64 Kbps.
- d. Primary Rate Interface – The central office switching elements that are dedicated to a customer's ISDN-PRI service.
- e. Primary Rate Channels – B-Channels or D-Channels, as defined above.
- f. Rotary Hunt Functionality - A service arrangement which allows calls made to a busy number to be completed to another idle line in that rotary number group.

GENERAL EXCHANGE TARIFF

Embarq Florida, Inc.

By: F. B. Poag  
Director

SECTION A29  
Second Revised Sheet 24.5  
Cancelling First Revised Sheet 24.5  
Effective: August 7, 2002

DIGITAL NETWORK SERVICES

B. INTEGRATED SERVICES DIGITAL NETWORK-PRIMARY RATE INTERFACE (ISDN-PRI) II  
(Cont'd)

4. Features

a. Standard Features

Dynamic Allocation of Bandwidth

Allows the voice and data services to share B-Channels and arrange them as a single trunk group. This allows incoming and outgoing voice and data calls to utilize B-Channels on a call by call basis. Without this capability, each service will have a dedicated B-Channel.

Incoming Call Identification (Caller ID)

When provided by the originating carrier's facilities, incoming call identification transmits the telephone number of the calling party to the subscriber via the D-Channel subject to availability. Incoming call identification is provided via the D-Channel associated with the incoming calls on a B-Channel to a PBX.

Clear Channel Capability

The B-Channels on ISDN-PRI are clear, since all signaling and control functions are handled by the D-Channel. This allows all 64 Kbps on each B-Channel to be used for customer information.

Digital Voice Transmission

All voice calls are transmitted using digital signaling.

Direct Inward Dialing (DID) Signaling

Permits incoming dialed calls from the exchange network to reach a specific number served by customer premises equipment (CPE) without the assistance of an attendant. The central office will outpulse digits to the CPE that can further process the calls as desired. The rates and charges for DID telephone numbers are in addition to the ISDN charges and are provided in Section A16 of this tariff.

PBX Station ID Capability

Allows the station user's number (calling party) to be transmitted over the ISDN-PRI D-Channel from Direct Inward Dialing equipped CPE PBXs that use ISDN-PRI. This number is provided by the originating station and must have an associated Direct Inward Dialing telephone number working in the central office.

GENERAL EXCHANGE TARIFF

Embarq Florida, Inc.

By: F. B. Poag  
Director

SECTION A29  
Second Revised Sheet 24.6  
Cancelling First Revised Sheet 24.6  
Effective: January 28, 2002

DIGITAL NETWORK SERVICES

B. INTEGRATED SERVICES DIGITAL NETWORK-PRIMARY RATE INTERFACE (ISDN-PRI) II  
(Cont'd)

4. Features (Cont'd)

b. Optional Features

D-Channel Backup

Provides backup for the D-Channel for a customer with multiple PRI lines by automatically switching signaling capability over to another D-Channel if service to the primary D-Channel is interrupted.

Network Ring Again

Enables the customer to complete calls to a busy station without continually redialing. Certain equipment restrictions may apply.

Call-by-Call/Integrated Service Access Feature Capability

Allows the customer to dynamically allocate the use of channels for ISDN-PRI Service. The customer may also choose voice or data transmission on a per call basis. In addition, the customer may also choose to subscribe to more services than channels. The Customer Premises Equipment signals the local central office as to which type of service (inward/outward trunk, WATS Lines, 800/866/877/888 Service) to access for each call.

Incoming Call Identification (Caller ID Name and Number)

Provides the customer with the telephone number and name of the calling party. Incoming call identification is provided via the D-Channel associated with incoming calls on a B-Channel to a PBX. The Customer's equipment must be compatible with this service. Calling Number Delivery Blocking is available as stipulated in Section 13 of this tariff.

GENERAL EXCHANGE TARIFF

Embarq Florida, Inc.

By: F. B. Poag  
Director

Section A29  
First Revised Page 24.6.1  
Cancelling Original Page 24.6.1  
Effective: January 28, 2002

DIGITAL NETWORK SERVICES

B. INTEGRATED SERVICES DIGITAL NETWORK - PRIMARY RATE INTERFACE (ISDN-PRI) II (Cont'd)

4. Features (Cont'd)

b. Optional Features (Cont'd)

2 B-Channel Transfer

If a call terminates at a given location, but is then forwarded to another location, two trunks between the Central Office and the original device are typically employed for the duration of the forwarded call. 2 B-Channel Transfer allows the central office switch to establish the call directly to the final destination and release the trunks going in and out of the forwarding device. This saves the customer PRI facilities and provides for more efficient use of the network. A common use of 2 B-Channel Transfer is illustrated below.

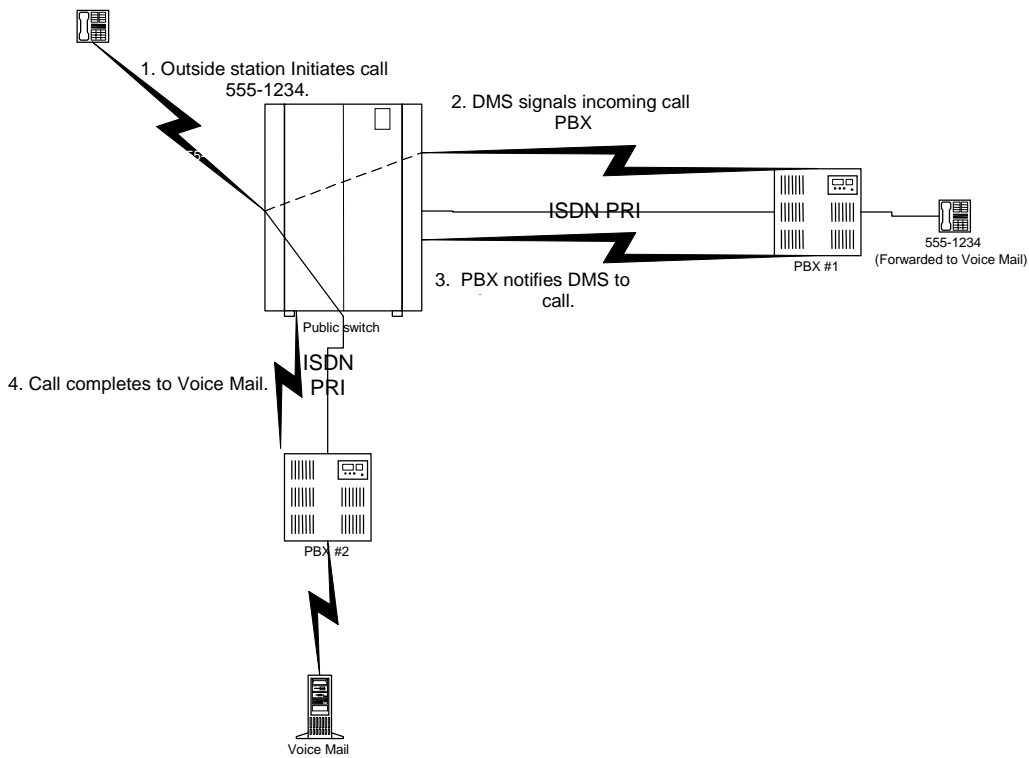

## GENERAL EXCHANGE TARIFF

Embarq Florida, Inc.

By: F. B. Poag  
Director

Section A29  
Second Revised Page 24.6.2  
Cancelling First Revised Page 24.6.2  
Effective: May 20, 2003

### DIGITAL NETWORK SERVICES

#### B. INTEGRATED SERVICES DIGITAL NETWORK - PRIMARY RATE INTERFACE (ISDN-PRI) II (Cont'd)

##### 4. Features (Cont'd)

##### b. Optional Features (Cont'd)

###### Circular Hunt

Circular Hunt provides the most efficient hunting sequence available, plus allows for much larger trunk groups than the standard ISDN-PRI packages. With circular hunt, an incoming call is completed to the next available trunk (bearer) in sequence starting from the last trunk selected. This can occur across multiple PRI facilities. The feature can support up to 220 Primary Rate Interfaces in a single hunting configuration. The standard limit is 50.

###### National ISDN-2 Protocol

National ISDN-2 Protocol is a communication protocol that governs interactions between the customer's equipment and the telephone network. This protocol is more advanced than the standard ISDN-PRI protocol. Most CPE is capable of using the ISDN-2 Protocol.

###### E911 Call Screening

E911 Call Screening provides for the transmission of PBX or Key System station information via the ISDN-PRI facility to local emergency services authorities. This provides for the possible identification of the specific location on a customer's premises where a 911 call originated. This option is available only in communities where local emergency authorities support the service in conjunction with the Company's Private Switch Automatic Location Identification (PSALI) Service, associated with E911 Service. This service is only available in conjunction with National ISDN-2 Protocol.

###### Optional Calling Plan

An Optional Calling Plan is available in certain exchanges. The plan is described in Section A3 of this tariff.

GENERAL EXCHANGE TARIFF

Embarq Florida, Inc.

By: F. B. Poag  
Director

SECTION A29  
Third Revised Sheet 24.7  
Cancelling Second Revised Sheet 24.7  
Effective: August 7, 2002

DIGITAL NETWORK SERVICES

B. INTEGRATED SERVICES DIGITAL NETWORK-PRIMARY RATE INTERFACE (ISDN-PRI) II  
(Cont'd)

5. Service Components

a. The components for ISDN-PRI Service will be as follows:

- Primary Rate Access Line
- Primary Rate Interface
- Primary Rate Channels

1. Primary Rate Access Line - Will provide a four-wire access loop from the customer premises to the serving central office. The transmission via this loop supports Clear Channel Capability.
2. Primary Rate Interface - Provides the multiplexing to support up to twenty-three (23) B-Channels at 64 Kbps and one (1) D-Channel for signaling also at 64 Kbps. When NFAS is ordered, the Primary Rate Interface can provide up to twenty-four B-Channels at 64 Kbps.
3. Primary Rate Channels - Will provide unlimited usage of channels that will allow either voice or data transmission up to 64 Kbps.
  - a. Voice calls may be completed to both ISDN and non-ISDN lines.
  - b. Data Transmission on the B-Channels will be at 64 Kbps within the switch and between ISDN-PRI compatible central offices. ISDN-PRI interconnection to non-ISDN-PRI equipped central offices may be potentially subjected to analog transmission or sub-rated to 56 Kbps.
  - c. The customer may choose to subscribe to additional non exchange based services. Initial choices for these services will be WATS and 800/888 Service. The subscription to these services is in addition to the charges for ISDN-PRI Service.

b. With the first ISDN-PRI Primary Rate Access Line the customer is required to purchase 23 B-Channels and an initial D-Channel.

After the initial 23B + D configuration, the customer may choose channels in increments of 12 up to twenty-three B + D or twenty-four B with NFAS, per ISDN-PRI Primary Rate Access Line (facility) to be active with a corresponding number of services (i.e., inward/outward trunks, WATS Lines, 800/866/877/888 Service) selected. The customer may also choose to subscribe to more services than channels. The Customer Premises Equipment signals the local central office as to which type of service (inward/outward trunk, WATS Lines, 800/866/877/888 Service) to access for each call.

GENERAL EXCHANGE TARIFF

Embarq Florida, Inc.

By: F. B. Poag  
Director

SECTION A29  
First Revised Sheet 24.7.1  
Cancelling Original Sheet 24.7.1  
Effective: January 28, 2002

DIGITAL NETWORK SERVICES

B. INTEGRATED SERVICES DIGITAL NETWORK-PRIMARY RATE INTERFACE (ISDN-PRI) II  
(Cont'd)

6. Application of Rates

- a. ISDN-PRI Primary Rate Access Lines furnished between a serving central office and the customer-designated premises will be charged at rates per each Primary Rate Access Line.
- b. Nonrecurring charges will not be applicable for the Primary Rate Access Line or interoffice channel facilities when upgrading an existing United TransLink to an ISDN-PRI Service.
- c. ISDN-PRI Primary Rate Access Line rates, including interoffice channels if applicable, apply in addition to Primary Rate Interface and Primary Rate Channel charges.
- d. If the customer chooses to purchase additional channels after purchasing the original 23B + D configuration, the customer must purchase another Primary Rate Access Line and another Primary Rate Interface as well as the additional channels. Additional channels can be purchased in increments of 12.
- e. Rates and charges for optional features and functions are applied to each Primary Rate Interface for which the option is ordered.

GENERAL EXCHANGE TARIFF

Embarq Florida, Inc.

BY: F. B. Poag  
Director

SECTION A29  
Fifth Revised Sheet 24.8  
Cancelling Fourth Revised Sheet 24.8  
Effective: November 1, 2005

DIGITAL NETWORK SERVICES

B. INTEGRATED SERVICES DIGITAL NETWORK-PRIMARY RATE INTERFACE (ISDN-PRI) II (Cont'd)

7. Rates and Charges

a. ISDN-PRI Primary Rate Access Line

Primary Rate Access Line is furnished between a serving central office and the customer's designated premises. Primary Rate Access Line charges apply per point of termination.

1. Primary Rate Access Line (Intraexchange)

	Monthly Rate	Nonrecurring Charge First	Nonrecurring Charge Add'l*
1.544 Mbps			
Month to month**	\$248.00	\$300.00	\$110.00
12-23 months	202.00	200.00	110.00
24-35 months	194.00	110.00	0.00
36-59 months	180.00	0.00	0.00
60-84 months	152.00	0.00	0.00

\* Additional facilities must be installed at the same customer designated premises on the same trip and placed on the same service order.

\*\*Minimum Service Period for ISDN-PRI is six months.

2. Primary Rate Access Line (Interexchange)

The rates, charges and regulations applicable to TransLink® Service, as defined in Section A21 of this tariff, also apply for interexchange Primary Rate Access Lines.

b. Primary Rate Interface

	Monthly Rate	Nonrecurring Charge
1. Primary Rate Interface One-Way Per ISDN-PRI Primary Rate Access Line (Data only or Voice and Data)		
Month to month	\$138.70	\$230.00
12-23 months	123.70	130.00
24-35 months	90.70	20.00
36-59 months	85.70	0.00
60-84 months	73.70	0.00



GENERAL EXCHANGE TARIFF

Embarq Florida, Inc.

BY: F. B. Poag  
Director

SECTION A29  
Fourth Revised Sheet 24.9  
Cancelling Third Revised Sheet 24.9  
Effective: October 24, 2003

DIGITAL NETWORK SERVICES

B. INTEGRATED SERVICES DIGITAL NETWORK-PRIMARY RATE INTERFACE (ISDN-PRI) II  
(Cont'd)

7. Rates and Charges (Cont'd)

b. Primary Rate Interface (Cont'd)

	<u>S&amp;E Code</u>	<u>Monthly Rate</u>	<u>Nonrecurring Charge</u>
2. Primary Rate Interface Two-Way Per ISDN-PRI Primary Rate Access Line			
Month to month	FCETPRI(2W1)	\$206.00	\$230.00
12-23 months	FCETPRI(2W2)	181.00	130.00
24-35 months	FCETPRI(2W3)	148.00	20.00
36-59 months	FCETPRI(2W4)	143.00	0.00
60-84 months	FCETPRI(2W5)	121.00	0.00

c. ISDN-PRI Services will be available in combinations of Primary Rate Channels according to the limits of the Company central office type. Customers will choose the most appropriate combination(s) and will be billed for the services as appropriate. The initial configuration must be 23 B-Channels and 1 D-Channel. Additional configurations are outlined in Section A29 B 5.b. of this tariff.

1. B-Channel Charge, each channel

	<u>S&amp;E Code</u>	<u>Monthly Rate</u>	<u>Nonrecurring Charge</u>
Month to month	TIFCLB(BC1)	\$20.00	\$5.00
12-23 months	TIFCLB(BC2)	18.00	5.00
24-35 months	TIFCLB(BC3)	17.00	5.00
36-59 months	TIFCLB(BC4)	15.00	0.00
60-84 months	TIFCLB(BC5)	13.00	0.00

2. Initial D-Channel

	<u>S&amp;E Code</u>	<u>Monthly Rate</u>	<u>Nonrecurring Charge</u>
Month to month	FCEISCD(DC1)	\$20.00	\$5.00
12-23 months	FCEISCD(DC2)	18.00	5.00
24-35 months	FCEISCD(DC3)	17.00	5.00
36-59 months	FCEISCD(DC4)	15.00	0.00
60-84 months	FCEISCD(DC5)	13.00	0.00

GENERAL EXCHANGE TARIFF

Embarq Florida, Inc.

By: F. B. Poag  
Director

SECTION A29  
Fourth Revised Sheet 24.10  
Cancelling Third Revised Sheet 24.10  
Effective: September 20, 2003

DIGITAL NETWORK SERVICES

B. INTEGRATED SERVICES DIGITAL NETWORK-PRIMARY RATE INTERFACE (ISDN-PRI) II  
(Cont'd)

7. Rates and Charges (Cont'd)

d. Optional Features

	<u>Monthly Rate</u>	<u>Nonrecurring Charge</u>
1. D-Channel Backup* each channel	\$ 50.00	\$20.00
2. Network Ring Again Per Primary Rate Interface** (Available with Two-Way Primary Rate Interface only)	160.00	0.00
3. Call-by-Call/Integrated Service Access Feature Capability Per Primary Rate Interface (Available with Two-Way Primary Rate Interface only)	50.00	35.00
4. Incoming Call Identification (Caller ID Name and Number) Per Primary Rate Interface	100.00	0.00
5. 2 B-Channel Transfer** Per Primary Rate Interface	75.00	100.00
6. Circular Hunt** Per Primary Rate Interface	25.00	100.00
7. National ISDN-2 Protocol** Per Primary Rate Interface	0.00	0.00
8. E911 Call Screening** Per Primary Rate Interface (up to 100 station numbers)	125.00	150.00

\* Available only to customers subscribing to more than one Primary Rate Interface.

\*\* Certain equipment restrictions apply.

GENERAL EXCHANGE TARIFF

Embarq Florida, Inc.

SECTION A29

By: F. B. Poag  
Director

Fifth Revised Sheet 24.11  
Cancelling Fourth Revised Sheet 24.11  
Effective: September 20, 2003

DIGITAL NETWORK SERVICES

B. INTEGRATED SERVICES DIGITAL NETWORK-PRIMARY RATE INTERFACE (ISDN-PRI) II  
(Cont'd)

7. Rates and Charges (Cont'd)

		<u>Monthly Nonrecurring</u>	
		<u>Rate</u>	<u>Charge</u>
e.	Optional Feature Packages		
1.	Premium Package* Includes National ISDN-2 Protocol**, E911 Call Screening**, Incoming Call Identification (Caller ID Name and Number), Call-by-Call/Integrated Service Access Feature Capability, and 2 B-Channel Transfer** Per Primary Rate Interface	\$195.00	\$285.00

f. Move Charge

A Move Charge, per ISDN-PRI Primary Rate Access Line, applies for each Primary Rate Access Line moved to a new location in the same building. This Move Charge is equal to the sum of the Primary Rate Access Line nonrecurring charge, Service Change Charge - Inside Moves and Premises Visit Charge specified in Section A29 B.7.g.4.b.

g. Service Connection Charges

1. Service Establishment Charges are applicable for each ISDN-PRI Primary Rate Access Line ordered, for receiving and recording information and/or taking action in connection with a customer's request, and processing the necessary data. These charges include engineering design, common centralized testing and coordination. The nonrecurring charges associated with service establishment are found in Section A29 B.7.a, b, c.
2. Service Change Charges are applicable for receiving and recording information and/or taking action in connection with a customer's termination change at the same premises or transfer of service responsibility request, for processing the necessary data on an existing Primary Rate Access Line. A Service Change Charge is applicable for each Primary Rate Access Line associated with the customer request (in lieu of a Service Establishment Charge).
3. Premises Visit Charges are applicable per Primary Rate Access Line, for the termination of a channel at a customer's premises or for termination change at the same premises. Only one Premises Visit Charge applies when more than one channel service of the same type is terminated or moved at the same premises at the same time.

\* Only available for customers subscribing to ISDN Primary Rate Interface Two-Way under a Term Discount Plan.

\*\* Certain equipment restrictions apply.

GENERAL EXCHANGE TARIFF

Embarq Florida, Inc.

By: F. B. Poag  
Director

SECTION A29  
Sixth Revised Sheet 24.12  
Cancelling Fifth Revised Sheet 24.12  
Effective: May 1, 2003

DIGITAL NETWORK SERVICES

B. INTEGRATED SERVICES DIGITAL NETWORK-PRIMARY RATE INTERFACE (ISDN-PRI) II  
(Cont'd)

7. Rates and Charges (Cont'd)

g. Service Connection Charges (Cont'd)

4. Charges

	<u>Nonrecurring Charges</u>
a. Service Change Charge per Primary Rate Access Line	
1. For termination change at the same premises, physical, per Primary Rate Interface	\$165.00
2. For termination change at the same premises, Programming, per Primary Rate Interface	35.00
b. Premises Visit Charge per Primary Rate Access Line or for an Inside move	125.00

h. Termination Liability Charges

1. If a customer under a Term Discount Plan (TDP) disconnects all or a portion of the ISDN-PRI Service prior to the expiration of the TDP, then a Termination Liability Charge will apply to those services that are disconnected. The Termination Liability Charge will be a one-time charge equal to the sum of 50% of the payments remaining for the rest of the TDP. If Charges Applicable Under Special Conditions were applied to the service being terminated, any termination charges associated with Charges Applicable Under Special Conditions will also apply.
2. Rate increases or decreases will automatically be applied to the monthly term plan rates for the remaining term of the TDP. If Company initiated rate increases to any rate element or combination of rate elements causes the charges for the entire ISDN-PRI service under the TDP to increase by 10% or more annually, then the customer may cancel the TDP without incurring termination liability charges provided that the customer notifies the Company within 30 days after the effective date of the rate increase.

GENERAL EXCHANGE TARIFF

Embarq Florida, Inc.

By: F. B. Poag  
Director

SECTION A29  
Fourth Revised Sheet 24.13  
Cancelling Third Revised Sheet 24.13  
Effective: July 12, 2005

DIGITAL NETWORK SERVICES

B. INTEGRATED SERVICES DIGITAL NETWORK-PRIMARY RATE INTERFACE (ISDN-PRI) II  
(Cont'd)

7. Rates and Charges (Cont'd)

h. Termination Liability Charges (Cont'd)

3. The customer can extend TDP commitment periods at any time during the term of the plan, up to a maximum of 84 months. The number of months accrued in the current plan will apply toward the new plan selected.
4. At the end of the TDP service commitment period, the customer may subscribe to a new TDP at the prevailing rates. If the customer does not select a new TDP, the prevailing rates applicable for the expired TDP will continue in effect for as long as the customer chooses to continue subscribing to the ISDN-PRI services installed under the expired TDP. Additional ISDN-PRI services installed after the TDP expiration date will not be eligible for the TDP rates and will be charged at the prevailing month to month rates unless the customer selects a TDP for those services.
5. Termination Liability Charges will not apply when a service or rate element under a (TDP) arrangement is disconnected prior to the expiration of a selected service period as a result of a change in tariff jurisdiction and/or a customer requested upgrade to a next generation service offering under the following conditions:

The service period of the new TDP for the new service offering is a period equal to or exceeding the remaining service period of the disconnected TDP, and

The service orders to install the new service and disconnect the old service are related together, and there is no lapse in service between the installation of the new service the disconnection of the existing service, and

The service orders to install the new service and disconnect the old service are for the same customer at the same location.

The Telephone Company will determine whether replacement service qualifies as a next generation service offering.

Nonrecurring charges and Service Charges for the new service will apply according to the requirements of the new service.

## GENERAL EXCHANGE TARIFF

Embarq Florida, Inc.

By: F. B. Poag  
Director

SECTION A29  
Fourth Revised Sheet 25  
Cancelling Third Revised Sheet 25  
Effective: August 7, 2002

### DIGITAL NETWORK SERVICES

#### C. INTEGRATED SERVICES DIGITAL NETWORK-BASIC RATE INTERFACE (ISDN-BRI)

##### 1. General

- a. Integrated Services Digital Network - Basic Rate Interface (ISDN-BRI) is a local exchange telecommunications service that provides integrated voice and data communications capability. ISDN-BRI service supports the simultaneous transmission of voice and data over a single exchange access line.

ISDN-BRI provides a customer two B-channels with transmission speeds up to 64 Kbps each and one 16 Kbps D-channel. The service provides communication paths providing end user access to a variety of network services and features including data, voice and video, which conforms to internationally developed, published and recognized standards generated by the International Telecommunications Union.

##### b. Service Capabilities

- 1) ISDN-BRI consists of three distinct channels delivered to the customer's premises: two B (bearer) channels and one D (delta) channel. This is also known as 2B+D. ISDN-BRI is not available in other channel configurations of 1B+D or 0B+D.
- 2) The B-channel carries voice and/or data communications at speeds up to 64 Kbps, from the customer's premises, over the loop facility, to the central office. Packet data services are not available over the B-channel.
- 3) The D-channel carries administrative signaling at 16 Kbps for call-control for either a voice or data B-channel call on the ISDN-BRI line. The D-channel does not have voice capability. Packet data services are not available on the D-channel.
- 4) Customers subscribing to ISDN-BRI must comply with ISDN Basic Rate Network Interface specifications as specified by the Company. The ISDN Basic Rate Interface is comprised of a limited set of standard user-network interfaces. The BRI customer premises equipment (CPE) located at the customer premises must be compatible with the network interface. This interface is defined as follows:

## GENERAL EXCHANGE TARIFF

Embarq Florida, Inc.

By: F. B. Poag  
Director

SECTION A29  
Second Revised Sheet 26  
Cancelling First Revised Sheet 26  
Effective: January 22, 1999

### DIGITAL NETWORK SERVICES

#### C. INTEGRATED SERVICES DIGITAL NETWORK-BASIC RATE INTERFACE (ISDN-BRI) (Cont'd)

##### 1. General (Cont'd)

##### b. Service Capabilities (Cont'd)

##### 4) (Cont'd)

A two-wire interface is the physical interface between a central office switch equipped with ISDN and the customer premises equipment which is necessary for terminating a telephone circuit or facility at the customer premises.

##### c. Standard Features

- 1) Closed User Group - allows the user to establish subnetworks within which the members of the Closed User Group can communicate. Each data terminal in a Closed User Group can be arranged in one of the follow modes:
  - a) Outgoing Access - The data terminal originates outgoing calls only. These calls may terminate within or out of the Closed User Group.
  - b) Incoming Access - The data terminal receives incoming calls only. These calls may terminate within or out of the Closed User Group.
  - c) Incoming Calls Barred - The data terminal originates outgoing calls only to the data terminals in the Closed User Group with which it is associated.
  - d) Outgoing Calls Barred - The data terminal receives incoming calls only from the data terminals in the Closed User Group with which it is associated.
  - e) Unrestricted Access - The data terminal receives and originates both incoming and outgoing calls.

GENERAL EXCHANGE TARIFF

Embarq Florida, Inc.

By: F. B. Poag  
Director

SECTION A29  
Third Revised Sheet 27  
Cancelling Second Revised Sheet 27  
Effective: August 7, 2002

DIGITAL NETWORK SERVICES

C. INTEGRATED SERVICES DIGITAL NETWORK-BASIC RATE INTERFACE (ISDN-BRI)  
(Cont'd)

1. General (Cont'd)

c. Standard Features (Cont'd)

- 2) Configuration Group - Associates a button or buttons of an ISDN-CPE station to a feature or group of features. Each different telephone set button arrangement requires that a different Configuration Group be assigned.

d. Service Capability Packages\*

- 1) Customers shall subscribe to one of the following Service Capability Packages specifying the assignment of each B-channel. Through the North American ISDN Users' Forum, a set of ISDN Service Capability Packages have been defined and given a letter designation. Each of the Service Capability Packages describes a specific interface configuration as well as the features and capabilities of that interface. Detailed technical specifications are defined for each of the Service Capability Packages. These packages have been established to help simplify the ordering, provisioning, and installation of ISDN.

- a) Standard ISDN-BRI (equivalent to Package S without features)  
1-B Alternate voice/data  
1-B Alternate voice/data

Key Telephone Systems

ISDN may be purchased for a key system from this tariff in the place of a key trunk (for ISDN-capable key systems). If terminating an ISDN-BRI line into key system, the customer shall order one of the following Service Capability Packages:

\* ISDN terminal equipment is the responsibility of the customer and must support the configuration, optional services, and features chosen by the customer.



## GENERAL EXCHANGE TARIFF

Embarq Florida, Inc.

By: F. B. Poag  
Director

SECTION A29  
Third Revised Sheet 28  
Cancelling Second Revised Sheet 28  
Effective: August 7, 2002

### DIGITAL NETWORK SERVICES

#### C. INTEGRATED SERVICES DIGITAL NETWORK-BASIC RATE INTERFACE (ISDN-BRI) (Cont'd)

##### 1. General (Cont'd)

##### d. Service Capability Packages\* (Cont'd)

###### 1) (Cont'd)

b) Package H:  
1-B Voice Only  
1-B data only  
(Includes Additional Call Offering)

c) Package L:  
1-B data only  
1-B Alternate voice/data  
(Includes Additional Call Offering)

##### e. Optional Services and Features\*

1) The ISDN-BRI offering provides the customer with the following features, where available.

a) Call Pickup - Originating and Terminating - This feature allows a station user to answer any call within an associated predesignated pickup group. If more than one line within the pickup group has an unanswered incoming call, the call to be answered is selected by the central office switching system.

b) Flexible Calling - This feature includes:  
Hold/Retrieve\*  
B-Channel Reservation  
Three-Way Conference Calling  
Add-on (previously held conference call)  
Drop Last Call  
Transfer  
No Transfer Restriction  
Consultation Hold

\* ISDN terminal equipment is the responsibility of the customer and must support the configuration, optional services, and features chosen by the customer.

## GENERAL EXCHANGE TARIFF

Embarq Florida, Inc.

By: F. B. Poag  
Director

SECTION A29  
Second Revised Sheet 29  
Cancelling First Revised Sheet 29  
Effective: January 22, 1999

### DIGITAL NETWORK SERVICES

#### C. INTEGRATED SERVICES DIGITAL NETWORK-BASIC RATE INTERFACE (ISDN-BRI) (Cont'd)

##### 1. General (Cont'd)

##### e. Optional Services and Features\* (Cont'd)

##### 1) (Cont'd)

- c) Six-Way Conference Calling, Drop, Hold, Transfer - This feature allows the customer to add up to five parties to an existing call. This feature is for voice calls only.
- d) Automatic Callback (Repeat Dial) - This feature provides automatic callback to the last dialed number.
- e) Additional Call Offering (ACO) - This feature allows multiple call appearances per telephone number (B-channel) per telephone set. Example: A customer can put up to 3 calls on hold and receive another call on the phone, with all calling parties dialing the telephone number associated with voice on B-channel.
- f) Call Forwarding - This feature provides the customer with Call Forwarding Variable, Call Forwarding Busy and Call Forwarding No Answer with message waiting indicator, either visual or audible.
- g) Calling Number Identification - This feature permits the customer to receive and display the calling party telephone number for calls placed to the customer.
- h) Calling Name Identification - This feature permits the customer to receive and display the calling party name for calls placed to the customer.
- i) Additional Directory Numbers - Additional directory numbers are available on each B-channel in addition to the primary directory number assigned to the B-channel. Additional Directory Numbers are purchased separately.

\* ISDN terminal equipment is the responsibility of the customer and must support the configuration, optional services, and features chosen by the customer.

GENERAL EXCHANGE TARIFF

Embarq Florida, Inc.

By: F. B. Poag  
Director

SECTION A29  
Second Revised Sheet 30  
Cancelling First Revised Sheet 30  
Effective: January 22, 1999

DIGITAL NETWORK SERVICES

C. INTEGRATED SERVICES DIGITAL NETWORK-BASIC RATE INTERFACE (ISDN-BRI) (Cont'd)

1. General (Cont'd)

e. Optional Services and Features\* (Cont'd)

1) (Cont'd)

- j) Multi-line Hunt Group - This feature is limited to hunting within ISDN-BRI lines and on an individual customer location basis. Directory numbers within the multi-line hunt group may not have multiple call appearances.
- k) Feature Package 1 - This package includes:
  - Calling Number ID/Calling Name ID
  - Call Forwarding
  - Flexible Calling
  - Automatic Callback
  - Additional Call Offering
- l) Loop Extension - ISDN-BRI is available only where the customer's service location is within the provisioning limitations as determined prior to installation of the service. This limitation is a cable plant distance of approximately 18,000 feet. The actual distance is dependent on decibel (db) loss and not just physical loop length. Should the customer's service location exceed said limitations, service will be provided where the Company has compatible facilities available, or where existing facilities can be made compatible by the addition of special equipment. This service, which carries an additional charge, is called Loop Extension and will extend the ISDN-capability to approximately 36,000 feet.

2. Regulations

- a. This service is offered only where facilities and appropriate technology exist.

\* ISDN terminal equipment is the responsibility of the customer and must support the configuration, optional services, and features chosen by the customer.

## GENERAL EXCHANGE TARIFF

Embarq Florida, Inc.

By: F. B. Poag  
Director

SECTION A29  
Third Revised Sheet 31  
Cancelling Second Revised Sheet 31  
Effective: August 7, 2002

### DIGITAL NETWORK SERVICES

#### C. INTEGRATED SERVICES DIGITAL NETWORK-BASIC RATE INTERFACE (ISDN-BRI) (Cont'd)

##### 2. Regulations (Cont'd)

- b. Local voice and data calls will be billed on a flat-rate basis, as shown in Section A29.C.3 of this tariff. Toll charges shall apply when data or voice calls are made outside of the customer's designated local calling area. When two simultaneous B-channels are combined for a maximum data speed of 128 Kbps, the toll call will be billed as if two calls were dialed by the originating customer.
- c. In exchanges where IntraLATA presubscription has been implemented, only one InterLATA and one IntraLATA Carrier may be selected for all B-channels associated with the same ISDN-BRI Service. Access via 101XXXX to other Interexchange Carriers is available.
- d. A minimum service period of three months is required.
- e. The Company shall terminate ISDN-BRI Services at the Company Network Interface Device (NID) located at the customer's premises.
- f. Two Primary Directory Numbers will be included with an ISDN-BRI Service, one for each B-Channel. If Additional Directory Numbers are required on either channel, an additional charge, as specified in Section A29.C.4 of this tariff, will apply for each additional number.
- g. ISDN-compatible customer premises terminal equipment is required for proper operation. It is the customer's responsibility to provide necessary power and obtain such equipment.
- h. The provisions for temporary suspension of service, as defined in Section A2 of this tariff, do not apply to ISDN-BRI service.

## GENERAL EXCHANGE TARIFF

Embarq Florida, Inc.

By: F. B. Poag  
Director

SECTION A29  
Second Revised Sheet 32  
Cancelling First Revised Sheet 32  
Effective: January 22, 1999

### DIGITAL NETWORK SERVICES

#### C. INTEGRATED SERVICES DIGITAL NETWORK-BASIC RATE INTERFACE (ISDN-BRI) (Cont'd)

##### 2. Regulations (Cont'd)

- i. This service is available only from central offices, which have the necessary facilities to provide ISDN-BRI on the standard network platform. In the event a customer is provided service from a non-ISDN compatible central office, the Company will provide ISDN-BRI Service from an alternative serving central office. This provision is accomplished by utilizing a 'hubbing' architecture and the subscriber may be required to accept a unique NXX.

When service is provided from an alternative Central Office, the appropriate Foreign Central Office or Foreign Exchange Service charges for usage and mileage as specified in Section A9, will apply in addition to the rates and charges shown in this section.

Emergency 911 calls, both enhanced and basic, placed over ISDN-BRI lines provisioned via this arrangement will be identified as the alternative serving central office NXX and not the non-ISDN compatible central office NXX. The Company shall not be liable for any loss or damages arising from the emergency calls placed from ISDN-BRI lines provisioned via an alternative serving central office.

- j. One directory listing will be provided with ISDN-BRI. Additional listings are available as specified in the Company's General Exchange Tariff.
- k. ISDN-BRI Service will be assessed the appropriate inter-state charges (e.g. End User Common Line and Presubscribed Interexchange Carrier Charge), as defined in the Company's Interstate Access Tariff.
- l. ISDN-BRI does not provide for the transmission of packet data on either the D-channel or one of the B-channels.

## GENERAL EXCHANGE TARIFF

Embarq Florida, Inc.

By: F. B. Poag  
Director

SECTION A29  
First Revised Sheet 32.1  
Cancelling Original Sheet 32.1  
Effective: January 22, 1999

### DIGITAL NETWORK SERVICES

#### C. INTEGRATED SERVICES DIGITAL NETWORK-BASIC RATE INTERFACE (ISDN-BRI) (Cont'd)

##### 2. Regulations (Cont'd)

- m. ISDN-compatible terminal equipment is a requirement for operation and is the customer's responsibility. ISDN customer-premise equipment is dependent upon commercial power and not power from the Company central office. For their safety and well-being, all ISDN customers are encouraged to maintain a non-ISDN access line on the premises for emergency calls in the event of a loss of commercial electrical power. In the event a subscriber elects to disconnect or not maintain a non-ISDN access line, the customer assumes full responsibility for telephone service in the event of an emergency.
- n. ISDN-BRI Service is available for residence and business service.
- o. ISDN-BRI lines may be purchased out of this tariff to be associated with Centrex Service, as defined in Sections A11, A12 and A23 of this tariff. Terms and conditions for Centrex Service will apply to these ISDN-BRI lines except as otherwise stated in this section. Optional features compatible with ISDN-BRI may be purchased from the Centrex Optional Features Section of the tariff as well as features unique to ISDN lines from the Optional Features in this section.

ISDN-BRI lines associated with Centrex Service may be purchased only for those features from the Centrex section of the tariff. ISDN-BRI can be provisioned in the same Centrex customer group if, and only if, the customer group is resident in an ISDN equipped host or remote office. All other Centrex customers can subscribe to ISDN-BRI; however, the service will be provisioned as a stand-alone service and will not be included in the customer group.

- p. ISDN-BRI Service may be terminated in key telephone systems in lieu of a key trunk. However, the key telephone system must be ISDN compatible.
- q. ISDN-BRI Service for customers subscribing to Rotary Hunt Service, as defined in Section A3 of this tariff will be provisioned outside the existing hunt group.

## GENERAL EXCHANGE TARIFF

Embarq Florida, Inc.

By: F. B. Poag  
Director

SECTION A29  
Fourth Revised Sheet 33  
Cancelling Third Revised Sheet 33  
Effective: August 7, 2002

### DIGITAL NETWORK SERVICES

#### C. INTEGRATED SERVICES DIGITAL NETWORK-BASIC RATE INTERFACE (ISDN-BRI) (Cont'd)

##### 2. Regulations (Cont'd)

r. Verification and Emergency Interrupt service is not available for ISDN-BRI Service.

##### 3. Application of Rates

- a. ISDN-BRI Service is offered on an unlimited use basis. All applicable state and federal charges will apply. Extended Area Service (EAS) charges, if applicable as defined in the General Exchange Tariff apply per ISDN-BRI B-channel. Toll charges apply when data or voice calls are completed outside the customer's designated local calling area or EAS territory.
- b. The monthly rates for Service Capability Packages are applied on a per package basis.
- c. The ISDN-BRI monthly rates are in addition to the applicable R-1 (Residential One Party), B-1 (Business One Party) or Centrex access line rate. These rates vary by service area and can be found in Sections A3, A11, A12 and A13.
- d. The Non-Recurring Charge for ISDN Service Capability Package will be discounted 50% when a customer commits to a 12-month service period or 100% when a customer commits to a 24-month service period. If termination of service prior to the end of the commitment occurs, the customer is responsible for payment of the discounted amount of the Non-Recurring Charge, which represents the charges initially waived.

However, this termination requirement will not apply when the customer converts to a Next Generation Service Offering of a separately tariffed service, provided that:

- 1) The service period for the new service offering is a minimum period equal to or exceeding the remaining service period of the disconnected arrangement, whichever is greater; and
- 2) The service orders to install the new service and disconnect the old service are related together, and there is no lapse in service between installation of the new service and disconnection of the existing service; and
- 3) The service orders are for the same customer at the same location.

Integrated Services Digital Network-Basic Rate Interface (ISDN-BRI) to: Integrated Services Digital Network-Primary Rate Interface (ISDN-PRI), Frame Relay Service (FRS) or Asynchronous Transfer Mode (ATM) are a few examples of a Next Generation Service Offering.

GENERAL EXCHANGE TARIFF

Embarq Florida, Inc.

By: F. B. Poag  
Director

SECTION A29  
Second Revised Sheet 33.1  
Cancelling First Revised Sheet 33.1  
Effective: August 7, 2002

DIGITAL NETWORK SERVICES

C. INTEGRATED SERVICES DIGITAL NETWORK-BASIC RATE INTERFACE (ISDN-BRI) (Cont'd)

3. Application of Rates (Cont'd)

- e.** ISDN-BRI provides for one Configuration Group to be established at the initial implementation of service. Subsequent additions to or changes of Configuration Groups or in excess of one group on the initial establishment of service will be charged a Non-Recurring charge per Configuration Group.
- f.** A Change Charge will apply for a database change subsequent to the installation of an ISDN-BRI Service. This includes changing, adding, or deleting features or feature packages, directory numbers, or number appearances.



GENERAL EXCHANGE TARIFF

Embarq Florida, Inc.

By: F. B. Poag  
Director

SECTION A29  
Second Revised Sheet 34  
Cancelling First Revised Sheet 34  
Effective: January 22, 1999

DIGITAL NETWORK SERVICES

C. INTEGRATED SERVICES DIGITAL NETWORK-BASIC RATE INTERFACE (ISDN-BRI) (Cont'd)

4. Rates and Charges

a. Service Capability Packages	S&E Code	Monthly Rate	NRC
Standard ISDN-BRI Package (Package S without features)	1FLCBRC (Res)	\$25.00	\$200.00
	1FLCBRC (Bus)	35.00	200.00
	1FLCBRI		
Package H (Key Telephone System)	1FLCBRC	35.00	200.00
	1FLCBR1		
Package L (Key Telephone System)	1FLCBRC	35.00	200.00
	1FLCBR1		
Loop Extension	MCSXNDC MCSXNDD	20.00	N/A

\* The ISDN-BRI rates set forth above are in addition to an applicable R-1 (Residential One Party), B-1 (Business One Party) or Centrex access line rates.

GENERAL EXCHANGE TARIFF

Embarq Florida, Inc.

SECTION A29

By: F. B. Poag  
Director

Fifth Revised Sheet 35  
Cancelling Fourth Revised Sheet 35  
Effective: March 1, 2003

DIGITAL NETWORK SERVICES

C. INTEGRATED SERVICES DIGITAL NETWORK-BASIC RATE INTERFACE (ISDN-BRI) (Cont'd)

4. Rates and Charges (Cont'd)

b. Optional Features	<u>S&amp;E Codes</u>	<u>Monthly Rates</u>
Calling Number ID/Calling Name ID	FCVISBC, FCVISBR	\$8.00
Call Pickup (per member)	FCUISBC, FCUISBR	\$2.00
Flexible Calling	FFXISBC, FFXISBR	\$3.00
Six-Way Conference Calling	FSXISBC, FSXISBR	\$5.00
Automatic Callback (Repeat Dial)	FTBISBC, FTBISBR	\$2.00
Additional Call Offering (ACO)	FEAISBC, FEAISBR	\$4.00
Call Forwarding	FCFISBC, FCFISBR	\$3.00
Additional Directory Number (each)	FNSISBC, FNSISBR	\$2.00
Multi-line Hunt Group	FSHISBC, FSHISBR	\$2.00
 c. Feature Package 1	 FPKISBC, FPKISBR	 \$10.99
Calling Number ID/Call Name ID		
Call Forwarding		
Flexible Calling		
Automatic Callback		
Additional Call Offering		
 d. Change Charges	<u>Non-Recurring Charge</u>	
Closed User Group		\$35.00
Configuration Group		\$65.00
Database Change		\$15.00

## GENERAL EXCHANGE TARIFF

Embarq Florida, Inc.

By: F. B. Poag  
Director

SECTION A29  
First Revised Sheet 36  
Cancelling Original Sheet 36  
Effective: April 2, 1999

### DIGITAL NETWORK SERVICES

#### D. ATM SERVICE

##### 1. Description

- a. Asynchronous Transfer Mode (ATM) is a connection-oriented fast packet local, intraLATA, and intrastate interLATA network service that permits the transmission of high speed data, voice, and video traffic utilizing cell switching technology. ATM cells are fixed length cells that provide symmetrical duplex transmissions. Utilizing statistical multiplexing, ATM Service enables customers to allocate circuit bandwidth to applications as needed on virtual paths or channels. ATM Service allows multiple data applications to be transmitted within multiple paths or channels utilizing common fiber optic or copper facilities. ATM Service is primarily designed for businesses with several multi-site locations requiring the transport of data, voice, or video traffic between the sites. ATM Service allows for the interconnection of Customer Premises Equipment (CPE) that is ATM compatible.
- b. Permanent Virtual Circuits (PVCs) are logical channels between the customer's premises and ports on an ATM switch or between ATM switches. PVCs are duplex channels that are established via the service order process. Separate PVCs must be established to each customer location at which the customer desires ATM Service. PVC channels are virtual channels that are established in software tables and do not tie up facilities when not in use. Multiple PVCs can be defined over a single ATM User Network Interface (UNI), thereby providing a single access line with the capability to transmit data, voice, and video to multiple destinations simultaneously. A PVC can be set up as either a Virtual Path (VP) or a Virtual Channel (VC) type connection. A VP may contain multiple VCs referred to as tunneling. Tunneling allows customers to establish VCs or end to end connections between their CPE via VPs.

## GENERAL EXCHANGE TARIFF

Embarq Florida, Inc.

By: F. B. Poag  
Director

SECTION A29  
First Revised Sheet 37  
Cancelling Original Sheet 37  
Effective: April 2, 1999

### DIGITAL NETWORK SERVICES

#### D. ATM SERVICE (Cont'd)

##### 1 Description (Cont'd)

- c. ATM Service requires the use of CPE that functions as a multiplexer, aggregator, concentrator, or router. This CPE must be purchased separately from the ATM Service and must conform to the Consultative Committee for International Telecommunication Union (ITU) Standards, ATM Forum Standards, and Company ATM CPE standards. Only Company standardized equipment may be connected to the ATM network. The CPE functions to accumulate customer data and transfers it into an ATM format suitable for transmission over the ATM Network.
- d. In the operation of ATM, the CPE captures arriving data into fixed length ATM 53-byte cells. These cells contain a 48-byte cell user information segment, and a five byte header containing a Virtual Path Identifier (VPI) and a Virtual Channel Identifier (VCI), identifying which PVC in the network should be used to forward the cell to the proper destination. The CPE sends the cells into the ATM Network over a dedicated access facility called an ATM Access Line that includes a UNI, which is a port on the ATM switch. The ATM switch, usually located in the Company central office, reads identifying header information and routes the cell to the proper destination based on a pre-established PVC, over a VP and/or VC.
- e. ATM Service is capable of handling the requirements of bursty data sources because of the ability of the service to allocate additional bandwidth when not in use by other sources. ATM Service can also transmit delay sensitive traffic such as voice and video, on the same physical circuit, but with a different Quality of Service (QoS) category on separate PVCs, within the same physical circuit.

## GENERAL EXCHANGE TARIFF

Embarq Florida, Inc.

By: F. B. Poag  
Director

SECTION A29  
First Revised Sheet 38  
Cancelling Original Sheet 38  
Effective: April 2, 1999

### DIGITAL NETWORK SERVICES

#### D. ATM SERVICE (Cont'd)

##### 1. Description (Cont'd)

- f. ATM Service is provided to the customer in the form of an ATM Access Line (a physical line that may be fiber or copper) from the Customer Designated Location (CDL), an ATM UNI port on the ATM switch, and the ATM network bandwidth via a PVC or multiple PVCs. The ATM UNI port access options available are: DS1, 2xDS1, 4xDS1, 6xDS1, 8xDS1, DS3, and OC3. Information Rate (IR) or through-put, for PVCs is available in bands ranging from 56 Kbps/64 Kbps up to 155 Mbps.
- g. The actual through-put or IR for aggregated PVC bandwidths cannot exceed the port speed, or the port line transfer rate. The customer must specify a category of service for each PVC to be connected to the ATM network. The QoS category defines the performance parameters for each connection to meet specific networking requirements. QoS provides three categories of service:
  - (1) Constant Bit Rate (CBR) for delay or timing sensitive traffic such as voice or interactive video, provides a constant data rate and consistent delay parameters throughout the ATM network. CBR PVCs are given the highest priority in the ATM network, and are provisioned to provide the minimum Cell Delay Variation (CDV) or "jitter". The Peak Cell Rate (PCR), which is the highest transmission rate the logical connection will allow, must be specified by the customer.

## GENERAL EXCHANGE TARIFF

Embarq Florida, Inc.

By: F. B. Poag  
Director

SECTION A29  
First Revised Sheet 39  
Cancelling Original Sheet 39  
Effective: April 2, 1999

### DIGITAL NETWORK SERVICES

#### D. ATM SERVICE (Cont'd)

##### 1. Description (Cont'd)

##### g. (Cont'd)

(2) Variable Bit Rate (VBR) a non-real time service designed for bursty data applications that provides a pre-assigned variable bit rate. VBR is ordered with two traffic parameters: (1) PCR, which defines the maximum rate of transmission, and (2) Sustainable Cell Rate (SCR), which provides an average through-put information rate expected on the connection. Customers must specify the SCR for ATM Service. Oversubscription is allowed with VBR.

(3) Unspecified Bit Rate (UBR) takes advantage of excess network bandwidth and is best suited for communication applications where timing of delivered data is not critical. UBR is well suited to Internet protocol LAN traffic, which has inherent reliability, and can tolerate occasional cell discarding. PCR and SCR values are not used with UBR. An advantage of UBR is that ATM cells can be transmitted up to the port line rate, if available, rather than being limited to a predefined maximum PCR, as with VBR and CBR. However, through-put is not guaranteed.

h. Since multiple PVCs may be defined on one physical port, it is possible for the cumulative data IRs of multiple PVCs to exceed the physical bandwidth of the port. This is referred to as oversubscription, and when this occurs there will be no guarantee that the IR defined for the port and PVC will be available at any point in time.

i. IRs are traffic management parameters that allow the customer to fine tune implementation of ATM Service. The IRs of PVCs can be customer specified and can be ordered in increments of bandwidth. IRs can be used on CBR and VBR PVCs only. IRs for UBR are by definition not used, and IRs can be up to the line rate or the UNI port transfer rate. UBR uses available network bandwidth and is a "best effort" service, therefore there are no guarantees with the delivery of UBR traffic. IRs are assigned to each PVC symmetrically (two-way).

## GENERAL EXCHANGE TARIFF

Embarq Florida, Inc.

By: F. B. Poag  
Director

SECTION A29  
First Revised Sheet 40  
Cancelling Original Sheet 40  
Effective: April 2, 1999

### DIGITAL NETWORK SERVICES

#### D. ATM SERVICE (Cont'd)

##### 1. Description (Cont'd)

- j. For CBR PVCs, the customer may specify IRs in terms of PCR. The maximum PCR for a CBR PVC is limited to 99% of the port transfer rate. When CBR traffic is mixed with VBR and UBR on the same port, the sum of all the PCRs associated with the CBR PVCs must not exceed 50% of the maximum IR of the ATM port. The PCR should never exceed the PCR available at the lowest port access between the local and remote locations. For VBR PVCs, the value of the SCR for ATM traffic may be defined between 20%-70% of the PCR. The user can burst above the PCR for short periods only. The limit for VBR transmission at the PCR is 250 cells. This limit is called the Maximum Burst Size (MBS). If the MBS is exceeded, a period of lower activity must follow to meet the SCR. UBR traffic IRs are not specified and use only available network bandwidth and may burst up to the line rate.

##### 2. Definitions

- a. ATM Access Line - Provides access to the ATM Network. An ATM Access Line includes both the physical dedicated local loop and a UNI port on the ATM switch.
- b. ATM Class of Service - Refers to service categories defined by the ATM Forum which define the traffic parameters for each VC. These categories, CBR, VBR, and UBR and their related parameters, partially define the traffic between the Company and the customer for each VC.
- c. ATM Network Link (ATM-NL) - Describes the link between two networks or two switches. The ATM-NL ensures that switches from different manufacturers or two different companies can communicate with each other.
- d. ATM Port - A port on the ATM network that is used to interconnect other Company provided private line services such as DigiLink, TransLink or a digital cross connect system port to ATM. The ATM Port is the physical entry point for PVCs. Ports are physically located on ATM switches and are generally named for their maximum capacity IR, such as DS1, DS3 and OC3.

## GENERAL EXCHANGE TARIFF

Embarq Florida, Inc.

By: F. B. Poag  
Director

SECTION A29  
First Revised Sheet 41  
Cancelling Original Sheet 41  
Effective: April 2, 1999

### DIGITAL NETWORK SERVICES

#### D. ATM SERVICE (Cont'd)

##### 2. Definitions (Cont'd)

- e. ATM Service Network Serving Area - An area encompassing certain serving area points. Serving area points are those Company central offices designated for the ATM network.
- f. Cell - A unit of transmission in ATM that is a fixed size frame consisting of a 5 byte header and a 48 byte information payload.
- g. Customer Designated Location (CDL) - The geographic location designated by the customer where the customer's CPE is first considered to enter the Company's network.
- h. Direct Fiber - A type of DS3 or OC3 facility provisioned using an optical fiber interface with no alternate route.
- i. Early Packet Discard (EPD) - The procedure for discarding cells related to a frame or packet to minimize the impact of congestion in the ATM network. This discarding technique with Partial Packet Discard (PPD) minimizes the amount of packets that must be retransmitted during congestion. EPD is for UBR traffic only.
- j. Frame Relay Service (FRS) - A fast packet network that provides the customer high-speed access and through-put to different customer addresses. Utilizing statistical multiplexing, the frame relay network enables the customer to allocate bandwidth to applications as needed, rather than dedicating fixed channels to specific applications.
- k. Gateway Service - Allows the Company ATM customers to interconnect to another ATM or Frame Relay Network. The service is available wherever the Company has established a network interface with another private or public ATM or Frame Relay network. Gateway Service is only available where such network connectivity exists or where suitable connectivity arrangements can be made that are acceptable to the Company.



## GENERAL EXCHANGE TARIFF

Embarq Florida, Inc.

By: F. B. Poag  
Director

SECTION A29  
First Revised Sheet 42  
Cancelling Original Sheet 42  
Effective: April 2, 1999

### DIGITAL NETWORK SERVICES

#### D. ATM SERVICE (Cont'd) (N)

##### 2. Definitions (Cont'd)

- i. Information Rate (IR) - Defines the amount of data through-put on any designated PVC that the Company will support under normal operating conditions. IR is administered per PVC, on a VP or VC basis. Any data burst beyond the IR may be labeled Discard Eligible (DE) if the data transfer rate exceeds the port transfer rate or the PCR of the PVC being used. If the ATM network develops congestion, the Early Packet Discard (EPD) and Partial Packet Discard (PPD) cell buffering techniques will be implemented in Company ATM switches for UBR traffic only. At service subscription, the customer must specify the PCR associated with each PVC. The retransmission of discarded cells is administered by the customer's CPE.
- m. Local Access and Transport Area (LATA) - Denotes a geographic area established for the provision and administration of communications service. It encompasses one or more designated exchanges that are grouped to serve common social, economic, and other purposes.
- n. Local Area Network (LAN) - A local network permitting the interconnection and intercommunication of a group of computers, primarily for the sharing of resources such as data storage devices and printers.
- o. Logical Channel - A communications channel that allows two-way, simultaneous transmission of sequenced data packets through the network. No circuit capacity is preassigned to a logical channel. Capacity is made available as the data is transmitted. Each PVC is considered one logical channel or one virtual channel.

## GENERAL EXCHANGE TARIFF

Embarq Florida, Inc.

By: F. B. Poag  
Director

SECTION A29  
First Revised Sheet 43  
Cancelling Original Sheet 43  
Effective: April 2, 1999

### DIGITAL NETWORK SERVICES

#### D. ATM SERVICE (Cont'd)

##### 2. Definitions (Cont'd)

- p. Maximum Burst Size (MBS) - Denotes the maximum number of consecutive cells that may be transmitted to the Company ATM network in a single burst at a rate that exceeds the SCR, but does not exceed the PCR, assigned to the VBR connection. MBS is a traffic parameter considered only for VBR traffic. Cells exceeding the MBS will be declared as non-conforming and will be discarded.
- q. Permanent Virtual Circuit (PVC) - Provides software-defined electronic paths between two ports within the ATM or Frame Relay Network. Each UNI requires the purchase of at least one PVC. A UNI or UNI Port connection can be associated with multiple PVCs. Since all PVCs need not be in use at the same time, it is possible for the total IR of all PVCs associated with one port to exceed the bandwidth of the port. It is not possible, however, for the simultaneous aggregation of the PVCs through-put to exceed the bandwidth of the port. Such a relationship is referred to as oversubscription or overbooking. When oversubscription occurs, there is no guarantee that the bandwidth defined for that PVC will be available at any point in time.
- r. Protocol - A specific set of rules, procedures or conventions relating to format and timing of data transmission. It is a standard procedure that multiple data devices must accept and use to be able to communicate with each other. Protocols break a file into parts called blocks or packets. When blocks or packets are sent, the receiving computer checks the arriving packet and sends an acknowledgment back to the sending computer.
- s. Route Diversity - A separate and diverse physical route from the customer premises to the Company Serving Central Office. This includes a separate fiber optic pair assignment in two different and distinct fiber optic cables.
- t. Serving Central Office (SCO) - The Company central office from which the customer normally receives dial tone.

## GENERAL EXCHANGE TARIFF

Embarq Florida, Inc.

By: F. B. Poag  
Director

SECTION A29  
First Revised Sheet 44  
Cancelling Original Sheet 44  
Effective: April 2, 1999

### DIGITAL NETWORK SERVICES

#### D. ATM SERVICE (Cont'd)

##### 2. Definitions (Cont'd)

- u. Statistical Multiplexing – A multiplexing technique in which timeslots are dynamically allocated on the basis of need rather than being predetermined. The data is typically transmitted on a first come, first served basis.
- v. Synchronous Optical Network (SONET) - A standards based fiber optic communications network that transports both asynchronous and synchronous digital signals using the Synchronous Transport Signal (STS) format. This includes a DS3 or OC3 facility provisioned as a survivable service with an alternate route.
- w. UNI Port– A port on the Company ATM switch that is used to connect to the access line. The UNI port is the physical entry point for access to PVCs. The UNI port is on the line side or customer side of the ATM switch. UNI ports include the electronic equipment used in connecting these service elements to the ATM Network and enable customers to allocate bandwidth to applications as needed.
- x. User to Network Interface (UNI) – A standard interface used to connect the end user to the Company ATM switch. It receives data cells from the customer's LAN or other CPE devices and verifies that the data is valid before relaying the ATM cells to the destination point.

GENERAL EXCHANGE TARIFF

Embarq Florida, Inc.

By: F. B. Poag  
Director

SECTION A29  
First Revised Sheet 45  
Cancelling Original Sheet 45  
Effective: April 2, 1999

DIGITAL NETWORK SERVICES

D. ATM SERVICE (Cont'd)

2. Definitions (Cont'd)

The following diagram illustrates some of the above mentioned terms:

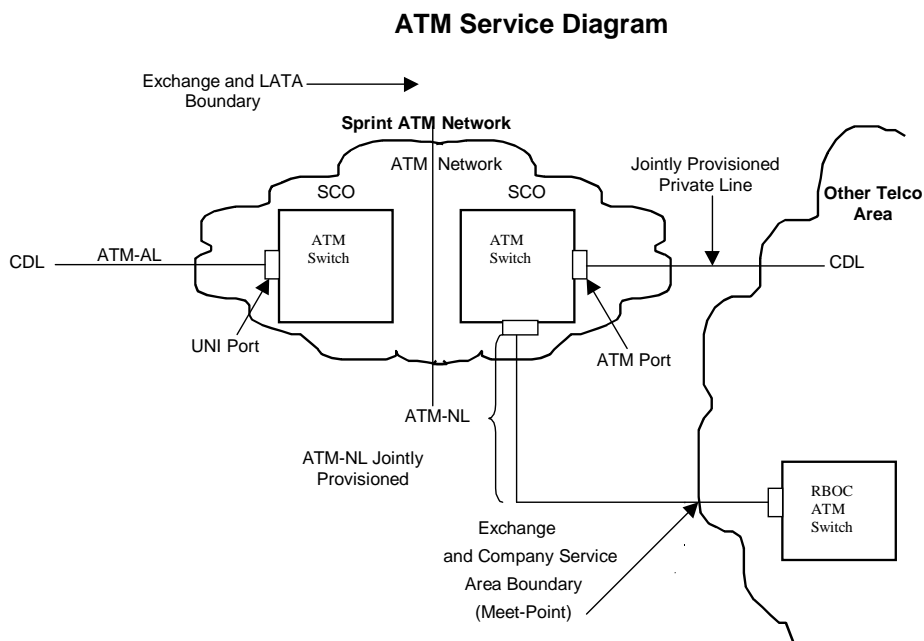

**ATM Service Between Embarq Florida, Inc.  
and another Telco Service Area**

Legend

ATM-AL	ATM Access Line (Includes UNI Port)
ATM-NL	ATM Network Link
ATM-Port	Facilities not included
CDL	Customer Designated Location
SCO	Serving Central Office
UNI Port	Intracompany Provisioned User to Network Interface

## GENERAL EXCHANGE TARIFF

Embarq Florida, Inc.

By: F. B. Poag  
Director

SECTION A29  
First Revised Sheet 46  
Cancelling Original Sheet 46  
Effective: April 2, 1999

### DIGITAL NETWORK SERVICES

#### D. ATM SERVICE (Cont'd) (N)

##### 3. General Regulations

- a. ATM Service is provided to the customer in the form of an ATM Access Line or a combination of digital, private line transport facilities, including an ATM access port, otherwise known as a UNI, and a PVC at a specified IR. The ATM Access Line includes the UNI port. A PVC must be ordered for transmission between any two locations.
- b. ATM is provided subject to the availability of appropriate facilities.
- c. The minimum service period for ATM Service is six months. ATM Service may be ordered for an initial six month term or through a Term Discount Plan for fixed periods of up to 84 months.
- d. When the customer orders additional PVCs, nonrecurring charges will apply. In addition, nonrecurring charges will apply to all changes made to a customer's ATM configuration at the customer's request.
- e. The ATM access services not covered by this tariff will be ordered from the applicable Telephone Company General Exchange Private Line Tariff.
- f. Special Construction Charges, as defined in Section A5 of this tariff, may apply when technical limitations and/or the lack of facilities exist, or if it is necessary to construct facilities to satisfy service requests.
- g. Whenever facilities are provided jointly by the Company and one or more other telephone companies, the regulations, rates and charges of such other telephone companies apply for the equipment and facilities furnished by them for use in connection with the inter-exchange ATM Service provided by the Company.
- h. Where private line, Frame Relay Service, or ATM Service is required to interconnect to the Company's ATM Service for a customer, such service will be furnished only if satisfactory arrangements can be made with the other company.

## GENERAL EXCHANGE TARIFF

Embarq Florida, Inc.

By: F. B. Poag  
Director

SECTION A29  
First Revised Sheet 47  
Cancelling Original Sheet 47  
Effective: April 2, 1999

### DIGITAL NETWORK SERVICES

#### D. ATM SERVICE (Cont'd)

##### 3. General Regulations (Cont'd)

- i. Suspension of service at the customer's request, as defined in Section A2 of this tariff, is not allowed for ATM Service.
- j. The customer is responsible for payment of a Trouble Location Charge, as set forth in Section 4A of this tariff, for visits by the Company to the customer premises when a service difficulty resulting in a trouble report is caused by the use of equipment or facilities provided by the customer.

##### 4. Obligations of the Company

- a. The responsibility of the Company is limited to furnishing network equipment suitable for ATM Service and to the maintenance and operation of such equipment in a manner proper for such service. Subject to this responsibility, the Company is not responsible for the through transmission of signals generated by the CPE or systems, or for the quality of, or defects in, such transmission or the reception of signals by such equipment or systems.
- b. The Company is not responsible for installation, operation or maintenance of any terminal equipment, data unit or communications system provided by a customer or user. The Company is not responsible for adapting ATM Service to the technological requirements of any specific customer equipment.
- c. The Company is not responsible to the customer or user if changes in any of the equipment, operations or procedures of the Company used in the provision of ATM Service render any facilities provided by the customer or user obsolete or require modification or alteration of such equipment or system or otherwise affect its use or performance, provided the Company has met any applicable information disclosure requirements otherwise required by law.
- d. In order to maintain the quality of ATM Service, the Company reserves the right to perform preventative maintenance and software updates to the network. The Company has classified this maintenance as indicated below:

## GENERAL EXCHANGE TARIFF

Embarq Florida, Inc.

By: F. B. Poag  
Director

SECTION A29  
First Revised Sheet 48  
Cancelling Original Sheet 48  
Effective: April 2, 1999

### DIGITAL NETWORK SERVICES

#### D. ATM SERVICE (Cont'd)

##### 4. Obligations of the Company (Cont'd)

###### d. (Cont'd)

###### Scheduled Maintenance

Scheduled maintenance is used to perform such functions as hardware and software upgrades and network optimization. The Company will perform these tasks in a maintenance window that is defined as occurring between midnight and 6 a.m., local time, seven days per week. The Company will provide advance notice of all scheduled maintenance.

###### Demand Maintenance

Demand maintenance may occur as a result of unexpected events and is performed when ATM Service network elements are in jeopardy. The Company will perform this type of maintenance at its discretion. Due to the nature of demand maintenance prior notification may not be possible; however, the customer will be informed when the maintenance has been completed.

##### 5. Obligations of the Customer

- a. The customer's ATM compatible terminal equipment is responsible for retransmitting cells or packets that are discarded due to errors or network congestion.
- b. Where ATM Service is available for use in connection with communications systems or equipment provided by a customer or user, the operating characteristics of such systems or equipment shall be such as not to interfere with any services offered by the Company. Such use is subject to the further provisions that the equipment provided by the customer or user does not endanger the safety of Company employees or the public; does not damage, harm, require change in or alteration of the equipment or other services of the Company; does not interfere with the proper operation of the Company's equipment; or does not otherwise injure the public in its use of Company services. Upon notice from the Company that the equipment provided by the customer or user is causing, or is likely to cause, such hazard or interference, the customer shall take the necessary steps to remove or prevent such hazard or interference.

GENERAL EXCHANGE TARIFF

Embarq Florida, Inc.

By: F. B. Poag  
Director

SECTION A29  
First Revised Sheet 49  
Cancelling Original Sheet 49  
Effective: April 2, 1999

DIGITAL NETWORK SERVICES

D. ATM SERVICE (Cont'd)

5. Obligations of the Customer (Cont'd)

- c. The customer, upon request, shall furnish such CPE information as may be required to permit the Company to design and maintain the ATM Service it offers and to assure that the service arrangement is in compliance with the regulations contained herein.
- d. Upon service subscription, the customer should specify the IR and Class of Service for each PVC ordered. IR is the maximum information rate at which the customer's traffic will be admitted to the ATM network without being designated eligible for discard. A default of fifty (50) percent of the smallest port size will be assigned as the IR should the information not be provided. No individual PVC IR shall exceed (99) percent of the UNI port access rate. The sum of all PVCs IRs on a single ATM port must not exceed two hundred (200) percent of the port line rate.

6. Term Discount Plan (TDP)

- a. Term Discount Plan (TDP) provides the customer with discounted tariff rates for the ATM Access Line and the ATM-Network Link. The customer agrees to a minimum service commitment period for ATM Access Line and/or Private Network Link when the TDP is established. Customers may disconnect or move PVCs and not be subject to termination liability charges. The customer must order a TDP in writing to the Company. A TDP may be ordered in increments of one month, based on the following plan options:

Plan A:	12 - 23 months
Plan B:	24 - 35 months
Plan C:	36 - 59 months
Plan D:	60 - 84 months

- b. The customer must specify the length of the initial service period at the time the service is ordered. When a customer converts to a TDP, no administrative charges are applied toward facilities in service at that time. If a customer moves from a month-to-month plan to a TDP, or upgrades from one TDP to another, no administrative charges are applied.



GENERAL EXCHANGE TARIFF

Embarq Florida, Inc.

By: F. B. Poag  
Director

SECTION A29  
Third Revised Sheet 50  
Cancelling Second Revised Sheet 50  
Effective: May 1, 2003

DIGITAL NETWORK SERVICES

D. ATM SERVICE (Cont'd)

6. Term Discount Plan (TDP) (Cont'd)

- c. If a TDP customer under a Term Discount Plan (TDP) disconnects any portion of the ATM Access Line and/or ATM-Network Link TDP service prior to the expiration of the TDP, then a Termination Liability Charge will apply to those elements that are disconnected. The Termination Liability Charge will be a one-time charge equal to the sum of 50% of the payments for the rest of the TDP. If Charges Applicable Under Special Conditions charges were applied to the service being terminated, any termination charges associated with the Charges Applicable Under Special Conditions will also apply.
- d. Rate increases or decreases will automatically be applied to the monthly term plan rates for the remaining term of the TDP. If Company initiated rate increases to any rate element or combination of rate elements causes the charges for the entire ATM service under the TDP to increase by 10% or more annually, then the customer may cancel the TDP without incurring termination liability charges provided that the customer notifies the Company within 30 days after the effective date of the rate increase.
- e. TDP commitment periods can be extended by the customer at any time during the term of the plan, up to a maximum of 84 months. The number of months accrued in the current plan will be applied toward the new plan selected.
- f. At the end of the TDP service commitment period, the customer may subscribe to a new TDP at the prevailing rates set forth in Section 8.a-g following. If the customer does not select a new TDP, the rates will convert to the prevailing month-to-month rates.

GENERAL EXCHANGE TARIFF

Embarq Florida, Inc.

By: F. B. Poag  
Director

SECTION A29  
Second Revised Sheet 50.1  
Cancelling First Revised Sheet 50.1  
Effective: May 1, 2003

DIGITAL NETWORK SERVICES

D. ATM SERVICE (Cont'd)

6. Term Discount Plan (TDP) (Cont'd)

- g. Termination Liability Charges will not apply when a service or rate element under a Term Discount Plan (TDP) arrangement is disconnected prior to the expiration of a selected service period as a result of a change in tariff jurisdiction and/or a customer requested upgrade to a next generation service offering under the following conditions:

The service period of the new TDP arrangement for the new service offering is a period equal to or exceeding the remaining service period of the disconnected arrangement TDP, and

The service orders to install the new service and disconnect the old service are related together, and there is no lapse in service between the installation of the new service and disconnection of the existing service, and

The service orders to install the new service and disconnect the older service are for the same customer at the same location.

The Telephone Company will determine whether replacement service qualifies as a next generation service offering.

Nonrecurring charges and Service Charges for the new service will apply according to the requirements of the new service.

## GENERAL EXCHANGE TARIFF

Embarq Florida, Inc.

By: F. B. Poag  
Director

SECTION A29  
First Revised Sheet 51  
Cancelling Original Sheet 51  
Effective: April 2, 1999

### DIGITAL NETWORK SERVICES

#### D. ATM SERVICE (Cont'd)

##### 7. Service Components

- a. Administrative Charge – Applies to changes in a customer's network associated with PVCs. Although multiple changes can be caused by such actions, only one administrative charge applies per customer request. This administrative charge applies in addition to applicable Service Charges as specified in Section A4 of this tariff.
- b. ATM Access Line (ATM-AL) - A nonrecurring charge and monthly rate based on the connection line speed of the local loop access line. The access line is from the CDL to the serving central office and includes the UNI port on the ATM switch. Where the CDL is located in another telephone company's service area, the ATM Access Line charges provide for transport to the meet-point boundary with the other local telephone company. Charges for service from the meet-point boundary to the CDL will be the responsibility of the customer based on the rates and charges of each jointly provisioning telephone company. Special Construction Charges may apply, if facilities do not already exist. Route Diversity of the loop portion of ATM Access Line also may require a Special Construction Charges.
- c. ATM Network Link (ATM-NL) - A nonrecurring charge and monthly rate based on the DS1 or DS3 port at the Company's ATM and transport from the ATM to the interconnecting ATM. Where the service is jointly provisioned with another telephone company, the appropriate charges will be based on the distance from the ATM to the meet-point boundary with the other telephone company. Charges for service from the meet-point boundary to the other company's ATM switch will be the responsibility of the customer based on the rates and charges of each jointly provisioning telephone company. In addition to a DS1 or DS3 ATM Network Link, a minimum of one Gateway Service for bandwidth will apply.
- d. ATM Port - A nonrecurring charge and monthly rate based on the speed of the port connection applies per port connection to the network supporting ATM. The port rate element can be used in lieu of the ATM Access Line element if the customer has an alternative Company-approved means of access to the ATM Network (such as DigiLink and TransLink).

GENERAL EXCHANGE TARIFF

Embarq Florida, Inc.

By: F. B. Poag  
Director

SECTION A29  
First Revised Sheet 52  
Cancelling Original Sheet 52  
Effective: April 2, 1999

DIGITAL NETWORK SERVICES

D. ATM SERVICE (Cont'd)

7. Service Components (Cont'd)

- e. Gateway Service - This service allows the Company's ATM customers to interconnect to another ATM or FRS Network. The service is available wherever the Company has established a network interface with another private or public ATM or Frame Relay network. The charge for this service covers the facility from the Company ATM port to the interconnecting ATM or Frame Relay point of another company. The charge includes the software defined PVC to the other company's network to the UNI port, but does not include the UNI port provided by the other company. Gateway Service is purchased in increments of IR. The customer accomplishes this by ordering PVCs and Gateway Service connections to the other company's ATM or Frame Relay Network.
- f. IR and PVC - A monthly rate applies for each PVC based on the IR requested by the customer. If no IR is indicated, the IR will be set at the default of 50% of the associated ATM UNI Port. A nonrecurring charge applies for the establishment of each PVC and for each subsequent order of PVC(s). A separate rate is established for PVCs that are intraLATA and for PVCs that are interLATA.

Customers may select from three different Categories of Service or Classes of Service for PVCs to ensure greater reliability for mission-critical applications in the event of network congestion:

Lowest Priority – Unspecified Bit Rate (UBR)  
Higher Priority – Variable Bit Rate (VBR)  
Highest Priority – Constant Bit Rate (CBR)

This flexibility helps to ensure maximum performance and satisfaction for individual customer data applications.

GENERAL EXCHANGE TARIFF

Embarq Florida, Inc.

By: F. B. Poag  
Director

SECTION A29  
Third Revised Sheet 53  
Cancelling Second Revised Sheet 53  
Effective: May 5, 2004

DIGITAL NETWORK SERVICES

D. ATM SERVICE (Cont'd)

8. Rates and Charges

a. ATM Access Line (ATM-AL) (includes Access Line and Port)

	<u>SAE Code</u>	<u>Monthly Rate</u>	<u>NRC</u>
1.544 Mbps (DS1 UNI)			
Month to month	PUNIDS1(MTM)	\$ 517.75	\$ 700.00
12-23 months	PUNIDS1(1YR)	\$ 490.00	\$ 700.00
24-35 months	PUNIDS1(2YR)	\$ 480.00	\$ 700.00
36-59 months	PUNIDS1(3YR)	\$ 470.00	N/A
60-84 months	PUNIDS1(5YR)	\$ 445.00	N/A
*3 Mbps (2xDS1 UNI)			
Month to month	PUNI2DS(MTM)	\$ 800.00	\$ 800.00
12-23 months	PUNI2DS(1YR)	\$ 750.00	\$ 800.00
24-35 months	PUNI2DS(2YR)	\$ 710.00	\$ 800.00
36-59 months	PUNI2DS(3YR)	\$ 690.00	N/A
60-84 months	PUNI2DS(5YR)	\$ 650.00	N/A
*6 Mbps (4xDS1 UNI)			
Month to month	PUNI4DS(MTM)	\$1,300.00	\$ 900.00
12-23 months	PUNI4DS(1YR)	\$1,230.00	\$ 900.00
24-35 months	PUNI4DS(2YR)	\$1,160.00	\$ 900.00
36-59 months	PUNI4DS(3YR)	\$1,125.00	N/A
60-84 months	PUNI4DS(5YR)	\$1,090.00	N/A
*9 Mbps (6xDS1 UNI)			
Month to month	PUNI6DS(MTM)	\$1,915.00	\$1,000.00
12-23 months	PUNI6DS(1YR)	\$1,820.00	\$1,000.00
24-35 months	PUNI6DS(2YR)	\$1,725.00	\$1,000.00
36-59 months	PUNI6DS(3YR)	\$1,675.00	N/A
60-84 months	PUNI6DS(5YR)	\$1,630.00	N/A
*12 Mbps (8xDS1 UNI)			
Month to month	PUNI8DS(MTM)	\$2,400.00	\$1,100.00
12-23 months	PUNI8DS(1YR)	\$2,275.00	\$1,100.00
24-35 months	PUNI8DS(2YR)	\$2,150.00	\$1,100.00
36-59 months	PUNI8DS(3YR)	\$2,085.00	N/A
60-84 months	PUNI8DS(5YR)	\$2,025.00	N/A

\* Where facilities are available

GENERAL EXCHANGE TARIFF

Embarq Florida, Inc.

By: F. B. Poag  
Director

SECTION A29  
First Revised Sheet 54  
Cancelling Original Sheet 54  
Effective: April 2, 1999

DIGITAL NETWORK SERVICES

D. ATM SERVICE (Cont'd)

8. Rates and Charges (Cont'd)

a. ATM Access Line (ATM-AL) (includes Access Line and Port) (Cont'd)

	<u>SAE Code</u>	<u>Monthly Rate</u>	<u>NRC</u>
*45 Mbps (DS3 UNI) (Direct Fiber)			
Month to month			
0-3 miles	PUN3D03(MTM)	\$3,200.00	\$1,300.00
Over 3 miles	PUN3DG3(MTM)	\$3,800.00	\$1,300.00
12-23 months			
0-3 miles	PUN3D03(1YR)	\$3,000.00	\$1,300.00
Over 3 miles	PUN3DG3(1YR)	\$3,600.00	\$1,300.00
24-35 months			
0-3 miles	PUN3D03(2YR)	\$2,800.00	\$1,300.00
Over 3 miles	PUN3DG3(2YR)	\$3,400.00	\$1,300.00
36-59 months			
0-3 miles	PUN3D03(3YR)	\$2,600.00	N/A
Over 3 miles	PUN3DG3(3YR)	\$3,200.00	N/A
60-84 months			
0-3 miles	PUN3D03(5YR)	\$2,400.00	N/A
Over 3 miles	PUN3DG3(5YR)	\$3,000.00	N/A
*45 Mbps (DS3 UNI) (SONET)			
Month to month			
0-3 miles	PUN3S03(MTM)	\$4,600.00	\$2,500.00
Over 3 miles	PUN3SG3(MTM)	\$5,200.00	\$2,500.00
12-23 months			
0-3 miles	PUN3S03(1YR)	\$4,200.00	\$2,500.00
Over 3 miles	PUN3SG3(1YR)	\$4,800.00	\$2,500.00
24-35 months			
0-3 miles	PUN3S03(2YR)	\$3,800.00	\$2,500.00
Over 3 miles	PUN3SG3(2YR)	\$4,400.00	\$2,500.00
36-59 months			
0-3 miles	PUN3S03(3YR)	\$3,400.00	N/A
Over 3 miles	PUN3SG3(3YR)	\$4,000.00	N/A
60-84 months			
0-3 miles	PUN3S03(5YR)	\$3,000.00	N/A
Over 3 miles	PUN3SG3(5YR)	\$3,600.00	N/A

\* Where facilities are available

GENERAL EXCHANGE TARIFF

Embarq Florida, Inc.

By: F. B. Poag  
Director

SECTION A29  
First Revised Sheet 55  
Cancelling Original Sheet 55  
Effective: April 2, 1999

DIGITAL NETWORK SERVICES

D. ATM SERVICE (Cont'd)

8. Rates and Charges (Cont'd)

a. ATM Access Line (ATM-AL) (includes Access Line and Port) (Cont'd)

	<u>SAE Code</u>	<u>Monthly Rate</u>	<u>NRC</u>
*155 Mbps (OC3 UNI) (Direct Fiber)			
Month to month		\$	
0-3 miles	PUNOC03(MTM)	\$3,600.00	\$3,000.00
Over 3 miles	PUNOCG3(MTM)	\$4,300.00	\$3,000.00
12-23 months			
0-3 miles	PUNOC03(1YR)	\$3,400.00	\$3,000.00
Over 3 miles	PUNOCG3(1YR)	\$4,100.00	\$3,000.00
24-35 months			
0-3 miles	PUNOC03(2YR)	\$3,200.00	\$3,000.00
Over 3 miles	PUNOCG3(2YR)	\$3,900.00	\$3,000.00
36-59 months			
0-3 miles	PUNOC03(3YR)	\$3,000.00	N/A
Over 3 miles	PUNOCG3(3YR)	\$3,700.00	N/A
60-84 months			
0-3 miles	PUNOC03(5YR)	\$2,800.00	N/A
Over 3 miles	PUNOCG3(5YR)	\$3,500.00	N/A
*155 Mbps (OC3 UNI) (SONET)			
Month to month			
0-3 miles	PUNOCS0(MTM)	\$5,800.00	\$4,000.00
Over 3 miles	PUNOCS3(MTM)	\$6,400.00	\$4,000.00
12-23 months			
0-3 miles	PUNOCS0(1YR)	\$5,400.00	\$4,000.00
Over 3 miles	PUNOCS3(1YR)	\$6,000.00	\$4,000.00
24-35 months			
0-3 miles	PUNOCS0(2YR)	\$5,000.00	\$4,000.00
Over 3 miles	PUNOCS3(2YR)	\$5,600.00	\$4,000.00
36-59 months			
0-3 miles	PUNOCS0(3YR)	\$4,600.00	N/A
Over 3 miles	PUNOCS3(3YR)	\$5,200.00	N/A
60-84 months			
0-3 miles	PUNOCS0(5YR)	\$4,200.00	N/A
Over 3 miles	PUNOCS3(5YR)	\$4,800.00	N/A

\* Where facilities are available

GENERAL EXCHANGE TARIFF

Embarq Florida, Inc.

By: F. B. Poag  
Director

SECTION A29  
First Revised Sheet 56  
Cancelling Original Sheet 56  
Effective: April 2, 1999

DIGITAL NETWORK SERVICES

D. ATM SERVICE (Cont'd)

8. Rates and Charges (Cont'd)

b. ATM Port (Port Only)

	<u>SAE Code</u>	<u>Monthly Rate</u>	<u>NRC</u>
1.544 Mbps (DS1 UNI)			
Month to month	PUNPDS1(MTM)	\$ 460.00	\$ 400.00
12-23 months	PUNPDS1(1YR)	\$ 445.00	\$ 400.00
24-35 months	PUNPDS1(2YR)	\$ 415.00	\$ 400.00
36-59 months	PUNPDS1(3YR)	\$ 365.00	N/A
60-84 months	PUNPDS1(5YR)	\$ 310.00	N/A
*3 Mbps (2xDS1 UNI)			
Month to month	PUNP2DS(MTM)	\$ 710.00	\$ 500.00
12-23 months	PUNP2DS(1YR)	\$ 640.00	\$ 500.00
24-35 months	PUNP2DS(2YR)	\$ 560.00	\$ 500.00
36-59 months	PUNP2DS(3YR)	\$ 480.00	N/A
60-84 months	PUNP2DS(5YR)	\$ 400.00	N/A
*6 Mbps (4xDS1 UNI)			
Month to month	PUNP4DS(MTM)	\$1,125.00	\$ 600.00
12-23 months	PUNP4DS(1YR)	\$1,080.00	\$ 600.00
24-35 months	PUNP4DS(2YR)	\$1,005.00	\$ 600.00
36-59 months	PUNP4DS(3YR)	\$ 895.00	N/A
60-84 months	PUNP4DS(5YR)	\$ 760.00	N/A
*9 Mbps (6xDS1 UNI)			
Month to month	PUNP6DS(MTM)	\$1,690.00	\$ 700.00
12-23 months	PUNP6DS(1YR)	\$1,620.00	\$ 700.00
24-35 months	PUNP6DS(2YR)	\$1,510.00	\$ 700.00
36-59 months	PUNP6DS(3YR)	\$1,340.00	N/A
60-84 months	PUNP6DS(5YR)	\$1,140.00	N/A
*12 Mbps (8xDS1 UNI)			
Month to month	PUNP8DS(MTM)	\$2,250.00	\$ 800.00
12-23 months	PUNP8DS(1YR)	\$2,160.00	\$ 800.00
24-35 months	PUNP8DS(2YR)	\$2,010.00	\$ 800.00
36-59 months	PUNP8DS(3YR)	\$1,790.00	N/A
60-84 months	PUNP8DS(5YR)	\$1,520.00	N/A

\* Where facilities are available



GENERAL EXCHANGE TARIFF

Embarq Florida, Inc.

By: F. B. Poag  
Director

SECTION A29  
First Revised Sheet 57  
Cancelling Original Sheet 57  
Effective: April 2, 1999

DIGITAL NETWORK SERVICES

D. ATM SERVICE (Cont'd)

8. Rates and Charges (Cont'd)

b. ATM Port (Port Only) (Cont'd)

	<u>SAE Code</u>	<u>Monthly Rate</u>	<u>NRC</u>
45 Mbps (DS3 UNI) (Direct Fiber), Within CO			
Month to month	PUN3DCO(MTM)	\$2,250.00	\$1,500.00
12-23 months	PUN3DCO(1YR)	\$2,100.00	\$1,500.00
24-35 months	PUN3DCO(2YR)	\$1,950.00	\$1,500.00
36-59 months	PUN3DCO(3YR)	\$1,820.00	N/A
60-84 months	PUN3DCO(5YR)	\$1,680.00	N/A
155 Mbps (OC3 UNI) (Direct Fiber), Within CO			
Month to month	PUNOCCO(MTM)	\$2,500.00	\$2,000.00
12-23 months	PUNOCCO(1YR)	\$2,400.00	\$2,000.00
24-35 months	PUNOCCO(2YR)	\$2,250.00	\$2,000.00
36-59 months	PUNOCCO(3YR)	\$2,100.00	N/A
60-84 months	PUNOCCO(5YR)	\$1,950.00	N/A

GENERAL EXCHANGE TARIFF

Embarq Florida, Inc.

By: F. B. Poag  
Director

SECTION A29  
Second Revised Sheet 58  
Cancelling First Revised Sheet 58  
Effective: August 16, 2000

DIGITAL NETWORK SERVICES

D. ATM SERVICE (Cont'd)

8. Rates and Charges (Cont'd)

c. Permanent Virtual Circuit (PVC) - IntraLATA

	<u>SAE Code</u>	<u>Monthly Rate (Per Increment)</u>	<u>NRC (Per PVC)</u>
Over 0 thru 2.944 Mbps (Per increments of 64 Kbps)			
CBR	PUNPVCK(RBC)	\$ 8.00	\$ 50.00
VBR	PUNPVCK(VBR)	\$ 6.00	\$ 50.00
Over 2.944 Mbps (Per increments of 1 Mbps)			
CBR	PUNPVCM(RBC)	\$ 40.00	\$ 50.00
VBR	PUNPVCM(VBR)	\$ 30.00	\$ 50.00
UBR, Per Connection			
Per DS1 Connection	PUNPVCM(DS1)	\$ 12.00	\$ 50.00
Per NXDS1 Connection	PUNPVCM(IMA)	\$ 45.00	\$ 50.00
Per DS3 Connection	PUNPVCM(DS3)	\$275.00	\$ 50.00
Per OC3 Connection	PUNPVCM(OC3)	\$775.00	\$ 50.00

d. Permanent Virtual Circuit (PVC) - InterLATA

	<u>SAE Code</u>	<u>Monthly Rate (Per Increment)</u>	<u>NRC (Per PVC)</u>
Over 0 thru 2.944 Mbps (Per increments of 64 Kbps)			
CBR	PUNPVIK(RBC)	\$ 12.00	\$100.00
VBR	PUNPVIK(VBR)	\$ 8.00	\$100.00
Over 2.944 Mbps (Per increments of 1 Mbps)			
CBR	PUNPVIM(RBC)	\$ 60.00	\$100.00
VBR	PUNPVIM(VBR)	\$ 40.00	\$100.00
UBR, Per Connection			
Per DS1 Connection	PUNPVIM(DS1)	\$ 15.00	\$ 50.00
Per NXDS1 Connection	PUNPVIM(IMA)	\$ 55.00	\$ 50.00
Per DS3 Connection	PUNPVIM(DS3)	\$330.00	\$ 50.00
Per OC3 Connection	PUNPVIM(OC3)	\$930.00	\$ 50.00

GENERAL EXCHANGE TARIFF

Embarq Florida, Inc.

By: F. B. Poag  
Director

SECTION A29  
First Revised Sheet 59  
Cancelling Original Sheet 59  
Effective: April 2, 1999

DIGITAL NETWORK SERVICES

D. ATM SERVICE (Cont'd)

8. Rates and Charges (Cont'd)

e. ATM Network Link (ATM-NL)

	<u>SAE Code</u>	<u>Monthly Rate</u>	<u>NRC</u>
*1.544 Mbps ATM-NL			
Month to month	PUNPNL1(MTM)	\$ 470.00	\$375.00
12-23 months	PUNPNL1(1YR)	\$ 445.00	\$375.00
24-35 months	PUNPNL1(2YR)	\$ 415.00	\$375.00
36-59 months	PUNPNL1(3YR)	\$ 350.00	\$375.00
60-84 months	PUNPNL1(5YR)	\$ 300.00	\$375.00
*45 Mbps ATM-NL			
Within CO			
Month to month	PUNPNLC(MTM)	\$1,500.00	\$375.00
12-23 months	PUNPNLC(1YR)	\$1,450.00	\$375.00
24-35 months	PUNPNLC(2YR)	\$1,320.00	\$375.00
36-59 months	PUNPNLC(3YR)	\$1,180.00	\$375.00
60-84 months	PUNPNLC(5YR)	\$1,000.00	\$375.00
*45 Mbps ATM-NL			
0-3 miles			
Month to month	PUNPNL3(MTM)	\$1,700.00	\$375.00
12-23 months	PUNPNL3(1YR)	\$1,580.00	\$375.00
24-35 months	PUNPNL3(2YR)	\$1,450.00	\$375.00
36-59 months	PUNPNL3(3YR)	\$1,350.00	\$375.00
60-84 months	PUNPNL3(5YR)	\$1,200.00	\$375.00
*45 Mbps ATM-NL			
Over 3 miles			
Month to month	PUNPNLG(MTM)	\$2,550.00	\$375.00
12-23 months	PUNPNLG(1YR)	\$2,480.00	\$375.00
24-35 months	PUNPNLG(2YR)	\$2,300.00	\$375.00
36-59 months	PUNPNLG(3YR)	\$2,040.00	\$375.00
60-84 months	PUNPNLG(5YR)	\$1,750.00	\$375.00

\* Where facilities are available

GENERAL EXCHANGE TARIFF

Embarq Florida, Inc.

By: F. B. Poag  
Director

SECTION A29  
Second Revised Sheet 60  
Cancelling First Revised Sheet 60  
Effective: August 16, 2000

DIGITAL NETWORK SERVICES

D. ATM SERVICE (Cont'd)

8. Rates and Charges (Cont'd)

f. Administrative Charge

An administrative charge will be applied, in addition to applicable service connection charges as specified in Section A4 of this tariff, when a customer initiated change is made to the parameters associated with Permanent Virtual Circuits (PVC) or other service parameters that do not involve the reconfiguration of an ATM Access Line or an ATM Port. Such changes are defined as those requiring no changes in physical facilities, and can be facilitated by the Company without dispatching Company personnel to the customer's physical location. When changes to an ATM Access Line or an ATM Port are involved, a disconnect order and a subsequent connect order will be required and the appropriate NRC as specified in this section of the tariff will apply. The administrative charge applies to changes in a customer's network associated with PVCs. Only one administrative charge applies per customer request.

Administrative Charge (Nonrecurring)	\$75.00
--------------------------------------	---------

g. Gateway Service

	<u>SAE Code</u>	<u>Monthly Rate (Per Increment)</u>	<u>NRC (Per PVC)</u>
Over 0 thru 2.944 Mbps (Per increments of 64 Kbps)			
CBR	PUNIGWK(RBC)	\$ 12.00	\$100.00
VBR	PUNIGWK(VBR)	\$ 8.00	\$100.00
Over 2.944 Mbps (Per increments of 1 Mbps)			
CBR	PUNIGWM(RBC)	\$ 60.00	\$100.00
VBR	PUNIGWM(VBR)	\$ 40.00	\$100.00
UBR, Per Connection			
Per DS1 Connection	PUNIGWM(DS1)	\$ 15.00	\$ 50.00
Per NXDS1 Connection	PUNIGWM(IMA)	\$ 55.00	\$ 50.00
Per DS3 Connection	PUNIGWM(DS3)	\$330.00	\$ 50.00
Per OC3 Connection	PUNIGWM(OC3)	\$930.00	\$ 50.00

## GENERAL EXCHANGE TARIFF

Embarq Florida, Inc.

By: F. B. Poag  
Director

SECTION A29  
First Revised Sheet 61  
Cancelling Original Sheet 61  
Effective: April 15, 2001

### DIGITAL NETWORK SERVICES

#### E. ENHANCED FRAME RELAY SERVICE

##### 1. Description

- a. Enhanced Frame Relay Service (EFRS) is a fast packet network that permits the transmission of data at speeds of 56/64 Kbps, 128 Kbps, 256 Kbps, 384 Kbps, 512 Kbps, 1.544 MBPS, or 44.210 MBPS using Permanent Virtual Circuits (PVCs). Utilizing statistical multiplexing, the FRS network enables the customer to allocate circuit bandwidth to applications as needed, rather than assigning fixed channels to specific applications.
- b. Permanent Virtual Circuits (PVCs) are logical channels that connect ports on a frame relay switch or between frame relay switches. PVCs are end-to-end, bi-directional channels that are established and non-established via the service order process. Separate PVCs must be established to each location to which the customer desires to transmit data. PVC channels are virtual channels that are established in software tables and do not tie up facilities when not in use. With EFRS, customers may select from three different classes of PVCs to ensure greater reliability for mission-critical applications in the event of network congestion. Multiple PVCs can be defined over a single Enhanced Frame Relay Access Line (EFRAL), thereby providing a single access line the capability to transmit data to multiple destinations.
- c. EFRS requires the use of customer terminal equipment that functions as a multiplexer, bridger or router. This terminal equipment must be purchased separately from the EFRS and must conform to Consultative Committee for International Telecommunication Union (ITU) and American National Standards Institute (ANSI) standards set forth in ITU: Q.933 Annex A, ANSI: T1.617 Annex D. The terminal equipment accumulates customer data and transfers it into a frame relay format suitable for transmission over the EFRS network.
- d. In the operation of EFRS, Customer Premises Equipment (CPE), such as frame relay assemblers and disassemblers, encapsulate arriving data into variable length frames. The information contained in these frames is data link connection identifier (DLCI) addresses, which identifies the PVC in the network that should be used to forward the frame to its proper destination. The CPE then sends the frame into the EFRS network over a dedicated access facility called a User Network Interface (UNI). The frame relay switch reads identifying information and routes the frame to the proper destination based on pre-established PVC.

## GENERAL EXCHANGE TARIFF

Embarq Florida, Inc.

By: F. B. Poag  
Director

SECTION A29  
First Revised Sheet 62  
Cancelling Original Sheet 62  
Effective: April 15, 2001

### DIGITAL NETWORK SERVICES

#### E. ENHANCED FRAME RELAY SERVICE (Cont'd)

##### 1. Description (Cont'd)

- e. Variable frame length capability is useful in communications between asynchronous Local Area Networks (LAN) and for transport of synchronous data traffic. EFRS is capable of handling the requirements of bursty data sources because of the ability of the service to allocate additional bandwidth when not in use by other sources.
- f. EFRS is provided to the customer in the form of an EFRAL, Frame Relay User Network Interface Port and the PVC.
- g. The actual throughput of aggregated PVC bandwidths in use at the same time on the same port cannot exceed the port speed.
- h. Since multiple PVCs may be defined on one physical port, it is possible for the cumulative Committed Information Rates (CIRs) to exceed the physical bandwidth of that port. This is referred to as oversubscription and when this occurs, there can be no guarantee that the CIR defined for that port and PVC will be available at any point in time.
- i. The CIR and the Excess Burst Size ( $B_e$ ) are traffic management parameters that allow the customer to fine tune implementation of EFRS in conjunction with the classes of PVCs offered.
- j. 64 Kbps Clear Channel Capability (CCC) will be provided upon request and where deemed applicable by the Company. Charges Applicable Under Special Conditions may apply.

##### 2. Definitions

- a. 64 Kbps Clear Channel Capability (CCC) - A channel connection that provides an end-to-end digital connection between the customer's premises and the customer's Central Office in which all 64 Kbps of bandwidth are available for the customer's use.
- b. Committed Information Rate (CIR) - Defines the amount of data throughput on any designated PVC that the Company will support under normal operating conditions. CIR is administered per PVC. Any data burst beyond the CIR may be labeled Discard Eligible (DE) if the data transfer rate exceeds the CIR of the PVC being used. If the EFRS network develops congestion, the frames marked DE may be discarded. Upon service subscription, the customer must specify the PVC class and CIR for each PVC. The retransmission of discarded frames is administered by the customer's CPE.
- c. Customer Designated Location (CDL) - The geographic location designated by the customer where the customer's CPE is first considered to enter the Company's network.

## GENERAL EXCHANGE TARIFF

Embarq Florida, Inc.

By: F. B. Poag  
Director

SECTION A29  
First Revised Sheet 63  
Cancelling Original Sheet 63  
Effective: April 15, 2001

### DIGITAL NETWORK SERVICES

#### E. ENHANCED FRAME RELAY SERVICE (Cont'd)

##### 2. Definitions (Cont'd)

- d. Data Link Connection Identifier (DLCI) – The address information contained in the frame relay header that conveys to the network how an individual frame should be routed. The DLCI essentially defines the customer end point to which a particular frame should be sent.
- e. Enhanced Frame Relay Access Line (EFRAL) – A UNI that provides access to the EFRS network. An EFRAL includes the provision of an enhanced frame relay access port and the physical facility from the customer designated location to the Company Serving Central Office.
- f. Enhanced Frame Relay Access Port (EFRAP) – A port on the EFRS network that is used to interconnect other Company provided private line services such as a digital cross connect system port to the EFRS network. The EFRAP is the physical entry point for PVCs. Ports include the electronic equipment used in connecting these service elements to the EFRS network and enable customers to allocate bandwidth to applications as needed.
- g. Enhanced Frame Relay Service (EFRS) – A fast packet network that provides the customer high-speed access and throughput to different customer addresses. Utilizing statistical multiplexing, the EFRS network enables the customer to allocate bandwidth to applications as needed, rather than dedicating fixed channels to specific applications. Customers may select from three different classes of PVCs to ensure greater reliability for mission-critical applications in the event of network congestion.
- h. Enhanced Frame Relay Service Network Serving Area – Area encompassing certain serving area points. Serving area points are those Company serving central offices designated for the EFRS Network Serving Area.
- i. Excess Burst Size ( $B_e$ ) - Denotes the data above CIR at which customer data will be admitted to the EFRS network. All Excess Burst data admitted to the network that exceeds the CIR will be designated discard eligible.
- j. Frame - A sequence of contiguous bits delimited by beginning and ending flag sequences.
- k. Gateway Service – Allows the Company EFRS customers to interconnect to other frame relay networks. The service is available wherever the Company has established a network interface with another private or public frame relay network. Gateway Service is only available where such network connectivity exists or where suitable connectivity arrangements can be made that are acceptable to the Company.

## GENERAL EXCHANGE TARIFF

Embarq Florida, Inc.

By: F. B. Poag  
Director

SECTION A29  
First Revised Sheet 64  
Cancelling Original Sheet 64  
Effective: April 15, 2001

### DIGITAL NETWORK SERVICES

#### E. ENHANCED FRAME RELAY SERVICE (Cont'd)

##### 2. Definitions (Cont'd)

- l. Local Access and Transport Area (LATA) - Denotes a geographic area established for the provision and administration of communications service. It encompasses one or more designated exchanges that are grouped to serve common social, economic, and other purposes.
- m. Local Area Network (LAN) - A network permitting the interconnection and intercommunication of a group of computers, primarily for the sharing of resources such as data storage devices and printers.
- n. Logical Channel - A communications channel that allows two-way, simultaneous transmission of sequenced data packets through the network. No circuit capacity is preassigned to a logical channel. Capacity is made available as the data is transmitted. Each PVC is considered one logical channel or one virtual channel.
- o. Maximum Burst Rate (MBR) - Denotes the maximum information rate at which customer traffic will be admitted to the EFRS network. Traffic rates in excess of MBR will be automatically discarded on ingress to the network. MBR is equal to the sum of the Committed Information Rate (CIR) and Excess Burst Size ( $B_e$ ).
- p. Network to Network Interface (NNI) - Specifies how a frame relay switch sends and receives data from a frame relay interexchange carrier's or other customer's network.
- q. Permanent Virtual Circuit (PVC) - Provides a software-defined electronic path between the two ports within the EFRS network. A UNI or NNI port connection can be associated with multiple PVCs. Since all PVCs need not be in use at the same time, it is possible for the total CIR of all PVCs associated with one port to exceed the bandwidth of the port. It is not possible, however for the simultaneous aggregation of the PVCs throughput to exceed the bandwidth of the port. Such a relationship is referred to as oversubscription or overbooking. When oversubscription occurs, there is no guarantee that the bandwidth defined for that PVC will be available at any point in time. PVCs classified as Frame for Voice receive the highest priority routing with PVCs classified as Frame for SNA next in priority. Frame for LAN PVCs receive standard frame relay switching priority.
- r. Private Network Link (PNL) - The facilities, normally DS1 service used from a customer's frame relay switch location to the Company's Enhanced Frame Relay Service Network.



## GENERAL EXCHANGE TARIFF

Embarq Florida, Inc.

By: F. B. Poag  
Director

SECTION A29  
First Revised Sheet 65  
Cancelling Original Sheet 65  
Effective: April 15, 2001

### DIGITAL NETWORK SERVICES

#### E. ENHANCED FRAME RELAY SERVICE (Cont'd)

##### 2. Definitions (Cont'd)

- s. Protocol - A specific set of rules, procedures or conventions relating to format and timing of data transmission between two devices. It is a standard procedure that two data devices must accept and use in order to understand each other. Protocols break a file into parts called blocks or packets. When packets are sent, the receiving computer checks the arriving packets and sends an acknowledgment back to the sending computer.
- t. Servicing Area Points - Geographical locations designated by the Company where EFRS network ports are located and where the EFRS network is accessed.
- u. Serving Central Office (SCO) - The Company central office from which the customer normally receives dial tone.
- v. Systems Network Architecture (SNA) - IBM's data communications scheme.
- w. Statistical Multiplexing - A multiplexing technique in which timeslots are dynamically allocated on the basis of need rather than being predetermined. The data is typically transmitted on a first come, first served basis.
- x. User to Network Interface (UNI) - A standard interface used to connect the end-user to the Company EFRS network. The UNI receives the data frame from the customer's LAN or other CPE devices and verifies that the DLCI is valid before relaying the frame to the destination point.
- y. Utilization Reports - Reports that the customer can order that display circuit utilization for Enhanced Frame Relay Access Ports (EFRAP) and Permanent Virtual Circuits (PVC).

GENERAL EXCHANGE TARIFF

Embarq Florida, Inc.

By: F. B. Poag  
Director

SECTION A29  
First Revised Sheet 66  
Cancelling Original Sheet 66  
Effective: April 15, 2001

DIGITAL NETWORK SERVICES

E. ENHANCED FRAME RELAY SERVICE (Cont'd)

2. Definitions (Cont'd)

The following diagram illustrates some of the above mentioned terms.

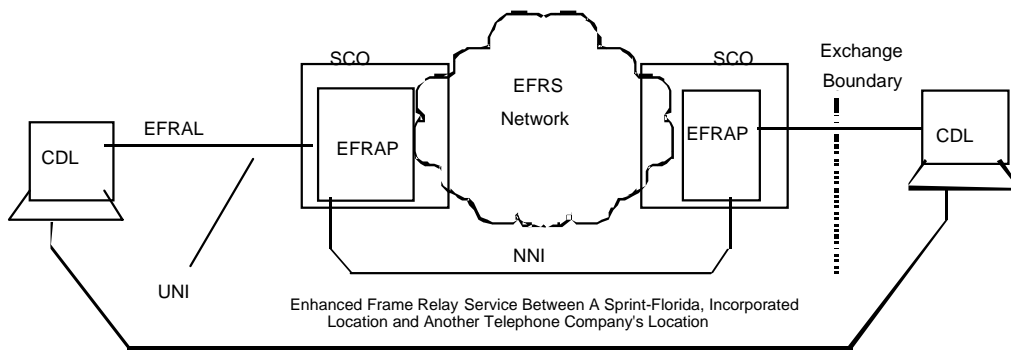

**Sprint-Florida, Incorporated dba Sprint EFRS Diagram**

CDL = Customer Designated Location  
EFRS = Enhanced Frame Relay Service  
EFRAL = Enhanced Frame Relay Access Line  
EFRAP = Enhanced Frame Relay Access Port  
SCO = Serving Central Office  
UNI = User to Network Interface

## GENERAL EXCHANGE TARIFF

Embarq Florida, Inc.

By: F. B. Poag  
Director

SECTION A29  
Second Revised Sheet 67  
Cancelling First Revised Sheet 67  
Effective: August 4, 2004

### DIGITAL NETWORK SERVICES

#### E. ENHANCED FRAME RELAY SERVICE (Cont'd)

##### 3. General Regulations

- a. EFRS is available at Company Servicing Area Point locations. EFRS is offered for local and intraLATA use where Company facilities exist. EFRS is offered for intrastate interLATA use where Company facilities exist. The regulations and rates specified herein are in addition to the applicable regulations and rates specified in other tariffs and other sections of this tariff.
- b. EFRS is provided subject to the availability of facilities.
- c. EFRS is provided to the customer in the form of an EFRAL or a combination of digital, private line transport facilities, (i.e., DigiLink, TransLink or LightLink) and an EFRAP and a PVC at a specified CIR. The EFRAL, or a combination of DigiLink, TransLink and LightLink, and an EFRAP from the customer access components to the EFRS network.
- d. 18 Mbps, 24 Mbps and 44.210 Mbps services are available at tariff rates only in exchanges that have an EFRS switch. 18 Mbps, 24 Mbps and 44.210 Mbps services are available at Individual Case Basis (ICB) rates in exchanges that do not have an EFRS switch. The EFRAP Only offerings are provided for digital special access line connections to the network supporting EFRS. Digital special access facilities are available from the Private Line section of this tariff, the Intrastate Access Service Tariff, or the Interstate Access Tariff.
- e. The minimum service period for EFRS is three months. EFRS may be ordered on a month to month basis or through a Term Discount Plan for fixed periods of 12 to 84 months.
- f. The provision of suspension of service at the customer's request, as defined in Section A2 of this tariff, is not allowed for Enhanced Frame Relay Service.
- g. The customer is responsible for payment of a Trouble Isolation Charge, as defined in Section A2 of this tariff, for visits by the Company to the customer premises when a service difficulty resulting in a trouble report is caused by the use of equipment or facilities provided by the customer.
- h. When the customer orders additional PVCs, nonrecurring charges apply. In addition, nonrecurring charges will apply to all changes made to a customer's EFRS configuration at the customer's request, such as changes to add, delete, or rearrange the customer's configuration, and changes to PVC classes and CIRs. One PVC nonrecurring charge applies for each PVC changed.

## GENERAL EXCHANGE TARIFF

Embarq Florida, Inc.

By: F. B. Poag  
Director

SECTION A29  
First Revised Sheet 68  
Cancelling Original Sheet 68  
Effective: April 15, 2001

### DIGITAL NETWORK SERVICES

#### E. ENHANCED FRAME RELAY SERVICE (Cont'd)

##### 3. General Regulations (Cont'd)

- i. A customer subscribing to an EFRAL or EFRAP and a PVC will be referred to as the Controller of the EFRAL or EFRAP. A customer may request data transmission capability to a different customer's location. Both customers must subscribe to enhanced frame relay service. The customer requesting PVC connectivity to another customer's location as such must have written permission from the Controller of the EFRAL or EFRAP for this data transmission capability.

The EFRAL or EFRAP and PVC may be ordered and billed independently and can have different customers as Controllers. A request by one customer to discontinue a PVC does not result in the disconnection of the EFRAL and/or EFRAP. Only the Controller of an EFRAL or EFRAP may authorize the disconnection of that EFRAL or EFRAP.

- j. Whenever facilities are provided jointly by the Company and one or more other telephone companies, the regulations, rates and charges of such other telephone companies apply for the equipment and facilities furnished by them for use in connection with the interexchange EFRS provided by the Company.
- k. Where it is necessary to use interexchange or local channel facilities of another telephone company in order to furnish a private line service to interconnect to the Company's EFRS, such service will be furnished only if satisfactory arrangements can be made with the other company.
- l. Due to technical limitations, the distance between the SCO and the customer designated location (CDL) is limited to approximately 12,000 feet for 1.544 mbps access or 18,000 feet for 56 kbps access. A Company engineer may allow some deviation of this specification based on the gauge of wire used. For access lines that exceed this specification, the access line may be made operational by adding additional equipment. The Company will apply Charges Applicable Under Special Conditions, as defined in Section A5 of this tariff, for the additional time and material required.
- m. Charges Applicable Under Special Conditions, as defined in Section A5 of this tariff, may apply when technical limitations and/or the lack of facilities exist, or if it is necessary to construct facilities to satisfy service requests.

## GENERAL EXCHANGE TARIFF

Embarq Florida, Inc.

By: F. B. Poag  
Director

SECTION A29  
First Revised Sheet 69  
Cancelling Original Sheet 69  
Effective: April 15, 2001

### DIGITAL NETWORK SERVICES

#### E. ENHANCED FRAME RELAY SERVICE (Cont'd)

##### 4. Obligations of the Company

- a. The responsibility of the Company is limited to furnishing network equipment suitable for EFRS and to the maintenance and operation of such equipment in a manner proper for such service. Subject to this responsibility, the Company is not responsible for the through transmission of signals generated by the customer provided equipment or system, or for the quality of, or defects in, such transmission or the reception of signals by such equipment or systems.
- b. The Company is not responsible for installation, operation or maintenance of any terminal equipment, data unit or communications system provided by a customer or user. The Company is not responsible for adapting EFRS to the technological requirements of any specific customer equipment.
- c. The Company is not responsible to the customer or user if changes in any of the equipment, operations or procedures of the Company used in the provision of EFRS render any facilities provided by the customer or user obsolete or require modification or alteration of such equipment or system or otherwise affect its use or performance, provided the Company has met any applicable information disclosure requirements otherwise required by law.
- d. In order to maintain the quality of EFRS, the Telephone Company reserves the right to perform preventative maintenance and software updates to the network. The Telephone Company has classified this maintenance as follows:

##### (1) Scheduled Maintenance

Scheduled maintenance is used to perform such functions as hardware and software upgrades and network optimization. The Telephone Company will perform these tasks in a maintenance window that is defined as occurring between midnight and 6 a.m., local time, on Monday. The Telephone Company reserves the same time period for any other day(s) of the week to facilitate maintenance which cannot be completed during the Monday maintenance window. The Telephone Company will provide advance notice of all scheduled maintenance.

##### (2) Demand Maintenance

Demand maintenance may occur as a result of unexpected events and is performed when EFRS network elements are in jeopardy. The Telephone Company will perform this type of maintenance at its discretion. Due to the nature of demand maintenance prior notification may not be possible; however, the customer will be informed when the maintenance has been completed.

## GENERAL EXCHANGE TARIFF

Embarq Florida, Inc.

By: F. B. Poag  
Director

SECTION A29  
First Revised Sheet 70  
Cancelling Original Sheet 70  
Effective: April 15, 2001

### DIGITAL NETWORK SERVICES

#### E. ENHANCED FRAME RELAY SERVICE (Cont'd)

##### 5. Obligations of the Customer

- a. The customer's frame relay compatible terminal equipment is responsible for re-transmitting frames that are discarded due to errors or network congestion.
- b. Where EFRS is available for use in connection with communications systems or equipment provided by a customer or user, the operating characteristics of such systems or equipment shall be such as not to interfere with any services offered by the Company. Such use is subject to the further provisions that the equipment provided by the customer or user does not endanger the safety of Company employees or the public; does not damage, harm, require change in or alteration of the equipment or other services of the Company; does not interfere with the proper operation of the Company's equipment or does not otherwise injure the public in its use of Company services. Upon notice from the Company that the equipment provided by the customer or user is causing, or is likely to cause, such hazard or interference, the customer shall take the necessary steps to remove or prevent such hazard or interference.
- c. The customer, upon request, shall furnish such CPE information as may be required to permit the Company to design and maintain the EFRS it offers and to assure that the service arrangement is in compliance with the regulations contained herein.
- d. Upon service subscription, the customer must specify the CIR class and  $B_e$  of each PVC ordered. CIR is the maximum information rate at which the customer's traffic will be admitted to the EFRS network without being designated eligible for discard. A default of fifty (50) percent of the smallest port size will be assigned as the CIR should the information not be provided. No individual PVC CIR shall exceed (95) percent of the EFRAP access rate. The sum of all CIR on a single EFRAP must not exceed two hundred (200) percent of the EFRAP access rate.

##### 6. Term Discount Plan (TDP)

- a. Term Discount Plans (TDPs) are available for EFRALs, EFRAPs and EPNLs. TDPs provide the customer with discounted rates for the services listed. The customer agrees to a minimum service commitment period for EFRS when the TDP is established. Customers may disconnect or move PVCs and not be subject to termination liability charges. The customer must order a TDP in writing to the Company. A TDP may be ordered in one month increments, based on the following plan options:

Plan A:	12 - 23 months
Plan B:	24 - 35 months
Plan C:	36 - 59 months
Plan D:	60 - 84 months

## GENERAL EXCHANGE TARIFF

Embarq Florida, Inc.

By: F. B. Poag  
Director

SECTION A29  
Third Revised Sheet 71  
Cancelling Second Revised Sheet 71  
Effective: May 1, 2003

### DIGITAL NETWORK SERVICES

#### E. ENHANCED FRAME RELAY SERVICE (Cont'd)

##### 6. Term Discount Plan (TDP) (Cont'd)

- b. The customer must specify the length of the initial service period at the time the service is ordered. When a customer converts to a TDP, no administrative charges are applied toward facilities in-service at that time. If a customer moves from a month to month plan to a TDP, or upgrades from one TDP to another, no administrative charges are applied.
- c. If a TDP customer under a Term Discount Plan (TDP) disconnects any portion of the Enhanced Frame Relay Service TDP service prior to the expiration of the TDP, then a Termination Liability Charge will apply to those elements that are disconnected. The Termination Liability Charge will be a one-time charge equal to the sum of 50% of the payments for the rest of the TDP. If Charges Applicable Under Special Conditions were applied to the service being terminated, any termination charges associated with the Charges Applicable Under Special Conditions will also apply.
- d. Rate increases or decreases as approved by the Florida Public Service Commission will automatically be applied to the monthly term plan rates for the remaining term of the TDP. If Company initiated rate increases to any rate element or combination of rate elements causes the charges for the entire EFRS under the TDP to increase by 10% or more annually, then the customer may cancel the TDP without incurring termination liability charges provided that the customer notifies the Company within 30 days after the effective date of the rate increase.
- e. TDP commitment periods can be extended by the customer at any time during the term of the plan, up to a maximum of 84 months. The number of months accrued in the current plan will apply toward the new plan selected.
- f. At the end of the TDP service commitment period, the customer may subscribe to a new TDP at the prevailing rates set forth in Section 8. a.-g. following. If the customer does not select a new TDP, the rates will convert to the prevailing month to month rates.

## GENERAL EXCHANGE TARIFF

Embarq Florida, Inc.

By: F. B. Poag  
Director

SECTION A29  
Second Revised Sheet 72  
Cancelling First Revised Sheet 72  
Effective: May 1, 2003

### DIGITAL NETWORK SERVICES

#### E. ENHANCED FRAME RELAY SERVICE (Cont'd)

##### 6. Term Discount Plan (TDP) (Cont'd)

- g. Termination Liability Charges will not apply when a service or rate element under a Term Discount Plan (TDP) arrangement is disconnected prior to the expiration of a selected service period as a result of a change in tariff jurisdiction and/or a customer requested upgrade to a next generation service offering under the following conditions:

The service period of the new TDP arrangement for the new service offering is a period equal to or exceeding the remaining service period of the disconnected TDP, whichever is greater, and

The service orders to install the new service and disconnect the old service are related together, and there is no lapse in service between the installation of the new service the disconnection of the existing service, and

The service orders to install the new service and disconnect the old service are for the same customer at the same location.

The Telephone Company will determine whether replacement service qualifies as a next generation service offering.

Nonrecurring charges and Service Charges for the new service will apply according to the requirements of the new service.

##### 7. Service Components

- a. Administrative Charge – Applies to changes in a customer's network configuration such as additions or changes of PVCs. Although multiple changes can be caused by such actions, only one administrative charge applies.

This administrative charge applies in addition to the applicable charges associated with Service Charges, as specified in Section A4 of this tariff.



GENERAL EXCHANGE TARIFF

Embarq Florida, Inc.

By: F. B. Poag  
Director

SECTION A29  
First Revised Sheet 73  
Cancelling Original Sheet 73  
Effective: April 15, 2001

DIGITAL NETWORK SERVICES

E. ENHANCED FRAME RELAY SERVICE (Cont'd)

7. Service Components (Cont'd)

- b. CIR and PVC - A monthly rate applies for each PVC based on the CIR requested by the customer. If no CIR is indicated, the CIR will be set at the default of 50% of the associated EFRAP. A nonrecurring charge applies for the establishment of each PVC and for each subsequent order of PVC(s). Rates for intraLATA PVCs are specified in Section 29.2.8 C. Rates for interLATA PVCs are specified in the Intrastate/InterLATA Private Line Service Tariff.

Customers may select from three different classes of PVCs to ensure greater reliability for mission-critical applications in the event of network congestion:

Service Class	Type	PVC Priority
Frame for LAN	Standard	Normal
Frame for SNA	Premium	Higher
Frame for Voice	Premium	Highest

This flexibility helps to ensure maximum performance and satisfaction for individual customer data applications.

- c. Enhanced Frame Relay Access Line (EFRAL) - A nonrecurring charge and monthly rate applies based on the speed of the port connection for each physical connection. The EFRAL includes the provision of a port.
- d. Enhanced Frame Relay Access Port (EFRAP) - A nonrecurring charge and monthly rate based on the speed of the port connection applies per port connection to the network supporting EFRS. The port rate element can be used in lieu of the EFRAL element if the customer has an alternative Company-approved means of access to the EFRS network.
- e. Enhanced Frame to Asynchronous Transfer Mode (ATM) Inter-Networking Links - The Company may establish facilities between EFRS switching equipment and ATM Service switching equipment and may allow customers to share bandwidth on these facilities. Where these shared facilities are available to customers; the Enhanced Frame to ATM Inter-Networking Link option exists. In addition to the EFRS Customer Connection, the customer may subscribe to an Enhanced Frame to ATM Inter-Networking Link. Links that extend between EFRS and ATM switches must have an associated CIR. At least one PVC is required between both customer premises through the Enhanced Frame to ATM Inter-Networking Link. All CIRs on this PVC must have the same value. Enhanced Frame to ATM Inter-Networking Links are only available where such facilities exist.

## GENERAL EXCHANGE TARIFF

Embarq Florida, Inc.

By: F. B. Poag  
Director

SECTION A29  
Second Revised Sheet 74  
Cancelling First Revised Sheet 74  
Effective: May 1, 2003

### DIGITAL NETWORK SERVICES

#### E. ENHANCED FRAME RELAY SERVICE (Cont'd)

##### 7. Service Components (Cont'd)

- f. Gateway Service - This service allows the Company EFRS customers to interconnect to another enhanced frame relay network. The service is available wherever the Company has established a network interface with another private or public enhanced frame relay network. The charge for this service covers the EFRAP and interconnecting facilities from the Company to the interconnection point with the other provider. The charge includes the software defined PVC to the other company's network to the UNI port, but does not include the UNI port provided by the other company. The Gateway charge is purchased in increments of CIR. The following diagram shows a typical customer network with three data devices interconnected to the Company EFRS (sites D, E & F). The customer needs to interconnect the data devices to a fourth site (C) served by another company. The customer accomplishes this by ordering three PVCs and three Gateway service connections to the other company's frame relay network. This example assumes that enhanced frame relay access from site C is already established as illustrated.

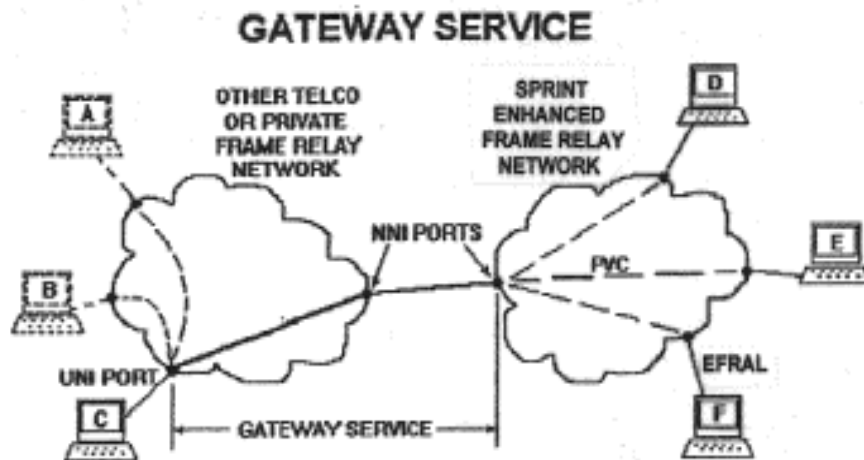

- g. Private Network Link (PNL) - A charge for a DS1 facility from a customer's frame relay switch location to the Company's EFRS Network. In addition to the access facility, a 1.544 EFRAP must be purchased.
- h. Utilization Reports - Reports that the customer can order that display certain circuit utilization statistics for Permanent Virtual Circuits (PVC) and Enhanced Frame Relay Access Ports (EFRAP). The PVC report summarizes inbound and outbound packet discards and displays utilization as a percentage of CIR. The EFRAP report summarizes inbound and outbound packet discards and displays utilization as a percent of port speed. Reports are ordered on a per port basis. Service is not available to NNI locations. A monthly play and Term Discount Plans are available for fixed periods of 12 to 84 months. Reports are available only where Company facilities permit.

GENERAL EXCHANGE TARIFF

Embarq Florida, Inc.

By: F. B. Poag  
Director

SECTION A29  
Fourth Revised Sheet 75  
Cancelling Third Revised Sheet 75  
Effective: May 5, 2004

DIGITAL NETWORK SERVICES

E. ENHANCED FRAME RELAY SERVICE (Cont'd)

8. Rates and Charges

a. Enhanced Frame Relay Access Line (EFRAL) (includes Access Line and Port)

	<u>S&amp;E Code</u>	<u>Monthly Rate</u>	<u>Nonrecurring Charge</u>
<b>56 Kbps</b>			
Month to month	FCEALTA	\$115.00	\$395.00
12-23 months	FCEALTA(F1Y)	\$112.00	\$295.00
24-35 months	FCEALTA(F2Y)	\$110.00	\$195.00
36-59 months	FCEALTA(F3Y)	\$105.00	-0-
60-84 months	FCEALTA(F5Y)	\$ 95.00	-0-
<b>64 Kbps*</b>			
Month to month	FCEALTC	\$117.20	\$445.00
12-23 months	FCEALTC(F1Y)	\$115.00	\$345.00
24-35 months	FCEALTC(F2Y)	\$112.50	\$245.00
36-59 months	FCEALTC(F3Y)	\$110.00	-0-
60-84 months	FCEALTC(F5Y)	\$100.00	-0-
<b>128 Kbps</b>			
Month to month	FCEALTD	\$230.00	\$495.00
12-23 months	FCEALTD(F1Y)	\$221.00	\$395.00
24-35 months	FCEALTD(F2Y)	\$218.50	\$295.00
36-59 months	FCEALTD(F3Y)	\$215.00	-0-
60-84 months	FCEALTD(F5Y)	\$205.00	-0-
<b>256 Kbps</b>			
Month to month	FCEALTE	\$330.00	\$525.00
12-23 months	FCEALTE(F1Y)	\$320.00	\$425.00
24-35 months	FCEALTE(F2Y)	\$315.00	\$325.00
36-59 months	FCEALTE(F3Y)	\$310.00	-0-
60-84 months	FCEALTE(F5Y)	\$300.00	-0-
<b>384 Kbps</b>			
Month to month	FCEALTF	\$395.00	\$550.00
12-23 months	FCEALTF(F1Y)	\$385.00	\$450.00
24-35 months	FCEALTF(F2Y)	\$380.00	\$350.00
36-59 months	FCEALTF(F3Y)	\$375.00	-0-
60-84 months	FCEALTF(F5Y)	\$360.00	-0-

\* 64 Kbps Clear Channel Capability is provided upon request where facilities are available

GENERAL EXCHANGE TARIFF

Embarq Florida, Inc.

By: F. B. Poag  
Director

SECTION A29  
Seventh Revised Sheet 76  
Cancelling Sixth Revised Sheet 76  
Effective: November 17, 2004

DIGITAL NETWORK SERVICES

E. ENHANCED FRAME RELAY SERVICE (Cont'd)

8. Rates and Charges (Cont'd)

a. Enhanced Frame Relay Access Line (EFRAL) (includes Access Line and Port) (Cont'd)

	<u>S&amp;E Code</u>	<u>Monthly Rate</u>	<u>Nonrecurring Charge</u>
512 Kbps			
Month to month	FCEALTG	\$445.00	\$575.00
12-23 months	FCEALTG(F1Y)	\$430.00	\$475.00
24-35 months	FCEALTG(F2Y)	\$425.00	\$375.00
36-59 months	FCEALTG(F3Y)	\$420.00	-0-
60-84 months	FCEALTG(F5Y)	\$405.00	-0-
1.544 Mbps			
Month to month	FCEALTB	\$517.75	\$795.00
12-23 months	FCEALTB(F1Y)	\$490.00	\$595.00
24-35 months	FCEALTB(F2Y)	\$480.00	\$395.00
36-59 months	FCEALTB(F3Y)	\$470.00	-0-
60-84 months	FCEALTB(F5Y)	\$445.00	-0-
*3 Mbps (2xDS1)			
Month to month	FCEALTM	\$750.00	\$795.00
12-23 months	FCEALTM(F1Y)	\$675.00	\$595.00
24-35 months	FCEALTM(F2Y)	\$640.00	\$395.00
36-59 months	FCEALTM(F3Y)	\$600.00	-0-
60-84 months	FCEALTM(F5Y)	\$560.00	-0-
*6 Mbps (4xDS1)			
Month to month	FCEALTN	\$1,275.00	\$795.00
12-23 months	FCEALTN(F1Y)	\$1,210.00	\$595.00
24-35 months	FCEALTN(F2Y)	\$1,145.00	\$395.00
36-59 months	FCEALTN(F3Y)	\$1,115.00	-0-
60-84 months	FCEALTN(F5Y)	\$995.00	-0-
*9 Mbps (6xDS1)			
Month to month	FCEALTP	\$1,780.00	\$795.00
12-23 months	FCEALTP(F1Y)	\$1,695.00	\$595.00
24-35 months	FCEALTP(F2Y)	\$1,605.00	\$395.00
36-59 months	FCEALTP(F3Y)	\$1,560.00	-0-
60-84 months	FCEALTP(F5Y)	\$1,515.00	-0-
*10.5 Mbps (7xDS1)			
Month to month	FCEALTY	\$1,960.00	\$795.00
12-23 months	FCEALTY(F1Y)	\$1,860.00	\$595.00
24-35 months	FCEALTY(F2Y)	\$1,760.00	\$395.00
36-59 months	FCEALTY(F3Y)	\$1,710.00	-0-
60-84 months	FCEALTY(F5Y)	\$1,660.00	-0-
*12 Mbps (8xDS1)			
Month to month	FCEALTZ	\$2,035.00	\$795.00
12-23 months	FCEALTZ(F1Y)	\$1,931.00	\$595.00
24-35 months	FCEALTZ(F2Y)	\$1,830.00	\$395.00
36-59 months	FCEALTZ(F3Y)	\$1,775.00	-0-
60-84 months	FCEALTZ(F5Y)	\$1,725.00	-0-

\* Where facilities are available. CPE must be compliant with Frame Relay Forum.16 (FRF.16), Multilink Frame Relay Protocol Industry Standard.

GENERAL EXCHANGE TARIFF

Embarq Florida, Inc.

By: F. B. Poag  
Director

SECTION A29  
First Revised Sheet 76.1  
Cancelling Original Sheet 76.1  
Effective: August 4, 2004

DIGITAL NETWORK SERVICES

E. ENHANCED FRAME RELAY SERVICE (Cont'd)

8. Rates and Charges (Cont'd)

a. Enhanced Frame Relay Access Line (EFRAL) (includes Access Line and Port) (Cont'd)

	<u>S&amp;E Code</u>	<u>Monthly Rate</u>	<u>Nonrecurring Charge</u>
*18 Mbps (Subrate DS3) Customer Provided Equipment			
Month to month			
0-3 miles	FCEALTQ	\$2,225.00	\$995.00
Over 3 miles	FCEALTR	\$2,450.00	\$995.00
12-23 months			
0-3 miles	FCEALTQ(F1Y)	\$2,115.00	\$795.00
Over 3 miles	FCEALTR(F1Y)	\$2,325.00	\$795.00
24-35 months			
0-3 miles	FCEALTQ(F2Y)	\$1,995.00	\$595.00
Over 3 miles	FCEALTR(F2Y)	\$2,205.00	\$595.00
36-59 months			
0-3 miles	FCEALTQ(F3Y)	\$1,945.00	-0-
Over 3 miles	FCEALTR(F3Y)	\$2,145.00	-0-
60-84 months			
0-3 miles	FCEALTQ(F5Y)	\$1,895.00	-0-
Over 3 miles	FCEALTR(F5Y)	\$2,075.00	-0-
*18 Mbps (Subrate DS3) Company Provided Equipment			
Month to month			
0-3 miles	FCEALTS	\$2,550.00	\$995.00
Over 3 miles	FCEALTT	\$2,805.00	\$995.00
12-23 months			
0-3 miles	FCEALTS(F1Y)	\$2,425.00	\$795.00
Over 3 miles	FCEALTT(F1Y)	\$2,665.00	\$795.00
24-35 months			
0-3 miles	FCEALTS(F2Y)	\$2,295.00	\$595.00
Over 3 miles	FCEALTT(F2Y)	\$2,525.00	\$595.00
36-59 months			
0-3 miles	FCEALTS(F3Y)	\$2,230.00	-0-
Over 3 miles	FCEALTT(F3Y)	\$2,455.00	-0-
60-84 months			
0-3 miles	FCEALTS(F5Y)	\$2,165.00	-0-
Over 3 miles	FCEALTT(F5Y)	\$2,385.00	-0-

\* Where facilities are available.

GENERAL EXCHANGE TARIFF

Embarq Florida, Inc.

By: F. B. Poag  
Director

SECTION A29  
First Revised Sheet 76.2  
Cancelling Original Sheet 76.2  
Effective: August 4, 2004

DIGITAL NETWORK SERVICES

E. ENHANCED FRAME RELAY SERVICE (Cont'd)

8. Rates and Charges (Cont'd)

a. Enhanced Frame Relay Access Line (EFRAL) (includes Access Line and Port) (Cont'd)

	<u>S&amp;E Code</u>	<u>Monthly Rate</u>	<u>Nonrecurring Charge</u>
*24 Mbps (Subrate DS3) Customer Provided Equipment			
Month to month			
0-3 miles	FCEALTU	\$2,450.00	\$995.00
Over 3 miles	FCEALTV	\$2,695.00	\$995.00
12-23 months			
0-3 miles	FCEALTU(F1Y)	\$2,325.00	\$795.00
Over 3 miles	FCEALTV(F1Y)	\$2,560.00	\$795.00
24-35 months			
0-3 miles	FCEALTU(F2Y)	\$2,205.00	\$595.00
Over 3 miles	FCEALTV(F2Y)	\$2,425.00	\$595.00
36-59 months			
0-3 miles	FCEALTU(F3Y)	\$2,145.00	-0-
Over 3 miles	FCEALTV(F3Y)	\$2,360.00	-0-
60-84 months			
0-3 miles	FCEALTU(F5Y)	\$2,080.00	-0-
Over 3 miles	FCEALTV(F5Y)	\$2,290.00	-0-
*24 Mbps (Subrate DS3) Company Provided Equipment			
Month to month			
0-3 miles	FCEALTW	\$2,805.00	\$995.00
Over 3 miles	FCEALTX	\$3,085.00	\$995.00
12-23 months			
0-3 miles	FCEALTW(F1Y)	\$2,665.00	\$795.00
Over 3 miles	FCEALTX(F1Y)	\$2,930.00	\$795.00
24-35 months			
0-3 miles	FCEALTW(F2Y)	\$2,525.00	\$595.00
Over 3 miles	FCEALTX(F2Y)	\$2,775.00	\$595.00
36-59 months			
0-3 miles	FCEALTW(F3Y)	\$2,455.00	-0-
Over 3 miles	FCEALTX(F3Y)	\$2,700.00	-0-
60-84 months			
0-3 miles	FCEALTW(F5Y)	\$2,385.00	-0-
Over 3 miles	FCEALTX(F5Y)	\$2,625.00	-0-

\* Where facilities are available

GENERAL EXCHANGE TARIFF

Embarq Florida, Inc.

By: F. B. Poag  
Director

SECTION A29  
First Revised Sheet 76.3  
Cancelling Original Sheet 76.3  
Effective: August 4, 2004

DIGITAL NETWORK SERVICES

E. ENHANCED FRAME RELAY SERVICE (Cont'd)

8. Rates and Charges (Cont'd)

a. Enhanced Frame Relay Access Line (EFRAL) (includes Access Line and Port) (Cont'd)

	<u>S&amp;E Code</u>	<u>Monthly Rate</u>	<u>Nonrecurring Charge</u>
*44.210 Mbps Customer Provided Equipment			
Month to month			
0-3 miles	FCEALTH	\$3,125.00	\$995.00
Over 3 miles	FCEALTJ	\$3,675.00	\$995.00
12-23 months			
0-3 miles	FCEALTH(F1Y)	\$2,925.00	\$795.00
Over 3 miles	FCEALTJ(F1Y)	\$3,475.00	\$795.00
24-35 months			
0-3 miles	FCEALTH(F2Y)	\$2,725.00	\$595.00
Over 3 miles	FCEALTJ(F2Y)	\$3,275.00	\$595.00
36-59 months			
0-3 miles	FCEALTH(F3Y)	\$2,525.00	-0-
Over 3 miles	FCEALTJ(F3Y)	\$3,075.00	-0-
60-84 months			
0-3 miles	FCEALTH(F5Y)	\$2,375.00	-0-
Over 3 miles	FCEALTJ(F5Y)	\$2,925.00	-0-
*44.210 Mbps Company Provided Equipment			
Month to month			
0-3 miles	FCEALTK	\$4,425.00	\$995.00
Over 3 miles	FCEALTL	\$5,025.00	\$995.00
12-23 months			
0-3 miles	FCEALTK(F1Y)	\$3,975.00	\$795.00
Over 3 miles	FCEALTL(F1Y)	\$4,575.00	\$795.00
24-35 months			
0-3 miles	FCEALTK(F2Y)	\$3,575.00	\$595.00
Over 3 miles	FCEALTL(F2Y)	\$4,225.00	\$595.00
36-59 months			
0-3 miles	FCEALTK(F3Y)	\$3,175.00	-0-
Over 3 miles	FCEALTL(F3Y)	\$3,825.00	-0-
60-84 months			
0-3 miles	FCEALTK(F5Y)	\$2,775.00	-0-
Over 3 miles	FCEALTL(F5Y)	\$3,425.00	-0-

\*Where facilities are available

GENERAL EXCHANGE TARIFF

Embarq Florida, Inc.

By: F. B. Poag  
Director

SECTION A29  
First Revised Sheet 77  
Cancelling Original Sheet 77  
Effective: April 15, 2001

DIGITAL NETWORK SERVICES

E. ENHANCED FRAME RELAY SERVICE (Cont'd)

8. Rates and Charges (Cont'd)

b. Enhanced Frame Relay Port (EFRAP) Only

	<u>S&amp;E Code</u>	<u>Monthly Rate</u>	<u>Nonrecurring Charge</u>
<b>56 Kbps</b>			
Month to month	FCEALA0	\$55.00	\$155.00
12-23 months	FCEALA0(F1Y)	\$54.00	\$135.00
24-35 months	FCEALA0(F2Y)	\$53.00	\$115.00
36-59 months	FCEALA0(F3Y)	\$51.00	\$ 95.00
60-84 months	FCEALA0(F5Y)	\$45.00	\$ 75.00
<b>64 Kbps*</b>			
Month to month	FCEALC0	\$55.00	\$175.00
12-23 months	FCEALC0(F1Y)	\$54.00	\$155.00
24-35 months	FCEALC0(F2Y)	\$53.00	\$135.00
36-59 months	FCEALC0(F3Y)	\$51.00	\$115.00
60-84 months	FCEALC0(F5Y)	\$45.00	\$ 95.00
<b>128 Kbps</b>			
Month to month	FCEALD0	\$100.00	\$225.00
12-23 months	FCEALD0(F1Y)	\$ 98.00	\$200.00
24-35 months	FCEALD0(F2Y)	\$ 96.00	\$175.00
36-59 months	FCEALD0(F3Y)	\$ 94.00	\$150.00
60-84 months	FCEALD0(F5Y)	\$ 88.00	\$125.00
<b>256 Kbps</b>			
Month to month	FCEALE0	\$180.00	\$250.00
12-23 months	FCEALE0(F1Y)	\$178.00	\$225.00
24-35 months	FCEALE0(F2Y)	\$175.00	\$200.00
36-59 months	FCEALE0(F3Y)	\$173.00	\$175.00
60-84 months	FCEALE0(F5Y)	\$165.00	\$150.00
<b>384 Kbps</b>			
Month to month	FCEALF0	\$235.00	\$275.00
12-23 months	FCEALF0(F1Y)	\$232.00	\$250.00
24-35 months	FCEALF0(F2Y)	\$229.00	\$225.00
36-59 months	FCEALF0(F3Y)	\$227.00	\$200.00
60-84 months	FCEALF0(F5Y)	\$215.00	\$175.00
<b>512 Kbps</b>			
Month to month	FCEALG0	\$360.00	\$300.00
12-23 months	FCEALG0(F1Y)	\$345.00	\$275.00
24-35 months	FCEALG0(F2Y)	\$325.00	\$250.00
36-59 months	FCEALG0(F3Y)	\$300.00	\$225.00
60-84 months	FCEALG0(F5Y)	\$290.00	\$200.00

\*64 Kbps Clear Channel Capability is provided upon request where facilities are available



GENERAL EXCHANGE TARIFF

Embarq Florida, Inc.

SECTION A29

By: F. B. Poag  
Director

Third Revised Sheet 78  
Cancelling Second Revised Sheet 78  
Effective: November 17, 2004

DIGITAL NETWORK SERVICES

E. ENHANCED FRAME RELAY SERVICE (Cont'd)

8. Rates and Charges (Cont'd)

b. Enhanced Frame Relay Port (EFRAP) Only (Cont'd)

	<u>S&amp;E Code</u>	<u>Monthly Rate</u>	<u>Nonrecurring Charge</u>
1.544 Mbps			
Month to month	FCEALB0	\$400.00	\$325.00
12-23 months	FCEALB0(F1Y)	\$395.00	\$300.00
24-35 months	FCEALB0(F2Y)	\$390.00	\$275.00
36-59 months	FCEALB0(F3Y)	\$385.00	\$250.00
60-84 months	FCEALB0(F5Y)	\$370.00	\$225.00
3 Mbps (2xDS1)			
Month to month	FCEALJ0	\$525.00	\$325.00
12-23 months	FCEALJ0(F1Y)	\$495.00	\$300.00
24-35 months	FCEALJ0(F2Y)	\$475.00	\$275.00
36-59 months	FCEALJ0(F3Y)	\$455.00	\$250.00
60-84 months	FCEALJ0(F5Y)	\$410.00	\$225.00
6 Mbps (4xDS1)			
Month to month	FCEALK0	\$890.00	\$325.00
12-23 months	FCEALK0(F1Y)	\$850.00	\$300.00
24-35 months	FCEALK0(F2Y)	\$815.00	\$275.00
36-59 months	FCEALK0(F3Y)	\$775.00	\$250.00
60-84 months	FCEALK0(F5Y)	\$730.00	\$225.00
9 Mbps (6xDS1)			
Month to month	FCEALM0	\$1,250.00	\$325.00
12-23 months	FCEALM0(F1Y)	\$1,185.00	\$300.00
24-35 months	FCEALM0(F2Y)	\$1,135.00	\$275.00
36-59 months	FCEALM0(F3Y)	\$1,085.00	\$250.00
60-84 months	FCEALM0(F5Y)	\$1,020.00	\$225.00
10.5 Mbps (7xDS1)			
Month to month	FCEALQ0	\$1,570.00	\$325.00
12-23 months	FCEALQ0(F1Y)	\$1,490.00	\$300.00
24-35 months	FCEALQ0(F2Y)	\$1,425.00	\$275.00
36-59 months	FCEALQ0(F3Y)	\$1,365.00	\$250.00
60-84 months	FCEALQ0(F5Y)	\$1,285.00	\$225.00
12 Mbps (8xDS1)			
Month to month	FCEALR0	\$1,960.00	\$325.00
12-23 months	FCEALR0(F1Y)	\$1,860.00	\$300.00
24-35 months	FCEALR0(F2Y)	\$1,780.00	\$275.00
36-59 months	FCEALR0(F3Y)	\$1,705.00	\$250.00
60-84 months	FCEALR0(F5Y)	\$1,605.00	\$225.00
18 Mbps (Subrate DS3)			
Month to month	FCEALN0	\$2,040.00	\$325.00
12-23 months	FCEALN0(F1Y)	\$1,940.00	\$300.00
24-35 months	FCEALN0(F2Y)	\$1,860.00	\$275.00
36-59 months	FCEALN0(F3Y)	\$1,775.00	\$250.00
60-84 months	FCEALN0(F5Y)	\$1,675.00	\$225.00

GENERAL EXCHANGE TARIFF

Embarq Florida, Inc.

By: F. B. Poag  
Director

SECTION A29  
First Revised Sheet 78.1  
Cancelling Original Sheet 78.1  
Effective: August 4, 2004

DIGITAL NETWORK SERVICES

E. ENHANCED FRAME RELAY SERVICE (Cont'd)

8. Rates and Charges (Cont'd)

b. Enhanced Frame Relay Port (EFRAP) Only (Cont'd)

	<u>S&amp;E Code</u>	<u>Monthly Rate</u>	<u>Nonrecurring Charge</u>
24 Mbps (Subrate DS3)			
Month to month	FCEALP0	\$2,245.00	\$325.00
12-23 months	FCEALP0(F1Y)	\$2,130.00	\$300.00
24-35 months	FCEALP0(F2Y)	\$2,040.00	\$275.00
36-59 months	FCEALP0(F3Y)	\$1,950.00	\$250.00
60-84 months	FCEALP0(F5Y)	\$1,840.00	\$225.00
44.210 Mbps			
Month to month	FCEALH0	\$2,575.00	\$695.00
12-23 months	FCEALH0(F1Y)	\$2,435.00	\$595.00
24-35 months	FCEALH0(F2Y)	\$2,295.00	\$495.00
36-59 months	FCEALH0(F3Y)	\$2,155.00	\$395.00
60-84 months	FCEALH0(F5Y)	\$2,045.00	\$295.00

c. Permanent Virtual Circuit (PVC) - IntraLATA

Cir, Per PVC

Over 0 thru 8 Kbps			
Frame for LAN	FCEALVL(AP3)	\$2.00	\$10.00
Frame for SNA	FCEALVL(AP2)	\$3.00	\$10.00
Frame for Voice	FCEALVL(AP1)	\$4.00	\$10.00
Over 8 thru 16 Kbps			
Frame for LAN	FCEALVL(BP3)	\$3.00	\$10.00
Frame for SNA	FCEALVL(BP2)	\$4.00	\$10.00
Frame for Voice	FCEALVL(BP1)	\$5.00	\$10.00
Over 16 thru 24 Kbps			
Frame for LAN	FCEALVL(TP3)	\$4.00	\$10.00
Frame for SNA	FCEALVL(TP2)	\$5.00	\$10.00
Frame for Voice	FCEALVL(TP1)	\$6.00	\$10.00
Over 24 thru 32 Kbps			
Frame for LAN	FCEALVL(DP3)	\$5.00	\$10.00
Frame for SNA	FCEALVL(DP2)	\$6.00	\$10.00
Frame for Voice	FCEALVL(DP1)	\$7.00	\$10.00
Over 32 thru 40 Kbps			
Frame for LAN	FCEALVL(EP3)	\$7.00	\$10.00
Frame for SNA	FCEALVL(EP2)	\$8.00	\$10.00
Frame for Voice	FCEALVL(EP1)	\$9.00	\$10.00
Over 40 thru 48 Kbps			
Frame for LAN	FCEALVL(FP3)	\$8.00	\$10.00
Frame for SNA	FCEALVL(FP2)	\$9.00	\$10.00
Frame for Voice	FCEALVL(FP1)	\$10.00	\$10.00

GENERAL EXCHANGE TARIFF

Embarq Florida, Inc.

By: F. B. Poag  
Director

SECTION A29  
First Revised Sheet 78.1  
Cancelling Original Sheet 78.1  
Effective: August 4, 2004

DIGITAL NETWORK SERVICES

E. ENHANCED FRAME RELAY SERVICE (Cont'd)

8. Rates and Charges (Cont'd)

b. Enhanced Frame Relay Port (EFRAP) Only (Cont'd)

	<u>S&amp;E Code</u>	<u>Monthly Rate</u>	<u>Nonrecurring Charge</u>
24 Mbps (Subrate DS3)			
Month to month	FCEALP0	\$2,245.00	\$325.00
12-23 months	FCEALP0(F1Y)	\$2,130.00	\$300.00
24-35 months	FCEALP0(F2Y)	\$2,040.00	\$275.00
36-59 months	FCEALP0(F3Y)	\$1,950.00	\$250.00
60-84 months	FCEALP0(F5Y)	\$1,840.00	\$225.00
44.210 Mbps			
Month to month	FCEALH0	\$2,575.00	\$695.00
12-23 months	FCEALH0(F1Y)	\$2,435.00	\$595.00
24-35 months	FCEALH0(F2Y)	\$2,295.00	\$495.00
36-59 months	FCEALH0(F3Y)	\$2,155.00	\$395.00
60-84 months	FCEALH0(F5Y)	\$2,045.00	\$295.00

c. Permanent Virtual Circuit (PVC) - IntraLATA

Cir, Per PVC

Over 0 thru 8 Kbps			
Frame for LAN	FCEALVL(AP3)	\$2.00	\$10.00
Frame for SNA	FCEALVL(AP2)	\$3.00	\$10.00
Frame for Voice	FCEALVL(AP1)	\$4.00	\$10.00
Over 8 thru 16 Kbps			
Frame for LAN	FCEALVL(BP3)	\$3.00	\$10.00
Frame for SNA	FCEALVL(BP2)	\$4.00	\$10.00
Frame for Voice	FCEALVL(BP1)	\$5.00	\$10.00
Over 16 thru 24 Kbps			
Frame for LAN	FCEALVL(TP3)	\$4.00	\$10.00
Frame for SNA	FCEALVL(TP2)	\$5.00	\$10.00
Frame for Voice	FCEALVL(TP1)	\$6.00	\$10.00
Over 24 thru 32 Kbps			
Frame for LAN	FCEALVL(DP3)	\$5.00	\$10.00
Frame for SNA	FCEALVL(DP2)	\$6.00	\$10.00
Frame for Voice	FCEALVL(DP1)	\$7.00	\$10.00
Over 32 thru 40 Kbps			
Frame for LAN	FCEALVL(EP3)	\$7.00	\$10.00
Frame for SNA	FCEALVL(EP2)	\$8.00	\$10.00
Frame for Voice	FCEALVL(EP1)	\$9.00	\$10.00
Over 40 thru 48 Kbps			
Frame for LAN	FCEALVL(FP3)	\$8.00	\$10.00
Frame for SNA	FCEALVL(FP2)	\$9.00	\$10.00
Frame for Voice	FCEALVL(FP1)	\$10.00	\$10.00

GENERAL EXCHANGE TARIFF

Embarq Florida, Inc.

By: F. B. Poag  
Director

SECTION A29  
First Revised Sheet 79  
Cancelling Original Sheet 79  
Effective: April 15, 2001

DIGITAL NETWORK SERVICES

E. ENHANCED FRAME RELAY SERVICE (Cont'd)

8. Rates and Charges (Cont'd)

c. Permanent Virtual Circuit (PVC) - IntraLATA (Cont'd)

<u>Cir, Per PVC</u>	<u>S&amp;E Code</u>	<u>Monthly Rate</u>	<u>Nonrecurring Charge</u>
Over 48 thru 56 Kbps			
Frame for LAN	FCEALVL(GP3)	\$ 9.00	\$10.00
Frame for SNA	FCEALVL(GP2)	\$10.00	\$10.00
Frame for Voice	FCEALVL(GP1)	\$11.00	\$10.00
Over 56 thru 64 Kbps			
Frame for LAN	FCEALVL(HP3)	\$10.00	\$10.00
Frame for SNA	FCEALVL(HP2)	\$11.00	\$10.00
Frame for Voice	FCEALVL(HP1)	\$12.00	\$10.00
Over 64 thru 128 Kbps			
Frame for LAN	FCEALVL(IP3)	\$19.00	\$10.00
Frame for SNA	FCEALVL(IP2)	\$22.00	\$10.00
Frame for Voice	FCEALVL(IP1)	\$25.00	\$10.00
Over 128 thru 256 Kbps			
Frame for LAN	FCEALVL(JP3)	\$25.00	\$10.00
Frame for SNA	FCEALVL(JP2)	\$29.00	\$10.00
Frame for Voice	FCEALVL(JP1)	\$33.00	\$10.00
Over 256 thru 384 Kbps			
Frame for LAN	FCEALVL(KP3)	\$30.00	\$10.00
Frame for SNA	FCEALVL(KP2)	\$33.00	\$10.00
Frame for Voice	FCEALVL(KP1)	\$37.00	\$10.00
Over 384 thru 512 Kbps			
Frame for LAN	FCEALVL(LP3)	\$36.00	\$10.00
Frame for SNA	FCEALVL(LP2)	\$39.00	\$10.00
Frame for Voice	FCEALVL(LP1)	\$44.00	\$10.00
Over 512 thru 768 Kbps			
Frame for LAN	FCEALVL(MP3)	\$42.00	\$10.00
Frame for SNA	FCEALVL(MP2)	\$47.00	\$10.00
Frame for Voice	FCEALVL(MP1)	\$52.00	\$10.00
Over 768 thru 1.536 Mbps			
Frame for LAN	FCEALVL(NP3)	\$50.00	\$10.00
Frame for SNA	FCEALVL(NP2)	\$60.00	\$10.00
Frame for Voice	FCEALVL(NP1)	\$70.00	\$10.00
Over 1.536 thru 4 Mbps			
Frame for LAN	FCEALVL(OP3)	\$120.00	\$10.00
Frame for SNA	FCEALVL(OP2)	\$135.00	\$10.00
Frame for Voice	FCEALVL(OP1)	\$150.00	\$10.00
Over 4 thru 10 Mbps			
Frame for LAN	FCEALVL(PP3)	\$170.00	\$10.00
Frame for SNA	FCEALVL(PP2)	\$190.00	\$10.00
Frame for Voice	FCEALVL(PP1)	\$210.00	\$10.00

GENERAL EXCHANGE TARIFF

Embarq Florida, Inc.

By: F. B. Poag  
Director

SECTION A29  
Second Revised Sheet 80  
Cancelling First Revised Sheet 80  
Effective: October 26, 2001

DIGITAL NETWORK SERVICES

E. ENHANCED FRAME RELAY SERVICE (Cont'd)

8. Rates and Charges (Cont'd)

c. Permanent Virtual Circuit (PVC) - IntraLATA (Cont'd)

Cir, Per PVC	S&E Code	Monthly Rate	Nonrecurring Charge
Over 10 thru 16 Mbps			
Frame for LAN	FCEALVL(QP3)	\$285.00	\$10.00
Frame for SNA	FCEALVL(QP2)	\$305.00	\$10.00
Frame for Voice	FCEALVL(QP1)	\$335.00	\$10.00
Over 16 thru 34 Mbps			
Frame for LAN	FCEALVL(RP3)	\$525.00	\$10.00
Frame for SNA	FCEALVL(RP2)	\$545.00	\$10.00
Frame for Voice	FCEALVL(RP1)	\$565.00	\$10.00
Over 34 thru 44.210 Mbps			
Frame for LAN	FCEALVL(SP3)	\$655.00	\$10.00
Frame for SNA	FCEALVL(SP2)	\$675.00	\$10.00
Frame for Voice	FCEALVL(SP1)	\$695.00	\$10.00

d. Permanent Virtual Circuit (PVC) - InterLATA

Cir, Per PVC

Over 0 thru 8 Kbps			
Frame for LAN	FCEALVI(AP3)	\$3.00	\$10.00
Frame for SNA	FCEALVI(AP2)	\$4.00	\$10.00
Frame for Voice	FCEALVI(AP1)	\$5.00	\$10.00
Over 8 thru 16 Kbps			
Frame for LAN	FCEALVI(BP3)	\$4.00	\$10.00
Frame for SNA	FCEALVI(BP2)	\$5.00	\$10.00
Frame for Voice	FCEALVI(BP1)	\$6.00	\$10.00
Over 16 thru 24 Kbps			
Frame for LAN	FCEALVI(TP3)	\$5.00	\$10.00
Frame for SNA	FCEALVI(TP2)	\$6.00	\$10.00
Frame for Voice	FCEALVI(TP1)	\$7.00	\$10.00
Over 24 thru 32 Kbps			
Frame for LAN	FCEALVI(DP3)	\$6.00	\$10.00
Frame for SNA	FCEALVI(DP2)	\$7.00	\$10.00
Frame for Voice	FCEALVI(DP1)	\$8.00	\$10.00
Over 32 thru 40 Kbps			
Frame for LAN	FCEALVI(EP3)	\$ 8.00	\$10.00
Frame for SNA	FCEALVI(EP2)	\$ 9.00	\$10.00
Frame for Voice	FCEALVI(EP1)	\$10.00	\$10.00
Over 40 thru 48 Kbps			
Frame for LAN	FCEALVI(FP3)	\$ 9.00	\$10.00
Frame for SNA	FCEALVI(FP2)	\$10.00	\$10.00
Frame for Voice	FCEALVI(FP1)	\$11.00	\$10.00

GENERAL EXCHANGE TARIFF

Embarq Florida, Inc.

By: F. B. Poag  
Director

SECTION A29  
Second Revised Sheet 81  
Cancelling First Revised Sheet 81  
Effective: October 26, 2001

DIGITAL NETWORK SERVICES

E. ENHANCED FRAME RELAY SERVICE (Cont'd)

8. Rates and Charges (Cont'd)

d. Permanent Virtual Circuit (PVC) - InterLATA (Cont'd)

<u>Cir, Per PVC</u>	<u>S&amp;E Code</u>	<u>Monthly Rate</u>	<u>Nonrecurring Charge</u>
Over 48 thru 56 Kbps			
Frame for LAN	FCEALVI(GP3)	\$10.00	\$10.00
Frame for SNA	FCEALVI(GP2)	\$11.00	\$10.00
Frame for Voice	FCEALVI(GP1)	\$12.00	\$10.00
Over 56 thru 64 Kbps			
Frame for LAN	FCEALVI(HP3)	\$11.00	\$10.00
Frame for SNA	FCEALVI(HP2)	\$12.00	\$10.00
Frame for Voice	FCEALVI(HP1)	\$13.00	\$10.00
Over 64 thru 128 Kbps			
Frame for LAN	FCEALVI(IP3)	\$20.00	\$10.00
Frame for SNA	FCEALVI(IP2)	\$23.00	\$10.00
Frame for Voice	FCEALVI(IP1)	\$26.00	\$10.00
Over 128 thru 256 Kbps			
Frame for LAN	FCEALVI(JP3)	\$26.00	\$10.00
Frame for SNA	FCEALVI(JP2)	\$30.00	\$10.00
Frame for Voice	FCEALVI(JP1)	\$34.00	\$10.00
Over 256 thru 384 Kbps			
Frame for LAN	FCEALVI(KP3)	\$31.00	\$10.00
Frame for SNA	FCEALVI(KP2)	\$34.00	\$10.00
Frame for Voice	FCEALVI(KP1)	\$38.00	\$10.00
Over 384 thru 512 Kbps			
Frame for LAN	FCEALVI(LP3)	\$36.00	\$10.00
Frame for SNA	FCEALVI(LP2)	\$40.00	\$10.00
Frame for Voice	FCEALVI(LP1)	\$45.00	\$10.00
Over 512 thru 768 Kbps			
Frame for LAN	FCEALVI(MP3)	\$43.00	\$10.00
Frame for SNA	FCEALVI(MP2)	\$48.00	\$10.00
Frame for Voice	FCEALVI(MP1)	\$53.00	\$10.00
Over 768 thru 1.536 Mbps			
Frame for LAN	FCEALVI(NP3)	\$55.00	\$10.00
Frame for SNA	FCEALVI(NP2)	\$65.00	\$10.00
Frame for Voice	FCEALVI(NP1)	\$75.00	\$10.00
Over 1.536 thru 4 Mbps			
Frame for LAN	FCEALVI(OP3)	\$125.00	\$10.00
Frame for SNA	FCEALVI(OP2)	\$140.00	\$10.00
Frame for Voice	FCEALVI(OP1)	\$155.00	\$10.00
Over 4 thru 10 Mbps			
Frame for LAN	FCEALVI(PP3)	\$180.00	\$10.00
Frame for SNA	FCEALVI(PP2)	\$200.00	\$10.00
Frame for Voice	FCEALVI(PP1)	\$220.00	\$10.00

GENERAL EXCHANGE TARIFF

Embarq Florida, Inc.

By: F. B. Poag  
Director

SECTION A29  
Second Revised Sheet 82  
Cancelling First Revised Sheet 82  
Effective: October 26, 2001

DIGITAL NETWORK SERVICES

E. ENHANCED FRAME RELAY SERVICE (Cont'd)

8. Rates and Charges (Cont'd)

d. Permanent Virtual Circuit (PVC) - InterLATA (Cont'd)

Cir, Per PVC	<u>S&amp;E Code</u>	<u>Monthly Rate</u>	<u>Nonrecurring Charge</u>
Over 10 thru 16 Mbps			
Frame for LAN	FCEALVI(QP3)	\$295.00	\$10.00
Frame for SNA	FCEALVI(QP2)	\$315.00	\$10.00
Frame for Voice	FCEALVI(QP1)	\$345.00	\$10.00
Over 16 thru 34 Mbps			
Frame for LAN	FCEALVI(RP3)	\$535.00	\$10.00
Frame for SNA	FCEALVI(RP2)	\$555.00	\$10.00
Frame for Voice	FCEALVI(RP1)	\$575.00	\$10.00
Over 34 thru 44.210 Mbps			
Frame for LAN	FCEALVI(SP3)	\$665.00	\$10.00
Frame for SNA	FCEALVI(SP2)	\$685.00	\$10.00
Frame for Voice	FCEALVI(SP1)	\$705.00	\$10.00

e. Private Network Link (PNL)

1.544 Mbps NNI

Month to month	FCECRTA	\$225.00	\$395.00
12-23 months	FCECRTA(1YR)	\$205.00	\$295.00
24-35 months	FCECRTA(2YR)	\$185.00	\$195.00
36-59 months	FCECRTA(3YR)	\$165.00	-0-
60-84 months	FCECRTA(5YR)	\$145.00	-0-

- f. An administrative charge will be applied, in addition to the applicable charges associated with Service Connection Charges, as specified in Section 18 of this tariff, when a change is made to a customer's frame relay configuration (including changes to an existing group's addressing or changes in bandwidth), at the customer's request. Such changes are defined as those rearrangements necessary to add, delete or rearrange the customer's configuration and changes of CIR on a PVC. The administrative charge applies to changes in a customer's network associated with PVCs. Only one administrative charge applies per customer request.

Administrative Charge (Nonrecurring) \$50.00

GENERAL EXCHANGE TARIFF

Embarq Florida, Inc.

By: F. B. Poag  
Director

SECTION A29  
Second Revised Sheet 83  
Cancelling First Revised Sheet 83  
Effective: August 4, 2004

DIGITAL NETWORK SERVICES

E. ENHANCED FRAME RELAY SERVICE (Cont'd)

8. Rates and Charges (Cont'd)

g. Frame To ATM Inter-Networking Link

Cir, Per PVC	S&E Code	Monthly Rate	Nonrecurring Charge
Over 0 thru 256 Kbps	FCEALVI(FA1)	\$ 25.00	\$50.00
Over 256 thru 384 Kbps	FCEALVI(FA2)	\$ 35.00	\$50.00
Over 384 thru 512 Kbps	FCEALVI(FA3)	\$ 45.00	\$50.00
Over 512 thru 768 Kbps	FCEALVI(FA4)	\$ 55.00	\$50.00
Over 768 thru 1.536 Mbps	FCEALVI(FA5)	\$ 75.00	\$50.00
Over 1.536 thru 4 Mbps	FCEALVI(FA6)	\$125.00	\$50.00
Over 4 thru 10 Mbps	FCEALVI(FA7)	\$185.00	\$50.00
Over 10 thru 16 Mbps	FCEALVI(FA8)	\$265.00	\$50.00
Over 16 thru 34 Mbps	FCEALVI(FA9)	\$525.00	\$50.00
Over 34 thru 44.736 Mbps	FCEALVI(FA0)	\$675.00	\$50.00

h. Gateway Service

Cir, Per PVC

Over 0 thru 8 Kbps	FCEALMT(008)	\$ 10.00	\$50.00
Over 8 thru 16 Kbps	FCEALMT(016)	\$ 20.00	\$50.00
Over 16 thru 24 Kbps	FCEALMT(024)	\$ 30.00	\$50.00
Over 24 thru 32 Kbps	FCEALMT(032)	\$ 40.00	\$50.00
Over 32 thru 40 Kbps	FCEALMT(040)	\$ 45.00	\$50.00
Over 40 thru 48 Kbps	FCEALMT(048)	\$ 50.00	\$50.00
Over 48 thru 56 Kbps	FCEALMT(056)	\$ 55.00	\$50.00
Over 56 thru 64 Kbps	FCEALMT(064)	\$ 60.00	\$50.00
Over 64 thru 128 Kbps	FCEALMT(128)	\$ 70.00	\$50.00
Over 128 thru 256 Kbps	FCEALMT(256)	\$ 80.00	\$50.00
Over 256 thru 384 Kbps	FCEALMT(384)	\$ 90.00	\$50.00
Over 384 thru 512 Kbps	FCEALMT(512)	\$100.00	\$50.00
Over 512 thru 768 Kbps	FCEALMT(768)	\$110.00	\$50.00
Over 768 thru 1.536 Mbps	FCEALMT(1M)	\$125.00	\$50.00
Over 1.536 thru 4 Mbps	FCEALMT(4M)	\$150.00	\$50.00
Over 4 thru 10 Mbps	FCEALMT(10M)	\$225.00	\$50.00
Over 10 thru 16 Mbps	FCEALMT(16M)	\$295.00	\$50.00
Over 16 thru 34 Mbps	FCEALMT(34M)	\$550.00	\$50.00
Over 34 thru 44.210 Mbps	FCEALMT(44M)	\$675.00	\$50.00

i. Utilization Reports

Per Channel

Month to month	FCEALUN RMM	\$ 18.95	\$50.00
12-23 months	FCEALUN R12	\$ 16.95	\$50.00
24-35 months	FCEALUN R24	\$ 14.95	\$50.00
36-59 months	FCEALUN R36	\$ 12.95	\$50.00
60-84 months	FCEALUN R60	\$ 10.95	\$50.00



GENERAL EXCHANGE TARIFF

Embarq Florida, Inc.

SECTION A30

By: F. B. Poag  
Director

Third Revised Contents Sheet 1  
Cancelling Second Revised Contents Sheet 1  
Effective: August 15, 2002

DERIVED CHANNEL SERVICES

CONTENTS

A.	INDIVIDUAL VOICE CHANNELS FOR CUSTOM ACCESS SOLUTIONS	1
1.	Description .....	1
2.	Definitions .....	2
3.	General Regulations .....	2
4.	Service Components .....	3
5.	Application of Rates .....	4
6.	Rates and Charges .....	4
B.	DIGITAL TRUNKING SERVICE .....	5
1.	General .....	5
2.	Regulations .....	5
3.	Term Discount Plan (TDP) .....	11
4.	Termination Liability Charges .....	12
5.	Rate Categories .....	13
6.	Application of Rates .....	14
7.	Rates and Charges .....	15
C.	ESP LINK .....	17
1.	General .....	17
2.	Regulations .....	18
3.	Term Discount Plan (TDP) .....	23
4.	Termination Liability Charges .....	24
5.	Rate Categories .....	25
6.	Application of Rates .....	26
7.	Rates and Charges .....	27

GENERAL EXCHANGE TARIFF

Embarq Florida, Inc.

By: F. B. Poag  
Director

SECTION A30  
Third Revised Sheet 1  
Cancelling Second Revised Sheet 1  
Effective: March 24, 2004

DERIVED CHANNEL SERVICES

A. INDIVIDUAL VOICE CHANNELS FOR CUSTOM ACCESS SOLUTIONS

1. Description

- a. Individual Voice Channels for Custom Access Solutions is an intraexchange digital service designed to provide for the integration of multiple voice channels over Custom Access Solutions as found in the Interstate Access Tariff.
- b. Individual Voice Channels are segregated from the data channels using a Digital Access and Cross-connect System (DACS) located in the Telephone Company's central office. The DACS will route the voice traffic to the serving wire center switching equipment. Individual Voice Channels may be provisioned with ISDN-PRI functionality upon request.
- c. Customers subscribing to Individual Voice Channels for Custom Access Solutions are limited to a maximum of 20 Individual Voice Channels per 1.544 Mbps facility. Each channel is dedicated to the provisioning of Individual Voice Channels for Custom Access Solutions. Channels not activated will not be used for purposes other than providing Individual Voice Channels for Custom Access Solutions.
- d. Customers subscribing to Individual Voice Channels for Custom Access Solutions must also order data channels at the same time from the Interstate Access Tariff.

Individual Voice Channels <sup>1</sup>	Frame Relay Service			
	256 Kbps (4 Channels)	384 Kbps (6 Channels)	512 Kbps (8 Channels)	768 Kbps (12 Channels)
6	10	12	14	18
8	12	14	16	20
10	14	16	18	22
12	16	18	20	24
14	18	20	22	N/A
16	20	22	24	N/A
18	22	24	N/A	N/A
20	24	N/A	N/A	N/A

Shaded area reflects total channels utilized for each combination.

<sup>1</sup> A minimum of 12 Individual Voice Channels is required when provisioned with ISDN-PRI functionality and each configuration requires one D-channel. For example, when a customer subscribes to 12 Individual Voice Channels with ISDN-PRI functionality, the customer is provided with 11 B-channels and one D-channel.

GENERAL EXCHANGE TARIFF

Embarq Florida, Inc.

By: F. B. Poag  
Director

SECTION A30  
Second Revised Sheet 2  
Cancelling First Revised Sheet 2  
Effective: March 24, 2004

DERIVED CHANNEL SERVICES

A. INDIVIDUAL VOICE CHANNELS FOR CUSTOM ACCESS SOLUTIONS (Cont'd)

1. Description (Cont'd)

e. Individual Voice Channels may be equipped with the following features, where available:

1) Incoming Call Identification (Caller ID) – Caller ID provides the customer with the telephone number of the calling party and is intended solely for the use of the Individual Voice Channels for Custom Access Solutions subscriber.

f. Individual Voice Channels with ISDN-PRI functionality provides functionality equivalent to ISDN-PRI II Service as described in Section A29 of this tariff. All standard features included with ISDN-PRI II Service are standard for Individual Voice Channels with ISDN-PRI functionality. In addition, optional features available with ISDN-PRI II Service are available with Individual Voice Channels with ISDN-PRI functionality, with the exception of D-Channel Backup and Circular Hunt. Optional features are provided at the rates and charges specified in Section A29 of this tariff on a per 1.544 Mbps facility basis.

2. Definitions

a. Digital Access and Cross-connect System (DACCS) – A digital switching device for routing and switching T-1 lines, and DS0 portions of lines, among multiple T-1 ports. The DACCS performs all the functions of a normal “switch” except connections are typically setup in advance of the call, not together with the call.

b. Custom Access Solutions – Provides for the integration of multiple voice and data channels over the same 1.544 Mbps facility, as referenced in the Interstate Access Tariff.

3. General Regulations

a. The regulations and rates specified herein for Individual Voice Channels for Custom Access Solutions are in addition to the applicable regulations and rates in other tariffs and other sections of this tariff. Unless specified, the regulations for Individual Voice Channels for Custom Access Solutions apply in addition to the General Regulations set forth in Section A2 of this tariff.

## GENERAL EXCHANGE TARIFF

Embarq Florida, Inc.

By: F. B. Poag  
Director

SECTION A30  
Fourth Revised Sheet 3  
Cancelling Third Revised Sheet 3  
Effective: March 24, 2004

### DERIVED CHANNEL SERVICES

#### A. INDIVIDUAL VOICE CHANNELS FOR CUSTOM ACCESS SOLUTIONS (Cont'd)

##### 3. General Regulations (Cont'd)

- b. Individual Voice Channels for Custom Access Solutions are provided subject to the availability of appropriate facilities as determined by the Company. Service inquiries will be necessary to determine availability.
- c. Customer Premises Equipment (CPE) that is compatible with Individual Voice Channels for Custom Access Solutions is the customer's responsibility to provision.
- d. The Company shall not be responsible if changes in any of the equipment, operations or procedures of the Company utilized in the provisioning of Individual Voice Channels for Custom Access Solutions render any facilities provided by the customer obsolete or require modification or alteration of such equipment or system or otherwise affect its use or performance.
- e. Individual Voice Channels for Custom Access Solutions is only available where facilities permit.
- f. Customers may disconnect Individual Voice Channels for Customer Access Solutions, without penalty, should the total of the monthly recurring rates associated with Individual Voice Channels for Custom Access Solutions increase by 10% or more at any one time.
- g. Custom Calling Features and ExpressTouch Services, as found in Section A13, are available as specified in this tariff at the applicable tariffed recurring rates.
- h. An Optional Calling Plan is available in certain exchanges. The plan is described in Section A3 of this tariff.
- i. One Directory Listing will be provided per 1.544 Mbps facility. Additional Directory Listings are available as specified in Section A6 of this tariff.

##### 4. Service Components

- a. Individual Voice Channels - A monthly rate is applicable for each voice channel for Custom Access Solutions. Custom Access Solutions is found in Local Telephone Companies' FCC Tariff No. 3, Section 8.7. Individual Voice Channels can be purchased in increments of 6, 8, 10, 12, 14, 16, 18 or 20 voice channels. Individual Voice Channels with ISDN-PRI functionality can be purchased in increments of 12, 14, 16, 18 or 20 voice channels.
- b. All other service components apply as found in the Interstate Access Tariff.

GENERAL EXCHANGE TARIFF

Embarq Florida, Inc.

By: F. B. Poag  
Director

SECTION A30  
Second Revised Sheet 4  
Cancelling First Revised Sheet 4  
Effective: March 24, 2004

DERIVED CHANNEL SERVICES

A. INDIVIDUAL VOICE CHANNELS FOR CUSTOM ACCESS SOLUTIONS (Cont'd)

5. Application of Rates

- a. The monthly rate per Individual Voice Channel includes all mandatory and applicable Extended Area Service (EAS) and Extended Calling Scope (ECS) recurring charges. ECS usage charges are applicable as specified in Section 3 of this tariff. Individual Voice Channels receive the same local calling area as any other form of basic local exchange service.
- b. Optional toll and extended local calling plans are available as specified in this tariff at the applicable tariffed recurring rates and usage charges.
- c. All federal and state surcharges apply per Individual Voice Channel, including, but not limited to, 9-1-1 surcharges and Telecommunications Relay Service (TRS) surcharges.
- d. Federal monthly end user charges apply, as described in the Interstate Access Tariff (e.g., End User Common Line (EUCL), Presubscribed Interexchange Carrier Charge (PICC), Line Port Charge (LPC), Local Number Portability (LNP), Federal Universal Service Fund (USF)).

6. Rates and Charges

	<u>Monthly Rate</u>
a. Individual Voice Channel without ISDN-PRI functionality: (per channel)	\$16.00
b. Individual Voice Channels with ISDN-PRI functionality: (per channel)	\$17.00

## GENERAL EXCHANGE TARIFF

Embarq Florida, Inc.

By: F. B. Poag  
Director

SECTION A30  
First Revised Sheet 5  
Cancelling Original Sheet 5  
Effective: August 15, 2002

### DERIVED CHANNEL SERVICES

#### B. DIGITAL TRUNKING SERVICE

##### 1. General

- a. Digital Trunking Service (DTS) is a digital intraexchange service furnished for use with PBX systems and appropriately equipped Key Systems.
- b. DTS will be available on a digital basis at the network interface on a customer's premises. The customer is required to provide the appropriate multiplexing equipment or interface needed to accommodate the Customer Premises Equipment (CPE).
- c. DTS provides twenty-four (24) digital channels within a single, channelized DS1/1.544 Mbps circuit available for voice-grade communications, where facilities are available.
- d. To ensure satisfactory operation, the CPE provided by the customer must be compatible with the DTS channel facility provided by the Company.
- e. The regulations for DTS specified herein apply in addition to the regulations set forth in other sections of this tariff.
- f. The rates specified for DTS in A30.B.7. following contemplate the provision of a digital quality facility utilizing existing interoffice carrier equipment and/or exchange cable facilities compatible with this service. If equipment, new facilities or changes to existing facilities are required for the provision of this service, then charges as specified in Section A5, Charges Applicable Under Special Conditions, will apply in addition to the rates for DTS..
- g. Suspension of service at the customer's request, as defined in Section A2 of this tariff, is not allowed.

##### 2. Regulations

###### a. Description of Service

- 1) DTS provides central office channels in any combination totaling twenty-four (24). This could include outward only, inward only, Direct Inward Dialing (DID), or Two-Way central office channels. DID channels are inbound only.

GENERAL EXCHANGE TARIFF

Embarq Florida, Inc.

By: F. B. Poag  
Director

SECTION A30  
Second Revised Sheet 6  
Cancelling First Revised Sheet 6  
Effective: January 6, 2003

DERIVED CHANNEL SERVICES

B. DIGITAL TRUNKING SERVICE (Cont'd)

2. Regulations (Cont'd)

a. Description of Service (Cont'd)

- 2) The individual channels carried via a group of DTS facilities may be arranged in separate trunk groups with different pilot numbers, up to a maximum of one trunk group per DTS facility. Customers may direct up to five (5) pilot numbers to the same DTS facility. Customers requiring more numbers must subscribe to Direct Inward Dialing service and be charged for numbers accordingly.
- 3) DID numbers are provided at the rates specified in Section A16 of this tariff. The only charge for DID numbers is the charge applicable to DID number blocks. No other charge in Section A16 apply for DID numbers. Pilot numbers cannot be used as a substitute for DID numbers.
- 4) DTS is not offered in conjunction with the following services:
  - a) Basic Exchange Service (e.g., R1, B1, Key, PBX)
  - b) Feature Groups A, B, C, or D
  - c) Private Line Access Services and facilities, unless otherwise stated in this section
  - d) Foreign Exchange Service on individual channels
- 5) A Two-Way channel may not be used to terminate DID Service associated with DTS.
- 6) One directory listing will be provided with DTS. Additional Directory Listings are available as specified in Section A6 of this tariff.
- 7) If a customer requests DTS from an alternative serving central office other than that designated by the Company, then all charges applicable to Foreign Exchange Service, as specified in Section A9 of this tariff, and interoffice mileage charges as specified in Section A21 for TransLink Service apply in addition to the rates and charges included in this section. Emergency 911 calls placed over DTS Channels provisioned via a foreign central office serving this arrangement will be identified as the alternative serving central office and not the central office normally serving the customer's location. The Company shall not be liable for any loss or damages arising from the emergency calls placed from DTS Channels provisioned via an alternative serving central office.

GENERAL EXCHANGE TARIFF

Embarq Florida, Inc.

By: F. B. Poag  
Director

SECTION A30  
Second Revised Sheet 7  
Cancels First Revised Sheet 7  
Effective: May 20, 2003

DERIVED CHANNEL SERVICES

B. DIGITAL TRUNKING SERVICE (Cont'd)

2. Regulations (Cont'd)

a. Description of Service (Cont'd)

- 8) When lines ordered as Outward WATS, Two-Way WATS, or 800 Service terminate on DTS, they will terminate as one of the twenty-four (24) available digital channels on a DTS facility. The rates and charges normally applicable to WATS and 800 Service will continue to apply when provided in conjunction with DTS.
- 9) A Channel Service Unit (CSU) or appropriate termination equipment provided by the customer is required at a customer's or authorized user's premises to perform such functions as:
  - a) proper termination of the service
  - b) amplification
  - c) signal shaping
  - d) remote loop-back
- 10) An Optional Calling Plan is available in certain exchanges. The plan is described in Section A3 of this tariff.

b. Definitions

- 1) Channel Service Unit (CSU) – The term "Channel Service Unit (CSU)" denotes equipment provided by the customer to terminate a digital facility on the customer's premises.
- 2) DS1 - This denotes a channel service expressed in terms of its digitally encoded data bit rate in accordance with the North American hierarchy of digital signal levels. It has a 1.544 Mbps transmission data rate, and provides for the two-way simultaneous transmission of isochronous times, Bipolar Return-to-Zero (BPRZ) bit stream format, except where intentional bipolar violations are introduced by Bipolar with 8 Zero Substitution (B8ZS) format. Unframed signal formats are not permitted or compatible with Company equipment. The required format and interface specifications are contained in Technical Reference Publications GR-54 and GR-342.
- 3) Nonrecurring Charge - A one-time charge for the initial installation, the installation of functions and features and service rearrangements.
- 4) Serving Wire Center - The local telephone central office assigned to subscribers in a predetermined geographic area.



GENERAL EXCHANGE TARIFF

Embarq Florida, Inc.

By: F. B. Poag  
Director

SECTION A30  
First Revised Sheet 8  
Cancelling Original Sheet 8  
Effective: August 15, 2002

DERIVED CHANNEL SERVICES

B. DIGITAL TRUNKING SERVICE (Cont'd)

2. Regulations (Cont'd)

c. Connections

- 1) Customer-Provided Terminal Equipment and Customer-Provided Communications Systems may be connected to DTS when such connection is made in accordance with the provisions specified in 2), 3) and 4) following.
- 2) Responsibility of the Company
  - a) The responsibility of the Company shall be limited to the furnishing and maintenance of DTS to a network interface on the customer's premises where provision is made for the connection of local service.
  - b) The Company shall not be responsible for installation, operation or maintenance of any terminal equipment or communications systems provided by the customer. DTS is not represented as adapted for the use of such equipment or system. Where such equipment or system is connected to Company facilities, the responsibility of the Company shall be limited to the furnishing of facilities suitable for DTS and to the maintenance and operation in a manner proper for such digital service. The Company shall not be responsible for:
    - (1) The through transmission of signals generated by such equipment or system, or for the quality of, or defects in, such transmission, or
    - (2) The reception of signals by such equipment or systems, or
    - (3) Damage to terminal equipment or communications systems provided by a customer or authorized user due to testing.
  - c) The Company shall not be responsible to the customer if changes in any of the facilities, operations or procedures of the Company utilized in the provision of DTS render any facilities or equipment provided by a customer obsolete, or require modification or alteration of such equipment or system or otherwise affects its use or performance.

GENERAL EXCHANGE TARIFF

Embarq Florida, Inc.

By: F. B. Poag  
Director

SECTION A30  
First Revised Sheet 9  
Cancelling Original Sheet 9  
Effective: August 15, 2002

DERIVED CHANNEL SERVICES

B. DIGITAL TRUNKING SERVICE (Cont'd)

2. Regulations (Cont'd)

c. Connections (Cont'd)

2) Responsibility of the Company (Cont'd)

d) The Company is responsible for maintaining and repairing the facilities it furnishes. The customer may not rearrange, disconnect, remove or attempt to repair any equipment installed by the Company without prior written consent of the Company.

e) The DTS Access Line as described following is designed to meet or exceed a performance objective of 99% error-free seconds of transmission per 1000 seconds on a daily basis and 99.9% availability on an annual basis when measured through the digital termination equipment.

f) In order to maintain the quality of DTS, the Company reserves the right to perform preventative maintenance and software updates to the network. The Company has classified maintenance as follows:

(1) Scheduled Maintenance

Scheduled maintenance is performed for functions such as hardware and software upgrades and network optimization. The Company will perform these tasks in a maintenance window that is anticipated to minimize disruption of customer service and activity. The Company will provide advance notice of all scheduled maintenance.

(2) Demand Maintenance

Demand maintenance may occur as a result of unexpected events and is performed when DTS network elements are in jeopardy. The Company will perform this type of maintenance at its discretion. Due to the nature of demand maintenance, prior notification may not be possible; however, the customer will be informed when the maintenance has been completed.

3) Responsibility of the Customer

a) The customer is responsible for installing and testing his customer premises equipment or facilities to insure that when they are connected to DTS such equipment or facilities are operating properly.

GENERAL EXCHANGE TARIFF

Embarq Florida, Inc.

By: F. B. Poag  
Director

SECTION A30  
First Revised Sheet 10  
Cancelling Original Sheet 10  
Effective: August 15, 2002

DERIVED CHANNEL SERVICES

B. DIGITAL TRUNKING SERVICE (Cont'd)

2. Regulations (Cont'd)

c. Connections (Cont'd)

3) Responsibility of the Customer (Cont'd)

b) The operating characteristics of the customer premises equipment or facilities shall be such as to not interfere with any of the services offered by the Company. Such use is subject to the further provisions that the equipment provided by a customer does not: endanger the safety of Company employees or the public; damage, require change in or alteration of the equipment or other facilities of the Company; interfere with the proper functioning of such equipment or facilities; impair the operation of the Company's facilities or otherwise injure the public in its use of the Company's services. Upon notice that the equipment provided by a customer is causing or is likely to cause such hazard or interference, the customer shall take such steps as shall be necessary to remove or prevent such hazard or interference.

c) The customer's responsibility shall include cooperative testing with the Company as may be necessary. Where regeneration and/or equalization adjustments or changes may be required to compensate for rearrangements and/or changes in outside plant facilities, the customer will be responsible for all expenses incurred in changes to his customer premises equipment.

4) Connection of Customer-Provided Terminal Equipment and Customer-Provided Communications Systems

a) The following provisions will apply:

(1) Customer-Provided Terminal Equipment and/or Customer-Provided Communications Systems may be connected at the premises of the customer to DTS.

(2) The undertaking of the Company is to furnish DTS as ordered and specified by the customer except as specified in d) following.

GENERAL EXCHANGE TARIFF

Embarq Florida, Inc.

By: F. B. Poag  
Director

SECTION A30  
First Revised Sheet 11  
Cancelling Original Sheet 11  
Effective: August 15, 2002

DERIVED CHANNEL SERVICES

B. DIGITAL TRUNKING SERVICE (Cont'd)

2. Regulations (Cont'd)

c. Connections (Cont'd)

4) Connection of Customer-Provided (Cont'd)

b) Connection of Channel Service Units

A Channel Service Unit (CSU) or appropriate termination equipment must be provided by the customer to connect a Company-provided digital facility. This equipment must comply with the technical requirements outlined in Part 68 of the FCC Rules and Regulations.

c) The customer shall be responsible for payment of a Trouble Location Charge, as set forth in Section A4 of this tariff, for visits by the Company to the customer's premises where the service difficulty or trouble report results from the use of equipment or facilities provided by the customer.

d) The customer may not rearrange, disconnect, remove or attempt to repair any equipment installed by the Company without the prior written consent of the Company.

e) For maintenance purposes, upon request of the Company, the customer will be responsible for notifying the Company of the type of digital terminating equipment used.

3. Term Discount Plan (TDP)

a. A Term Discount Plan (TDP) provides the customer with discounted rates for DTS. The minimum service period is twelve (12) months. DTS may be ordered under a TDP for fixed periods of 12 - 23 months, 24 - 35 months, 36 - 59 months, and 60 - 84 months. Month-to-month rates in this tariff may apply only after the expiration of a TDP. All rate elements within the same DTS facility must be ordered under the same commitment period and under the same service date. The customer must order the TDP in writing to the Company. A TDP may be ordered in one-month increments, (e.g. a 28-month commitment period or a 37-month commitment period).

b. The customer must specify the length of the initial service period at the time the service is ordered. When a customer converts to a TDP, Nonrecurring Charges do not apply toward facilities in-service at that time. If a customer converts from month-to-month rates to a TDP or upgrades from one TDP to another, Nonrecurring Charges and Service Charges do not apply.

c. At the end of the TDP the customer may subscribe to a new TDP at the prevailing rates set forth in A30.B.7. following. If the customer does not select a new TDP, the rates will convert to the prevailing month-to-month rates.

## GENERAL EXCHANGE TARIFF

Embarq Florida, Inc.

By: F. B. Poag  
Director

SECTION A30  
First Revised Sheet 12  
Cancelling Original Sheet 12  
Effective: August 15, 2002

### DERIVED CHANNEL SERVICES

#### B. DIGITAL TRUNKING SERVICE (Cont'd)

##### 3. Term Discount Plan (TDP) (Cont'd)

- d. Rate increases or decreases will automatically be applied to the monthly term plan rates for the remaining term of the TDP. If Company initiated rate increases to any rate element or combination of rate elements causes the charges for the entire DTS under the TDP to increase by 10% or more annually, then the customer may cancel the TDP without incurring termination liability charges provided the customer notifies the Company within 30 days after the effective date of the rate increase.
- e. The customer can extend TDP commitment periods at any time during the term of the plan, up to a maximum of 84 months. The number of remaining months in the original term plan will become part of the total term in the new term plan.

##### 4. Termination Liability Charges

- a. If a customer under a Term Discount Plan (TDP) disconnects all or a portion of DTS prior to the expiration of the TDP, then a Termination Liability Charge will apply to those services that are disconnected. The Termination Liability Charge will be a one-time charge equal to sum of 50% of the payments remaining for the rest of the TDP.
- b. Customers may move DTS Access Lines and not be subject to Termination Liability Charges providing the terms of the TDP are maintained. If charges as specified in A30.B.1.f. were applied to the service being terminated or moved, any termination or move charges associated with that construction apply, as well as any construction charges at the new location.
- c. Termination Liability Charges will not apply when a service or rate element under a TDP is disconnected prior to the expiration of a selected service period as a result of a change in tariff jurisdiction and/or a customer requested upgrade to a next generation service offering, under the following conditions:
  - 1) The service period of the new TDP for the new service offering is a period equal to or exceeding the remaining service period of the disconnected TDP, and
  - 2) The service orders to install the new service and disconnect the old service are related together, and there is no lapse in service between the installation of the new service and the disconnection of the old service, and
  - 3) The service orders to install the new service and disconnect the old service are for the same customer at the same location.
- d. The Company will determine whether the replacement service qualifies as a next generation service offering.
- e. Nonrecurring charges and Service Charges for the new service will apply according to the requirements of the new service.

## GENERAL EXCHANGE TARIFF

Embarq Florida, Inc.

By: F. B. Poag  
Director

SECTION A30  
First Revised Sheet 13  
Cancelling Original Sheet 13  
Effective: August 15, 2002

### DERIVED CHANNEL SERVICES

#### B. DIGITAL TRUNKING SERVICE (Cont'd)

##### 5. Rate Categories

There are three rate categories which apply to DTS:

- DTS Access Line
- DTS Interface
- DTS Channels

##### a. DTS Access Line

The DTS Access Line rate category provides for the communications path between a customer designated premises and the Serving Wire Center. Included as part of the DTS Access Line is a standard channel interface arrangement which defines the technical characteristics associated with the type of facilities to which the service is to be connected at the point of termination (POT) and the type of signaling capability if any. The signaling capability itself is provided as a part of this rate category. One DTS Access Line charge applies per DTS facility. The charge applicable to the DTS Access Line is set forth in A30.B.7.a. following.

##### b. DTS Interface

The DTS Interface rate category provides for the central office multiplexing to support twenty-four (24) channels at 56 Kbps with required signaling as necessary for trunking functionality. One DTS Interface charge applies per DS1 facility. The charges applicable to the DTS Interface are set forth in A30.B.7.b. following.

##### c. DTS Channels

The DTS Channels rate category provides unlimited usage of a network channel that will allow digital transmission up to 56 Kbps. Twenty-four (24) DTS Channels are required per DTS Interface. The charge applicable to DTS Channels is set forth in A30.B.7.c. following.

## GENERAL EXCHANGE TARIFF

Embarq Florida, Inc.

By: F. B. Poag  
Director

SECTION A30  
Second Revised Sheet 14  
Cancelling First Revised Sheet 14  
Effective: March 1, 2003

### DERIVED CHANNEL SERVICES

#### B. DIGITAL TRUNKING SERVICE (Cont'd)

##### 6. Application of Rates

- a. DTS is furnished between the normal Serving Wire Center and the customer's premises. At a minimum, each DTS facility is comprised of one DTS Access Line, one DTS Interface, and twenty-four (24) DTS Channels.
- b. A LightLink Local Channel Termination may be employed as a substitute for the DTS Access Line, provided that the Local Channel Termination meets the required technical standards necessary to support DTS. In such cases, there will be no charge for the DTS Access Line.
- c. The DTS Interface is provided at the Serving Wire Center. One DTS Interface charge applies per DS1 facility.
- d. When DTS is extended from an alternative central office, all charges applicable to Foreign Exchange Service and TransLink Service interoffice mileage apply in addition to the rates and charges included in this section.
- e. Twenty-four (24) DTS Channels apply per DTS Interface.
- f. Extended Area Service (EAS) and Extended Calling Scope (ECS) charges apply as specified in Section A3 of this tariff per DTS Channel. Toll charges apply when voice calls are completed outside the customer's designated local calling area or EAS territory. DTS Channels receive the same local calling area as any other form of basic local exchange service.
- g. Optional toll and extended local calling plans are available and will apply on a per DTS Interface basis as specified in this tariff at the applicable tariffed recurring rates and usage charges. Applicable charges will be calculated per DTS Channel.
- h. The Federal Subscriber Line Charge and the Presubscribed Interexchange Carrier Charge (PICC) apply per DTS Channel, as well as other federal monthly end user charges as described in the Interstate Access Tariff, (e.g., Local Number Portability (LNP), and Federal Universal Service Fund (USF).
- i. All federal, state, and local surcharges apply per DTS Channel, including, but not limited to, 9-1-1 surcharges and Telecommunications Relay Service (TRS) surcharges.
- j. Rates and charges specified in other sections of this tariff for services such as Custom Calling Features, ExpressTouch Service, etc., as specified in Section A13 of this tariff, apply in addition to the monthly rates for DTS on a per channel basis.
- k. Rotary Hunt functionality at no additional charge is available with DTS. The functionality may be within the channels of a single DTS arrangement, between channels of multiple DTS arrangements, or between PBX trunks, Key System trunks, and channels within a DTS arrangement.

GENERAL EXCHANGE TARIFF

Embarq Florida, Inc.

By: F. B. Poag  
Director

SECTION A30  
Second Revised Sheet 15  
Cancels First Revised Sheet 15  
Effective: September 20, 2003

DERIVED CHANNEL SERVICES

B. DIGITAL TRUNKING SERVICE (Cont'd)

7. Rates and Charges

	<u>Monthly Rate</u>	<u>Nonrecurring Charge Initial</u>	<u>Nonrecurring Charge Additional</u>	<u>Nonrecurring Charge Rearrangement</u>
a. DTS Access Line				
Month to Month <sup>1</sup>	\$200.00	\$300.00	\$110.00	\$150.00
12 - 23 Months	195.00	200.00	110.00	150.00
24 - 35 Months	175.00	110.00	110.00	150.00
36 - 59 Months	165.00	0.00	0.00	150.00
60 - 84 Months	145.00	0.00	0.00	150.00
b. DTS Interface				
Month to Month <sup>1</sup>	\$325.00	\$230.00	\$230.00	\$115.00
12 - 23 Months	305.00	130.00	130.00	115.00
24 - 35 Months	280.00	25.00	25.00	115.00
36 - 59 Months	270.00	0.00	0.00	115.00
60 - 84 Months	255.00	0.00	0.00	115.00
c. DTS Channels, each channel (24 required per DTS Interface)				
Month to Month <sup>1</sup>	\$15.00	\$5.00	\$5.00	\$5.00
12 - 23 Months	14.00	5.00	5.00	5.00
24 - 35 Months	13.00	5.00	5.00	5.00
36 - 59 Months	12.00	0.00	0.00	5.00
60 - 84 Months	11.00	0.00	0.00	5.00

<sup>1</sup>Month-to-month rates are available only after the expiration of one of the Term Discount Plans.



GENERAL EXCHANGE TARIFF

Embarq Florida, Inc.

By: F. B. Poag  
Director

SECTION A30  
First Revised Sheet 16  
Cancelling Original Sheet 16  
Effective: August 15, 2002

DERIVED CHANNEL SERVICES

B. DIGITAL TRUNKING SERVICE (Cont'd)

7. Rates and Charges (Cont'd)

e. Nonrecurring Charge

The Initial Nonrecurring Charge is applicable for the initial installation of a DTS Access Line, DTS Interface and DTS Channels to a given Serving Wire Center. The Additional Nonrecurring Charge is applicable for each additional DTS Access Line, DTS Interface and associated DTS Channels installed at the same location, the same time, under the same order, and with the same due date. The Rearrangement Nonrecurring Charge is applicable for any rearrangement of an existing DTS Access Line, DTS Interface, and DTS Channels.

f. Move Charges

A Move Charge applies for DTS Access Lines moved to a new location, even when moved on the same premises. The Move Charge is equal to the DTS Access Line Initial Nonrecurring Charge and applies in addition to the Primary Service Order Charge located in Section A4 of this tariff.

g. Service Charges

A Primary Service Order Charge as set forth in Section A4 of this tariff is applicable per customer request. Nonrecurring Charges specified in this tariff section are in lieu of all other Service Charges.

## GENERAL EXCHANGE TARIFF

Embarq Florida, Inc.

By: F. B. Poag  
Director

SECTION A30  
First Revised Sheet 17  
Cancelling Original Sheet 17  
Effective: August 15, 2002

### DERIVED CHANNEL SERVICES

#### C. ESP Link

##### 1. General

- a. ESP Link is a digital intraexchange service is intended for Enhanced Service Providers (ESPs) for use with Customer Premises Equipment (CPE).
- b. ESP Link will be available on a digital basis at the network interface on a customer's premises. The customer is required to provide the appropriate multiplexing equipment or interface needed to accommodate the CPE provided by the customer.
- c. ESP Link provides twenty-four (24) digital channels within a single, channelized DS1/1.544 Mbps circuit available for voice-grade communications, where facilities are available.
- d. To ensure satisfactory operation, the CPE provided by the customer must be compatible with the ESP Link channel facility provided by the Company.
- e. The regulations for ESP Link specified herein apply in addition to the regulations set forth in other sections of this tariff.
- f. The rates specified for ESP Link in A30.C.7 following contemplate the provision of a digital quality facility utilizing existing interoffice carrier equipment and/or exchange cable facilities compatible with this service. If equipment, new facilities or changes to existing facilities are required for the provision of this service, then charges as specified in Section A5, Charges Applicable Under Special Conditions, apply in addition to the rates for ESP Link.
- g. Suspension of service at the customer's request, as defined in Section A2 of this tariff, is not allowed.

##### 2. Regulations

###### a. Description of Service

- 1) ESP Link is furnished for the two-way transmission of digital signals at 1.544 Mbps between the serving wire center and the customer's premises located within the same exchange. Calls from the public switched network are terminated to the ESP Link facility, but the ESP Link facility is prohibited from originating calls. The Company will provide out pulses as seizures only and will not provide digits. ESP Link may not be terminated to a Serving Wire Center for the purposes of switched connection to the local exchange and/or long distance (local toll) network.

GENERAL EXCHANGE TARIFF

Embarq Florida, Inc.

By: F. B. Poag  
Director

SECTION A30  
Second Revised Sheet 18  
Cancelling First Revised Sheet 18  
Effective: January 6, 2003

DERIVED CHANNEL SERVICES

C. ESP Link (Cont'd)

2. Regulations

a. Description of Service

- 2) One pilot number will be provided with each ESP Link Interface, if required. Each additional ESP Link Interface may have its own pilot number, or may receive overflow traffic from another ESP Link Interface.
- 3) ESP Link is not offered in conjunction with the following services:
  - a) Basic Exchange Service (e.g., R1, B1, Key, PBX)
  - b) Feature Groups A, B, C, or D
  - c) Private Line Access Services and facilities, unless otherwise stated in this section
  - d) Foreign Exchange Service on individual channels
- 4) DID Service is not allowed for use with ESP Link.
- 5) No directory listings will be provided with ESP Link.
- 6) If a customer requests ESP Link from an alternative serving central office other than that designated by the Company, then all charges applicable to Foreign Exchange Service, as specified in Section A9 of this tariff, and interoffice mileage charges as specified in Section A21 for TransLink Service will apply in addition to the rates and charges included in this section. ESP Link is an inbound service only, and cannot be used to place Emergency 911 calls.
- 7) A Channel Service Unit (CSU) or appropriate termination equipment provided by the customer is required at a customer's or authorized user's premises to perform such functions as:
  - a) proper termination of the service
  - b) amplification
  - c) signal shaping
  - d) remote loop-back

GENERAL EXCHANGE TARIFF

Embarq Florida, Inc.

By: F. B. Poag  
Director

SECTION A30  
First Revised Sheet 19  
Cancelling Original Sheet 19  
Effective: August 15, 2002

DERIVED CHANNEL SERVICES

C. ESP Link (Cont'd)

2. Regulations (Cont'd)

b. Definitions

- 1) Channel Service Unit (CSU) – The term "Channel Service Unit (CSU)" denotes equipment provided by the customer to terminate a digital facility on the customer's premises.
- 2) DS1 - This denotes a channel service expressed in terms of its digitally encoded data bit rate in accordance with the North American hierarchy of digital signal levels. It has a 1.544 Mbps transmission data rate, and provides for the two-way simultaneous transmission of isochronous times, Bipolar Return-to-Zero (BPRZ) bit stream format, except where intentional bipolar violations are introduced by Bipolar with 8 Zero Substitution (B8ZS) format. Unframed signal formats are not permitted or compatible with Company equipment. The required format and interface specifications are contained in Technical Reference Publications GR-54 and GR-342.
- 3) Nonrecurring Charge - A one-time charge for the initial installation, the installation of functions and features and service rearrangements.
- 4) Serving Wire Center - The local telephone central office assigned to subscribers in a predetermined geographic area.

GENERAL EXCHANGE TARIFF

Embarq Florida, Inc.

By: F. B. Poag  
Director

SECTION A30  
First Revised Sheet 20  
Cancelling Original Sheet 20  
Effective: August 15, 2002

DERIVED CHANNEL SERVICES

C. ESP Link (Cont'd)

2. Regulations (Cont'd)

c. Connections

- 1) Customer-Provided Terminal Equipment and Customer-Provided Communications Systems may be connected to ESP Link when such connection is made in accordance with the provisions specified in 2), 3) and 4) following.
- 2) Responsibility of the Company
  - a) The responsibility of the Company shall be limited to the furnishing and maintenance of ESP Link to a network interface on the customer's premises where provision is made for the connection of local service.
  - b) The Company shall not be responsible for installation, operation or maintenance of any terminal equipment or communications systems provided by the customer. ESP Link is not represented as adapted for the use of such equipment or system. Where such equipment or system is connected to Company facilities, the responsibility of the Company shall be limited to the furnishing of facilities suitable for ESP Link and to the maintenance and operation in a manner proper for such digital service. The Company shall not be responsible for:
    - (1) The through transmission of signals generated by such equipment or system, or for the quality of, or defects in, such transmission, or
    - (2) The reception of signals by such equipment or systems, or
    - (3) Damage to terminal equipment or communications systems provided by a customer or authorized user due to testing.
  - c) The Company shall not be responsible to the customer if changes in any of the facilities, operations or procedures of the Company utilized in the provision of ESP Link render any facilities or equipment provided by a customer obsolete, or require modification or alteration of such equipment or system or otherwise affects its use or performance.

GENERAL EXCHANGE TARIFF

Embarq Florida, Inc.

By: F. B. Poag  
Director

SECTION A30  
First Revised Sheet 21  
Cancelling Original Sheet 21  
Effective: August 15, 2002

DERIVED CHANNEL SERVICES

C. ESP Link (Cont'd)

2. Regulations (Cont'd)

c. Connections (Cont'd)

2) Responsibility of the Company (Cont'd)

d) The Company is responsible for maintaining and repairing the facilities it furnishes. The customer may not rearrange, disconnect, remove or attempt to repair any equipment installed by the Company without prior written consent of the Company.

e) The ESP Link Access Line as described following is designed to meet or exceed a performance objective of 99% error-free seconds of transmission per 1000 seconds on a daily basis and 99.9% availability on an annual basis when measured through the digital termination equipment.

f) In order to maintain the quality of ESP Link, the Company reserves the right to perform preventative maintenance and software updates to the network. The Company has classified maintenance as follows:

(1) Scheduled Maintenance

Scheduled maintenance is performed for functions such as hardware and software upgrades and network optimization. The Company will perform these tasks in a maintenance window that is anticipated to minimize disruption of customer service and activity. The Company will provide advance notice of all scheduled maintenance.

(2) Demand Maintenance

Demand maintenance may occur as a result of unexpected events and is performed when ESP Link network elements are in jeopardy. The Company will perform this type of maintenance at its discretion. Due to the nature of demand maintenance, prior notification may not be possible; however, the customer will be informed when the maintenance has been completed.

3) Responsibility of the Customer

a) The customer is responsible for installing and testing his customer premises equipment or facilities to insure that when they are connected to ESP Link such equipment or facilities are operating properly.

GENERAL EXCHANGE TARIFF

Embarq Florida, Inc.

By: F. B. Poag  
Director

SECTION A30  
First Revised Sheet 22  
Cancelling Original Sheet 22  
Effective: August 15, 2002

DERIVED CHANNEL SERVICES

C. ESP Link (Cont'd)

2. Regulations (Cont'd)

c. Connections (Cont'd)

3) Responsibility of the Customer (Cont'd)

b) The operating characteristics of the customer premises equipment or facilities shall be such as to not interfere with any of the services offered by the Company. Such use is subject to the further provisions that the equipment provided by a customer does not: endanger the safety of Company employees or the public; damage, require change in or alteration of the equipment or other facilities of the Company; interfere with the proper functioning of such equipment or facilities; impair the operation of the Company's facilities or otherwise injure the public in its use of the Company's services. Upon notice that the equipment provided by a customer is causing or is likely to cause such hazard or interference, the customer shall take such steps as shall be necessary to remove or prevent such hazard or interference.

c) The customer's responsibility shall include cooperative testing with the Company as may be necessary. Where regeneration and/or equalization adjustments or changes may be required to compensate for rearrangements and/or changes in outside plant facilities, the customer will be responsible for all expenses incurred in changes to his customer premises equipment.

4) Connection of Customer-Provided Terminal Equipment and Customer-Provided Communications Systems

a) The following provisions will apply:

(1) Customer-Provided Terminal Equipment and/or Customer-Provided Communications Systems may be connected at the premises of the customer to ESP Link.

(2) The undertaking of the Company is to furnish ESP Link as ordered and specified by the customer except as specified in d) following.

## GENERAL EXCHANGE TARIFF

Embarq Florida, Inc.

By: F. B. Poag  
Director

SECTION A30  
First Revised Sheet 23  
Cancelling Original Sheet 23  
Effective: August 15, 2002

### DERIVED CHANNEL SERVICES

#### C. ESP Link (Cont'd)

##### 2. Regulations (Cont'd)

##### c. Connections (Cont'd)

##### 4) Connection of Customer-Provided ... (Cont'd)

##### b) Connection of Channel Service Units

A Channel Service Unit (CSU) or appropriate termination equipment must be provided by the customer to connect a Company-provided digital facility. This equipment must comply with the technical requirements outlined in Part 68 of the FCC Rules and Regulations.

c) The customer shall be responsible for payment of a Trouble Location Charge, as set forth in Section A4 of this tariff, for visits by the Company to the customer's premises where the service difficulty or trouble report results from the use of equipment or facilities provided by the customer.

d) The customer may not rearrange, disconnect, remove or attempt to repair any equipment installed by the Company without the prior written consent of the Company.

e) For maintenance purposes, upon request of the Company, the customer will be responsible for notifying the Company of the type of digital terminating equipment used.

##### 3. Term Discount Plan (TDP)

a. A Term Discount Plan (TDP) provides the customer with discounted rates for ESP Link. The minimum service period is twelve (12) months. ESP Link may be ordered under a TDP for fixed periods of 12 - 23 months, 24 - 35 months, 36 - 59 months, and 60 - 84 months. Month-to-month rates in this tariff may apply only after the expiration of a TDP. All rate elements within the same ESP Link facility must be ordered under the same commitment period and under the same service date. The customer must order the TDP in writing to the Company. A TDP may be ordered in one-month increments, (e.g. a 28-month commitment period or a 37-month commitment period).

b. The customer must specify the length of the initial service period at the time the service is ordered. When a customer converts to a TDP, Nonrecurring Charges do not apply toward facilities in-service at that time. If a customer converts from month-to-month rates to a TDP or upgrades from one TDP to another, Nonrecurring Charges and Service Charges do not apply.

c. At the end of the TDP the customer may subscribe to a new TDP at the prevailing rates set forth in A30.C.7 following. If the customer does not select a new TDP, the rates will convert to the prevailing month-to-month rates.



## GENERAL EXCHANGE TARIFF

Embarq Florida, Inc.

By: F. B. Poag  
Director

SECTION A30  
First Revised Sheet 24  
Cancelling Original Sheet 24  
Effective: August 15, 2002

### DERIVED CHANNEL SERVICES

#### C. ESP Link (Cont'd)

##### 3. Term Discount Plan (TDP) (Cont'd)

- d. Rate increases or decreases will automatically be applied to the monthly term plan rates for the remaining term of the TDP. If Company initiated rate increases to any rate element or combination of rate elements causes the charges for the entire ESP Link under the TDP to increase by 10% or more annually, then the customer may cancel the TDP without incurring termination liability charges provided the customer notifies the Company within 30 days after the effective date of the rate increase.
- e. The customer can extend TDP commitment periods at any time during the term of the plan, up to a maximum of 84 months. The number of remaining months in the original term plan will become part of the total term in the new term plan.

##### 4. Terminations Liability Charges

- a. If a customer under a Term Discount Plan (TDP) disconnects all or a portion of ESP Link prior to the expiration of the TDP, then a Termination Liability Charge will apply to those services that are disconnected. The Termination Liability Charge will be a one-time charge equal to sum of 50% of the payments remaining for the rest of the TDP.
- b. Customers may move ESP Link Access Lines and not be subject to Termination Liability Charges providing the terms of the TDP are maintained. If charges as specified in A30.C.1.f. were applied to the service being terminated or moved, any termination or move charges associated with that construction apply, as well as any construction charges at the new location.
- c. Termination Liability Charges will not apply when a service or rate element under a TDP is disconnected prior to the expiration of a selected service period as a result of a change in tariff jurisdiction and/or a customer requested upgrade to a next generation service offering, under the following conditions:
  - 1) The service period of the new TDP for the new service offering is a period equal to or exceeding the remaining service period of the disconnected TDP, and
  - 2) The service orders to install the new service and disconnect the old service are related together, and there is no lapse in service between the installation of the new service and the disconnection of the old service, and
  - 3) The service orders to install the new service and disconnect the old service are for the same customer at the same location.
- d. The Company will determine whether the replacement service qualifies as a next generation service offering.
- e. Nonrecurring charges and Service Charges for the new service will apply according to the requirements of the new service.

GENERAL EXCHANGE TARIFF

Embarq Florida, Inc.

By: F. B. Poag  
Director

SECTION A30  
First Revised Sheet 25  
Cancelling Original Sheet 25  
Effective: August 15, 2002

DERIVED CHANNEL SERVICES

C. ESP Link (Cont'd)

5. Rate Categories

There are three rate categories which apply to ESP Link:

- ESP Link Access Line
- ESP Link Interface
- ESP Link Channels

a. ESP Link Access Line

The ESP Link Access Line rate category provides for the communications path between a customer designated premises and the Serving Wire Center. Included as part of the ESP Link Access Line is a standard channel interface arrangement which defines the technical characteristics associated with the type of facilities to which the service is to be connected at the point of termination (POT) and the type of signaling capability if any. The signaling capability itself is provided as a part of this rate category. One ESP Link Access Line charge applies per ESP Link facility. The charge applicable to the ESP Link Access Line is set forth in A30.C.7a. following.

b. ESP Link Interface

The ESP Link Interface rate category provides for the central office multiplexing to support twenty-four (24) channels at 56 Kbps with required signaling as necessary for trunking functionality. The charge applicable to the ESP Link Interface are set forth in A30.C.7b. following

c. ESP Link Channels

The ESP Link Channels rate category provides unlimited usage of a network channel that will allow digital transmission up to 56 Kbps. Twenty-four (24) ESP Link Channels are required per ESP Link Interface. The charge applicable to ESP Link Channels is set forth in A30.C.7c. following.

GENERAL EXCHANGE TARIFF

Embarq Florida, Inc.

By: F. B. Poag  
Director

SECTION A30  
Second Revised Sheet 26  
Cancelling First Revised Sheet 26  
Effective: March 1, 2003

DERIVED CHANNEL SERVICES

C. ESP Link (Cont'd)

6. Applications of Rates

- a. ESP Link is furnished between the normal Serving Wire Center and the customer's premises. At a minimum, each ESP Link facility is comprised of one ESP Link Access Line, one ESP Link Interface, and twenty-four (24) ESP Link Channels.
- b. A LightLink Local Channel Termination may be employed as a substitute for the ESP Link Access Line, provided that the Local Channel Termination meets the required technical standards necessary to support ESP Link. In such cases, there will be no charge for the ESP Link Access Line.
- c. The ESP Link Interface is provided at the Serving Wire Center. One ESP Link Interface charge applies per ESP Link facility.
- d. When ESP Link is extended from an alternative central office, all charges applicable to Foreign Exchange Service and TransLink Service interoffice mileage apply in addition to the rates and charges included in this section.
- e. Twenty-four (24) ESP Link Channels apply per ESP Link Interface.
- f. ESP Link Channels receive the same local calling area as any other form of basic local exchange service.
- g. The Federal Subscriber Line Charge and the Presubscribed Interexchange Carrier Charge (PICC) apply at a ratio of five (5) per ESP Link Interface, as well as other federal monthly end user charges as described in the Interstate Access Tariff, (e.g., Local Number Portability (LNP), and Federal Universal Service Fund (USF).
- h. All federal, state, and local surcharges apply per ESP Link Channel, including, but not limited to, 9-1-1 surcharges and Telecommunications Relay Service (TRS) surcharges.
- i. Services such as Custom Calling Features, ExpressTouch Service, etc., as specified in Section A13 of this tariff, are not available in conjunction with ESP Link.
- k. Rotary Hunt functionality is inherent to ESP Link Service.

GENERAL EXCHANGE TARIFF

Embarq Florida, Inc.

SECTION A30

By: F. B. Poag  
Director

Third Revised Sheet 27  
Cancelling Second Revised Sheet 27  
Effective: September 20, 2003

DERIVED CHANNEL SERVICES

C. ESP Link (Cont'd)

7. Rates and Charges

	<u>Monthly Rate</u>	<u>Nonrecurring Charge Initial</u>	<u>Nonrecurring Charge Additional</u>	<u>Nonrecurring Charge Rearrangement</u>
a. ESP Link Access Line				
Month to Month <sup>1</sup>	\$165.00	N/A	N/A	\$125.00
12 - 23 Months	145.00	\$200.00	\$100.00	125.00
24 - 35 Months	125.00	110.00	100.00	125.00
36 - 59 Months	115.00	0.00	0.00	125.00
60 - 84 Months	105.00	0.00	0.00	125.00
b. ESP Link Interface				
Month to Month <sup>1</sup>	\$184.00	N/A	N/A	\$100.00
12 - 23 Months	179.00	\$125.00	\$125.00	100.00
24 - 35 Months	164.00	25.00	25.00	100.00
36 - 59 Months	154.00	0.00	0.00	100.00
60 - 84 Months	129.00	0.00	0.00	100.00
c. ESP Link Channels, each channel (24 required per ESP Link Interface)				
Month to Month <sup>1</sup>	\$14.00	N/A	N/A	\$5.00
12 - 23 Months	13.00	\$ 2.00	\$ 2.00	5.00
24 - 35 Months	12.00	1.00	1.00	5.00
36 - 59 Months	11.00	0.00	0.00	5.00
60 - 84 Months	10.00	0.00	0.00	5.00

<sup>1</sup>Month-to-month rates are available only after the expiration of one of the Term Discount Plans.

GENERAL EXCHANGE TARIFF

Embarq Florida, Inc.

By: F. B. Poag  
Director

SECTION A30  
First Revised Sheet 28  
Cancelling Original Sheet 28  
Effective: August 15, 2002

DERIVED CHANNEL SERVICES

C. ESP Link (Cont'd)

7. Rates and Charges (Cont'd)

d. Nonrecurring Charge

The Initial Nonrecurring Charge is applicable for the initial installation of a ESP Link Access Line, ESP Link Interface and ESP Link Channels to a given Serving Wire Center. The Additional Nonrecurring Charge is applicable for each additional ESP Link Access Line, ESP Link Interface and associated ESP Link Channels installed at the same location, the same time, under the same order, and with the same due date. The Rearrangement Nonrecurring Charge is applicable for any rearrangement of an existing ESP Link Access Line, ESP Link Interface, and ESP Link Channels.

e. Move Charges

A Move Charge applies for ESP Link Access Lines moved to a new location, even when moved on the same premises. The Move Charge is equal to the ESP Link Access Line Initial Nonrecurring Charge and applies in addition to the Primary Service Order Charge located in Section A4 of this tariff.

f. Service Charges

A Primary Service Order Charge as set forth in Section A4 of this tariff is applicable per customer request. Nonrecurring Charges specified in this tariff section are in lieu of all other Service Charges.

GENERAL EXCHANGE TARIFF

Embarq Florida, Inc.

By: F. B. Poag  
Director

SECTION A39  
Second Revised Contents Sheet 1  
Canceling First Revised Contents Sheet 1  
Effective: April 27, 2000

ABBREVIATED DIALING

CONTENTS

This Page Also Cancels the Following Sheets:

Second Revised Sheet 1  
Second Revised Sheet 2  
First Revised Sheet 2.1  
Original Sheet 3  
Second Revised Sheet 4  
Original Sheet 5  
Original Sheet 6  
Original Sheet 7  
Original Sheet 8  
Original Sheet 9  
Original Sheet 10  
Original Sheet 11  
Original Sheet 12  
Original Sheet 13  
Original Sheet 14  
Original Sheet 15  
Original Sheet 16  
Original Sheet 17  
Original Sheet 18  
Original Sheet 19  
Original Sheet 20  
Original Sheet 21  
Original Sheet 22  
Original Sheet 23  
Original Sheet 24  
Original Sheet 25  
Original Sheet 26  
Original Sheet 27  
Original Sheet 28  
First Revised Sheet 29

GENERAL EXCHANGE TARIFF

Embarq Florida, Inc.

By: F. B. Poag  
Director

SECTION A101  
Second Revised sheet 1  
Cancelling First Revised Sheet 1  
Effective: April 1, 1997

OBSOLETE SERVICE OFFERINGS  
EXPLANATION OF TERMS

RESERVED FOR FUTURE USE

GENERAL EXCHANGE TARIFF

Embarq Florida, Inc.

By: F. B. Poag  
Director

SECTION A103  
Seventh Revised Sheet 1  
Cancelling Sixth Revised Sheet 1  
Effective: November 1, 2005

OBSOLETE SERVICE OFFERINGS  
RESERVED FOR FUTURE USE



GENERAL EXCHANGE TARIFF

Embarq Florida, Inc.

By: F. B. Poag  
Director

SECTION A103  
Sixth Revised Sheet 2  
Cancelling Fifth Revised Sheet 2  
Effective: November 1, 2005

OBSOLETE SERVICE OFFERINGS  
RESERVED FOR FUTURE USE

GENERAL EXCHANGE TARIFF

Embarq Florida, Inc.

By: F. B. Poag  
Director

SECTION A103  
Fifth Revised Sheet 3  
Cancelling Fourth Revised Sheet 3  
Effective: November 12, 2004

OBSOLETE SERVICE OFFERINGS  
BASIC LOCAL EXCHANGE SERVICE

A. MONTHLY EXCHANGE RATES

This information formerly appeared in Section A3 and became obsolete on March 1, 2003. Only subscribers to access lines without Touch-Tone Service are grandfathered. No new customers may subscribe to an access line without Touch-Tone. This service will continue to be provided to existing customer(s) until such time as discontinued by the customer or the Florida Public Service Commission.

1. Basic Access Line – Rates and Charges (Cont'd)

	<u>Rate Groups</u>				
	1	2	3	4	5
n. Trunks, Flat Rate	\$35.75	36.95	41.50	43.65	49.75
1) Central Telephone- Eglin AFB	\$41.20				

GENERAL EXCHANGE TARIFF

Embarq Florida, Inc.

By: F. B. Poag  
Director

SECTION A103  
Seventh Revised Sheet 4  
Cancelling Sixth Revised Sheet 4  
Effective: November 1, 2005

OBSOLETE SERVICE OFFERINGS  
RESERVED FOR FUTURE USE

GENERAL EXCHANGE TARIFF

Embarq Florida, Inc.

By: F. B. Poag  
Director

SECTION A103  
Sixth Revised Sheet 5  
Cancelling Fifth Revised Sheet 5  
Effective: November 1, 2005

OBSOLETE SERVICE OFFERINGS  
RESERVED FOR FUTURE USE

GENERAL EXCHANGE TARIFF

Embarq Florida, Inc.

By: F. B. Poag  
Director

SECTION A103  
Sixth Revised Sheet 6  
Cancelling Fifth Revised Sheet 6  
Effective: November 12, 2004

OBSOLETE SERVICE OFFERINGS  
BASIC LOCAL EXCHANGE SERVICE

RESERVED FOR FUTURE USE

GENERAL EXCHANGE TARIFF

Embarq Florida, Inc.

By: F. B. Poag  
Director

SECTION A103  
Fifth Revised Sheet 7  
Cancelling Fourth Revised Sheet 7  
Effective: November 12, 2004

OBSOLETE SERVICE OFFERINGS  
BASIC LOCAL EXCHANGE SERVICE

A. MONTHLY EXCHANGE RATES

This information formerly appeared in Section A3 and became obsolete on March 1, 2003. Only subscribers to access lines without Touch-Tone Service are grandfathered. No new customers may subscribe to an access line without Touch-Tone. This service will continue to be provided to existing customer(s) until such time as discontinued by the customer or the Florida Public Service Commission.

3. SmallTalk

d. Rates and Charges

- 1) Monthly rates are listed above.
- 2) The equivalent of \$3.00 per month in call allowance is provided with the basic SmallTalk service. Calls in excess of the \$3.00 allowance will be billed to the subscriber at the rate of \$.10 per call.
- 3) Calls to areas outside the subscriber's local exchange and EAS calling scope will be billed at the appropriate long distance rates. Such calls are not included in the monthly allowance calculation.
- 4) SmallTalk is not offered in conjunction with any other local or EAS alternative calling plan.

GENERAL EXCHANGE TARIFF

Embarq Florida, Inc.

BY: F. B. Poag  
Director

SECTION A103  
Sixth Revised Sheet 8  
Cancelling Fifth Revised Sheet 8  
Effective: May 4, 2005

OBSOLETE SERVICE OFFERINGS  
BASIC LOCAL EXCHANGE SERVICE

RESERVED FOR FUTURE USE

GENERAL EXCHANGE TARIFF

Embarq Florida, Inc.

By: F. B. Poag  
Director

SECTION A103  
Fourth Revised Sheet 9  
Cancelling Third Revised Sheet 9  
Effective: November 1, 2005

OBSOLETE SERVICE OFFERINGS  
BASIC LOCAL EXCHANGE SERVICE

C. RESIDENTIAL, CENTREX LINES

This information formerly appeared in Section A3 and became obsolete on May 10, 2002. No new customers may subscribe to this service. This service will continue to be provided to existing customers until such time as discontinued by the customer or the Florida Public Service Commission, or the service can no longer be maintained by the Company.

1. General

a. Residential, Centrex Line

Individual access lines provided with central office based Centrex software.

b. Residential, Centrex Line - Rotary

1) Individual access lines provided with central office based Centrex software configured in central offices provided rotary hunting.

2) Residential, Centrex Rotary Line Service is limited to three lines in rotary. If more than three lines in rotary are required, Business, Centrex Line Rotary rates will apply to all lines in rotary.

2. Rates and Charges

a. Residential, Centrex Line

	<u>Rate Groups</u>				
	<u>1</u>	<u>2</u>	<u>3</u>	<u>4</u>	<u>5</u>
	\$16.00	17.00	18.00	19.00	20.00

b. Residential, Rotary,  
Centrex Line

	\$16.25	17.25	18.25	19.25	20.25
--	---------	-------	-------	-------	-------



GENERAL EXCHANGE TARIFF

Embarq Florida, Inc.

By: F. B. Poag  
Director

SECTION A106  
Second Revised sheet 1  
Cancelling First Revised Sheet 1  
Effective: April 1, 1997

OBSOLETE SERVICE OFFERINGS  
DIRECTORY LISTINGS

RESERVED FOR FUTURE USE

GENERAL EXCHANGE TARIFF

Embarq Florida, Inc.

By: F. B. Poag  
Director

SECTION A107  
Second Revised Sheet 1  
Cancelling First Revised Sheet 1  
Effective: April 1, 1997

OBSOLETE SERVICE OFFERINGS  
COIN TELEPHONE SERVICE

RESERVED FOR FUTURE USE

GENERAL EXCHANGE TARIFF

Embarq Florida, Inc

By: F. B. Poag  
Director

SECTION A107  
Second Revised Sheet 2  
Cancelling First Revised Sheet 2  
Effective: April 1, 1997

OBSOLETE SERVICE OFFERINGS  
COIN TELEPHONE SERVICE

RESERVED FOR FUTURE USE

GENERAL EXCHANGE TARIFF

Embarq Florida, Inc

By: F. B. Poag  
Director

SECTION A107  
Second Revised Sheet 3  
Cancelling First Revised Sheet 3  
Effective: April 1, 1997

OBSOLETE SERVICE OFFERINGS  
COIN TELEPHONE SERVICE

RESERVED FOR FUTURE USE

GENERAL EXCHANGE TARIFF

Embarq Florida, Inc

By: F. B. Poag  
Director

SECTION A107  
Second Revised Sheet 4  
Cancelling First Revised Sheet 4  
Effective: April 1, 1997

OBSOLETE SERVICE OFFERINGS  
COIN TELEPHONE SERVICE

RESERVED FOR FUTURE USE

GENERAL EXCHANGE TARIFF

Embarq Florida, Inc.

Section A108

By: F. B. Poag  
Director

Second Revised Contents Sheet 1  
Cancelling First Revised Contents Sheet 1  
Effective: December 1, 1997

OBSOLETE SERVICE OFFERINGS  
TELEPHONE ANSWERING SERVICE FACILITIES

CONTENTS

A.	GENERAL .....	1
B.	RATES AND CHARGES .....	2

GENERAL EXCHANGE TARIFF

Embarq Florida, Inc.

By: F. B. Poag  
Director

Section A108  
First Revised Sheet 1  
Cancelling Original Sheet 1  
Effective: January 1, 1997

OBSOLETE SERVICE OFFERINGS  
TELEPHONE ANSWERING SERVICE FACILITIES

A. GENERAL

1. The company will provide facilities for Telephone Answering Bureaus (hereafter referred to as Bureaus) for their use in furnishing telephone answering service to customers when they are unavailable to answer their calls personally.
2. Main station terminations are also provided in those cases where the customer contracts with a Bureau to answer all incoming calls.
3. Facilities will be furnished for answering incoming calls only.
4. Local exchange trunks listed in the name of the Bureau may be terminated in telephone answering equipment for the purpose of completing local or long distance calls to and from administrative telephones furnished with and on the same premises as the telephone answering equipment.
5. A Bureau may bridge calls from secretarial lines to the general exchange network over local exchange central office lines furnished the Bureau for its administrative use; however, these facilities furnished by the Company are not designed for such call bridging. A Bureau will bridge calls at its own risk and the company will not be liable for defects in transmission or other service difficulties arising out of or resulting from this type of connection.

GENERAL EXCHANGE TARIFF

Embarq Florida, Inc.

By: F. B. Poag  
Director

Section A108  
First Revised Sheet 2  
Cancelling Original Sheet 2  
Effective: January 1, 1997

OBSOLETE SERVICE OFFERINGS  
TELEPHONE ANSWERING SERVICE FACILITIES

A. GENERAL

6. Foreign exchange service may be terminated in telephone answering equipment via a secretarial line arrangement for answering purposes only; they may not be terminated in telephone answering equipment for completing calls to and from administrative telephones or the attendant.
7. Outward Wide Area Telephone Service (WATS) access lines may not be terminated in telephone answering equipment. Extensions on Inward WATS access lines may be terminated in telephone answering equipment for the purpose of answering calls at such time as the subscriber is not available at the main station.
8. Administrative lines and stations connected to telephone answering switchboard will be charged for at the regular PBX trunk and station rates, as outlined in this tariff.

B. RATES AND CHARGES

1. Rates and Charges

	<u>Nonrecurring Charges</u>	<u>Monthly Rate</u>
a. Secretarial Line Terminations for extension station lines terminating directly from the central office into telephone answering equipment, each	\$15.00	\$1.25



GENERAL EXCHANGE TARIFF

Embarq Florida, Inc.

By: F. B. Poag  
Director

Section A108  
First Revised Sheet 3  
Cancelling Original Sheet 3  
Effective: January 1, 1997

OBSOLETE SERVICE OFFERINGS  
TELEPHONE ANSWERING SERVICE FACILITIES

B. RATES AND CHARGES

1. Rates and Charges (Cont'd)

	<u>Monthly Rate</u>
b. Secretarial Line Mileage	
1) Within the same exchange	
For each one-quarter mile or fraction thereof between different buildings on the same premises	\$1.50
For each one-quarter mile or fraction thereof between different buildings, different premises	\$1.00
2) Between exchanges	Charges as specified in the BellSouth Private Line Service and Channels Tariff apply.
c. The nonrecurring charge shall apply when an existing customer is being connected to a Telephone Answering Service having dedicated facilities.	

GENERAL EXCHANGE TARIFF

Embarq Florida, Inc.

By: F. B. Poag  
Director

Section A108  
First Revised Sheet 4  
Cancelling Original Sheet 4  
Effective: January 1, 1997

OBSOLETE SERVICE OFFERINGS  
TELEPHONE ANSWERING SERVICE FACILITIES

B. RATES AND CHARGES

1. Rates and Charges (Cont'd)

- d. When a new line is being installed and will appear only at a Telephone Answering Service with dedicated facilities, a Service Ordering Charge, an Access Line Charge, plus the Nonrecurring Charge will apply.
- e. Full Service Charges and not the Nonrecurring Charge shall apply for all lines connected to Telephone Answering Services not having dedicated facilities.

GENERAL EXCHANGE TARIFF

Embarq Florida, Inc.

SECTION A111

By: F. B. Poag  
Director

Second Revised Contents Sheet 1  
Cancelling First Revised Contents Sheet 1  
Effective: May 10, 2002

OBSOLETE SERVICE OFFERINGS  
DIGITAL CENTREX SERVICE  
(CENTRAL TELEPHONE EXCHANGES ONLY)  
CONTENTS

A.	CITY WIDE SERVICE .....	1
B.	DIGITAL CENTREX SERVICE .....	2
	1. General .....	2
	2. Service Features .....	3
	3. Rates and Charges .....	6
C.	DIGITAL CENTREX SERVICE - OPTIONAL FEATURES .....	11
	1. Northern Telecom Business Terminal .....	11
	2. Automatic Call Distribution (ACD) .....	11
	3. Customer Specific Recorded Announcements.....	12
	4. Answering Service Identification Forwarding (ASIF).....	13
	5. Enhanced Automatic Call Distribution (ACD) .....	13
D.	DIGITAL CENTREX NETWORK - SPECIAL ACCESS .....	14
	1. General .....	14
	2. Rates and Charges.....	14
E.	EXPRESSTOUCH CENTREX FEATURES .....	15
	1. General .....	15
	2. Regulations.....	15
	3. Features.....	16
	4. Rates and Charges.....	18

GENERAL EXCHANGE TARIFF

Embarq Florida, Inc.

By: F. B. Poag  
Director

SECTION A111  
First Revised Sheet 1  
Cancelling Original Sheet 1  
Effective: February 11, 1997

OBSOLETE SERVICE OFFERINGS  
DIGITAL CENTREX SERVICE  
(CENTRAL TELEPHONE EXCHANGES ONLY)

A. CITY WIDE SERVICE

The following information formerly appeared in Section A11 and was made obsolete on February 11, 1997. This service will be provided to existing customers until changed or discontinued by the customer or the Company.

1. For those customers with more than one premises location within an exchange, City Wide Service is offered. This service will enable a customer to use the same telephone number or central office prefix at any premises within the exchange.
2. The service is subject to the availability of facilities and the customer's various locations must be served by digital central offices.
3. Regular Foreign Exchange (FX) charges apply to access lines at a premises located in another exchange.
4. A minimum of 20 access lines must be installed in each premises location.
5. The City Wide Service rates are in addition to the rates applicable to Digital Centrex Service in A.3. preceding.
6. Rates and Charges

Monthly Rate

City Wide Service, per access line

\$9.15

GENERAL EXCHANGE TARIFF

Embarq Florida, Inc.

By: F. B. Poag  
Director

SECTION A111  
First Revised Sheet 2  
Cancelling Original Sheet 2  
Effective: May 10, 2002

OBSOLETE SERVICE OFFERINGS  
DIGITAL CENTREX SERVICE  
(CENTRAL TELEPHONE EXCHANGES ONLY)

B. DIGITAL CENTREX SERVICE

This information formerly appeared in Section A11 and became obsolete on May 10, 2002. No new customers may subscribe to this service. This service will continue to be provided to existing customer(s) until such time as discontinued by the customer, the Company, or the Florida Public Service Commission, or the service can no longer be maintained by the Company

1. General

- a. Digital Centrex is a Centrex-type service provided through a digital central office. It provides the customer with features normally associated with key telephone systems or switchboards.
- b. The service is offered subject to the availability of facilities and provided the customer's serving central office is a digital central office equipped with the necessary software.
- c. The service does not include terminal equipment on the customer's premises. Provision of the telephone instruments or other equipment is the responsibility of the customer.
- d. Directory listings are furnished in accordance with the rates and regulations specified in Section A6 of this tariff.
- e. Service charges as specified in Section A4 of this tariff apply to the services offered in this section.
- f. The minimum service period for Digital Centrex is twelve (12) months unless the term of the agreement is modified in a Contract Service Arrangement or longer term contract.

GENERAL EXCHANGE TARIFF

Embarq Florida, Inc.

By: F. B. Poag  
Director

SECTION A111  
First Revised Sheet 3  
Cancelling Original Sheet 3  
Effective: May 10, 2002

OBSOLETE SERVICE OFFERINGS  
DIGITAL CENTREX SERVICE  
(CENTRAL TELEPHONE EXCHANGES ONLY)

B. DIGITAL CENTREX SERVICE (Cont'd)

1. General (Cont'd)

- g. Contract termination liability for the twelve month minimum service period is such that if a subscriber terminates their Centrex service prior to the expiration of the minimum 12 month service period, the subscriber shall immediately pay a termination liability in the amount of 100% of the monthly charges remaining in the 12 month period.
- h. At the expiration of the 12 month service period, the subscriber's service period will automatically renew for successive periods of 12 months each at the then current tariff rates, unless the subscriber provides written or verbal notice of termination at least thirty (30) days in advance of any scheduled renewal.
- i. Directory Assistance charges as specified in Section A3 of this tariff apply to the services offered in this section.

2. Service Features

- a. The features listed are station or attendant console related. The basic rate includes all features, but the number of features actually used depends upon the customer's operating procedures and the terminal equipment selected. The customer may utilize station features only or both station and attendant console features.

GENERAL EXCHANGE TARIFF

Embarq Florida, Inc.

By: F. B. Poag  
Director

SECTION A111  
First Revised Sheet 4  
Cancelling Original Sheet 4  
Effective: May 10, 2002

OBSOLETE SERVICE OFFERINGS  
DIGITAL CENTREX SERVICE  
(CENTRAL TELEPHONE EXCHANGES ONLY)

B. DIGITAL CENTREX SERVICE (Cont'd)

2. Service Features (Cont'd)

b. Station Features

- 1) Call Forward
  - a) All calls
  - b) Station busy
  - c) No answer
- 2) Call Pickup
- 3) Call Waiting
- 4) Camp-on
- 5) Consultation Hold- Three Parties
- 6) Meet-Me Conference - Six Parties
- 7) Ring Again
- 8) Speed Call
- 9) Station Call Park
- 10) Code Call Access
- 11) Station Controlled Conference - Six Parties
- 12) Three-Way Conference/Transfer
- 13) Paging
- 14) Autodial
- 15) Conference - Six Parties
- 16) Call Transfer
- 17) Call Hold
- 18) Uniform Call Distribution

GENERAL EXCHANGE TARIFF

Embarq Florida, Inc.

By: F. B. Poag  
Director

SECTION A111  
First Revised Sheet 5  
Cancelling Original Sheet 5  
Effective: May 10, 2002

OBSOLETE SERVICE OFFERINGS  
DIGITAL CENTREX SERVICE  
(CENTRAL TELEPHONE EXCHANGES ONLY)

B. DIGITAL CENTREX SERVICE (Cont'd)

2. Service Features (Cont'd)

c. Attendant Features

- 1) Call Park Timer
- 2) Call Selection
- 3) Camp-On
- 4) Console Display
- 5) Control of Trunk Group Access
- 6) Locked Loop Operation
- 7) Release
- 8) Speed Call
- 9) Recorded Announcement
- 10) Automatic Recall
- 11) Busy Verification
- 12) Call Park
- 13) Code Calling
- 14) Console Test
- 15) Delayed Operation
- 16) Interposition Calls and Transfers
- 17) Lockout
- 18) Maintenance and Administration Display
- 19) Multiple Console Operation
- 20) Multiple Listed Directory Numbers
- 21) Position Busy
- 22) Secrecy
- 23) Serial Call
- 24) Straight Forward Outward Completion
- 25) Supervisory Console
- 26) Switched Loop Operation
- 27) Trunk Group Busy



GENERAL EXCHANGE TARIFF

Embarq Florida, Inc.

By: F. B. Poag  
Director

SECTION A111  
First Revised Sheet 6  
Cancelling Original Sheet 6  
Effective: May 10, 2002

OBSOLETE SERVICE OFFERINGS  
DIGITAL CENTREX SERVICE  
(CENTRAL TELEPHONE EXCHANGES ONLY)

B. DIGITAL CENTREX SERVICE (Cont'd)

2. Service Features (Cont'd)

c. Attendant Features (Cont'd)

- 28) Through Dialing
- 29) Timed Recall to Zero
- 30) Trouble Key on Console
- 31) Two Way Splitting

3. Rates and Charges

- a. Digital Centrex lines will be furnished on a per customer premises location basis at the following rates. The monthly rate depends upon the number of lines in service. The monthly rate does not include the Subscriber Line Charge (SLC). The SLC may be calculated using the trunk equivalency table shown following. If the trunk equivalency table is used to calculate the SLC, the number of simultaneous conversations allowed on the system will be the number shown in the equivalent number of trunks column. If the customer elects to use a greater number of trunks, the SLC applies to each additional trunk.

End User Common Line (EUCL) charges for multi-line business subscribers, as described in Section 4 of the Company's Tariff F.C.C. No. 1, will apply.

GENERAL EXCHANGE TARIFF

Embarq Florida, Inc.

By: F. B. Poag  
Director

SECTION A111  
Fifth Revised Sheet 7  
Cancelling Fourth Revised Sheet 7  
Effective: November 1, 2005

OBSOLETE SERVICE OFFERINGS  
DIGITAL CENTREX SERVICE  
(CENTRAL TELEPHONE EXCHANGES ONLY)

B. DIGITAL CENTREX SERVICE (Cont'd)

3. Rates and Charges (Cont'd)

b. Digital Centrex Line Rates

<u>No. Lines</u>	<u>Monthly Rate,*</u> <u>Per Premises Location</u> <u>Per Customer Group</u>
26-50	31.00
51-100	31.00
101-150	31.00
151-200	24.62
201-250	24.12
251-300	23.62
301-500	22.87
501-1,000	21.87
1,001-2,000	19.36
2,001-10,000	15.94
10,001 and up	12.51

\* The tiered rates will be applied on a per customer, per premises, per customer group basis with the applicable rate per line equal to the total number of lines subscribed to. Example: If a customer has 156 Digital Centrex lines and all 156 lines terminate at the same premises and are with the same Digital Centrex customer group, "ALL" 156 lines will be billed at \$24.62. However, if a customer has services at the same premises, but the Digital Centrex lines are terminated in multiple Digital Centrex customer groups, then the Digital Centrex lines will be rated independently based on the total number of lines terminating in each Digital Centrex customer group.

GENERAL EXCHANGE TARIFF

Embarq Florida, Inc.

By: F. B. Poag  
Director

SECTION A111  
First Revised Sheet 8  
Cancelling Original Sheet 8  
Effective: May 10, 2002

OBSOLETE SERVICE OFFERINGS  
DIGITAL CENTREX SERVICE  
(CENTRAL TELEPHONE EXCHANGES ONLY)

B. DIGITAL CENTREX SERVICE (Cont'd)

3. Rates and Charges (Cont'd)

c. Trunk Equivalency Table for Subscriber Line Charge (SLC)/End User Common Line (EUCL) Charge

- 1) The SLC/EUCL is in addition to the monthly rate for the access line. In cases where the number of virtual trunks/paths provided exceeds the number of trunks/paths shown in the table, the customer will be billed based on the actual number of virtual trunks/paths provisioned.

GENERAL EXCHANGE TARIFF

Embarq Florida, Inc.

By: F. B. Poag  
Director

SECTION A111  
First Revised Sheet 9  
Cancelling Original Sheet 9  
Effective: May 10, 2002

OBSOLETE SERVICE OFFERINGS  
DIGITAL CENTREX SERVICE  
(CENTRAL TELEPHONE EXCHANGES ONLY)

B. DIGITAL CENTREX SERVICE (Cont'd)

3. Rates and Charges (Cont'd)

c. Cont'd.

2) Trunk Equivalency Table

<u>Number Of Lines</u>	<u>Equivalent Number of Trunks/Paths</u>	<u>Equivalent Number of SLC/EUCLCharges*</u>
26-28	5	5
29-36	6	6
37-45	7	7
46-54	8	8
55-64	9	9
65-75	10	10
76-86	11	11
87-98	12	12
99-111	13	13
112-125	14	14
126-139	15	15
140-155	16	16
156-171	17	17
172-189	18	18
190-207	19	19
208-225	20	20
226-243	21	21
244-262	22	22
263-281	23	23
282-300	24	24
Each Add'l 15 Lines	+1	+1

\* For rates, see Subscriber Line Charge/End User Common Line Charges in Section 4 of the Company's Tariff F.C.C. No. 3, Volume 1.

GENERAL EXCHANGE TARIFF

Embarq Florida, Inc.

By: F. B. Poag  
Director

SECTION A111  
First Revised Sheet 10  
Cancelling Original Sheet 10  
Effective: May 10, 2002

OBSOLETE SERVICE OFFERINGS  
DIGITAL CENTREX SERVICE  
(CENTRAL TELEPHONE EXCHANGES ONLY)

B. DIGITAL CENTREX SERVICE (Cont'd)

3. Rates and Charges (Cont'd)

d. Centrex Translation Charge

The charge for performing the central office translation associated with configuring a Centrex customer's network parameters.

- 1) Applies to each Centrex customer's request which requires central office translation work defining the customer's network parameters to be established or changed.
- 2) Applies to each Centrex customer group translation activity performed.

Centrex Translation Charge	
Per customer translation request	
Nonrecurring Charge	\$50.00

- 3) Service Ordering Charges as specified in Section A4 of this tariff apply to the services offered in this section and are in addition to the Centrex Translation Charges in this section of the tariff.

e. Feature Changes After Initial Installation

- 1) Per Centrex Line up to a maximum of \$50.00  
Nonrecurring Charge (per line) \$10.00
- 2) For feature changes after the initial installation, the Secondary Service Ordering Charge will apply in addition to applicable nonrecurring charges.

GENERAL EXCHANGE TARIFF

Embarq Florida, Inc.

By: F. B. Poag  
Director

SECTION A111  
First Revised Sheet 11  
Cancelling Original Sheet 11  
Effective: May 10, 2002

OBSOLETE SERVICE OFFERINGS  
DIGITAL CENTREX SERVICE  
(CENTRAL TELEPHONE EXCHANGES ONLY)

C. DIGITAL CENTREX SERVICE - OPTIONAL FEATURES

1. Northern Telecom Business Terminal

- a. This feature allows the customer to utilize the Northern Telecom DMS-100 Business Terminal (telephone). The telephone is equipped with an alpha numeric display and allows push-button access to the customer's choice of various station features.
- b. The rate is for each line equipped and does not include the Northern Telecom Business Terminal. The customer is responsible for providing the Business Terminal.
- c. The Business Terminal line card is not required if the customer does not use the Northern Telecom Business Terminal.
- d. Rates and Charges

Monthly Rate

Business Terminal line card, per line	\$1.50
---------------------------------------	--------

2. Automatic Call Distribution (ACD)

- a. This feature provides incoming call distribution to the next available line. When all lines are busy, the incoming call will be placed in queue, the caller will receive a message explaining that all lines/agents are busy; and when a line become idle, the call will be switched to the available idle line/agent. This feature are offered under the conditions specified in A.1.b. previous.

GENERAL EXCHANGE TARIFF

Embarq Florida, Inc.

By: F. B. Poag  
Director

SECTION A111  
First Revised Sheet 12  
Cancelling Original Sheet 12  
Effective: May 10, 2002

OBSOLETE SERVICE OFFERINGS  
DIGITAL CENTREX SERVICE  
(CENTRAL TELEPHONE EXCHANGES ONLY)

C. DIGITAL CENTREX SERVICE - OPTIONAL FEATURES (Cont'd)

2. Automatic Call Distribution (ACD) (Cont'd)

b. Rates and Charges

	<u>NRC</u>	<u>Monthly Rates</u>
1. ACD per access line equipped	\$ --	\$ 1.50
2. ACD/UCD access port, each* - one required for printer and one required for CRT	\$200.00	47.15
3. Generic Recorded Message, each	150.00	34.10

\*Customer must provide printer or CRT

3. Customer Specific Recorded Announcements

a. In offices equipped with the technology and capacity; digital recorded announcement machines may be utilized to program announcements for use in conjunction with such features as Uniform Call Distribution (UCD) and/or Automatic Call Distribution (ACD). The rate is based on each "one-second" of announcement time and the Company reserves the right to limit the length of the announcement based upon available capacity. The subscriber is responsible for providing the desired announcement phraseology; however, the subscriber shall exclude from the message or announcement any matter the dissemination of which is prohibited by law, including but not limited to any communication which is prohibited by Section 365.161, Florida Statutes.

b. Rates and Charges

	<u>NRC</u>	<u>Monthly Rate</u>
Per Announcement Second	\$ --	\$ 6.04

GENERAL EXCHANGE TARIFF

Embarq Florida, Inc.

By: F. B. Poag  
Director

SECTION A111  
First Revised Sheet 13  
Cancelling Original Sheet 13  
Effective: May 10, 2002

OBSOLETE SERVICE OFFERINGS  
DIGITAL CENTREX SERVICE  
(CENTRAL TELEPHONE EXCHANGES ONLY)

C. DIGITAL CENTREX SERVICE - OPTIONAL FEATURES (Cont'd)

4. Answering Service Identification Forwarding (ASIF)

a. The ASIF feature, primarily used by answering services, provides where facilities are available, an intermediate point in the call forwarding process that identifies the call by forwarding customer's name and delivers the name along with the call to the answering machine.

b. Rates and Charges

	<u>Monthly Rate</u>
ASIF Feature, Per line	\$12.40

5. Enhanced Automatic Call Distribution (ACD)

a. This central office based ACD provides the ACD user with Management Information System (MIS) and Load Management built-in features that provide real-time management information and full ACD operational control. This feature is offered under the conditions specified in A.1.b.

b. Rates and Charges

	<u>NRC</u>	<u>Monthly Rate</u>
1) Enhanced ACD per access line equipped	\$ --	\$ 8.50
2) Access Port (One each required per customer group (See Note following))	200.00	240.00
3) Generic Recorded Announcement, each	150.00	34.10

Note: In addition to an access port, a Private Line facility as provided in Section A20 of this tariff is required.



GENERAL EXCHANGE TARIFF

Embarq Florida, Inc.

By: F. B. Poag  
Director

SECTION A111  
First Revised Sheet 14  
Cancelling Original Sheet 14  
Effective: May 10, 2002

OBSOLETE SERVICE OFFERINGS  
DIGITAL CENTREX SERVICE  
(CENTRAL TELEPHONE EXCHANGES ONLY)

D. DIGITAL CENTREX NETWORK - SPECIAL ACCESS

1. General

- a. This service provides for the interconnection of Special Access and/or Private Line facilities to Digital Centrex for the purpose of interfacing with subscribers to Digital Centrex Service. This service is necessary to complete the communication path between users of Centrex-type service and users of Special Access and/or Private Line services.
- b. This service is furnished subject to the availability of facilities and features from digital central office equipment located in a central office building owned or leased by the Company.
- c. The rates in C.2. following are applicable to each Digital Centrex interconnection. The Special Access and/or Private Line facility is not included in the interconnection charge.

2. Rates and Charges

	<u>NRC</u>	<u>Monthly Rates</u>
a. Voice Grade to Digital Centrex, each channel	\$ 50.00	\$ 53.00
b. DS1 to Digital Centrex, per 24 channels	200.00	315.00
c. DS1 to Digital Centrex to Digital PBX, per 24 channels	300.00	570.00
d. DS1 to Digital Centrex to Analog PBX, per 24 channels (See Note following)	300.00	570.00

Note: When DS1 interface via Digital Centrex to an analog PBX is required, rates for D-4 channel equipment shown in Section A20 of this tariff shall also apply.

GENERAL EXCHANGE TARIFF

Embarq Florida, Inc.

By: F. B. Poag  
Director

SECTION A111  
First Revised Sheet 15  
Cancelling Original Sheet 15  
Effective: May 10, 2002

OBSOLETE SERVICE OFFERINGS  
DIGITAL CENTREX SERVICE  
(CENTRAL TELEPHONE EXCHANGES ONLY)

E. EXPRESSTOUCH CENTREX FEATURES

1. General

ExpressTouch Centrex features are central office call management features offered to Centrex customers in addition to the optional features offered previously in this section of the tariff.

2. Regulations

a. The following regulations apply to the features listed in 3. following:

- 1) ExpressTouch Centrex features are provided subject to the availability of facilities. Additionally, the features described will only operate on call originating and terminating within the Custom Local Area Signaling Services (CLASS) serving areas.
- 2) In no event shall the Company be held liable for any losses or damages arising from the unavailability or failure of its equipment or facilities, or for any act, omission or failure of performance by the Company or its employees or agents in connection with this service.

b. The following regulations apply to the Caller ID feature only, in addition to the regulations listed in a. preceding.

- 1) If an incoming call is from a caller utilizing a PBX trunk or a rotary line group, the telephone number displayed may be the main number of that PBX or rotary group rather than the directory number accessed by the caller.

GENERAL EXCHANGE TARIFF

Embarq Florida, Inc.

By: F. B. Poag  
Director

SECTION A111  
First Revised Sheet 16  
Cancelling Original Sheet 16  
Effective: May 10, 2002

OBSOLETE SERVICE OFFERINGS  
DIGITAL CENTREX SERVICE  
(CENTRAL TELEPHONE EXCHANGES ONLY)

E. EXPRESSTOUCH CENTREX FEATURES (Cont'd)

2. Regulations (Cont'd)

- b. The following regulations apply to the Caller ID feature only, in addition to the regulations listed preceding.
  - 2) The Company will deliver all numbers, subject to the technical limitations defined in this tariff, including telephone numbers associated with Nonpublished Listing Service as described in Section A6 of this tariff.
  - 3) Telephone numbers transmitted via Caller ID are intended solely for the use of the Caller ID subscriber. Resale of this information is prohibited by the tariff.
  - 4) Calling numbers will not be displayed on operator-handled calls, access lines where Calling Number Delivery Blocking has been activated, or with calls originating outside of the CLASS serving area.

3. Features

- a. Repeat Dialing - When activated, Repeat Dialing automatically redials the last number the customer attempted to call. If the called line is not busy, the call will be placed and the caller will be notified with a distinctive ring.
- b. Return Call - Return Call enables a customer to place a call to the telephone number associated with the most recent call received, whether or not the call was answered.
- c. Caller ID - this feature enables the customer to view on a display unit the directory number of an incoming telephone call. The display unit may be an ancillary device which is attached to the customer's telephone set or may be a special telephone set with the display unit built-in. The calling number will display between the first and second ring.
- d. Calling Number Delivery Blocking - This service is provided at no charge to the subscriber. The service will be provided as described in Section A13.

GENERAL EXCHANGE TARIFF

Embarq Florida, Inc.

By: F. B. Poag  
Director

SECTION A111  
First Revised Sheet 17  
Cancelling Original Sheet 17  
Effective: May 10, 2002

OBSOLETE SERVICE OFFERINGS  
DIGITAL CENTREX SERVICE  
(CENTRAL TELEPHONE EXCHANGES ONLY)

E. EXPRESSTOUCH CENTREX FEATURES (Cont'd)

3. Features (Cont'd)

e. Call Tracing

- 1) Call Tracing enables the customer to initiate an automatic trace of the last call received. A usage charge will be assessed on a per-occasion basis for each successful trace made. A trace is considered successful when the customer is informed by the voice response unit that the Call Tracing has been successfully completed. Certain types of calls, i.e., out of the area long distance, cannot be traced using this feature.
- 2) Upon activation by the customer, the call tracing information (calling and called number, the time the call was received, and the time the trace was activated) is recorded and stored until requested by an authorized law enforcement agency. The information collection process is instantaneous and the customer using the feature will be notified immediately if the trace was successful and will then be instructed to contact the local law enforcement agency if they wish to file a complaint. The customer is not provided the traced number.

GENERAL EXCHANGE TARIFF

Embarq Florida, Inc.

By: F. B. Poag  
Director

SECTION A111  
First Revised Sheet 18  
Cancelling Original Sheet 18  
Effective: May 10, 2002

OBSOLETE SERVICE OFFERINGS  
DIGITAL CENTREX SERVICE  
(CENTRAL TELEPHONE EXCHANGES ONLY)

E. EXPRESSTOUCH<sup>SM</sup> CENTREX FEATURES (Cont'd)

3. Features (Cont'd)

e. Call Tracing (Cont'd)

3) If the customer receives another call prior to activating the trace, or receives a Call Waiting indication during the call to be traced, Call Tracing will record the last call, which may not be the call the call trace activation was intended to record.

f. Call Tracing Denial - This service allows the Call Tracing feature to be blocked. To initiate the blocking feature, the customer must contact the Company. The Company will then install the blocking feature on the customer's line. The blocking feature cannot be deactivated by the customer. This feature is provided at no charge to the customer.

4. Rates and Charges

Per Line

Monthly Rates

a. Return Call	\$ 2.50
b. Repeat Dialing	2.00
c. Caller ID	5.50
d. Call Tracing	\$ 4.00 per successful trace

GENERAL EXCHANGE TARIFF

Embarq Florida, Inc.

Section A112

By: F. B. Poag  
Director

Second Revised Contents Sheet 1  
Cancelling First Revised Contents Sheet 1  
Effective: May 29, 1997

OBSOLETE SERVICE OFFERINGS  
CENTREX SERVICE

CONTENTS

A.	CENTREX SERVICE .....	1
1.	Month-to-Month Rates .....	1

GENERAL EXCHANGE TARIFF

Embarq Florida, Inc

By: F. B. Poag  
Director

Section A112  
Second Revised Sheet 1  
Cancelling First Revised Sheet 1  
Effective: May 29, 1997

OBSOLETE SERVICE OFFERINGS  
CENTREX SERVICE

A. CENTREX SERVICE

1. Month-to-Month Rates

All subscribers to the month-to-month rates, as of August 5, 1996, will be grandfathered at the 12-month rates found in Section A12 for their existing services. No new customers may subscribe to these month-to-month rates. These month-to-month rates will continue to be provided to existing customers until such time as discontinued by the customer or until they can no longer be provided by the Company.

GENERAL EXCHANGE TARIFF

Embarq Florida, Inc.

SECTION A113

By: F. B. Poag  
Director

Third Revised Contents Sheet 1  
Cancelling Second Revised Contents Sheet 1  
Effective: December 2, 2003

OBSOLETE SERVICE OFFERINGS  
MISCELLANEOUS SERVICE ARRANGEMENTS

CONTENTS

A.	SPECIAL IDENTITY NUMBER ARRANGEMENT (SINA) (United Telephone exchanges only) .....	1
1.	General .....	1
2.	Rates and Charges.....	2
B.	ADVANTAGE SERVICE (United Telephone exchanges only) .....	2
1.	Application .....	2
2.	Residence Package Descriptions .....	3
3.	Business Package Description .....	4
4.	General .....	4
5.	Rates and Charges .....	5
C.	CUSTOM CALLING SERVICE - PACKAGED FEATURE OFFERINGS (Central Telephone exchanges only) .....	5
1.	General .....	6
2.	Rates and Charges .....	6



GENERAL EXCHANGE TARIFF

Embarq Florida, Inc.

SECTION A113

By: F. B. Poag  
Director

Third Revised Contents Sheet 2  
Cancelling Second Revised Contents Sheet 2  
Effective: December 3, 1999

OBSOLETE SERVICE OFFERINGS  
MISCELLANEOUS SERVICE ARRANGEMENTS

CONTENTS

E. CUSTOMER NAME AND ADDRESS

1. General .....	29
2. Rates and Charges .....	29

F. CUSTOM CALLING SERVICES-PACKAGED FEATURE OFFERINGS

1. General .....	30
2. Rates and Charges .....	30

GENERAL EXCHANGE TARIFF

Embarq Florida, Inc.

By: F. B. Poag  
Director

SECTION A113  
First Revised Sheet 1  
Cancelling Original Sheet 1  
Effective: January 1, 1997

OBSOLETE SERVICE OFFERINGS  
MISCELLANEOUS SERVICE ARRANGEMENTS

A. SPECIAL IDENTITY NUMBER ARRANGEMENT (SINA) (United Telephone exchanges only)

This information formerly appeared in Section A13 and was made obsolete on June 26, 1990. No new customers may subscribe to this service. These services will continue to be provided to existing customers until such time as discontinued by the customer, the Company, or the Florida Public Service Commission or the service can no longer be maintained by the Company.

1. General

- a. A residence single party line subscriber who desires to have incoming calls identified by means of a different ring may arrange for such service, where available, by contracting for a separate telephone number.
- b. A different telephone number is bridged to the access line and may be listed in the alphabetical section of the telephone directory at the rate for an additional listing. Whenever this additional telephone number is dialed, the telephone bell will ring either one long ring or two short rings, whichever is opposite of the ring assigned to the main telephone number. Incoming calls can thereby be identified for adults versus teenagers or husband versus wife.
- c. Subscribers of SINA service shall be responsible for the provision of the proper ring frequency in their premises equipment.

GENERAL EXCHANGE TARIFF

Embarq Florida, Inc.

By: F. B. Poag  
Director

SECTION A113  
First Revised Sheet 2  
Cancelling Original Sheet 2  
Effective: January 1, 1997

OBSOLETE SERVICE OFFERINGS  
MISCELLANEOUS SERVICE ARRANGEMENTS

A. SPECIAL IDENTITY NUMBER ARRANGEMENT (SINA) (United Telephone exchanges only)  
(Cont'd)

2. Rates and Charges

Monthly Rate

a. Special Identity Number Arrangement  
(SINA)

\$1.10

b. A secondary service order charge will apply in those instances when the service is requested after the initial installation.

B. ADVANTAGE SERVICE (United Telephone exchanges only)

This information formerly appeared in Section A13 and became obsolete on the July 19, 1995. No new customers may subscribe to these services. These services will continue to be provided to existing customers until such time as discontinued by the customer, the Company, or the Florida Public Service Commission or until the service can no longer be provided by the Company.

1. Application

a. Advantage Service is an offering which combines certain Custom Calling, ExpressTouch, and SignalRing Feature options into packages at rates which provide a monthly savings over the rates that would apply if the features were purchased individually.

b. The packaged features are those offered individually in Section A13 of this tariff. All descriptions, rules and regulations specified in those sections apply to these packages also.

GENERAL EXCHANGE TARIFF

Embarq Florida, Inc.

By: F. B. Poag  
Director

SECTION A113  
First Revised Sheet 3  
Cancelling Original Sheet 3  
Effective: January 1, 1997

OBSOLETE SERVICE OFFERINGS  
MISCELLANEOUS SERVICE ARRANGEMENTS

B. ADVANTAGE SERVICE (United Telephone exchanges only) (Cont'd)

2. Residence Package Descriptions

a. Basic Advantage - contains the following features:

- 1) Call Waiting
- 2) Cancel Call Waiting
- 3) Three-Way Calling

b. Enhanced Advantage - contains the following features:

- 1) Call Waiting
- 2) Cancel Call Waiting
- 3) Three-Way Calling
- 4) Call Forwarding

c. Preferred advantage - contains the following features:

- 1) Call Waiting
- 2) Cancel Call Waiting
- 3) Three-Way Calling
- 4) And a choice of:
  - a) Call Return
  - b) Call Block
  - c) Repeat Dialing
  - d) SignalRing I

GENERAL EXCHANGE TARIFF

Embarq Florida, Inc.

By: F. B. Poag  
Director

SECTION A113  
First Revised Sheet 4  
Cancelling Original Sheet 4  
Effective: January 1, 1997

OBSOLETE SERVICE OFFERINGS  
MISCELLANEOUS SERVICE ARRANGEMENTS

B. ADVANTAGE SERVICE (United Telephone exchanges only) (Cont'd)

2. Residence Package Descriptions

d. Deluxe Advantage - contains the following features:

- 1) Call Waiting
- 2) Cancel Call Waiting
- 3) Three-Way Calling
- 4) Call Return
- 5) Call Block
- 6) Repeat Dial

3. Business Package Description

a. Enhanced Advantage - contains the following features:

- 1) Call Waiting
- 2) Cancel Call Waiting
- 3) Three-Way Calling
- 4) Call Forwarding

4. General

- a. The definitions, rules and regulations of the individual features in each package are as specified in Section A13 of this tariff.

GENERAL EXCHANGE TARIFF

Embarq Florida, Inc.

BY: F. B. Poag  
Director

SECTION A113  
Ninth Revised Sheet 5  
Cancelling Eighth Revised Sheet 5  
Effective: November 12, 2004

OBSOLETE SERVICE OFFERINGS  
MISCELLANEOUS SERVICE ARRANGEMENTS

B. ADVANTAGE SERVICE (United Telephone exchanges only) (Cont'd)

5. Rates and Charges

a. Package Rates - Residence

	<u>Monthly Rate</u>
1) Basic Advantage	\$12.00
2) Enhanced Advantage	14.50
3) Preferred Advantage	17.00
4) Deluxe Advantage	17.00

b. Package Rates – Business

1) Enhanced Advantage	15.50
-----------------------	-------

C. CUSTOM CALLING SERVICES-PACKAGED FEATURE OFFERINGS (Central Telephone exchanges only)

The following information formerly appeared in Section A13 and became obsolete on July 19, 1995. No new customers may subscribe to these services. These services will be provided to existing customers until such time as discontinued by the customer, the Company, or the Florida Public Service Commission or until the service can no longer be provided by the Company.

GENERAL EXCHANGE TARIFF

Embarq Florida, Inc.

By: F. B. Poag  
Director

SECTION A113  
Eighth Revised Sheet 6  
Cancelling Seventh Revised Sheet 6  
Effective: November 12, 2004

OBSOLETE SERVICE OFFERINGS  
MISCELLANEOUS SERVICE ARRANGEMENTS

C. CUSTOM CALLING SERVICES-PACKAGED FEATURE OFFERINGS (Central Telephone exchanges only)

1. General

a. Teen Talk Packages, Basic and Premium

The Basic and Premium Teen Talk package offerings must be associated with a second residential line located on the same premises as the primary residential service. In addition, charges for the Teen Talk package and the associated second line must be billed on the same account as the primary service.

2. Rates

	<u>Monthly Rates</u>	
	<u>Residential</u>	<u>Business</u>
a. IN TOUCH Package Enhanced Call Waiting Return Call, Speed Call 8	\$17.00	\$13.00
b. IN TOUCH PLUS Package Enhanced Call Waiting Call Forward Caller ID, Speed Call 8	\$21.50	\$21.50
c. CALL MANAGER Package Enhanced Call Waiting Call Forward Return Call, Redial Call	\$17.00	\$16.50

GENERAL EXCHANGE TARIFF

Embarq Florida, Inc.

By: F. B. Poag  
Director

SECTION A113  
Seventh Revised Sheet 7  
Cancelling Sixth Revised Sheet 7  
Effective: October 24, 2003

OBSOLETE SERVICE OFFERINGS  
MISCELLANEOUS SERVICE ARRANGEMENTS

C. CUSTOM CALLING SERVICES-PACKAGED FEATURE OFFERINGS (Central Telephone exchanges only) (Cont'd)

2. Rates (Cont'd)

		<u>Monthly Rates</u>	
		<u>Residential</u>	<u>Business</u>
d.	CALL MANAGER PLUS Package Enhanced Call Waiting Call Forward Return Call, Redial Call Caller ID, Speed Call 8	\$23.00	\$23.00
e.	ADVANTAGE Package Enhanced Call Waiting Call Forward, Return Call Redial Call, Caller ID Speed Call 8 Three Way Calling Distinctive Ringing Call Screening	25.00	25.00
f.	Call Forwarding, Three-Way Calling, Call Waiting and Speed Calling (8 code)	12.00	14.00
g.	Call Forwarding, Call Waiting and Speed Calling (8 code)	12.00	12.00
h.	Call Forwarding, Call Waiting, Three Way Calling	12.00	9.49
i.	Call Forwarding Call Waiting	7.99	11.00



GENERAL EXCHANGE TARIFF

Embarq Florida, Inc.

By: F. B. Poag  
Director

SECTION A113  
Seventh Revised Sheet 8  
Cancelling Sixth Revised Sheet 8  
Effective: October 24, 2003

OBSOLETE SERVICE OFFERINGS  
MISCELLANEOUS SERVICE ARRANGEMENTS

C. CUSTOM CALLING SERVICES-PACKAGED FEATURE OFFERINGS (Central Telephone exchanges only) (Cont'd)

2. Rates (Cont'd)

		<u>Monthly Rates</u>	
		<u>Residential</u>	<u>Business</u>
j.	Call Forwarding, Three Way Calling, Enhanced Call Waiting, Speed Calling(8)	\$12.00	\$10.99
k.	Call Forwarding, Enhanced Call Waiting, Speed Calling (8)	11.00	9.49
l.	Call Forwarding, Enhanced Call Waiting, Three Way Calling	11.00	10.99
m.	Call Forwarding, Enhanced Call Waiting	12.00	9.49
n.	Call Forwarding, Three Way Calling, Enhanced Call Waiting, Call Forward/Busy-No Answer, Speed Calling(8)	12.00	12.49
o.	Call Forwarding, Enhanced Call Waiting, Call Forward/Busy-No Answer, Speed Calling (8)	11.00	10.99
p.	Call Forwarding, Enhanced Call Waiting, Call Forward/Busy-No Answer, Three Way Calling	12.00	14.50

GENERAL EXCHANGE TARIFF

Embarq Florida, Inc.

SECTION A113

Eight Revised Sheet 9

By: F. B. Poag  
Director

Cancelling Seventh Revised Sheet 9  
Effective: November 12, 2004

OBSOLETE SERVICE OFFERINGS  
MISCELLANEOUS SERVICE ARRANGEMENTS

C. CUSTOM CALLING SERVICES-PACKAGED FEATURE OFFERINGS (Central Telephone exchanges only)

2. Rates (Cont'd)

		<u>Monthly Rates</u>	
		<u>Residential</u>	<u>Business</u>
q.	Call Forwarding, Enhanced Call Waiting, Call Forward/Busy-No Answer	\$12.00	\$10.99
r.	Reserved for Future Use		
s.	Distinctive Ringing, Call Screening	10.50	9.00
t.	BASIC TEEN TALK Package Call Waiting, Three-Way Calling	10.50	
u.	PREMIUM TEEN TALK Package Call Forwarding/Busy-No Answer, Three-Way Calling, Enhanced Call Waiting	6.99	

GENERAL EXCHANGE TARIFF

Embarq Florida, Inc.

By: F. B. Poag  
Director

SECTION A113  
Third Revised Sheet 10  
Cancelling Second Revised Sheet 10  
Effective: May 03, 2003

OBSOLETE SERVICE OFFERINGS  
MISCELLANEOUS SERVICE ARRANGEMENTS

RESERVED FOR FUTURE USE

GENERAL EXCHANGE TARIFF

Embarq Florida, Inc.

By: F. B. Poag  
Director

SECTION A113  
Fourth Revised Sheet 11  
Cancelling Third Revised Sheet 11  
Effective: May 03, 2003

OBSOLETE SERVICE OFFERINGS  
MISCELLANEOUS SERVICE ARRANGEMENTS

RESERVED FOR FUTURE USE

GENERAL EXCHANGE TARIFF

Embarq Florida, Inc.

By: F. B. Poag  
Director

SECTION A113  
Third Revised Sheet 12  
Cancelling Second Revised Sheet 12  
Effective: May 03, 2003

OBSOLETE SERVICE OFFERINGS  
MISCELLANEOUS SERVICE ARRANGEMENTS

RESERVED FOR FUTURE USE

GENERAL EXCHANGE TARIFF

Embarq Florida, Inc.

By: F. B. Poag  
Director

SECTION A113  
Fourth Revised Sheet 13  
Cancelling Third Revised Sheet 13  
Effective: May 03, 2003

OBSOLETE SERVICE OFFERINGS  
MISCELLANEOUS SERVICE ARRANGEMENTS

RESERVED FOR FUTURE USE

GENERAL EXCHANGE TARIFF

Embarq Florida, Inc.

By: F. B. Poag  
Director

SECTION A113  
Third Revised Sheet 14  
Cancelling Second Revised Sheet 14  
Effective: May 03, 2003

OBSOLETE SERVICE OFFERINGS  
MISCELLANEOUS SERVICE ARRANGEMENTS

RESERVED FOR FUTURE USE

GENERAL EXCHANGE TARIFF

Embarq Florida, Inc.

By: F. B. Poag  
Director

SECTION A113  
Third Revised Sheet 15  
Cancelling Second Revised Sheet 15  
Effective: May 03, 2003

OBSOLETE SERVICE OFFERINGS  
MISCELLANEOUS SERVICE ARRANGEMENTS

RESERVED FOR FUTURE USE



GENERAL EXCHANGE TARIFF

Embarq Florida, Inc.

By: F. B. Poag  
Director

SECTION A113  
Third Revised Sheet 16  
Cancelling Second Revised Sheet 16  
Effective: May 03, 2003

OBSOLETE SERVICE OFFERINGS  
MISCELLANEOUS SERVICE ARRANGEMENTS

RESERVED FOR FUTURE USE

GENERAL EXCHANGE TARIFF

Embarq Florida, Inc.

By: F. B. Poag  
Director

SECTION A113  
Third Revised Sheet 17  
Cancelling Second Revised Sheet 17  
Effective: May 03, 2003

OBSOLETE SERVICE OFFERINGS  
MISCELLANEOUS SERVICE ARRANGEMENTS

RESERVED FOR FUTURE USE

GENERAL EXCHANGE TARIFF

Embarq Florida, Inc.

By: F. B. Poag  
Director

SECTION A113  
Third Revised Sheet 18  
Cancelling Second Revised Sheet 18  
Effective: May 03, 2003

OBSOLETE SERVICE OFFERINGS  
MISCELLANEOUS SERVICE ARRANGEMENTS

RESERVED FOR FUTURE USE

GENERAL EXCHANGE TARIFF

Embarq Florida, Inc.

By: F. B. Poag  
Director

SECTION A113  
Third Revised Sheet 19  
Cancelling Second Revised Sheet 19  
Effective: May 03, 2003

OBSOLETE SERVICE OFFERINGS  
MISCELLANEOUS SERVICE ARRANGEMENTS

RESERVED FOR FUTURE USE

GENERAL EXCHANGE TARIFF

Embarq Florida, Inc.

By: F. B. Poag  
Director

SECTION A113  
Third Revised Sheet 20  
Cancelling Second Revised Sheet 20  
Effective: May 03, 2003

OBSOLETE SERVICE OFFERINGS  
MISCELLANEOUS SERVICE ARRANGEMENTS

RESERVED FOR FUTURE USE

GENERAL EXCHANGE TARIFF

Embarq Florida, Inc.

By: F. B. Poag  
Director

SECTION A113  
Third Revised Sheet 21  
Cancelling Second Revised Sheet 21  
Effective: May 03, 2003

OBSOLETE SERVICE OFFERINGS  
MISCELLANEOUS SERVICE ARRANGEMENTS

RESERVED FOR FUTURE USE

GENERAL EXCHANGE TARIFF

Embarq Florida, Inc.

By: F. B. Poag  
Director

SECTION A113  
Third Revised Sheet 22  
Cancelling Second Revised Sheet 22  
Effective: May 03, 2003

OBSOLETE SERVICE OFFERINGS  
MISCELLANEOUS SERVICE ARRANGEMENTS

RESERVED FOR FUTURE USE

GENERAL EXCHANGE TARIFF

Embarq Florida, Inc.

By: F. B. Poag  
Director

SECTION A113  
Third Revised Sheet 23  
Cancelling Second Revised Sheet 23  
Effective: May 03, 2003

OBSOLETE SERVICE OFFERINGS  
MISCELLANEOUS SERVICE ARRANGEMENTS

RESERVED FOR FUTURE USE



GENERAL EXCHANGE TARIFF

Embarq Florida, Inc.

By: F. B. Poag  
Director

SECTION A113  
Third Revised Sheet 24  
Cancelling Second Revised Sheet 24  
Effective: May 03, 2003

OBSOLETE SERVICE OFFERINGS  
MISCELLANEOUS SERVICE ARRANGEMENTS

RESERVED FOR FUTURE USE

GENERAL EXCHANGE TARIFF

Embarq Florida, Inc.

By: F. B. Poag  
Director

SECTION A113  
Fourth Revised Sheet 25  
Cancelling Third Revised Sheet 25  
Effective: May 03, 2003

OBSOLETE SERVICE OFFERINGS  
MISCELLANEOUS SERVICE ARRANGEMENTS

RESERVED FOR FUTURE USE

GENERAL EXCHANGE TARIFF

Embarq Florida, Inc.

By: F. B. Poag  
Director

SECTION A113  
Third Revised Sheet 26  
Cancelling Second Revised Sheet 26  
Effective: May 03, 2003

OBSOLETE SERVICE OFFERINGS  
MISCELLANEOUS SERVICE ARRANGEMENTS

RESERVED FOR FUTURE USE

GENERAL EXCHANGE TARIFF

Embarq Florida, Inc.

By: F. B. Poag  
Director

SECTION A113  
Third Revised Sheet 27  
Cancelling Second Revised Sheet 27  
Effective: May 03, 2003

OBSOLETE SERVICE OFFERINGS  
MISCELLANEOUS SERVICE ARRANGEMENTS

RESERVED FOR FUTURE USE

GENERAL EXCHANGE TARIFF

Embarq Florida, Inc.

By: F. B. Poag  
Director

SECTION A113  
Third Revised Sheet 28  
Cancelling Second Revised Sheet 28  
Effective: May 03, 2003

OBSOLETE SERVICE OFFERINGS  
MISCELLANEOUS SERVICE ARRANGEMENTS

RESERVED FOR FUTURE USE

GENERAL EXCHANGE TARIFF

Embarq Florida, Inc.

By: F. B. Poag  
Director

SECTION A113  
First Revised Sheet 29  
Cancelling Original Sheet 29  
Effective: June 5, 1998

OBSOLETE SERVICE OFFERINGS  
MISCELLANEOUS SERVICE ARRANGEMENTS

E. CUSTOMER NAME AND ADDRESS (CNA)

1. General

- a. Customer Name and Address (CNA) is a directory assistance service which provides a subscriber with the name and/or address, based on a subscriber provided telephone number.
- b. Information regarding nonpublished and nonlisted telephone service will not be provided via Customer Name and Address service.
- c. The Telephone Company assumes no responsibility or liability for any errors in the information furnished. The caller shall indemnify the Telephone Company and hold it free and harmless of and from any and all claims, demands or damages that shall arise from the use of the service.
  - 1) This service is furnished solely for the telephone calling purposes of the caller.
  - 2) Additional provisions concerning limitations of liability and allowance for interruption of service are set forth in Section A2 of this Tariff.
- d. A maximum of two requests will be allowed per call.
- e. Charges will not apply to calls placed from pay telephone service, hotel/hospital message rate trunk lines, or to calls placed by customers who have been certified as visually or physically handicapped.
- f. Information provided by Customer Name and Address is limited to the Embarq Florida, Inc., directory assistance database.
- g. CNA will be furnished only where facilities permit.

2. Rates and Charges

- a. Customer Name and Address Rate, per Call (Maximum of two requests per call) \$ .45

GENERAL EXCHANGE TARIFF

Embarq Florida, Inc.

By: F. B. Poag  
Director

SECTION A113  
Fifth Revised Sheet 30  
Cancelling Fourth Revised Sheet 30  
Effective: February 16, 2006

OBSOLETE SERVICE OFFERINGS  
MISCELLANEOUS SERVICE ARRANGEMENTS

G. CUSTOM CALLING SERVICES-PACKAGED FEATURE OFFERINGS

This information formerly appeared in Section A13. No new customers may subscribe to this service. This service will continue to be provided to existing customers until such time as discontinued by the customer, the Company, or the Florida Public Service Commission or the service can no longer be maintained by the Company.

3. General

a. Package Descriptions:

(1) Package 4 includes:

Enhanced Call Waiting  
Return Call  
Caller ID With Name (including Anonymous Call Rejection)\*  
Call Waiting ID\*  
Call Forward-Busy-Fixed  
Call Forward-Don't Answer-Fixed

(2) Package 7 includes:

Enhanced Call Waiting  
Three-Way Calling  
Return Call  
Repeat Dialing  
Call Forwarding  
Selective Call Rejection  
Caller ID With Name(including Anonymous Call Rejection)\*  
Call Waiting ID\*  
Call Waiting Options  
Call Forward Busy-Fixed  
Call Forward No Answer-Fixed

4. Rates and Charges

Feature, per month	<u>Residential</u>	<u>Business</u>
Package 4	\$21.50	\$21.50
Package 7	20.00	22.00

\* These features provided on a "where available" basis as a part of these packages.

GENERAL EXCHANGE TARIFF

Embarq Florida, Inc.

SECTION A114

By: F. B. Poag  
Director

Second Revised Contents Sheet 1  
Cancelling First Revised Sheet 1  
Effective: December 1, 1997

OBSOLETE SERVICE OFFERINGS-  
AUXILIARY EQUIPMENT

CONTENTS

A.	TELECOMMUNICATIONS DEVICES (TDDs), HANDSETS AND SIGNALING EQUIPMENT FOR THE HEARING IMPAIRED (United Telephone exchanges only) .....	1
1.	General .....	1
2.	Rates and Charges.....	2
B.	TELECOMMUNICATIONS DEVICES FOR PERSONS WITH HEARING IMPAIRMENT (Central Telephone exchanges only) .....	3
1.	Lease of Equipment.....	3
1.	Sale of Equipment .....	4
2.	Lease of Equipment.....	4



GENERAL EXCHANGE TARIFF

Embarq Florida, Inc.

By: F. B. Poag  
Director

SECTION A114  
First Revised Sheet 1  
Cancelling Original Sheet 1  
Effective: January 1, 1997

OBSOLETE SERVICE OFFERINGS-  
AUXILIARY EQUIPMENT

A. TELECOMMUNICATIONS DEVICES (TDDS), HANDSETS AND SIGNALING EQUIPMENT FOR  
THE HEARING IMPAIRED

The following information formerly appeared in Section A14 and was made obsolete July 1, 1996. These services will be provided to existing customers until changed or discontinued by the customer or the Company.

1. General

- a. with maintenance provided on a per occasion basis - the customer pays only a recurring monthly lease rate. The customer pays applicable charges for maintenance service on a per occasion basis.

GENERAL EXCHANGE TARIFF

Embarq Florida, Inc.

By: F. B. Poag  
Director

SECTION A114  
Second Revised Sheet 2  
Cancelling First Revised Sheet 2  
Effective: December 2, 2003

OBSOLETE SERVICE OFFERINGS-  
AUXILIARY EQUIPMENT

A. TELECOMMUNICATIONS DEVICES (TDDS), HANDSETS AND SIGNALING EQUIPMENT FOR  
THE HEARING IMPAIRED (Cont'd)

2. Rates and Charges

a. Telecommunications Devices (TDDs)

1. SSI-220 Printer/Display - A portable unit with 20-character thermal printer/display, call status indicator and rechargeable Ni-Cad Battery.

Purchase Price*	Installment Plan*				Lease With/Without Maintenance	
	12 Months	24 Months	36 Months	48 Months		
\$492.89	49.41	24.71	16.47	12.36	29.61	18.46
					48 Months	Lease Without Maintenance
					b. \$ .67	.98
					c. .42	.62
					d. .08	.10
					e. 1.39	2.07

b. Accessories for Hearing Impaired Equipment

Vu Phone Carrying Case - for the Basic  
or Fully Optional Unit. Constructed of  
Lightweight Vinyl

Purchase  
Price  
\$38.12

\*Plus applicable sales tax.

GENERAL EXCHANGE TARIFF

Embarq Florida, Inc.

By: F. B. Poag  
Director

SECTION A114  
Second Revised Sheet 3  
Cancelling First Revised Sheet 3  
Effective: May 29, 1997

OBSOLETE SERVICE OFFERINGS-  
AUXILIARY EQUIPMENT

B. TELECOMMUNICATIONS DEVICES FOR PERSONS WITH HEARING IMPAIRMENTS (Central Telephone exchanges only)

This equipment unit is obsolete and no longer obtainable. Existing customers' service under this offering will continue until service is removed or the customer changes units.

1. Lease of Equipment

	<u>Monthly Rate With Maintenance</u>	<u>Monthly Rate Without Maintenance</u>
SSI-100 TDD	\$17.95	\$12.05

The following information formerly appeared in Section 14 and was made obsolete July 1, 1996. These services will be provided to existing customers until changed or discontinued by the customer or the Company.

1. Sale of Equipment

	<u>Sale Price Includes Sales Tax</u>	<u>Number of Installments</u>	<u>Monthly Payment</u>
PortaView Jr.	\$427.93	36	\$ 16.70
Ac Adapter/Charger	22.50	12	2.10

GENERAL EXCHANGE TARIFF

Embarq Florida, Inc.

By: F. B. Poag  
Director

SECTION A114  
First Revised Sheet 4  
Cancelling Original Sheet 4  
Effective: January 1, 1997

OBSOLETE SERVICE OFFERINGS-  
AUXILIARY EQUIPMENT

B. TELECOMMUNICATIONS DEVICES FOR PERSONS WITH HEARING IMPAIRMENTS (Central Telephone exchanges only)

2. Lease of Equipment

	<u>Monthly Rate With Maintenance</u>	<u>Monthly Rate Without Maintenance</u>
PortaView Jr.	\$12.23	\$ 8.62
AC Adapter Charger	*	1.76
Ring Alert	2.55	
Amplified Handset		1.01
Tone Ringer		2.75

\*Maintenance is not available, must be replaced.

GENERAL EXCHANGE TARIFF

Embarq Florida, Inc.

SECTION A115

By: F. B. Poag  
Director

Second Revised Contents Sheet 1  
Cancelling First Revised Sheet 1  
Effective: December 1, 1997

OBSOLETE SERVICE OFFERINGS-  
CONNECTIONS WITH CERTAIN FACILITIES AND/OR EQUIPMENT OF OTHERS

CONTENTS

A.	WIRED MUSIC SYSTEMS (Central Telephone exchanges only .....	1
	1. General .....	2
	2. Rates and Charges.....	2

GENERAL EXCHANGE TARIFF

Embarq Florida, Inc.

By: F. B. Poag  
Director

SECTION A115  
First Revised Sheet 1  
Cancelling Original Sheet 1  
Effective: January 1, 1997

OBSOLETE SERVICE OFFERINGS-  
CONNECTIONS WITH CERTAIN FACILITIES AND/OR EQUIPMENT OF OTHERS

A. WIRED MUSIC SYSTEMS (Central Telephone exchanges only)

1. General

- a. Channels within an exchange are provided for use by connecting wired music companies subject to the regulations contained in Section 15 and the monthly rates and charges and conditions as follows.
- b. Wired music service provided under the provisions of this tariff will not be provided to customers having systems in the same exchange under the provisions of Section A20 of this tariff unless such service is disconnected for billing and billed thereafter entirely as provided herein.
- c. Where for the purpose of furnishing wired music to a location, it is necessary to lay conduit, duct, molding, and terminal boxes on customers' premises, the customer shall provide, install, and maintain all such fixtures.
- d. Premises shall include space occupied by a customer or authorized user in a single building or in connecting buildings not separated by a public highway.

GENERAL EXCHANGE TARIFF

Embarq Florida, Inc.

By: F. B. Poag  
Director

SECTION A115  
Second Revised Sheet 2  
Cancelling First Revised Sheet 2  
Effective: June 1, 2002

OBSOLETE SERVICE OFFERINGS-  
CONNECTIONS WITH CERTAIN FACILITIES AND/OR EQUIPMENT OF OTHERS

A. WIRED MUSIC SYSTEMS (Central Telephone exchanges only)

2. Rates and Charges

	Nonrecurring <u>Charge</u>	Monthly <u>Rate</u>
a. Patron main terminations, each (See Note)	\$10.00	\$4.20

Note: In addition, the zone, or mileage charge for individual line service as covered in the General Exchange Tariff is applicable for each patron termination which extends beyond the base rate area boundary.

c. Studio channel, each

A mileage charge of \$1.30 per 1/4 airline mile or fraction thereof is applicable for that portion of each channel from the studio to the serving central office which exceeds one airline mile.

GENERAL EXCHANGE TARIFF

Embarq Florida, Inc.

By: F. B. Poag  
Director

SECTION A115  
First Revised Sheet 3  
Cancelling Original Sheet 3  
Effective: January 1, 1997

OBSOLETE SERVICE OFFERINGS-  
CONNECTIONS WITH CERTAIN FACILITIES AND/OR EQUIPMENT OF OTHERS

A. WIRED MUSIC SYSTEMS (Central Telephone exchanges only)

2. Rates and Charges

d. Equalization

- 1) Equalization is done by the Company only at the request of the customer. Charges for equalization are in addition to charges applicable for channels.
- 2) Each two-point service or each section of a network service, i.e., studio channel inter-office channel, or patron channel.

	<u>Nonrecurring Charge</u>	<u>Monthly Rate</u>
a) Approximately 100-5,000 Hertz	\$15.00	\$3.05
b) Approximately 50-8,000 Hertz	15.00	3.15
c) Approximately 50-15,000 Hertz	15.00	4.20



GENERAL EXCHANGE TARIFF

Embarq Florida, Inc.

By: F. B. Poag  
Director

SECTION A116  
Second Revised Contents Sheet 1  
Cancelling First Revised Sheet 1  
Effective: December 1, 1997

OBSOLETE SERVICE OFFERINGS-  
DATA SERVICE

CONTENTS

A.	LOCAL DATA TRANSMISSION SERVICE.....	1
	1. General.....	1
	2. Rates and Charges.....	4

GENERAL EXCHANGE TARIFF

Embarq Florida, Inc.

By: F. B. Poag  
Director

SECTION A116  
First Revised Sheet 1  
Cancelling Original Sheet 1  
Effective: January 1, 1997

OBSOLETE SERVICE OFFERINGS-  
DATA SERVICE

A. LOCAL DATA TRANSMISSION SERVICE

1. General

- a. Local Data Transmission Service provides the data channel facilities between a customer's premises and a central office or between two central offices to provide access to the Company's switched data services or to other composite data services.
- b. Channel services provided under this tariff are for local intraLATA use only and may not be used in connection with Switched Access Service offered under the Access Services Tariff.
- c. The regulations and charges in the tariff section are in addition to applicable regulations and charges shown in other sections of this tariff.
- d. Local Data Transmission Service may be provided using either analog voice-grade or digital channels and is intended to be used with Company switched data services or composite data services provided by other vendors.
- e. These services are provided on an individual element basis in contrast to the local private line services specified in Section A20 of this tariff which are offered on an end-to-end basis.

GENERAL EXCHANGE TARIFF

Embarq Florida, Inc.

By: F. B. Poag  
Director

SECTION A116  
First Revised Sheet 2  
Cancelling Original Sheet 2  
Effective: January 1, 1997

OBSOLETE SERVICE OFFERINGS-  
DATA SERVICE

A. LOCAL DATA TRANSMISSION SERVICE

1. General (Cont'd)

- f. Local Data Transmission Service includes the channel facilities only. Data terminal equipment on the customer's premises, if required, is provided by the customer.
- g. Data termination equipment in the central office will be provided by the Company.
  - 1) The Company will specify the type and manufacturer of the central office equipment.
  - 2) The customer's premises terminal equipment must be compatible with the company's central office equipment.
  - 3) The Company reserves the right to change its equipment if availability, price or technological changes make such a change advisable.
  - 4) The company will notify the customer a minimum of six months in advance of a change in its central office equipment.

GENERAL EXCHANGE TARIFF

Embarq Florida, Inc.

By: F. B. Poag  
Director

SECTION A116  
First Revised Sheet 3  
Cancelling Original Sheet 3  
Effective: January 1, 1997

OBSOLETE SERVICE OFFERINGS-  
DATA SERVICE

A. LOCAL DATA TRANSMISSION SERVICE

1. General (Cont'd)

g. Cont'd.

- 5) The customer is responsible for the installation, maintenance and testing of customer provided terminal equipment.
- 6) Joint testing, if required, will be done on a date mutually agreed upon by the customer and the Company.
- 7) Digital access channels are provided only from those central offices equipped for digital access.
- 8) Service Connection Charges specified in this section are in lieu of the Service Charges specified in Section A4 of this tariff except when noted.
- 9) A Trouble Location Charge will apply if the Company dispatches a repair technician to the customer's premises and the trouble is found to be in the customer's terminal equipment.
- 10) Local Data Transmission Service is provided for a minimum period of one month.

GENERAL EXCHANGE TARIFF

Embarq Florida, Inc.

By: F. B. Poag  
Director

SECTION A116  
First Revised Sheet 4  
Cancelling Original Sheet 4  
Effective: January 1, 1997

OBSOLETE SERVICE OFFERINGS-  
DATA SERVICE

A. LOCAL DATA TRANSMISSION SERVICE

2. Rates and Charges

a. Analog Channel

- 1) Customer is located in the same serving wire center as the Node Channel Termination

	<u>Nonrecurring Charge</u>	<u>Monthly Rate</u>
a) Local Channel Termination	\$25.00	\$ 2.90
b) Local Channel Mileage, per channel, first mile or fraction thereof	--	13.20
c) Each additional 1/4 mile or fraction thereof	--	2.90
d) Node Channel Termination, per channel	25.00	26.75
e) Analog Bridge		
(1) Bridge Common Equipment, main circuit	375.00	60.80
(2) Bridge, per leg off main circuit	50.00	11.60

GENERAL EXCHANGE TARIFF

Embarq Florida, Inc.

By: F. B. Poag  
Director

SECTION A116  
Fourth Revised Sheet 5  
Cancelling Third Revised Sheet 5  
Effective: April 13, 2003

OBSOLETE SERVICE OFFERINGS-  
DATA SERVICE

A. LOCAL DATA TRANSMISSION SERVICE (Central Telephone exchanges only)

2. Rates and Charges (Cont'd)

a. Analog Channel (Cont'd)

- 2) Customer is not located in the same serving wire center as the Node Channel termination. Interoffice mileage applies in addition to the charges specified in a) through d) preceding.

	Monthly <u>Rate</u>
a) Interoffice mileage, per channel, per 1/4 mile or fraction thereof	\$2.50

GENERAL EXCHANGE TARIFF

Embarq Florida, Inc.

By: F. B. Poag  
Director

SECTION A116  
First Revised Sheet 6  
Cancelling Original Sheet 6  
Effective: January 1, 1997

OBSOLETE SERVICE OFFERINGS-  
DATA SERVICE

A. LOCAL DATA TRANSMISSION SERVICE (Central Telephone exchanges only)

2. Rates and Charges (Cont'd)

b. Digital Channel

1) Customer is located in the same serving wire center as the Node Termination

	<u>Nonrecurring Charge</u>	<u>Monthly Rate</u>
a) Local Channel Mileage, per channel, first mile or fraction thereof	--	\$13.20
b) Each additional 1/4 mile or fraction thereof	--	2.90
c) Node Channel Termination, per channel	\$25.00	26.75
d) Digital bridge, per card (1 port in - 4 ports out)	200.00	95.65

GENERAL EXCHANGE TARIFF

Embarq Florida, Inc.

By: F. B. Poag  
Director

SECTION A116  
Second Revised Sheet 7  
Cancelling First Revised Sheet 7  
Effective: May 29, 1997

OBSOLETE SERVICE OFFERINGS-  
DATA SERVICE

A. LOCAL DATA TRANSMISSION SERVICE (Central Telephone exchanges only)

2. Rates and Charges (Cont'd)

b. Digital Channel

- 2) Customer is not located in the same serving wire center as the Node Channel Termination. Charges are in addition to those shown in a), b) and c) preceding.

	<u>Nonrecurring Charge</u>	<u>Monthly Rate</u>
a) Interoffice Channel Mileage, per channel, per mile		\$ 2.60
b) Serving Wire Center Termination, per channel	\$25.00	26.75



GENERAL EXCHANGE TARIFF

Embarq Florida, Inc.

By: F. B. Poag  
Director

Section A118  
First Revised Sheet 1  
Cancelling Original Sheet 1  
Effective: June 5, 1998

OBSOLETE SERVICE OFFERINGS  
LONG DISTANCE MESSAGE TELECOMMUNICATIONS SERVICE

CONTENTS

A.	CUSTOMER NAME AND ADDRESS (CNA) .....	1
1.	General.....	1
2.	Rates and Charges.....	2

GENERAL EXCHANGE TARIFF

Embarq Florida, Inc.

By: F. B. Poag  
Director

Section A118  
First Revised Sheet 1  
Cancelling Original Sheet 1  
Effective: June 5, 1998

OBSOLETE SERVICE OFFERINGS  
LONG DISTANCE MESSAGE TELECOMMUNICATIONS SERVICE

A. CUSTOMER NAME AND ADDRESS (CNA)

+

1. General

- a. Customer Name and Address (CNA) is a directory assistance service which provides a subscriber with the name and/or address, based on a subscriber provided telephone number.
- b. Information regarding nonpublished and nonlisted telephone service will not be provided via Customer Name and Address service.
- c. The Telephone Company assumes no responsibility or liability for any errors in the information furnished. The caller shall indemnify the Telephone Company and hold it free and harmless of and from any and all claims, demands or damages that shall arise from the use of the service.
  - 1) This service is furnished solely for the telephone calling purposes of the caller.
  - 2) Additional provisions concerning limitations of liability and allowance for interruption of service are set forth in Section A2 of this Tariff.
- d. A maximum of 2 requests will be allowed per call.

GENERAL EXCHANGE TARIFF

Embarq Florida, Inc.

By: F. B. Poag  
Director

Section A118  
First Revised Sheet 2  
Cancelling Original Sheet 2  
Effective: June 5, 1998

OBSOLETE SERVICE OFFERINGS  
LONG DISTANCE MESSAGE TELECOMMUNICATIONS SERVICE

A. CUSTOMER NAME AND ADDRESS (CNA) (Cont'd)

1. General (Cont'd)

- e. Charges will not apply to calls placed from pay telephone service, hotel/hospital message rate trunk lines, or to calls placed by customers who have been certified as visually or physically handicapped.
- f. Information provided by Customer Name and Address is limited to the Embarq Florida, Inc. directory assistance database.

2. Rates and Charges

Per Call

- a. Customer Name and Address Rate  
(Maximum of 2 Requests Per Call) \$ .45

GENERAL EXCHANGE TARIFF

Embarq Florida, Inc.

SECTION A120

By: F. B. Poag  
Director

Sixth Revised Contents Sheet 1  
Cancelling Fifth Revised Contents Sheet 1  
Effective: January 6, 2003

OBSOLETE SERVICE OFFERINGS-  
PRIVATE LINE SERVICE AND CHANNELS

CONTENTS

A.	RESERVED FOR FUTURE USE .....	1
B.	CHANNELS (United Telephone exchanges only) .....	1
a.	Series 1100 Channels .....	1
C.	TRANSLINK SERVICE (United Telephone exchanges only) .....	5
1.	Rates and Charges .....	5
D.	DIGILINK SERVICE (United Telephone exchanges only) .....	7
1.	Rates and Charges .....	7
E.	PRIVATE LINE SERVICE (Central Telephone exchanges only) .....	10
1.	Local Channels .....	11
2.	Interoffice Channels .....	11
3.	Optional Features and Functions .....	13
4.	Sub Voice Grade Service (Series 1000) .....	14
F.	PRIVATE LINE SERVICE (United and Central Telephone exchanges)	17
1.	TransLink Service.....	17
G.	DIGILINK SERVICE (United Telephone exchanges only)	18
1.	Local Channels.....	18
2.	Interoffice Channels.....	18
3.	Optional Features and Functions .....	19
H.	DIGILINK SERVICE (Central Telephone exchanges only)	20
1.	Optional Features and Functions .....	20
I.	DIGITAL ACCESS CROSS CONNECT SERVICE (Central Telephone exchanges only)	21
1.	Sub-Rate Multiplexing .....	21
J.	Private Line Services (Central and United Telephone)	22
1.	Definitions.....	22
2.	Rate Regulations .....	24
3.	Regulations Applicable to Channels.....	26
4.	Service Descriptions.....	34
5.	Rates and Charges.....	51

GENERAL EXCHANGE TARIFF

Embarq Florida, Inc.

By: F. B. Poag  
Director

SECTION A120  
Second Revised Sheet 1  
Cancelling First Revised Sheet 1  
Effective: August 6, 1997

OBSOLETE SERVICE OFFERINGS-  
PRIVATE LINE SERVICE AND CHANNELS

- A. RESERVED FOR FUTURE USE
- B. CHANNELS (United Telephone exchanges only)
  - 1. Series 1100 Channels

In consideration of the decreasing supply of metallic facilities, the Company will convert a customer's service requiring such facilities to a Voice Grade Service and waive the nonrecurring charges associated with the change. This applies to a customer where metallic facilities are being displaced with non-metallic facilities, or a customer may elect to make this change at any time prior to a modernization program that would eliminate the availability of metallic facilities.

a. Types and Description

These channels are furnished for operation on a two point or multi point basis subject to the number of point limitations indicated for each type and are provided for use with customer-provided power and signaling equipment. It is expressly declared that metallic facilities are in continually decreasing supply and that the Company does not hold itself in a position to make such facilities available. In addition, if modernization programs dictate the replacement of existing metallic facilities with nonmetallic facilities such as fiber optics the Company will not be required to

GENERAL EXCHANGE TARIFF

Embarq Florida, Inc.

By: F. B. Poag  
Director

SECTION A120  
Second Revised Sheet 2  
Cancelling First Revised Sheet 2  
Effective: August 6, 1997

OBSOLETE SERVICE OFFERINGS-  
PRIVATE LINE SERVICE AND CHANNELS

B. CHANNELS (United Telephone exchanges only)

1. Series 1100 Channels

a. Cont'd)

continue this service over metallic facilities. The various types of services furnished within this Series are as follows:

- 1) Type 1204 (1009/1109) - a two-wire interface with two-wire facilities suitable for use with direct current continuity type of equipment. Signaling (current and voltage) must be within the criteria as described following and circuits are limited to three station locations. This type channel may also be used to furnish auxiliary features (such as lights, hold, signaling, etc.).

Current applied by CPE -	ac & dc components per conductor, not to exceed 0.150 amperes rms
--------------------------	---

Magnitude of the peak - of the voltage between any conductor and ground	not to exceed 70.7 volts (50 volts rms) except continuous dc voltage not to exceed 135 volts
---	---

- 2) Type 1205 (1010/1110) - a two-wire interface with two-wire facilities suitable for low speed, uni-directional series-operated signaling. Transmission specifications as described in Technical Reference, "Transmission Specification for Low Speed Signaling System Channels." Service is limited to three serving wire centers and 26 stations.

GENERAL EXCHANGE TARIFF

Embarq Florida, Inc.

By: F. B. Poag  
Director

SECTION A120  
Sixth Revised Sheet 3  
Cancelling Fifth Revised Sheet 3  
Effective: April 13, 2003

OBSOLETE SERVICE OFFERINGS-  
PRIVATE LINE SERVICE AND CHANNELS

B. CHANNELS (United Telephone exchanges only)

1. Series 1100 Channels

a. (Cont'd)

2) Technical Reference, "Transmission Specification for Low Speed Signaling System Channels." Service is limited to three serving wire centers and 26 stations.

b. Rates and Charges(4)

1) Local Channels (1)

a) Sub Voice Grade  
Per point of termination

	Monthly Rate		Nonrecurring Charge	
	<u>Phase I</u>	<u>Phase II</u>	<u>First</u>	<u>Additional</u>
Type 1204	\$11.90	\$20.85	\$377.00	\$131.00
Type 1205	11.90	20.85	286.00	95.00

2) Non-Wire Center Connected Channels (1)

a) Served Direct

Not routed via the central office, limited to one airline mile or less

Series 1000	\$ 5.75	\$8.00	\$135.00	\$ 47.00
-------------	---------	--------	----------	----------

GENERAL EXCHANGE TARIFF

Embarq Florida, Inc.

SECTION A120

Third Revised Sheet 4

By: F. B. Poag  
Director

Cancelling Second Revised Sheet 4  
Effective: April 13, 2003

OBSOLETE SERVICE OFFERINGS-  
PRIVATE LINE SERVICE AND CHANNELS

B. CHANNELS (United Telephone exchanges only)

1. Series 1100 Channels

b. Rates and Charges(4)

3) Interoffice Channels (1,2,3)

a) Fixed and Mileage Charges applicable

Sub Voice Grade - Series 1000

	<u>Fixed Monthly Charge</u>	<u>Monthly Charge Per Mile</u>	<u>Nonrecurring Charge Per Channel</u>
1-8 Miles	\$28.00	\$1.50	\$103.00
9-25 Miles	28.00	1.45	103.00
Over 25 Miles	28.00	1.40	103.00

- Note 1: Nonrecurring charges are described in A20.B.3.a.  
 Note 2: For method of determining mileage, see A20.B.3.c.  
 Note 3: Metallic Interoffice Channels for type 1204 Local Channels are no longer available for new installations, moves or transfers. This service will no longer be available after 9/1/93. Metallic interoffice facilities are in continually decreasing supply due to modernization programs that replace existing metallic interoffice with non-metallic facilities such as fiber optics.



GENERAL EXCHANGE TARIFF

Embarq Florida, Inc.

By: F. B. Poag  
Director

SECTION A120  
Fifth Revised Sheet 5  
Cancelling Fourth Revised Sheet 5  
Effective: April 13, 2003

OBSOLETE SERVICE OFFERINGS-  
PRIVATE LINE SERVICE AND CHANNELS

C. TRANSLINK SERVICE (United Telephone exchanges only)

These rates are applicable to Interexchange Private Line Service. The term contracts for the following services have expired; the services will continue to be offered to existing customers on a month to month basis at the following rates, which may or may not be based on the original contract term. Rates are subject to change by the Company subject to limitations as provided by Florida Statutes.

1. Rates and Charges

- a. A Digital Local Channel is furnished between a Serving Wire Center and the customer's premises.

1) Digital Local Channel, each

	24 to 48 <u>Months</u>	49 to 72 <u>Months</u>	73 to 96 <u>Months</u>
First ½ mile	\$100.05	\$100.05	\$100.05
Each Additional ½ mile, or fraction thereof	49.00	46.00	44.00

- b. Interoffice Channels furnished between central offices. Rates are based on the airline distance between central offices. (1)

1) Interoffice Channel, each channel 0-8 miles

a) Fixed Monthly	\$69.00	\$69.00	\$69.00
b) Each airline mile, or fraction thereof	25.25	19.55	20.00

GENERAL EXCHANGE TARIFF

Embarq Florida, Inc.

By: F. B. Poag  
Director

SECTION A120  
Seventh Revised Sheet 6  
Cancelling Sixth Revised Sheet 6  
Effective: May 5, 2005

OBSOLETE SERVICE OFFERINGS-  
PRIVATE LINE SERVICE AND CHANNELS

C. TRANSLINK SERVICE (United Telephone exchanges only)

1. Rates and Charges (Cont'd)

b. Cont'd

		24 to 48 <u>Months</u>	49 to 72 <u>Months</u>	73 to 96 <u>Months</u>
2)	Interoffice Channel, each channel 9-25 miles			
	a) Fixed monthly	\$69.00	\$69.00	\$69.00
	b) Each airline mile, or fraction thereof	23.20	20.50	18.50
3)	Interoffice Channel, each channel over 25 miles			
	a) Fixed monthly	\$69.00	\$69.00	\$69.00
	b) Each airline mile, or fraction thereof	22.00	21.00	18.50

Note 1: Refer to Section A20.B.3.c. of this tariff for mileage measurement methodology.

GENERAL EXCHANGE TARIFF

Embarq Florida, Inc.

By: F. B. Poag  
Director

SECTION A120  
Seventh Revised Sheet 7  
Cancelling Sixth Revised Sheet 7  
Effective: May 5, 2005

OBSOLETE SERVICE OFFERINGS-  
PRIVATE LINE SERVICE AND CHANNELS

D. DIGILINK SERVICE (United Telephone exchanges only)

These rates are applicable to Interexchange Private Line Service. The term contracts for the following services have expired; the services will continue to be offered to existing customers on a month to month basis at the following rates, which may or may not be based on the original contract term. Rates are subject to change by the Company subject to limitations as provided by Florida Statutes.

1. Rates and Charges

a. Local Channel  
Per End User Point of Termination

	<u>24-42</u> <u>Months</u>	<u>43-60</u> <u>Months</u>
1) 2.4 Kbps	\$60.00	\$55.00
2) 4.8 Kbps	60.00	55.00
3) 9.6/19.2 Kbps	60.00	55.00
4) 56.0/64.0 Kbps	65.00	60.00

b. Node Channel Termination - per local channel, each

1) 2.4 Kbps	\$16.00	\$16.00
2) 4.8 Kbps	16.00	16.00
3) 9.6/19.2 Kbps	16.00	16.00
4) 56.0/64.0 Kbps	32.00	32.00

GENERAL EXCHANGE TARIFF

Embarq Florida, Inc.

By: F. B. Poag  
Director

SECTION A120  
Seventh Revised Sheet 8  
Cancelling Sixth Revised Sheet 8  
Effective: May 5, 2005

OBSOLETE SERVICE OFFERINGS-  
PRIVATE LINE SERVICE AND CHANNELS

D. DIGILINK SERVICE (United Telephone exchanges only)

1. Rates and Charges

c. Interoffice Channel

	<u>24-42</u> <u>Months</u>		<u>43-60</u> <u>Months</u>	
	<u>Fixed</u>	<u>Per Mile</u>	<u>Fixed</u>	<u>Per Mile</u>
2.4 Kbps				
Mileage Bands				
1) 1-8 miles	\$23.00	\$3.75	\$23.00	\$3.75
2) 9-25 miles	23.00	3.75	23.00	3.75
3) Over 25 miles	23.00	3.75	23.00	3.75
4.8 Kbps				
Mileage Bands				
1) 1-8 miles	\$23.00	\$ 3.75	\$23.00	\$3.75
2) 9-25 miles	23.00	3.75	23.00	3.75
3) Over 25 miles	23.00	3.75	23.00	3.75
9.6/19.2 Kbps				
Mileage Bands				
1) 1-8 miles	\$23.00	\$3.75	\$23.00	\$3.75
2) 9-25 miles	23.00	3.75	23.00	3.75
3) Over 25 miles	23.00	3.75	23.00	3.75
56.0/64.0 Kbps				
Mileage Bands				
1) 1-8 miles	\$33.75	\$ 3.75	\$30.00	\$ 3.75
2) 9-25 miles	33.75	3.75	30.00	3.75
3) Over 25 miles	33.75	3.75	30.00	3.75

GENERAL EXCHANGE TARIFF

Embarq Florida, Inc.

By: F. B. Poag  
Director

SECTION A120  
Fourth Revised Sheet 9  
Cancelling Third Revised Sheet 9  
Effective: April 7, 2002

OBSOLETE SERVICE OFFERINGS-  
PRIVATE LINE SERVICE AND CHANNELS

D. DIGILINK SERVICE (United Telephone exchanges only)

1. Rates and Charges

d. Optional Features and Functions

Bridging, DDC  
Multi point service, per  
local or interoffice  
channel bridged(1)

		<u>24-42</u> <u>Months</u>	<u>43-60</u> <u>Months</u>
1)	(2.4,4.8,9.6 or 19.2 Kbps)	\$13.05	\$10.50
2)	56.0 or 64.0 Kbps (2)	13.05	10.50
	Secondary Channel Capability per Local Channel, Each (1,2)	14.00	10.50

The following rates are applicable to Interexchange Private Line Service. Rate increases or decreases will automatically be applied to the term plan rates for the remaining term of the plan. If a Company initiated rate increase causes a customer's rates to exceed 110% of the original contract rates, the customer may cancel the TDP without incurring termination liability charges.

3)	2.4, 4.8, 9.6 or 19.2 Kbps	\$13.50	\$13.00
4)	56.0 and 64.0 Kbps	13.50	13.00
	Secondary Channel Capability per Local Channel, each	14.00	13.00

GENERAL EXCHANGE TARIFF

Embarq Florida, Inc.

By: F. B. Poag  
Director

SECTION A120  
Fifth Revised Sheet 9.1  
Cancelling Fourth Revised Sheet 9.1  
Effective: May 5, 2004

OBSOLETE SERVICE OFFERINGS-  
PRIVATE LINE SERVICE AND CHANNELS

D. DIGILINK SERVICE (United Telephone exchanges only)

The following rates are applicable to Interexchange Private Line Service. Rate increases or decreases will automatically be applied to the term plan rates for the remaining term of the plan. If a Company initiated rate increase causes a customer's rates to exceed 110% of the original contract rates, the customer may cancel the TDP without incurring termination liability charges.

a. Local Channels

		<u>Contract Rates</u>	
		<u>24-42</u>	<u>43-60</u>
		<u>Months</u>	<u>Months</u>
a)	2.4 Kbps	\$60.00	\$60.00
b)	4.8 Kbps	60.00	60.00
c)	9.6/19.2 Kbps	60.00	60.00
d)	56.0/64.0 Kbps	65.00	65.00

GENERAL EXCHANGE TARIFF

Embarq Florida, Inc.

By: F. B. Poag  
Director

SECTION A120  
Sixth Revised Sheet 9.2  
Cancelling Fifth Revised Sheet 9.2  
Effective: May 5, 2005

OBSOLETE SERVICE OFFERINGS-  
PRIVATE LINE SERVICE AND CHANNELS

D. DIGILINK SERVICE (United Telephone exchanges only)

These rates are applicable to Interexchange Private Line Service. Rate increases or decreases will automatically be applied to the term plan rates for the remaining term of the plan. If a Company initiated rate increase causes a customer's rates to exceed 110% of the original contract rates, the customer may cancel the TDP without incurring termination liability charges.

b. Interoffice Channels

		<u>Contract Rates</u>			
		<u>24-42 Months</u>		<u>43-60 Months</u>	
		<u>Fixed</u>	<u>Per Mile</u>	<u>Fixed</u>	<u>Per Mile</u>
1)	2.4 Kbps				
	Mileage Bands				
(a)	1 thru 8 Miles	\$ 23.00	\$ 3.00	\$ 23.00	\$ 3.00
(b)	9 thru 25 Miles	23.00	3.00	23.00	3.00
(c)	Over 25 Miles	23.00	3.00	23.00	3.00
2)	9.6/19.2 Kbps				
	Mileage Bands				
(a)	1 thru 8 Miles	\$ 23.00	\$ 3.00	\$ 23.00	\$ 3.00
(b)	9 thru 25 Miles	23.00	3.00	23.00	3.00
(c)	Over 25 Miles	23.00	3.00	23.00	3.00
3)	56.0/64.0 Kbps				
	Mileage Bands				
(a)	1 thru 8 Miles	\$ 33.50	\$ 3.75	\$ 33.50	\$ 3.75
(b)	9 thru 25 Miles	33.50	3.75	33.50	3.75
(c)	Over 25 Miles	33.50	3.75	33.50	3.75

GENERAL EXCHANGE TARIFF

Embarq Florida, Inc.

By: F. B. Poag  
Director

SECTION A120  
Fourth Revised Sheet 10  
Cancelling Third Revised Sheet 10  
Effective: June 1, 2002

OBSOLETE SERVICE OFFERINGS-  
PRIVATE LINE SERVICE AND CHANNELS

E. PRIVATE LINE SERVICE (Central Telephone exchanges only)

These rates are applicable to Interexchange Private Line Service. The term contracts for the following services have expired; the services will continue to be offered to existing customers on a month to month basis at the following rates, which may or may not be based on the original contract term. Rates are subject to change by the Company subject to limitations as provided by Florida Statutes.

1. Local Channels

a. Digital Data Access Service

1) Per end User Point of Termination

	Contract Rates	
	24-42	43-60
	<u>Months</u>	<u>Months</u>
a) 2.4 Kbps	NA*	\$45.00
b) 4.8 Kbps	NA*	45.00
c) 9.6/19/2 Kbps	NA*	45.00
d) 56.0/64.0 Kbps	\$65.00	59.25

2) Node Channel Termination-Per  
Local Channel, Each

a) 2.4 Kbps	NA*	\$13.20
b) 4.8 Kbps	NA*	13.20
c) 9.6/19/2 Kbps	NA*	13.20
d) 56.0/64.0 Kbps	25.95	24.10

\* NA = Not applicable



GENERAL EXCHANGE TARIFF

Embarq Florida, Inc.

By: F. B. Poag  
Director

SECTION A120  
Second Revised Sheet 11  
Cancelling First Revised Sheet 11  
Effective: April 7, 2002

OBSOLETE SERVICE OFFERINGS-  
PRIVATE LINE SERVICE AND CHANNELS

E. PRIVATE LINE SERVICE (Central Telephone exchanges only)

1. Local Channels

b. High Capacity, 1.544 Mbps per end User Point of Termination

		Contract Rates		
		24-48	49-72	73-96
		<u>Months</u>	<u>Months</u>	<u>Months</u>
1)	1.544 Mbps			
	a) First ½ Mile	\$95.05	\$95.05	\$95.05
	b) Each add'l ½ mile or fraction thereof	43.00	41.00	39.00

2. Interoffice channels

		Contract Rates			
		24-42 Months		43-60 Months	
		<u>Fixed</u>	<u>Per Mile</u>	<u>Fixed</u>	<u>Per Mile</u>
a.	2.4 Kbps				
	Mileage Bands:				
	1-8 miles	\$16.95	\$1.75	18.00	\$1.65
	9-25 miles	16.95	1.50	18.00	1.60
	Over 25 miles	16.95	1.45	18.00	1.20
b.	4.8 Kbps				
	Mileage Bands:				
	1-8 miles	\$16.95	\$1.75	18.00	\$1.65
	9-25 miles	16.95	1.50	18.00	1.60
	Over 25 miles	16.95	1.45	18.00	1.20

GENERAL EXCHANGE TARIFF

Embarq Florida, Inc.

By: F. B. Poag  
Director

SECTION A120  
Third Revised Sheet 12  
Cancelling Second Revised Sheet 12  
Effective: April 13, 2003

OBSOLETE SERVICE OFFERINGS-  
PRIVATE LINE SERVICE AND CHANNELS

E. PRIVATE LINE SERVICE (Central Telephone exchanges only)

2. Interoffice channels

		Contract Rates			
		24-42 Months		43-60 Months	
		<u>Fixed</u>	<u>Per Mile</u>	<u>Fixed</u>	<u>Per Mile</u>
c.	9.6/19.2 Kbps				
	Mileage Bands:				
	1-8 miles	\$18.45	\$1.75	\$18.00	\$1.65
	9-25 miles	18.45	1.70	18.00	1.60
	Over 25 miles	18.45	1.65	18.00	1.55

d.	56.0/64.0 Kbps				
	Mileage Bands:				
	1-8 miles	\$33.80	\$3.55	\$31.90	\$3.25
	9-25 miles	33.80	3.45	31.90	3.15
	Over 25 miles	33.80	3.40	31.90	3.05

e.	1.544 Mbps						
		Contract Rates					
		24-48 Months		49-72 Months		73-96 Months	
		<u>Fixed</u>	<u>Per Mile</u>	<u>Fixed</u>	<u>Per Mile</u>	<u>Fixed</u>	<u>Per Mile</u>
	Mileage Bands						
	1-8 Miles	\$59.75	\$25.25	\$59.75	\$23.35	\$59.75	\$20.50
	9-25 Miles	\$59.75	\$24.35	\$59.75	\$20.50	\$59.75	\$18.65
	Over 25 Miles	\$59.75	\$20.50	\$59.75	\$18.65	\$59.75	\$16.75

GENERAL EXCHANGE TARIFF

Embarq Florida, Inc.

By: F. B. Poag  
Director

SECTION A120  
Fifth Revised Sheet 12.1  
Cancelling Fourth Revised Sheet 12.1  
Effective: May 5, 2005

OBSOLETE SERVICE OFFERINGS-  
PRIVATE LINE SERVICE AND CHANNELS

E. PRIVATE LINE SERVICE (Central Telephone exchanges only)

3. DigiLink Service (Digital Data)

These rates are applicable to Interexchange Private Line Service. Rate increases or decreases will automatically be applied to the term plan rates for the remaining term of the plan. If a Company initiated rate increase causes a customer's rates to exceed 110% of the original contract rates, the customer may cancel the TDP without incurring termination liability charges.

	Contract Rates			
	24-42 Months		43-60 Months	
	<u>Fixed</u>	<u>Per Mile</u>	<u>Fixed</u>	<u>Per Mile</u>
Interoffice Channels				
a) 2.4 Kbps				
Mileage Bands				
(1) 1 thru 8 Miles	\$18.60	\$2.30	\$16.20	NA*
(2) 9 thru 25 Miles	18.60	2.60	16.20	2.30
(3) Over 25 Miles	18.60	NA*	16.20	2.30
b) 4.8 Kbps				
Mileage Bands				
(1) 1 thru 8 Miles	\$18.60	\$2.30	\$16.20	NA*
(2) 9 thru 25 Miles	18.60	2.60	16.20	2.30
(3) Over 25 Miles	18.60	NA*	16.20	2.30
c) 9.6/19.2 Kbps				
Mileage Bands				
(1) 1 thru 8 Miles	\$18.60	\$2.30	\$16.20	NA*
(2) 9 thru 25 Miles	18.60	2.60	16.20	2.30
(3) Over 25 Miles	18.60	NA*	16.20	2.30
d) 56.0/64.0 Kbps				
Mileage Bands				
(1) 1 thru 8 Miles	\$33.50	\$ 3.20	\$28.70	\$2.95
(2) 9 thru 25 Miles	33.50	3.00	28.70	2.85
(3) Over 25 Miles	33.50	2.95	28.70	2.75

\* NA = Not Applicable

GENERAL EXCHANGE TARIFF

Embarq Florida, Inc.

By: F. B. Poag  
Director

SECTION A120  
Third Revised Sheet 12.2  
Cancelling Second Revised Sheet 12.2  
Effective: May 5, 2005

OBSOLETE SERVICE OFFERINGS-  
PRIVATE LINE SERVICE AND CHANNELS

E. PRIVATE LINE SERVICE (Central Telephone exchanges only)

3. DigiLink Service (Digital Data)

These rates are applicable to Interexchange Private Line Service contract periods established March 1, 1995 through August 31, 1997. These rates will remain in effect until all contracts containing these rates have expired or until all applicable customers have converted to contract periods listed in Section A20 of this tariff. Additional services may be added using new term plans as described in Section A20.

<u>Local Channels</u>	<u>Contract Rates</u>	
	<u>24-42 Months</u>	<u>43-60 Months</u>
a) 2.4 Kbps	\$55.00	\$50.00
b) 4.8 Kbps	55.00	50.00
c) 9.6/19.2 Kbps	55.00	50.00
d) 56.0/64.0 Kbps	65.00	53.35

GENERAL EXCHANGE TARIFF

Embarq Florida, Inc.

By: F. B. Poag  
Director

SECTION A120  
Second Revised Sheet 13  
Cancelling First Revised Sheet 13  
Effective: April 7, 2002

OBSOLETE SERVICE OFFERINGS-  
PRIVATE LINE SERVICE AND CHANNELS

E. PRIVATE LINE SERVICE (Central Telephone exchanges only)

3. Optional Features and Functions

a. Bridging

Bridging charges are applicable where more than two Local Channels and more than one Interoffice Channel, or more than one Local Channel and one Interoffice channel are bridged or hubbed at the same wire center.

	<u>Monthly Rate</u>	<u>24-42 Months</u>	<u>43-60 Months</u>
1) Bridging, DDS			
a) Multi point Service, per local or interoffice channel bridged(1)			
(1) 2.4, 4.8, 9.6 or 19.2 Kbps		\$22.90	\$19.10
(2) 56 Kbps(2)		22.90	19.10
b) Digital Data Secondary Channel Capability, per local channel,			
Each(1,2)	\$15.00	13.50	13.00

Note 1: Not available at all service locations.

Note 2: This option cannot be provided where 56 Kbps repeaters are required for digital local channels.

GENERAL EXCHANGE TARIFF

Embarq Florida, Inc.

By: F. B. Poag  
Director

SECTION A120  
First Revised Sheet 14  
Cancelling Original Sheet 14  
Effective: July 17, 1997

OBSOLETE SERVICE OFFERINGS-  
PRIVATE LINE SERVICE AND CHANNELS

E. PRIVATE LINE SERVICE (Central Telephone exchanges only)

4. Sub Voice Grade Service (Series 1000)

- 1) These channels are furnished for operation on a two point or multipoint basis subject to the number of point limitations indicated for each type and are provided for use with customer provided power and signaling equipment. It is expressly declared that metallic facilities are in continually decreasing supply and that the Company does not hold itself in a position to make such facilities available. In addition, if modernization programs dictate the replacement of existing metallic facilities with non-metallic facilities such as fiber optics, the Company will not be required to continue this service over metallic facilities. The various types of service are:

- (a) Type 1204 - A two-wire interface with two-wire facilities suitable for use with direct current continuity type of equipment. Signaling must be within the criteria as described in Technical Reference, "Transmission Specifications for Private Line Metallic Circuits" and limited to three station locations. This type channel may also be used to furnish auxiliary features (such as lights, hold, signaling, etc.).

Current applied by - ac & dc components CPE per conductor, not to exceed 0.150 amperes RMS

Magnitude of peak - not to exceed 70.7 volts of the voltage between (50 volts RMS) except any conductor and continuous dc voltage ground not to exceed 135 volts

GENERAL EXCHANGE TARIFF

Embarq Florida, Inc.

By: F. B. Poag  
Director

SECTION A120  
First Revised Sheet 15  
Cancelling Original Sheet 15  
Effective: July 15, 1997

OBSOLETE SERVICE OFFERINGS-  
PRIVATE LINE SERVICE AND CHANNELS

E. PRIVATE LINE SERVICE (Central Telephone exchanges only)

4. Sub Voice Grade Service (Series 1000) (Cont'd)

1) (Cont'd)

(b) Type 1205 - A two-wire interface with two-wire facilities suitable for low speed, uni-directional series-operated signaling. Transmission specifications as described in Technical Reference, "Transmission Specifications for Low Speed Signaling System Channels". Service is limited to three serving wire centers and 26 stations.

2) Service is for 7 days per week, 24 hours per day, for a minimum period of one month. These channels are not suitable for the transmission of alternating current tones, but are capable of transmitting direct current mark-space or binary signals at rates from 30 up to 150 bauds.

3) These channels, when furnished for remote metering, supervisory control and miscellaneous signaling purposes, may be used for such purposes as indicating readings of meters at local locations, operating switching which in turn perform some desired operation, or operating special signaling devices of the customer.

4) These channels, when used for low speed teletypewriter or data transmission service, may be connected to extend service to another customer when such connection is made in accordance with the provision of Section A15.

GENERAL EXCHANGE TARIFF

Embarq Florida, Inc.

By: F. B. Poag  
Director

SECTION A120  
Third Revised Sheet 16  
Cancelling Second Revised Sheet 16  
Effective: May 5, 2005

OBSOLETE SERVICE OFFERINGS-  
PRIVATE LINE SERVICE AND CHANNELS

E. PRIVATE LINE SERVICE (Central Telephone exchanges only)

4. Sub Voice Grade Service (Series 1000) (Cont'd)

a. Local Channel

	<u>Monthly Rate</u>	<u>Nonrecurring Charge</u>	
		<u>First</u>	<u>Additional</u>
1) Sub Voice Grade, Series 1000 Per point of termination			
a) Type 1204	\$25.00	\$377.00	\$131.00
b) Type 1205	25.00	286.00	95.00
2) Intra-building connected channels not routed via the central office, per point of termination			
a) Series 1000	2.65	135.00	47.00

b. Interoffice Channels

Mileage Bands	<u>Fixed Monthly Charge</u>	<u>Per Mile Monthly Charge</u>	<u>NRC</u>
1) 1 thru 8 miles	\$25.65	\$3.00	\$103.00
2) 9 thru 25 miles	25.65	3.00	103.00
3) Over 25 miles	25.65	3.00	103.00



GENERAL EXCHANGE TARIFF

Embarq Florida, Inc.

BY: F. B. Poag  
Director

SECTION A120  
Eighth Revised Sheet 17  
Cancelling Seventh Revised Sheet 17  
Effective: May 5, 2005

OBSOLETE SERVICE OFFERINGS-

PRIVATE LINE SERVICE AND CHANNELS

F. PRIVATE LINE SERVICE (United and Central Telephone exchanges)

1. TransLink Service (High Capacity)

These rates are applicable to Interexchange Private Line Service contract periods established prior to September 1, 1997. These rates will remain in effect until all contracts containing these rates have expired or until all applicable customers have converted to contract periods listed in Section A20 of this tariff. Additional services may be added using new term plans as described in Section A20.

a) Local Channels

	Contract Rates		
	24-48 Months	49-72 Months	73-96 Months
1.544 Mbps			
Zone 1	\$130.00	\$128.00	\$117.00
Zone 2	150.00	145.00	127.00
Zone 3	145.00	145.00	140.00

b) Interoffice Channels

Mileage Bands	Contract Rates					
	24-48 Months		49-72 Months		73-96 Months	
	Fixed	Per Mile	Fixed	Per Mile	Fixed	Per Mile
(1) 1 thru 8 miles, each channel						
Zone 1	\$75.00	NA*	\$43.10	\$18.00	\$43.10	\$14.85
Zone 2	75.00	20.45	47.85	18.00	47.85	NA*
Zone 3	75.00	20.45	50.25	18.00	50.25	18.00
(2) 9 thru 25 miles, each channel						
Zone 1	\$75.00	\$17.50	\$43.10	\$14.85	\$43.10	\$13.50
Zone 2	75.00	18.95	47.85	17.50	47.85	14.95
Zone 3	75.00	18.95	50.25	17.50	50.25	15.75
(3) Over 25 miles, each channel						
Zone 1	\$75.00	\$15.00	\$43.10	\$13.50	\$43.10	\$12.15
Zone 2	75.00	18.00	47.85	15.75	47.85	13.45
Zone 3	75.00	17.30	50.25	15.75	50.25	14.15

\* NA = Not applicable

GENERAL EXCHANGE TARIFF

Embarq Florida, Inc.

By: F. B. Poag  
Director

SECTION A120  
Second Revised Sheet 18  
Cancelling First Revised Sheet 18  
Effective: June 1, 2002

OBSOLETE SERVICE OFFERINGS

RESERVED FOR FUTURE USE

GENERAL EXCHANGE TARIFF

Embarq Florida, Inc.

By: F. B. Poag  
Director

SECTION A120  
First Revised Sheet 19  
Cancelling Original Sheet 19  
Effective: April 10, 2001

OBSOLETE SERVICE OFFERINGS-  
PRIVATE LINE SERVICE AND CHANNELS

G. DIGILINK SERVICE (United Telephone exchanges only) (Cont'd)

3. Optional Features and Functions

a) Bridging DDS

	<u>Contract Rates</u>				
	<u>Monthly Rate</u>	<u>12-23 Months</u>	<u>24-35 Months</u>	<u>36-59 Months</u>	<u>60-84 Months</u>
Multipoint Service, per Local or interoffice channel Bridged <sup>1</sup>					
2.4, 4.8 or 9.6 Kbps	\$23.85	\$14.55	\$13.50	\$12.00	\$10.50

Note 1: Not available at all service locations.

GENERAL EXCHANGE TARIFF

Embarq Florida, Inc.

By: F. B. Poag  
Director

SECTION A120  
First Revised Sheet 20  
Cancelling Original Sheet 20  
Effective: April 10, 2001

OBSOLETE SERVICE OFFERINGS-  
PRIVATE LINE SERVICE AND CHANNELS

H. DIGILINK SERVICE (Central Telephone exchanges only)

These rates are applicable to Interexchange Private Line Service contract periods established prior to April 7, 2001. These rates will remain in effect until all contracts containing these rates have expired or until all applicable customers have converted to contract periods listed in Section A20 of this tariff. Additional services may be added using new term plans as described in Section A20.

1. Optional Features and Functions

a) Bridging DDS

	Monthly <u>Rate</u>	<u>Contract Rates</u>			
		<u>12-23 Months</u>	<u>24-35 Months</u>	<u>36-59 Months</u>	<u>60-84 Months</u>
Multipoint Service, per Local or interoffice channel Bridged <sup>1</sup>					
2.4, 4.8 or 9.6 Kbps	\$23.85	\$23.15	\$21.50	\$19.10	\$16.70

b) Multiplexing DS0 to Subrate

An arrangement that converts a 64.0 Kbps channel to subspeeds of up to twenty 2.4 kbps, ten 4.8 kbps, or five 9.6 kbps channels using digital time division multiplexing.

The following tables show the technical specifications packages with which the optional features and functions are available.

	Available with Technical Specifications Package HC-					
	<u>0</u>	<u>1</u>	<u>1C</u>	<u>2</u>	<u>3</u>	<u>4</u>
Automatic Loop Transfer Central Office Multiplexing:						
DS0 to Subrate	X					
(1) Per Arrangement						
(a) Up to twenty 2.4 kbps services						\$172.50
(b) Up to ten 4.8 Kbps services						\$ 86.25
(c) Up to five 9.6 kbps services						\$ 43.15

Note 1: Not available at all service locations.

GENERAL EXCHANGE TARIFF

Embarq Florida, Inc.

By: F. B. Poag  
Director

SECTION A120  
First Revised Sheet 21  
Cancelling Original Sheet 21  
Effective: April 10, 2001

OBSOLETE SERVICE OFFERINGS-  
PRIVATE LINE SERVICE AND CHANNELS

I. DIGITAL ACCESS CROSS CONNECT SERVICE (Central Telephone exchanges only)

These rates are applicable to Interexchange Private Line Service contract periods established prior to April 7, 2001. These rates will remain in effect until all contracts containing these rates have expired or until all applicable customers have converted to contract periods listed in Section A20 of this tariff. Additional services may be added using new term plans as described in Section A20.

1. Sub-rate Multiplexing

	<u>Monthly Rate</u>
(a) Up to twenty 2.4 kbps services	\$172.50
(b) Up to ten 4.8 kbps services	\$ 86.25
(c) Up to five 9.6 kbps services	\$ 43.15

GENERAL EXCHANGE TARIFF

Embarq Florida, Inc.

By: F. B. Poag  
Director

SECTION A120  
First Revised Sheet 22  
Cancelling Original Sheet 22  
Effective: January 6, 2003

OBSOLETE SERVICE OFFERINGS-  
PRIVATE LINE SERVICE AND CHANNELS

J. Private Line Service (Central and United Telephone)

1. Definitions

CHANNEL SERVICE UNIT (CSU) - Denotes equipment provided by the customer to terminate a digital facility on the customer's or other Common Carrier's premises.

CLEAR CHANNEL - Denotes an optional feature that allows the customer full use of the information capacity available in a high capacity channel. Clear Channel is provided by B8ZS line code, which reconfigures the address bits to allow full use of the available data stream.

DIGITAL INTEROFFICE CHANNEL - Denotes a path (or paths) for digital transmission between two Serving Wire Centers within an exchange.

DIGITAL LOCAL CHANNEL - Denotes a path for Digital Private Line service furnished from the Serving Wire Center to the customer's premises.

GENERAL EXCHANGE TARIFF

Embarq Florida, Inc.

By: F. B. Poag  
Director

SECTION A120  
First Revised Sheet 23  
Cancelling Original Sheet 23  
Effective: January 6, 2003

OBSOLETE SERVICE OFFERINGS-  
PRIVATE LINE SERVICE AND CHANNELS

J. Private Line Service (Central and United Telephone) (Cont'd)

1. Definitions (Cont'd)

DS1 - Denotes a channel service expressed in terms of its digitally encoded data bit rate in accordance with the North American hierarchy of digital signal levels. It has a 1.544 Mbps transmission data rate, and provides for the two-way simultaneous transmission of isochronous timed, Bipolar Return-to-Zero (BPRZ) bit stream format, except where intentional bipolar violations are introduced by Bipolar with 8 Zero Substitution (B8ZS) format. Unframed signal formats are not permitted or compatible with Company equipment.

HIGH SPEED - Denotes a rate of speed of 56.0 or 64.0 Kbps.

INTEROFFICE CHANNEL - Denotes a path (or paths) for digital transmission between Company Serving Wire Centers within an exchange. An interoffice channel may be furnished in such a manner as the Company may elect.

LOW SPEED - Denotes a rate of speed of 19.2 Kbps.

MULTIPOINT SERVICE - Denotes a service which provides communications capability between more than two private line station locations by means of a bridging or hubbing arrangement.

SECONDARY CHANNEL - Denotes the offering of a companion digital transmission capability over the same physical facility as the primary channel at a lower bit rate. Terminal equipment required to support secondary channel capability must be provided by the Company.

SERVING WIRE CENTER - The local telephone central office assigned to subscribers within an exchange.

2. Rate Regulations

a. Termination Liability Charge

A Termination Liability Charge is applicable at the date of termination for services under contract. If a customer disconnects any portion of their service prior to the end of month 12, the customer will be liable for 100% of the payments remaining for the first twelve months and 50% of the payments remaining in the contract period. If a customer disconnects any portion of their service after the end of the 12th month, the customer will be liable for 50% of the payments remaining for the rest of the contract period. However, Termination Liability Charges will not apply for customer requests for moves of service under CSPP subject to the provisions set forth in A20.A.9.d. following.

GENERAL EXCHANGE TARIFF

Embarq Florida, Inc.

By: F. B. Poag  
Director

SECTION A120  
First Revised Sheet 24  
Cancelling Original Sheet 24  
Effective: January 6, 2003

OBSOLETE SERVICE OFFERINGS-  
PRIVATE LINE SERVICE AND CHANNELS

J. Private Line Service (Central and United Telephone) (Cont'd)

2. Rate Regulations (Cont'd)

a. Zone Density Plan

The Zone Density Plan is applicable only to DS1 service. The rates applicable for services subject to the Zone Density Plan are dependent upon the zone in which the Telephone Company serving wire center is located. Specific Zone Density Charges are set forth in Section J.2.a. and J.2.b. following. The zones and associated Common Language Location Identifier (CLLI) Code for each Telephone Company serving wire center are identified following:

Zone 1	CLLI	Zone 2	CLLI	Zone 3	CLLI
ALTAMONTE SPRINGS	ALSPFLXADS0	APOPKA	APPKFLXADS1	ALL OTHERS	ALL OTHERS
AVON PARK	AVPKFLXADS0	CAPE CORAL	CPCRFLXADS0		
KISSIMMEE	KSSMFLXADS0	CYPRESS LAKE			
			CYLKFLXADS0		
MAITLAND	MTLDFLXADS1	DESTIN	DESTFLXADS0		
SOUTH FORT MYERS	FTMYFLXCDS2	FORT MYERS	FTMYFLXADS0		
WINTER PARK	WNPKFLXADS1	FORT WALTON BEACH	FTWBFLXADS0		
		GOLDENROD	GLRDFLXADS0		
		LAKE BRANTLEY	LKBRFLXADS1		
		LEESBURG	LSBGFLXADS1		
		NAPLES MOORINGS	NPLSFLXDDS0		
		NORTH NAPLES	NNPLFLXADS1		
		OCALA	OCALFLXADS0		
		PORT CHARLOTTE	PTCTFLXADS0		
		SHADY ROAD	OCALFLXBDS0		
		TALLAHASSEE	TLHSFLXADS0		
		TALLAHASSEE	TLHSFLXADS1		
		TALLAHASSEE	TLHSFLXBDS0		
		TALLAHASSEE	TLHSFLXCDS0		
		TALLAHASSEE	TLHSFLXDDS0		
		TALLAHASSEE	TLHSFLXFDS0		
		WEST KISSIMMEE	KSSMFLXBDS1		
		WINTER GARDEN	WNGRFLXADS0		



GENERAL EXCHANGE TARIFF

Embarq Florida, Inc.

By: F. B. Poag  
Director

SECTION A120  
First Revised Sheet 25  
Cancelling Original Sheet 25  
Effective: January 6, 2003

OBSOLETE SERVICE OFFERINGS-  
PRIVATE LINE SERVICE AND CHANNELS

J. Private Line Service (Central and United Telephone) (Cont'd)

3. Regulations Applicable to Channels

a. General

- 1) The regulations specified herein are applicable to specific facilities as indicated in the appropriate sections of this tariff for channel services.
- 2) Facilities furnished under the Channel Services Payment Plan (CSPP) are subject to all general regulations applicable to the provision of service by the Company as stated elsewhere in this tariff except as noted herein.
- 3) The CSPP is a payment plan which allows customers to pay fixed or variable rates for channel service equipment and facilities over optional contractual payment periods. A specific monthly rate applies for the duration of each period.
  - a) 12-23 month Term Payment Plan - payment periods may be selected from 12 months to 23 months in length, at applicable rates and charges.
  - b) 24-35 month Term Payment Plan - payment periods may be selected from 24 months to 35 months in length, at applicable rates and charges.
  - c) 36-59 month Term Payment Plan - payment periods may be selected from 36 months to 59 months in length, at applicable rates and charges.
  - d) 60-84 month Term Payment Plan - payment periods may be selected from 60 months to 84 months in length, at applicable rates and charges.

GENERAL EXCHANGE TARIFF

Embarq Florida, Inc.

By: F. B. Poag  
Director

SECTION A120  
First Revised Sheet 26  
Cancelling Original Sheet 26  
Effective: January 6, 2003

OBSOLETE SERVICE OFFERINGS-  
PRIVATE LINE SERVICE AND CHANNELS

J. Private Line Service (Central and United Telephone) (Cont'd)

3. Regulations Applicable to Channels (Cont'd)

b. Application of Rates and Charges

- 1) The monthly rate applicable at the time a customer subscribes to Channel Service under a CSPP is not subject to Company initiated change during the optional payment period longer than one month.
- 2) In the event that all or any part of a service is disconnected at a customer request prior to expiration of any selected payment period of greater than one month's duration, the customer will be required to pay a termination charge as stated in that service's section of this tariff.
- 3) When customers renew or change the length of their payment period, the rates applicable for the new period are those currently in effect at the time of the renewal or change in the length of the payment period. A service order charge will not be applicable for such renewals or changes to the payment period.
- 4) Recurring rates and installation, termination, service establishment, Service Connection and other nonrecurring charges apply according to the appropriate schedules for services offered as associated items to Channel Services, and are filed elsewhere in this tariff.
- 5) Customer requests for inside moves of service will not affect the contract period.

c. Additions

- 1) Facilities can be added to an existing system where capacity permits. New rates, charges and regulations as stated in the Channel Services section of the tariff, for any period available under CSPP, may be selected at the rates currently in effect for new customers at the time of the addition.

GENERAL EXCHANGE TARIFF

Embarq Florida, Inc.

By: F. B. Poag  
Director

SECTION A120  
First Revised Sheet 27  
Cancelling Original Sheet 27  
Effective: January 6, 2003

OBSOLETE SERVICE OFFERINGS-  
PRIVATE LINE SERVICE AND CHANNELS

- J. Private Line Service (Central and United Telephone) (Cont'd)
3. Regulations Applicable to Channels (Cont'd)
- c. Additions (Cont'd)
- 2) Termination charges for premature disconnection of added contractual services will apply as set forth under Disconnects.
  - 3) Additions under CSPP are exempt from Company initiated rate changes for all payment periods longer than one month.
  - 4) Installation, service order, service establishment and any other nonrecurring charges, as specified in this tariff, will apply to the added channel service.
- d. Disconnects
- 1) Facilities disconnected from a system prior to the expiration date of the payment period for such services will require termination charges for premature disconnection if applicable.
  - 2) The expiration date of the remaining facilities will not be affected.
- e. Moves of Equipment
- 1) The appropriate nonrecurring charges for inside moves for items associated with channel services as specified in this and other tariffs are applicable. This type movement will not affect the contract period.
  - 2) Inside moves of channel services provided under CSPP will be handled on an individual case basis based upon costs incurred.
  - 3) Customer requests for moves of service(s) under CSPP, other than inside moves, will be subject to the conditions stated in Section J.3.k. following.

GENERAL EXCHANGE TARIFF

Embarq Florida, Inc.

By: F. B. Poag  
Director

SECTION A120  
First Revised Sheet 28  
Cancelling Original Sheet 28  
Effective: January 6, 2003

OBSOLETE SERVICE OFFERINGS-  
PRIVATE LINE SERVICE AND CHANNELS

J. Private Line Service (Central and United Telephone) (Cont'd)

3. Regulations Applicable to Channels (Cont'd)

f. Requests for Changes in Length of Optional Payment Period

1) Subsequent to the establishment of a contract with a CSPP period, and prior to the completion of that period, the existing payment period may be replaced by:

a) A currently offered payment period at the current rates, with a length equal to or longer than the time remaining in the existing service agreement, subject to the following conditions:

- No credit will be given for payments made during the formerly selected period.
- The new payment period begins with the date requested.
- No termination charge applies for the remaining portion of the former payment period.
- Nonrecurring charges will not be reapplied.
- A service order charge will not apply.

g. Renewal Options

1) The customer has the following renewal options:

a) Prior to completion of the current payment period, any period available under the CSPP may be selected at the rates in effect for new customers at the time of the renewal. The customer will be charged the current rate for the newly selected payment period, commencing the day following completion of the prior payment period.

GENERAL EXCHANGE TARIFF

Embarq Florida, Inc.

By: F. B. Poag  
Director

SECTION A120  
First Revised Sheet 29  
Cancelling Original Sheet 29  
Effective: January 6, 2003

OBSOLETE SERVICE OFFERINGS-  
PRIVATE LINE SERVICE AND CHANNELS

J. Private Line Service (Central and United Telephone) (Cont'd)

3. Regulations Applicable to Channels (Cont'd)

g. Renewal Options (Cont'd)

1) The customer has the following renewal options. (Cont'd)

b) Service may be continued on a month-to-month basis at the current rate for the one month payment period, unless otherwise specified in this tariff. The customer has no additional service commitment and, consequently, when service is terminated will not be subject to any termination charge. The one month service will be subject to Company-initiated rate adjustments when approved by the regulatory authority.

c) If the customer does not elect an additional payment period or does not request discontinuance of service, service will be continued at the monthly rate currently in effect for the month-to-month payment rate, under the terms specified in Section J.1 preceding.

2) Service connection charges are not applicable for services renewed under the CSPP. Any new services added at the time of renewal will be subject to all appropriate service connection charges and other nonrecurring charges.

3) The Company may discontinue or change any or all renewal options with approval of the appropriate regulatory authority.

h. Transfer of Service

Service may be transferred to a new customer at the same locations under prior written concurrence by the new customer as specified in this tariff. The new customer will be subject to all provisions and equipment configurations currently in effect for the previous customer. Regulations concerning transfer of service between subscribers as stated in other sections of this tariff also apply under CSPP.

GENERAL EXCHANGE TARIFF

Embarq Florida, Inc.

By: F. B. Poag  
Director

SECTION A120  
First Revised Sheet 30  
Cancelling Original Sheet 30  
Effective: January 6, 2003

OBSOLETE SERVICE OFFERINGS-  
PRIVATE LINE SERVICE AND CHANNELS

J. Private Line Service (Central and United Telephone) (Cont'd)

3. Regulations Applicable to Channels (Cont'd)

i. Deferred Payment

1) Payment of nonrecurring charges for channel services with contract payment plans may be deferred over the length of the customer's payment period or a shorter period (in annual increments) subject to the conditions specified in this paragraph.

a) The charges to be deferred must be among the following types:

Nonrecurring Charges  
Service Establishment

b) The customer must select a payment period longer than one month.

c) The total amount of nonrecurring charges as defined in Section A20.A.8.a.2) may be deferred.

d) The minimum amount deferrable per CSPP Contract is \$4,000.00.

e) Interest on deferred amounts will be calculated at the rate set forth in the deferred payment agreement executed by the customer. The interest rate to be charged on deferred payments will be revised periodically by the Company. If, in the judgment of the Company, the maximum interest rate allowed by law is insufficient to cover the costs of providing the deferred payment option, the Company will suspend the availability of said option until such time as the costs of providing said option can be recovered through the application of a lawful interest rate. Suspension of the deferred payment option will not affect customers who have executed a deferred payment agreement prior to the effective date of such suspension.

GENERAL EXCHANGE TARIFF

Embarq Florida, Inc.

By: F. B. Poag  
Director

SECTION A120  
First Revised Sheet 31  
Cancelling Original Sheet 31  
Effective: January 6, 2003

OBSOLETE SERVICE OFFERINGS-  
PRIVATE LINE SERVICE AND CHANNELS

J. Private Line Service (Central and United Telephone) (Cont'd)

3. Regulations Applicable to Channels (Cont'd)

i. Deferred Payment (Cont'd)

1) (Cont'd)

f) All deferred charges must be paid in full when the customer:

- Selects a payment period with an expiration date prior to the expiration date of the deferral period.
- Disconnects service, for the system, prior to expiration of the selected deferral period.
- Fails to pay a monthly amount within 30 days of its due date.
- Moves a service under CSPP to another location in Company territory within the same state and jurisdiction, with the exception of an inside move.

h) The customer may prepay only the total outstanding deferred charges at any time during the selected deferral period. Customers will be given a credit for the amount of unearned interest. Customers may not prepay less than the total of the outstanding deferred charges.

j. Prepayment

- 1) For payment periods longer than one month, the customer may prepay the total outstanding recurring monthly rates. The prepayment of monthly rates in no way constitutes a purchase and the Company retains full ownership of all services covered by the prepayment. The following conditions apply:

GENERAL EXCHANGE TARIFF

Embarq Florida, Inc.

By: F. B. Poag  
Director

SECTION A120  
First Revised Sheet 32  
Cancelling Original Sheet 32  
Effective: January 6, 2003

OBSOLETE SERVICE OFFERINGS-  
PRIVATE LINE SERVICE AND CHANNELS

J. Private Line Service (Central and United Telephone) (Cont'd)

3. Regulations Applicable to Channels (Cont'd)

j. Prepayment (Cont'd)

1. (Cont'd)

- a) Customers who prepay six months or more will have an allowance applied. The prepayment factor to be used for each month prepaid will be revised periodically by the Company.
- b) Monthly rates for all services covered by a single Letter of Election must be prepaid. Monthly rates must be prepaid for services added subsequently and placed on the same Letter of Election (i.e., customer elected coterminous option) with a prepaid system.
- c) Customers who change the length of a prepaid payment period will be credited any unused portion of the prepayment, subject to termination charges as specified in Section J.2.a. preceding.
- d) Customers who prematurely disconnect will have termination charges deducted from the prepaid amount and any balance credited to their bill.

k. Moves of Service(s) Under CSPP

- 1) Termination Liability Charges will not apply to customer requests for moves of service(s) under CSPP from one location to another locations subject to the following:
  - a) The original and new premises locations must be in Company territory within the same state and jurisdiction.
  - b) The move from the original location to the new location must be completed within thirty (30) days of the original premises disconnect date.



GENERAL EXCHANGE TARIFF

Embarq Florida, Inc.

By: F. B. Poag  
Director

SECTION A120  
First Revised Sheet 33  
Cancelling Original Sheet 33  
Effective: January 6, 2003

OBSOLETE SERVICE OFFERINGS-  
PRIVATE LINE SERVICE AND CHANNELS

J. Private Line Service (Central and United Telephone) (Cont'd)

3. Regulations Applicable to Channels (Cont'd)

I. Moves of Service(s) Under CSPP (Cont'd)

1) (Cont'd)

- c) No lapse in billing will occur for moves of service under CSPP.
- d) Orders to disconnect the original service and reestablish it at the new locations must be related together and received by the Company at the same time.
- e) Any local channels, interoffice channels, and/or optional features and functions from the original location that are not reestablished at the new location will be subject to applicable Termination Liability charges.
- f) Any additions made at the new location will be treated as coterminous additions in accordance with Section J.3.c. preceding.
- g) All regulations and charges for changes made to the service coincident to the move shall apply.
- h) All appropriate nonrecurring charges for moves of service as specified in this tariff shall apply.

GENERAL EXCHANGE TARIFF

Embarq Florida, Inc.

By: F. B. Poag  
Director

SECTION A120  
First Revised Sheet 34  
Cancelling Original Sheet 34  
Effective: January 6, 2003

OBSOLETE SERVICE OFFERINGS-  
PRIVATE LINE SERVICE AND CHANNELS

J. Private Line Service (Central and United Telephone) (Cont'd)

4. Service Descriptions

a. Digilink Service (Digital Data Service)

1) Description of Service

- a) Digilink (Digital Data) Service is a digital transmission service that provides for the transmission of digital signals only and is furnished only via digital transmission facilities. The service provides for simultaneous two-way transmission of synchronous digital signals at speeds of 19.2, 56 and 64 Kbps between two or more points located within the same LATA. The service is available where appropriate digital facilities for this service are available as determined by the Company. The service offered in the Central Telephone area will be changed to the service name "Digilink" as of January 1, 1997.

GENERAL EXCHANGE TARIFF

Embarq Florida, Inc.

By: F. B. Poag  
Director

SECTION A120  
First Revised Sheet 35  
Cancelling Original Sheet 35  
Effective: January 6, 2003

OBSOLETE SERVICE OFFERINGS-  
PRIVATE LINE SERVICE AND CHANNELS

J. Private Line Service (Central and United Telephone) (Cont'd)

4. Service Descriptions (Cont'd)

a. Digilink Service (Digital Data Service) (Cont'd)

1) Description of Service (Cont'd)

- b) Service is furnished for duplex operation only for intraexchange and interexchange service. Provisioning is subject to the availability of facilities as determined by the Company.
- c) The Company will provide a digital facility over existing interoffice carrier equipment where technically feasible. If new equipment and facilities or changes to existing facilities are required to provision Digilink, a special construction charge may apply in addition to the rates in Section J.5 following. Regulations pertaining to special construction can be found in Section A5 preceding.
- d) Multipoint Service and/or Secondary Channel capability may not be available in all Digilink locations.
- e) For the provision of Digilink Service the bridging or hubbing arrangement shall be located at the Node Central Office. The Node Central Office is that physical location the Company has designated as a test, maintenance and monitoring center to service one or more serving wire centers.
- f) The design, maintenance and operation of Digilink is based on communications originating or terminating at stations of the customer. The Company does not represent this service as adaptive for any other purpose, and shall not be responsible for any use other than that intended. The Company shall not be responsible of any transmission, or the quality of any transmission, or signals through the customer's connection to any other communications system.

GENERAL EXCHANGE TARIFF

Embarq Florida, Inc.

By: F. B. Poag  
Director

SECTION A120  
First Revised Sheet 36  
Cancelling Original Sheet 36  
Effective: January 6, 2003

OBSOLETE SERVICE OFFERINGS-  
PRIVATE LINE SERVICE AND CHANNELS

J. Private Line Service (Central and United Telephone) (Cont'd)

4. Service Descriptions (Cont'd)

a. Digilink Service (Digital Data Service) (Cont'd)

1) Description of Service (Cont'd)

- g) A Digital Service Unit/Channel Service Unit (DSU/CSU) or other appropriate digital terminating equipment is required at the customer's premises to provide the proper interface between the Company's network and the customer's equipment.
- h) Digilink Service as furnished by the Company may be connected to other Link Services furnished by the Company.
- i) Digilink is designed to meet or exceed a performance objective of 99% error-free seconds of transmission per 1000 seconds on a daily basis and 99.9% availability on an annual basis when measured through the digital termination equipment.

2) Connections

a) Responsibility of the Company

- (1) Customer-Provided Terminal Equipment, Customer-Provided Derivation Equipment and Customer-Provided Communications Systems may be connected to Digilink Service at the customer's premises when such a connection is made in accordance with the provisions specified in b. following.

GENERAL EXCHANGE TARIFF

Embarq Florida, Inc.

By: F. B. Poag  
Director

SECTION A120  
First Revised Sheet 37  
Cancelling Original Sheet 37  
Effective: January 6, 2003

OBSOLETE SERVICE OFFERINGS-  
PRIVATE LINE SERVICE AND CHANNELS

J. Private Line Service (Central and United Telephone) (Cont'd)

4. Service Descriptions (Cont'd)

a. Digilink Service (Digital Data Service) (Cont'd)

2) Connections (Cont'd)

a) Responsibility of the Company (Cont'd)

- (2) The responsibility of the Company shall be limited to the furnishing and maintenance of service to a network interface on the customer's premises where provisions are made to connect to the customer's equipment.

b) Responsibilities of the Customer

- (1) It is the customer's responsibility to ensure that all customer provided equipment is compatible with Digilink Service.
- (2) The customer is also responsible for any necessary equipment adjustments or modifications, up to and including replacement, due to changes or rearrangements in the network.
- (3) The customer is responsible for installing and testing customer provided premises equipment or facilities to insure that when they are connected with Digilink Service they are operating properly.
- (4) The customer shall be responsible for payment of a Trouble Location Charge, as set forth in Section A15 of this tariff, for visits by the Company to the customer premises when a service difficulty resulting in a trouble report is caused by the use of equipment or facilities provided by the customer.

GENERAL EXCHANGE TARIFF

Embarq Florida, Inc.

By: F. B. Poag  
Director

SECTION A120  
First Revised Sheet 38  
Cancelling Original Sheet 38  
Effective: January 6, 2003

OBSOLETE SERVICE OFFERINGS-  
PRIVATE LINE SERVICE AND CHANNELS

J. Private Line Service (Central and United Telephone) (Cont'd)

4. Service Descriptions (Cont'd)

a. Digilink Service (Digital Data Service) (Cont'd)

2) Connections (Cont'd)

b) Responsibilities of the Customer (Cont'd)

- (5) The customer may not rearrange, disconnect, remove or attempt to repair any equipment installed by the Company.
- (6) Customer provided equipment must not cause interference with any of the services offered by the Company.
- (7) The customer or user may create digital bit streams from Digilink Service by use of its own derivation equipment. Such equipment may be connected for transmission of such bit streams when connected through a customer-provided CSU as described in J.4.b.1)) following.
- (8) A Channel Service Unit (CSU) must be provided by the customer to connect any Company-provided digital facility such as Digilink. Only registered and previously connected grandfathered CSUs may be connected to the Company-provided digital facilities.

3) Application of Rates

- a) A Digital Local Channel is furnished between a Serving Wire Center and the customer's premises.

GENERAL EXCHANGE TARIFF

Embarq Florida, Inc.

By: F. B. Poag  
Director

SECTION A120  
First Revised Sheet 39  
Cancelling Original Sheet 39  
Effective: January 6, 2003

OBSOLETE SERVICE OFFERINGS-  
PRIVATE LINE SERVICE AND CHANNELS

J. Private Line Service (Central and United Telephone) (Cont'd)

4. Service Descriptions (Cont'd)

a. Digilink Service (Digital Data Service) (Cont'd)

3) Application of Rates (Cont'd)

- b) The first Nonrecurring Charge for Local Channels is applicable for the first Local Channel to a customer premises only. For each additional Local Channel to the same premises ordered at the same time, the Additional Nonrecurring Charge applies.
- c) Local Channels greater than 5 miles in length for 19.2 Kbps service or 3 miles for 56.0 and 64.0 Kbps service may require additional equipment, and special construction charges as described in Section A5 of this tariff may apply.
- d) Serving Wire Center Termination Charges are applicable per Local Channel Charge assessed.
- e) The First Nonrecurring Charge for Serving Wire Center Termination is applicable for the first Serving Wire Center Termination in a Central Office only. For each additional Serving Wire Center Termination in the same Central Office ordered at the same time, the Additional Nonrecurring Charge applies.
- f) Service Connection Charges from Section A4 of this tariff do not apply when nonrecurring charges for Digilink Service are assessed.
- g) Rate increases or decreases will automatically be applied to the monthly term plan rates for the remaining term of the TDP. If Company initiated rate increases to any rate element or combination of rate elements causes the charges for the entire DigiLink service under the TDP to increase by 10% or more annually, then the customer may cancel the TDP without incurring termination liability charges provided that the customer notifies the Company within 30 days after the effective date of the rate increase.

GENERAL EXCHANGE TARIFF

Embarq Florida, Inc.

By: F. B. Poag  
Director

SECTION A120  
First Revised Sheet 40  
Cancelling Original Sheet 40  
Effective: January 6, 2003

OBSOLETE SERVICE OFFERINGS-  
PRIVATE LINE SERVICE AND CHANNELS

J. Private Line Service (Central and United Telephone) (Cont'd)

4. Service Descriptions (Cont'd)

a. Digilink Service (Digital Data Service) (Cont'd)

3) Application of Rates (Cont'd)

h) Secondary Channel Capability is also available on an optional features and functions basis. The secondary channel operates parallel with the primary Digilink channel, and is used for diverse network capabilities. Examples of such capabilities include, but are not limited to, providing a lower speed data channel to a network management system in order to perform on-line diagnostics, testing, data monitoring or traffic measurement. This feature is available on a point-to-point basis where facilities are available.

b. TransLink Service (High Capacity Service)

1) Description of Service

a) TransLink Service is furnished for the simultaneous two-way transmission of serial, Bipolar Return-to-Zero (BPRZ) isochronous digital signals, except where intentional bipolar violations are introduced by Bipolar with 8 Zero Substitution (B8ZS) format, at a speed of DS1/1.544 Mbps between two points located within a LATA. The service name "High Capacity Service" previously used in the Central Telephone area will be changed to the service name "TransLink" as of the effective date of this tariff.

b) TransLink service is furnished for Private Line Intraexchange and Interexchange Communications by the Company.



GENERAL EXCHANGE TARIFF

Embarq Florida, Inc.

By: F. B. Poag  
Director

SECTION A120  
First Revised Sheet 41  
Cancelling Original Sheet 41  
Effective: January 6, 2003

OBSOLETE SERVICE OFFERINGS-  
PRIVATE LINE SERVICE AND CHANNELS

J. Private Line Service (Central and United Telephone) (Cont'd)

4. Service Descriptions (Cont'd)

b. TransLink Service (High Capacity Service) (Cont'd)

1) Description of Service (Cont'd)

- c) TransLink service is a service for the transmission of digital signals only and using only digital transmission facilities.
- d) The terminal equipment provided by the customer must be compatible with the DS1/1.544 Mbps channel facility provided by the Company.
- e) Multipoint service is not available.
- f) Unless specified following, the regulations for TransLink service specified herein apply in addition to the regulations set forth in Section J.1. preceding.
- g) The rates specified for TransLink in Section J.5. following contemplate the provision of digital quality facility utilizing existing interoffice carrier equipment and/or exchange cable facilities compatible with this service. If such equipment, new facilities or changes to existing facilities are required for the provision of this service, a special construction charge as specified in Section A5 of this tariff will apply in addition to the rates for TransLink service.
- h) TransLink service is available on a month-to-month basis or under variable rate periods with rates based on length of 36 months, 60 months or 84 months, under conditions specified in Section J.3.a.3) of this tariff. A minimum initial service period of 1 month is required.

GENERAL EXCHANGE TARIFF

Embarq Florida, Inc.

By: F. B. Poag  
Director

SECTION A120  
First Revised Sheet 42  
Cancelling Original Sheet 42  
Effective: January 6, 2003

OBSOLETE SERVICE OFFERINGS-  
PRIVATE LINE SERVICE AND CHANNELS

J. Private Line Service (Central and United Telephone) (Cont'd)

4. Service Descriptions (Cont'd)

b. TransLink Service (High Capacity Service) (Cont'd)

1) Description of Service (Cont'd)

- i) Connection of DS1/1.544 Mbps communications systems provided by others may be made on a permissive basis. The Company does not represent its TransLink service as adapted for each connections, and shall not be responsible for the through transmission of signals, or the quality of such transmission on such connections.
- j) A Channel Service Unit (CSU) or appropriate Termination Equipment (TE) provided by the customer is required at a customer's or authorized user's premises to perform such functions as:
  - proper termination of the service
  - amplification
  - signal shaping
  - remote loop-back
- k) The design, maintenance and operation of TransLink service contemplates communications originating and terminating as (1) customer premises to customer premises channel via the Company Serving Wire Center (SWC) - and/or through remote SWCs; (2) a customer premises to the Serving Wire Center - and/or to remote SWCs - partial channel (link); or (3) a central office to central office (interoffice) partial channel (link).
- l) TransLink service may also be furnished on a link (partial channel) basis when connected to Centrex service and/or another TransLink service. Connections from TransLink service to Centrex service may not be available from all Serving Wire Centers.

GENERAL EXCHANGE TARIFF

Embarq Florida, Inc.

By: F. B. Poag  
Director

SECTION A120  
First Revised Sheet 43  
Cancelling Original Sheet 43  
Effective: January 6, 2003

OBSOLETE SERVICE OFFERINGS-  
PRIVATE LINE SERVICE AND CHANNELS

J. Private Line Service (Central and United Telephone) (Cont'd)

4. Service Descriptions (Cont'd)

b. TransLink Service (High Capacity Service) (Cont'd)

1) Description of Service (Cont'd)

m) All appropriate rates specified in other tariff sections are in addition to the monthly rate per package or single channel TransLink service specified in this tariff.

2) Connections

a) Responsibility of the Company

- (1) Customer-Provided Terminal Equipment, Customer-Provided Derivation Equipment and Customer-Provided Communications Systems may be connected to TransLink service when such connection is made in accordance with the provision specified in b) following.
- (2) The Company shall not be responsible for installation, operation or maintenance of any terminal equipment or communications systems provided by a customer. TransLink service is not represented as adapted for the use of such equipment or system. Where such equipment or system is connected to Company facilities the

GENERAL EXCHANGE TARIFF

Embarq Florida, Inc.

By: F. B. Poag  
Director

SECTION A120  
First Revised Sheet 44  
Cancelling Original Sheet 44  
Effective: January 6, 2003

OBSOLETE SERVICE OFFERINGS-  
PRIVATE LINE SERVICE AND CHANNELS

J. Private Line Service (Central and United Telephone) (Cont'd)

4. Service Descriptions (Cont'd)

b. TransLink Service (High Capacity Service) (Cont'd)

2) Connections (Cont'd)

a) Responsibility of the Company (Cont'd)

(2) (Cont'd)

responsibility of the Company shall be limited to the furnishing of facilities suitable for TransLink service and to the maintenance and operation in a manner proper for such digital service. The Company shall not be responsible for:

- the through transmission of signals generated by such equipment or system, or for the quality of, or defects in, such transmission or
- the reception of signals by such equipment or systems, or
- damage to terminating equipment or communications systems provided by a customer or authorized user due to testing.

- (3) The Company shall not be responsible to the customer if changes in any of the facilities, operations or procedures of the Company utilized in the provision of TransLink service render any facilities or equipment provided by a customer obsolete, or require modification or alteration of such equipment or system or otherwise affects its use or performance.

GENERAL EXCHANGE TARIFF

Embarq Florida, Inc.

By: F. B. Poag  
Director

SECTION A120  
First Revised Sheet 45  
Cancelling Original Sheet 45  
Effective: January 6, 2003

OBSOLETE SERVICE OFFERINGS-  
PRIVATE LINE SERVICE AND CHANNELS

J. Private Line Service (Central and United Telephone) (Cont'd)

4. Service Descriptions (Cont'd)

b. TransLink Service (High Capacity Service) (Cont'd)

2) Connections (Cont'd)

a) Responsibility of the Company (Cont'd)

- (4) The Company undertakes to maintain and repair the facilities which it furnishes. The customer may not rearrange, disconnect, remove or attempt to repair any equipment installed by the Company without prior written consent of the Company.

b) Responsibilities of the Customer

- (1) The customer is responsible for installing and testing his premises equipment or facilities to insure that when they are connected to TransLink service such equipment or facilities are operating properly.
- (2) The operating characteristics of the customer premises equipment of facilities shall be such as to not interfere with any of the services offered by the Company. Such use is subject to the further provisions that the equipment provided by a customer does not: endanger the safety of Company employees or the public; damage, require change in or alteration of the equipment or other facilities of the Company; interfere with the proper functioning of such equipment or

GENERAL EXCHANGE TARIFF

Embarq Florida, Inc.

By: F. B. Poag  
Director

SECTION A120  
First Revised Sheet 46  
Cancelling Original Sheet 46  
Effective: January 6, 2003

OBSOLETE SERVICE OFFERINGS-  
PRIVATE LINE SERVICE AND CHANNELS

J. Private Line Service (Central and United Telephone) (Cont'd)

4. Service Descriptions (Cont'd)

b. TransLink Service (High Capacity Service) (Cont'd)

2) Connections (Cont'd)

b) Responsibilities of the Customer (Cont'd)

(2) (Cont'd)

facilities; impair the operation of the Company's facilities or otherwise insure the public in its use of the Company's services. Upon notice that the equipment provided by a customer is causing or is likely to cause such hazard or interference, the customer shall take steps as shall be necessary to remove or prevent such hazard or interference.

(3) The customer's responsibility shall include cooperative testing with the Company as may be necessary. Where regeneration and/or equalization adjustments or changes may be required to compensate for rearrangements and/or changes in outside plant facilities, the customer will be responsible for all expenses incurred in changes to his premises equipment.

(4) The customer shall be responsible for payment of a Trouble Location Charge, as set forth in Section A15 of this tariff, for visits by the Company to the premises of the customer where the service difficulty or trouble report results from the use of equipment or facilities provided by the customer.

GENERAL EXCHANGE TARIFF

Embarq Florida, Inc.

By: F. B. Poag  
Director

SECTION A120  
First Revised Sheet 47  
Cancelling Original Sheet 47  
Effective: January 6, 2003

OBSOLETE SERVICE OFFERINGS-  
PRIVATE LINE SERVICE AND CHANNELS

J. Private Line Service (Central and United Telephone) (Cont'd)

4. Service Descriptions (Cont'd)

b. TransLink Service (High Capacity Service) (Cont'd)

2) Connections (Cont'd)

b) Responsibilities of the Customer (Cont'd)

- (5) Connection of Customer-Provided Terminal Equipment, Customer-Provided Derivation Equipment and Customer-Provided Communications Systems may be connected at the premises of the customer to TransLink service.
- (6) The customer, by use of its own derivation equipment, may create digital bit streams from the TransLink service and such equipment may be connected for transmission of such bit streams when connected through a customer-provided CSU/TE.
- (7) The undertaking of the Company is to furnish TransLink service as ordered. The customer is required to provide the CSU/TE as specified in Section J.4.b.2)b)10) following.
- (8) TransLink service furnished by the Company may be connected by the customer to another service or to other services furnished by the Company as specified in Section J.4.b.2)a) preceding. Connected services are subject to all rules and regulations governing the provisioning of those services.

GENERAL EXCHANGE TARIFF

Embarq Florida, Inc.

By: F. B. Poag  
Director

SECTION A120  
First Revised Sheet 48  
Cancelling Original Sheet 48  
Effective: January 6, 2003

OBSOLETE SERVICE OFFERINGS-  
PRIVATE LINE SERVICE AND CHANNELS

J. Private Line Service (Central and United Telephone) (Cont'd)

4. Service Descriptions (Cont'd)

b. TransLink Service (High Capacity Service) (Cont'd)

2) Connections (Cont'd)

b) Responsibilities of the Customer (Cont'd)

(9) The customer may connect at the premises of the customer to another TransLink service or other services furnished by the Company to different customer as specified in Section J.4.b.2)a) and J.4.b.2)b) preceding. Connected services are subject to all rules and regulations governing provisioning of those services.

(10) A Channel Service Unit (CSU) or appropriate Termination Equipment (TE) must be provided by the customer to connect Company-provided digital facility. In accordance with Part 68 of the FCC Rules and Regulations, new grandfathered CSU/TEs may be connected, moved, and reconnected until June 30, 1987. After this date only registered and previously connected grandfathered CSU/TEs may be connected to Company-provided digital facilities.

3) Application of Rates

a) Digital Local Channels furnished between a Serving Wire Center and the Customer's premises will be charge on a flat-rate basis.

b) Interoffice Channels furnished between Central Offices will be charged at rates based on airline distance between the Central Offices.



GENERAL EXCHANGE TARIFF

Embarq Florida, Inc.

By: F. B. Poag  
Director

SECTION A120  
First Revised Sheet 49  
Cancelling Original Sheet 49  
Effective: January 6, 2003

OBSOLETE SERVICE OFFERINGS-  
PRIVATE LINE SERVICE AND CHANNELS

J. Private Line Service (Central and United Telephone) (Cont'd)

4. Service Descriptions (Cont'd)

b. TransLink Service (High Capacity Service) (Cont'd)

3) Application of Rates (Cont'd)

- c) TransLink service is available on a month-to-month basis or under variable rate periods with rates based on lengths of 36 months, 60 months, or 84 months under conditions specified in the Channel Services Payment Plan in Section J.3.a. of this tariff except as modified following. Contract rate increases are subject to stipulations of d) following.
- d) Rate increases or decreases will automatically be applied to the monthly term plan rates for the remaining term of the TDP. If Company initiated rate increases to any rate element or combination of rate elements causes the charges for the entire TransLink service under the TDP to increase by 10% or more annually, then the customer may cancel the TDP without incurring termination liability charges provided that the customer notifies the Company within 30 days after the effective date of the rate increase.
- e) Termination Liability Charges will not apply for customer requests for moves of service under CSPP subject to the provisions set forth in Section J.3.I. preceding.
- f) Airline distance between Company Central Offices shall be developed using the methodology found in Section A20.8.c. of this tariff. Fractional mileage shall be rounded up to the next full mile.

GENERAL EXCHANGE TARIFF

Embarq Florida, Inc.

By: F. B. Poag  
Director

SECTION A120  
First Revised Sheet 50  
Cancelling Original Sheet 50  
Effective: January 6, 2003

OBSOLETE SERVICE OFFERINGS-  
PRIVATE LINE SERVICE AND CHANNELS

J. Private Line Service (Central and United Telephone) (Cont'd)

4. Service Descriptions (Cont'd)

b. TransLink Service (High Capacity Service) (Cont'd)

4) Clear Channel Capability

- a) Clear Channel Capability (CCC) is an arrangement that alters a DS1/1.544 Mbps signal with unconstrained information bits, to meet pulse density requirements.

This will allow a customer to transport an all zero octet over a TransLink service channel providing an available combined maximum 1.536 Mbps data rate. This arrangement requires the customer signal at the channel interface to conform to Bipolar with 8 Zero Substitution (B8ZS) line code.

- b) CCC is provided on TransLink Service channels between two customer designated premises and is subject to the availability of facilities. This optional feature may be ordered at the same time the TransLink service channel is ordered, or it may be ordered as an additional feature of an existing TransLink service channel.
- c) When providing CCC via a DS3/44.736 Mbps High Capacity channel, that DS3 channel must be designated, in Company records, as having Clear Channel Capability prior to the provisioning of a DS1/1.544 Mbps High Capacity channel with CCC. Customers must agree to out-of-service periods required to add this feature to an existing TransLink service channel to be optioned for B8ZS.

GENERAL EXCHANGE TARIFF

Embarq Florida, Inc.

By: F. B. Poag  
Director

SECTION A120  
Third Revised Sheet 51  
Cancelling Second Revised Sheet 51  
Effective: May 5, 2005

OBSOLETE SERVICE OFFERINGS-  
PRIVATE LINE SERVICE AND CHANNELS

J. Private Line Service (Central and United Telephone) (Cont'd)

5. Rates and Charges (Cont'd)

a. Local Channels (Cont'd)

1) DigiLink Service (Digital Data)

		<u>Monthly Rate</u>	<u>Nonrecurring Charge<sup>1</sup></u>	
			<u>First</u>	<u>Additional</u>
a)	19.2 Kbps	\$70.00	\$390.00	\$120.00
b)	56.0/64.0 Kbps	\$80.00	\$390.00	\$120.00

		<u>Contract Rates<sup>1</sup></u>			
		<u>12-23 Months</u>	<u>24-35 Months</u>	<u>36-59 Months</u>	<u>60-84 Months</u>
a)	19.2 Kbps	\$70.00	\$60.00	\$55.00	\$50.00
b)	56.0/64.0 Kbps	\$70.00	\$65.00	\$58.00	\$55.00

<sup>1</sup>Nonrecurring Charge also applies to Contract Rates.

GENERAL EXCHANGE TARIFF

Embarq Florida, Inc.

By: F. B. Poag  
Director

SECTION A120  
Fourth Revised Sheet 52  
Cancelling Third Revised Sheet 52  
Effective: May 5, 2005

OBSOLETE SERVICE OFFERINGS-  
PRIVATE LINE SERVICE AND CHANNELS

J. Private Line Service (Central and United Telephone) (Cont'd)

5. Rates and Charges (Cont'd)

a. Local Channels (Cont'd)

2) TransLink Service (High Capacity)

a) 1.544 Mbps	Monthly Rate	<u>Nonrecurring Charge<sup>1</sup></u>		
		<u>First</u>	<u>Additional</u>	
Zone 1	\$155.00	\$745.00	\$335.00	
Zone 2	155.00	745.00	335.00	
Zone 3	160.00	745.00	335.00	
		<u>Contract Rates<sup>1</sup></u>		
	<u>12-23 Months</u>	<u>24-35 Months</u>	<u>36-59 Months</u>	<u>60-84 Months</u>
Zone 1	\$137.00	\$130.00	\$122.00	\$115.00
Zone 2	148.00	140.00	130.00	120.00
Zone 3	148.00	140.00	130.00	120.00

<sup>1</sup> Nonrecurring Charges also apply to Contract Rates.

GENERAL EXCHANGE TARIFF

Embarq Florida, Inc.

By: F. B. Poag  
Director

SECTION A120  
Third Revised Sheet 53  
Cancelling Second Revised Sheet 53  
Effective: May 5, 2005

OBSOLETE SERVICE OFFERINGS-  
PRIVATE LINE SERVICE AND CHANNELS

J. Private Line Service (Central and United Telephone) (Cont'd)

5. Rates and Charges (Cont'd)

b. Interoffice Channels (Cont'd)

1) DigiLink Service (Digital Data)

		<u>Fixed Monthly</u>	<u>Per Mile Monthly</u>	<u>Nonrecurring Charge<sup>1</sup></u>
a)	19.2 Kbps	\$30.00	\$2.60	\$67.00
b)	56.0/64.0 Kbps	40.00	3.75	67.00

Contract Rates<sup>1</sup>

	<u>12-23 Months</u>		<u>24-35 Months</u>		<u>36-59 Months</u>		<u>60-84 Months</u>	
	<u>Fixed</u>	<u>Per Mile</u>	<u>Fixed</u>	<u>Per Mile</u>	<u>Fixed</u>	<u>Per Mile</u>	<u>Fixed</u>	<u>Per Mile</u>
c) 19.2 Kbps								
Mileage Bands								
(1) 1 thru 8 Miles	\$18.25	\$1.65	\$16.95	\$1.55	\$15.05	\$1.40	\$13.20	\$1.20
(2) 9 thru 25 Miles	18.25	1.65	16.95	1.55	15.05	1.40	13.20	1.20
(3) Over 25 Miles	18.25	1.65	16.95	1.55	15.05	1.40	13.20	1.20
d) 56/64.0 Kbps								
Mileage Bands								
(1) 1 thru 8 Miles	\$36.10	\$3.30	\$33.50	\$3.10	\$31.00	\$2.75	\$30.00	\$2.40
(2) 9 thru 25 Miles	36.10	3.30	33.50	3.10	31.00	2.75	30.00	2.40
(3) Over 25 Miles	36.10	3.30	33.50	3.10	31.00	2.75	30.00	2.40

<sup>1</sup>Nonrecurring Charge of \$67 applies to above contract rates.

GENERAL EXCHANGE TARIFF

Embarq Florida, Inc.

By: F. B. Poag  
Director

SECTION A120  
Third Revised Sheet 54  
Cancelling Second Revised Sheet 54  
Effective: May 5, 2005

OBSOLETE SERVICE OFFERINGS-  
PRIVATE LINE SERVICE AND CHANNELS

J. Private Line Service (Central and United Telephone) (Cont'd)

5. Rates and Charges (Cont'd)

b. Interoffice Channels (Cont'd)

2) TransLink Service (High Capacity) 1.544 Mbps

	<u>Fixed Monthly Charge</u>	<u>Per Mile Monthly Charge</u>	<u>Nonrecurring Charge<sup>1</sup></u>
Zone 1	\$75.00	\$27.00	\$200.00
Zone 2	75.00	27.00	200.00
Zone 3	75.00	27.00	200.00

Contract Rates<sup>1</sup>

Mileage Bands	<u>12-23 Months</u>		<u>24-35 Months</u>		<u>36-59 Months</u>		<u>60-84 Months</u>	
	<u>Fixed</u>	<u>Per Mile</u>	<u>Fixed</u>	<u>Per Mile</u>	<u>Fixed</u>	<u>Per Mile</u>	<u>Fixed</u>	<u>Per Mile</u>
a) 1 thru 8 Miles, each channel								
Zone 1	\$65.00	\$25.00	\$62.00	\$23.00	\$55.00	\$21.00	\$49.00	\$17.55
Zone 2	65.00	25.00	62.00	23.00	55.00	21.00	49.00	17.55
Zone 3	65.00	25.00	62.00	23.00	55.00	21.00	49.00	17.55
b) 9 thru 25 miles, each channel								
Zone 1	\$65.00	\$23.00	\$62.00	\$21.20	\$55.00	\$18.85	\$49.00	\$16.50
Zone 2	65.00	23.00	62.00	21.20	55.00	18.85	49.00	16.50
Zone 3	65.00	23.00	62.00	21.20	55.00	18.85	49.00	16.50
c) Over 25 miles, each channel								
Zone 1	\$65.00	\$23.00	\$62.00	\$19.75	\$55.00	\$17.60	\$49.00	\$15.40
Zone 2	65.00	23.00	62.00	19.75	55.00	17.60	49.00	15.40
Zone 3	65.00	23.00	62.00	19.75	55.00	17.60	49.00	15.40

<sup>1</sup>Nonrecurring Charge of \$200 applies to contract rates.

GENERAL EXCHANGE TARIFF

Embarq Florida, Inc.

By: F. B. Poag  
Director

SECTION A120  
First Revised Sheet 55  
Cancelling Original Sheet 55  
Effective: January 6, 2003

OBSOLETE SERVICE OFFERINGS-  
PRIVATE LINE SERVICE AND CHANNELS

J. Private Line Service (Central and United Telephone) (Cont'd)

5. Rates and Charges (Cont'd)

c. Optional Features and Functions (Cont'd)

1) Bridging

a) Bridging, DDS

UNITED TELEPHONE	Monthly Rate	Contract Rates <sup>1</sup>				NRC
		12-23 Months	24-35 Months	36-59 Months	60-84 Months	
(1) Multipoint Service, per local or interoffice channel bridged <sup>1</sup>						
(a) 19.2, 56.0 or 64.0 Kbps	\$23.85	\$14.55	\$13.50	\$12.00	\$10.50	\$ 25.00
(2) Secondary Channel Capability <sup>1,2,3</sup> per Local Channel, each	\$15.00	\$14.55	\$13.50	\$12.00	\$10.50	\$235.00
CENTRAL TELEPHONE						
(1) Multipoint Service, per local or interoffice channel bridged <sup>1</sup>						
(a) 19.2, 56.0 or 64.0 Kbps	\$23.85	\$23.15	\$21.50	\$19.10	\$16.70	\$ 25.00
(2) Secondary Channel Capability <sup>1,2,3</sup> per Local Channel, each	\$15.00	\$14.55	\$13.50	\$12.00	\$10.50	\$235.00

Note 1: Not available at all service locations.

Note 2: This option cannot be provided where 56.0 Kbps repeaters are required for digital channels.

Note 3: Nonrecurring charge is applicable only if Secondary Channel Service is being added subsequent to the installation of basic service.

GENERAL EXCHANGE TARIFF

Embarq Florida, Inc.

By: F. B. Poag  
Director

SECTION A120  
First Revised Sheet 56  
Cancelling Original Sheet 56  
Effective: January 6, 2003

OBSOLETE SERVICE OFFERINGS-  
PRIVATE LINE SERVICE AND CHANNELS

J. Private Line Service (Central and United Telephone) (Cont'd)

5. Rates and Charges (Cont'd)

c. Optional Features and Functions (Cont'd)

2) Clear Channel Capability  
Per Point-to-Point TransLink service channel

UNITED TELEPHONE	Monthly Rate	Nonrecurring Charge	
		Initial	Subsequent
a) with Superframe Format (SF)	ICB	ICB	\$ 275.00
b) with Extended Superframe format (ESF)	ICB	ICB	\$ 275.00



GENERAL EXCHANGE TARIFF

Embarq Florida, Inc.

By: F. B. Poag  
Director

SECTION A120  
First Revised Sheet 57  
Cancelling Original Sheet 57  
Effective: January 6, 2003

OBSOLETE SERVICE OFFERINGS-  
PRIVATE LINE SERVICE AND CHANNELS

J. Private Line Service (Central and United Telephone) (Cont'd)

5. Rates and Charges (Cont'd)

c. Optional Features and Functions (Cont'd)

3) Multiplexing

UNITED TELEPHONE	Monthly <u>Rate</u>
------------------	------------------------

a) Multiplexing (TransLink)	ICB
-----------------------------	-----

CENTRAL TELEPHONE

b) DS1 to Voice

An arrangement that converts a 1.544 Mbps channel to 24 channels for use with Voice Grade Services. A channel of this DS1 to the Hub can also be used for Digilink Service (Digital Data), Program Audio or Sub Voice Grade.

	Monthly <u>Rate</u>	Nonrecurring <u>Charge</u>
(1) Per arrangement, each	\$200.95	\$185.00

GENERAL EXCHANGE TARIFF

Embarq Florida, Inc.

By: F. B. Poag  
Director

SECTION A120  
First Revised Sheet 58  
Cancelling Original Sheet 58  
Effective: January 6, 2003

OBSOLETE SERVICE OFFERINGS  
PRIVATE LINE SERVICE AND CHANNELS

J. Private Line Service (Central and United Telephone) (Cont'd)

5. Rates and Charges (Cont'd)

c. Optional Features and Functions (Cont'd)

3) Multiplexing (CENTRAL TELEPHONE) (Cont'd)

c) DS1 to DS0

An arrangement that converts a 1.544 Mbps channel to 24 64.0 kbps channels utilizing digital time division multiplexing.

	<u>Monthly Rate</u>	<u>Nonrecurring Charge</u>
(1) Per arrangement, each	\$119.85	\$ 66.00

d) DS0 to Subrate (Central Telephone)

The following tables show the technical specifications packages with which the optional features and functions are available.

Available with Technical Specifications Package HC-

	0	1	1C	2	3	4
Automatic Loop Transfer		X				
Central Office Multiplexing:						
DS4 to DS1						X
DS3 to DS1					X	
DS2 to DS1				X		
DS1C to DS1			X			
DS1 to Voice		X				
DS1 to DS0		X				

GENERAL EXCHANGE TARIFF

Embarq Florida, Inc.

By: F. B. Poag  
Director

SECTION A120  
First Revised Sheet 59  
Cancelling Original Sheet 59  
Effective: January 6, 2003

OBSOLETE SERVICE OFFERINGS-  
PRIVATE LINE SERVICE AND CHANNELS

J. Private Line Service (Central and United Telephone) (Cont'd)

5. Rates and Charges (Cont'd)

c. Optional Features and Functions (Cont'd)

4) Automatic Loop Transfer

The Automatic Loop Transfer provides protection on a IXN basis against failure of the facilities between a customer designated premises and the wire center serving that premises. Protection is furnished through the use of a switching arrangement that automatically switched to a spare channel line when a working line fails. The spare channel is not included as a part of the option. This option requires compatible equipment at both the serving wire center and the customer premises. The customer is responsible for providing the equipment at its premises. Equipment at the customer premises will be provided under tariff only if it existed in the Company inventory as of November 18, 1983. An additional Local Channel charge will apply whenever the spare line is provided as a leg to the customer premises.

UNITED TELEPHONE

a) Per arrangement	<u>Monthly Rate</u> ICB
--------------------	--------------------------------

CENTRAL TELEPHONE

b) Per arrangement	<u>Monthly Rate</u>	<u>Nonrecurring Charge</u>
	\$ 72.30	\$ 10.00

GENERAL EXCHANGE TARIFF

Embarq Florida, Inc.

SECTION A123

By: F. B. Poag  
Director

First Revised Contents Sheet 1  
Cancelling Original Contents Sheet 1  
Effective: May 10, 2002

OBSOLETE SERVICE OFFERINGS  
DIGITAL CENTREX SERVICE FOR CITY, COUNTY,  
FEDERAL AND STATE AGENCIES  
(CENTRAL TELEPHONE EXCHANGES ONLY)

CONTENTS

	SHEET
A. GENERAL PROVISIONS.....	1
1. General .....	1
2. Service Features .....	2
B. RATES AND CHARGES .....	5
1. Rates and Charges(Central Telephone Exchanges Only) .....	5
a. General .....	5
b. Digital Centrex Service Line Rates (Central Telephone Exchanges Only) .....	6
c. Trunk Equivalency Table for Subscriber Line Charge (SLC)/End User Common Line (EUCL).....	7
d. Centrex Translation Charge.....	9
e. Feature Changes After Initial Installation.....	9
C. DIGITAL CENTREX SERVICE - OPTIONAL FEATURES .....	10
1. Northern Telecom Business Terminal .....	10
2. Special Message Detail Recording .....	10
D. DIGITAL CENTREX SERVICE SPECIAL ACCESS (Central Telephone Exchanges Only) .....	10
1. General .....	10
2. Rates and Charges.....	10

GENERAL EXCHANGE TARIFF

Embarq Florida, Inc.

By: F. B. Poag  
Director

SECTION A123  
First Revised Sheet 1  
Cancelling Original Sheet 1  
Effective: May 10, 2002

OBSOLETE SERVICE OFFERINGS  
DIGITAL CENTREX SERVICE FOR CITY, COUNTY,  
FEDERAL AND STATE AGENCIES  
(CENTRAL TELEPHONE EXCHANGES ONLY)

A. GENERAL PROVISIONS

This information formerly appeared in Section A23 and became obsolete on May 10, 2002. No new customers may subscribe to this service. This service will continue to be provided to existing customer(s) until such time as discontinued by the customer, the Company, or the Florida Public Service Commission, or the service can no longer be maintained by the Company

1. General

- a. Embarq Florida, Inc., Digital Centrex Service is provided through a digital central office. It provides the customer with features normally associated with key telephone systems or switchboards.
- b. The service is offered subject to the availability of facilities and provided the customer's serving central office is a digital central office equipped with the necessary software.
- c. The service does not include terminal equipment on the customer's premises. Provision of the telephone instruments or other equipment is the responsibility of the customer.
- d. Directory listings are furnished in accordance with the rates and regulations specified in Section A6 of this tariff.
- e. Service charges as specified in Section A4 of this tariff apply to the services offered in this Section.
- f. Directory assistance charges as specified in Section A6 of this tariff apply to the services offered in this Section.
- g. Toll traffic charges will apply between non-EAS exchanges for all access lines.

GENERAL EXCHANGE TARIFF

Embarq Florida, Inc.

By: F. B. Poag  
Director

SECTION A123  
First Revised Sheet 2  
Cancelling Original Sheet 2  
Effective: May 10, 2002

OBSOLETE SERVICE OFFERINGS  
DIGITAL CENTREX SERVICE FOR CITY, COUNTY,  
FEDERAL AND STATE AGENCIES  
(CENTRAL TELEPHONE EXCHANGES ONLY)

A. GENERAL PROVISIONS (Cont'd)

1. General (Cont'd)

- h. At the expiration of the 12 month service period, the subscriber's service period will automatically renew for successive periods of 12 months each at the then current tariffed rates, unless the subscriber provides written or verbal notice of termination at least thirty (30) days in advance of any scheduled renewal.
- i. The minimum service period for Digital Centrex Service (Central Telephone Exchanges Only) is one year (12 months) unless the term of the agreement is modified in a C.S.A. agreement or longer term contract.
- j. Contract termination liability for the twelve month minimum service period is such that if a subscriber terminates their Centrex service prior to the expiration of the minimum 12 month service period, the subscriber shall immediately pay a termination liability in the amount of 100% of the monthly charges remaining in the 12 month period.

2. Service Features

- a. The features listed are station or attendant console related. The basic rate includes all features, but the number of features actually used depends upon the customer's operating procedures and the terminal equipment selected. The customer may utilize station features only or both station and attendant console features.

GENERAL EXCHANGE TARIFF

Embarq Florida, Inc.

By: F. B. Poag  
Director

SECTION A123  
First Revised Sheet 3  
Cancelling Original Sheet 3  
Effective: May 10, 2002

OBSOLETE SERVICE OFFERINGS  
DIGITAL CENTREX SERVICE FOR CITY, COUNTY,  
FEDERAL AND STATE AGENCIES  
(CENTRAL TELEPHONE EXCHANGES ONLY)

A. GENERAL PROVISIONS (Cont'd)

2. Service Features (Cont'd)

b. Station Features

- 1) Call Forward
  - a) all calls
  - b) station busy
  - c) no answer
- 2) Call Pickup
- 3) Call Waiting
- 4) Camp-on
- 5) Consultation Hold - Three Parties
- 6) Meet-Me Conference - Six Parties
- 7) Ring Again
- 8) Speed Call
- 9) Station Call Park
- 10) Code Call Access
- 11) Station Controlled Conference - Six Parties
- 12) Three-Way Conference/Transfer
- 13) Paging
- 14) Autodial
- 15) Conference - Six Parties
- 16) Call Transfer
- 17) Call Hold
- 18) Uniform Call Distribution

GENERAL EXCHANGE TARIFF

Embarq Florida, Inc.

By: F. B. Poag  
Director

SECTION A123  
First Revised Sheet 4  
Cancelling Original Sheet 4  
Effective: May 10, 2002

OBSOLETE SERVICE OFFERINGS  
DIGITAL CENTREX SERVICE FOR CITY, COUNTY,  
FEDERAL AND STATE AGENCIES  
(CENTRAL TELEPHONE EXCHANGES ONLY)

A. GENERAL PROVISIONS (Cont'd)

2. Service Features (Cont'd)

c. Attendant Features

- 1) Call Park Timer
- 2) Call Selection
- 3) Camp-On
- 4) Console Display
- 5) Control of Trunk Group Access
- 6) Locked Loop Operation
- 7) Release
- 8) Speed Call
- 9) Recorded Announcement
- 10) Automatic Recall
- 11) Busy Verification
- 12) Call Park
- 13) Code Calling
- 14) Console Test
- 15) Delayed Operation
- 16) Interposition Calls and Transfers
- 17) Lockout
- 18) Maintenance and Administration Display
- 19) Multiple Console Operation
- 20) Multiple Listed Directory Numbers
- 21) Position Busy
- 22) Secrecy
- 23) Serial Call
- 24) Straight Forward Outward Completion
- 25) Supervisory Console



GENERAL EXCHANGE TARIFF

Embarq Florida, Inc.

By: F. B. Poag  
Director

SECTION A123  
First Revised Sheet 5  
Cancelling Original Sheet 5  
Effective: May 10, 2002

OBSOLETE SERVICE OFFERINGS  
DIGITAL CENTREX SERVICE FOR CITY, COUNTY,  
FEDERAL AND STATE AGENCIES  
(CENTRAL TELEPHONE EXCHANGES ONLY)

A. GENERAL PROVISIONS (Cont'd)

2. Service Features (Cont'd)

c. Attendant Features (Cont'd)

- 26) Switched Loop Operation
- 27) Trunk Group Busy
- 28) Through Dialing
- 29) Timed Recall to Zero
- 30) Trouble Key on Console
- 31) Two Way Splitting

B. RATES AND CHARGES

1. Rates and Charges (Central Telephone Exchanges Only)

a. General

Digital Centrex Service (Central Telephone Exchanges Only) lines will be furnished at the following rates. The monthly rate depends upon the number of lines in service. The monthly rate does not include the Subscriber Line Charge (SLC). The Subscriber Line Charge may be calculated using the trunk equivalency table shown in A123.B.1.c. If the trunk equivalency table is used to calculate the SLC, the number of simultaneous conversions allowed on the system will be the number shown in the equivalent number of trunks column. If the customer elects to use a greater number of trunks, the regular SLC applies to each additional trunk.

GENERAL EXCHANGE TARIFF

Embarq Florida, Inc.

By: F. B. Poag  
Director

SECTION A123  
Fourth Revised Sheet 6  
Cancelling Third Revised Sheet 6  
Effective: November 1, 2005

OBSOLETE SERVICE OFFERINGS  
DIGITAL CENTREX SERVICE FOR CITY, COUNTY,  
FEDERAL AND STATE AGENCIES  
(CENTRAL TELEPHONE EXCHANGES ONLY)

B. RATES AND CHARGES (Cont'd)

1. Rates and Charges (Central Telephone Exchanges Only) (Cont'd)

b. Digital Centrex Service Line Rates (Central Telephone Exchanges Only)

<u>No. Lines</u>	<u>Monthly Rate*</u> Per Premises Location <u>Per Customer Group</u>
26-50	21.01
51-100	23.00
101-150	23.00
151-200	23.00
201-250	21.00
251-300	21.00
301-500	21.00
501-1,000	19.00
1,001-2,000	19.00
2,001 and up	19.00

- \* The tiered rates will be applied on a per customer, per premises, per customer group basis with the applicable rate per line equal to the total number of lines subscribed to. Example: If a customer has 156 Digital Centrex lines and all 156 lines terminate at the same premises and are with the same Digital Centrex customer group, "ALL" 156 lines will be billed at \$20.01. However, if a customer has services at the same premises, but the Digital Centrex lines are terminated in multiple Digital Centrex customer groups, then the Digital Centrex lines will be rated independently based on the total number of lines terminating in each Digital Centrex customer group.

GENERAL EXCHANGE TARIFF

Embarq Florida, Inc.

By: F. B. Poag  
Director

SECTION A123  
First Revised Sheet 7  
Cancelling Original Sheet 7  
Effective: May 10, 2002

OBSOLETE SERVICE OFFERINGS  
DIGITAL CENTREX SERVICE FOR CITY, COUNTY,  
FEDERAL AND STATE AGENCIES  
(CENTRAL TELEPHONE EXCHANGES ONLY)

B. RATES AND CHARGES (Cont'd)

1. Rates and Charges (Central Telephone Exchanges Only) (Cont'd)

c. Trunk Equivalency Table for Subscriber Line Charge (SLC)/End User Common Line (EUCL)

- 1) The SLC/EUCL is in addition to the monthly rate for the access line. In cases where the number of virtual trunks/paths provided exceeds the number of trunks/paths shown in the table, the customer will be billed based on the actual number of virtual trunks/paths provisioned.

GENERAL EXCHANGE TARIFF

Embarq Florida, Inc.

By: F. B. Poag  
Director

SECTION A123  
First Revised Sheet 8  
Cancelling Original Sheet 8  
Effective: May 10, 2002

OBSOLETE SERVICE OFFERINGS  
DIGITAL CENTREX SERVICE FOR CITY, COUNTY,  
FEDERAL AND STATE AGENCIES  
(CENTRAL TELEPHONE EXCHANGES ONLY)

B. RATES AND CHARGES (Cont'd)

1. Rates and Charges (Central Telephone Exchanges Only) (Cont'd)

c. (Cont'd)

2) Trunk Equivalency Table

<u>Number Of Lines</u>	<u>Equivalent Number of Trunks/Paths</u>	<u>Equivalent Number of SLC/EUCL Charges*</u>
26-28	5	5
29-36	6	6
37-45	7	7
46-54	8	8
55-64	9	9
65-75	10	10
76-86	11	11
87-98	12	12
99-111	13	13
112-125	14	14
126-139	15	15
140-155	16	16
156-171	17	17
172-189	18	18
190-207	19	19
208-225	20	20
226-243	21	21
244-262	22	22
263-281	23	23
282-300	24	24
Each Add'l 15 lines	+1	+1

\* For rates, see Subscriber Line Charge/End User Common Line Charges in Section 4 of the Interstate Access Tariff.

GENERAL EXCHANGE TARIFF

Embarq Florida, Inc.

By: F. B. Poag  
Director

SECTION A123  
First Revised Sheet 9  
Cancelling Original Sheet 9  
Effective: May 10, 2002

OBSOLETE SERVICE OFFERINGS  
DIGITAL CENTREX SERVICE FOR CITY, COUNTY,  
FEDERAL AND STATE AGENCIES  
(CENTRAL TELEPHONE EXCHANGES ONLY)

B. RATES AND CHARGES (Cont'd)

1. Rates and Charges (Central Telephone Exchanges Only) (Cont'd)

d. Centrex Translation Charge

The charge for performing the central office translation associated with configuring a Centrex customer's network parameters.

- 1) Applies to each Centrex customer's request which requires central office translation work defining the customer's network parameters to be established or changed.
- 2) Applies to each Centrex customer group translation activity performed.

Centrex Translation Charge	
Per customer translation request	
Nonrecurring Charge	\$50.00

- 3) Service Ordering Charges as specified in Section A4 of this tariff apply to the services offered in this section and are in addition to the Centrex Translation Charges in this section of the tariff.

e. Feature Changes After Initial Installation

- 1) Per Centrex Line up to a maximum of \$50.00  
Nonrecurring Charge (per line) \$10.00
- 2) For feature changes after the initial installation, the Secondary Service Ordering Charge will apply in addition to applicable nonrecurring charges.

GENERAL EXCHANGE TARIFF

Embarq Florida, Inc.

By: F. B. Poag  
Director

SECTION A123  
First Revised Sheet 10  
Cancelling Original Sheet 10  
Effective: May 10, 2002

OBSOLETE SERVICE OFFERINGS  
DIGITAL CENTREX SERVICE FOR CITY, COUNTY,  
FEDERAL AND STATE AGENCIES  
(CENTRAL TELEPHONE EXCHANGES ONLY)

C. DIGITAL CENTREX SERVICE - OPTIONAL FEATURES

1. Northern Telecom Business Terminal

- a) This feature allows the customer to utilize the Northern Telecom DMS-100 Business Terminal (Telephone). The telephone is equipped with an alpha numeric display and allows push-button access to the customer's choice of various station features.
- b) The rate is for each line equipped and does not include the Northern Telecom Business Terminal. The customer is responsible for providing the Business Terminal.
- c) The Business Terminal line card is not required if the customer does not use the Northern Telecom Business Terminal.

	<u>Monthly Rate</u>
d) Business Terminal line card, per line	\$ 1.50

2. Special Message Detail Recording

<u>NRC</u>	<u>Monthly Rate</u>
\$180.00	\$108.50

D. DIGITAL CENTREX SERVICE - SPECIAL ACCESS (CENTRAL TELEPHONE EXCHANGES ONLY)

1. General

- a. This service provides for the interconnection of Special Access and/or Private Line facilities to Digital Centrex Service (Central Telephone Exchanges Only) for the purpose of interfacing with subscribers to Digital Centrex Service (Central Telephone Exchanges Only). This service is necessary to complete the communication path between end users of Digital Centrex Service (Central Telephone Exchanges Only) and users of Special Access and/or Private Line services.
- b. This service is furnished subject to the availability of facilities and features from digital central office switching equipment located in a central office building owned or leased by the Company.
- c. The rates in Section A111 are applicable to each Digital Centrex (Central Telephone Exchanges Only) interconnection. The Special Access and/or Private Line facility is not included in the interconnection charge.

2. Rates and Charges

- a. Rates and charges for various applications of this service should be assessed as shown in Section A111.

GENERAL EXCHANGE TARIFF

Embarq Florida, Inc.

By: F. B. Poag  
Director

Section A124  
Second Revised Contents Sheet 1  
Cancelling First Revised Sheet 1  
Effective: December 1, 1997

OBSOLETE SERVICE OFFERINGS  
EMERGENCY REPORTING SERVICES

CONTENTS

A.	ENHANCED UNIVERSAL EMERGENCY NUMBER SERVICE (E911).....	1
1.	Rates for PSAP Equipment (Obsoleted 6/2/89) .....	1

GENERAL EXCHANGE TARIFF

Embarq Florida, Inc.

By: F. B. Poag  
Director

Section A124  
First Revised Sheet 1  
Cancelling Original Sheet 1  
Effective: January 1, 1997

OBSOLETE SERVICE OFFERINGS  
EMERGENCY REPORTING SERVICES

A. ENHANCED UNIVERSAL EMERGENCY NUMBER SERVICE (E911)

1. Rates for PSAP Equipment (Obsoleted 6/2/89)

This equipment is provided subject to an initial contract period of three or five years or a one-time payment as selected by the customer. Termination charges, as prescribed elsewhere in this tariff, are applicable in the event termination occurs prior to expiration of the initial contract. Existing customers subscribing to the following PSAP equipment are "grandfathered" until such time as the 911 service is discontinued or the equipment is manufacturer discontinued or can no longer be maintained by the Company.

Tier B

a. Automatic Number Identification Features

- |   |         |
|---|---------|
| 1) Auxiliary Controller - Provides common equipment and wiring for next 11 incoming lines and/or display units (maximum 1 per system), each | \$69.71 |
| 2) Additional trunk equipment - (required with Auxiliary Controller) for up to 4 incoming trunk line units (maximum 3 per system), each     | 14.14   |
| 3) Display and transfer unit - (maximum 15 per system), each  | 15.74   |



GENERAL EXCHANGE TARIFF

Embarq Florida, Inc.

By: F. B. Poag  
Director

Section A124  
First Revised Sheet 2  
Cancelling Original Sheet 2  
Effective: January 1, 1997

OBSOLETE SERVICE OFFERINGS  
EMERGENCY REPORTING SERVICES

A. ENHANCED UNIVERSAL EMERGENCY NUMBER SERVICE (E911)

1. Rates for PSAP Equipment (Obsoleted 6/2/89) (Cont'd)

b. Automatic Location Identification Features

	<u>Tier B</u>
1) Master Controller - wired for 15, equipped for 5 display units, each	\$147.07
2) Auxiliary Controller - wired for 15, equipped for 5 additional ALI display units, each	146.14
3) Display Unit - (maximum 15 per master or auxiliary controller), each	13.45

GENERAL EXCHANGE TARIFF

Embarq Florida, Inc.

SECTION A127

BY: F. B. Poag  
Director

Third Revised Sheet 1  
Cancelling Second Revised Sheet 1  
Effective: November 1, 2005

OBSOLETE SERVICE OFFERINGS  
SPECIAL PACKAGED OFFERINGS

A. SOLUTIONS – RESIDENCE

No new customers may subscribe to these services. This service will continue to be provided to existing customers until such time as discontinued by the customer, the Company, or the Florida Public Service Commission or the service can no longer be maintained by the Company.

1. General

- a. Solutions is an optional residence service enrollment plan.

2. Rates and Charges

- a. Solutions Packages

	Monthly Rate *
1) Sure Solution I Local Exchange Service, Package 4, 60 minutes of Local Toll	\$33.15
2) Custom Solution I Local Exchange Service, Package 4,	\$28.15

\* Measured/message ECS/EAS charges, if applicable, as defined in Section A3 of this tariff, apply per each Solutions Package.

GENERAL EXCHANGE TARIFF

Embarq Florida, Inc.

SECTION A127

BY: F. B. Poag  
Director

Third Revised Sheet 2  
Cancelling Second Revised Sheet 2  
Effective: November 1, 2005

OBSOLETE SERVICE OFFERINGS  
SPECIAL PACKAGED OFFERINGS

A. SOLUTIONS – BUSINESS

No new customers may subscribe to these services. This service will continue to be provided to existing customers until such time as discontinued by the customer, the Company, or the Florida Public Service Commission or the service can no longer be maintained by the Company.

1. General

a. Solutions is an optional business service enrollment plan.

2. Rates and Charges

a. Solutions Packages

	Monthly Rate *
1) <u>Economy Solution II</u> <sup>1</sup> Local Exchange Service, Choice of three of the following: Call Forwarding Features (Call Forward Busy-Fixed, plus Call Forward No Answer-Fixed) Enhanced Call Waiting Caller ID with Name Three-Way Calling Repeat Dial	\$33.95
2) <u>Ideal Solution</u> Local Exchange Service, Package 5, <sup>2</sup> 60 minutes of Local Toll	\$48.90
3) <u>Choice Solution</u> Local Exchange Service, Package 1, 60 minutes of Local Toll	\$40.90
4) <u>Standard Solution I</u> Local Exchange Service, Enhanced Call Waiting, 60 minutes of Local Toll	\$36.90

\* Measured/message ECS/EAS charges, if applicable, as defined in Section A3 of this tariff, apply per each Solutions Package.

<sup>1</sup> Customers must also purchase any Embarq Communications, Inc. Plan.

<sup>2</sup> Talking Call Waiting can be added to this Solutions package at the monthly rate shown in Section A13.2.3.b.

GENERAL EXCHANGE TARIFF

Embarq Florida, Inc.

BY: F. B. Poag  
Director

SECTION A127  
Second Revised Sheet 3  
Cancelling First Revised Sheet 3  
Effective: November 1, 2005

OBSOLETE SERVICE OFFERINGS  
SPECIAL PACKAGED OFFERINGS

A. SOLUTIONS – BUSINESS

2. Rates and Charges (Continued)

a. Solutions Packages (Continued)

	Monthly Rate *
5) <u>Standard Solution II</u> Local Exchange Service, Package 1	\$33.65
6) <u>Basic Solution</u> Local Exchange Service, Package 8, 60 minutes of Local Toll	\$46.90
7) <u>Classic Solution</u> Local Exchange Service, Package 8	\$39.65

\* Measured/message ECS/EAS charges, if applicable, as defined in Section A3 of this tariff, apply per each Solutions Package.

GENERAL EXCHANGE TARIFF

Embarq Florida, Inc.

By: F.B. Poag  
Director

SECTION A128  
Sixth Revised Contents Sheet 1  
Cancelling Fifth Revised Contents Sheet 1  
Effective: November 21, 2002

OBSOLETE SERVICE OFFERING

DATA TRANSPORT SERVICE  
CONTENTS

A.	SWITCHLINK (United Telephone Exchanges Only)	
1.	General .....	1
2.	Definitions .....	1
3.	Regulations .....	2
4.	Rates and Charges.....	3
B.	SWITCHLINK PLUS (United Telephone Exchanges Only)	
1.	General .....	4
2.	Regulations .....	5
3.	Rates and Charges.....	6
C.	CENDEL METROPOLITAN DATA SERVICES (CMDS)(United Telephone Exchanges Only)	7
D.	DATAPATH SERVICE (Central Telephone Exchanges Only)	
1.	General .....	15
2.	Rates and Charges.....	15

GENERAL EXCHANGE TARIFF

Embarq Florida, Inc.

By: F.B. Poag  
Director

SECTION A128  
Second Revised Sheet 1  
Cancelling First Revised Sheet 1  
Effective: November 15, 2001

OBSOLETE SERVICE OFFERING

DATA TRANSPORT SERVICE

A. SWITCHLINK (United Telephone Exchanges Only)

1. General

- a. SwitchLink is a digital switched service that provides full duplex information transport at bit rates up to and including 19.2 kbps via a specially equipped two-wire SwitchLink access line.
- b. SwitchLink access lines allow a maximum 19.2 kbps digital call except that digital transmission rates of less than 19.2 may be accomplished as a function of the particular customer premises equipment connected to a SwitchLink access line.
- c. SwitchLink access lines are not voice functional.
- d. SwitchLink is furnished in conjunction with intraLATA communications provided by the Company. InterLATA communications are supported by the Embarq Florida, Inc., Access Service Tariff, Section E6.

2. Definitions

SWITCHLINK ACCESS LINE - refers to the non-loaded facility connecting the customer premises to the Switchlink switching equipment and is similar to an individual business line.

SWITCHLINK SERVICE ARRANGEMENT - refers to the equipment required in the central office per line to support 19.2 kbps data transport over the SwitchLink Access Line.

SWITCHLINK NETWORK CALL - refers to a call placed from one SwitchLink Access Line to another SwitchLink Access Line whether or not the lines are served from the same SwitchLink serving central office.

SWITCHLINK SERVING AREA - the Serving Area is defined by the technical limitations of each specific serving arrangement and in the Company's judgment are necessary to accommodate the data transmission without excessive degradation.

SWITCHLINK REMOTE CAPABILITY - refers to the facilities and equipment necessary to extend a SwitchLink Access Line to certain customers who are served by central offices rather than a SwitchLink serving central office.

SWITCHLINK MODEM POOLING - SwitchLink customers may subscribe to Modem Pooling either as one-way in, one-way out or two-way service. SwitchLink Modem Pooling provides access to the analog public switched network.

SWITCHLINK CENTRAL OFFICE - refers to the central office containing SwitchLink switching equipment.

SERVING WIRE CENTER - denotes the local telephone central office assigned to subscribers in a well defined area. A Serving Wire Center may be further designated by the Company as a SwitchLink Serving Central Office.

GENERAL EXCHANGE TARIFF

Embarq Florida, Inc.

By: F.B. Poag  
Director

SECTION A128  
Third Revised Sheet 2  
Cancelling Second Revised Sheet 2  
Effective: March 1, 2003

OBSOLETE SERVICE OFFERING

DATA TRANSPORT SERVICE

A. SWITCHLINK (United Telephone Exchanges Only) (Cont'd)

3. Regulations

- a. SwitchLink Service is provided subject to the availability of appropriate network facilities and equipment and is provided from the closest designated SwitchLink serving central office. Telephone numbers for SwitchLink access lines will be assigned from the SwitchLink serving central office.
- b. The minimum billing period will be one month.
- c. The Company shall not be responsible if changes in any of its equipment, operations, or procedures utilized in the provision of SwitchLink service render any facilities provided by a customer obsolete or require modification or alteration of such equipment or system or otherwise affect its use or performance. In such instances and when known in advance, the Company will notify customers of such changes.
- d. Vacation service is not allowed.
- e. Regulations for Allowance for Interruptions apply as specified in Section A2 of this tariff.
- f. When SwitchLink Remote Capability is purchased, the mileage charge will be calculated as follows:

The interoffice mileage charge will be based on the airline mileage between the SwitchLink serving central office and the customer's serving wire center. Airline distance between Company central offices is to be developed using the mileage formula in E10 of the BellSouth Service Tariff from V&H coordinates listed in the National Exchange Carrier Association (NECA) Tariff, FCC No. 4.

- g. SwitchLink Service requires the use of customer premises equipment which is compatible with Company facilities.
- h. Customer premises equipment associated with SwitchLink Service is subject to the limitations specified in the Bell Communications Research, Inc., Technical Reference, "DATAPATH\* Network Access Interface Specification." TR-EOP-000277, until such time as the FCC adapts registration rules for the service under Part 68 of their rules and regulations. This technical reference is available from:

BCR Documentation Center  
60 New England Avenue  
Room DSC 1A218  
Piscataway, New Jersey 08854

GENERAL EXCHANGE TARIFF

Embarq Florida, Inc.

By: F.B. Poag  
Director

SECTION A128  
Third Revised Sheet 3  
Cancelling Second Revised Sheet 3  
Effective: April 7, 2002

OBSOLETE SERVICE OFFERING

DATA TRANSPORT SERVICE

A. SWITCHLINK (United Telephone Exchanges Only) (Cont'd)

4. Rates and Charges

a. SwitchLink Network Call Usage Charges

- 1) The following charges apply whenever a SwitchLink Network Call is established to a number within the local toll-free calling area of the customer's serving wire center. Until such time as the Company's billing system can be modified to bill the network call usage charges in A.4.a.1), a flat-rate surrogate usage charge of \$12 per month will be billed to subscribers of Remote Capability per SwitchLink Remote Access Line.

- |    |   |        |
|----|---|--------|
| a) | Initial one minute or fraction<br>Thereof, per call | \$ .06 |
| b) | Additional minute increment<br>Or fraction thereof  | .02    |

- 2) A time-of-day discount is applicable to SwitchLink Network Call Usage charges as follows:

		<u>Discount</u>
All days:	8:00 p.m. - 9:00 a.m.	50%
Sat - Sun	9:00 a.m. - 8:00 p.m.	50%

- 3) Messages that span more than one rate period will have the total charges for the minutes in each rate period summarized. The results for each rate period are added together to obtain the total message charge.
- 4) Network Call Usage charges will be billed to the SwitchLink access line originating the call.
- 5) SwitchLink access lines utilizing the long distance network will have the applicable toll charges billed to the originating end. Long distance charges will be rated from the exchange rate center of the central office providing the SwitchLink Service Arrangement.



GENERAL EXCHANGE TARIFF

Embarq Florida, Inc.

By: F.B. Poag  
Director

SECTION A128  
Fifth Revised Sheet 4  
Cancelling Fourth Revised Sheet 4  
Effective: May 5, 2004

OBSOLETE SERVICE OFFERING

DATA TRANSPORT SERVICE

A. SWITCHLINK (United Telephone Exchanges Only)

4. Rates and Charges (Cont'd)

b. SwitchLink Service Rates

	<u>Nonrecurring Charge</u>	<u>Monthly Rate</u>
1) Basic Service, per line	\$ 25.00	\$ 50.00
2) Remote Access Line*		
First Mile	--	\$ 45.00
Each additional mile	--	4.00
3) Modem Pooling		
One-Way In	\$ 12.00	\$ 5.40
One-Way Out	12.00	5.40
Two Way	12.00	9.50

\* A customer who is not within a SwitchLink serving central office area but who is within a SwitchLink serving area may order SwitchLink at these rates. The rates are in addition to the charges in 4.b.1) and apply to each line that is extended.

c. Other Rates and Charges

- 1) Other charges applicable to individual business lines apply for SwitchLink access lines as outlined in federal or state tariffs.
- 2) Optional Features (i.e., Speed Calling) are available at the rates provided in the applicable sections of the tariff.
- 3) Service Connection Charges from Section A4 of this tariff are applicable to SwitchLink service establishment.

B. SWITCHLINK PLUS

1. General

- a. SwitchLink Plus is a service that permits subscribers to transmit digital data at speeds up to 56 kbps over the public switched network.
- b. SwitchLink Plus, at speeds up to 56 kbps, is an enhanced digital data service. Therefore, the regulations and definitions for SwitchLink are also applicable to SwitchLink Plus except as stated herein.
- c. Modem pooling is not available with SwitchLink Plus.

GENERAL EXCHANGE TARIFF

Embarq Florida, Inc.

SECTION A128

By: F.B. Poag  
Director

Fifth Revised Sheet 5  
Cancelling Fourth Revised Sheet 5  
Effective: November 24, 2005

OBSOLETE SERVICE OFFERING

DATA TRANSPORT SERVICE

B. SWITCHLINK PLUS (Cont'd)

1. General (Cont'd)

- d. The Remote Access Line feature of the SwitchLink Service is available to subscribers of SwitchLink Plus at the rates specified in Section A29 of this tariff.
- e. SwitchLink Plus access lines are not voice functional.

2. Regulations

- a. SwitchLink Plus requires a data-conditioned local loop from the serving central office to the subscriber's premises. The local loop is limited to the transport of digital information only. The service may not be used for analog transmissions.
- b. Compatible data units must be utilized at the originating and terminating ends of the transmission to transmit and receive the data at the 56 Kbps speed. The same data unit may be used for either SwitchLink or SwitchLink Plus. The subscriber is responsible for obtaining and maintaining the data unit.
- c. If the data is to be transmitted over interexchange facilities, the carrier chosen by the subscriber must be capable of passing high speed data end-to-end over a digital network. If the requirements in b. and c. are not met, the information will not be transmitted correctly.

3. Rates and Charges

- a. Local usage rates are billed for outward local and EAS calling only. Long distance rates will apply to calls beyond the local calling area.

b. SwitchLink Plus Rates

	<u>Nonrecurring Charges</u>	<u>Monthly Rates</u>
1) Basic service, per line	\$150.00	\$50.00
2) Local Usage		
First minute, or fraction thereof, per call	.06	
Each additional minute, or fraction thereof	.02	

GENERAL EXCHANGE TARIFF

Embarq Florida, Inc.

By: F.B. Poag  
Director

SECTION A128  
Second Revised Sheet 6  
Cancelling First Revised Sheet 6  
Effective: November 15, 2001

OBSOLETE SERVICE OFFERING

DATA TRANSPORT SERVICE

B. SWITCHLINK PLUS (Cont'd)

3. Rates and Charges (Cont'd)

b. SwitchLink Plus Rates (Cont'd)

2) Local Usage (Cont'd)

- a) Call usage charges will be billed to the SwitchLink Plus access line originating the call.
- b) Per call usage charges are not applicable to Centrex customers for SwitchLink Plus calls placed within the customer's central office defined 4-digit dialing user group. SwitchLink Plus calls dialed outside the customer's user group are subject to applicable usage charges.
- c) Messages which span more than one rate period will have the total charges for the minutes in each rate period summarized. The results for each rate period are added together to obtain the total message charge.

c. A time-of-day discount applies to the local SwitchLink Plus usage rates as follows:

		<u>Discount</u>
All Days	8:00 p.m. - 9:00 a.m.	50%
Saturday and Sunday	9:00 a.m. - 8:00 p.m.	50%

d. Other Rates and Charges

- 1) Optional Features (i.e., Speed Calling) are available at the rates provided in the applicable sections of the tariff.
- 2) Service Connection Charges from Section A4 of this tariff are applicable to SwitchLink Plus service establishment.

GENERAL EXCHANGE TARIFF

Embarq Florida, Inc.

SECTION A128

By: F.B. Poag  
Director

Second Revised Sheet 7  
Cancelling First Revised Sheet 7  
Effective: September 18, 2002

OBSOLETE SERVICE OFFERING  
CENTEL METROPOLITAN DATA SERVICES (CMDS)  
(Central Telephone exchanges only)

DATA TRANSPORT SERVICE

C. CENTEL METROPOLITAN DATA SERVICES (CMDS) (Central Telephone exchanges only)

This information formerly appeared in Section A28 and became obsolete on September 18, 2002. No new customers may subscribe to this service. This service will continue to be provided to existing customer(s) until such time as discontinued by the customer, the Company, or the Florida Public Service Commission, or the service can no longer be maintained by the Company.

1. General

- a. Centel Metropolitan Data Services (CMDS) is a group of telecommunication services designed for use within the metropolitan area of Tallahassee, Florida. CMDS is defined by "Classes of Service." The first group of services being offered provide Local Area Network (LAN) inter-networking over a shared fiber optic network. The shared network utilizes Fiber Distributed Data Interface (FDDI) to transport a subscriber's LAN data across the metropolitan area. The Company's FDDI Metropolitan Area Network (Man) is capable of supporting multiple subscriber network connections at their native LAN speeds.
- b. A "Class of Service" will be used to define each tariffed service for the present LAN inter-networking services and undefined future services.

Classes 4,5,6,7,9 define classes of access for LAN inter-networking via the CMDS MAN. Each class provides Media Access Control (MAC) level bridging services to a subscriber's LANs across the CMDS network as shown following:

<u>CLASS NAME</u>	<u>ACCESS SPEED</u>	<u>FACILITIES</u>	<u>PROTOCOLS SUPPORTED</u>
Class 4	1,536,000 BPS	Copper	802.3/802.5/FDDI
Class 5	4,000,000 BPS	Fiber	802.5
Class 6	10,000,000 BPS	Fiber	802.3
Class 7	16,000,000 BPS	Fiber	802.5
Class 9	100,000,000 BPS	Fiber	FDDI

GENERAL EXCHANGE TARIFF

Embarq Florida, Inc.

By: F.B. Poag  
Director

SECTION A128  
Second Revised Sheet 8  
Cancelling First Revised Sheet 8  
Effective: September 18, 2002

OBSOLETE SERVICE OFFERING

DATA TRANSPORT SERVICE

C. CENTEL METROPOLITIAN DATA SERVICES (CMDS) (Central Telephone exchanges only) (Cont'd)

1. General (Cont'd)

- c. The network demarcation point is the LAN interface on the CMDS equipment at the subscriber premises. This would be a IEEE 802.3, IEEE 802.5, or FDDI. The subscriber is responsible for providing cabling necessary to hook up to the CMDS equipment and is responsible for placing all facilities and cabling required to get to the CMDS demarcation within the building.

2. Requirements for Access Classes 5,6,7, and 9

- a. The customer must ensure site requirements are met as specified following:

1) Power

Customer will provide the Company with two (2) duplex isolated ground 20 amp., 120v. AC outlets. The outlets are to be within five (5) feet of the equipment. All electrical work must meet NECA codes.

2) Footprint

Customer will provide the Company with adequate space to place an equipment cabinet on the premises. Equipment cabinet dimensions are: H70"xW30"xL30". Customer will provide a two (2) foot clearance on all sides and above the equipment cabinet.

3) Conduit

a) Exterior

Customer is responsible to ensure adequate conduit space is available to place fiber from the closest right-of-way into the main telephone room within a building.

b) Interior

If Company-provided equipment is to be located in another space other than the telephone room, the customer will provide a two (2) inch interior conduit suitable to run fiber jumpers to the equipment.

4) Access (maintenance)

Customer will provide the Company's maintenance personnel or contractors with access to the equipment for regular maintenance and service.

GENERAL EXCHANGE TARIFF

Embarq Florida, Inc.

By: F.B. Poag  
Director

SECTION A128  
Third Revised Sheet 9  
Cancelling Second Revised Sheet 9  
Effective: September 18, 2002

OBSOLETE SERVICE OFFERING

DATA TRANSPORT SERVICE

C. CENTEL METROPOLITIAN DATA SERVICES (CMDS) (Central Telephone exchanges only) (Cont'd)

2. Requirements for Access Classes 5,6,7, and 9 (Cont'd)

a. (Cont'd)

5) Environment

a) Air

It is the customer's responsibility to provide adequate cooling to maintain the equipment operating environment parameters as follows:

Temperature: 55-85 degrees Fahrenheit

Humidity: 70% or less

b) Space

It is the customer's responsibility to provide a clean environment free from flooding for the Company provided equipment.

3. Limitations

a. Classes 5,6,7,and 9 are available only within the Tallahassee metropolitan area.

b. Classes 4,5,6 and 7, LAN bridging services are available only for LANs adhering to the IEEE 802.3 and IEEE 802.5 specifications.

GENERAL EXCHANGE TARIFF

Embarq Florida, Inc.

SECTION A128

By: F.B. Poag  
Director

Third Revised Sheet 10  
Cancelling Second Revised Sheet 10  
Effective: September 18, 2002

OBSOLETE SERVICE OFFERING

DATA TRANSPORT SERVICE

C. CENTEL METROPOLITIAN DATA SERVICES (CMDS) (Central Telephone exchanges only) (Cont'd)

4. Discounts

Pricing discounts of 50% on nonrecurring charges are available for subscriber sites with three or more connections regardless of the class of service.

5. Definitions

ANSI - American National Standards Institute is a private, nongovernmental, non-profit organization.

BRIDGING - The linking of LANs at layer two (2) of the ISO OSI 7 layer Reference Mode. Bridge devices operate on networks having compatible Data Link Layer addressing schemes (such as IEEE 802.3 and IEEE 802.5), but are transparent to protocols of the Network and higher layers. Bridging makes multiple LANs appear as if they are on a contiguous network.

CLASS OF SERVICE - The definition of a CMDS service includes interface type and interface speed.

CMDS - Centel Metropolitan Data Services is a definition of services available within a metropolitan area.

FDDI - Fiber Distributed Data Interface is a 100-Megabit network developed by the American National Standards Institute. FDDI is designed for both LAN and MAN configurations. FDDI has four (4) component standards covering the physical and data-link layers of the ISO Reference Model.

IEEE - The Institute of Electrical and Electronics Engineers is a professional organization providing educational services to its members and developing standards in the area of electrical engineering and computing.

INTER-NETWORKING - Inter-networking is the linking of networks. Network to network communications inspired the need for the OSI Reference Model first published in 1978.

## GENERAL EXCHANGE TARIFF

Embarq Florida, Inc.

SECTION A128

By: F.B. Poag  
Director

Third Revised Sheet 11  
Cancelling Second Revised Sheet 11  
Effective: September 18, 2002

### OBSOLETE SERVICE OFFERING

#### DATA TRANSPORT SERVICE

#### C. CENTEL METROPOLITIAN DATA SERVICES (CMDS) (Central Telephone exchanges only) (Cont'd)

##### 5. Definitions (Cont'd)

ISO - International Organization for Standardization produces international standards and is a voluntary, nontreaty organization founded in 1946. Its members are the national standards organizations of the 89 member countries. The U.S. representative in ISO is ANSI.

LAN - A Local Area Network is a collection of computing devices connected together to form a network, typically within a single site or building. LANs were initially conceived to provide interconnection of computing assets available at one site. MAC - Medium Access Control frames are used for network management. In the seven layer Open Systems Interconnection (OSI) model, the MAC layer is in the lower half of layer 2. There are 25 different types of MAC frames, and these are divided into four categories: Medium Control, which is concerned with the reliable operation of the network; Station Initialization, which is used when a station wishes to join the ring; Error Monitoring, which indicates soft errors that have occurred; and Network management, which controls the network configuration and station parameters.

MAC - Medium Access Control frames are used for network management. In the seven layer Open Systems Interconnection (OSI) model, the MAC layer is in the lower half of layer 2. There are 25 different types of MAC frames, and these are divided into four categories: Medium Control, which is concerned with the reliable operation of the network; Station Initialization, which is used when a station wishes to join the ring; Error Monitoring, which indicates soft errors that have occurred; and Network management, which controls the network configuration and station parameters.

MAN - A Metropolitan Area Network is a network that covers an entire city. A MAN network interconnects many networks into a Metropolitan network and extends beyond the scope of a LAN, which is typically within a single office, site or building.

NATIVE SPEED - The speed (bit rate) equal to the full rate of speed at which a given LAN operates.

OSI - Open System Interconnection

OSI REFERENCE MODEL - The Open Systems Interconnection Reference Model is designed as a standard to allow various "open" systems to communicate. An open system is standards-based instead of proprietary-based. 802.3 - Part of the IEEE developed body of LAN standards. Colloquially known as Ethernet, 802.3 runs over coax, copper, or fiber at 10 megabits per second.

802.3 - Part of the IEEE developed body of LAN standards. Colloquially known as Ethernet, 802.3 runs over coax, copper, or fiber at 10 megabits per second.

802.5 - Also a LAN standard out of IEEE, known as Token Ring, 802.5 operates at 4 or 16 megabits per second.



GENERAL EXCHANGE TARIFF

Embarq Florida, Inc.

By: F.B. Poag  
Director

SECTION A128  
Third Revised Sheet 12  
Cancelling Second Revised Sheet 12  
Effective: September 18, 2002

OBSOLETE SERVICE OFFERING

DATA TRANSPORT SERVICE

C. CENTEL METROPOLITIAN DATA SERVICES (CMDS) (Central Telephone exchanges only) (Cont'd)

6. Rates and Charges

- a. The following rates include the elements of demarcation, port electronics at the subscriber's premises, the local channel and the company's MAN switching system function.
- b. Nonrecurring charges apply for each service terminated at the customer's premises. For the installation of local channels when more than one of the same type of service, within the same building at the same premises for the same customer is ordered and installed, the first and second ports at each location are billed at the first and second NRC rate and the others are billed at the third and additional NRC rate; regardless of date of installation.
- c. Discounts of monthly recurring charges are also provided dependent upon the number of ports per building and the total number of ports per customer. Discounts of monthly rates are not available for Class 4.
- d. The rates shown in this tariff are based on costs associated with the installation of typical customer loops. Where a special type of customer loop installation is desired by the subscriber or where the individual requirements of a particular situation makes the installation unusually expensive, the subscriber is required to bear the excess as specified in Section A5 of this tariff.

GENERAL EXCHANGE TARIFF

Embarq Florida, Inc.

By: F.B. Poag  
Director

SECTION A128  
Fourth Revised Sheet 13  
Cancelling Third Revised Sheet 13  
Effective: April 13, 2003

OBSOLETE SERVICE OFFERING

DATA TRANSPORT SERVICE

C. CENTEL METROPOLITAN DATA SERVICES (CMDS) (Central Telephone Exchanges Only) (Cont'd)

6. Rates and Charges (Cont'd)

e. Monthly Recurring Rates - Per Port - Same Building

0-80 Ports Per Customer

	<u>Discount</u>	<u>Class 4</u>	<u>Class 5</u>	<u>Class 6</u>	<u>Class 7</u>	<u>Class 9</u>
1-2	0%	\$400.00	\$500.00	\$545.00	\$610.00	\$2,000.00
3-5	11%	400.00	445.00	472.00	534.00	1,780.00
6-9	13%	400.00	435.00	461.00	522.00	1,740.00
10-13	15%	400.00	425.00	451.00	10.00	1,700.00
14-21	17%	400.00	415.00	440.00	498.00	1,660.00
22-33	19%	400.00	405.00	429.00	486.00	1,620.00

81-160 Ports Per Customer

	<u>Discount</u>	<u>Class 4</u>	<u>Class 5</u>	<u>Class 6</u>	<u>Class 7</u>	<u>Class 9</u>
1-2	4%	\$375.00	\$480.00	\$509.00	\$576.00	\$1,920.00
3-5	13%	375.00	435.00	461.00	522.00	1,740.00
6-9	15%	375.00	425.00	451.00	510.00	1,700.00
10-13	17%	375.00	415.00	440.00	498.00	1,660.00
14-21	19%	375.00	405.00	429.00	486.00	1,620.00
22-33	21%	375.00	395.00	419.00	474.00	1,580.00

GENERAL EXCHANGE TARIFF

Embarq Florida, Inc.

SECTION A128

By: F.B. Poag  
Director

Third Revised Sheet 14  
Cancelling Second Revised Sheet 14  
Effective: September 18, 2002

OBSOLETE SERVICE OFFERING

DATA TRANSPORT SERVICE

C. CENTEL METROPOLITAN DATA SERVICES (CMDS) (Central Telephone Exchanges Only) (Cont'd)

6. Rates and Charges (Cont'd)

e. Monthly Recurring Rates - Per Port - Same Building

161-240 Ports Per Customer

	<u>Discount</u>	<u>Class 4</u>	<u>Class 5</u>	<u>Class 6</u>	<u>Class 7</u>	<u>Class 9</u>
1-2	6%	\$375	\$470	\$498	\$564	\$1,880
3-5	15%	375	425	451	510	1,700
6-9	17%	375	415	440	498	1,660
10-13	19%	375	405	429	486	1,620
14-21	21%	375	395	419	474	1,580
22-33	23%	375	385	408	462	1,540

241-320 Ports Per Customer

	<u>Discount</u>	<u>Class 4</u>	<u>Class 5</u>	<u>Class 6</u>	<u>Class 7</u>	<u>Class 9</u>
1-2	8%	\$375	\$460	\$488	\$552	\$1,840
3-5	17%	375	415	440	498	1,660
6-9	19%	375	405	429	486	1,620
10-13	21%	375	395	419	474	1,580
14-21	23%	375	385	408	462	1,540
22-33	25%	375	375	398	450	1,500

321 and Above Ports Per Customer

	<u>Discount</u>	<u>Class 4</u>	<u>Class 5</u>	<u>Class 6</u>	<u>Class 7</u>	<u>Class 9</u>
1-2	10%	\$375	\$450	\$477	\$540	\$1,800
3-5	19%	375	405	429	486	1,620
6-9	21%	375	395	419	474	1,580
10-13	23%	375	385	408	462	1,540
14-21	25%	375	375	398	450	1,500
22-33	27%	375	365	387	438	1,460

GENERAL EXCHANGE TARIFF

Embarq Florida, Inc.

By: F.B. Poag  
Director

SECTION A128  
Second Revised Sheet 15  
Cancelling First Revised Sheet 15  
Effective: November 21, 2002

OBSOLETE SERVICE OFFERING

DATA TRANSPORT SERVICE

C. CENTEL METROPOLITAN DATA SERVICES (CMDS) (Central Telephone Exchanges Only)  
(Cont'd)

6. Rates and Charges (Cont'd)

f. Nonrecurring Installation Charges

	First and Second NRC	Additional NRC
	<u>First and Second Ports</u>	<u>Third and Additional Ports</u>
Class 4, Per Port	\$1,275	\$ 637.50
Class 5, Per Port	1,375	687.50
Class 6, Per Port	1,475	737.50
Class 7, Per Port	1,500	750.00
Class 9, Per Port	2,200	1,100.00

D. DATAPATH SERVICE (Central Telephone Exchanges Only)

1. General

- a. Datapath provides direct network data transmission capabilities through digital central office facilities. This service is offered only in those central offices equipped for Datapath.
- b. Datapath supports asynchronous and synchronous dial up or dedicated data transmission and transports data at rates up to 64 Kbps over a standard unloaded, two-wire subscriber access line.
- c. Station user equipment is not included in the rate for this service.

2. Rates and Charges

- a. The rate for Datapath is in addition to Centrex access line charges found in Section A11, A25, and A112 of this tariff.
- b. Normal service order charges found in Section A4 of this tariff apply for the installation of the service.
- c. Rates

	<u>Nonrecurring Charge</u>	<u>Monthly Rate</u>
Datapath Line Card, each	\$50.00	\$12.60

GENERAL EXCHANGE TARIFF

Embarq Florida, Inc.

By: F. B. Poag  
Director

SECTION A129  
First Revised Contents Sheet 1  
Cancelling Original Contents Sheet 1  
Effective: November 17, 2001

OBSOLETE SERVICE OFFERING

DIGITAL NETWORK SERVICES

CONTENTS

	<u>SHEET</u>
A. FRAME RELAY SERVICE .....	1
1. General.....	1
2. Regulations .....	2
3. Obligations of the Customer.....	6
4. Obligations of the Company.....	8
5. Rates and Charges .....	9
B. INTEGRATED SERVICES DIGITAL NETWORK-PRIMARY RATE INTERFACE (ISDN-PRI).....	 11
1. General.....	11
2. Regulations .....	12
3. Definitions.....	13
4. Application of Rates .....	13
5. Service Components.....	14
6. Rates and Charges .....	16

GENERAL EXCHANGE TARIFF

Embarq Florida, Inc.

By: F. B. Poag  
Director

SECTION A129  
First Revised Sheet 1  
Cancelling Original Sheet 1  
Effective: April 15, 2001

OBSOLETE SERVICE OFFERING

DIGITAL NETWORK SERVICES

A. FRAME RELAY SERVICE

1. General

- a. This information formerly appeared in Section A29 and became obsolete on April 10, 2001. No new customers may subscribe to this service. This service will continue to be provided to existing customer(s) until such time as discontinued by the customer, the Company, or the Florida Public Service Commission, or the service can no longer be maintained by the Company.
- b. Frame Relay Service (FRS) is a "fast packet" network service that permits the transmission of data at speeds up to 1.544 Mbps using permanent virtual circuits.
- c. Permanent Virtual Circuits (PVCs) are logical circuits that define a specific bi-directional path for data sent by the customer to another location. These circuits are virtual because they are established in software tables and do not tie up capacity when not in use. This also allows multiple PVCs to be defined over a single access line, thereby providing a single access line the capability to transmit data to multiple destinations.
- d. In the operation of Frame Relay Service, Customer Premises Equipment (CPE) such as routers, encapsulate arriving data into variable length frames. These frames contain information identifying which PVC in the network should be used to forward the frame to the proper destination. The CPE then sends the frame into the Frame Relay network. The Frame Relay switch reads identifying information and routes the frame to the proper destination based on a pre-established PVC.
- e. The statistical multiplexing Frame Relay switches are able to provide shared network resources to end users of this service.
- f. Frame Relay Service conforms to the International Telecommunications Union (ITU), formerly the Consultative Committee for International Telegraph and Telephone (CCITT), and American National Standards Institute (ANSI) standards set forth in technical publications.
- g. Frame Relay Service, as provided for in this tariff section, is offered for intraLATA use only.
- h. The regulations and rates specified herein are in addition to the applicable regulations and rates specified in other sections of this tariff.
- i. The rates and charges set forth for Frame Relay Service provide for the furnishing of service where suitable facilities are available.

GENERAL EXCHANGE TARIFF

Embarq Florida, Inc.

By: F. B. Poag  
Director

SECTION A129  
First Revised Sheet 2  
Cancelling Original Sheet 2  
Effective: April 15, 2001

OBSOLETE SERVICE OFFERING

DIGITAL NETWORK SERVICES

A. FRAME RELAY SERVICE (Cont'd)

2. Regulations

a. Explanation of Terms

- 1) Committed Information Rate (CIR) - A monthly rate, based on the amount of subscriber data throughput that the Telephone Company will support under normal network conditions. CIR is administered per PVC. Any data burst beyond the CIR may be labeled Discard Eligible (DE) if the data transfer rate exceeds the CIR of the PVC being used. If the frame Relay network develops congestion, the frames marked DE may be discarded.

In Frame Relay Service, the retransmission of discarded frames is administered by the CPE. The CIR ordered on a PVC connecting to a 56 Kbps Frame Relay Access Line (FRAL) may not exceed 48 Kbps.

- 2) Customer Designated Location (CDL) - The geographic location designated by the customer at which an access component of the customer's service is first considered to enter the Company's network.
- 3) Frame - A sequence of contiguous bits delimited by beginning and ending flag sequences.
- 4) Frame Relay Access Line (FRAL) - Frame Relay Access Line provides access to the Frame Relay Service (FRS) network, connecting customer facilities at the Network Interface with a corresponding Frame Relay Port. The FRAL includes the provision of a port.
- 5) Permanent Virtual Circuit (PVC) - A Permanent Virtual Circuit (PVC) is a logical channel from one Frame Relay Port to another Frame Relay Port within the FRS Network. PVCs are provisioned on either 56 Kbps, 64 Kbps, or 1.544 Mbps ports, depending on the customer's data networking requirements. The actual throughput of aggregated PVC bandwidths in use at the same time on the same port cannot exceed the port speed.

A customer subscribing to a PVC will be referred to as the Controller of the FRAL. A customer may request data transmission capability to another customer. Both customers must have a FRAL. The Controller of the FRAL must have written permission from the Controller of the other FRAL in order to establish PVCs between the two customers. This document must be presented to the Company before the request can be processed.

The FRAL and PVC are ordered and billed independently and can have different customers as Controllers. A request by one customer to discontinue a PVC does not result in the disconnection of the FRAL. Only the Controller of a FRAL may authorize a disconnect of that FRAL.

GENERAL EXCHANGE TARIFF

Embarq Florida, Inc.

By: F. B. Poag  
Director

SECTION A129  
First Revised Sheet 3  
Cancelling Original Sheet 3  
Effective: April 15, 2001

OBSOLETE SERVICE OFFERING

DIGITAL NETWORK SERVICES

A. FRAME RELAY SERVICE (Cont'd)

2. Regulations (Cont'd)

a. Explanation of Terms (Cont'd)

6) Port - In a Frame Relay Service, ports are the physical entry points for Access Lines and the originating and termination points for PVCs. Ports include the electronic equipment used in connecting these service elements to the FRS network. Ports enable customers to allocate bandwidth to applications as needed at customer-designated transmission speeds of up to 56 Kbps, 64 Kbps or 1.544 Mbps. Port access is included in the FRAL but may be purchased separately if connecting to a Telephone Company approved access method to the Frame Relay network.

7) Protocol - A specific set of rules, procedures or conventions relating to format and timing of data transmission between two devices. A standard procedure that two data devices must accept and use to be able to understand each other.

Protocols break a file into equal parts called blocks or packets. These packets are sent and the receiving computer checks the arriving packet and sends an acknowledgment back to the sending computer. When a block is damaged in transit, an error occurs. The purpose of a protocol is to set up a mathematical way of measuring if the block came through accurately; and if it didn't, ask the distant end to re-transmit the block.

8) Statistical Multiplexing - A multiplexing technique in which time slots are dynamically allocated on the basis of need rather than being predefined. The data is typically transmitted on a first come, first served basis.

b. Frame Relay is provided to the customer in the form of the FRAL, PVC and the CIR. The FRAL forms the local access component which provides the customer access to the Frame Relay Network. A PVC must be ordered for transmission between any two locations. The CIR determines the speed the Telephone Company will support under normal operating conditions on a specific PVC.

c. The Company does not undertake to originate data, but offers the use of its service components, where available, to customers for the purpose of transporting customer-originated data.



GENERAL EXCHANGE TARIFF

Embarq Florida, Inc.

By: F. B. Poag  
Director

SECTION A129  
First Revised Sheet 4  
Cancelling Original Sheet 4  
Effective: April 15, 2001

OBSOLETE SERVICE OFFERING

DIGITAL NETWORK SERVICES

A. FRAME RELAY SERVICE (Cont'd)

3. Obligations of the Customer

- a. The customer's Frame Relay compatible terminal equipment has the responsibility for error correction. Frame Relay Service nodes may discard frames with errors and may discard frames when the network supporting FRS is in a state of congestion.
- b. Where FRS is available for use in connection with communications systems or equipment provided by a customer or user, the operating characteristics of such systems or equipment shall be such as not to interfere with any services offered by the Company. Such use is subject to the further provisions that the equipment provided by the customer or user does not endanger the safety of Company employees or the public; damage, harm, require change in or alteration of the equipment or other services of the Company interfere with the proper operation of the Company's equipment or otherwise injure the public in its use of the Company's services. Upon notice from the Company that the equipment provided by the customer or user is causing, or is likely to cause, such hazard or interference, the customer shall take such steps as shall be necessary to remove or prevent such hazard or interference.
- c. The customer, upon request, shall furnish such information as may be required to permit the Company to design and maintain the FRS it offers and to assure that the service arrangement is in compliance with the regulations contained herein.
- d. It shall be the responsibility of the customer to ensure the continuing compatibility of the customer-provided equipment that is used in conjunction with the FRS. The CPE shall be in compliance with rules and regulations as specified in Section A15 of this tariff.
- e. The customer shall be responsible for obtaining permission for the Company's agents or employees to enter the premises of the customer at any reasonable hour for the purpose of installing, inspecting, repairing, or upon termination of the service, removing the service components of the Company.
- f. The customer shall be responsible for the payment of a nonrecurring Trouble Location Charge as found in Section A4 of this tariff.
- g. The customer may only use a Frame Relay Access Line with Frame Relay Service.

GENERAL EXCHANGE TARIFF

Embarq Florida, Inc.

By: F. B. Poag  
Director

SECTION A129  
First Revised Sheet 5  
Cancelling Original Sheet 5  
Effective: April 15, 2001

OBSOLETE SERVICE OFFERING

DIGITAL NETWORK SERVICES

A. FRAME RELAY SERVICE (Cont'd)

4. Obligations of the Telephone Company

- a. The responsibility of the Company shall be limited to furnishing network equipment suitable for FRS and to the maintenance and operation of such equipment in a manner proper for such service. Subject to this responsibility, the Company shall not be responsible for the through transmission of signals generated by the customer-provided equipment or system, or for the quality of, or defects in, such transmission or the reception of signals by such equipment or systems.
- b. The Company shall not be responsible for installation, operation, or maintenance of any terminal equipment, data unit or communications system provided by the customer or user. The Company is not responsible for adapting FRS to the technological requirements of any specific customer equipment.
- c. When a customer orders a PVC which is relayed to other Local Exchange Carriers, Interexchange Carriers or other Frame Relay networks, the Company will provide advisory assistance as a part of the establishment of this PVC.
- d. The Company shall not be responsible to the customer or user if changes in any of the equipment, operations or procedures of the Company used in the provision of Frame Relay Service render any facilities provided by the customer or user obsolete or require modification or alteration of such equipment or system or otherwise affect its use or performance, provided the Company has met any applicable information disclosure requirements otherwise required by law.
- e. The Company undertakes the responsibility to maintain and repair the service which it furnishes. Network equipment installed by the Company on the customer's premises shall be and remain the property of the Company. The customer or user may not rearrange, disconnect, remove, attempt to repair, remote test, or interface with any network equipment installed by the Company without prior written consent by the Company.
- f. The Company, by written notice to the customer, may immediately discontinue the furnishing of FRS without incurring liability upon nonpayment of any sum due to the Company or a violation of any condition governing the furnishing of service.
- g. The Company has the service responsibility up to and including the network interface.

GENERAL EXCHANGE TARIFF

Embarq Florida, Inc.

By: F. B. Poag  
Director

SECTION A129  
First Revised Sheet 6  
Cancelling Original Sheet 6  
Effective: April 15, 2001

OBSOLETE SERVICE OFFERING

DIGITAL NETWORK SERVICES

A. FRAME RELAY SERVICE (Cont'd)

5. Rates and Charges

- a. The minimum contract period for Frame Relay Service is one month.
- b. When a customer orders additional PVCs, changes PVC assignments or changes the CIR on a PVC on a given FRS Port after the initial port installation, the Frame Relay PVC nonrecurring charge shall apply.
- c. Service Rearrangements

Service rearrangements are changes to existing (installed) services which do not result in a change in the physical location of the network interface. Changes in the physical location of the network interface are treated as moves and are described and charged for as set forth herein.

1) Additions to Service

- a) When service elements are added to an existing service, the added elements must meet the minimum period requirements associated with the service to which they are added.
- b) Related monthly rates and nonrecurring charges for addition(s) to service are the rates and charges in effect at the time of the addition(s).

2) Administrative Charge - An administrative charge will be applied whenever a change is made to a customer's Frame Relay configuration (including changes to existing group addressing) at the customer's request. Such changes are defined as those rearrangements necessary to add, delete, or rearrange the customer's configuration and changes of CIR on a PVC. Although multiple changes may be caused by such actions, only one administrative charge will apply.

GENERAL EXCHANGE TARIFF

Embarq Florida, Inc.

By: F. B. Poag  
Director

SECTION A129  
First Revised Sheet 7  
Cancelling Original Sheet 7  
Effective: April 15, 2001

OBSOLETE SERVICE OFFERING

DIGITAL NETWORK SERVICES

A. FRAME RELAY SERVICE (Cont'd)

5. Rates and Charges (Cont'd)

d. Rate Elements

- 1) Frame Relay Access Line (FRAL) - A nonrecurring charge and monthly rate both based on the speed of the port connection (i.e., 56 Kbps, 64 Kbps or 1.544 Mbps) apply per port for each physical connection to the network supporting FRS. The FRAL includes the provision of a port.
- 2) Frame Relay Port (FRP) - A monthly rate based on the speed of the port connection (i.e., 56 Kbps, 64 Kbps or 1.544 Mbps) applies per port connection to the network supporting FRS. The port rate element can be used in lieu of the FRAL element if the customer has an alternative Company approved access to the Frame Relay Network.
- 3) Frame Relay PVC (FR-PVC) - A nonrecurring charge applies for the establishment of each PVC and for each subsequent order of PVC(s).
- 4) CIR - A monthly charge based on the desired Telephone Company supported speed of each PVC. The CIR ordered on a PVC connecting to a 56 Kbps FRAL cannot exceed 38.4 Kbps. The CIR ordered on a PVC connecting to a 64 Kbps FRAL cannot exceed 48 Kbps.
- 5) Administrative Charge - Applies to changes in a customer's network configuration such as additions or changes of PVCs. Although multiple changes can be caused by such actions, only one administrative charge applies.

GENERAL EXCHANGE TARIFF

Embarq Florida, Inc.

By: F. B. Poag  
Director

SECTION A129  
First Revised Sheet 8  
Cancelling Original Sheet 8  
Effective: April 15, 2001

OBSOLETE SERVICE OFFERING

DIGITAL NETWORK SERVICES

A. FRAME RELAY SERVICE (Cont'd)

5. Rates and Charges (Cont'd)

e. Term Discounts

- 1) FRS is available on a month-to-month basis or under variable rate periods, with rates based on 36 and 60-month lengths.
- 2) FRS rates under any Term payment Plan are exempt from customer-initiated changes for the payment period selected. Rates in effect at the time the service is installed and/or as of the service order application date will be applicable until the contract expires. At the expiration date of the customer's payment period option, the customer may select a new payment period option at current rates or may revert to current month-to-month rates.
- 3) If the customer disconnects any portion of their Frame Relay service prior to the end of month 12, the customer will be liable for 100% of the payments remaining for the first twelve months and 50% of the payment remaining in the contract period.

If the customer disconnects any portion of their FRS after the end of the 12th month, the customer will be liable for 50% of the payments remaining for the remainder of the contract period. Termination Liability charges do not apply to requests for moves of service.

GENERAL EXCHANGE TARIFF

Embarq Florida, Inc.

By: F. B. Poag  
Director

SECTION A129  
Second Revised Sheet 9  
Cancelling First Revised Sheet 9  
Effective: June 1, 2002

OBSOLETE SERVICE OFFERING

DIGITAL NETWORK SERVICES

A. FRAME RELAY SERVICE (Cont'd)

5. Rates and Charges (Cont'd)

f. Rates

		<u>Nonrecurring</u>	<u>Monthly Rates</u>	<u>36 Months</u>	<u>60 Months</u>
1)	Frame Relay Access Line and Port				
	a) 56 Kbps	\$ 590.00	\$ 117.20	\$ 110.00	\$ 100.00
	b) 64 Kbps	590.00	117.20	110.00	100.00
	c) 128 Kbps	750.00	225.00	215.00	205.00
	d) 256 Kbps	750.00	325.00	315.00	300.00
	e) 384 Kbps	750.00	400.00	385.00	370.00
	f) 1.544 Mbps	1,330.00	512.75	495.00	475.00
2)	Frame Relay Port				
	a) 56 Kbps	\$ 200.00	\$ 55.00	\$ 51.00	\$ 45.00
	b) 64 Kbps	200.00	55.00	51.00	45.00
	c) 128 Kbps	360.00	100.00	95.00	88.00
	d) 256 Kbps	360.00	180.00	173.00	165.00
	e) 384 Kbps	360.00	235.00	227.00	215.00
	f) 1.544 Mbps	585.00	400.00	385.00	NA*

\* NA = Not applicable

GENERAL EXCHANGE TARIFF

Embarq Florida, Inc.

By: F. B. Poag  
Director

SECTION A129  
Second Revised Sheet 10  
Cancelling First Revised Sheet 10  
Effective: June 1, 2002

OBSOLETE SERVICE OFFERING

DIGITAL NETWORK SERVICES

A. FRAME RELAY SERVICE (Cont'd)

5. Rates and Charges (Cont'd)

f. Rates (Cont'd)

	<u>Nonrecurring</u>	<u>Monthly Rates</u>
3) CIR, Per PVC		
a) 2.4 Kbps	\$ 10.00	\$ 2.00
b) 4.8 Kbps	10.00	2.00
c) 9.6 Kbps	10.00	2.00
d) 19.2 Kbps	10.00	4.00
e) 38.4 Kbps	10.00	6.00
f) 48 Kbps	10.00	8.00
g) 64 Kbps	10.00	10.00
h) 128 Kbps	10.00	14.00
i) 256 Kbps	10.00	18.00
j) 384 Kbps	10.00	22.00
k) 512 Kbps	10.00	26.00
l) 640 Kbps	10.00	30.00
m) 768 Kbps	10.00	34.00
4) Administrative Charge	\$ 50.00	--

GENERAL EXCHANGE TARIFF

Embarq Florida, Inc.

By: F. B. Poag  
Director

SECTION A129  
Second Revised Sheet 11  
Cancelling First Revised Sheet 11  
Effective: August 7, 2002

OBSOLETE SERVICE OFFERING

DIGITAL NETWORK SERVICES

B. INTEGRATED SERVICES DIGITAL NETWORK-PRIMARY RATE INTERFACE (ISDN-PRI)

1. General

- a. This information formerly appeared in Section A29 and became obsolete on July 5, 2001. No new customers may subscribe to this service. This service will continue to be provided to existing customer(s) until such time as discontinued by the customer, the Company, or the Florida Public Service Commission, or the service can no longer be maintained by the Company
- b. ISDN-PRI is an IntraLATA group of offerings supported by the Integrated Services Digital Network (ISDN) architecture.
- c. ISDN-PRI provides a method of access to the telephone network called Primary Rate Interface. PRI is an ISDN based T1 link to the telecommunications network and provides integrated digital channels for voice, data and video applications. The service will initially provide connectivity between an ISDN PBX or other ISDN compatible Customer Premises Equipment (CPE) and a serving central office. The basic channel structure for PRI is twenty-three 64 Kbps B channels and one 64 Kbps D channel. The B channels may be used to connect the PBX or ISDN compatible CPE to the public network (i.e., inward/outward calls, OutWats/TFC, or to tie lines, and FX service access lines). The D channel carries the signaling and call set-up information for the B channels.
- d. ISDN-PRI is a service for the transmission of digital signals only.
- e. Unless otherwise specified, the regulations for ISDN-PRI specified herein apply in addition to the regulations set forth in Section A20 A. And D. of this tariff.
- f. ISDN-PRI is provided within a LATA from wire centers where appropriate ISDN facilities are available, as determined by the Company. Service inquiries will be necessary to determine availability. If new equipment or facilities and/or changes to existing equipment/facilities are required for the provision of this service, special construction charges will apply as specified in Section A5, in addition to the applicable ISDN-PRI rates.



GENERAL EXCHANGE TARIFF

Embarq Florida, Inc.

By: F. B. Poag  
Director

SECTION A129  
First Revised Sheet 12  
Cancelling Original Sheet 12  
Effective: November 17, 2001

OBSOLETE SERVICE OFFERING

DIGITAL NETWORK SERVICES

B. INTEGRATED SERVICES DIGITAL NETWORK-PRIMARY RATE INTERFACE (ISDN-PRI)

2. Regulations

- a. Provisioning of CPE that is compatible with the ISDN-PRI interface is the responsibility of the user.
- b. The Company shall not be responsible if changes in any of the equipment, operations, or procedures of the Company utilized in the provision of ISDN-PRI render any facilities provided by the customer obsolete or require modification or alteration of such equipment or system or otherwise affect its use or performance.
- c. Digital transmission rates at speeds less than those indicated may be accomplished as a function of the particular CPE furnished by the user.
- d. Suspension of service is not permitted with this service.
- e. Regulations for Allowance of Interruptions apply as specified in Section A2 of this tariff.
- f. The minimum subscription period for which month-to-month PRI is furnished and for which charges are applicable is one month.
- g. OutWATS/TFC services utilizing ISDN-PRI are available in Section A19, tie lines are available in A20 and FX/FCO are available in A9.
- h. Verification and Emergency Interrupt service is not available for ISDN-PRI.
- i. Telephone numbers transmitted via the Calling Line Information feature are intended solely for the use of the ISDN-PRI subscriber or user. Resale of this information is prohibited by this tariff.
- j. Through Non-Facility Associated Signaling (NFAS), PRI can also be ordered with 24 B channels and no D channel. Under this option, the customer will order one ISDN-PRI service arrangement with 23 B channels and one D channel. Additional PRI services can then be provided with 24 B channels. The D channel on the initial PRI is used to control subsequent 24 B PRI circuits.

GENERAL EXCHANGE TARIFF

Embarq Florida, Inc.

By: F. B. Poag  
Director

SECTION A129  
First Revised Sheet 13  
Cancelling Original Sheet 13  
Effective: November 17, 2001

OBSOLETE SERVICE OFFERING

DIGITAL NETWORK SERVICES

B. INTEGRATED SERVICES DIGITAL NETWORK-PRIMARY RATE INTERFACE (ISDN-PRI)  
(Cont'd)

3. Definitions

- a. B Channel - A bi-directional synchronous channel capable of supporting 64 Kbps of digital transmission.
- b. D Channel - A 64 Kbps digital signaling-only channel for call establishment and routing used for ISDN-PRI.
- c. 64 Kbps Clear Channel Capability - A B channel connection which provides end-to-end digital connection in which all 64 Kbps of bandwidth are available for customer use.
- d. Virtual Facility Group(s) (VFG) - A VFG simulates lines and trunks in software. When VFG is accessed, the central office switch checks for the availability of virtual facilities. If none are available, the call is blocked. If a virtual facility is available, the call is re-translated, recorded and routed to the appropriate access service.

4. Application of Rates

- a. The Primary Rate Facility furnished between a Serving Wire Center and the customer's premises will be charged at rates and regulations contained in Section A20 A.10.d. All regulations of that tariff section will also apply.
- b. ISDN-PRI is available on a month-to-month basis or under variable rate periods, with rates based on lengths of 24-48 months, 49-72 months, or 73-96 months under conditions specified in this tariff except as modified following.
- c. ISDN-PRI service rates under any Term Payment Plan are exempt from customer-initiated changes for the payment period selected. Rates in effect at the time the service is installed and/or as of the service order application date will be applicable until the contract expires. At the expiration date of the customer's payment period option, the customer may select a new payment period option at current rates or revert to current rates on a month-to-month basis.

GENERAL EXCHANGE TARIFF

Embarq Florida, Inc.

By: F. B. Poag  
Director

SECTION A129  
Third Revised Sheet 14  
Cancelling Second Revised Sheet 14  
Effective: March 1, 2003

OBSOLETE SERVICE OFFERING  
DIGITAL NETWORK SERVICES

B. INTEGRATED SERVICES DIGITAL NETWORK-PRIMARY RATE INTERFACE (ISDN-PRI)  
(Cont'd)

4. Application of Rates (Cont'd)

- d. If a customer disconnects any portion of their ISDN-PRI service prior to the end of month 12, the customer will be liable for 100% of the payments remaining for the first twelve months and 50% of the payment remaining in the contract period. If a customer disconnects any portion of their ISDN-PRI service after the end of the 12th month, the customer will be liable for 50% of the payments remaining for the rest of the contract period. However, termination liability charges will not apply for customer requests for moves of service under Channel Services Payment Plans (CSPP) subject to the provisions in A20.
- e. Nonrecurring charges for PRI facility will not be applicable for a PRI when upgrading an existing circuit to ISDN-PRI.
- f. The customer may be restricted to 56 Kbps B channel transmission in some locations of the Company's interoffice network.
- g. Subscriber Line Charges are applicable per public switched network capable B channel as specified in the Interstate Access Tariff.
- h. NFAS, D Channel Backup, and dynamic call-by-call connections to FX and tie lines may not be available in all areas.

5. Service Components

- a. The required components for ISDN-PRI are as follows:
  - 1) Primary Rate Facility - Provides a four-wire access loop from the customer premises to the serving wire center. The transmission characteristics of this loop support Clear Channel Capability. See Section A20 D.
  - 2) Primary Rate Access - Provides the multiplexing to support up to 23 B channels at 64 Kbps and one D channel for signaling also at 64 Kbps. Up to 24 B channels at 64 Kbps can be provided for subsequent PRI's if the customer chooses the NFAS option.
  - 3) Primary Rate B Channels - Will provide network service that will allow either voice or data transmissions at up to 64 Kbps.

GENERAL EXCHANGE TARIFF

Embarq Florida, Inc.

By: F. B. Poag  
Director

SECTION A129  
Second Revised Sheet 15  
Cancelling First Revised Sheet 15  
Effective: August 7, 2002

OBSOLETE SERVICE OFFERING

DIGITAL NETWORK SERVICES

B. INTEGRATED SERVICES DIGITAL NETWORK-PRIMARY RATE INTERFACE (ISDN-PRI)  
(Cont'd)

5. Service Components (Cont'd)

a. The required components for ISDN-PRI are as follows: (Cont'd)

3) Primary Rate Channels (Cont'd)

- a) Customers will be billed a Network Access Register (NAR) charge per capable B channel. NAR rates depend on the rate group and can be found in Section A12 of this tariff.
- b) Data transmission on the B channel will be at 64 Kbps within the switch and between ISDN compatible central offices. ISDN-PRI interconnection to non-ISDN-PRI equipped central offices may potentially be subjected to analog transmission or subrated to 56 Kbps.
- c) The customer may choose to subscribe to additional non-exchange based services. Initial choices for these services will be OutWATS/TFC service, tie lines, and FX service. If ISA is used to dynamically connect B channels to FS, Tie and OutWATS, B channel charges are used in lieu of local channel charges for tie lines, FX, and OutWATS. Interoffice charges shall apply. The subscription to the services notes is in addition to the ISDN-PRI charges.

4) Call-by-Call/Integrated Service Access (ISA) Feature Capability - Allows the customers to dynamically allocate the use of channels for ISDN-PRI services. The customer may also choose voice or data transmission on a per call basis. ISA charges are based on the number of Virtual Facility Groups (VFG) established in the Company's central office. The Company will apply a VFG charge for each call type requested by the customer, for example, Public Access (incoming, outgoing), private network traffic, TFC, FC, tie line. Additional VFG charges may be applicable if the customer wishes the Company to provide more call control in the central office.

5) D Channel Access - Carries the signaling information for functional requirements of the ISDN B channels. Where end user access arrangements contain multiple PRI's the signaling in one interface structure may also carry signaling for B channels in another PRI structure without an activated D channel. The D channel contains Call Set Up, Call Tear Down, and Calling Number identification.

GENERAL EXCHANGE TARIFF

Embarq Florida, Inc.

BY: F. B. Poag  
Director

SECTION A129  
Second Revised Sheet 16  
Cancelling First Revised Sheet 16  
Effective: October 13, 2002

OBSOLETE SERVICE OFFERING  
DIGITAL NETWORK SERVICES

B. INTEGRATED SERVICES DIGITAL NETWORK-PRIMARY RATE INTERFACE (ISDN-PRI)  
(Cont'd)

5. Service Components (Cont'd)

a. The required components for ISDN-PRI are as follows: (Cont'd)

6) D Channel Backup - Provides backup for the D channel for a customer with multiple PRI lines by automatically switching signaling capability over to another D channel if service to the primary D channel is interrupted.

b. Calling Line Information Delivery - This feature, inherent in PRI, provides the customer with the telephone number of the calling party. Incoming call identification is provided via the D channel associated with incoming calls on a B channel(s) to a PBX. Calling Number Delivery Blocking is available as stipulated in A13 of this tariff.

6. Rates and Charges

	<u>Nonrecurring Charge</u>	<u>Month to Month</u>	<u>24 to 48 Months</u>	<u>49 to 72 Months</u>	<u>73 to 96 Months</u>
a. Primary Rate Facility, each	Rates located in Section A20				
b. PRI Access	\$ 300.00	\$335.00	\$285.00	\$260.00	\$225.00
c. B Channel					
United Telephone Exchanges Only	Rates based on NARs located in Section A12				
Central Telephone Exchanges Only	Rates found in Section A29.				
d. ISA, per VFG	50.00	15.00	15.00	15.00	15.00
e. D Channel Access	500.00	150.00	130.00	120.00	110.00
f. D Channel Backup	300.00	150.00	130.00	120.00	110.00
g. Move Charges					
1)	A move charge will apply for each Primary Rate Facility moved to a new location in the same building. This move charge is an amount equal to one half of the nonrecurring charge, Service Change Charge and Premises Visit Charge, as found in Section A4 of this tariff.				
2)	A move charge will also apply for ISDN-PRI service moved to a new location in the Company's territory. This move charge is equal to the sum of all nonrecurring charges, including service establishment applicable to a new ISDN-PRI service installation at the new location, as found in Section A4 of this tariff.				

GENERAL EXCHANGE TARIFF

Embarq Florida, Inc.

By: F. B. Poag  
Director

SECTION A139  
First Revised Contents Sheet 1  
Cancelling Original Contents Sheet 1  
Effective: April 27, 2000

OBSOLETE SERVICE OFFERING

ABBREVIATED DIALING

CONTENTS

	<u>SHEET</u>
A. N11 SERVICE .....	1
1. General .....	1
2. Service Requirements and Conditions .....	5
3. Advertisement Regulations for N11 Service.....	15
4. N11 Service Monthly Report.....	18
5. N11 Service Billing Information .....	19
6. Rates and Charges.....	19

GENERAL EXCHANGE TARIFF

Embarq Florida, Inc.

By: F. B. Poag  
Director

SECTION A139  
First Revised Sheet 1  
Cancelling Original Sheet 1  
Effective: April 27, 2000

OBSOLETE SERVICE OFFERING

ABBREVIATED DIALING

A. N11 Service

This information formerly appeared in Section A39 and became obsolete on April 27, 2000. No new customers may subscribe to this service. These services will continue to be provided to the one existing customer in the Winter Park basic local calling area until such time as discontinued by the customer, the Company, or the Florida Public Service Commission, or the service can no longer be maintained by the Company.

1. General

- a. N11 Service is a three-digit local dialing arrangement, available in specified areas, with Embarq Florida, Inc., recording and rating of the call, for delivery of general information via voice grade facilities. The N11 subscriber may apply a charge to its end users, within the N11 subscriber's local calling area, for services delivered in response to calls to an N11 number. The Company will record and rate these calls on behalf of the N11 subscriber. The Company will bill calls on behalf of the N11 subscriber as an optional service.
- b. The Local Calling Area of the N11 Service subscriber will be the basic Local Calling Area defined in Section A3. of this Tariff, as facilities permit.

N11 Service will be made available in the following Basic Local Calling Areas:

- 1) United Telephone Exchanges:

Basic Local Calling Areas

Tier 1

Winter Park

GENERAL EXCHANGE TARIFF

Embarq Florida, Inc.

By: F. B. Poag  
Director

SECTION A139  
First Revised Sheet 2  
Cancelling Original Sheet 2  
Effective: April 27, 2000

OBSOLETE SERVICE OFFERING

ABBREVIATED DIALING

A. N11 Service (Cont'd)

1. General (Cont'd)

b. (Cont'd)

1) United Telephone Exchanges (Cont'd)

Overlapping basic local calling areas shall be addressed on a case-by-case basis. Such areas have been identified as follows:

Clermont -	To be excluded from Winter Park
Montverde -	To be included with Winter Park

- c. Only one N11 number will be assigned to an N11 subscriber or its affiliates, per local calling area.
- d. An "affiliate" (as used in c. above) of an N11 subscriber is an entity that directly, or indirectly through one of more intermediaries, controls, is controlled by, or is under common control with, the N11 subscriber. The term "control" (including the terms "controlling", "controlled by", and "under common control with") means the possession, direct or indirect, of the power to direct or cause the direction of the management and policies of an entity, whether through the ownership of voting securities, by contract, or otherwise.
- e. If the Company provides billing on behalf of the subscriber, the rules and regulations as defined in this Section will apply.
- f. To provide access to an N11 number to end users in another company's territory within the local calling area, the N11 subscriber must make appropriate arrangements with the company serving that territory.
- g. N11 Service can be delivered via regular exchange access lines (by individual business lines, PBX trunks, etc.).



GENERAL EXCHANGE TARIFF

Embarq Florida, Inc.

By: F. B. Poag  
Director

SECTION A139  
First Revised Sheet 3  
Cancelling Original Sheet 3  
Effective: April 27, 2000

OBSOLETE SERVICE OFFERING

ABBREVIATED DIALING

A. N11 Service (Cont'd)

1. General (Cont'd)

- h. This service is furnished subject to the availability of N11 numbers, or the availability for blocking of N11.
- i. Limitations and use of service as stated in Section A2 of this Tariff apply.
- j. Calls to a disconnected N11 number will be routed to intercept over the announcement facilities for a maximum of 60 days. The announcement provided may refer the caller to another telephone number.
- k. Directory Listings may be provided for N11 Service at rates and regulations as specified in Section A6 of this Tariff. The phrase "Charges Will Apply" will be included in the N11 Service listing at no additional charge.
- l. Local measured or message rate service charges will be collected from end users, subscribing to measured or message rate service, for calls to an N11 number, as facilities permit, in addition to the charge applied on behalf of the N11 subscriber.
- m. Access to N11 Service is not available to the following classes of service:
  - Pay Telephone Service
  - Hotel/Motel/Hospital Service
  - 1+
  - 0+, 0- (Credit Card, Third-Party Billing, Collect Calls)
  - 101XXXX
  - Cellular - Type 2A

GENERAL EXCHANGE TARIFF

Embarq Florida, Inc.

By: F. B. Poag  
Director

SECTION A139  
First Revised Sheet 4  
Cancelling Original Sheet 4  
Effective: April 27, 2000

OBSOLETE SERVICE OFFERING

ABBREVIATED DIALING

A. N11 Service (Cont'd)

1. General (Cont'd)

- n. Operator assisted calls to an N11 subscriber will not be completed.
- o. N11 Service will not provide calling number information in real time to the N11 subscriber. If the N11 subscriber needs this type of information, the N11 subscriber must subscribe to a compatible Calling Number Identification service in Section A13 of this Tariff, as available.
- p. The N11 subscriber is restricted from selling or transferring the N11 number to an unaffiliated entity, either directly or indirectly.
- q. If an N11 subscriber becomes an affiliate of or is acquired by another N11 subscriber through merger, acquisition, or otherwise, then the affiliated subscribers must surrender all but one N11 number within 90 days of the merger or acquisition.
- r. If local calling areas are merged, and an N11 number exists in both areas, the N11 subscriber who established the N11 service first in time will be entitled to retain the N11 Service in the merged local calling area.
- s. If the basic local calling area of an exchange is expanded resulting in overlapping basic local calling areas, the established N11 local calling area for the effected exchange will not change. The Company reserves the right to redefine the associated basic local calling area for N11 where overlapping occurs and no N11 numbers exist in the associated local calling area prior to the overlap.

GENERAL EXCHANGE TARIFF

Embarq Florida, Inc.

By: F. B. Poag  
Director

SECTION A139  
First Revised Sheet 5  
Cancelling Original Sheet 5  
Effective: April 27, 2000

OBSOLETE SERVICE OFFERING

ABBREVIATED DIALING

A. N11 Service (Cont'd)

1. General (Cont'd)

- t. The N11 subscriber must comply with any rules, pertaining to N11 Service, adopted by the FCC in rulemaking proceeding (CC Docket 92-105).
- u. The N11 subscriber is prohibited from providing programming which involves live group interaction, such as "GAB" lines, "Chat" lines, or similar type programs where the primary purpose is for callers to interact with one another.

2. Service Requirements and Conditions

- a. A minimum usage charge will be billed to the N11 subscriber for any billing period in which the N11 subscriber's usage charges fall below the amount of the Minimum Usage Charge in A.3. of this Tariff section.
- b. The N11 subscriber must (1) obtain a new 7-digit number, (2) designate an existing non-published 7-digit number, or (3) change an existing published 7-digit number to a non-published number which will be established as the lead number in the hunt group, ACD, etc., of the subscriber. This 7-digit number must be non-published. When the N11 Service is disconnected or discontinued, the N11 subscriber must surrender this 7-digit number as part of the N11 Service. This 7-digit number can be either disconnected or a new 7-digit number can be assigned. Appropriate rates from Sections A.3. and A.4. of this Tariff will apply.

GENERAL EXCHANGE TARIFF

Embarq Florida, Inc.

By: F. B. Poag  
Director

SECTION A139  
First Revised Sheet 6  
Cancelling Original Sheet 6  
Effective: April 27, 2000

OBSOLETE SERVICE OFFERING

ABBREVIATED DIALING

A. N11 Service (Cont'd)

2. Service Requirements and Conditions (Cont'd)

- c. Use of N11 Service is subject to possible recall of the N11 code by the NANP (North American Numbering Plan) Administrator for national use. The N11 subscriber must, prior to provisioning of the service, sign a written acknowledgment of this condition and an agreement to return the code upon receipt of 6 months written notice of such a recall from the Company and abide by any subsequent rules which may be identified by the FCC regarding the use and return of such N11 codes. If a recall is effected by the NANP Administrator, the Company will work with all N11 subscribers affected by such recall to transfer their service arrangements, if technically and economically feasible at the time, to an abbreviated dialing arrangement, and if not feasible, to a seven-digit dialing arrangement, if technically and economically feasible at the time, within the 6-month notice period. The N11 subscriber will be required to migrate to any standard access arrangement for information services subsequently agreed to by the industry and approved by the FCC. The N11 subscriber will be charged the appropriate rates, as stated in A.6.b. of this tariff, for the establishment of the new access arrangement.
- d. The N11 Service is provided where facilities permit.
- e. N11 subscribers should work separately with cellular companies to ascertain whether Type 1 cellular customers will be able to reach information services provided by dialing an N11 number. Charges for calls to the N11 number made from cellular end users will be billed to the cellular company. This may require the N11 subscriber to enter into a contractual agreement with the cellular company to provide 3-digit access service and the billing associated with the service.

GENERAL EXCHANGE TARIFF

Embarq Florida, Inc.

By: F. B. Poag  
Director

SECTION A139  
First Revised Sheet 7  
Cancelling Original Sheet 7  
Effective: April 27, 2000

OBSOLETE SERVICE OFFERING

ABBREVIATED DIALING

A. N11 Service (Cont'd)

2. Service Requirements and Conditions (Cont'd)

f. N11 Service will be provided under the following conditions:

- 1) For network sizing and protection, each N11 subscriber must provide an estimate of annual call volumes, the expected busy hour and holding time for each call to an N11 number.
- 2) The Company report of the number of local calls completed to each N11 number will serve as the sole document upon which remittance will be made. In the event the Company's charges for calls exceed the revenue from billed calls, the subscriber will be liable for payment of the difference to the Company. Nonpayment of the N11 call billing by the end user shall not be cause for denial or termination of the end user's exchange telephone service.
- 3) The N11 subscriber is responsible for obtaining all necessary permission, licenses, written consents, waivers and releases and all other rights from all persons whose work, statements or performance are used in connection with the service, and from all holders of copyrights, trademarks, and patents used in connection with said service.
- 4) The N11 subscriber shall be liable for, and shall indemnify, protect, defend and save harmless the Company against all suits, actions, claims, demands and judgments, and of all costs, expenses and counsel fees incurred on account thereof, arising out of and resulting directly or indirectly from the Service or in connection therewith, including, but not limited to, any loss, damage, expense or liability resulting from any infringement or claim of infringement, of any patent, trademark, copyright, or resulting from any claim of liable and slander.

GENERAL EXCHANGE TARIFF

Embarq Florida, Inc.

By: F. B. Poag  
Director

SECTION A139  
First Revised Sheet 8  
Cancelling Original Sheet 8  
Effective: April 27, 2000

OBSOLETE SERVICE OFFERING

ABBREVIATED DIALING

A. N11 Service (Cont'd)

2. Service Requirements and Conditions (Cont'd)

f. N11 Service will be provided under the following conditions: (Cont'd)

- 5) Suspension of Service as covered in Section A.2. of this Tariff is not applicable for this service.
- 6) If the Company provides billing for N11 Service, when N11 Service is disconnected, all remittance money due to the N11 subscriber may be credited or applied to the final bill issued for the recurring charges associated with this Tariff.
- 7) If an N11 subscriber discontinues subscription to N11 Service, the N11 number will be disconnected.
- 8) Unless otherwise specifically provided in this Tariff, the Company shall be authorized to disconnect any tariffed service provided to the N11 subscriber utilized, directly or indirectly, with the N11 Service which fails to comply with regulations and conditions set forth herein, upon five (5) days written notice to the subscriber. Disconnection may be suspended at the discretion of the Company if it receives written certification that the N11 subscriber is in compliance with regulations and conditions of the tariffs. Continual noncompliance shall be cause for disconnection without notice at the discretion of the Company.

GENERAL EXCHANGE TARIFF

Embarq Florida, Inc.

By: F. B. Poag  
Director

SECTION A139  
First Revised Sheet 9  
Cancelling Original Sheet 9  
Effective: April 27, 2000

OBSOLETE SERVICE OFFERING

ABBREVIATED DIALING

A. N11 Service (Cont'd)

2. Service Requirements and Conditions (Cont'd)

f. N11 Service will be provided under the following conditions: (Cont'd)

- 9) The N11 subscriber is responsible for informing potential end users that a call to the N11 number will be at the charge the subscriber establishes and, if applicable, will be billed by the Company for calls from within the N11 subscriber's local calling area.

The N11 subscriber must notify the Company in writing at least 30 days in advance if the call charge is to be increased or decreased. Such charge shall begin on the date requested by the N11 subscriber. As a result, the N11 end user bills may show calls to the N11 number at different rates during the same billing period.

- 10) If the Company provides billing for N11 Service, descriptions to appear on the end user's bill must be specified by the N11 subscriber. If the N11 subscriber requires tax(es) to be billed to the end user, the tax(es) must be embedded in the N11 rate. The responsibility for tracking, reporting and remitting the tax(es) resides with the N11 subscriber.
- 11) The Company will rate the calls from end users of the N11 subscriber one charge per call to the N11 number.
- 12) The N11 subscriber shall subscribe to adequate exchange facilities to transport the calls to the N11 subscriber's premises.
- 13) The Company will not be responsible for recording and rating those calls that bypass the N11 routing.

GENERAL EXCHANGE TARIFF

Embarq Florida, Inc.

By: F. B. Poag  
Director

SECTION A139  
First Revised Sheet 10  
Cancelling Original Sheet 10  
Effective: April 27, 2000

OBSOLETE SERVICE OFFERING

ABBREVIATED DIALING

A. N11 Service (Cont'd)

2. Service Requirements and Conditions (Cont'd)

f. N11 Service will be provided under the following conditions: (Cont'd)

- 14) The N11 subscriber shall provide appropriate answer supervision for a minimum two-second duration for all calls completed to the N11 subscriber to ensure proper recording and rating for the service.
- 15) When end users are charged for services delivered in response to calls to an N11 number, the N11 subscriber must provide a preamble at the beginning of each N11 Service call for which the total charge exceeds \$3.00, stating the charge for the N11 Service call. The N11 subscriber must provide a preamble on all calls where there is a potential for minors (defined as under 18 years of age) to be attracted to the program, clear and conspicuous notification in language understandable to children of the requirement to obtain parental permission before placing or continuing with the call. The preamble message must be given within 15 seconds and must be followed by a 3 second period within which the caller can hang up without being charged the N11 service charge for the call. The N11 subscriber may allow a caller to affirmatively bypass a preamble. However, if the period of time from off-hook condition to on-hook condition is 18 seconds or less, the N11 Service charge will not be recorded or rated.

In addition, for those programs for which a preamble is not required, if the period of time from off-hook to on-hook condition is 18 seconds or less, recording and rating of the call to the N11 number will not occur.



GENERAL EXCHANGE TARIFF

Embarq Florida, Inc.

By: F. B. Poag  
Director

SECTION A139  
First Revised Sheet 11  
Cancelling Original Sheet 11  
Effective: April 27, 2000

OBSOLETE SERVICE OFFERING

ABBREVIATED DIALING

A. N11 Service (Cont'd)

2. Service Requirements and Conditions (Cont'd)

f. N11 Service will be provided under the following conditions: (Cont'd)

- 16) Children's programs shall not have rates in excess of \$5.00 per call and shall not include the enticement of a gift or premium.
- 17) No N11 subscriber shall promote N11 Service with the use of an autodialer or broadcasting of tones that dial an N11 number.
- 18) The N11 subscriber must prominently disclose the additional cost per minute or per call for any other telephone number that the caller is referred to either directly or indirectly.
- 19) Price changes to existing service must be submitted in writing to a Company designated representative at least thirty (30) days prior to the effective date of the price change.
- 20) The N11 subscriber will not charge callers to the N11 number a rate that exceeds a maximum of \$5.00 per call.
- 21) The N11 subscriber shall respond promptly to any and all complaints lodged with any regulatory authority against any service provided via the N11 number. If requested by the Company, the N11 subscriber shall assist the Company in responding to complaints made to the Company concerning the subscriber's N11 service.

GENERAL EXCHANGE TARIFF

Embarq Florida, Inc.

By: F. B. Poag  
Director

SECTION A139  
First Revised Sheet 12  
Cancelling Original Sheet 12  
Effective: April 27, 2000

OBSOLETE SERVICE OFFERING

ABBREVIATED DIALING

A. N11 Service (Cont'd)

2. Service Requirements and Conditions (Cont'd)

f. N11 Service will be provided under the following conditions: (Cont'd)

22) A written notice will be sent to any N11 subscriber following oral notification when their service unreasonably interferes with or impairs other services rendered to the public by the Company or by other subscribers of N11 Service. If after notification the subscriber makes no modification in method of operation or in the service arrangements that are deemed service-protective by the Company, or if the subscriber is unwilling to accept the modifications, or if the subscriber continues to cause service impairment, the Company reserves the right, at any time, without further notice, to institute protective measures, up to and including termination of service. In an emergency situation as defined by the Company, the Company reserves the right, at any time, without notice, to institute protective measures, up to and including termination of service.

g. If a pre-recorded announcement is provided by the N11 subscriber, the following conditions apply:

- 1) The N11 Service subscriber will provide announcements. The Company will provide only the delivery of the call.
- 2) N11 Subscriber sponsorship of any particular announcement of recorded program service shall not preclude another N11 subscriber from sponsoring the same or similar announcement or recorded program service.

GENERAL EXCHANGE TARIFF

Embarq Florida, Inc.

By: F. B. Poag  
Director

SECTION A139  
First Revised Sheet 13  
Cancelling Original Sheet 13  
Effective: April 27, 2000

OBSOLETE SERVICE OFFERING

ABBREVIATED DIALING

A. N11 Service (Cont'd)

2. Service Requirements and Conditions (Cont'd)

- g. If a pre-recorded announcement is provided by the N11 subscriber, the following conditions apply: (Cont'd)
  - 3) The provision of access to the N11 Network by the Company for the transmission of announcement or recorded program services is subject to availability of such facilities and the requirements of the local exchange network.
  - 4) The N11 subscriber assumes all financial responsibility for all costs involved in providing announcement or recorded program services including, but not limited to, the recorder announcement equipment producing the recording, advertising and promotional expenses.
  - 5) The N11 subscriber assumes, according to other specific rates and charges under tariff, all financial responsibility for all facilities required to connect the recorder announcement equipment located on the subscriber's premises.
  - 6) The subscriber has exclusive responsibility and control over the content, quality characteristics of speech used in the N11 program; the Company assumes no liability for the quality of, defects in, or contents of, the N11 program. The subscriber shall be responsible for the dissemination of the message or announcement in any matter the dissemination of which is prohibited by law.
- h. The Company may take all legal and practical steps to disassociate itself from N11 subscribers providing services whose business and/or public conduct (whether demonstrated or proposed) is of a type that generates unacceptable levels of complaints by end users.

GENERAL EXCHANGE TARIFF

Embarq Florida, Inc.

By: F. B. Poag  
Director

SECTION A139  
First Revised Sheet 14  
Cancelling Original Sheet 14  
Effective: April 27, 2000

OBSOLETE SERVICE OFFERING

ABBREVIATED DIALING

A. N11 Service (Cont'd)

2. Service Requirements and Conditions (Cont'd)

- i. In no event shall the Company be liable for any losses or damages of any kind resulting from the unavailability of its equipment or facilities or for any act, omission or failure of performance by the Company, or its employees, or agents, in connection with this Tariff. The Company shall not be responsible for calls that cannot be completed as a result of repair or maintenance difficulties on Company facilities and equipment nor on equipment owned or leased by the subscriber.
- j. The N11 Service subscriber must be located within the principle exchange of the Basic Local Calling Area in which it subscribes to N11 Service.
- k. If the N11 Service subscriber also subscribes to the Company's Billing and Collection service, the subscriber may choose itemized billing or aggregate (bulk) billing to the end user. Itemized billing will print on the end user's bill a separate line identifying each call made to the N11 Service number. Aggregate billing will print on the end user's bill one line to indicate the total number of calls made to the N11 Service number and the total amount of the charges for those calls.
- l. The Company shall not be liable for any losses or damages of any kind resulting from another local exchange Company in providing service on that portion of the service as described above (A139.A.2.i.) which is in the other local exchange company serving territory.

GENERAL EXCHANGE TARIFF

Embarq Florida, Inc.

By: F. B. Poag  
Director

SECTION A139  
First Revised Sheet 15  
Cancelling Original Sheet 15  
Effective: April 27, 2000

OBSOLETE SERVICE OFFERING

ABBREVIATED DIALING

A. N11 Service (Cont'd)

2. Service Requirements and Conditions (Cont'd)

m. The Company reserves the right to refuse and/or discontinue billing and collection services for any N11 provider whose advertising and/or programming is deemed, in the judgment of the company, to be harmful to the Company's reputation or corporate image, creates a financial nuisance for the Company, or has an inordinately high number of complaints received by the Company as a result of the N11 providers' advertising and/or programming.

3. Advertisement Regulations for N11 Service

a. All advertising inviting the use of or in any way relating to N11 Service shall conform to and comply with the requirements and conditions contained herein as well as all other applicable tariff provisions, rules, ordinances, laws and statutes.

b. The advertising for N11 Service shall comply with the following regulations:

- 1) Advertising may be distributed in any form that the subscriber chooses, provided it complies with and conforms to the specifications contained herein.
- 2) No advertising shall be permitted which, in form or substance, does not allow for an audit trail which is verifiable independent of the subscriber for review and confirmation, at any given moment, of compliance with the procedures and specifications set out herein, as well as in other applicable tariff provisions.

GENERAL EXCHANGE TARIFF

Embarq Florida, Inc.

By: F. B. Poag  
Director

SECTION A139  
First Revised Sheet 16  
Cancelling Original Sheet 16  
Effective: April 27, 2000

OBSOLETE SERVICE OFFERING

ABBREVIATED DIALING

A. N11 Service (Cont'd)

3. Advertisement Regulations for N11 Service (Cont'd)

- c. Each advertisement shall inform potential callers of the name of the person responsible for the advertisement, the charge for N11 calls, and if billing is provided by the Company that the charge will appear on the telephone bill from which the call is placed. This information shall be displayed with such clarity and prominence to permit it to be noticed and understood by prospective callers. In order to ensure that callers will have an adequate opportunity to notice and understand the foregoing information, advertisements inviting the use of or in any way relating to N11 Service will, at a minimum, be conducted in compliance with the following media-specific specifications.
  - 1) Print Media - Notice of the charge for each N11 call and, when applicable, the fact of inclusion of this charge on the telephone bill, and the telephone number of the person responsible for the advertisement shall be displayed on any printed material immediately above, below, or next to the N11 Service number in type size that can be seen as clearly and conspicuously as the N11 Service number.
  - 2) Audio or Verbal Media - Notice of the charge for each N11 call and, when applicable, the fact of the inclusion of the charge on the telephone bill shall be stated once during audio or verbal advertisements. This portion of the advertisement shall be broadcast at the same audio level with the same diction and pace as the remaining portions of the ad.

GENERAL EXCHANGE TARIFF

Embarq Florida, Inc.

By: F. B. Poag  
Director

SECTION A139  
First Revised Sheet 17  
Cancelling Original Sheet 17  
Effective: April 27, 2000

OBSOLETE SERVICE OFFERING

ABBREVIATED DIALING

A. N11 Service (Cont'd)

3. Advertisement Regulations for N11 Service (Cont'd)

c. (Cont'd)

3) Audio/Visual - Notice of the charge for each N11 call and, when applicable, the fact of inclusion of these charges on the telephone bill, and the person responsible for the advertisement shall be both displayed/broadcast during any audio/visual advertisement. When displayed, this information shall be shown for the same duration as the N11 Service number is shown. In all other respects, the advertisement shall conform to the specifications for print advertisements and audio or verbal advertisement set out in 1) and 2) preceding.

d. In addition to complying with the procedures stated preceding and all other specifications relating to the advertisement of the charge and bill consequences associated with N11 Service, each N11 subscriber shall comply with the following:

1) The N11 subscriber shall exclude from any advertisement any matter the dissemination of which is prohibited by law. No advertisement shall be used which, because of words, phrases, statements or illustrations therein or information omitted there from, has the capacity or tendency to mislead or deceive prospective callers as to the cost, extent, quality, caller's qualification or nature of any information or service to be received from an N11 call. The N11 subscriber shall respond promptly to any and all complaints lodged with any regulatory authority regarding advertisement for N11 Service. If requested by the Company, the N11 subscriber shall assist the Company in responding to complaints to the Company concerning advertisements for N11 Service.

GENERAL EXCHANGE TARIFF

Embarq Florida, Inc.

By: F. B. Poag  
Director

SECTION A139  
First Revised Sheet 18  
Cancelling Original Sheet 18  
Effective: April 27, 2000

OBSOLETE SERVICE OFFERING

ABBREVIATED DIALING

A. N11 Service (Cont'd)

3. Advertisement Regulations for N11 Service (Cont'd)

d. (Cont'd)

- 2) Where detailed and complete information concerning the N11 Service is prominently displayed in a publication, other references to the N11 Service within that publication need not repeat all of the information so long as each other reference clearly reflects that there is a charge for dialing the N11 Service number and where the complete information is located.

4. N11 Service Monthly Report

- a. The N11 Service Monthly Report is a monthly record of terminating traffic to the N11 subscriber per local calling area. The information in this report will include the calling telephone number, date, time of day, and call duration of each call received.
- b. The N11 Service Monthly Report will be provided via paper copy to the N11 subscriber.
- c. The N11 Service Monthly Report will be offered where facilities permit and where the Company's message billing process has been arranged to provide this optional feature.
- d. The N11 Service Monthly Report is not represented to be a provision of billing detail.
- e. Telephone numbers listed in the N11 Service Monthly Report are intended solely for the use of the N11 subscriber. Resale of this information is prohibited by this Tariff.



GENERAL EXCHANGE TARIFF

Embarq Florida, Inc.

By: F. B. Poag  
Director

SECTION A139  
First Revised Sheet 19  
Cancelling Original Sheet 19  
Effective: April 27, 2000

OBSOLETE SERVICE OFFERING

ABBREVIATED DIALING

A. N11 Service (Cont'd)

5. N11 Service Billing Information

- a. N11 Service Billing Information is offered for N11 subscribers that provide billing for the N11 Service. This billing information is a monthly record of terminating traffic to the N11 subscriber per local calling area. The information will include the calling telephone number, date, time of day, call duration of each call received, and the rate to be charged for the call.
- b. The N11 Service Billing Information will be provided via magnetic tape to the N11 subscriber.
- c. The N11 Service Billing Information will be offered where facilities permit and where the Company's message billing process has been arranged to provide this feature.

6. Rates and Charges

a. Application of Rates

- 1) Nonrecurring charges shall apply for each N11 number per local calling area.
- 2) If the Company provides billing to the end user on behalf of the N11 subscriber, the Company will render bills to end users in the Company's territory to whom the Company normally provides a monthly telephone bill. Billing and collection services will be provided at the rates and charges as stated following:
  - a) Per message with inquiry 0.0666
  - b) Bulk-billed message with inquiry 0.0096

In addition to the above message rates, a non-recurring charge as stated in A.6.b.8 will apply for the establishment of the billing and collection service per local calling area.

GENERAL EXCHANGE TARIFF

Embarq Florida, Inc.

By: F. B. Poag  
Director

SECTION A139  
First Revised Sheet 20  
Cancelling Original Sheet 20  
Effective: April 27, 2000

OBSOLETE SERVICE OFFERING

ABBREVIATED DIALING

A. N11 Service (Cont'd)

6. Rates and Charges (Cont'd)

a. Application of Rates (Cont'd)

- 3) N11 subscribers will pay the normal tariffed charges for the local exchange access arrangements (e.g., PBX trunks, Centrex service lines, etc.) used for transporting and terminating messages at the N11 subscriber's designated premises.
- 4) Applicable service order charges as specified in Section A4 of this Tariff will apply, in addition to the following rates.
- 5) A Minimum Usage Charge will be billed to the N11 subscriber in each billing period, in which the N11 subscriber's usage charges fall below the amount of the Minimum Usage Charge in b.5) following.

b. Charges applicable to the N11 Service Subscriber:

- 1) Establishment of N11 Service, per N11 Service number, per local Calling Area

	<u>Nonrecurring Charge</u>
a) Tier 1	\$15,000.00
- 2) Service Price Change by Subscriber

a) Per N11 Service Number, per Local Calling Area	225.00
--	--------

GENERAL EXCHANGE TARIFF

Embarq Florida, Inc.

By: F. B. Poag  
Director

SECTION A139  
First Revised Sheet 21  
Cancelling Original Sheet 21  
Effective: April 27, 2000

OBSOLETE SERVICE OFFERING

ABBREVIATED DIALING

A. N11 Service (Cont'd)

6. Rates and Charges (Cont'd)

b. (Cont'd)

3) Change of Point-to Number by Subscriber, per local Calling Area

	<u>Nonrecurring Charge</u>
a) Tier 1	\$240.00

4) Usage Charges

	<u>Rate</u>
a) Per message rate for the first 5 minutes or portion thereof	\$.10
b) Per minute charge for each message minute in excess of 5 minutes	\$.02

5) Minimum Usage Charge, per N11 Service Number, per Local Calling Area

a) Tier 1	\$2,900.00
-----------	------------

6) N11 Service Monthly Report  
Per occasion, Per Local Calling Area

	<u>Nonrecurring Charge</u>	<u>Monthly Rate</u>
a) Tier 1	\$ 200.00	\$ 90.00

GENERAL EXCHANGE TARIFF

Embarq Florida, Inc.

By: F. B. Poag  
Director

SECTION A139  
First Revised Sheet 22  
Cancelling Original Sheet 22  
Effective: April 27, 2000

OBSOLETE SERVICE OFFERING

ABBREVIATED DIALING

A. N11 Service (Cont'd)

6. Rates and Charges (Cont'd)

b. (Cont'd)

		Monthly <u>Rate</u>
7)	N11 Subscriber Billing Information Per Occasion, Per Local Calling Area	\$ 80.00
		Nonrecurring <u>Charge</u>
8)	Billing and Collection Per Local Calling Area	\$ 2,000.00

GENERAL EXCHANGE TARIFF

Embarq Florida, Inc.

By: F. B. Poag  
Director

Supplement Section 3  
First Revised Sheet 1  
Cancelling Original Sheet 1  
Effective: January 1, 1997

ALFORD EXCHANGE

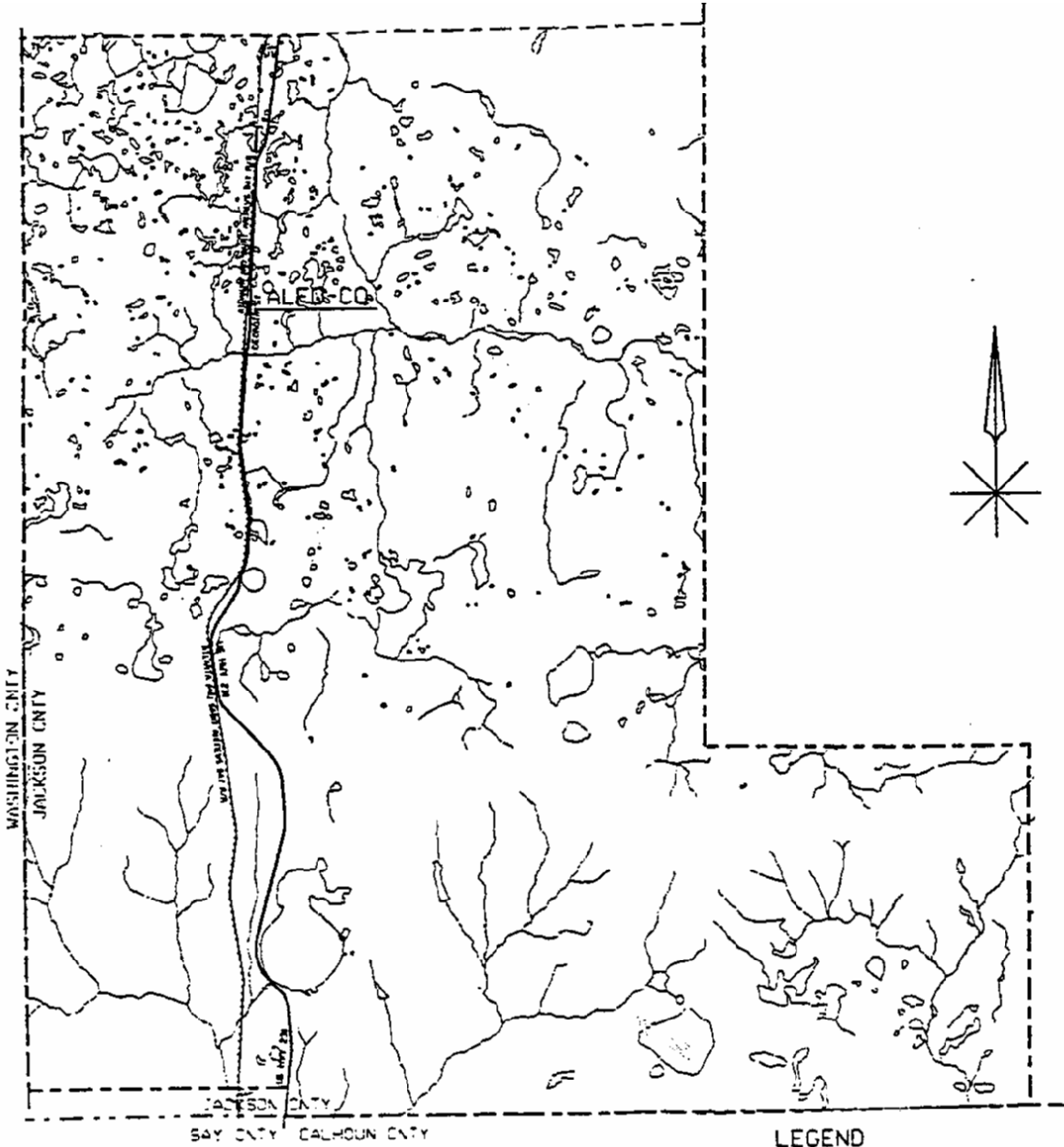

LEGEND

-----	EXCHANGE BOUNDARY
-----	COUNTY BOUNDARY
□ ALFO-CO	CENTRAL OFFICE LOCATION

GENERAL EXCHANGE TARIFF

Embarq Florida, Inc.

By: F. B. Poag  
Director

Supplement Section 3  
First Revised Sheet 2  
Cancelling Original Sheet 2  
Effective: January 1, 1997

APOPKA EXCHANGE

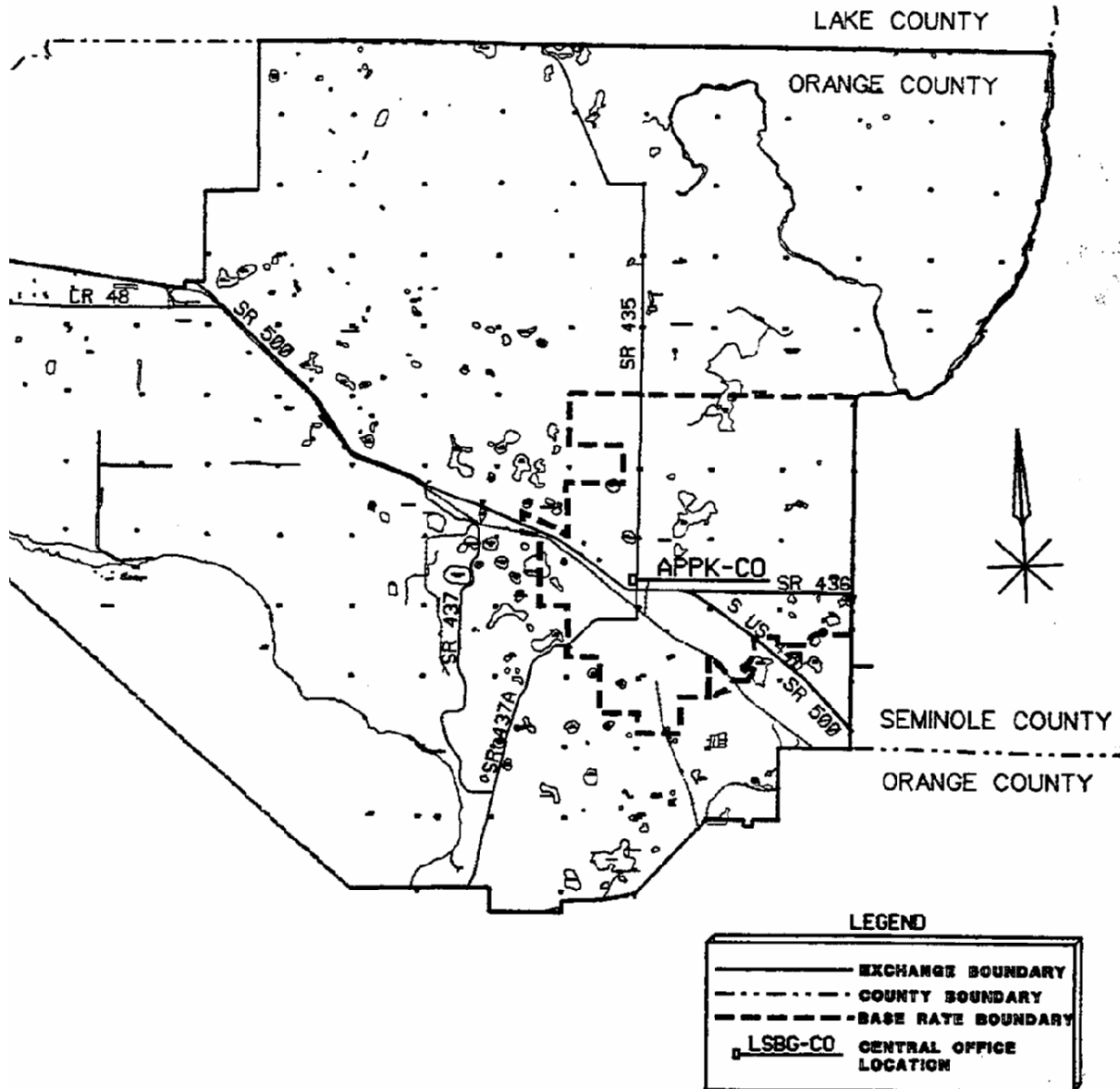

GENERAL EXCHANGE TARIFF

Embarq Florida, Inc.

By: F. B. Poag  
Director

Supplement Section 3  
First Revised Sheet 3  
Cancelling Original Sheet 3  
Effective: January 1, 1997

ARCADIA EXCHANGE

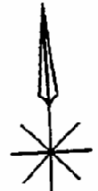
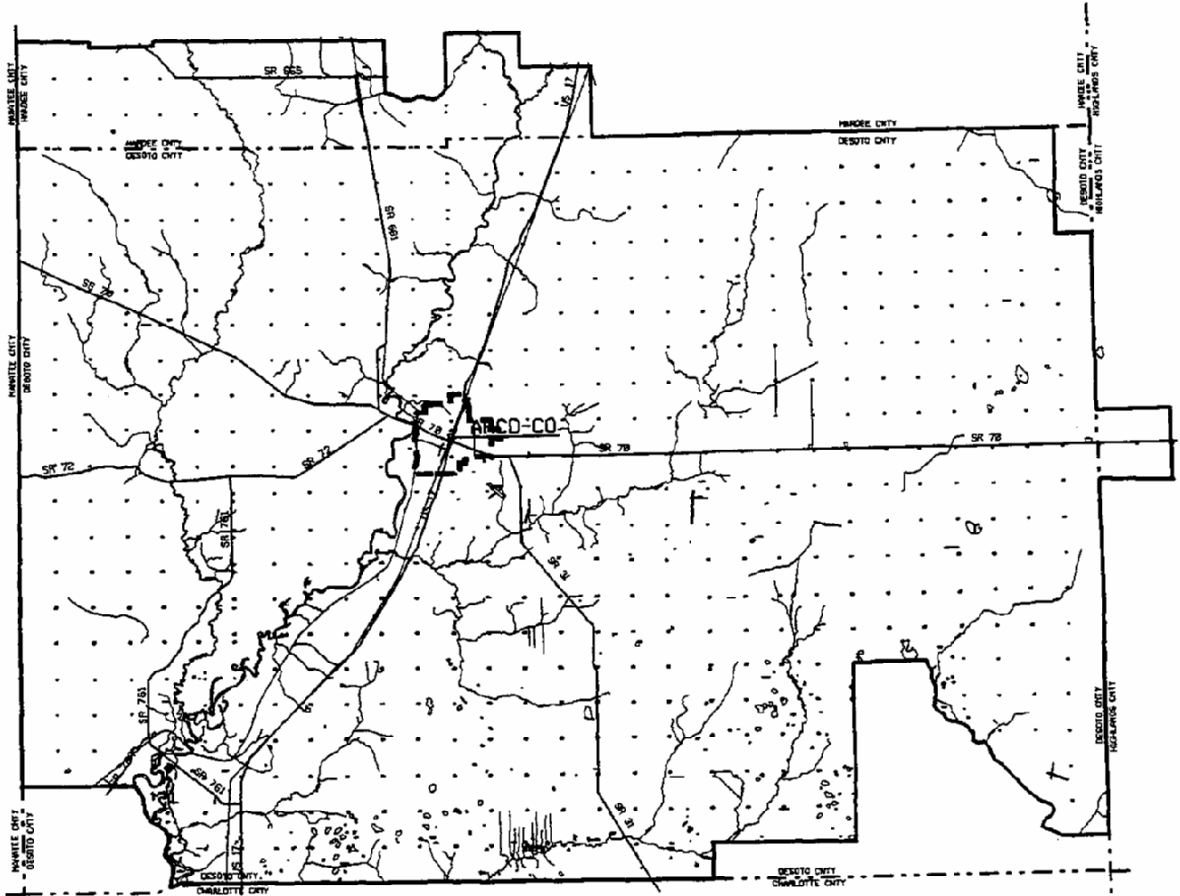

**LEGEND**

—	EXCHANGE BOUNDARY
- - -	COUNTY BOUNDARY
- · - ·	BASE RATE BOUNDARY
□	LSBG-CO CENTRAL OFFICE LOCATION

GENERAL EXCHANGE TARIFF

Embarq Florida, Inc.

By: F. B. Poag  
Director

Supplement Section 3  
First Revised Sheet 4  
Cancelling Original Sheet 4  
Effective: January 1, 1997

ASTOR EXCHANGE

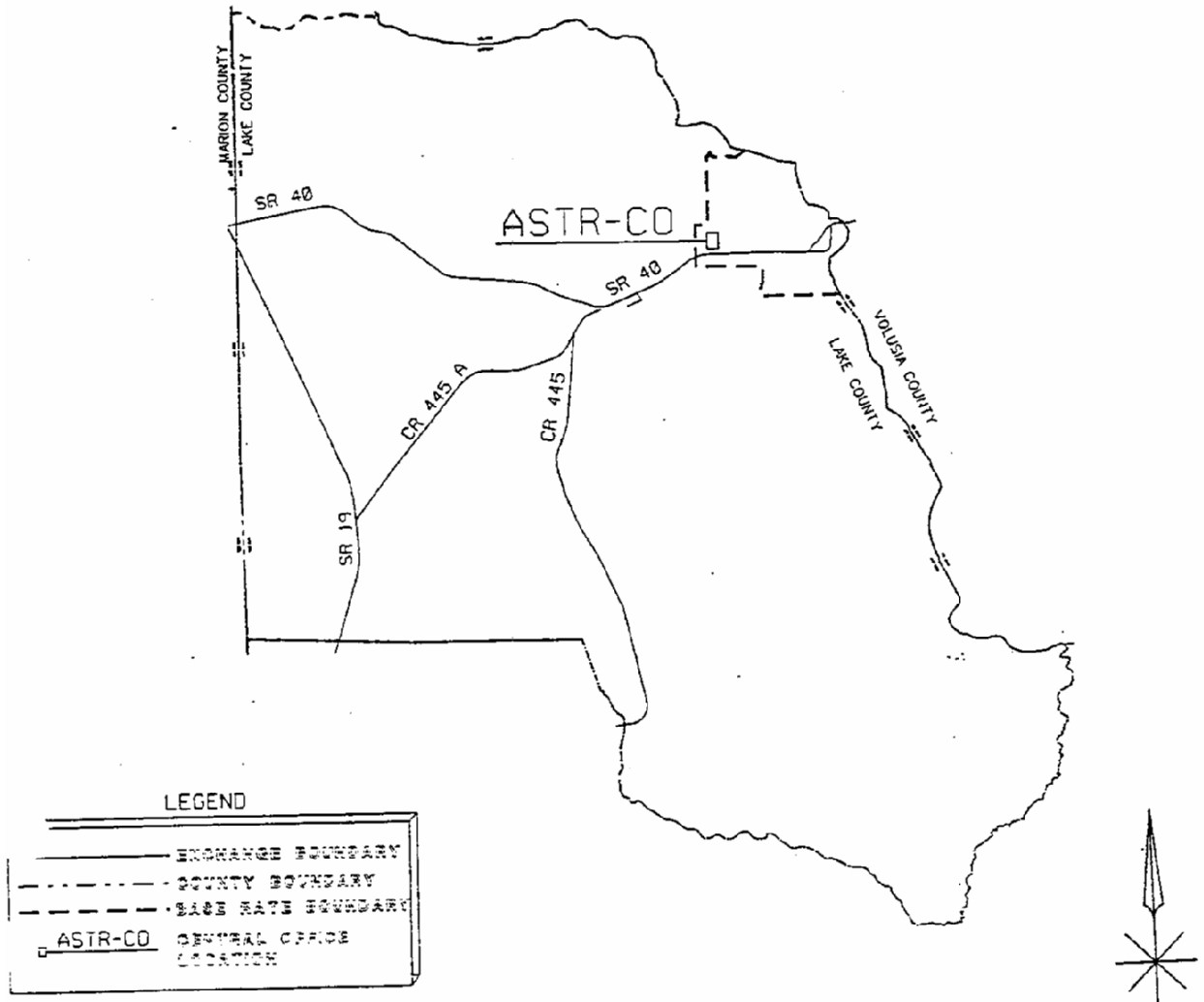



GENERAL EXCHANGE TARIFF

Embarq Florida, Inc.

By: F. B. Poag  
Director

Supplement Section 3  
First Revised Sheet 5  
Cancelling Original Sheet 5  
Effective: January 1, 1997

AVON PARK EXCHANGE

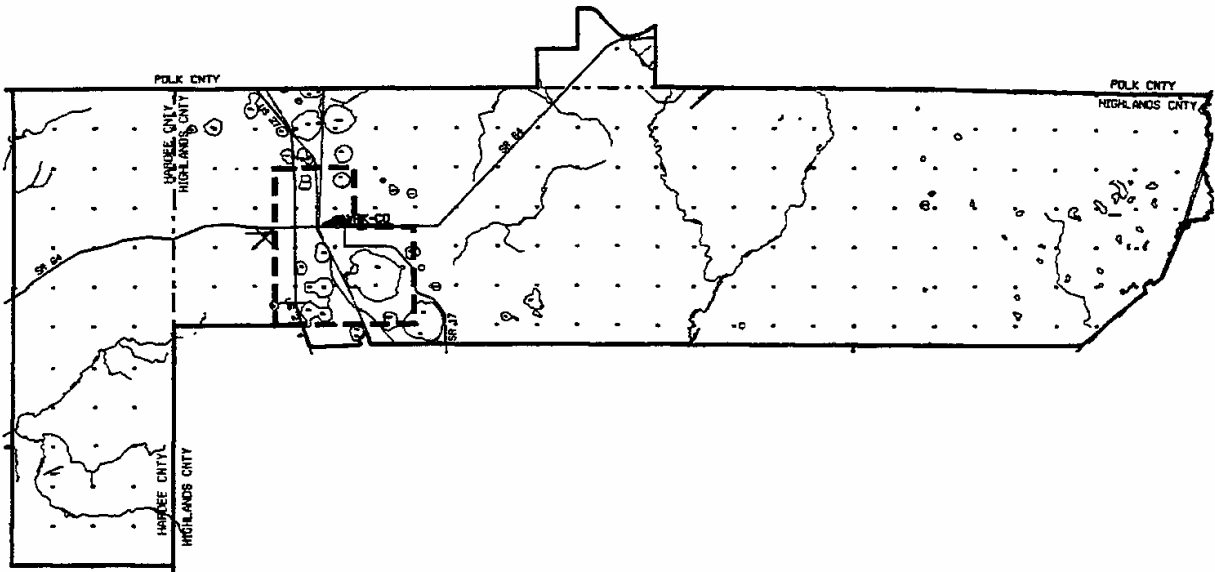

GENERAL EXCHANGE TARIFF

Embarq Florida, Inc.

By: F. B. Poag  
Director

Supplement Section 3  
First Revised Sheet 6  
Cancelling Original Sheet 6  
Effective: January 1, 1997

BAKER EXCHANGE

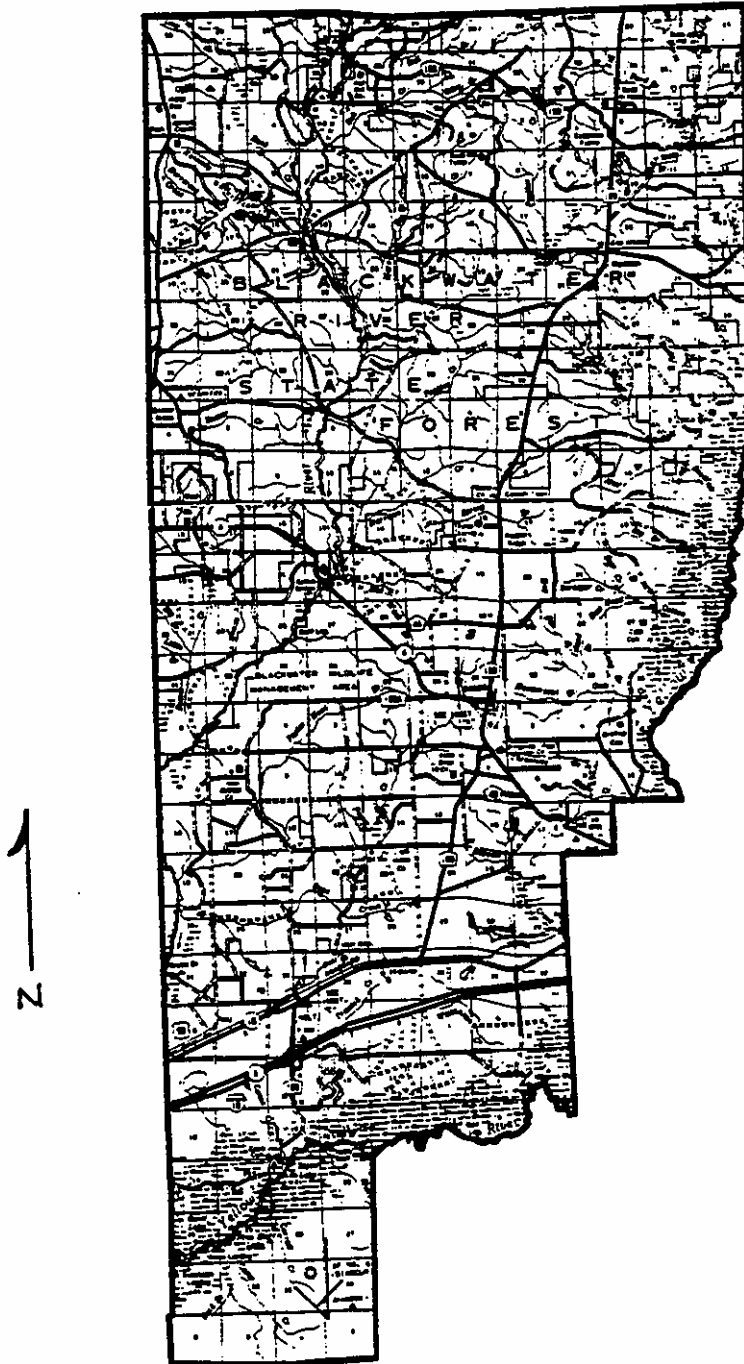

GENERAL EXCHANGE TARIFF

Embarq Florida, Inc.

By: F. B. Poag  
Director

Supplement Section 3  
Fourth Revised Sheet 7  
Cancelling Third Revised Sheet 7  
Effective: January 1, 2003

BELLEVIEW EXCHANGE

EXCHANGE SERVICE AREA MAP

**BELLEVIEW  
EXCHANGE**

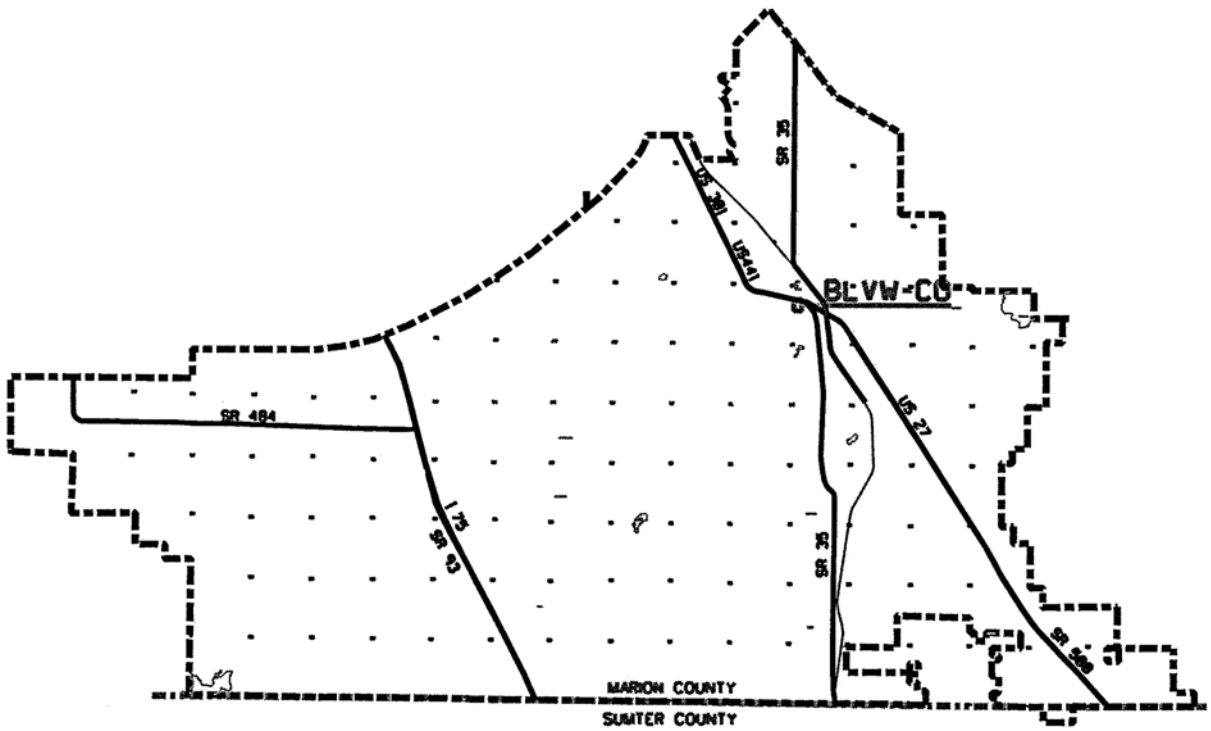

**LEGEND**

	EXCHANGE BOUNDARY
	COUNTY BOUNDARY
	CENTRAL OFFICE LOCATION

GENERAL EXCHANGE TARIFF

Embarq Florida, Inc.

By: F. B. Poag  
Director

Supplement Section 3  
Second Revised Sheet 8  
Cancelling First Revised Sheet 8  
Effective: September 22, 1999

BEVERLY HILLS EXCHANGE

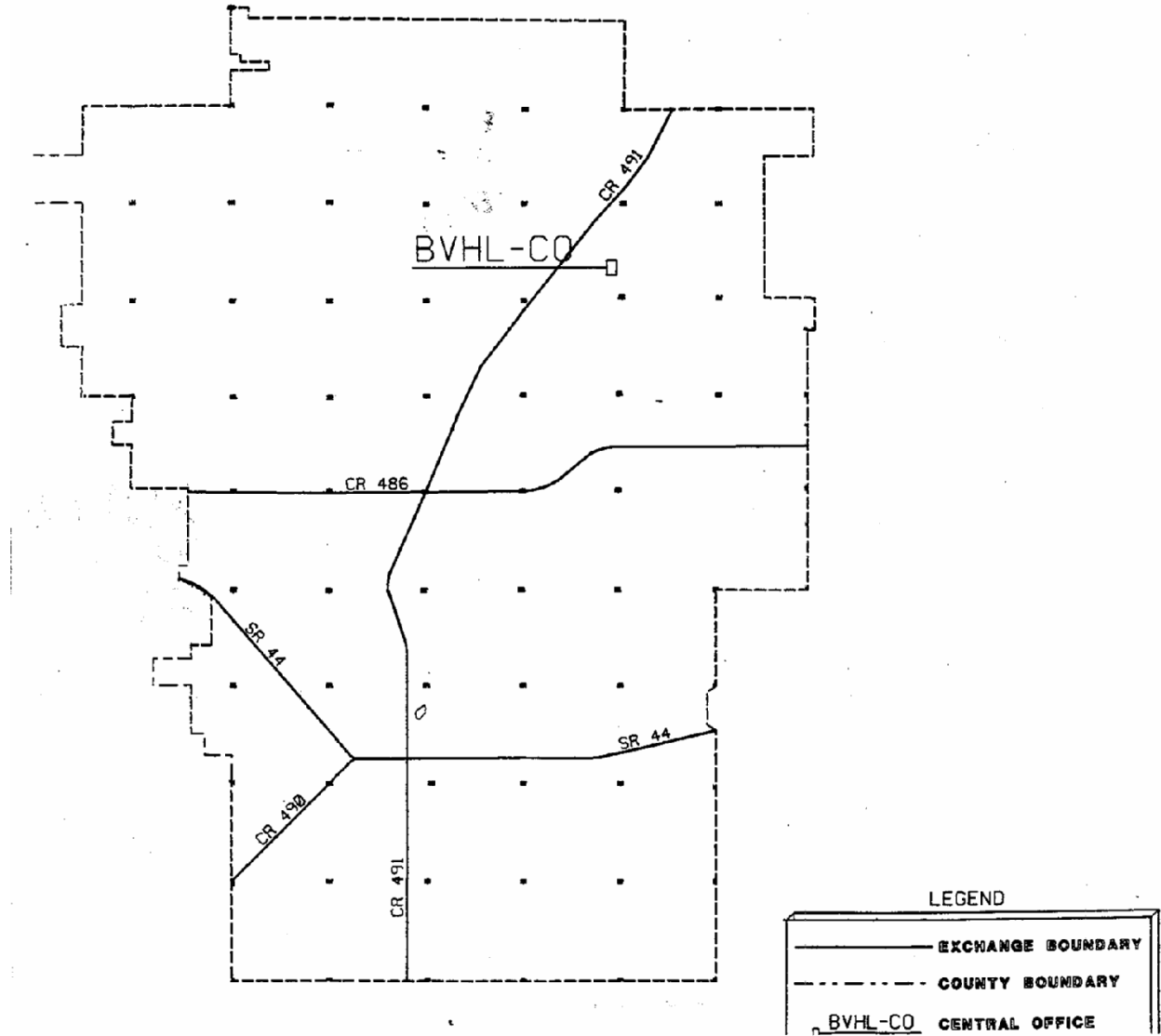

GENERAL EXCHANGE TARIFF

Embarq Florida, Inc.

By: F. B. Poag  
Director

Supplement Section 3  
First Revised Sheet 9  
Cancelling Original Sheet 9  
Effective: January 1, 1997

BOCA GRANDE EXCHANGE

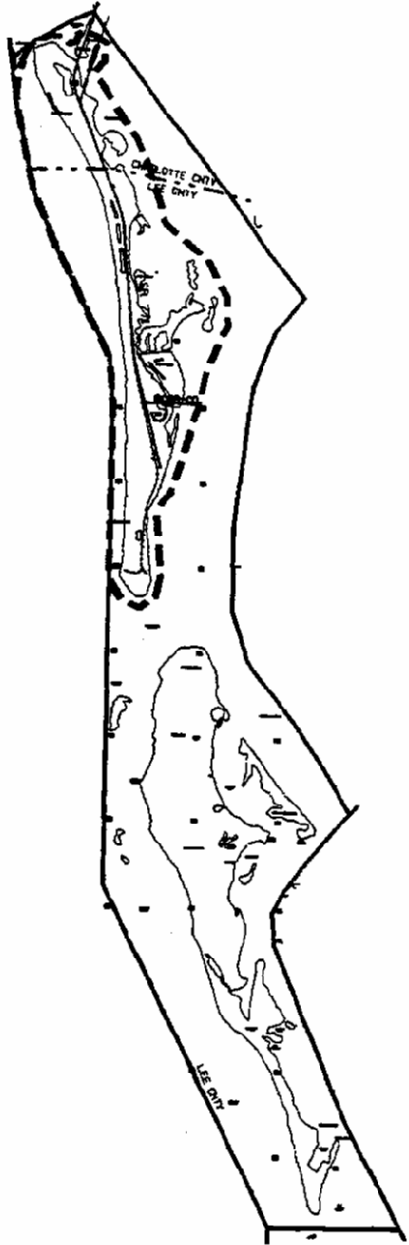

LEGEND

—————	EXCHANGE BOUNDARY
- - - - -	COUNTY BOUNDARY
- · - · -	BASE RATE BOUNDARY
□	LSBG-CO CENTRAL OFFICE LOCATION

GENERAL EXCHANGE TARIFF

Embarq Florida, Inc.

By: F. B. Poag  
Director

Supplement Section 3  
First Revised Sheet 10  
Cancelling Original Sheet 10  
Effective: January 1, 1997

BONIFAY EXCHANGE

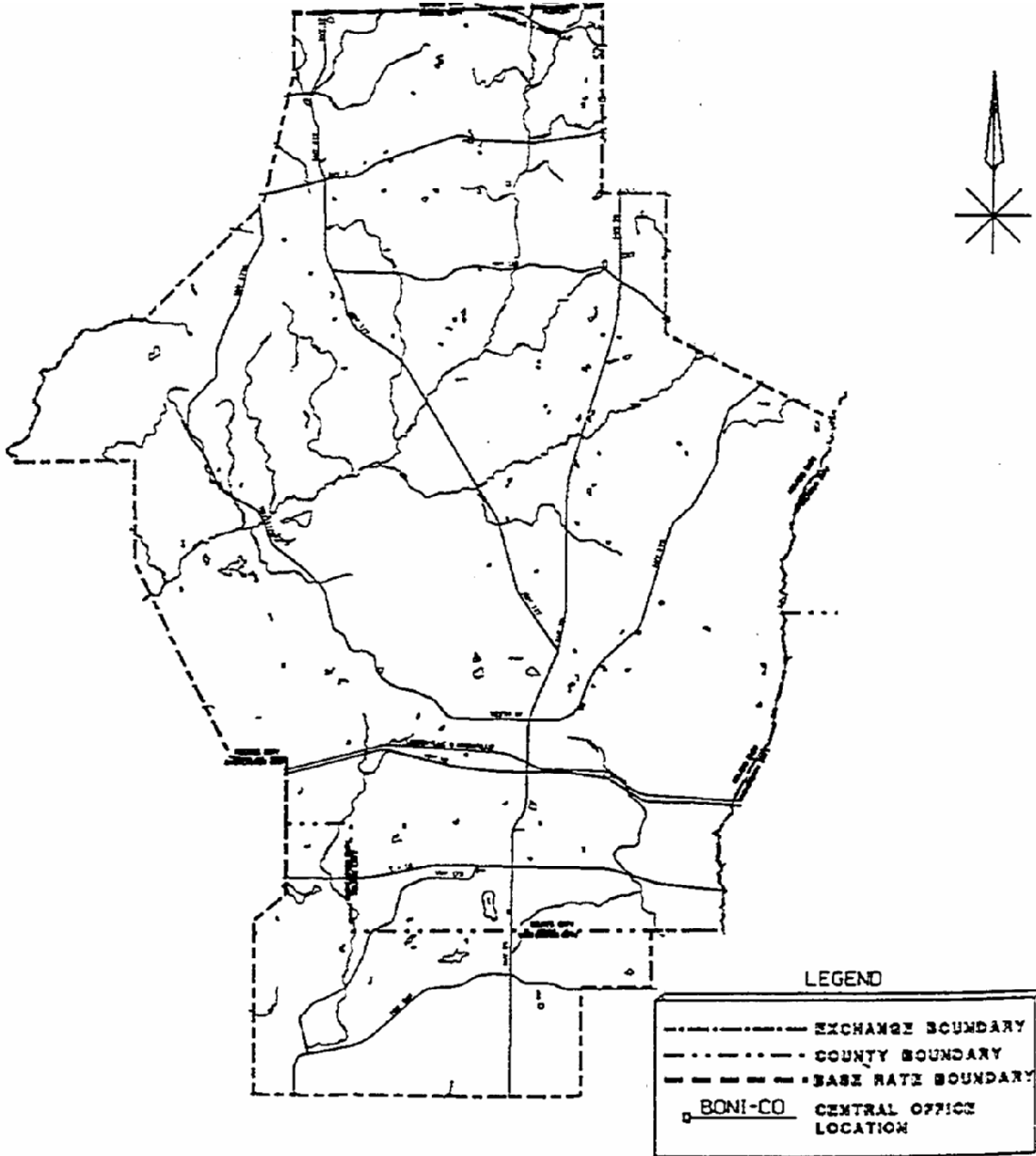

GENERAL EXCHANGE TARIFF

Embarq Florida, Inc.

SUPPLEMENT SECTION A3  
Sixth Revised Sheet 11  
Cancelling Fifth Sheet 11

By: F. B. Poag  
Director

Effective :March 22, 2005

EXCHANGE SERVICE AREA MAP

BONITA SPRINGS

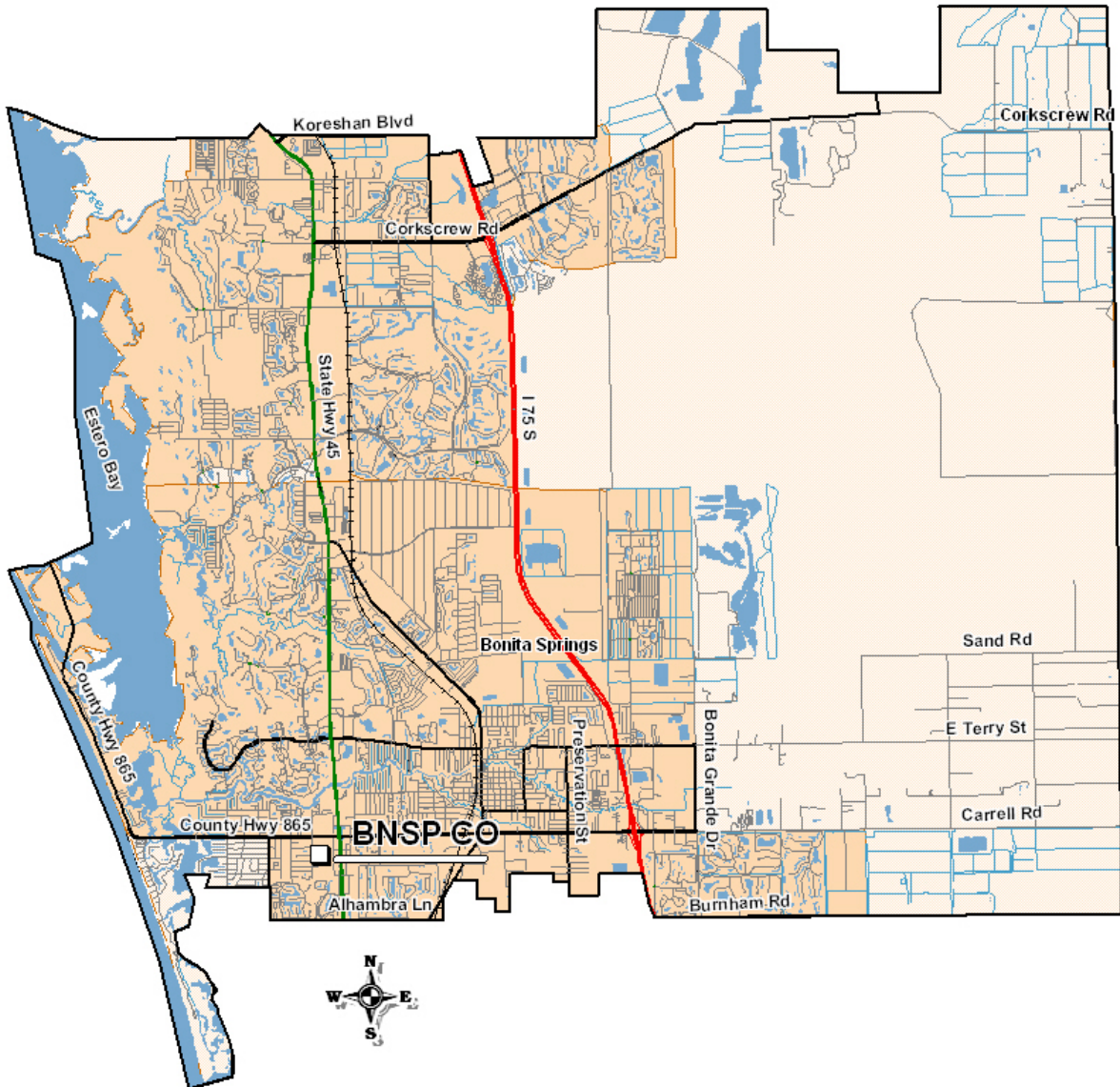

GENERAL EXCHANGE TARIFF

Embarq Florida, Inc.

By: F. B. Poag  
Director

Supplement Section 3  
First Revised Sheet 12  
Cancelling Original Sheet 12  
Effective: January 1, 1997

BOWLING GREEN EXCHANGE

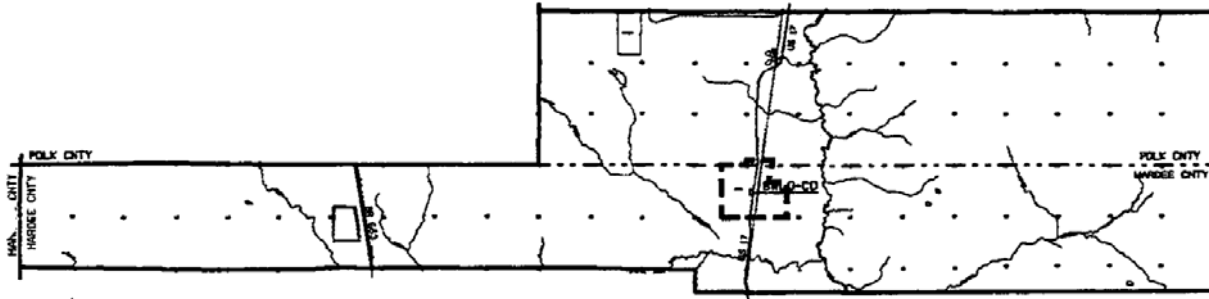

LEGEND

—————	EXCHANGE BOUNDARY
- - - - -	COUNTY BOUNDARY
- · - · -	BASE RATE BOUNDARY
□	LSBG-CO
	CENTRAL OFFICE LOCATION



GENERAL EXCHANGE TARIFF

Embarq Florida, Inc.

By: F. B. Poag  
Director

Supplement Section 3  
First Revised Sheet 13  
Cancelling Original Sheet 13  
Effective: January 1, 1997

BUSHNELL EXCHANGE

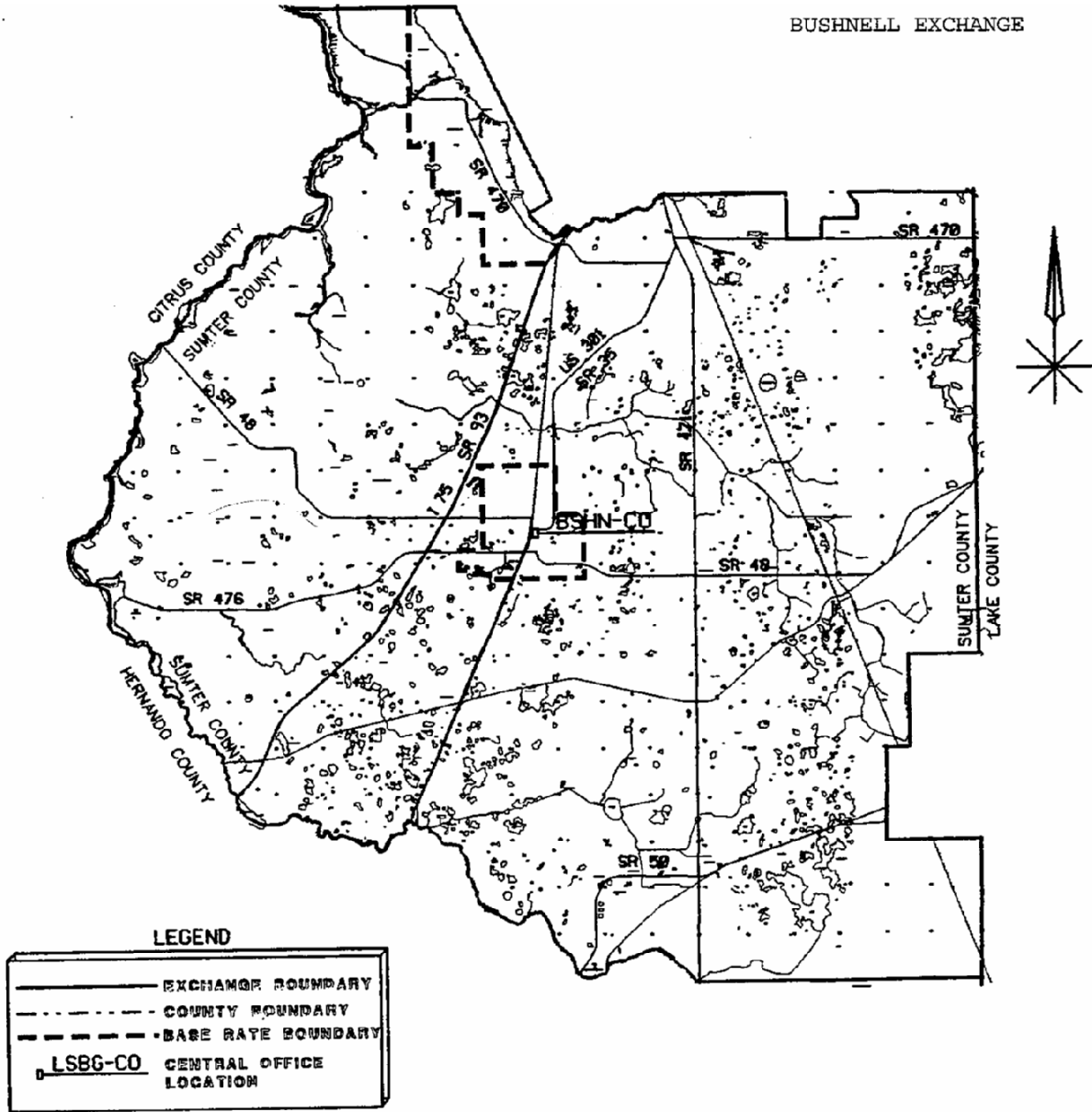

GENERAL EXCHANGE TARIFF

Embarq Florida, Inc.

By: F. B. Poag  
Director

Supplement Section 3  
First Revised Sheet 14  
Cancelling Original Sheet 14  
Effective: January 1, 1997

CAPE CORAL EXCHANGE

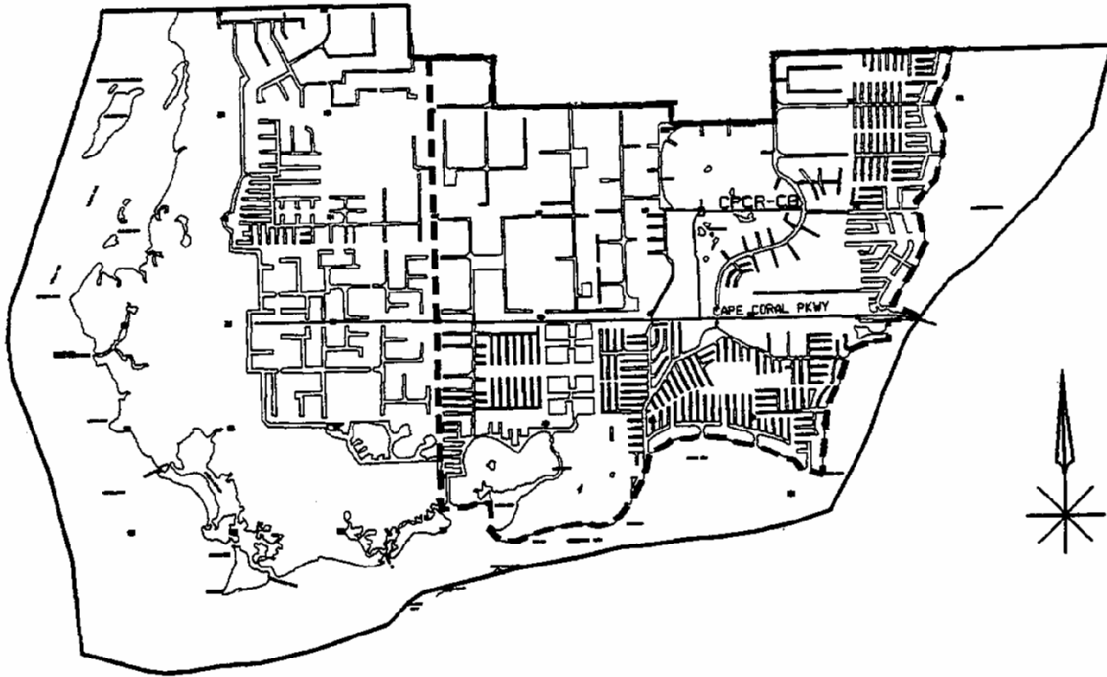

LEGEND

	EXCHANGE BOUNDARY
	COUNTY BOUNDARY
	BASE RATE BOUNDARY
	CENTRAL OFFICE LOCATION

GENERAL EXCHANGE TARIFF

Embarq Florida, Inc.

By: F. B. Poag  
Director

Supplement Section 3  
First Revised Sheet 15  
Cancelling Original Sheet 15  
Effective: January 1, 1997

CAPE HAZE EXCHANGE

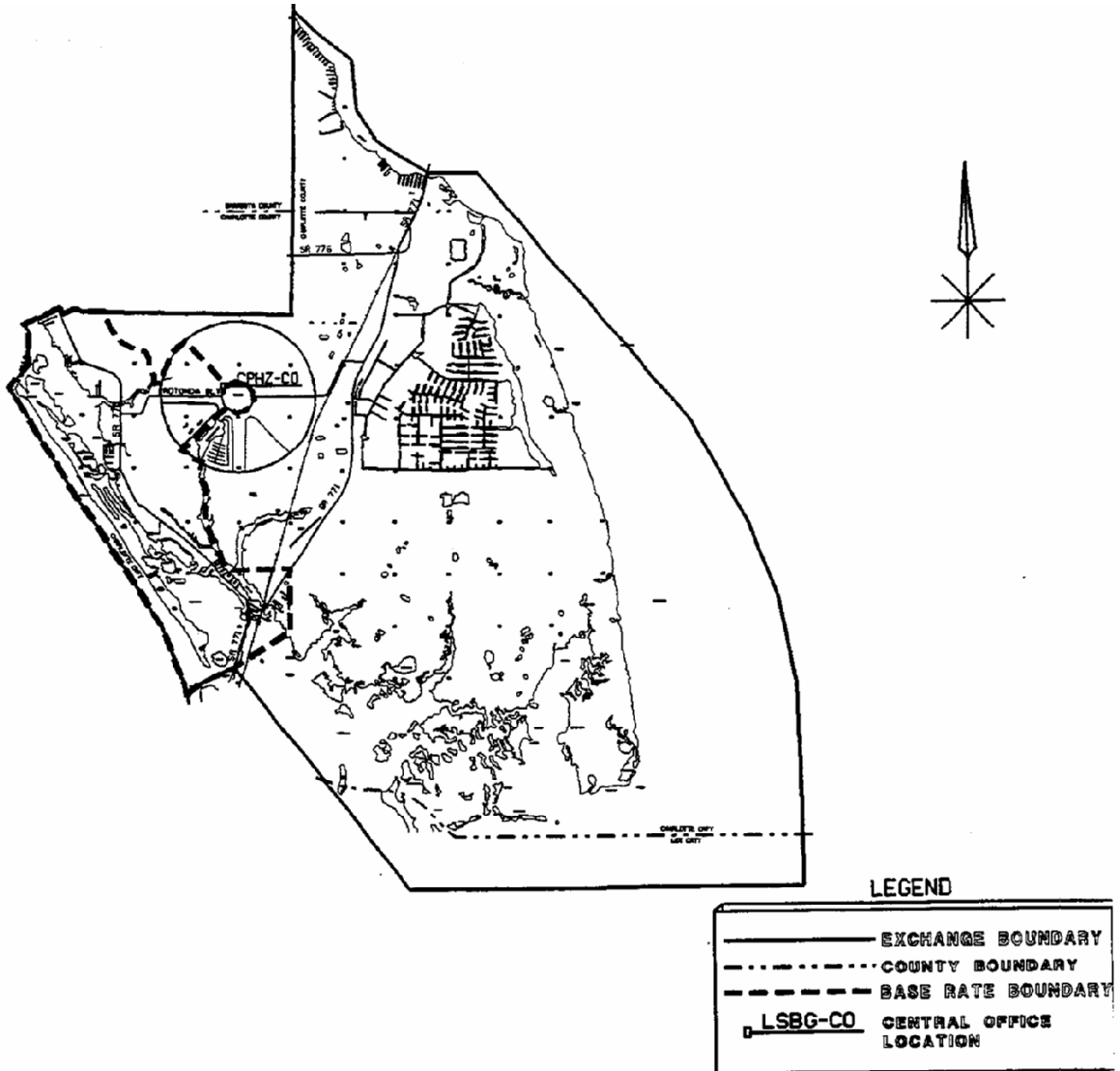

GENERAL EXCHANGE TARIFF

Embarq Florida, Inc.

By: F. B. Poag  
Director

Supplement Section 3  
First Revised Sheet 16  
Cancelling Original Sheet 16  
Effective: January 1, 1997

CHERRY LAKE EXCHANGE

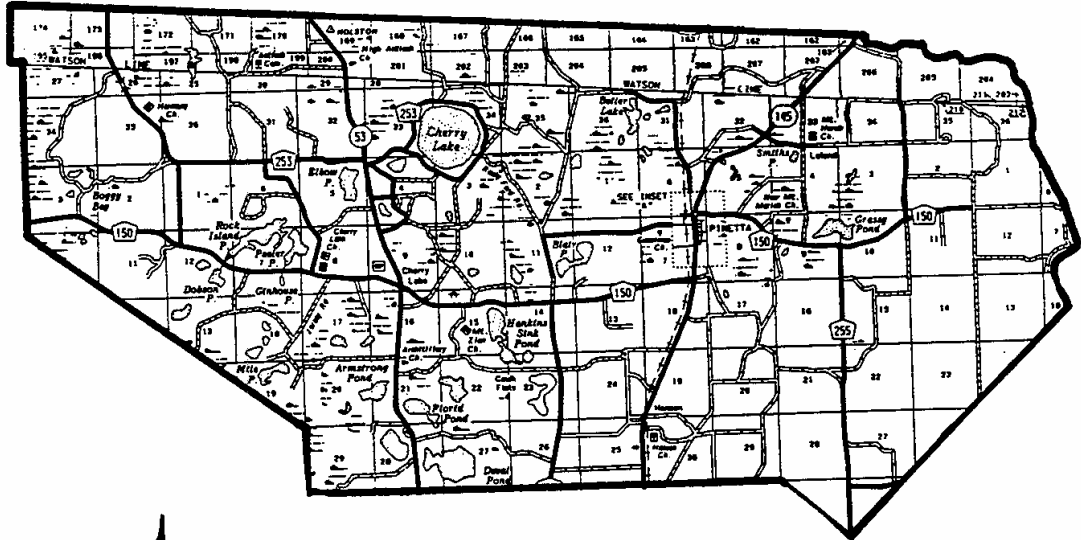

GENERAL EXCHANGE TARIFF

Embarq Florida, Inc.

SUPPLEMENT SECTION A3  
Fourth Revised Sheet 17  
Cancelling Third Revised Sheet 17  
Effective: June 1, 2005

By: F. B. Poag  
Director

EXCHANGE SERVICE AREA MAP

CLERMONT EXCHANGE

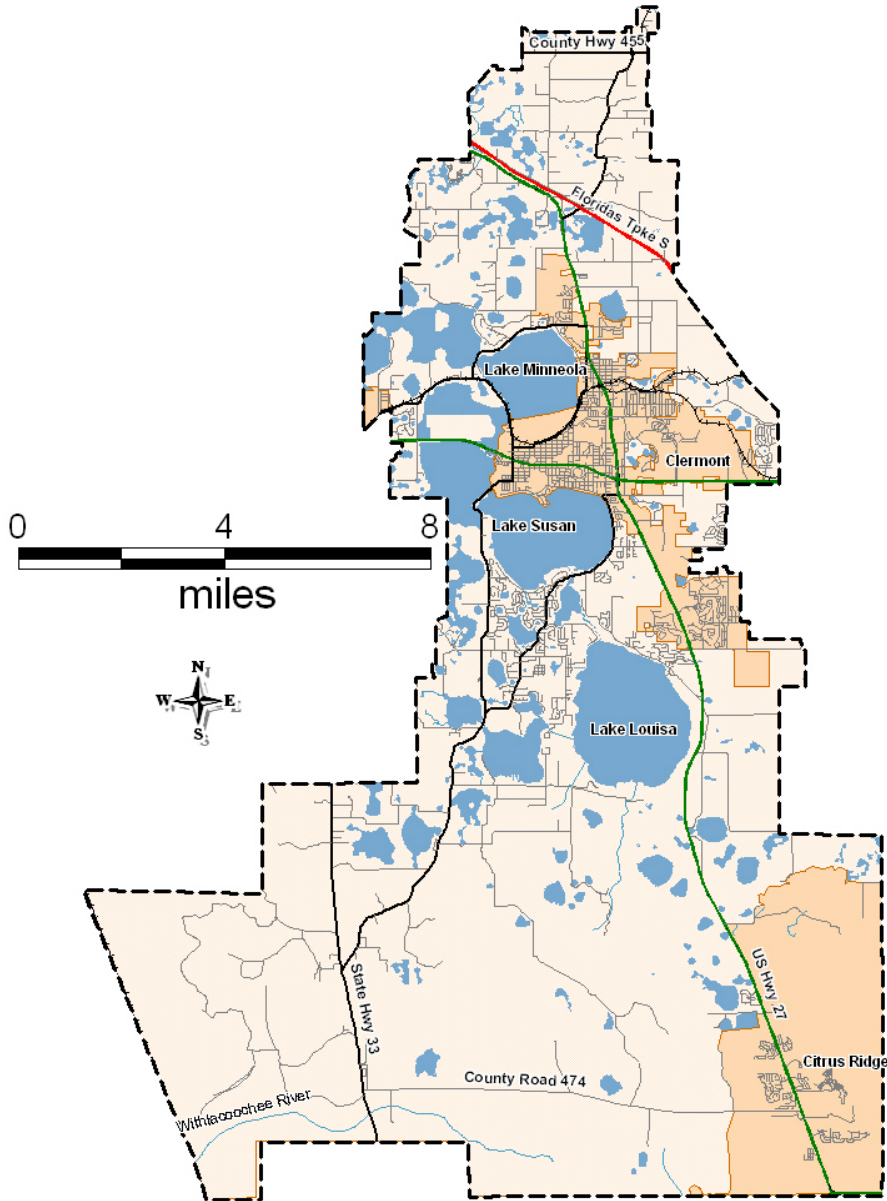

# GENERAL EXCHANGE TARIFF

Embarq Florida, Inc.

By: F. B. Poag  
Director

Supplement Section 3  
First Revised Sheet 18  
Cancelling Original Sheet 18  
Effective: January 1, 1997

## CLEWISTON EXCHANGE

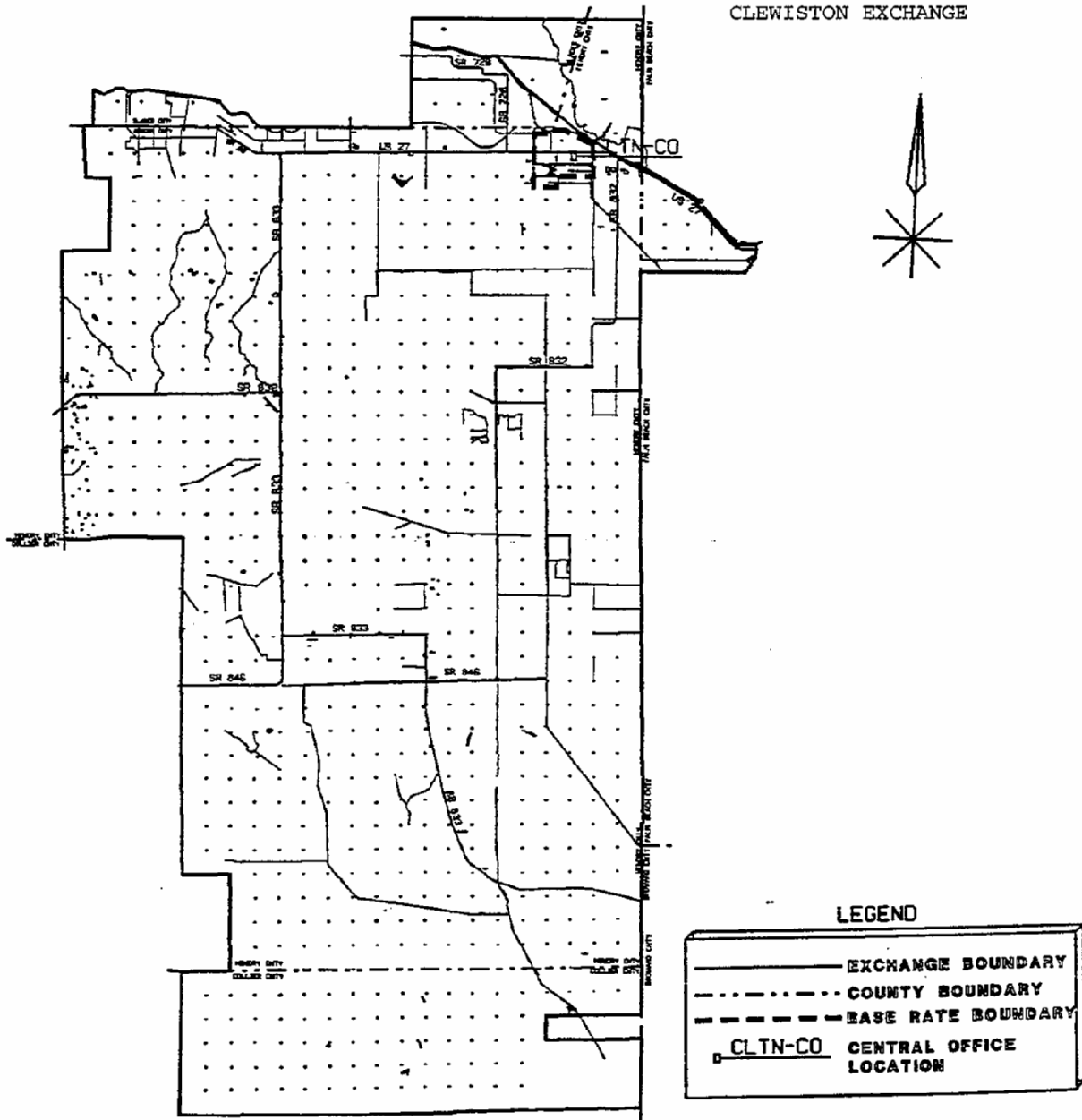

GENERAL EXCHANGE TARIFF

Embarq Florida, Inc.

By: F. B. Poag  
Director

Supplement Section 3  
First Revised Sheet 19  
Cancelling Original Sheet 19  
Effective: January 1, 1997

COTTONDALE EXCHANGE

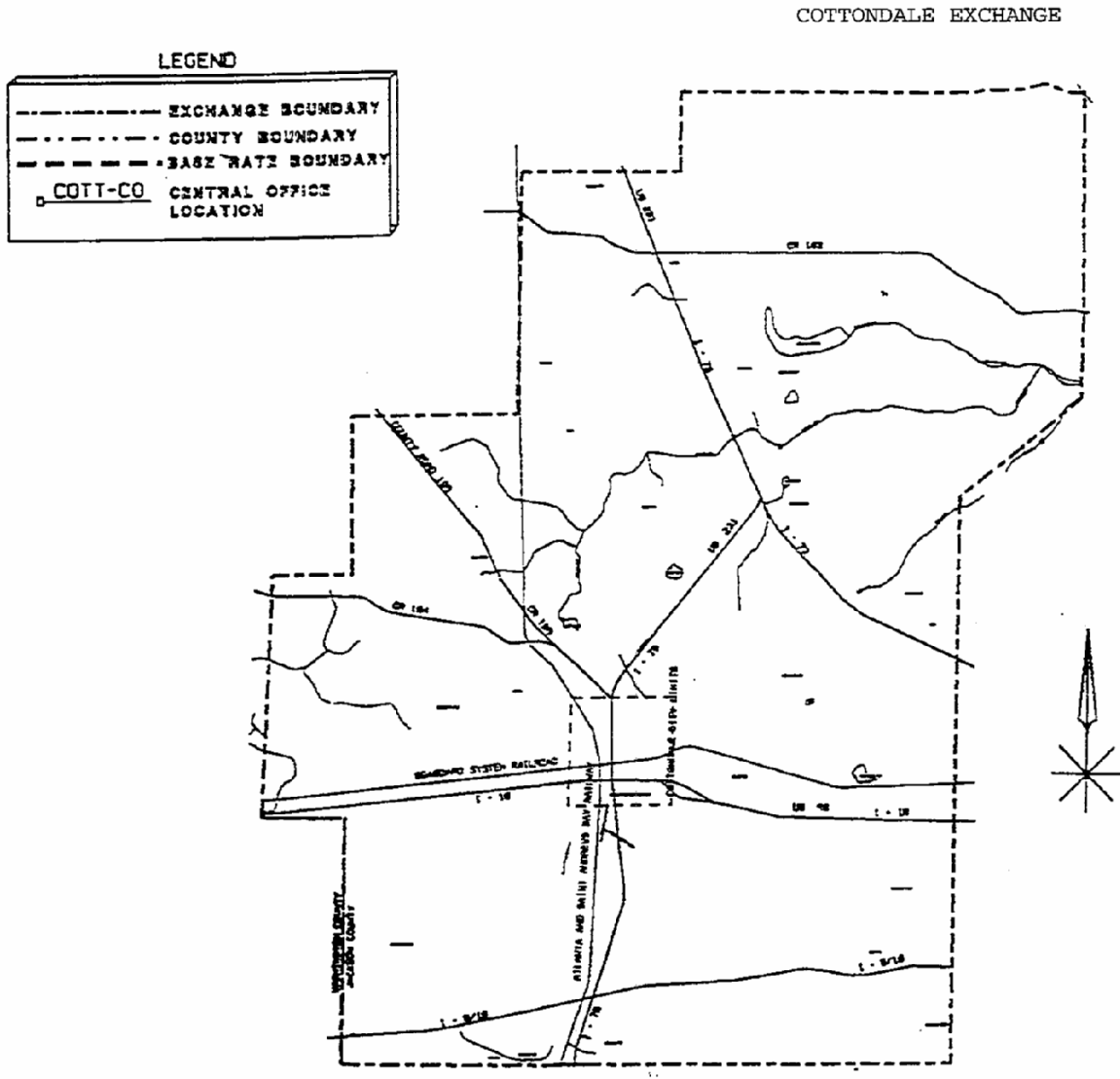

GENERAL EXCHANGE TARIFF

Embarq Florida, Inc.

By: F. B. Poag  
Director

Supplement Section 3  
First Revised Sheet 20  
Cancelling Original Sheet 20  
Effective: January 1, 1997

CRAWFORDVILLE EXCHANGE

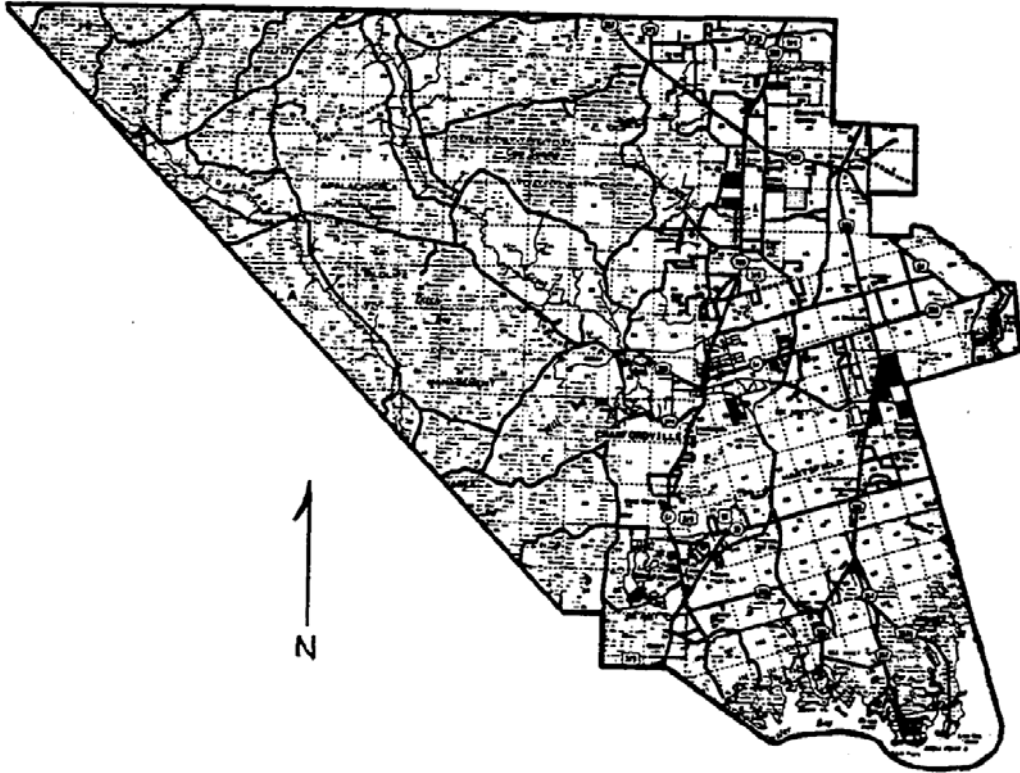



GENERAL EXCHANGE TARIFF

Embarq Florida, Inc.

By: F. B. Poag  
Director

Supplement Section 3  
First Revised Sheet 21  
Cancelling Original Sheet 21  
Effective: January 1, 1997

CRESTVIEW EXCHANGE

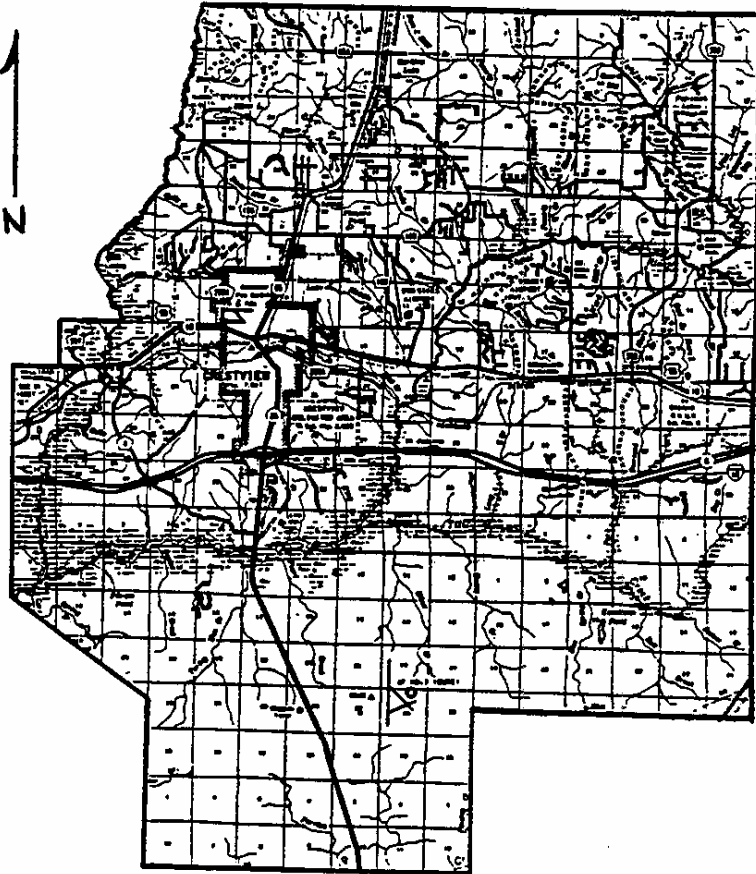

GENERAL EXCHANGE TARIFF

Embarq Florida, Inc.

By: F. B. Poag  
Director

Supplement Section 3  
Second Revised Sheet 22  
Cancelling First Revised Sheet 22 & 22.1  
Effective: September 22, 1998

CRYSTAL RIVER EXCHANGE

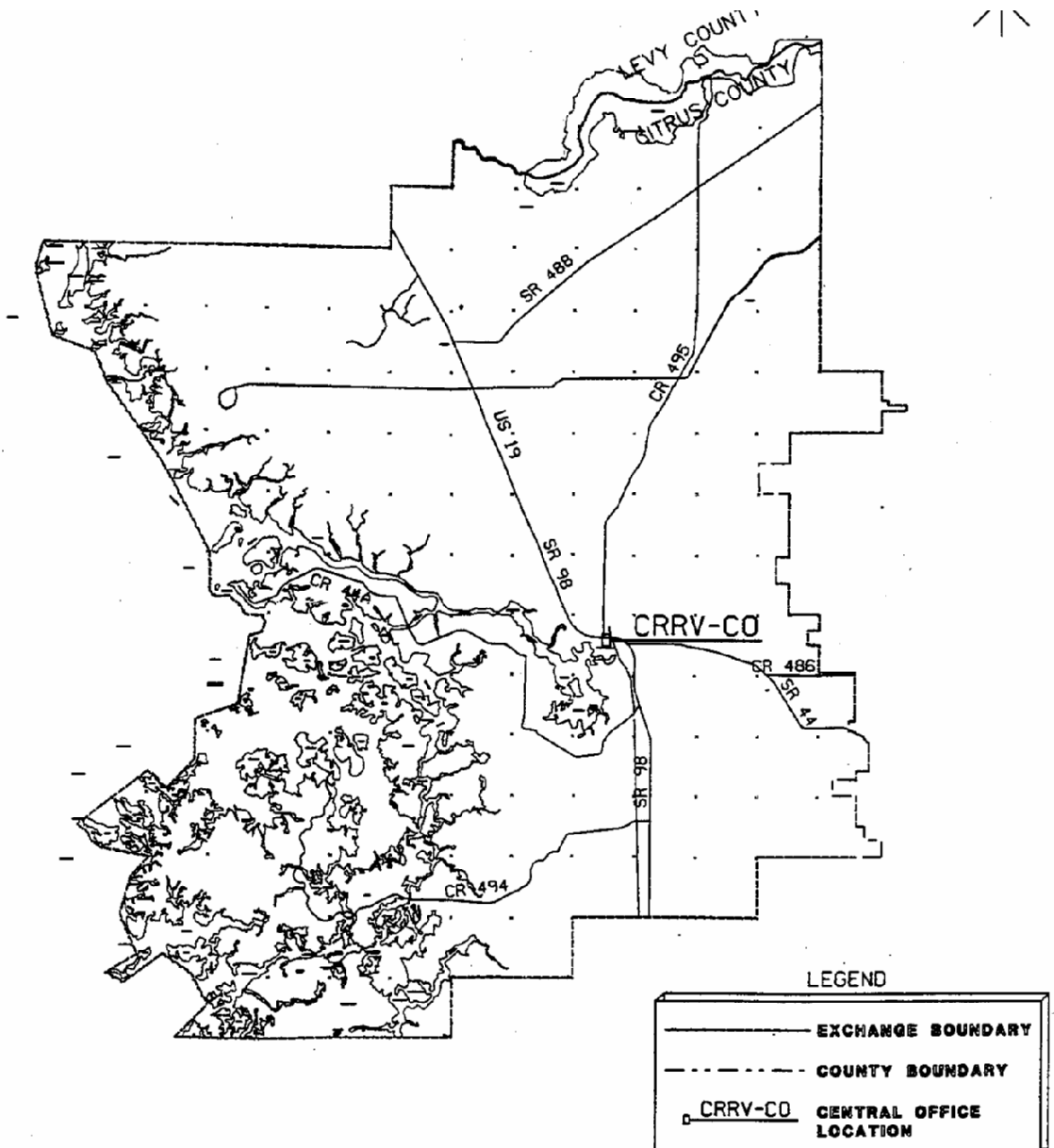

GENERAL EXCHANGE TARIFF

Embarq Florida, Inc.

By: F. B. Poag  
Director

Supplement Section 3  
Second Revised Sheet 23  
Cancelling First Revised Sheet 23  
Effective: January 22, 2000

DADE CITY EXCHANGE

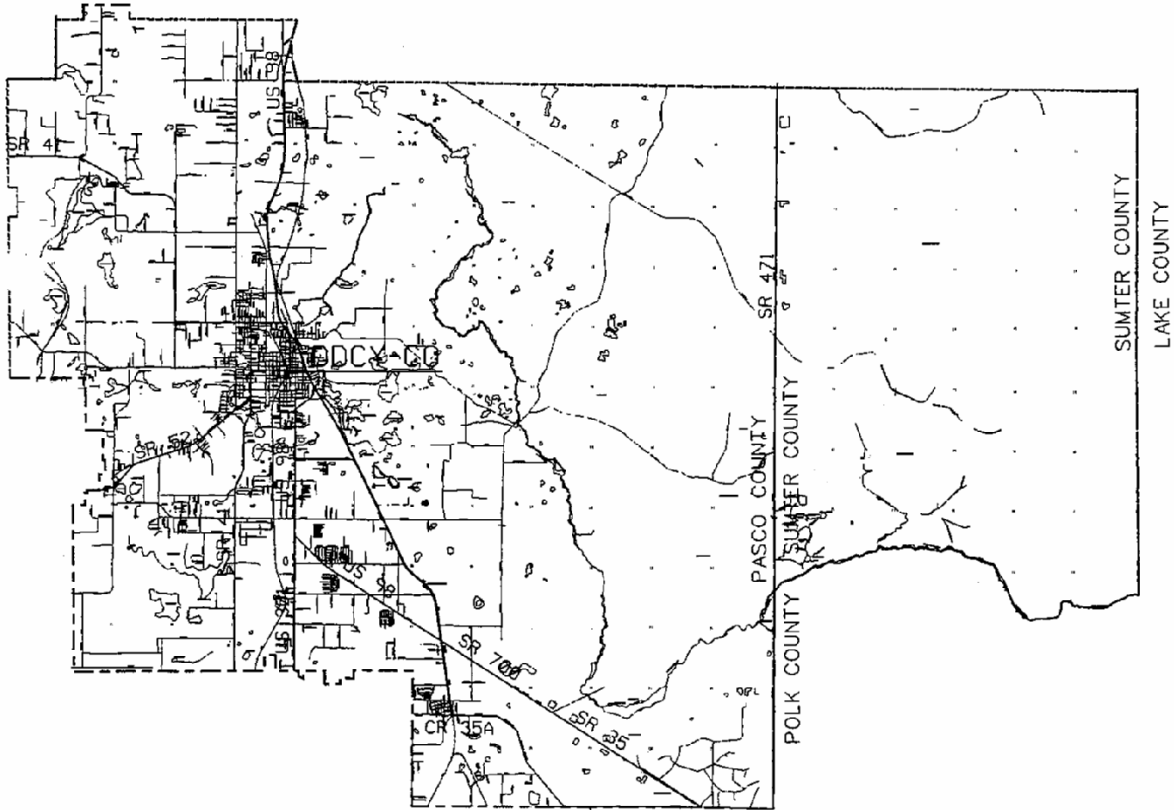

LEGEND

	EXCHANGE BOUNDARY
	COUNTY BOUNDARY
	CENTRAL OFFICE LOCATION

GENERAL EXCHANGE TARIFF

Embarq Florida, Inc.

By: F. B. Poag  
Director

Supplement Section 3  
First Revised Sheet 24  
Cancelling Original Sheet 24  
Effective: January 1, 1997

DEFUNIAK SPRINGS EXCHANGE

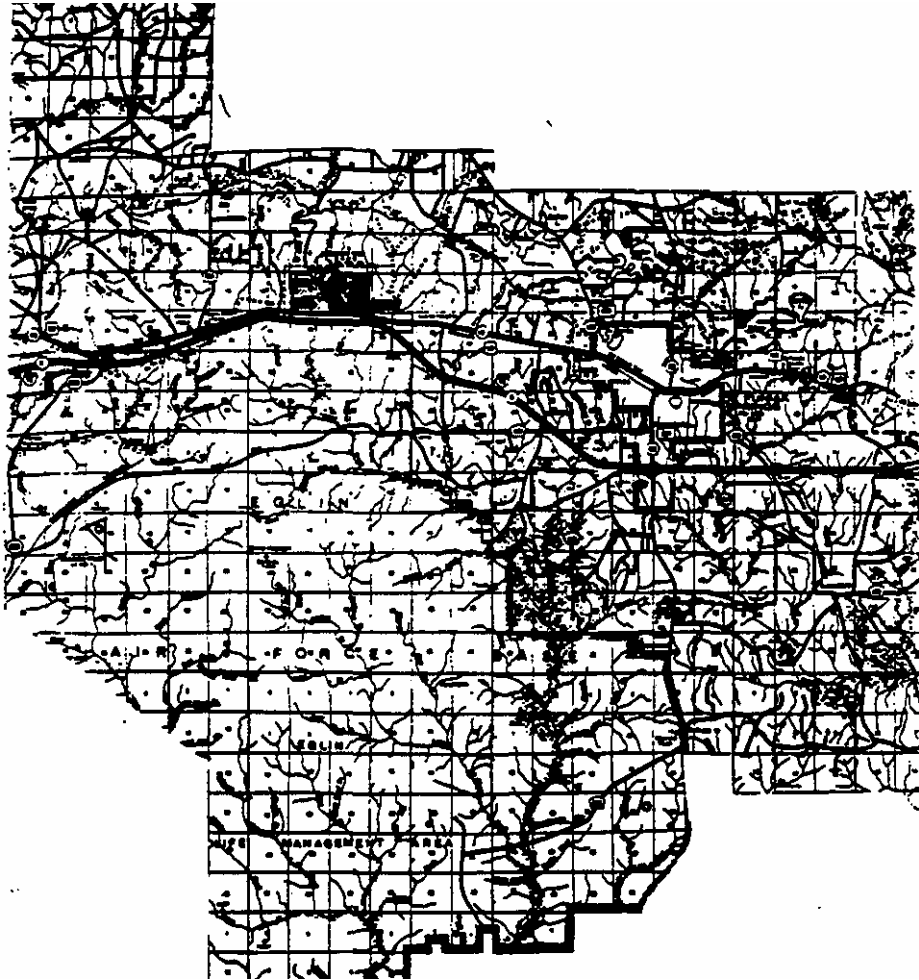

GENERAL EXCHANGE TARIFF





Embarq Florida, Inc.

BY: F. B. Poag  
Director

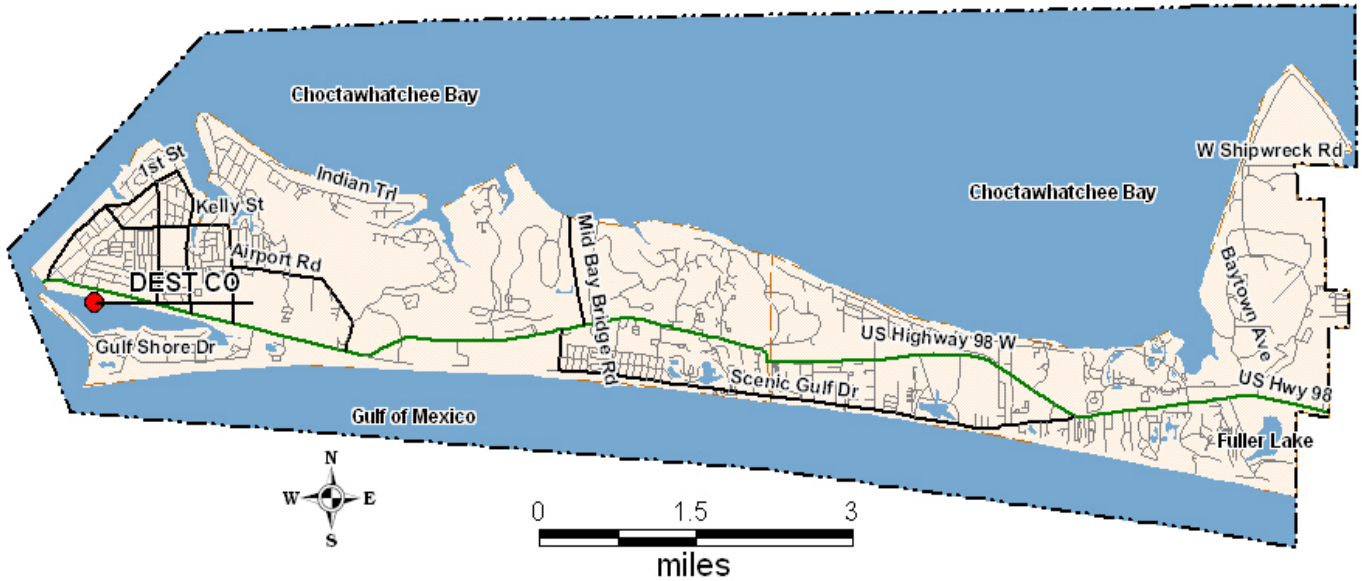
SUPPLEMENT SECTION A3  
Second Revised Sheet 25  
Cancelling First Revised sheet 25  
EFFECTIVE: September 15, 2004

EXCHANGE SERVICE AREA MAP  
DESTIN EXCHANGE



-  EXCHANGE BOUNDARY
-  COUNTY BOUNDARY
-  WATER BODIES
-  CENTRAL OFFICE LOCATION

GENERAL EXCHANGE TARIFF

Embarq Florida, Inc.

SUPPLEMENT SECTION A3  
Third Revised Sheet 26  
Cancelling Second Revised Sheet 26

By: F. B. Poag  
Director

Effective: June 10, 2005

EXCHANGE SERVICE AREA MAP

EUSTIS EXCHANGE

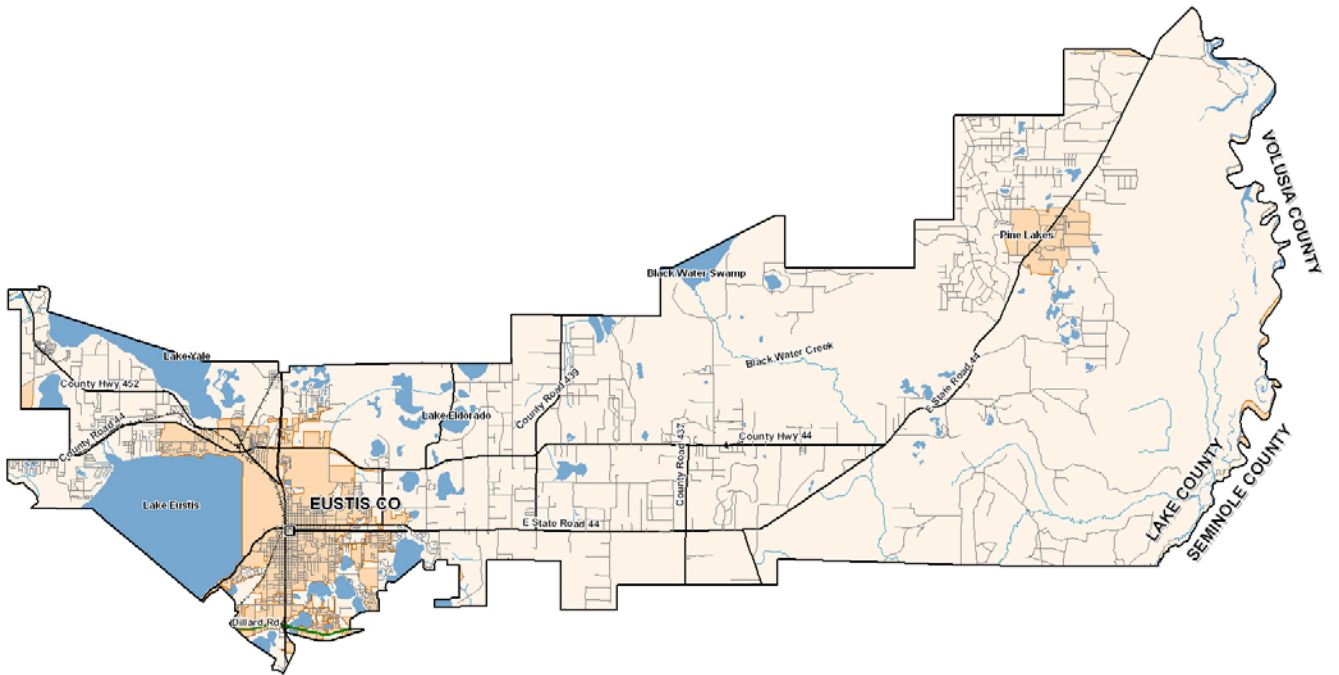

GENERAL EXCHANGE TARIFF

Embarq Florida, Inc.

By: F. B. Poag  
Director

Supplement Section 3  
First Revised Sheet 27  
Cancelling Original Sheet 27  
Effective: January 1, 1997

EVERGLADES EXCHANGE

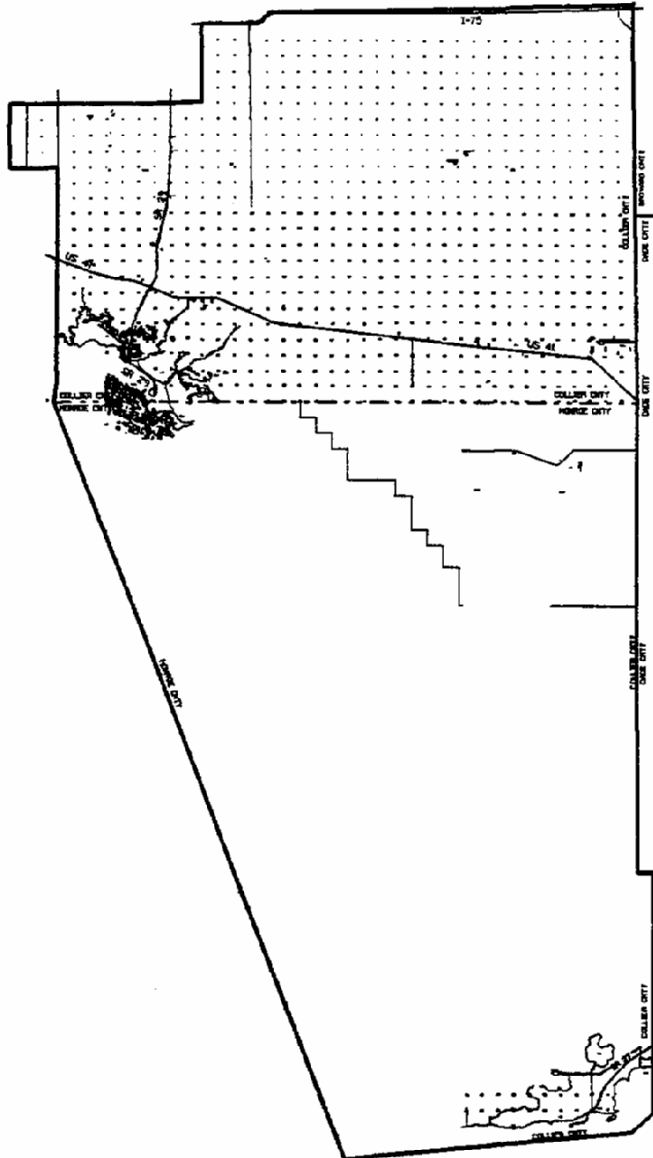

LEGEND

—	EXCHANGE BOUNDARY
- - -	COUNTY BOUNDARY
· · ·	BASE RATE BOUNDARY
■	LSBG-CD CENTRAL OFFICE LOCATION

GENERAL EXCHANGE TARIFF

Embarq Florida, Inc.

By: F. B. Poag  
Director

Supplement Section 3  
First Revised Sheet 28  
Cancelling Original Sheet 28  
Effective: January 1, 1997

FOREST EXCHANGE

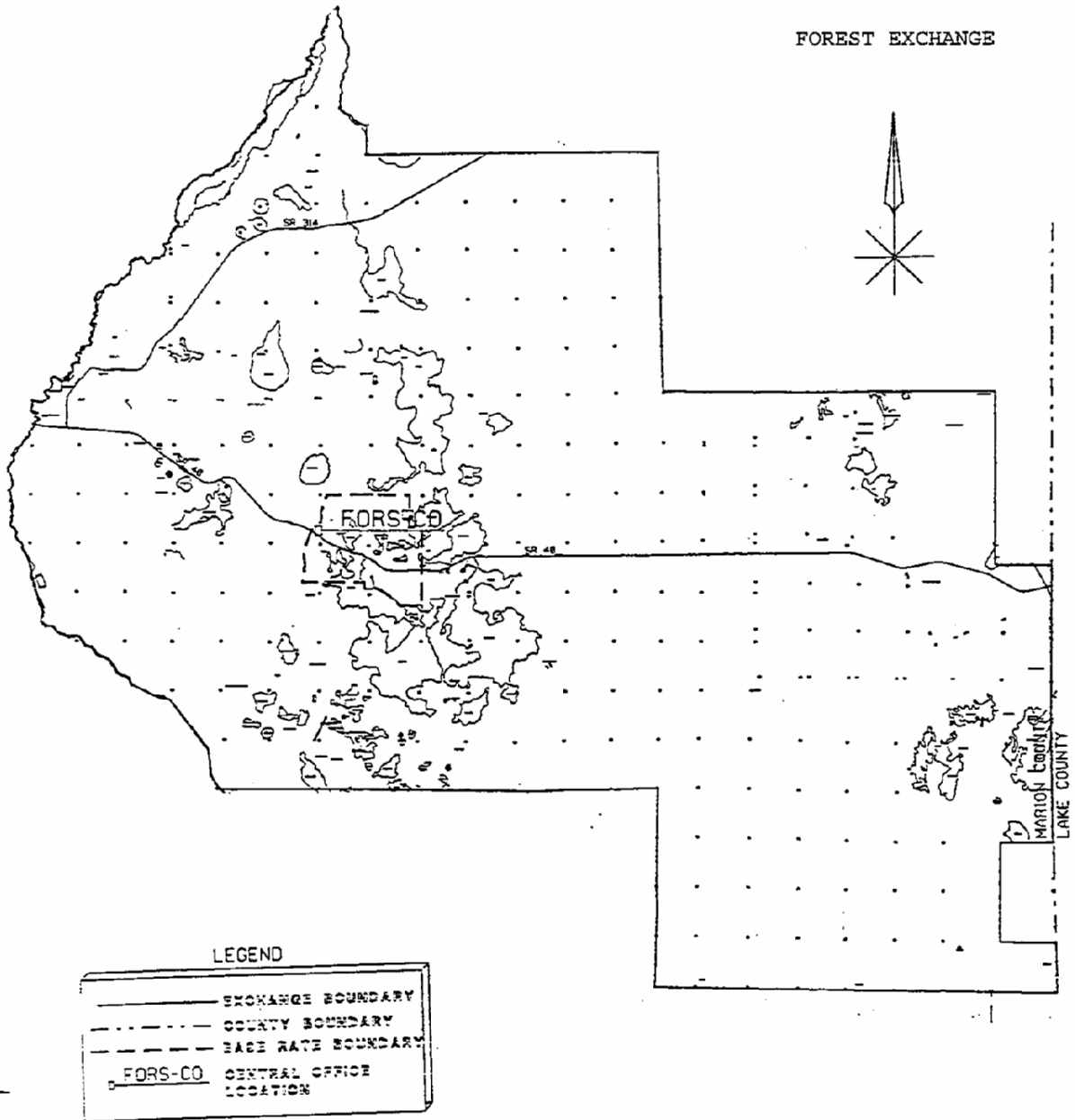



GENERAL EXCHANGE TARIFF

Embarq Florida, Inc.

By: F. B. Poag  
Director

Supplement Section 3  
First Revised Sheet 29  
Cancelling Original Sheet 29  
Effective: January 1, 1997

FORT MEADE EXCHANGE

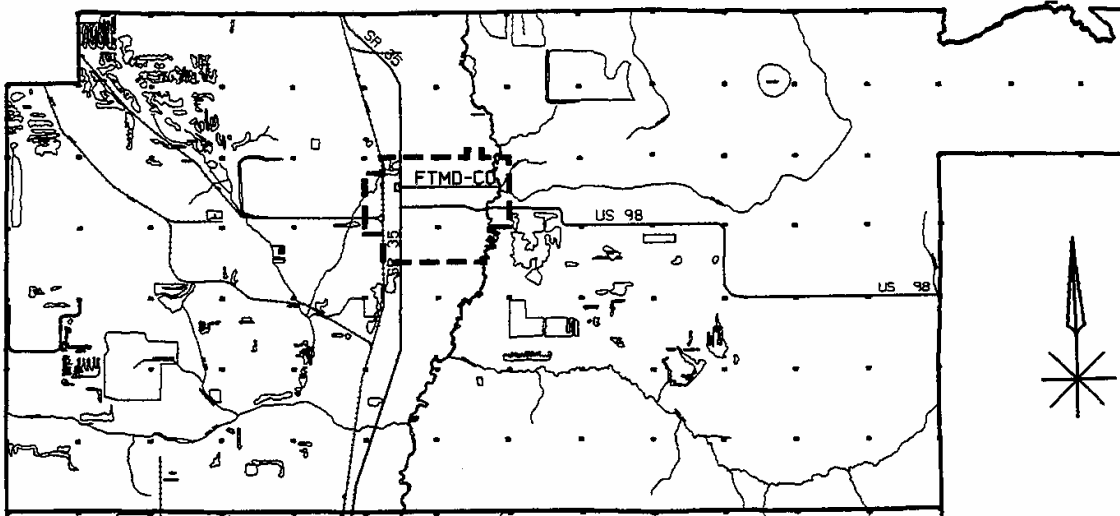

GENERAL EXCHANGE TARIFF

Embarq Florida, Inc.

By: F. B. Poag  
Director

Supplement Section 3  
Fourth Revised Sheet 30  
Cancelling Third Revised Sheet 30  
Effective: August 9, 2003

FORT MYERS EXCHANGE

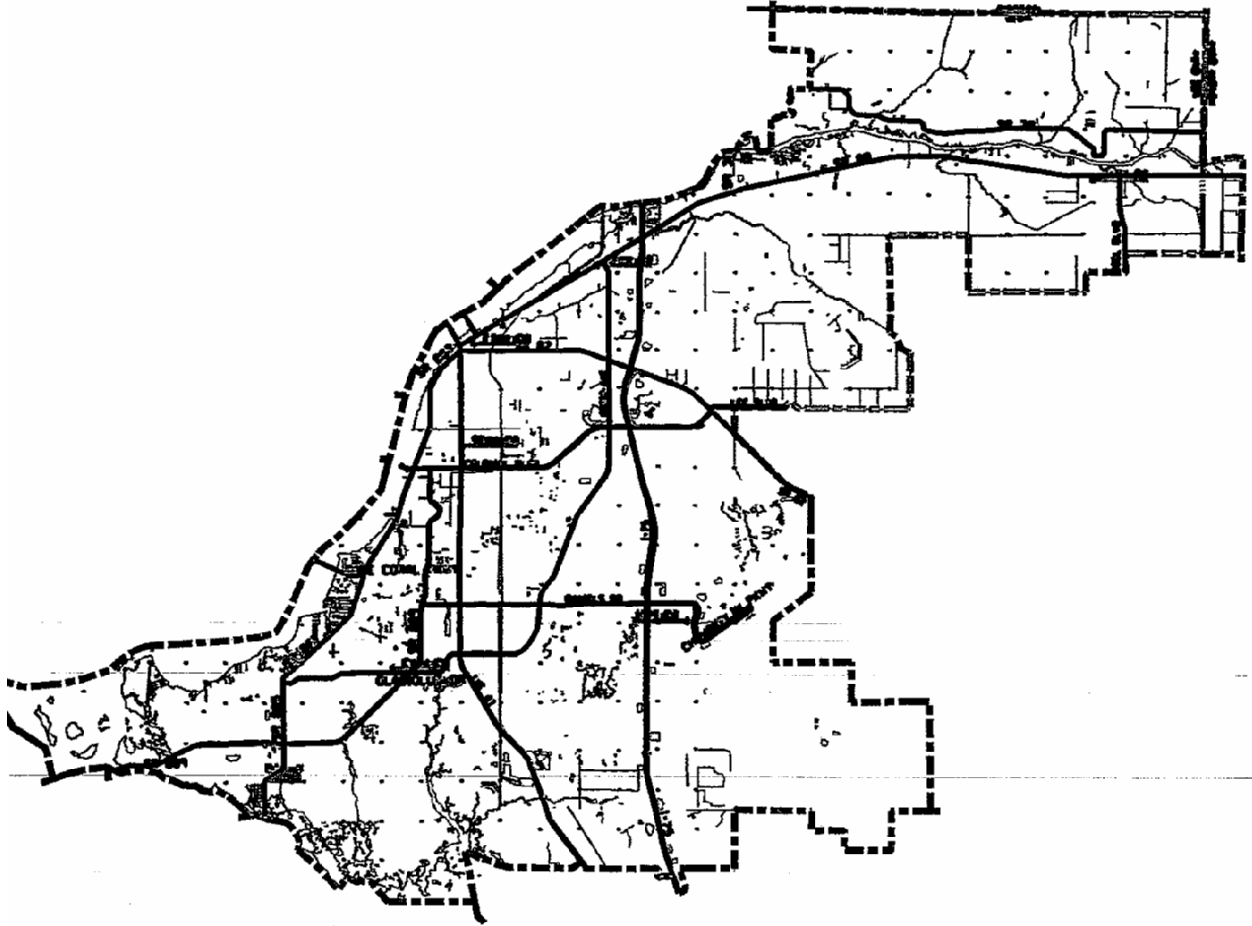

**LEGEND**

-----	EXCHANGE BOUNDARY
.....	COUNTY BOUNDARY
★	CENTRAL OFFICE LOCATION

GENERAL EXCHANGE TARIFF

Embarq Florida, Inc.

By: F. B. Poag  
Director

Supplement Section 3  
First Revised Sheet 31  
Cancelling Original Sheet 31  
Effective: January 1, 1997

FORT MYERS BEACH EXCHANGE

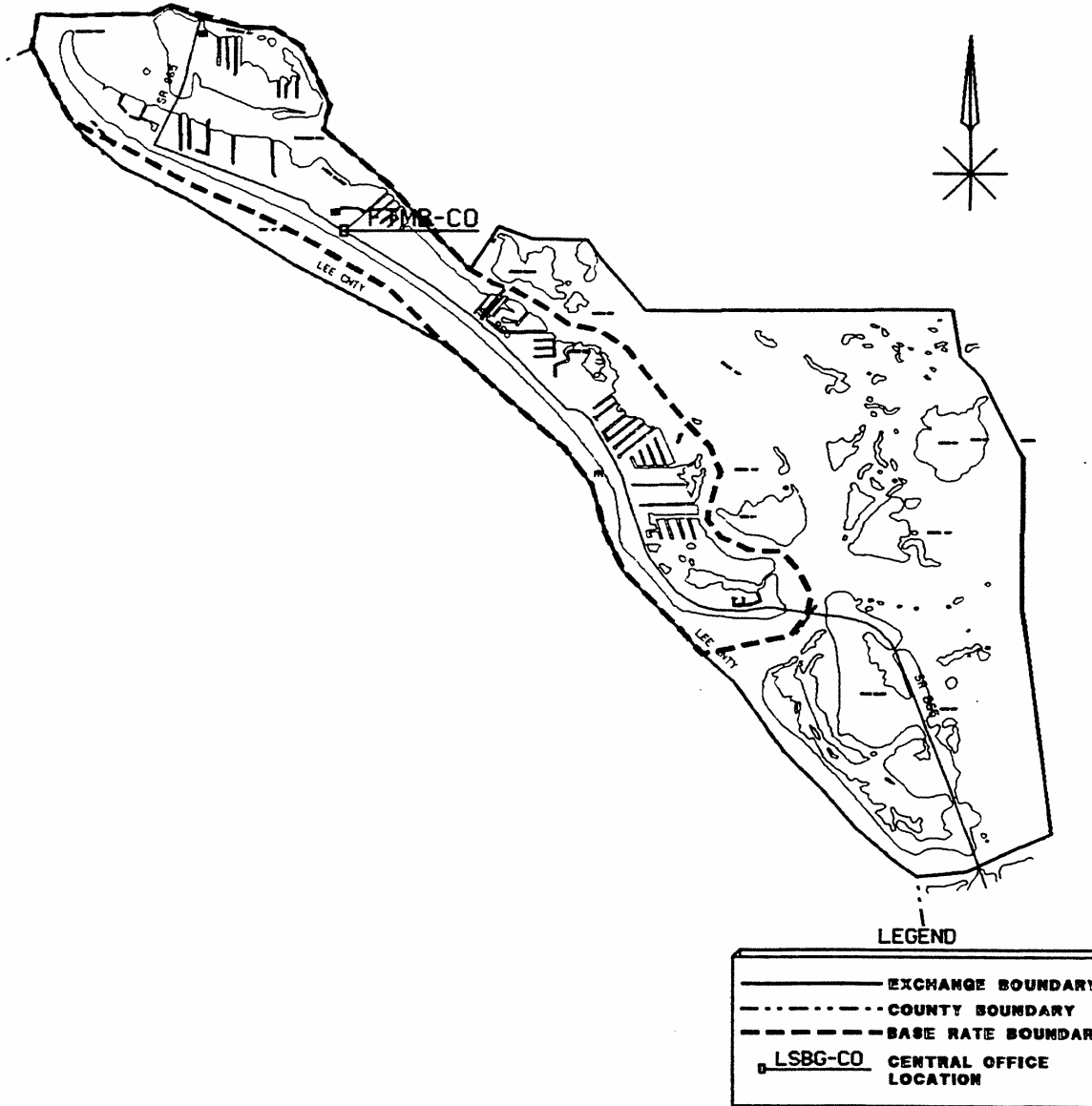

GENERAL EXCHANGE TARIFF

Embarq Florida, Inc.

By: F. B. Poag  
Director

Supplement Section 3  
First Revised Sheet 32  
Cancelling Original Sheet 32  
Effective: January 1, 1997

FORT WALTON BEACH EXCHANGE

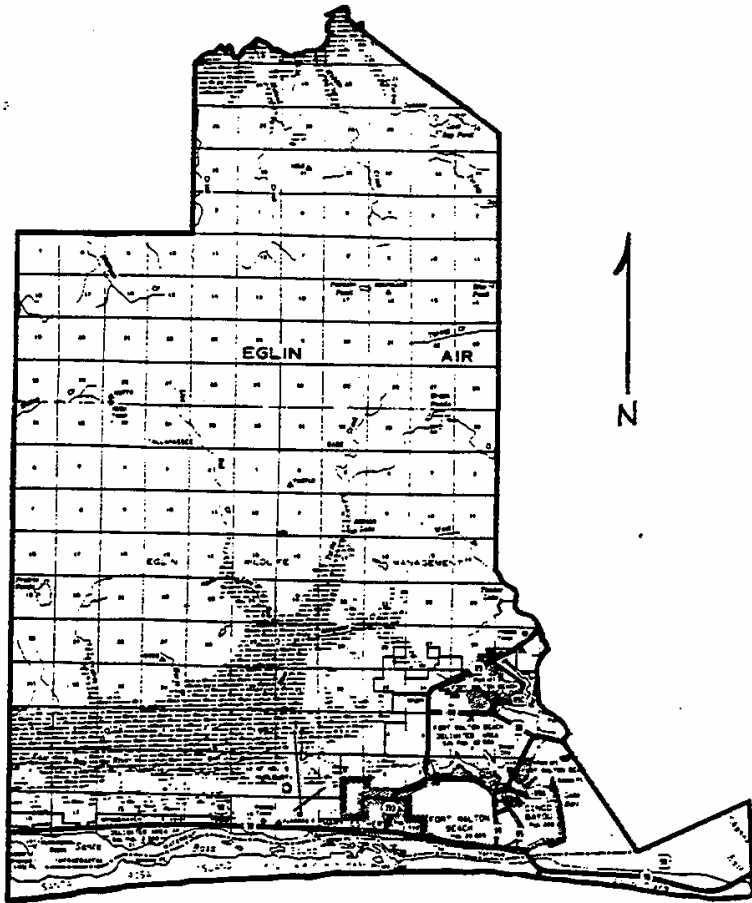

GENERAL EXCHANGE TARIFF

Embarq Florida, Inc.

By: F. B. Poag  
Director

Supplement Section 3  
First Revised Sheet 33  
Cancelling Original Sheet 33  
Effective: January 1, 1997

FREEMPORT EXCHANGE

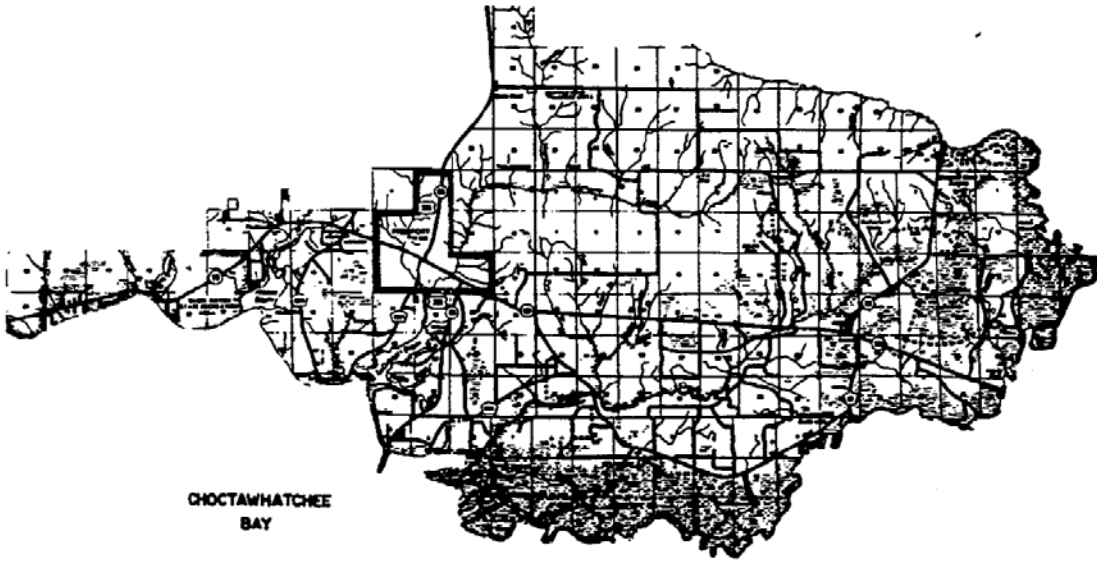

GENERAL EXCHANGE TARIFF

Embarq Florida, Inc.

By: F. B. Poag  
Director

Supplement Section 3  
First Revised Sheet 34  
Cancelling Original Sheet 34  
Effective: January 1, 1997

GLENDALE EXCHANGE

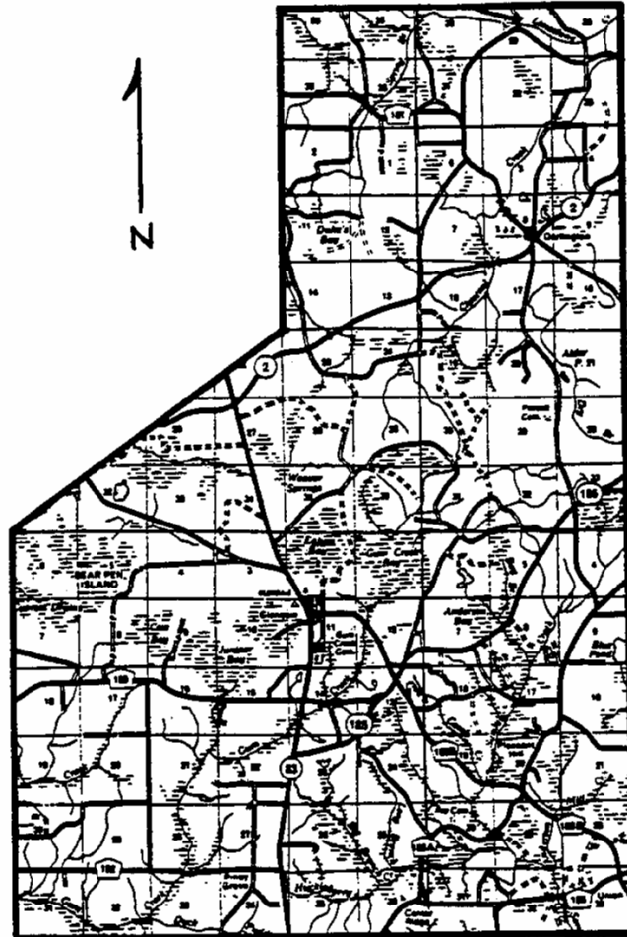

GENERAL EXCHANGE TARIFF

Embarq Florida, Inc.

By: F. B. Poag  
Director

Supplement Section 3  
First Revised Sheet 35  
Cancelling Original Sheet 35  
Effective: January 1, 1997

GRAND RIDGE EXCHANGE

GRAND RIDGE EXCHANGE

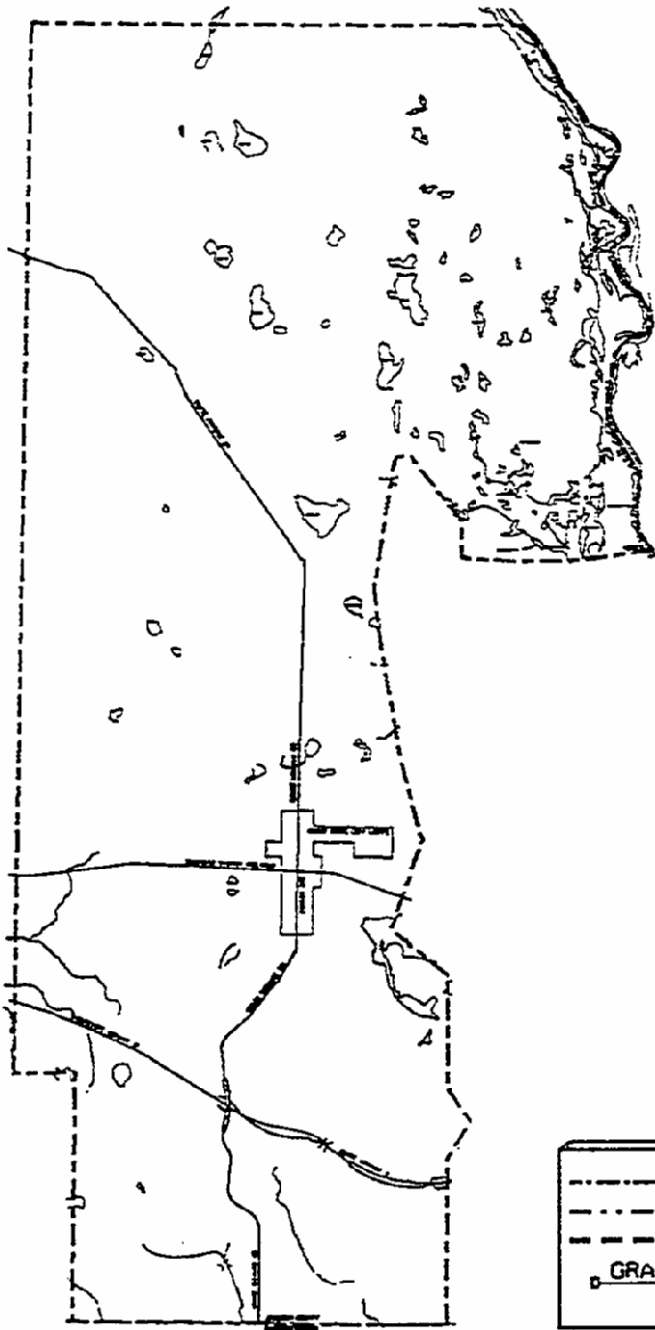

LEGEND

-----	EXCHANGE BOUNDARY
-----	COUNTY BOUNDARY
- · - · -	BASE RATE BOUNDARY
GRAN-CO	CENTRAL OFFICE LOCATION

GENERAL EXCHANGE TARIFF

Embarq Florida, Inc.

By: F. B. Poag  
Director

Supplement Section 3  
First Revised Sheet 36  
Cancelling Original Sheet 36  
Effective: January 1, 1997

GREENVILLE EXCHANGE

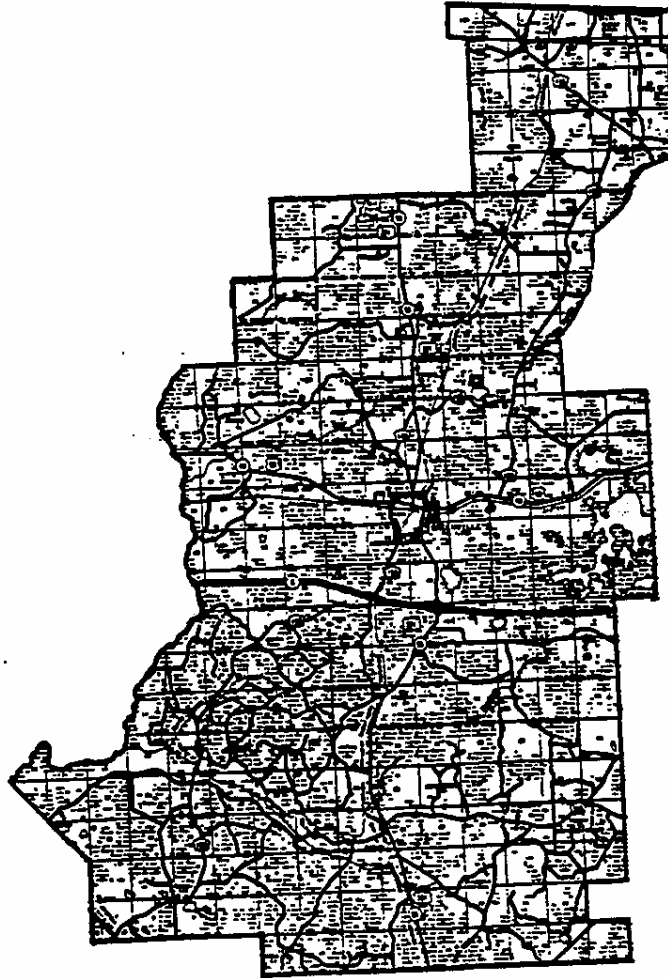



GENERAL EXCHANGE TARIFF

Embarq Florida, Inc.

By: F. B. Poag  
Director

Supplement Section 3  
First Revised Sheet 37  
Cancelling Original Sheet 37  
Effective: January 1, 1997

GREENWOOD EXCHANGE

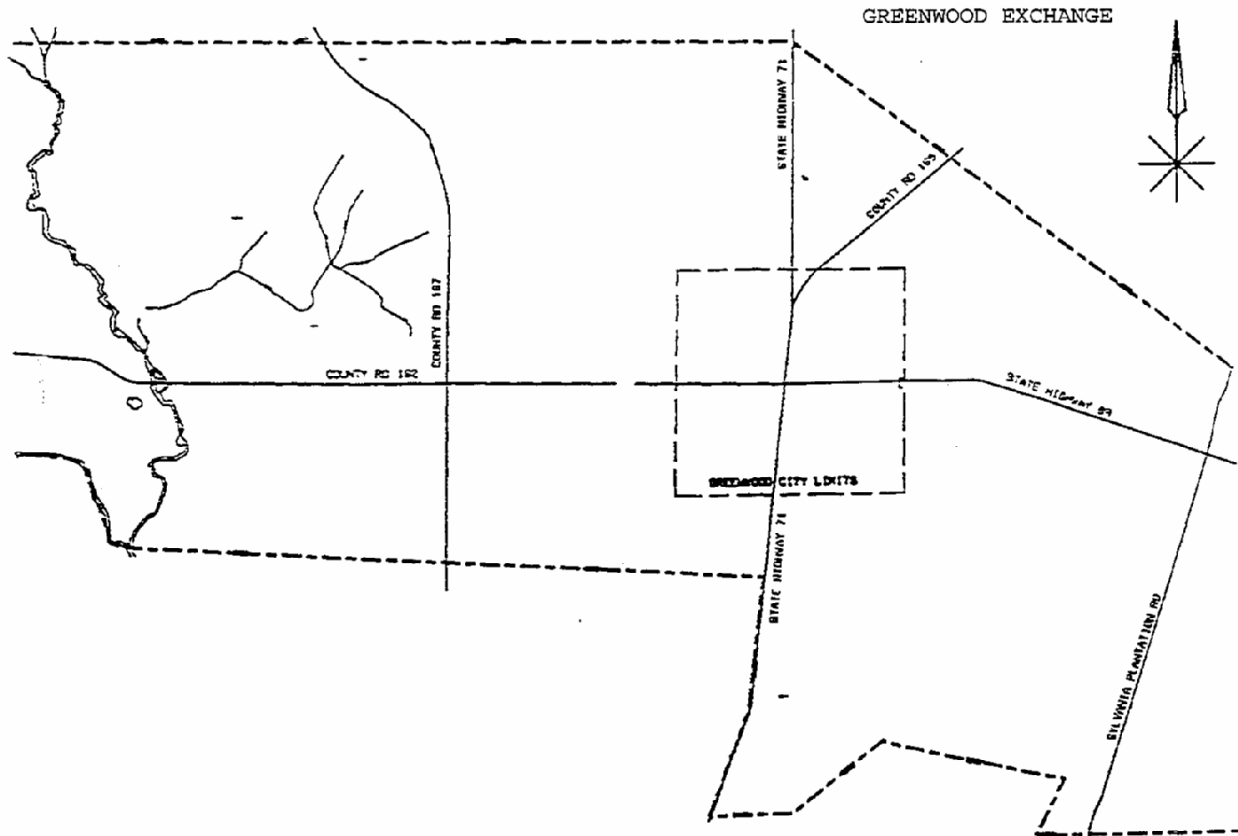

LEGEND

-----	EXCHANGE BOUNDARY
-----	COUNTY BOUNDARY
-----	BASE RATE BOUNDARY
GREW-CO	CENTRAL OFFICE LOCATION

GENERAL EXCHANGE TARIFF

Embarq Florida, Inc.

By: F. B. Poag  
Director

Supplement Section 3  
Second Revised Sheet 38  
Cancelling First Revised Sheet 38  
Effective: November 12, 2003

GROVELAND EXCHANGE

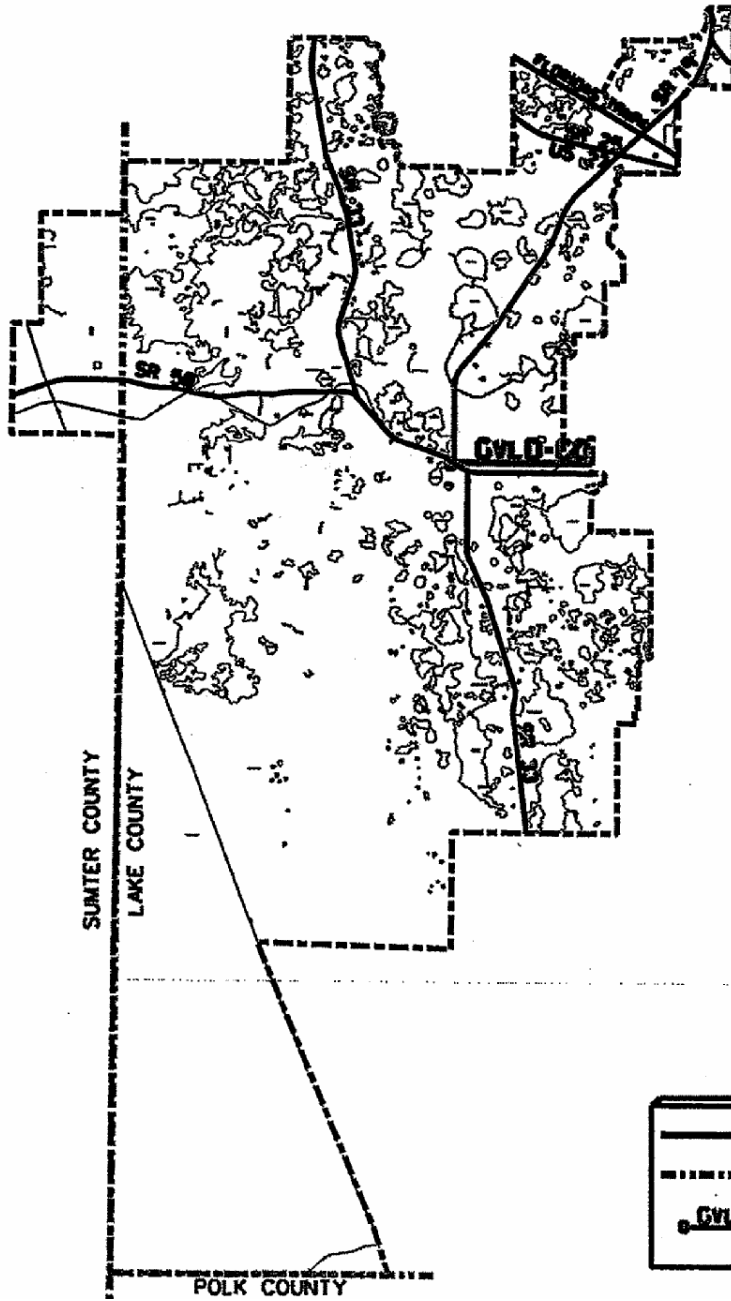

**LEGEND**

	EXCHANGE BOUNDARY
	COUNTY BOUNDARY
	CENTRAL OFFICE LOCATION

GENERAL EXCHANGE TARIFF

Embarq Florida, Inc.

By: F. B. Poag  
Director

Supplement Section 3  
First Revised Sheet 39  
Cancelling Original Sheet 39  
Effective: January 1, 1997

HOMOSASSA SPRINGS EXCHANGE

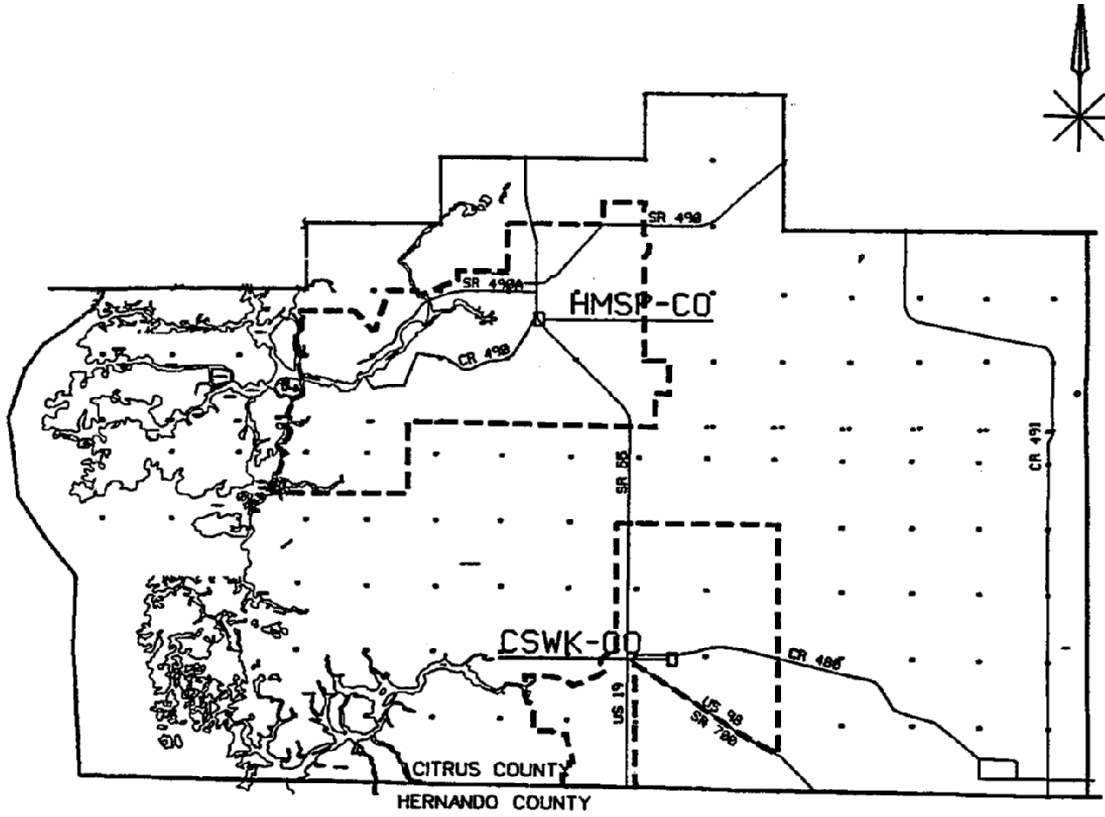

LEGEND

	EXCHANGE BOUNDARY
	COUNTY BOUNDARY
	BASE RATE BOUNDARY
	CENTRAL OFFICE LOCATION

GENERAL EXCHANGE TARIFF

Embarq Florida, Inc.

By: F. B. Poag  
Director

Supplement Section 3  
Second Revised Sheet 40  
Cancelling First Revised Sheet 40 & 40.1  
Effective: January 1, 1997

HOWEY-IN-THE-HILLS EXCHANGE

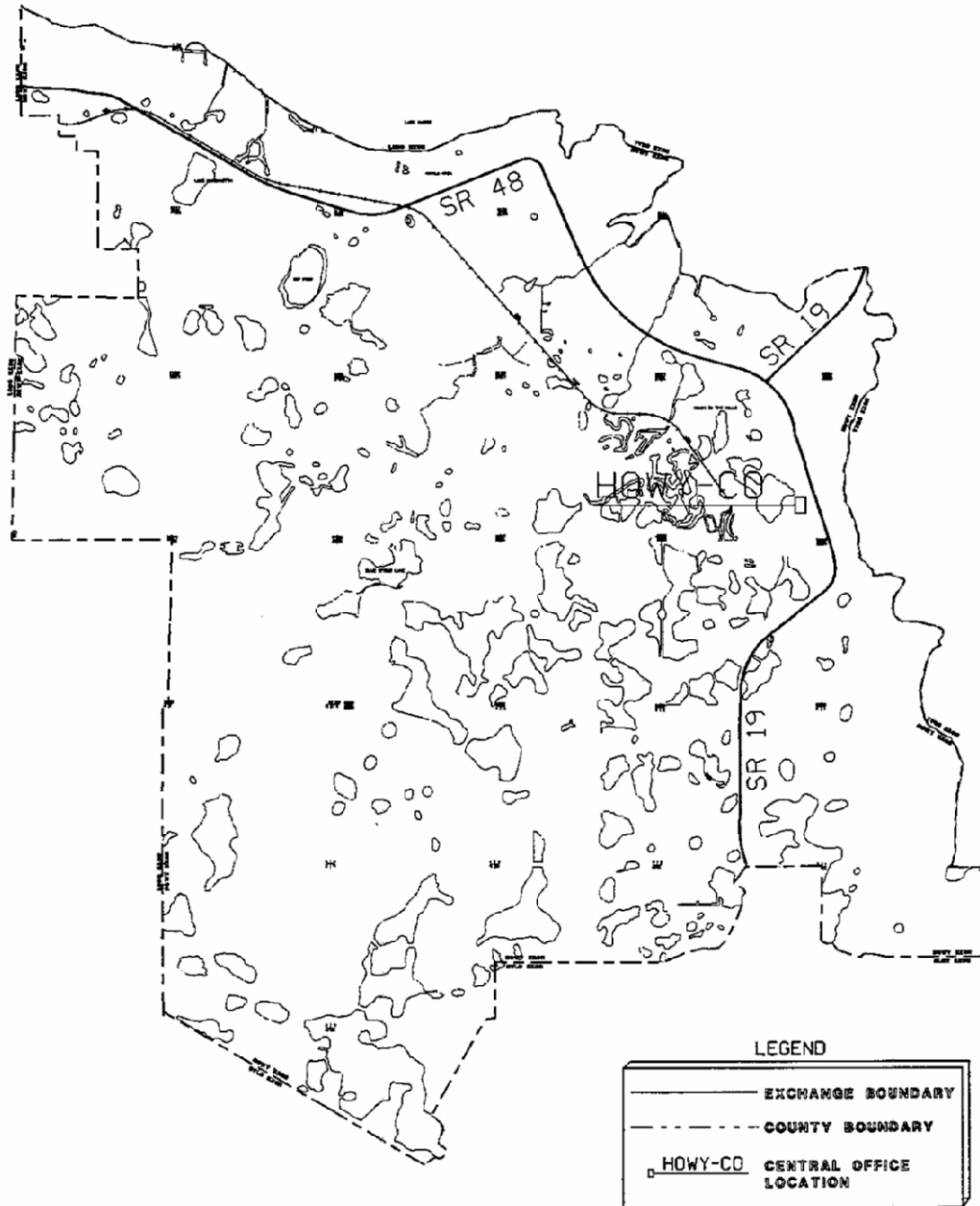

GENERAL EXCHANGE TARIFF

Embarq Florida, Inc.

SUPPLEMENT SECTION A3  
Fifth Revised Sheet 41  
Cancelling Fourth Sheet 41  
Effective: March 25, 2005

By: F. B. Poag  
Director

EXCHANGE SERVICE AREA MAP

IMMOKALEE

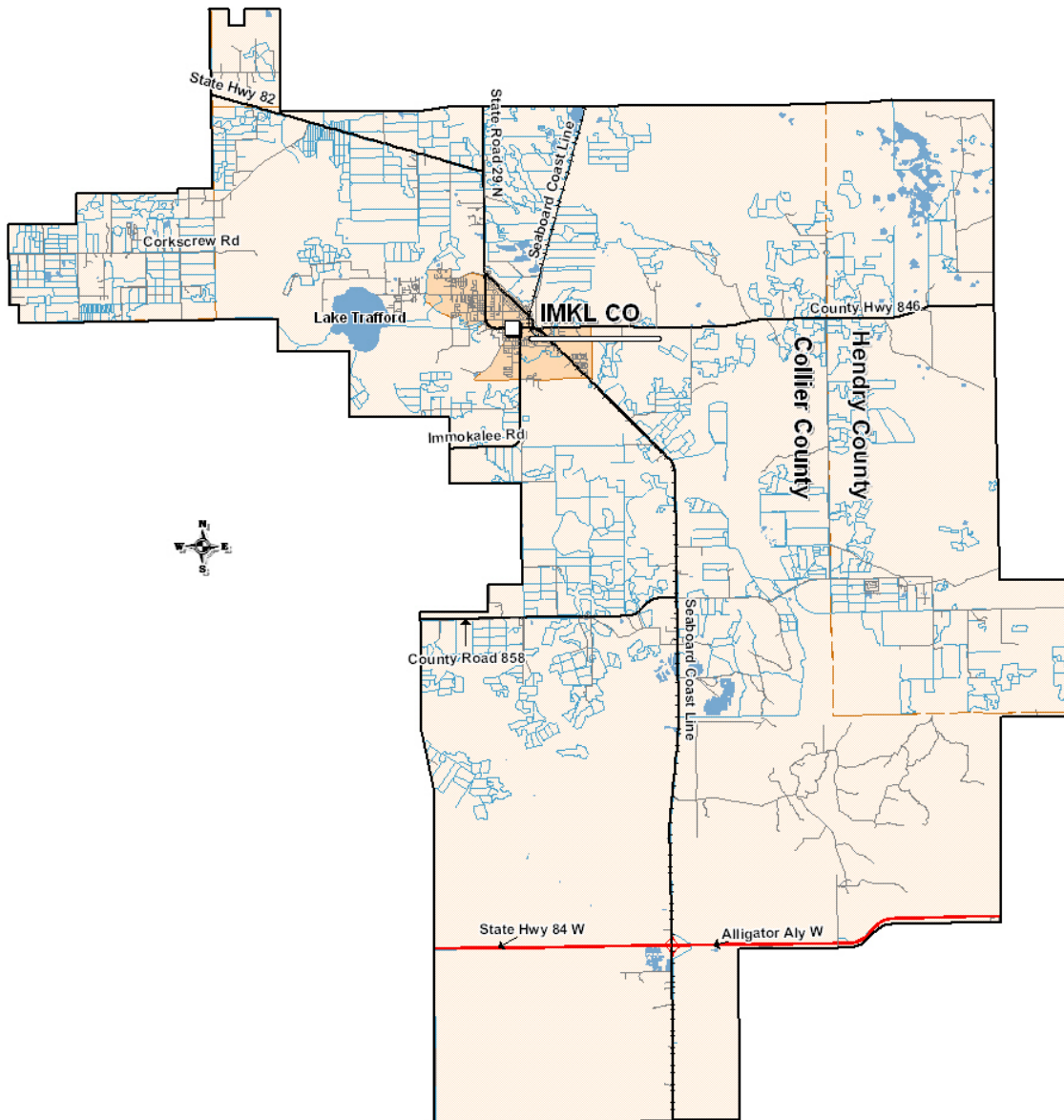

GENERAL EXCHANGE TARIFF

Embarq Florida, Inc.

By: F. B. Poag  
Director

Supplement Section 3  
First Revised Sheet 42  
Cancelling Original Sheet 42  
Effective: January 1, 1997

INVERNESS SPRINGS EXCHANGE

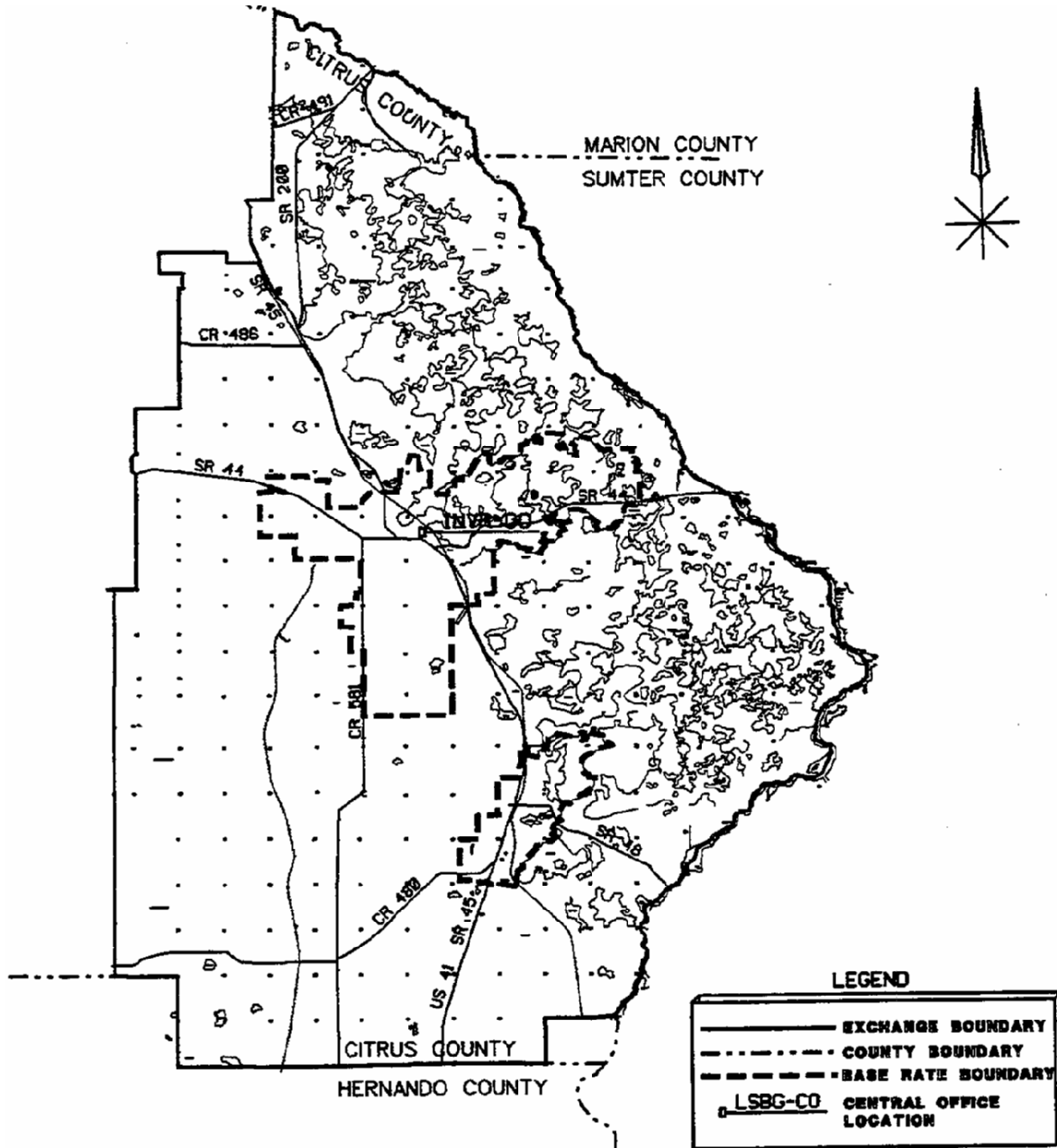

GENERAL EXCHANGE TARIFF

Embarq Florida, Inc.

By: F. B. Poag  
Director

Supplement Section 3  
First Revised Sheet 43  
Cancelling Original Sheet 43  
Effective: January 1, 1997

KENANSVILLE EXCHANGE

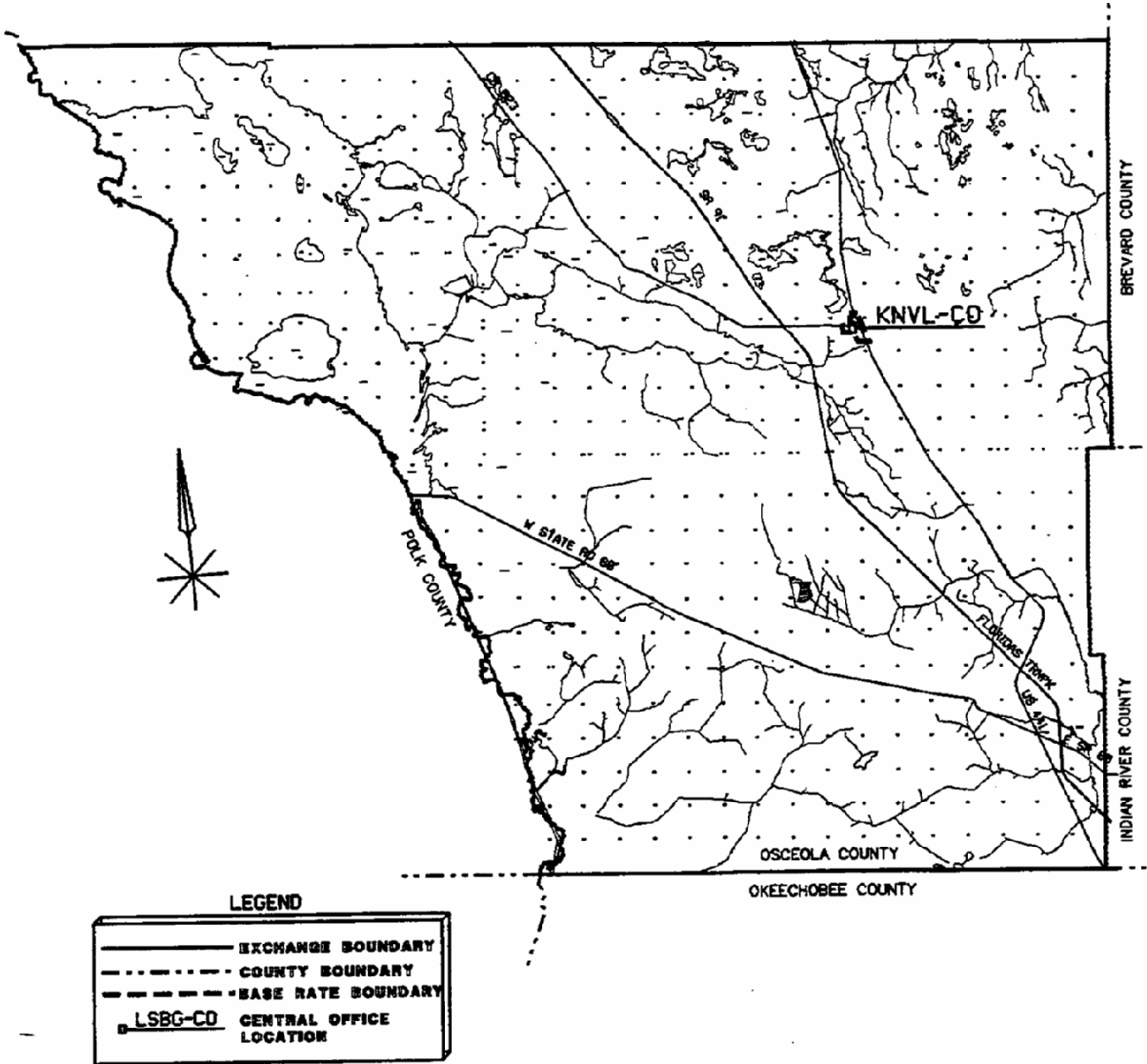

GENERAL EXCHANGE TARIFF

Embarq Florida, Inc.

By: F. B. Poag  
Director

Supplement Section 3  
First Revised Sheet 44  
Cancelling Original Sheet 44  
Effective: January 1, 1997

KINGSLEY LAKE EXCHANGE

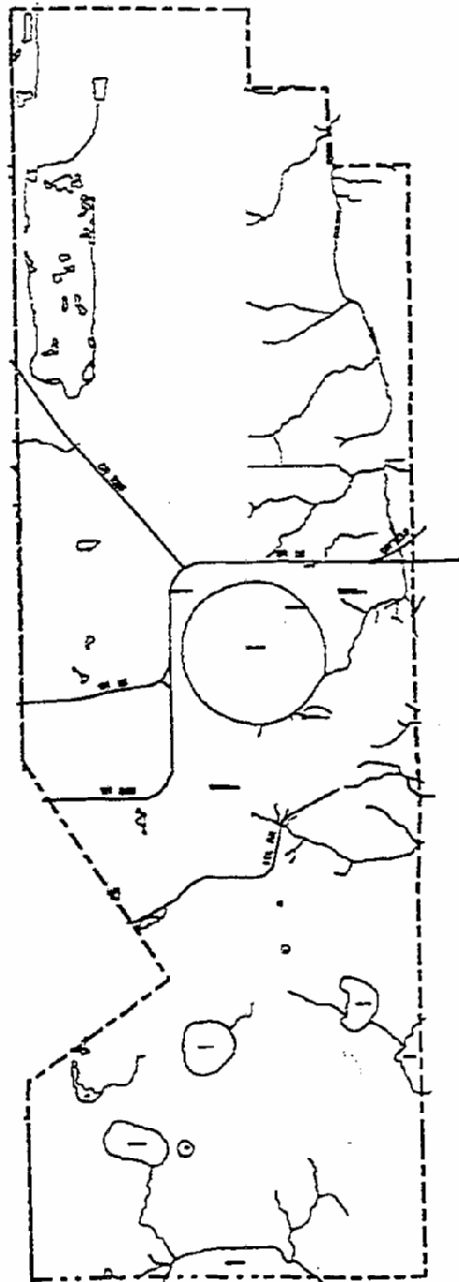

KINGSLEY LAKE EXCHANGE

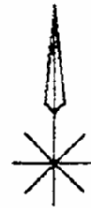

LEGEND

-----	EXCHANGE BOUNDARY
- · - · -	COUNTY BOUNDARY
————	BASE RATE BOUNDARY
□ KING-CO	CENTRAL OFFICE LOCATION



GENERAL EXCHANGE TARIFF

Embarq Florida, Inc.

BY: F. B. Poag  
Director

SUPPLEMENT SECTION A3  
Fifth Revised Sheet 45  
Canceling Fourth Revised Sheet 45  
EFFECTIVE: September 1, 2004

EXCHANGE SERVICE AREA MAP  
KISSIMMEE EXCHANGE

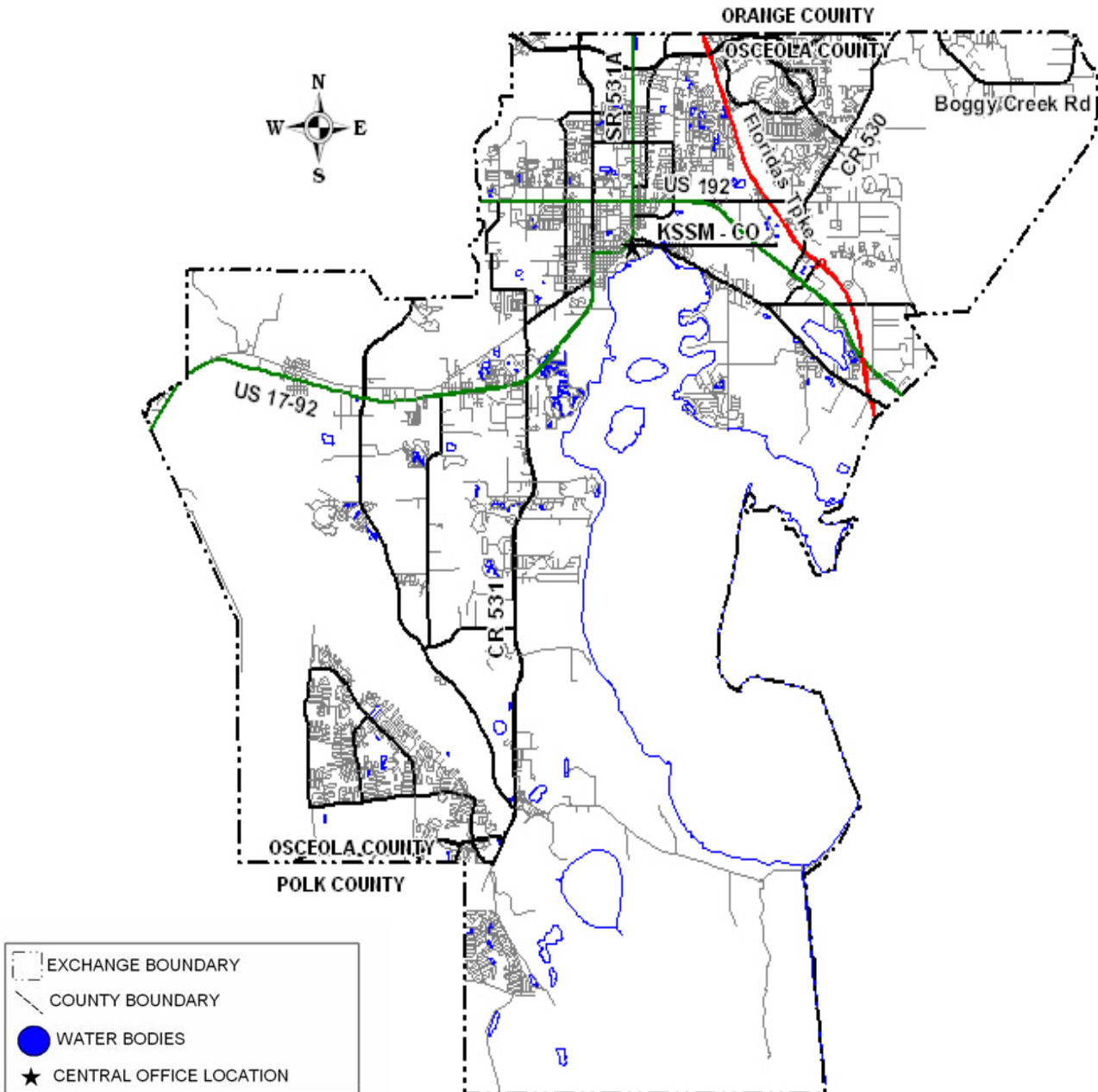

GENERAL EXCHANGE TARIFF

Embarq Florida, Inc.

By: F. B. Poag  
Director

Supplement Section 3  
First Revised Sheet 46  
Cancelling Original Sheet 46  
Effective: January 1, 1997

LABELLE EXCHANGE

LABELLE EXCHANGE

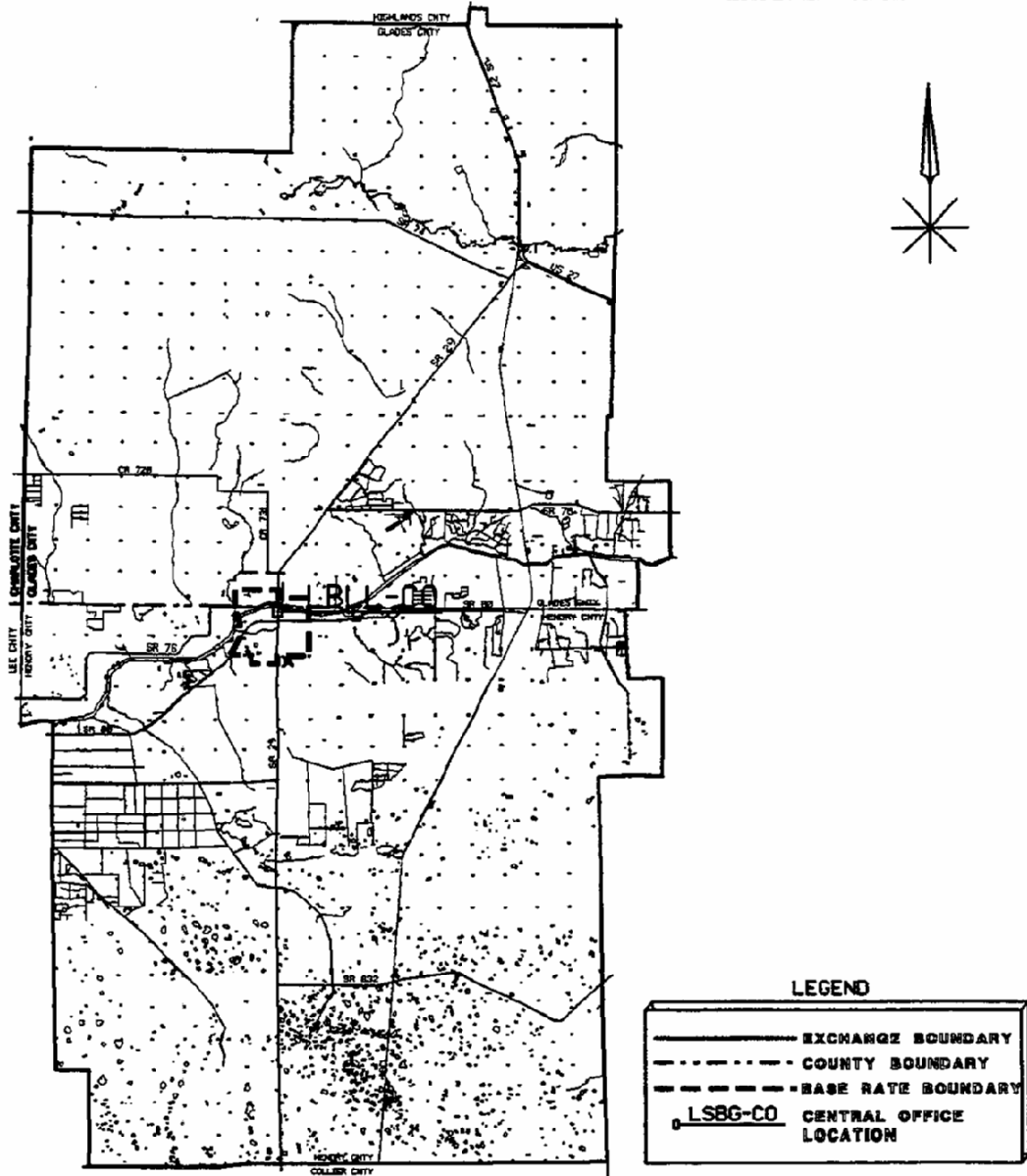

GENERAL EXCHANGE TARIFF

Embarq Florida, Inc.

SUPPLEMENT SECTION A3  
Sixth Revised Sheet 47  
Cancelling Fifth Revised 47  
Effective: October 21, 2005

By: F. B. Poag  
Director

EXCHANGE SERVICE AREA MAP

LADY LAKE

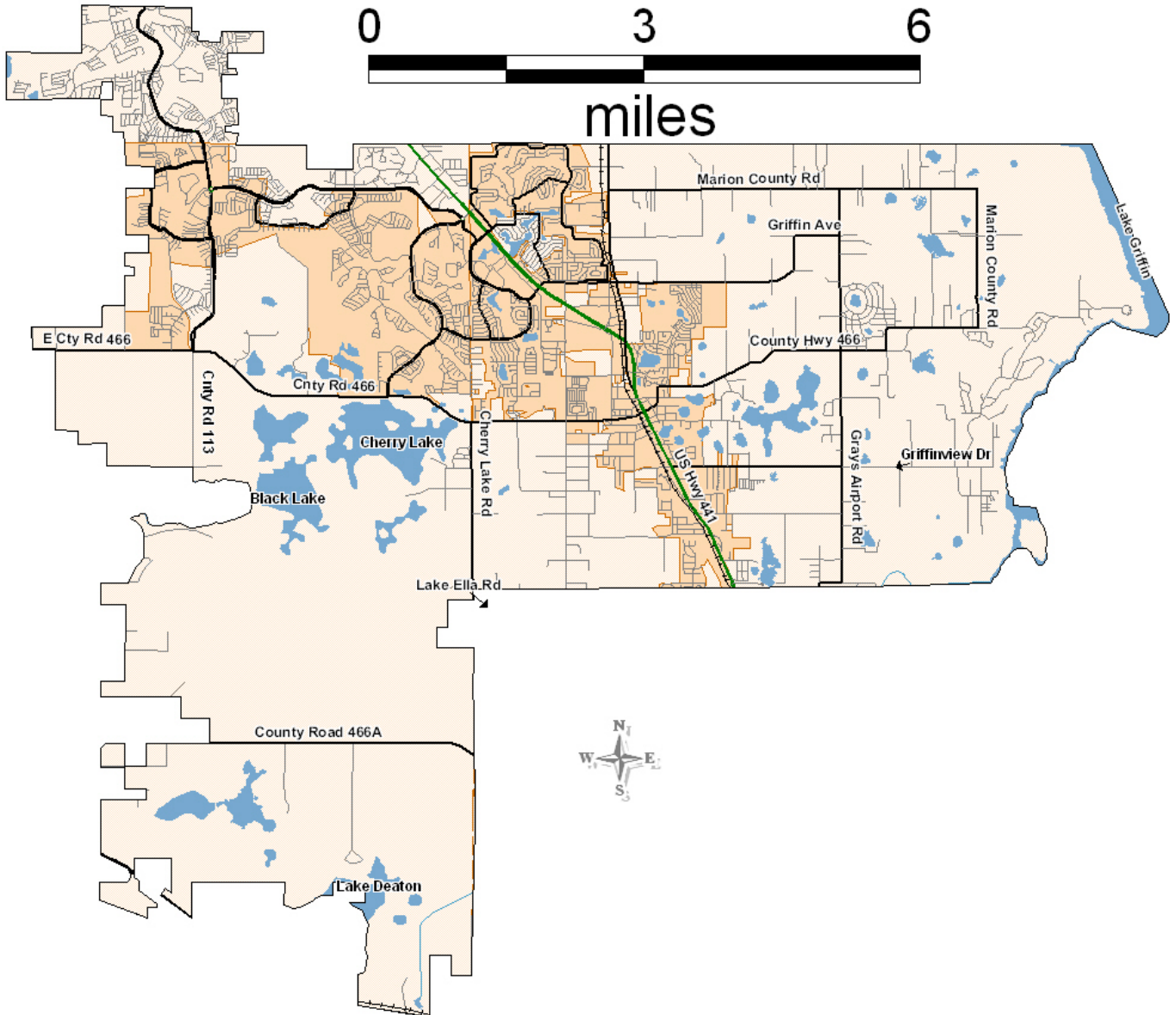

GENERAL EXCHANGE TARIFF

Embarq Florida, Inc.

By: F. B. Poag  
Director

Supplement Section 3  
First Revised Sheet 48  
Cancelling Original Sheet 48  
Effective: January 1, 1997

LAKE PLACID EXCHANGE

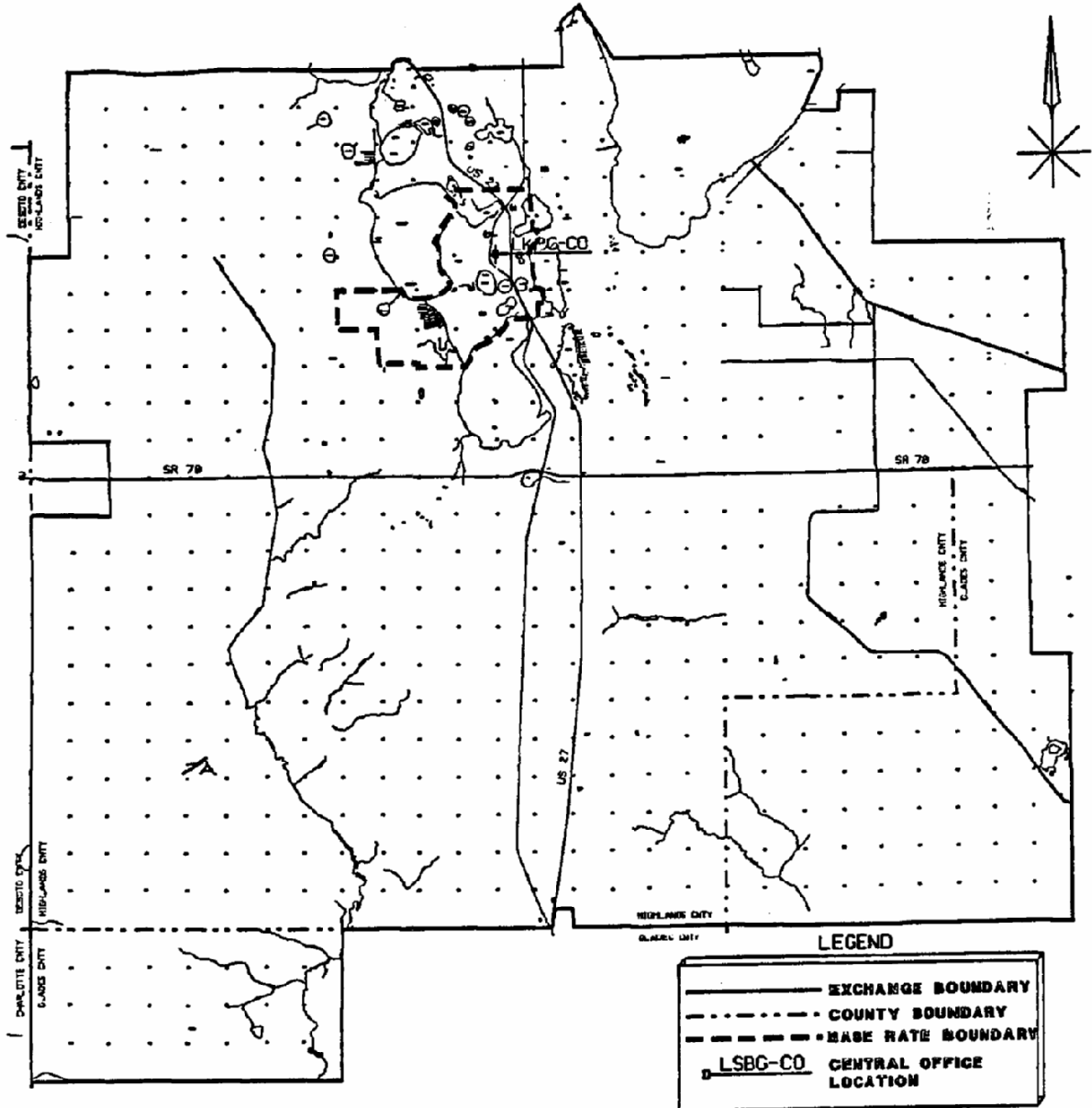

GENERAL EXCHANGE TARIFF

Embarq Florida, Inc.

By: F. B. Poag  
Director

Supplement Section 3  
First Revised Sheet 49  
Cancelling Original Sheet 49  
Effective: January 1, 1997

LAWTEY EXCHANGE

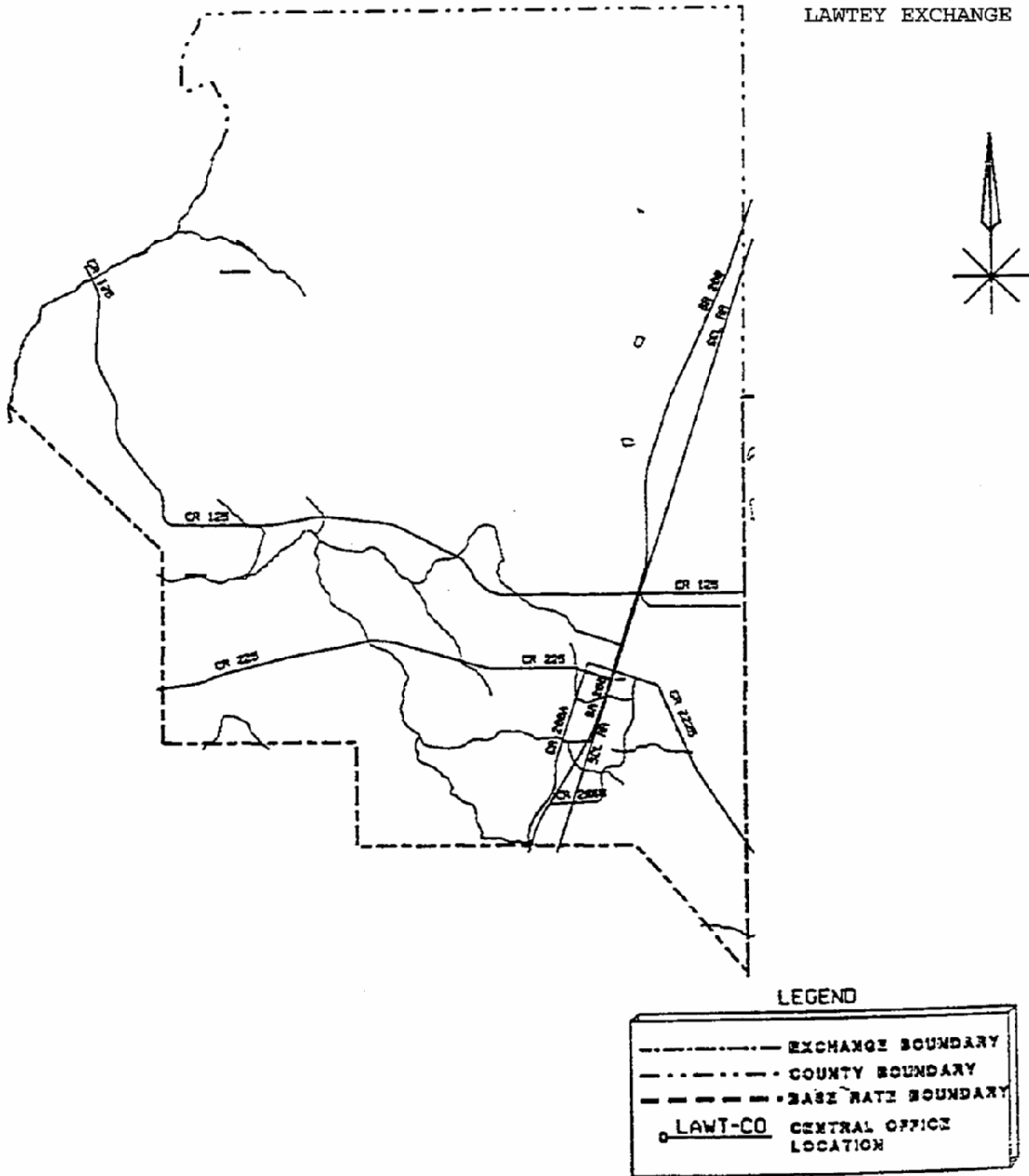

GENERAL EXCHANGE TARIFF

Embarq Florida, Inc.

By: F. B. Poag  
Director

Supplement Section 3  
First Revised Sheet 50  
Cancelling Original Sheet 50  
Effective: January 1, 1997

LEE EXCHANGE

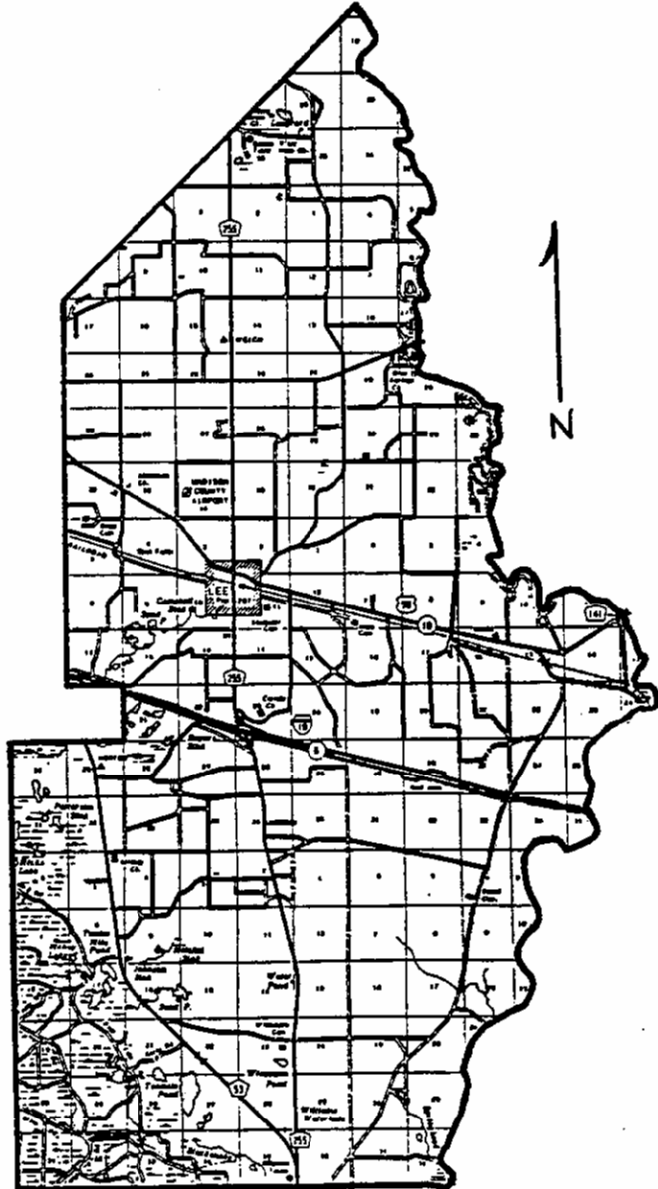

GENERAL EXCHANGE TARIFF

Embarq Florida, Inc.

SUPPLEMENT SECTION A3  
Third Revised Sheet 51  
Cancelling Second Revised 51  
Effective: October 21, 2005

By: F. B. Poag  
Director

EXCHANGE SERVICE AREA MAP

LEESBURG

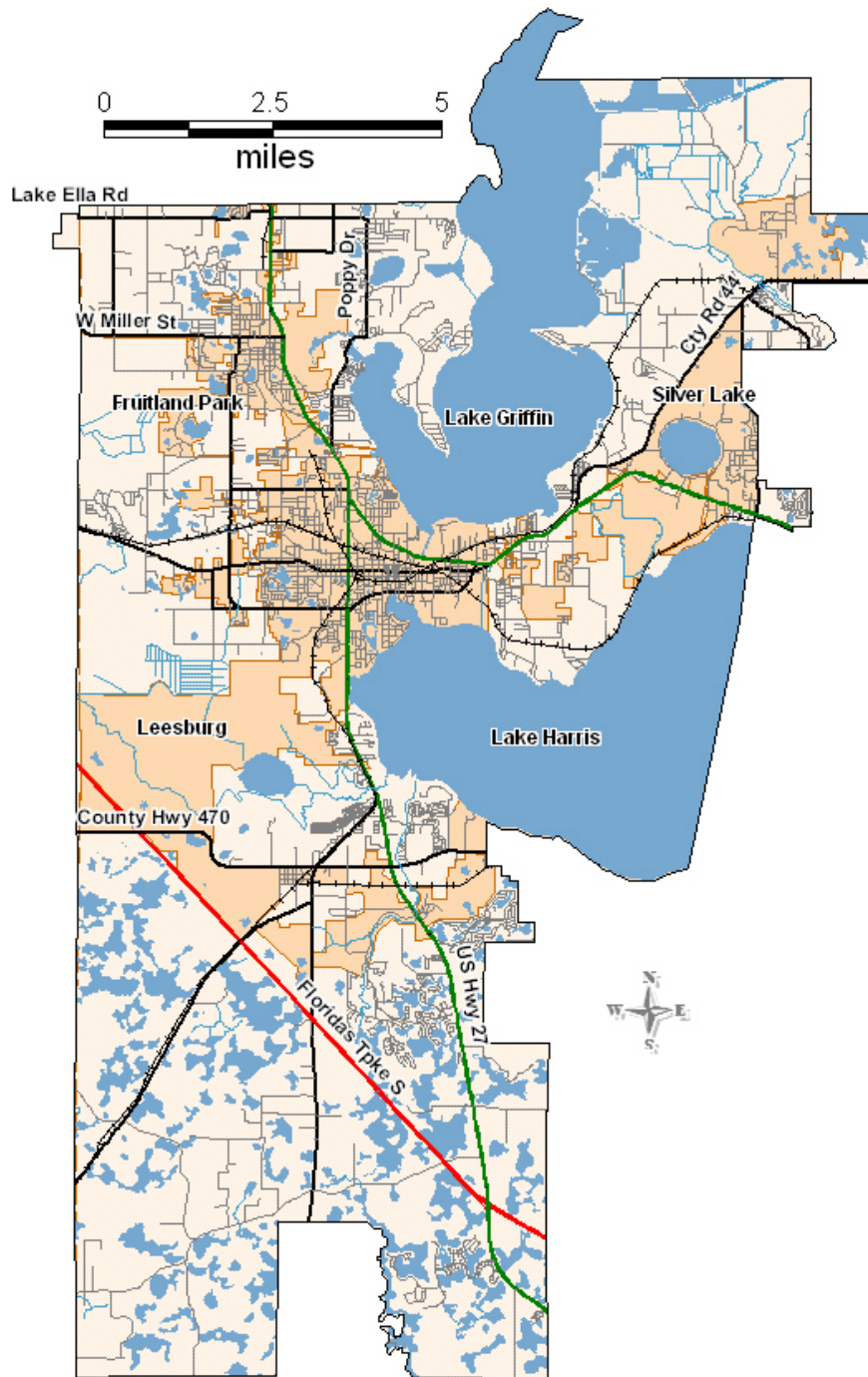





GENERAL EXCHANGE TARIFF

Embarq Florida, Inc.

By: F. B. Poag  
Director

Supplement Section 3  
First Revised Sheet 53  
Cancelling Original Sheet 53  
Effective: January 1, 1997

MADISON EXCHANGE

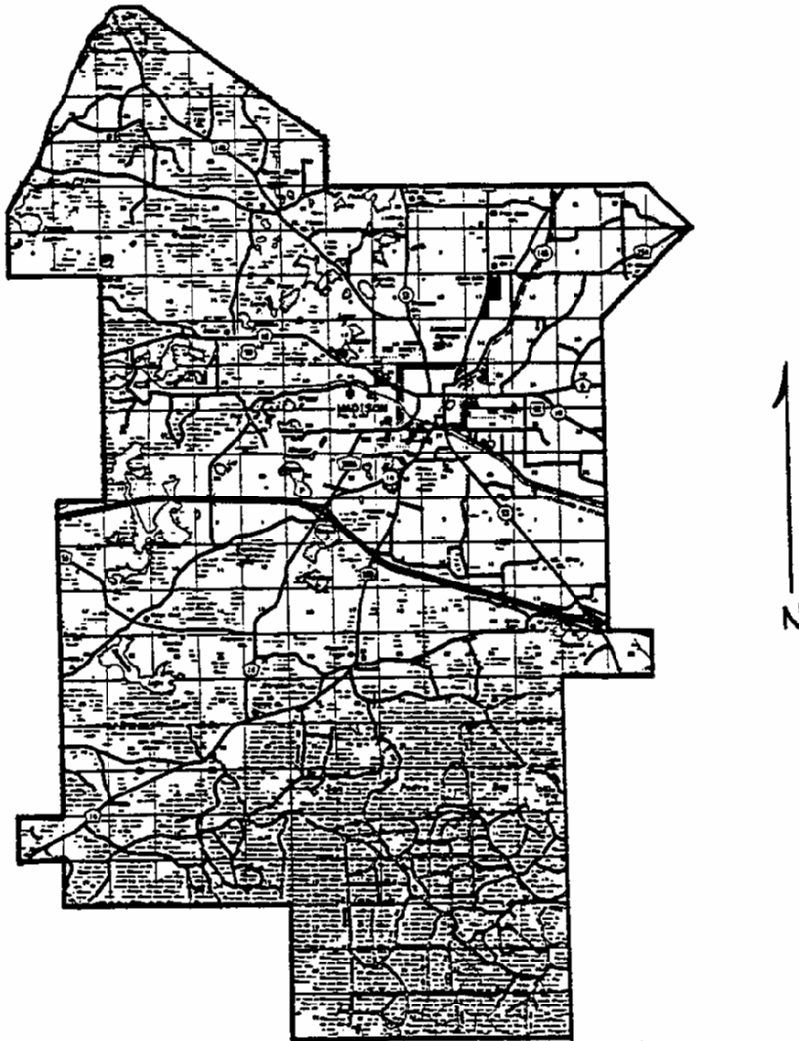

GENERAL EXCHANGE TARIFF

Embarq Florida, Inc.

By: F. B. Poag  
Director

Supplement Section 3  
First Revised Sheet 54  
Cancelling Original Sheet 54  
Effective: January 1, 1997

MALONE EXCHANGE

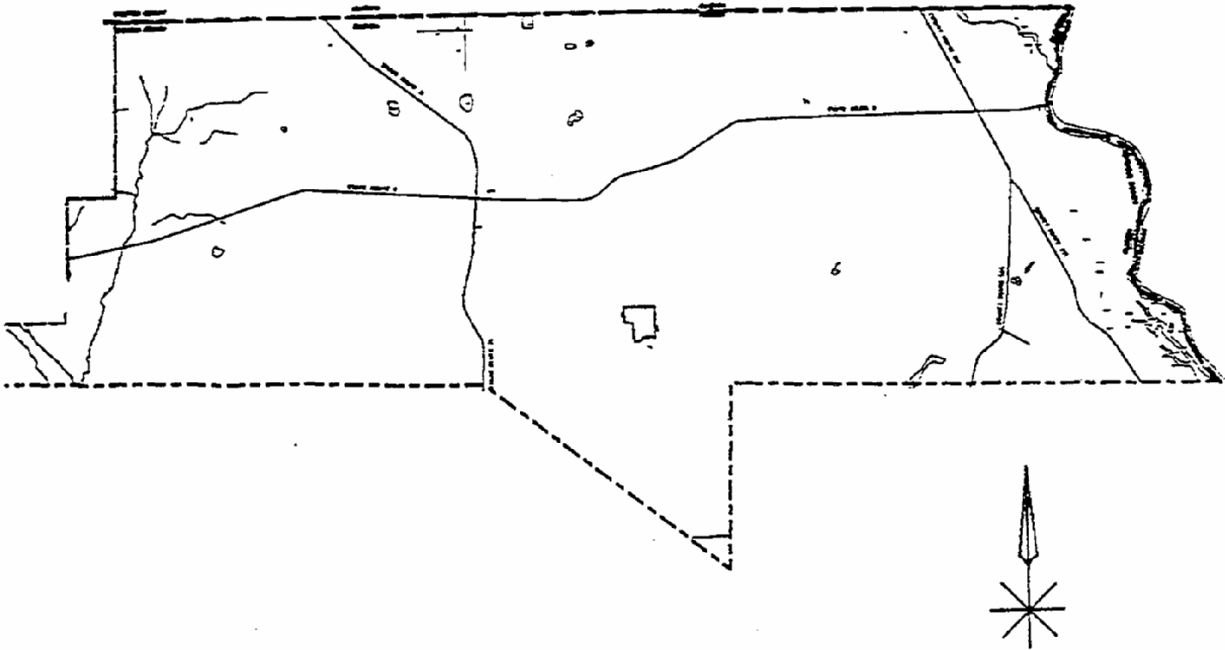

LEGEND

-----	EXCHANGE BOUNDARY
-----	COUNTY BOUNDARY
-----	BASE RATE BOUNDARY
□ MALO-CO	CENTRAL OFFICE LOCATION

GENERAL EXCHANGE TARIFF

Embarq Florida, Inc.

By: F. B. Poag  
Director

Supplement Section 3  
First Revised Sheet 55  
Cancelling Original Sheet 55  
Effective: January 1, 1997

MARCO ISLAND EXCHANGE

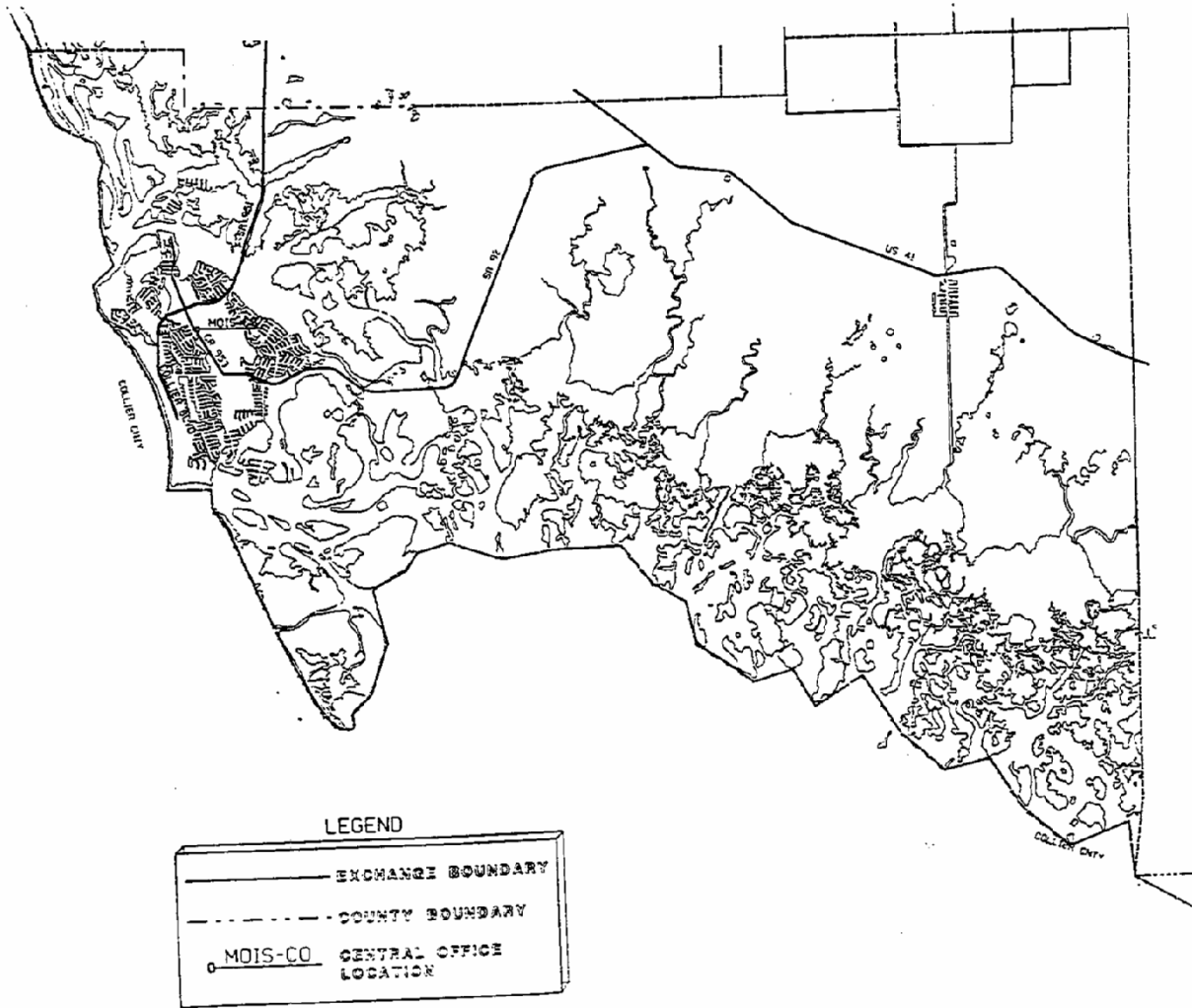

GENERAL EXCHANGE TARIFF

Embarq Florida, Inc.

By: F. B. Poag  
Director

Supplement Section 3  
First Revised Sheet 56  
Cancelling Original Sheet 56  
Effective: January 1, 1997

MARIANNA EXCHANGE

MARIANNA EXCHANGE

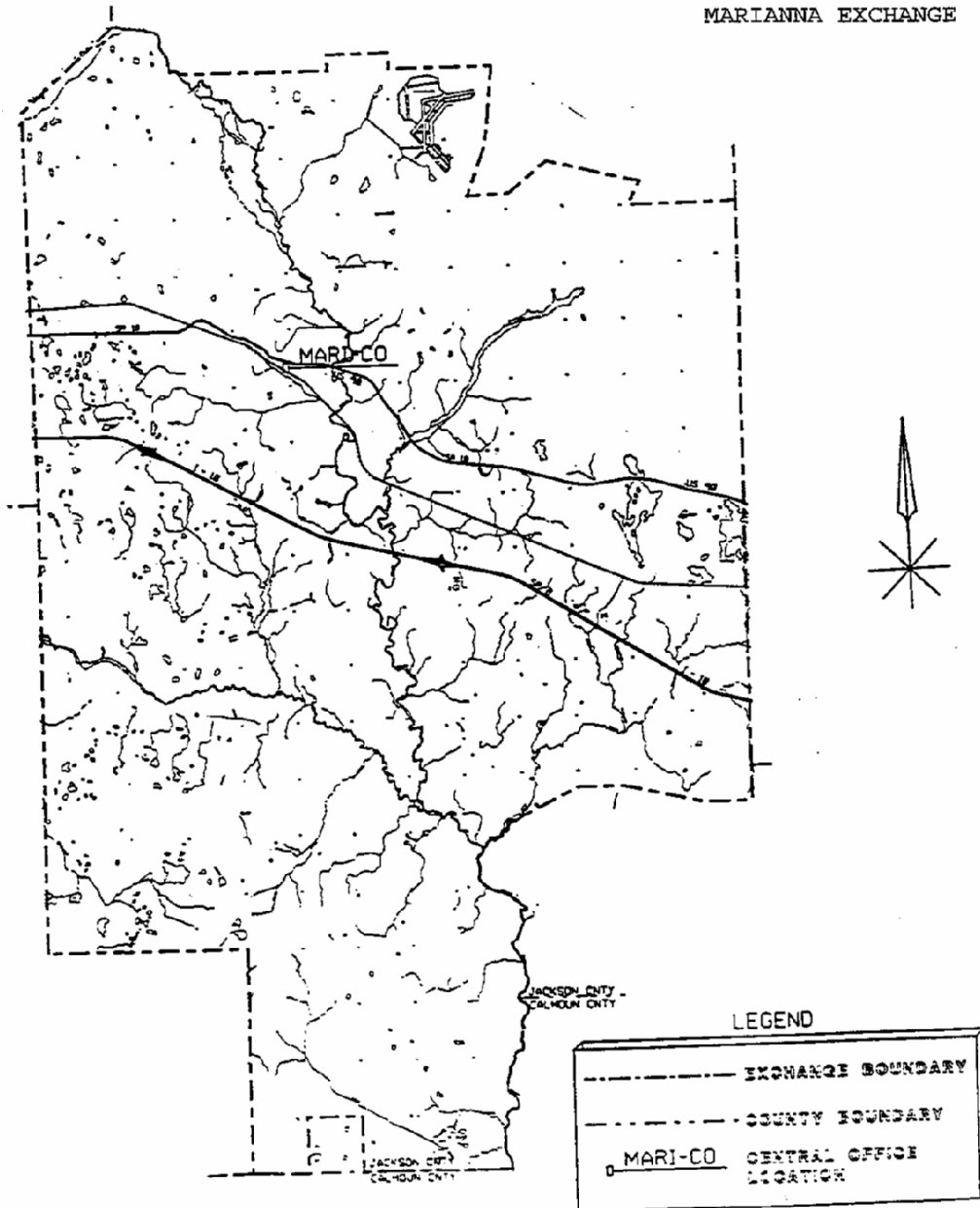

GENERAL EXCHANGE TARIFF

Embarq Florida, Inc.

By: F. B. Poag  
Director

Supplement Section 3  
First Revised Sheet 57  
Cancelling Original Sheet 57  
Effective: January 1, 1997

MONTICELLO EXCHANGE

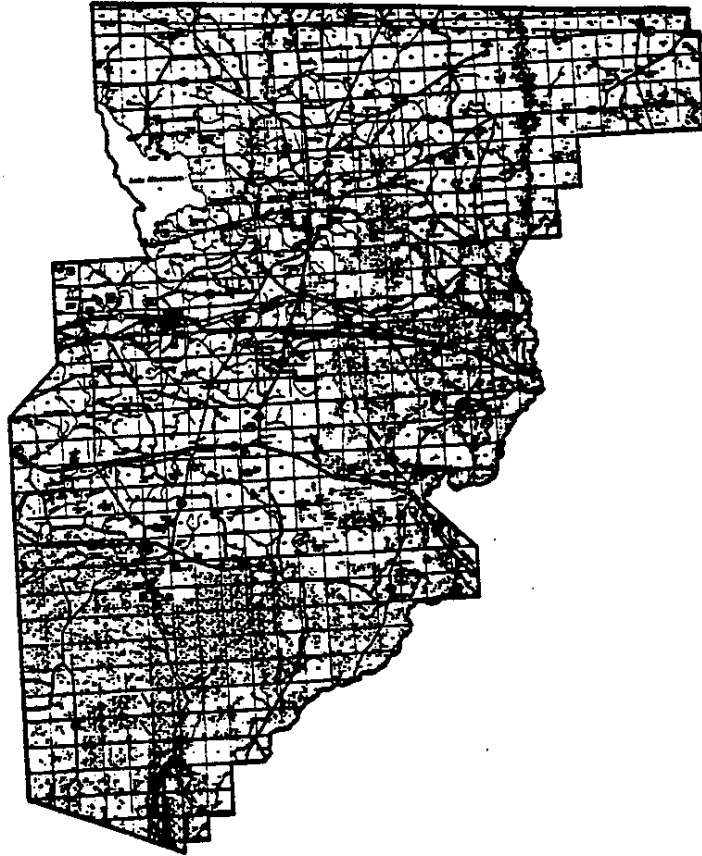

GENERAL EXCHANGE TARIFF

Embarq Florida, Inc.

By: F. B. Poag  
Director

Supplement Section 3  
First Revised Sheet 58  
Cancelling Original Sheet 58  
Effective: January 1, 1997

MONTVERDE EXCHANGE

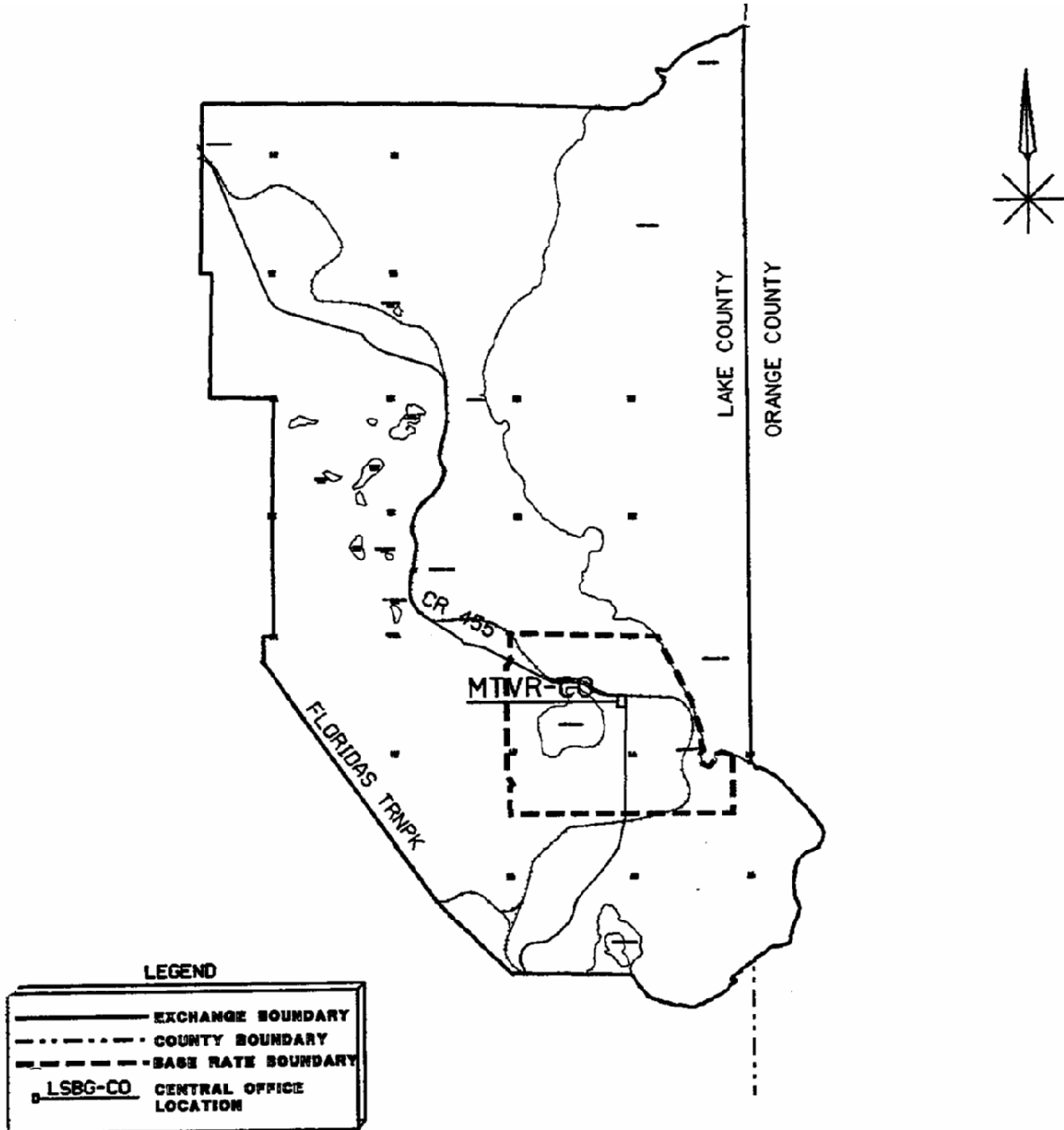

GENERAL EXCHANGE TARIFF

Embarq Florida, Inc.

By: F. B. Poag  
Director

Supplement Section 3  
First Revised Sheet 59  
Cancelling Original Sheet 59  
Effective: January 1, 1997

MOORE HAVEN EXCHANGE

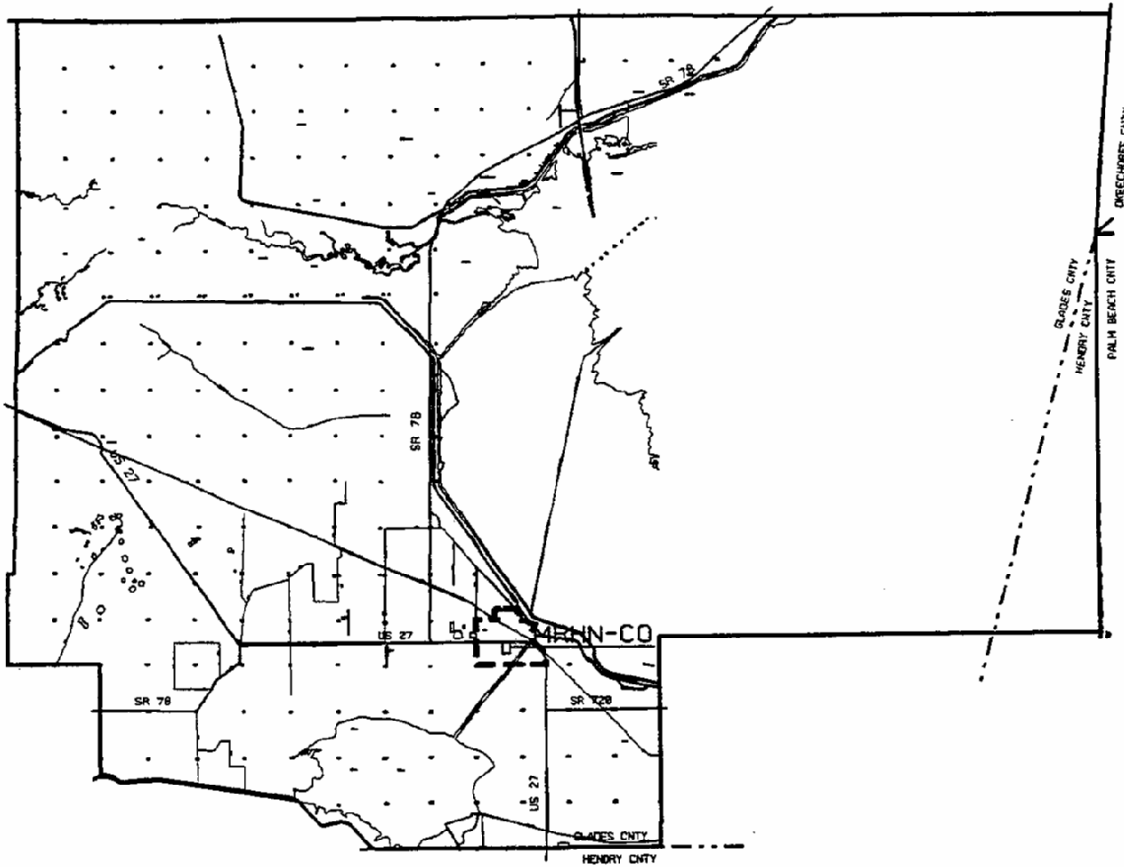

LEGEND

	EXCHANGE BOUNDARY
	COUNTY BOUNDARY
	BASE RATE BOUNDARY
	CENTRAL OFFICE LOCATION

GENERAL EXCHANGE TARIFF

Embarq Florida, Inc.

SUPPLEMENT SECTION A3  
Third Revised Sheet 60  
Cancelling Second Revised Sheet 60

By: F. B. Poag  
Director

Effective: June 10, 2005

EXCHANGE SERVICE AREA MAP

MOUNT DORA EXCHANGE

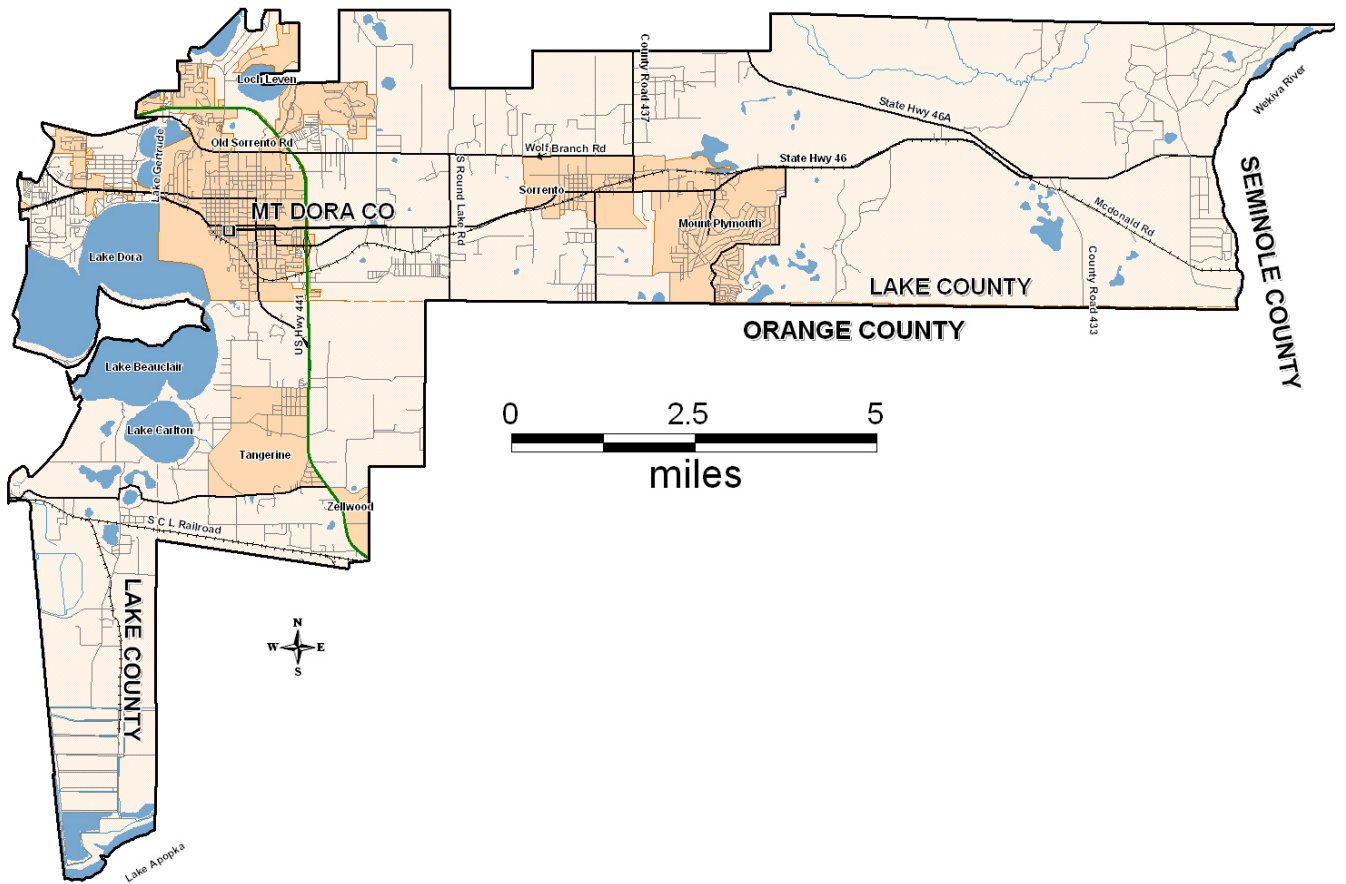



GENERAL EXCHANGE TARIFF

Embarq Florida, Inc.

SUPPLEMENT SECTION A3  
Eighth Revised Sheet 61  
Cancelling Seventh Sheet 61  
Effective: March 25, 2005

By: F. B. Poag  
Director

EXCHANGE SERVICE AREA MAP

NAPLES

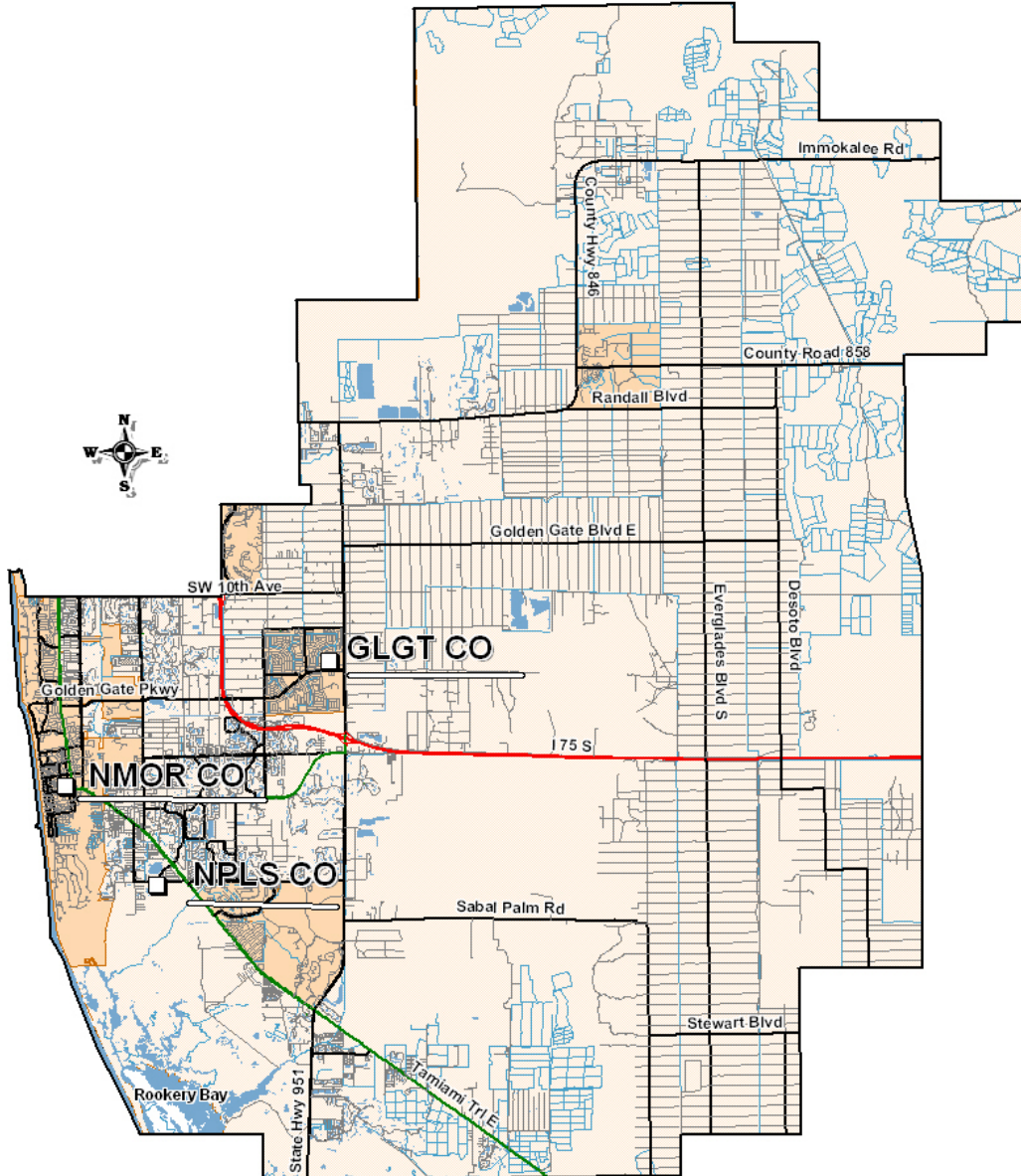

GENERAL EXCHANGE TARIFF

Embarq Florida, Inc.

By: F. B. Poag  
Director

Supplement Section 3  
First Revised Sheet 62  
Cancelling Original Sheet 62 & 62.1  
Effective: September 2, 1999

NORTH CAPE CORAL EXCHANGE

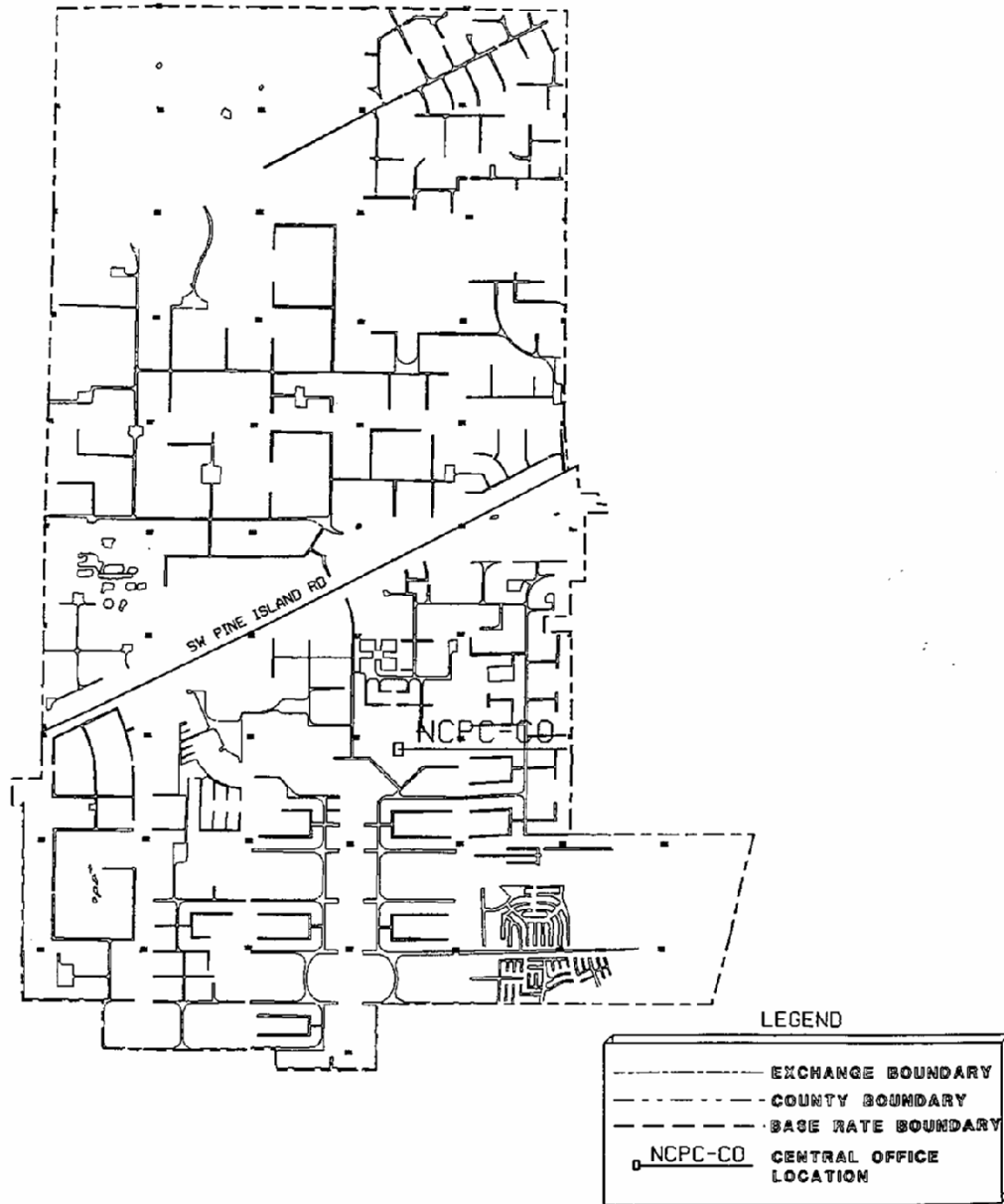

GENERAL EXCHANGE TARIFF

Embarq Florida, Inc.

By: F. B. Poag  
Director

Supplement Section 3  
First Revised Sheet 63  
Cancelling Original Sheet 63 & 63.1  
Effective: September 2, 1999

NORTH FORT MYERS EXCHANGE

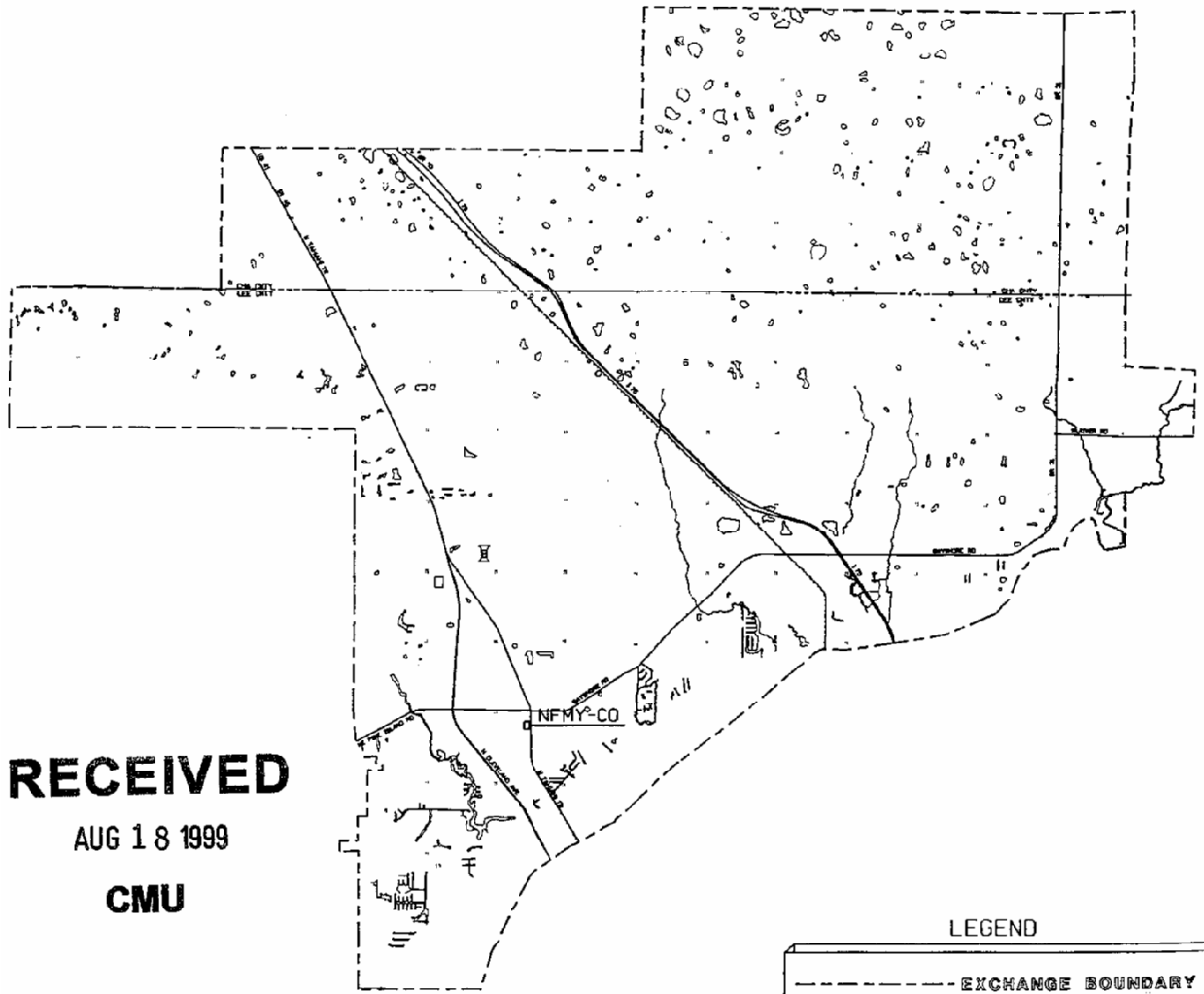

**RECEIVED**  
AUG 18 1999  
CMU

LEGEND	
-----	EXCHANGE BOUNDARY
-----	COUNTY BOUNDARY
□ NFMY-CO	CENTRAL OFFICE LOCATION

GENERAL EXCHANGE TARIFF

Embarq Florida, Inc.

SUPPLEMENT SECTION A3  
Third Revised Sheet 64  
Cancelling Second Revised Sheet 64

By: F. B. Poag  
Director

Effective: March 22, 2005

EXCHANGE SERVICE AREA MAP

NORTH NAPLES

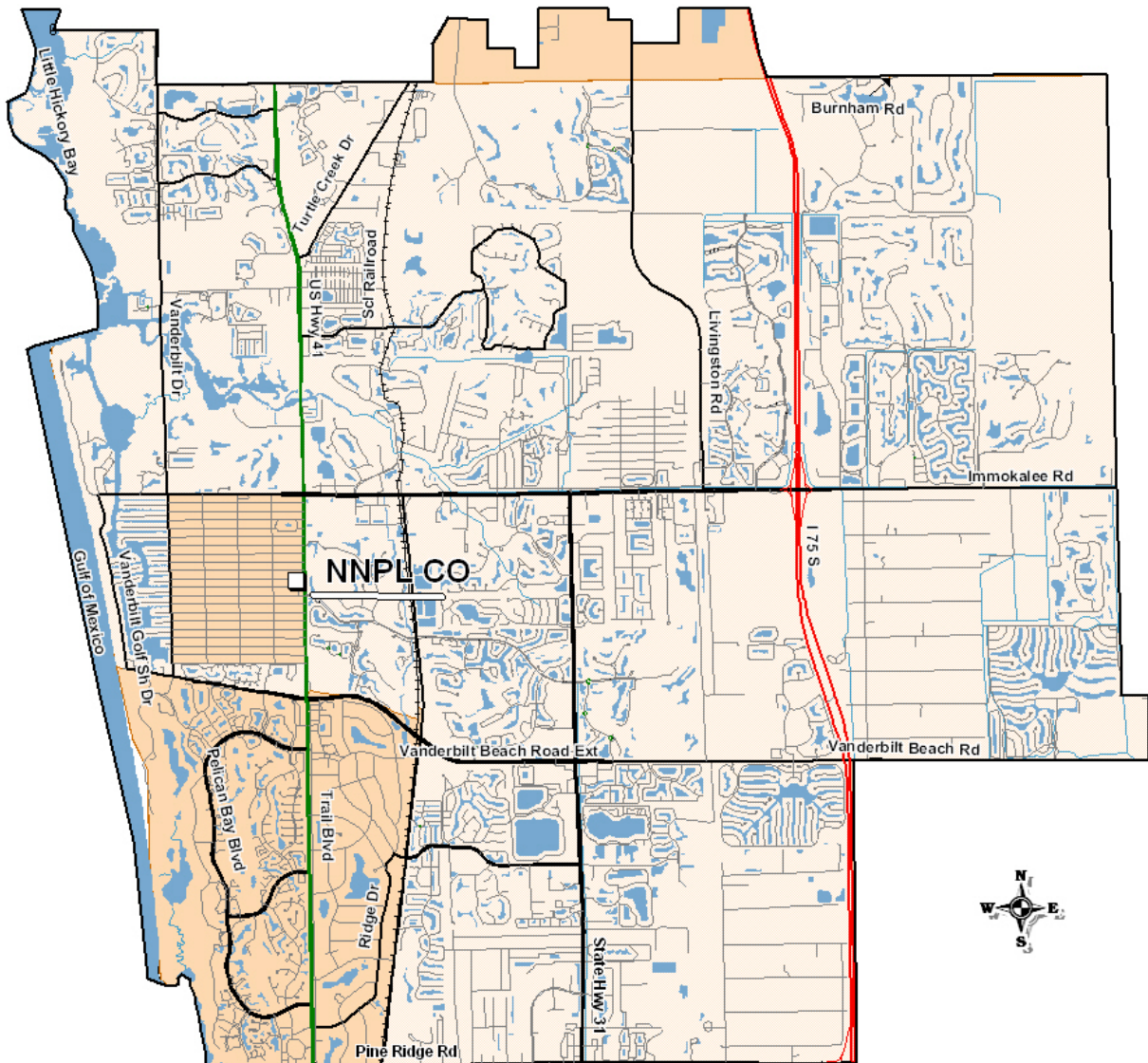

GENERAL EXCHANGE TARIFF

Embarq Florida, Inc.

By: F. B. Poag  
Director

Supplement Section 3  
First Revised Sheet 65  
Cancelling Original Sheet 65  
Effective: January 1, 1997

OCALA EXCHANGE

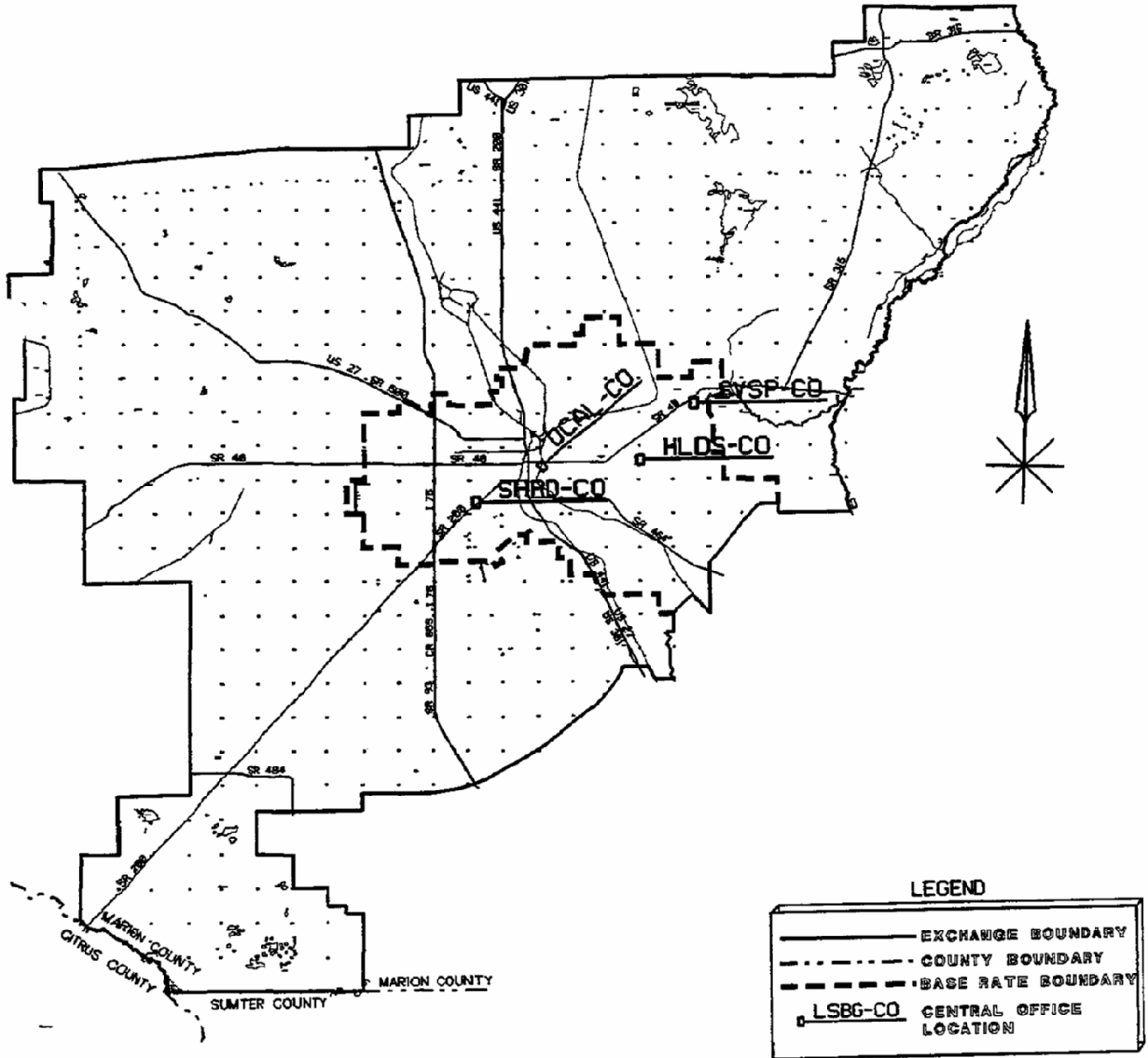

GENERAL EXCHANGE TARIFF

Embarq Florida, Inc.

By: F. B. Poag  
Director

Supplement Section 3  
Second Revised Sheet 66  
Cancelling First Revised Sheet 66 & 66.1  
Effective: August 16, 1997

OCKLAWAHA EXCHANGE

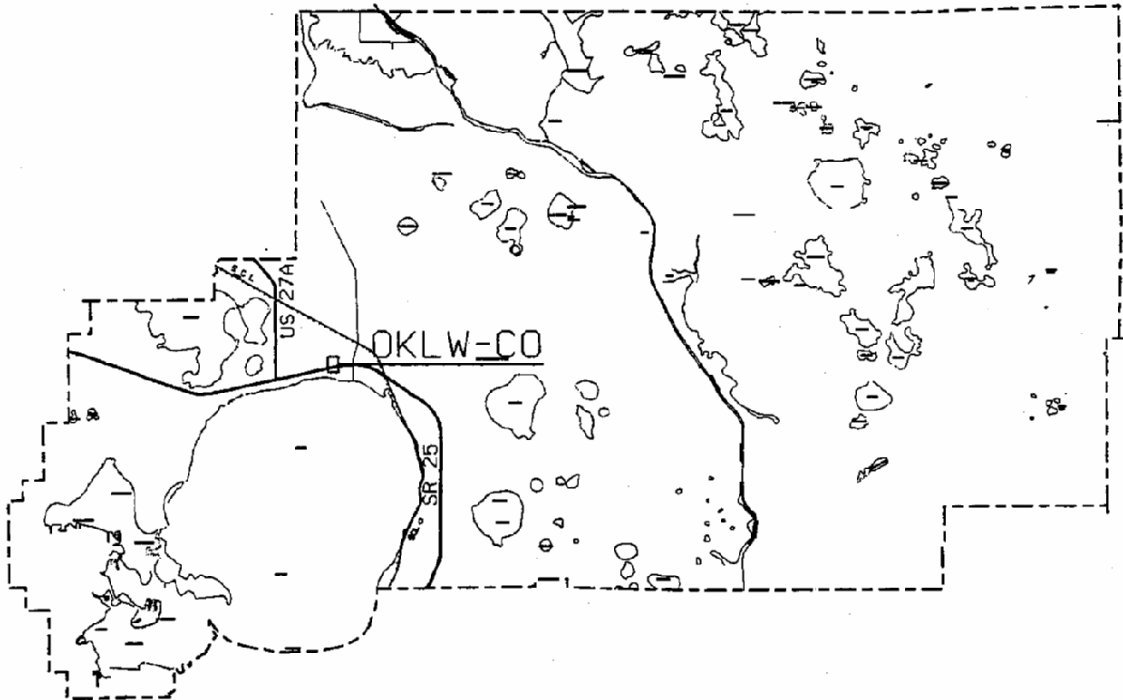

LEGEND

	EXCHANGE BOUNDARY
	COUNTY BOUNDARY
	CENTRAL OFFICE LOCATION

GENERAL EXCHANGE TARIFF

Embarq Florida, Inc.

By: F. B. Poag  
Director

Supplement Section 3  
First Revised Sheet 67  
Cancelling Original Sheet 67  
Effective: January 1, 1997

OKEECHOBEE EXCHANGE

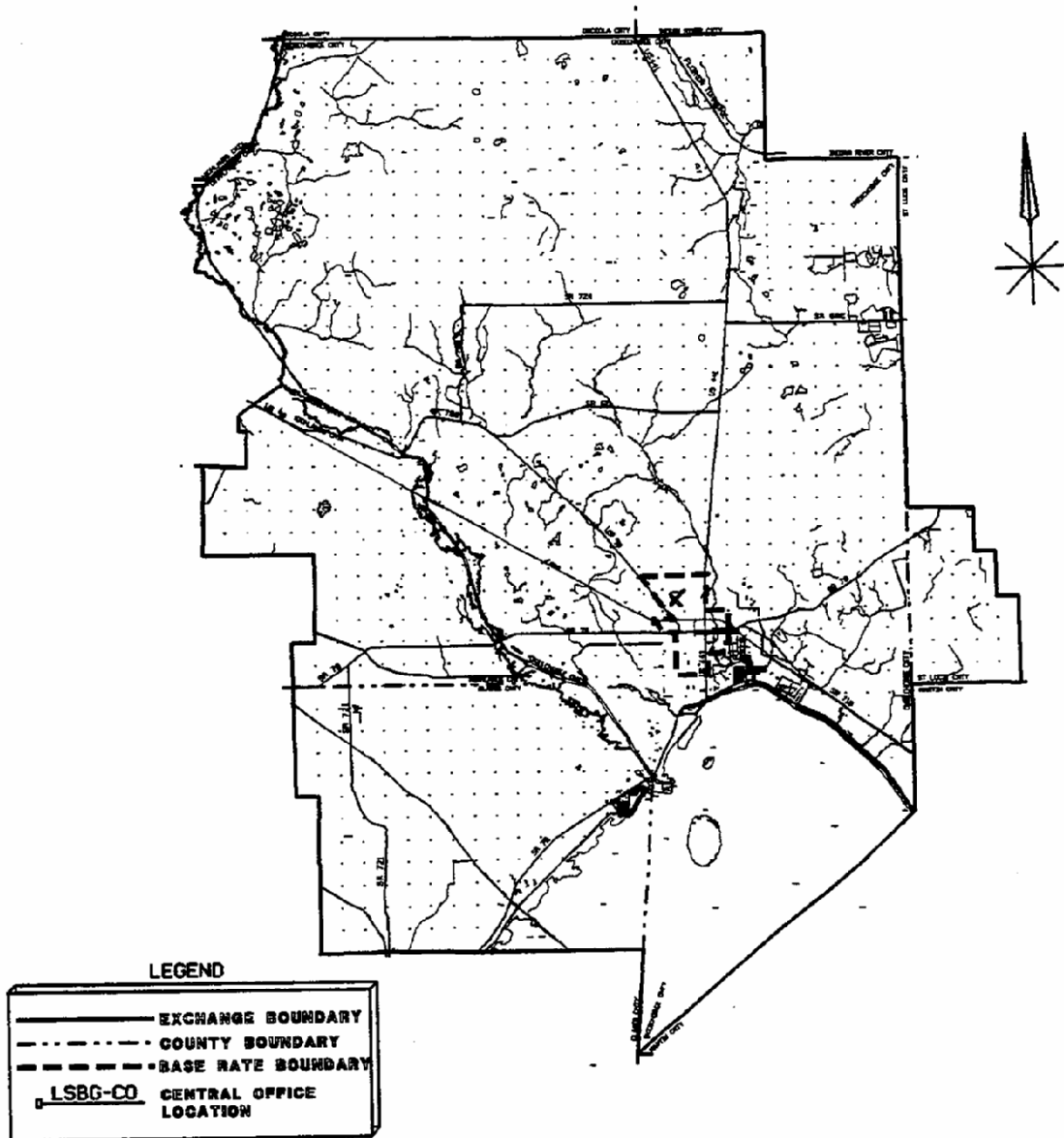

GENERAL EXCHANGE TARIFF

Embarq Florida, Inc.

By: F. B. Poag  
Director

Supplement Section 3  
First Revised Sheet 68  
Cancelling Original Sheet 68  
Effective: January 1, 1997

ORANGE CITY EXCHANGE

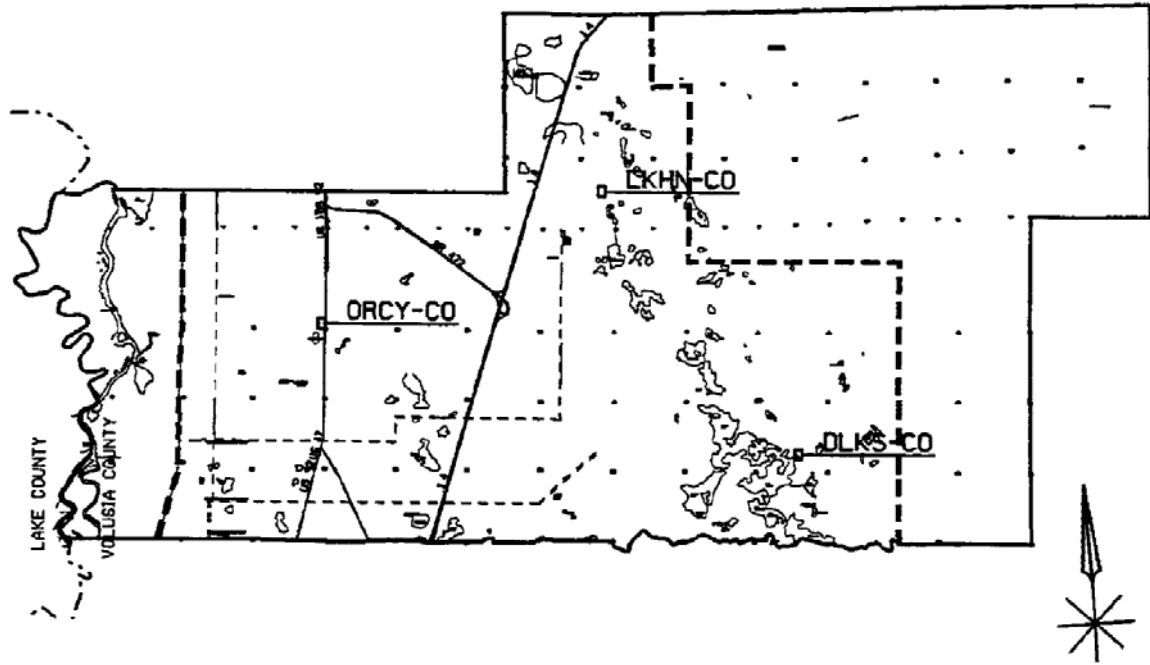

LEGEND

	EXCHANGE BOUNDARY
	COUNTY BOUNDARY
	BASE RATE BOUNDARY
	CENTRAL OFFICE LOCATION



GENERAL EXCHANGE TARIFF

Embarq Florida, Inc.

By: F. B. Poag  
Director

Supplement Section 3  
First Revised Sheet 69  
Cancelling Original Sheet 69  
Effective: January 1, 1997

PANACEA EXCHANGE

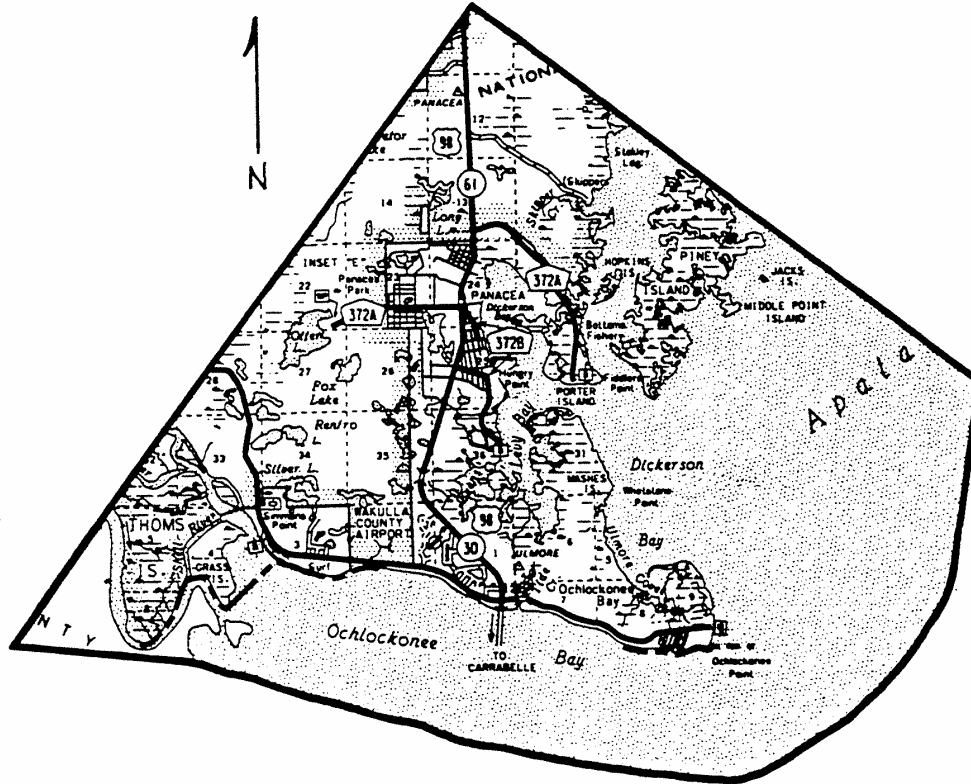

GENERAL EXCHANGE TARIFF

Embarq Florida, Inc.

By: F. B. Poag  
Director

Supplement Section 3  
First Revised Sheet 70  
Cancelling Original Sheet 70  
Effective: January 1, 1997

PINE ISLAND EXCHANGE

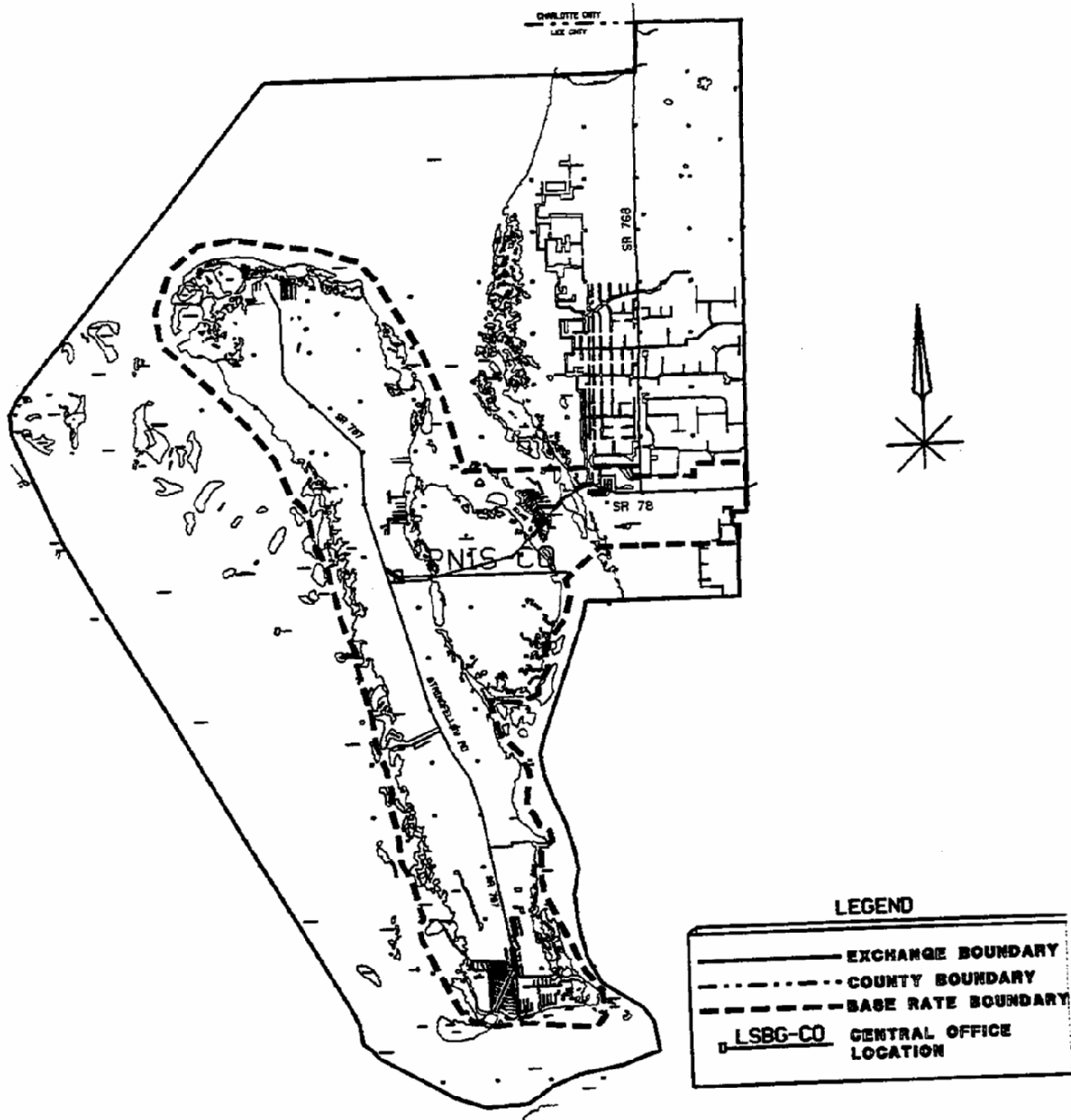

GENERAL EXCHANGE TARIFF

Embarq Florida, Inc.

By: F. B. Poag  
Director

Supplement Section 3  
First Revised Sheet 71  
Cancelling Original Sheet 71  
Effective: January 1, 1997

PONCE DE LEON EXCHANGE

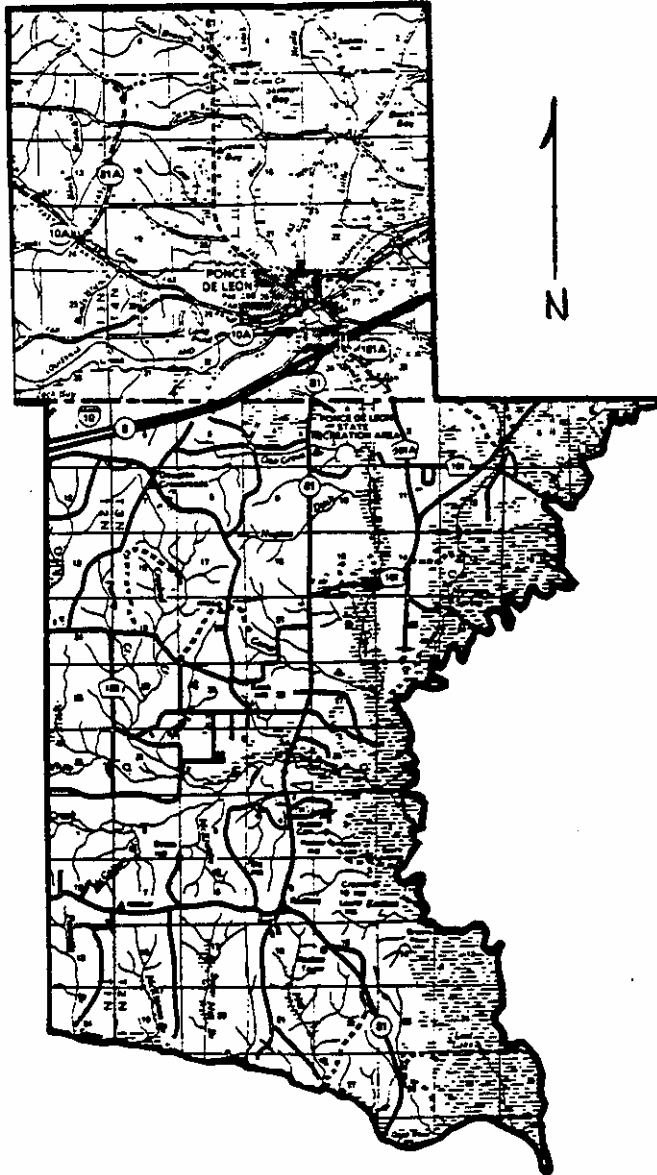

GENERAL EXCHANGE TARIFF

Embarq Florida, Inc.

By: F. B. Poag  
Director

Supplement Section 3  
First Revised Sheet 73  
Cancelling Original Sheet 73  
Effective: January 1, 1997

PUNTA GORDA EXCHANGE

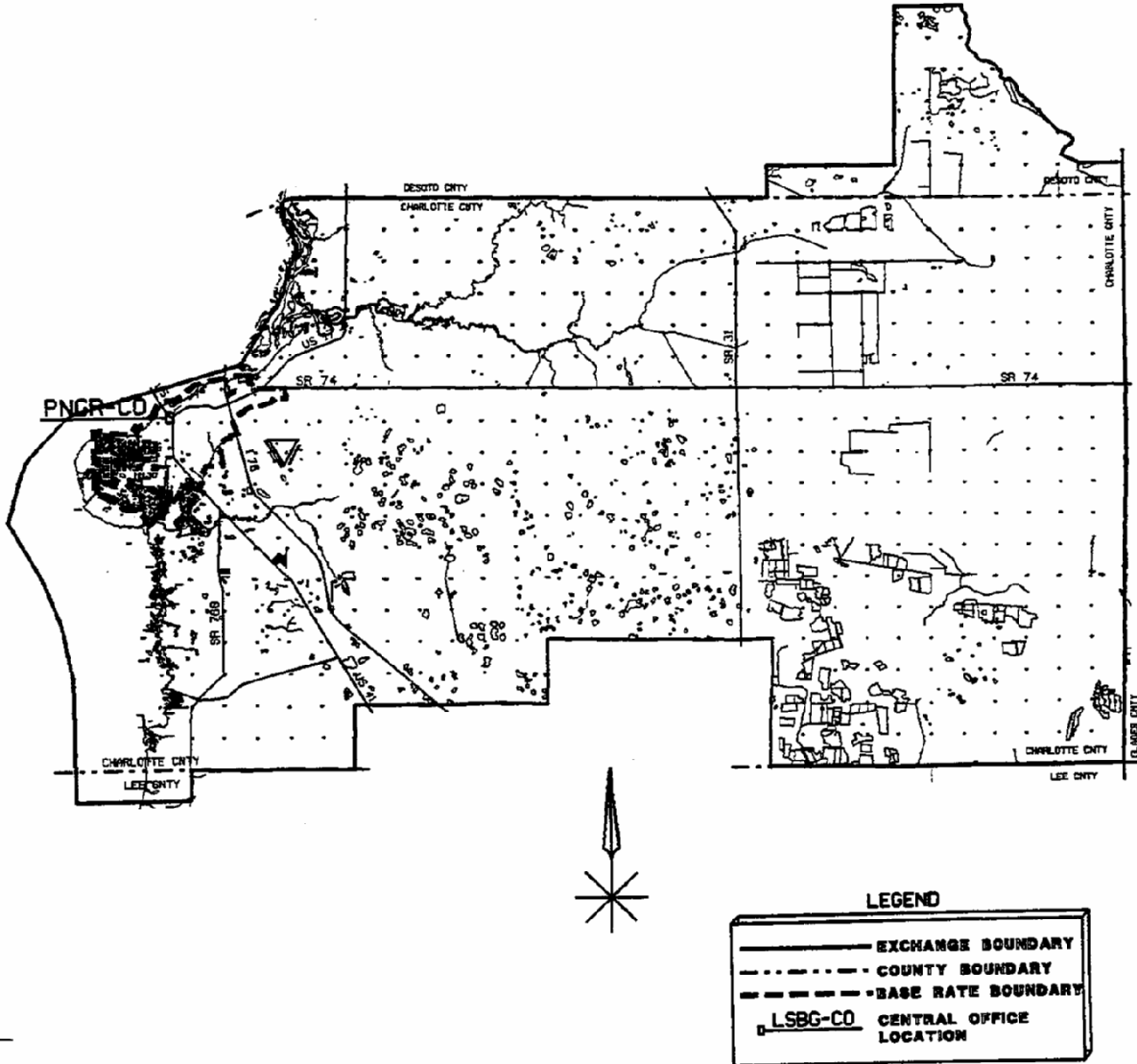

GENERAL EXCHANGE TARIFF

Embarq Florida, Inc.

By: F. B. Poag  
Director

Supplement Section 3  
First Revised Sheet 72  
Cancelling Original Sheet 72  
Effective: January 1, 1997

PORT CHARLOTTE EXCHANGE

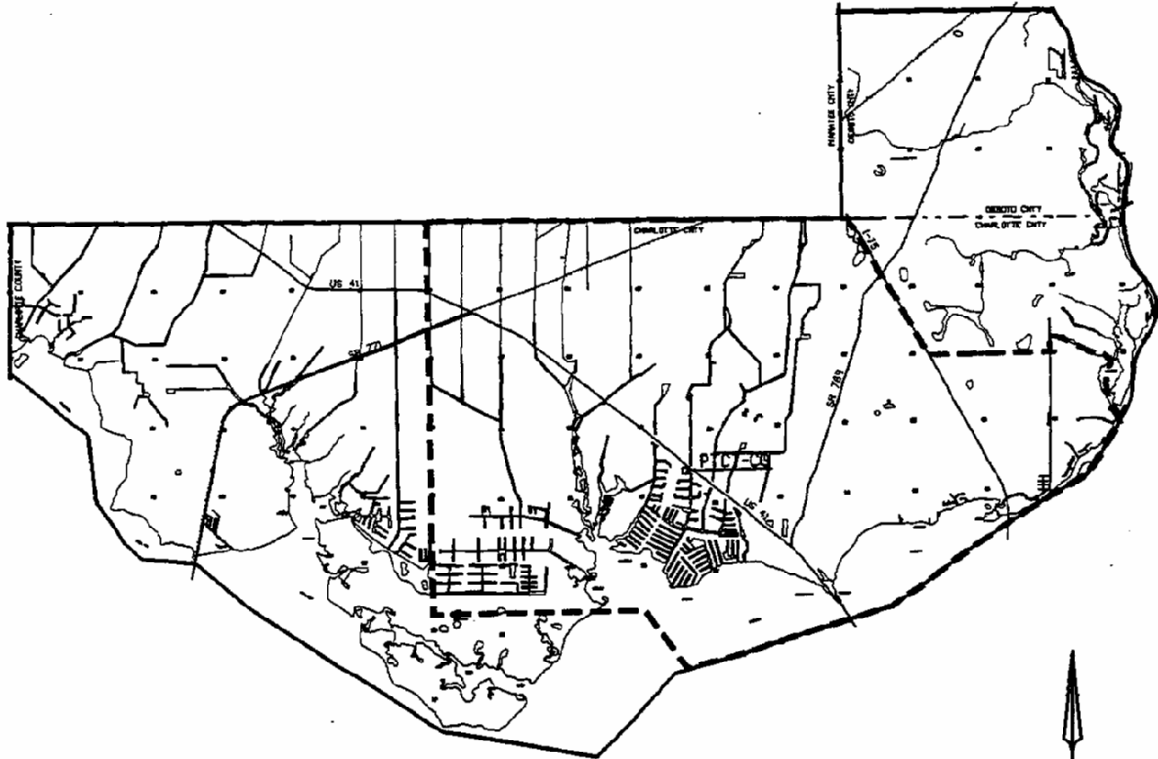

LEGEND

	EXCHANGE BOUNDARY
	COUNTY BOUNDARY
	BASE RATE BOUNDARY
	CENTRAL OFFICE LOCATION

GENERAL EXCHANGE TARIFF

Embarq Florida, Inc.

By: F. B. Poag  
Director

Supplement Section 3  
Second Revised Sheet 74  
Cancelling First Revised Sheet 74  
Effective: June 6, 2001

REEDY CREEK EXCHANGE

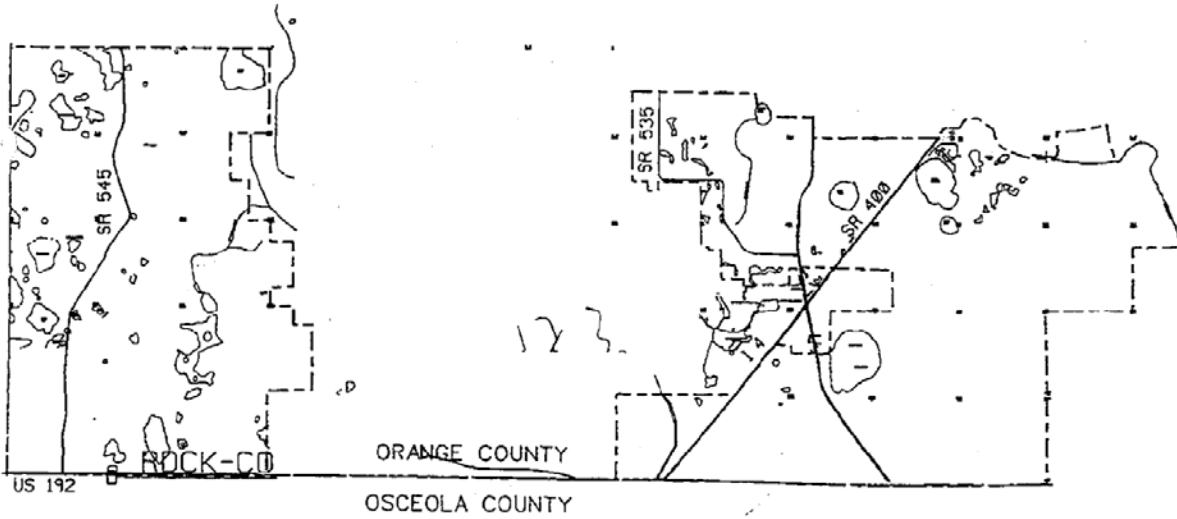

LEGEND

	EXCHANGE BOUNDARY
	COUNTY BOUNDARY
	CENTRAL OFFICE LOCATION

GENERAL EXCHANGE TARIFF

Embarq Florida, Inc.

By: F. B. Poag  
Director

Supplement Section 3  
First Revised Sheet 75  
Cancelling Original Sheet 75  
Effective: January 1, 1997

REYNOLDS HILL EXCHANGE

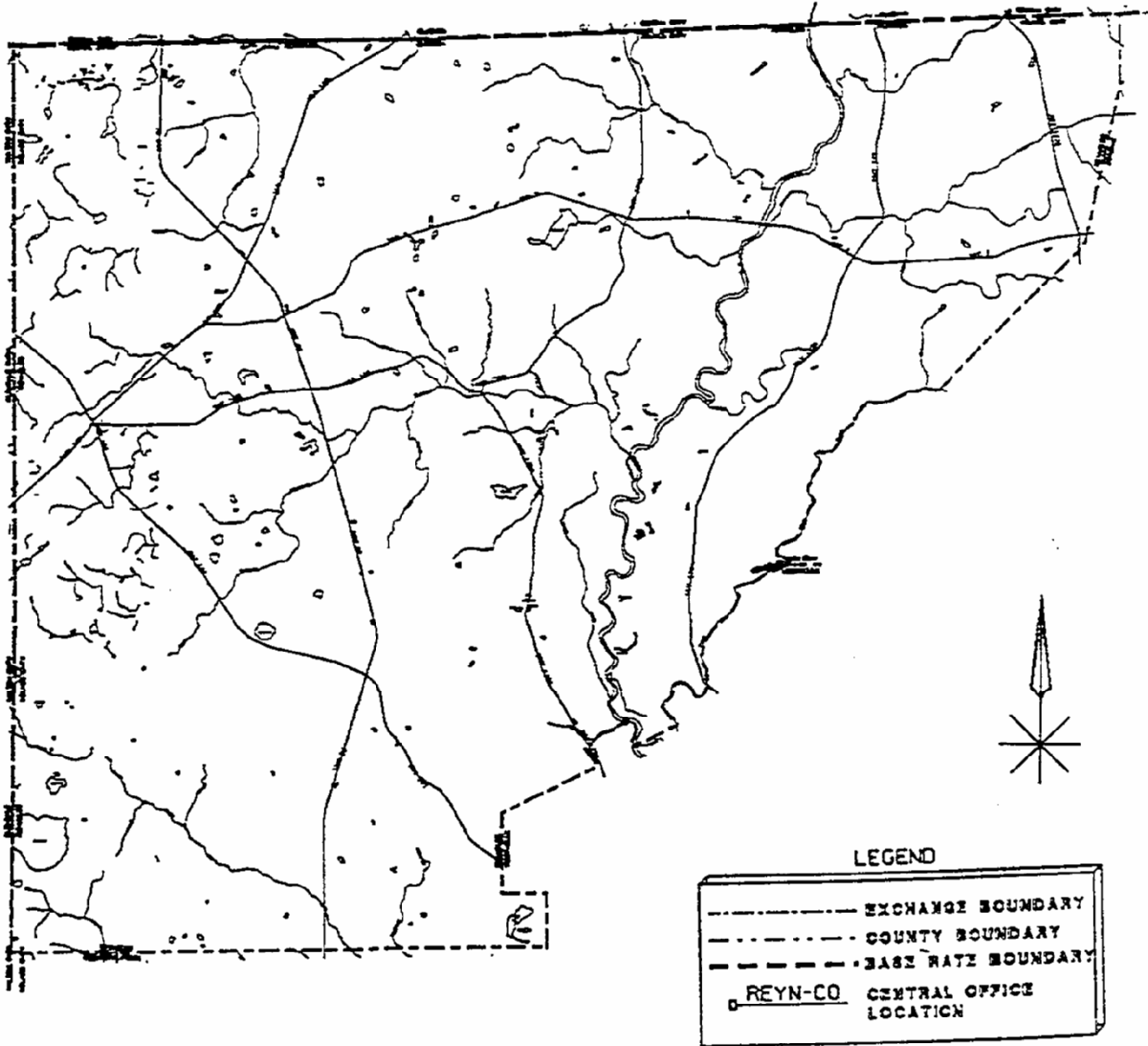

GENERAL EXCHANGE TARIFF

Embarq Florida, Inc.

By: F. B. Poag  
Director

Supplement Section 3  
First Revised Sheet 76  
Cancelling Original Sheet 76  
Effective: January 1, 1997

SAINT CLOUD EXCHANGE

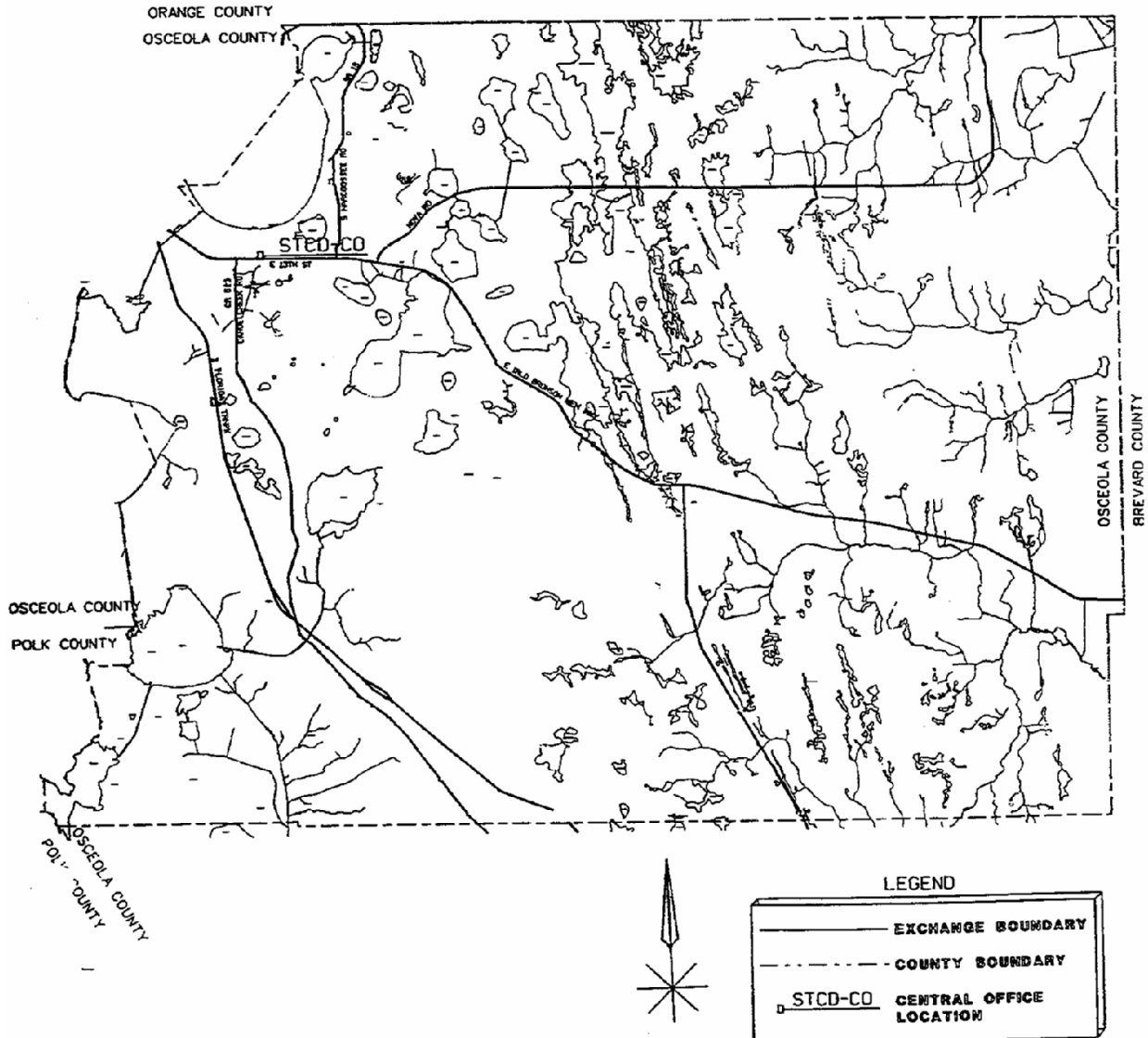



GENERAL EXCHANGE TARIFF

Embarq Florida, Inc.

By: F. B. Poag  
Director

Supplement Section 3  
First Revised Sheet 77  
Cancelling Original Sheet 77  
Effective: January 1, 1997

SAINT MARKS EXCHANGE

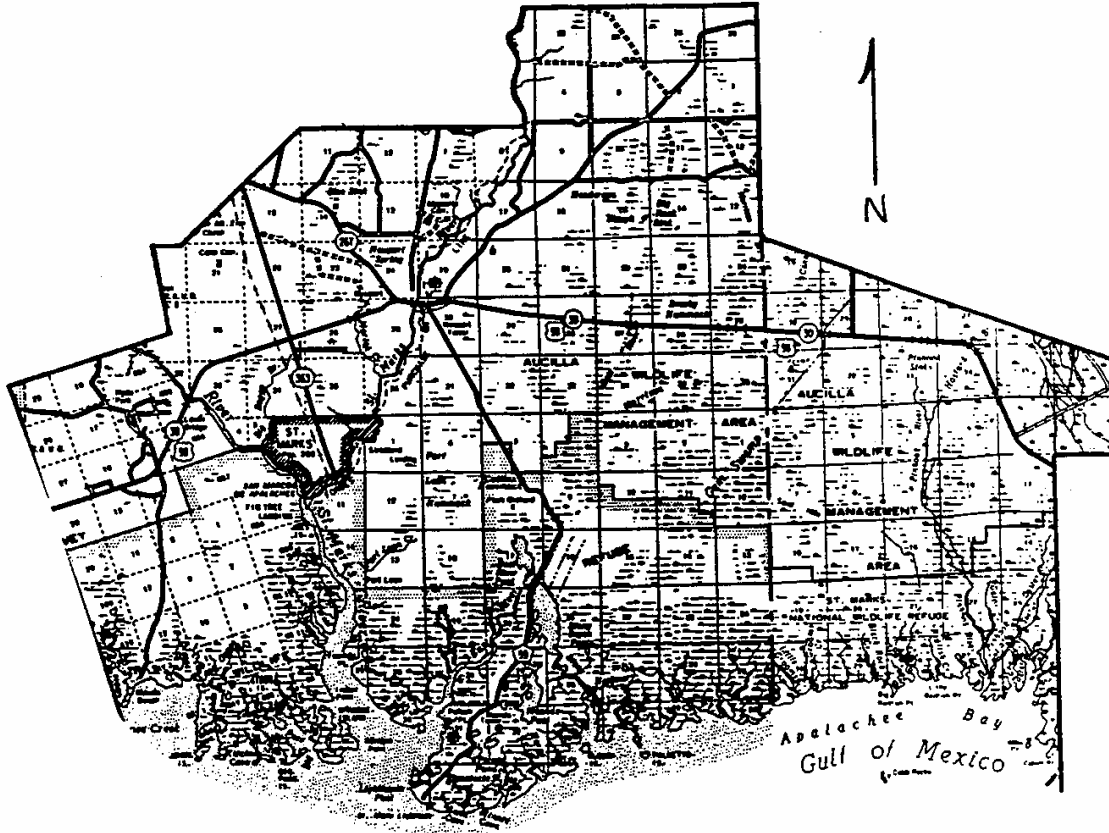

GENERAL EXCHANGE TARIFF

Embarq Florida, Inc.

By: F. B. Poag  
Director

Supplement Section 3  
First Revised Sheet 78  
Cancelling Original Sheet 78  
Effective: January 1, 1997

SALT SPRINGS EXCHANGE

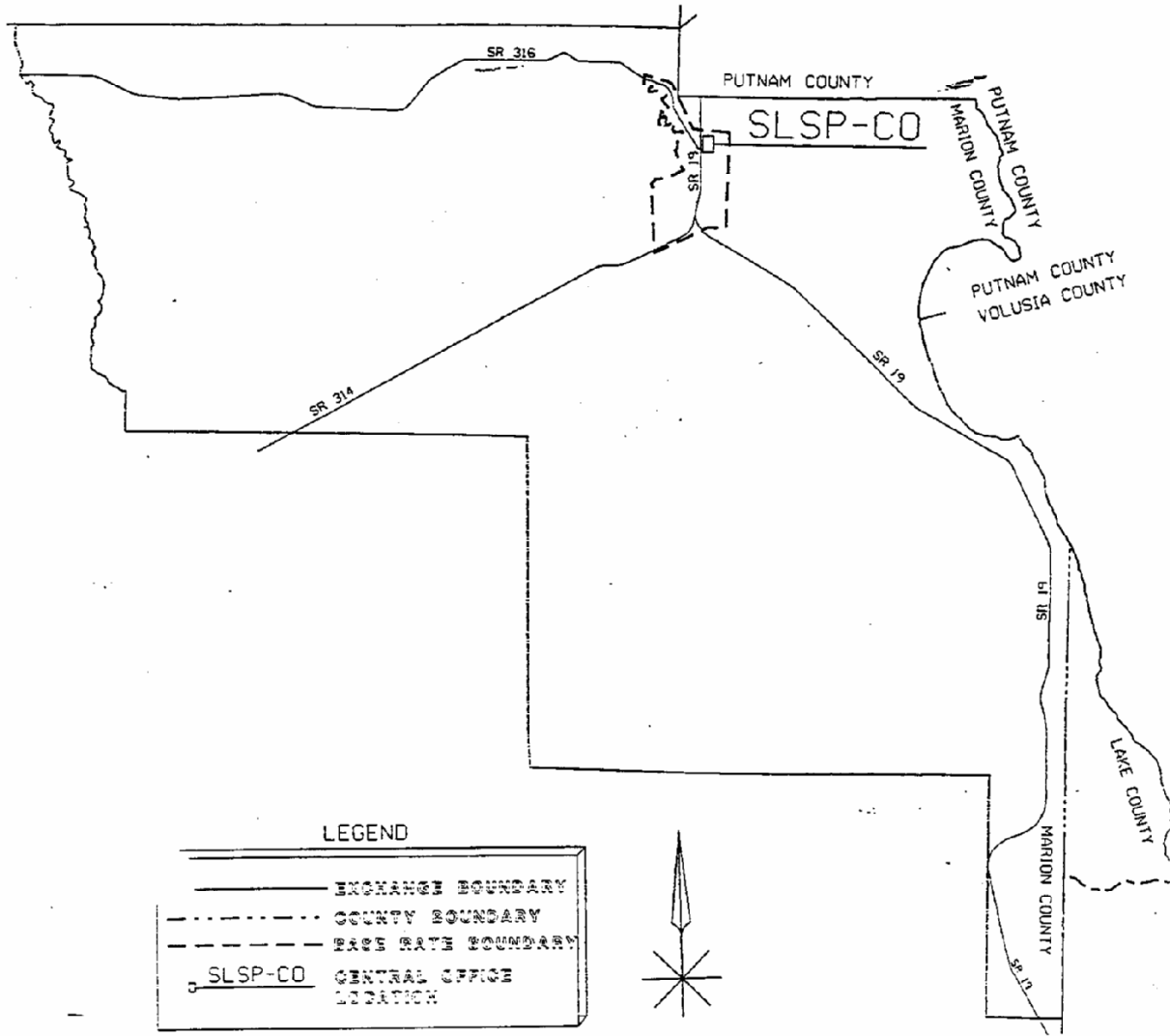

GENERAL EXCHANGE TARIFF

Embarq Florida, Inc.

By: F. B. Poag  
Director

Supplement Section 3  
Third Revised Sheet 79  
Cancelling Second Revised Sheet 79  
Effective: January 22, 2000

SAN ANTONIO EXCHANGE

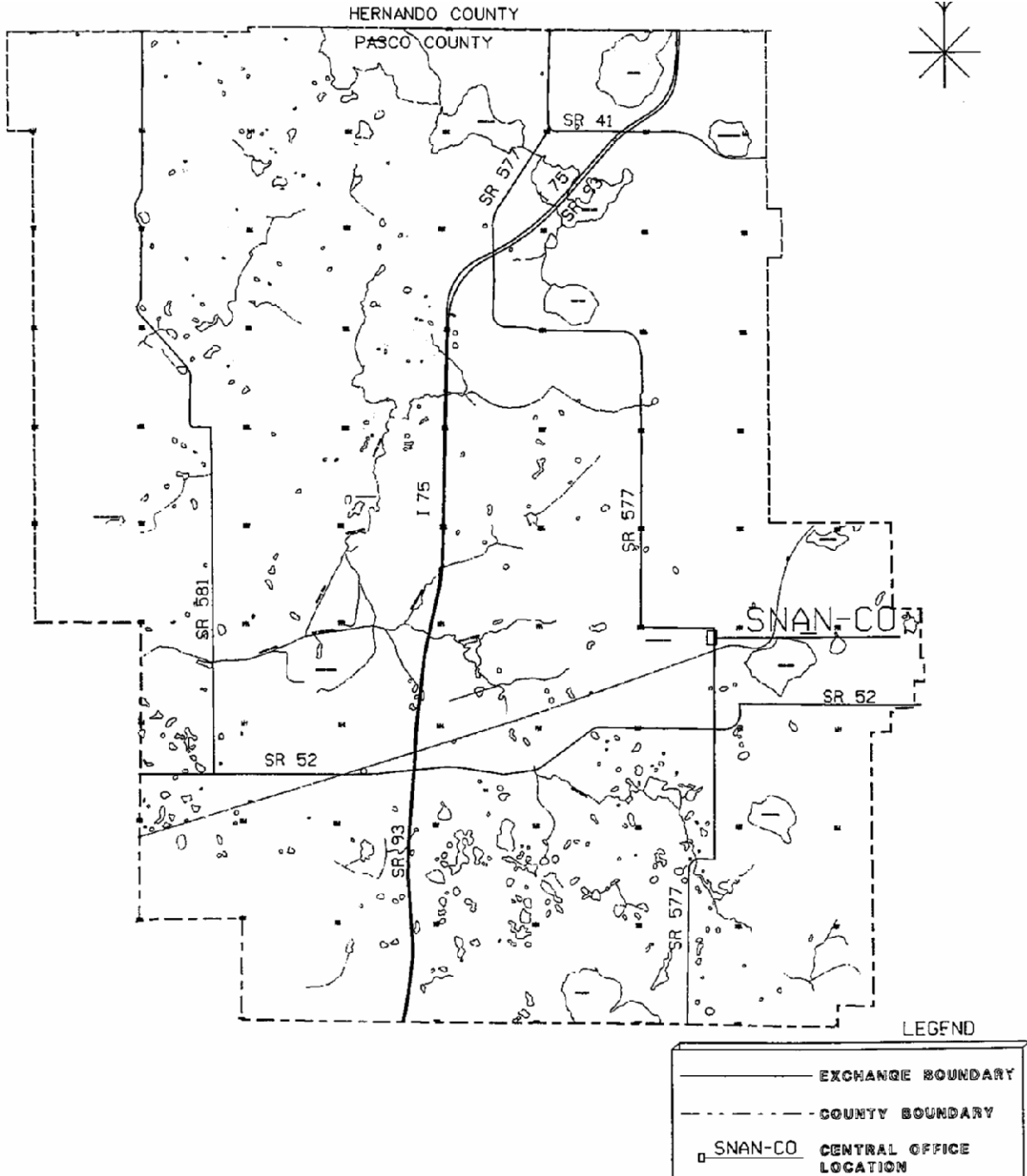

GENERAL EXCHANGE TARIFF

Embarq Florida, Inc.

By: F. B. Poag  
Director

Supplement Section 3  
First Revised Sheet 80  
Cancelling Original Sheet 80  
Effective: January 1, 1997

SANIBEL-CAPTIVA ISLANDS EXCHANGE

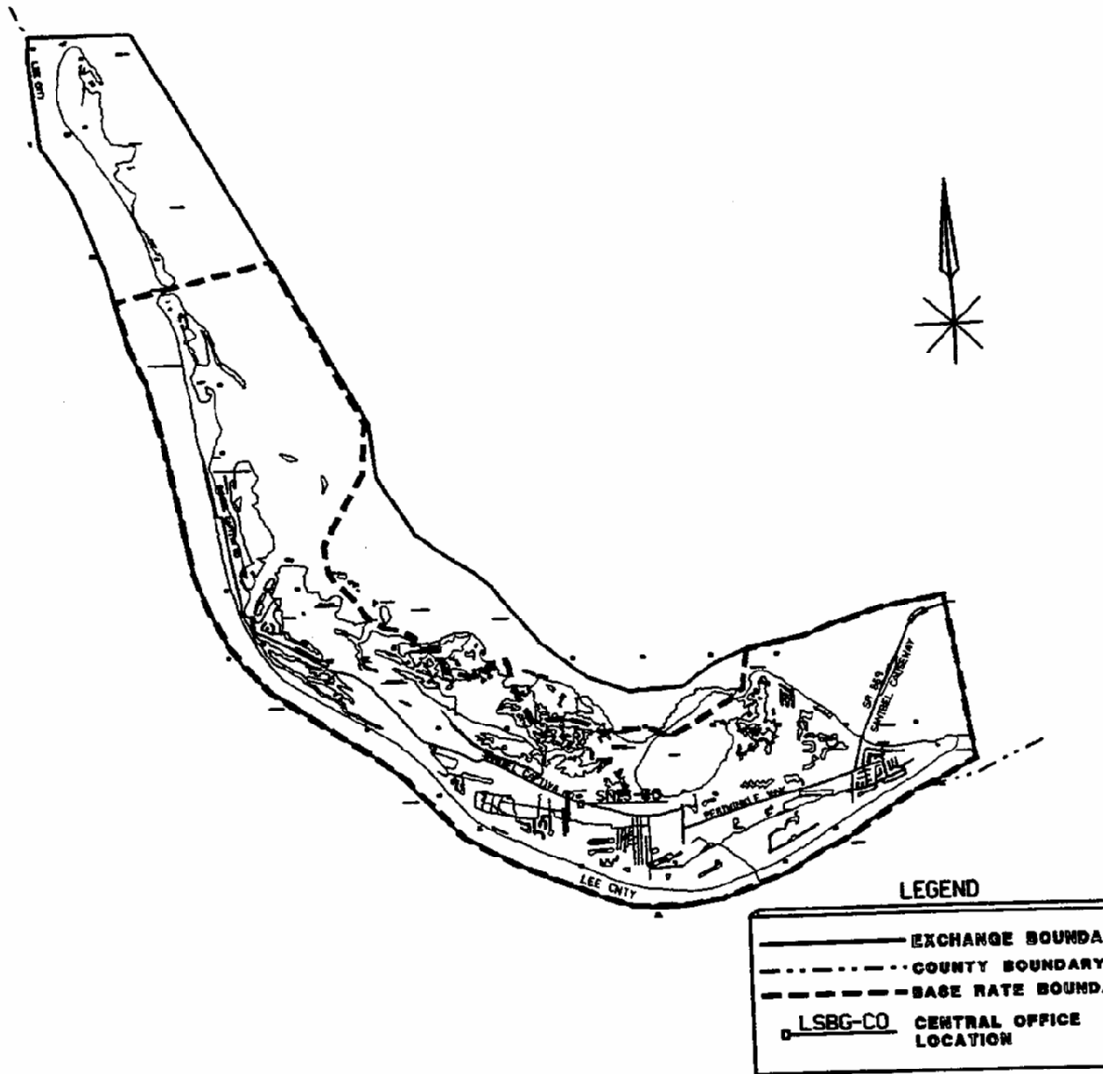

GENERAL EXCHANGE TARIFF

Embarq Florida, Inc.

BY: F. B. Poag  
Director

SUPPLEMENT SECTION A3  
Second Revised Sheet 81  
Cancelling First Revised Sheet 81  
EFFECTIVE: September 15, 2004

EXCHANGE SERVICE AREA MAP  
SANTA ROSA BEACH EXCHANGE

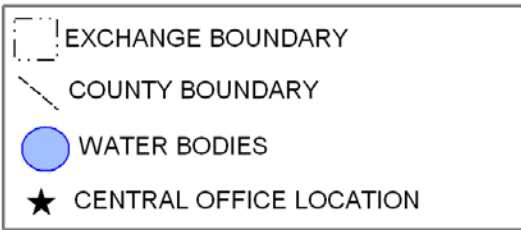

GENERAL EXCHANGE TARIFF

Embarq Florida, Inc.

By: F. B. Poag  
Director

Supplement Section 3  
First Revised Sheet 82  
Cancelling Original Sheet 82  
Effective: January 1, 1997

SEAGROVE BEACH EXCHANGE

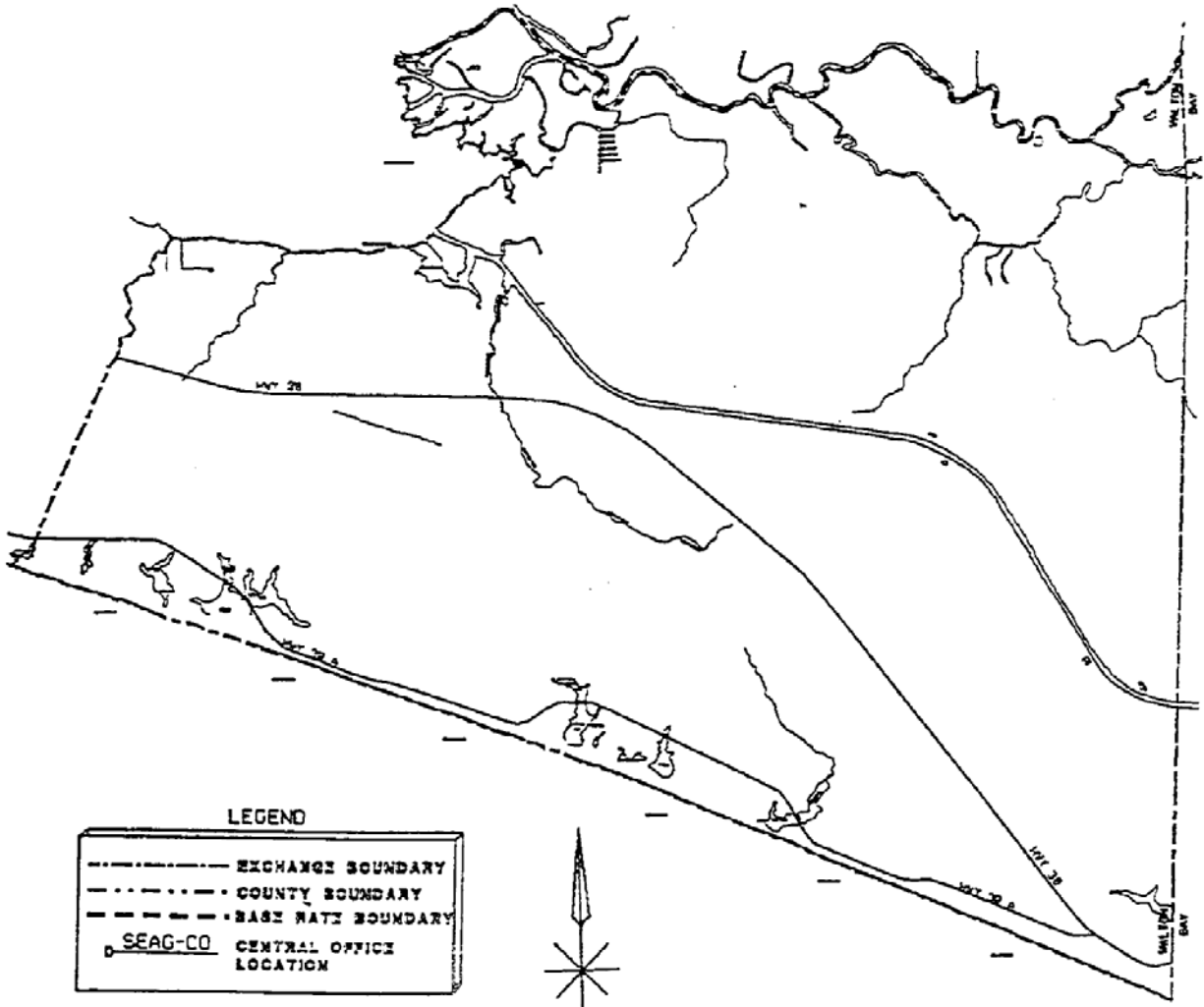

GENERAL EXCHANGE TARIFF

Embarq Florida, Inc.

By: F. B. Poag  
Director

Supplement Section 3  
First Revised Sheet 83  
Cancelling Original Sheet 83  
Effective: January 1, 1997

SEBRING EXCHANGE

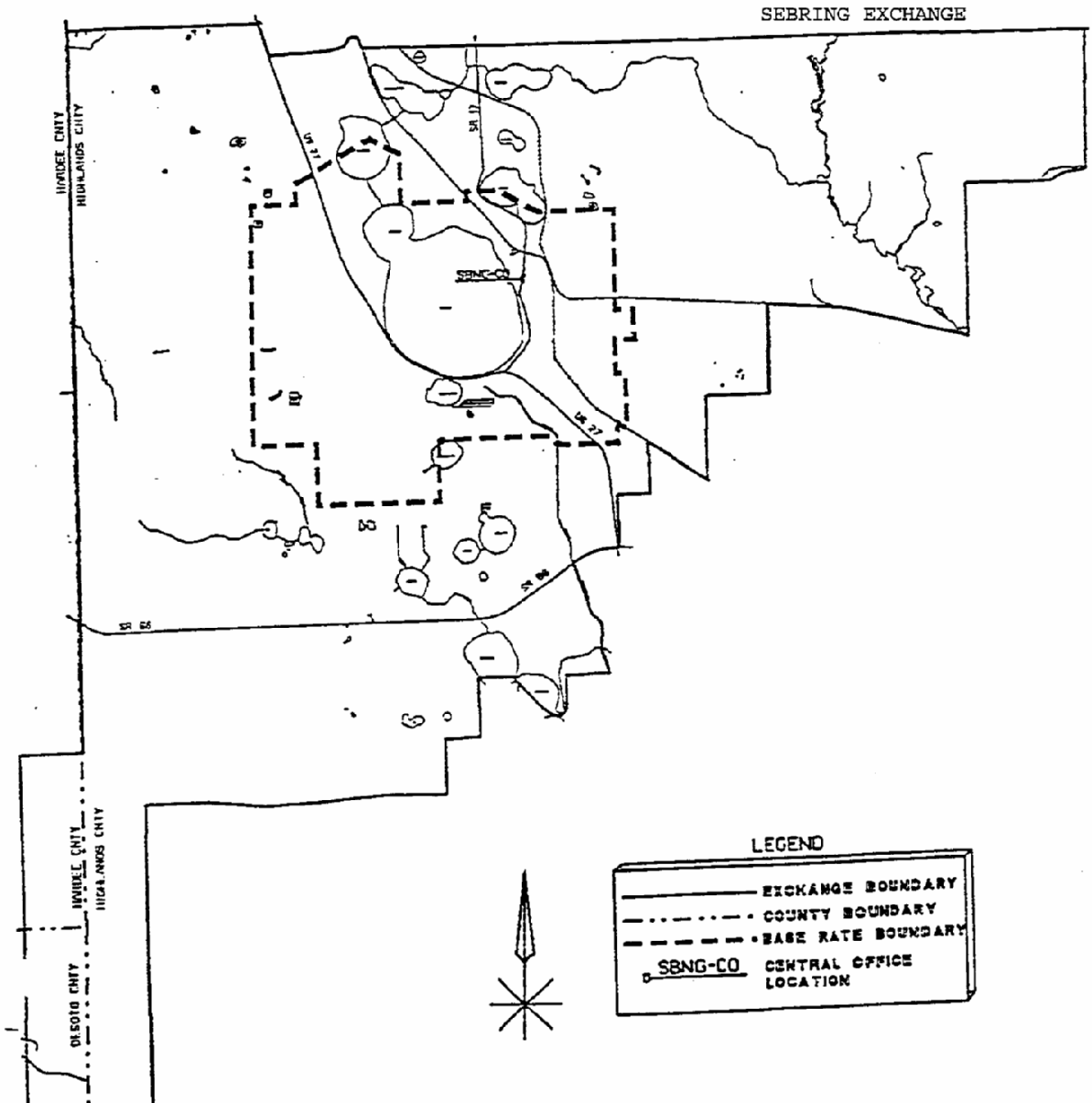

GENERAL EXCHANGE TARIFF

Embarq Florida, Inc.

By: F. B. Poag  
Director

Supplement Section 3  
First Revised Sheet 84  
Cancelling Original Sheet 84  
Effective: January 1, 1997

SHALIMAR EXCHANGE

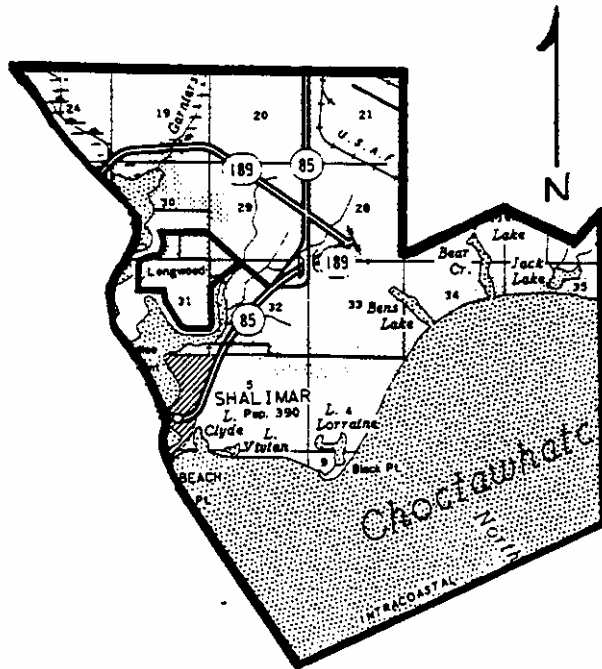



GENERAL EXCHANGE TARIFF

Embarq Florida, Inc.

By: F. B. Poag  
Director

Supplement Section 3  
First Revised Sheet 85  
Cancelling Original Sheet 85  
Effective: January 1, 1997

SILVER SPRINGS SHORES EXCHANGE

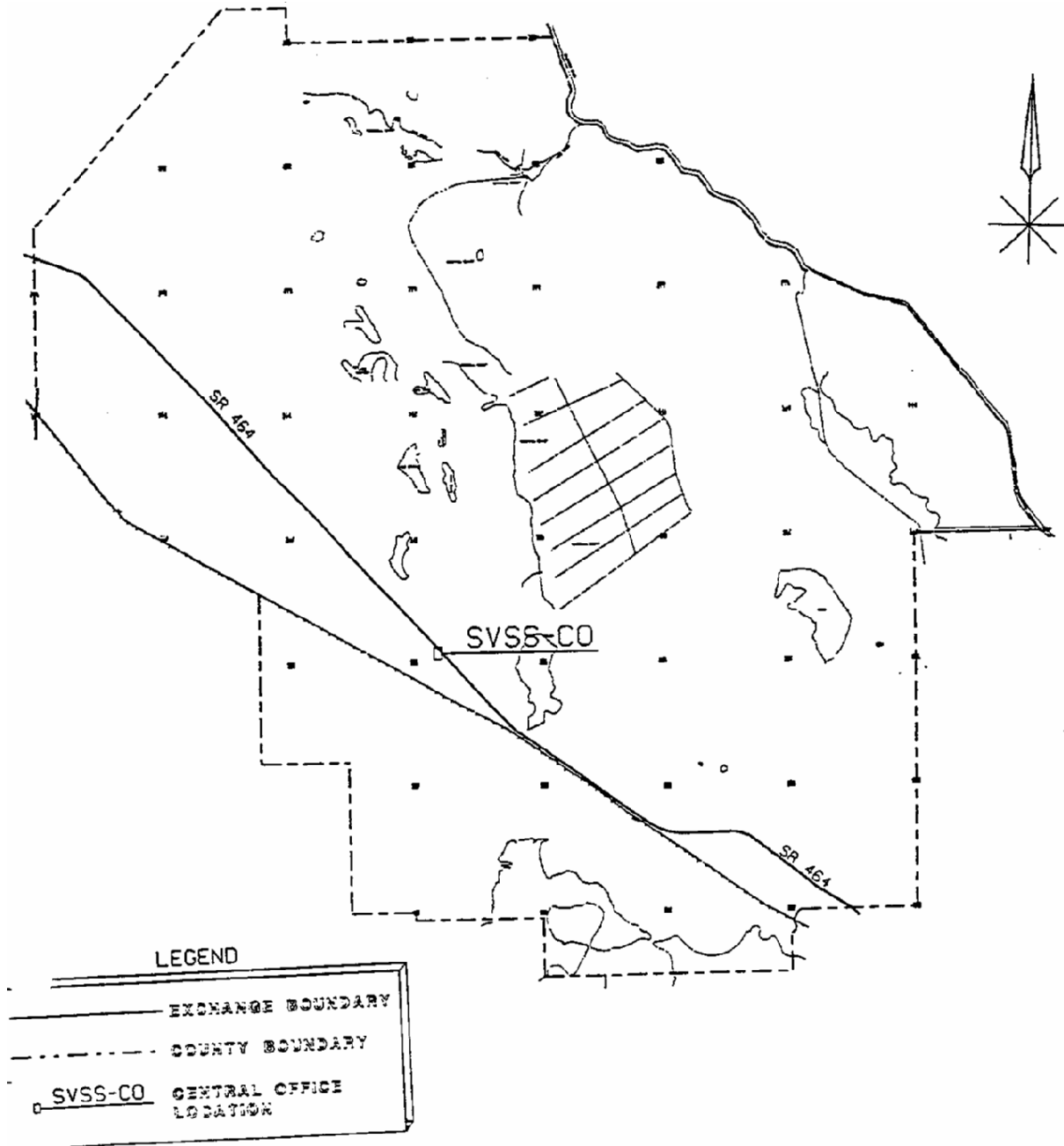

GENERAL EXCHANGE TARIFF

Embarq Florida, Inc.

By: F. B. Poag  
Director

Supplement Section 3  
First Revised Sheet 86  
Cancelling Original Sheet 86  
Effective: January 1, 1997

SNEADS EXCHANGE

EXCHANGE SERVICE AREA MAP

SNEADS EXCHANGE

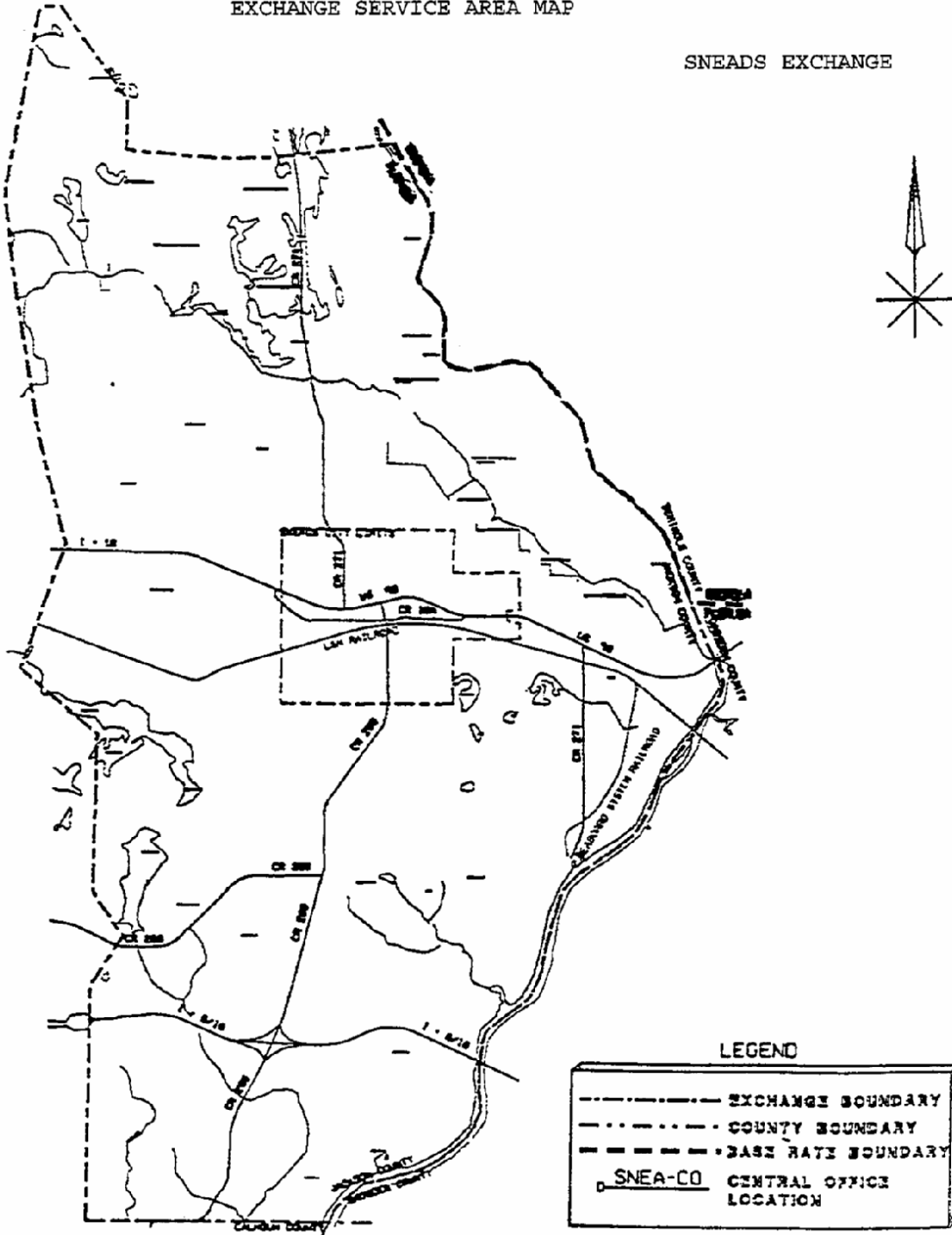

GENERAL EXCHANGE TARIFF

Embarq Florida, Inc.

By: F. B. Poag  
Director

Supplement Section 3  
First Revised Sheet 87  
Cancelling Original Sheet 87  
Effective: January 1, 1997

SOCHOPPY EXCHANGE

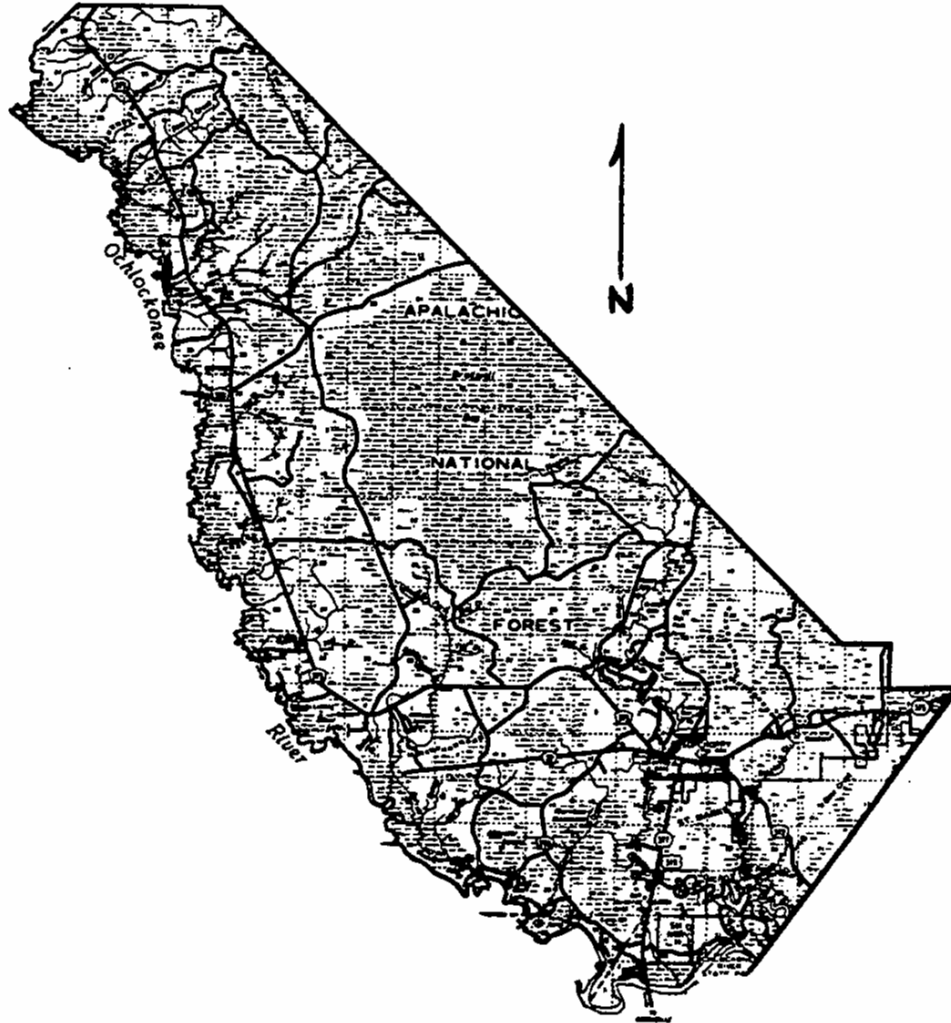

GENERAL EXCHANGE TARIFF

Embarq Florida, Inc.

By: F. B. Poag  
Director

Supplement Section 3  
First Revised Sheet 88  
Cancelling Original Sheet 88  
Effective: January 1, 1997

SPRING LAKE EXCHANGE

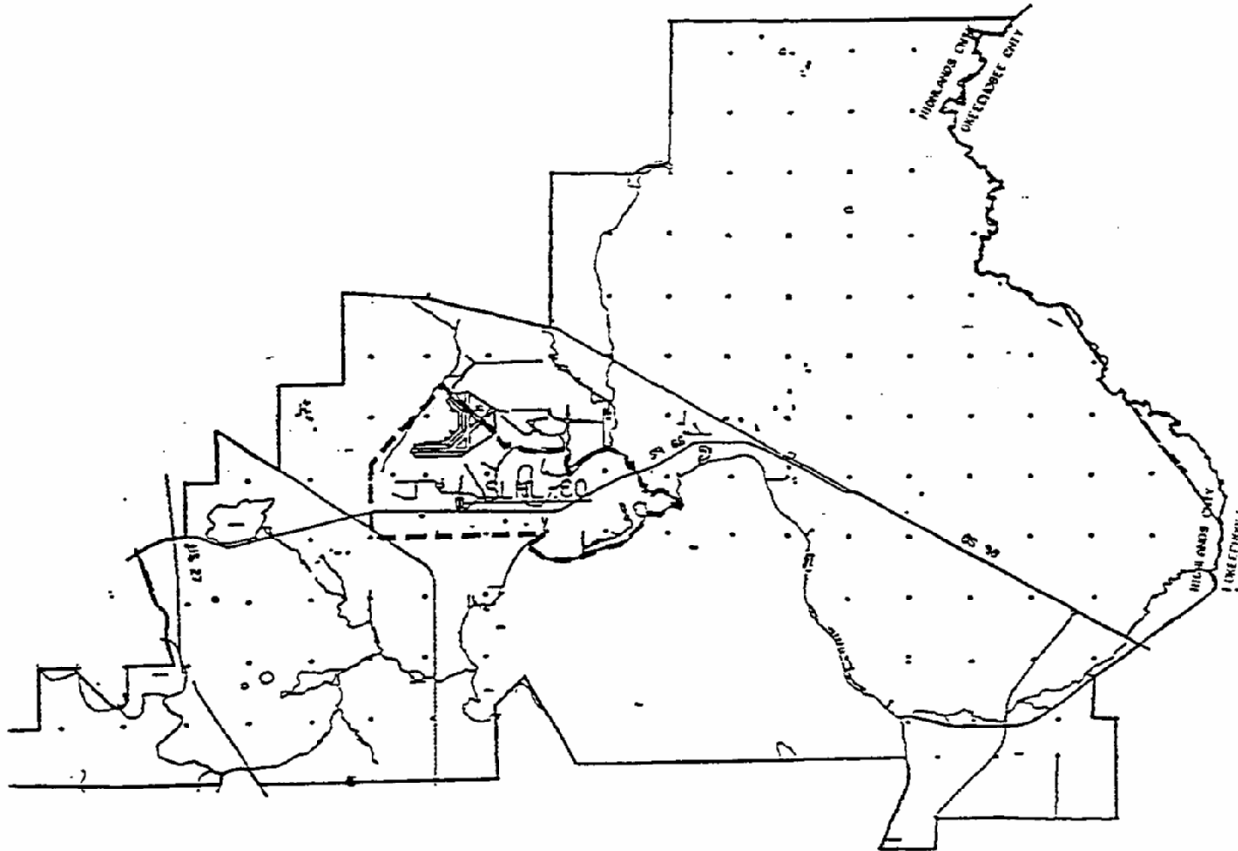

LEGEND

—	EXCHANGE BOUNDARY
- - - - -	COUNTY BOUNDARY
- · - · -	BASE RATE BOUNDARY
□ SLHL-CO	CENTRAL OFFICE LOCATION



GENERAL EXCHANGE TARIFF

Embarq Florida, Inc.

By: F. B. Poag  
Director

Supplement Section 3  
First Revised Sheet 89  
Cancelling Original Sheet 89  
Effective: January 1, 1997

STARK EXCHANGE

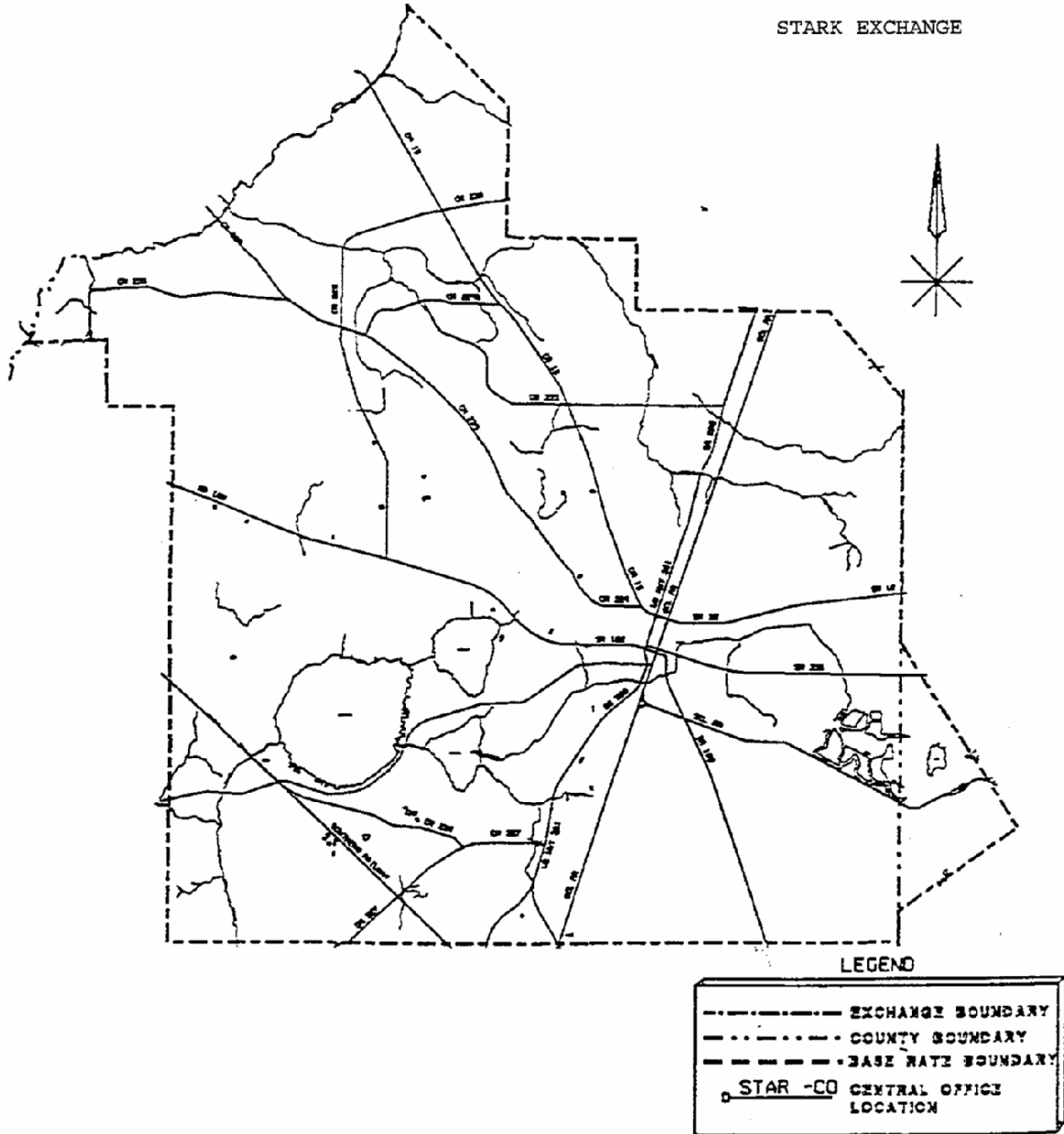

GENERAL EXCHANGE TARIFF

Embarq Florida, Inc.

By: F. B. Poag  
Director

Supplement Section 3  
First Revised Sheet 90  
Cancelling Original Sheet 90  
Effective: January 1, 1997

TALLAHASSEE EXCHANGE

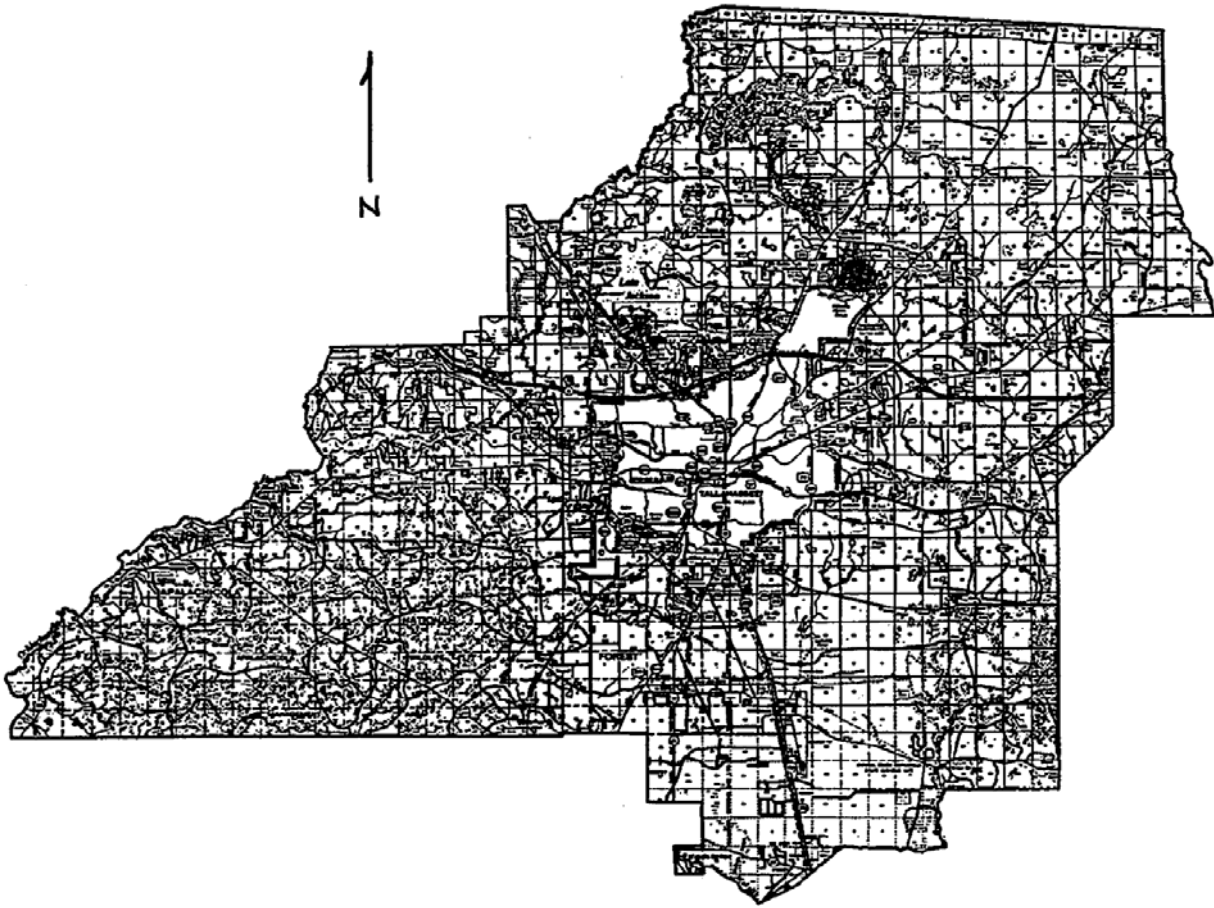

GENERAL EXCHANGE TARIFF

Embarq Florida, Inc.

SUPPLEMENT SECTION A3  
Second Revised Sheet 91  
Cancelling First Revised Sheet 91  
Effective: June 10, 2005

By: F. B. Poag  
Director

EXCHANGE SERVICE AREA MAP

TAVARES EXCHANGE

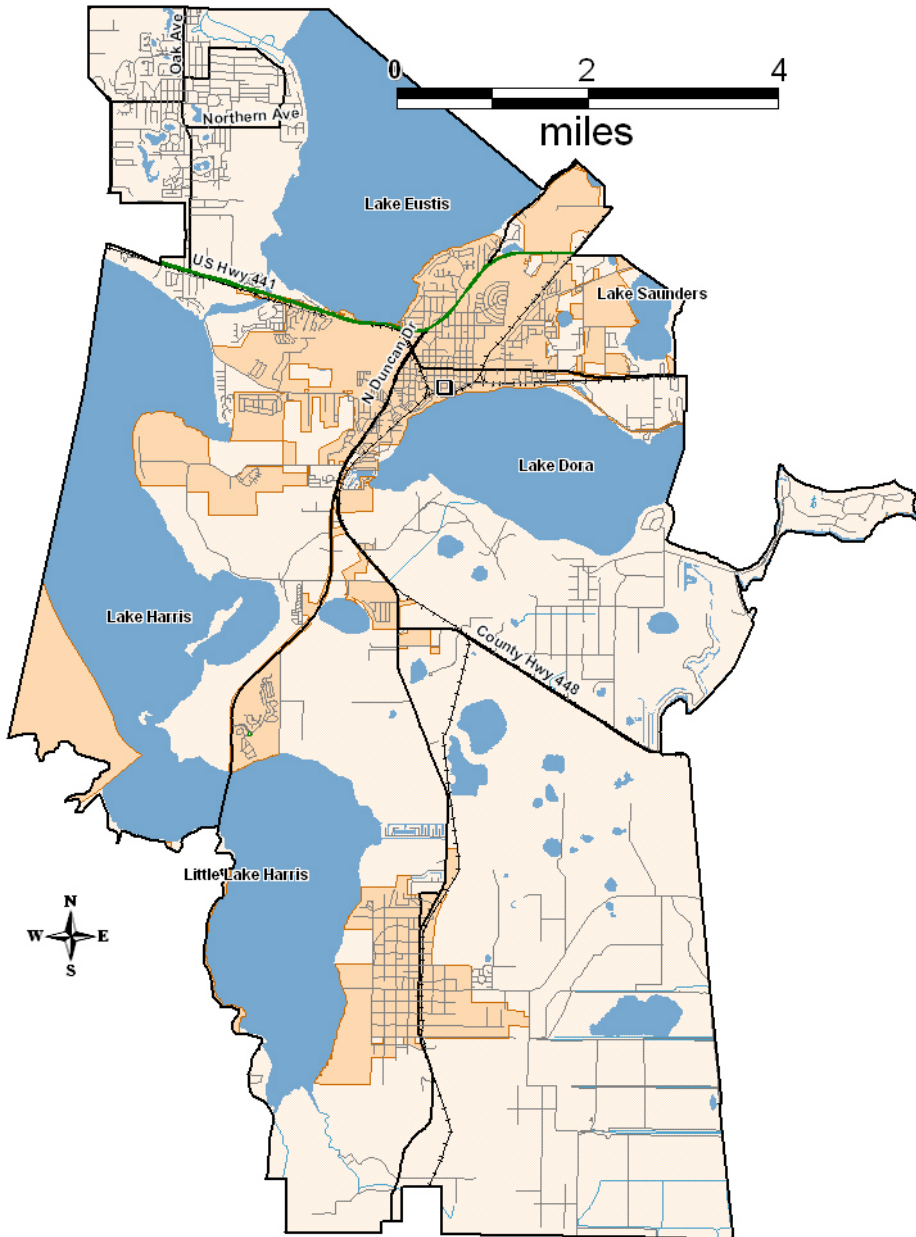

GENERAL EXCHANGE TARIFF

Embarq Florida, Inc.

By: F. B. Poag  
Director

Supplement Section 3  
Second Revised Sheet 92  
Cancelling First Revised Sheet 92  
Effective: April 26, 2000

TRILACOOCHEE EXCHANGE

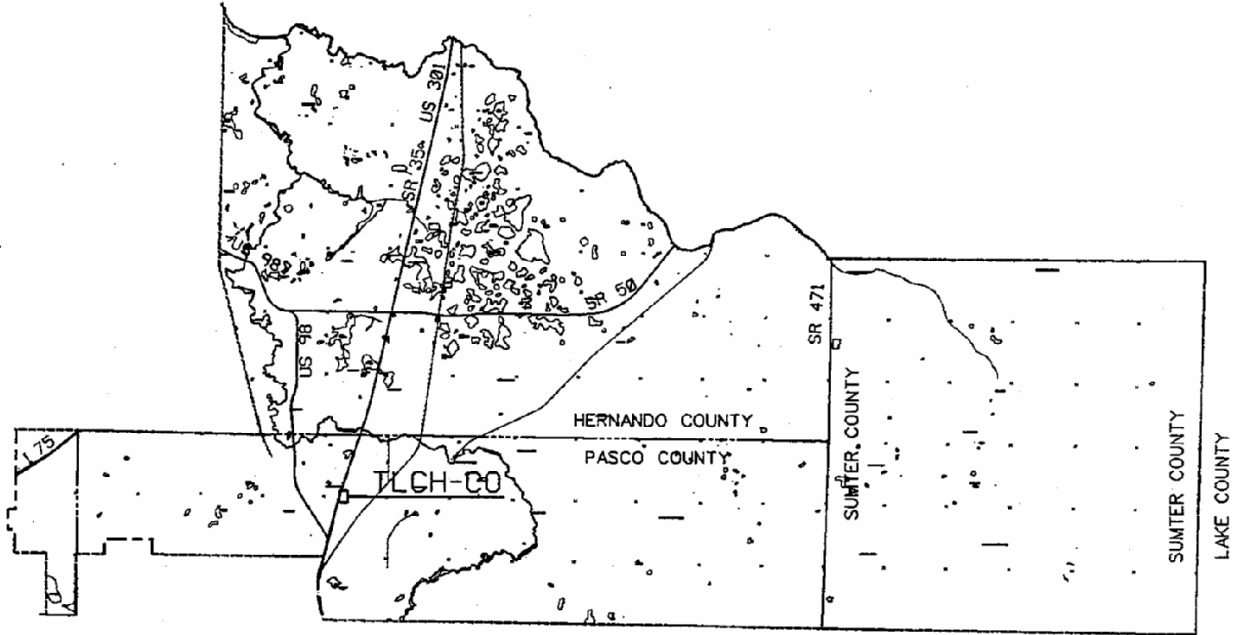

LEGEND

	EXCHANGE BOUNDARY
	COUNTY BOUNDARY
	CENTRAL OFFICE LOCATION



GENERAL EXCHANGE TARIFF

Embarq Florida, Inc.

By: F. B. Poag  
Director

Supplement Section 3  
First Revised Sheet 93  
Cancelling Original Sheet 93  
Effective: January 1, 1997

UMATILLA EXCHANGE

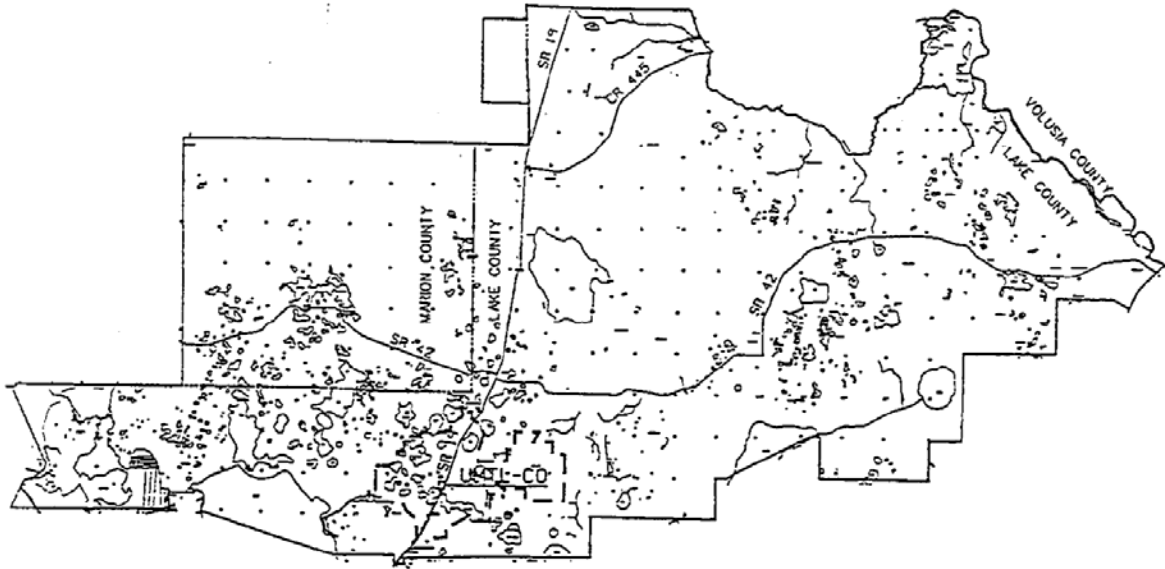

LEGEND

	EXCHANGE BOUNDARY
	COUNTY BOUNDARY
	BASE RATE BOUNDARY
	CENTRAL OFFICE LOCATION

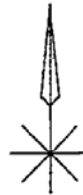

GENERAL EXCHANGE TARIFF

Embarq Florida, Inc.

By: F. B. Poag  
Director

Supplement Section 3  
First Revised Sheet 94  
Cancelling Original Sheet 94  
Effective: January 1, 1997

VALPARAISO EXCHANGE

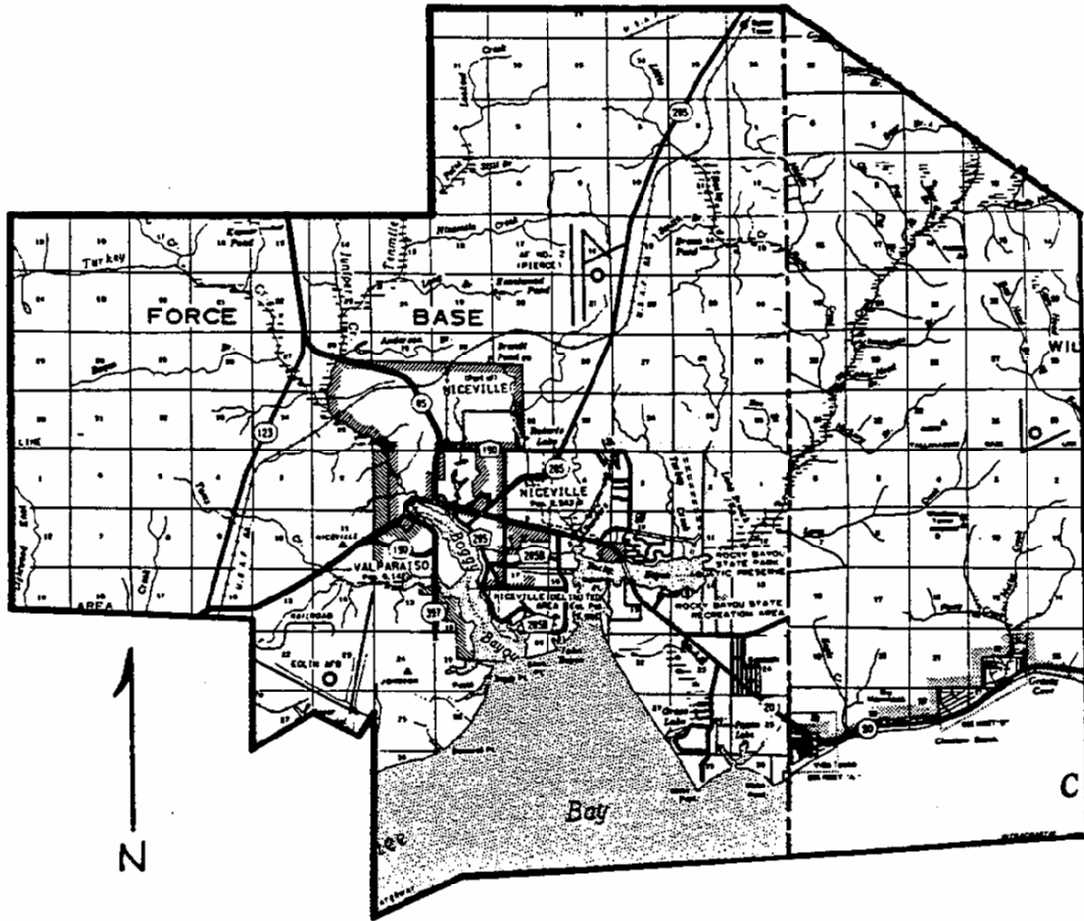

GENERAL EXCHANGE TARIFF

Embarq Florida, Inc.

By: F. B. Poag  
Director

Supplement Section 3  
First Revised Sheet 95  
Cancelling Original Sheet 95  
Effective: January 1, 1997

WACHULA EXCHANGE

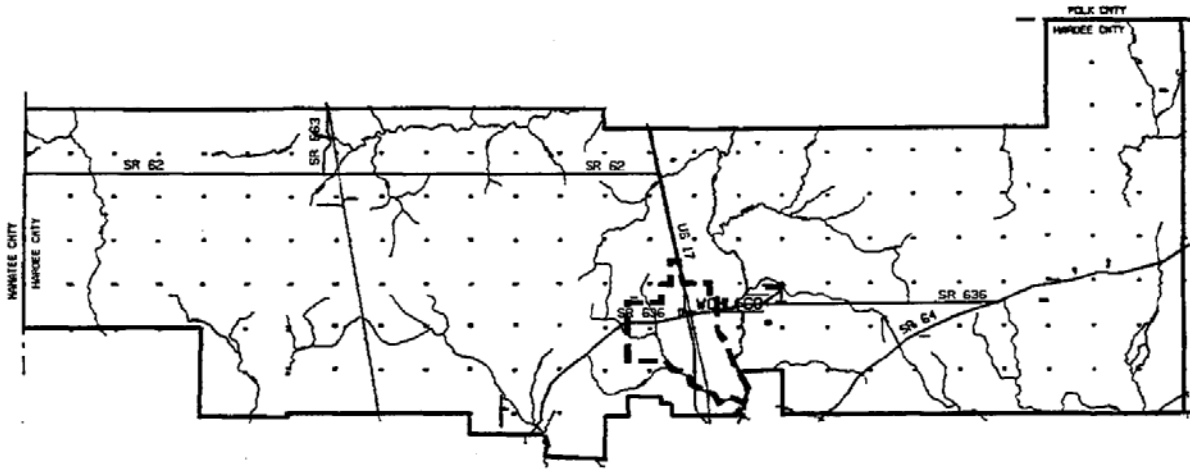

LEGEND	
—	EXCHANGE BOUNDARY
- - - - -	COUNTY BOUNDARY
- · - · - ·	BASE RATE BOUNDARY
■	LSBG-CO CENTRAL OFFICE LOCATION

GENERAL EXCHANGE TARIFF

Embarq Florida, Inc.



By: F. B. Poag  
Director

Supplement Section 3  
Second Revised Sheet 95.2  
Cancelling First Revised Sheet 95.2  
Effective: January 1, 2003

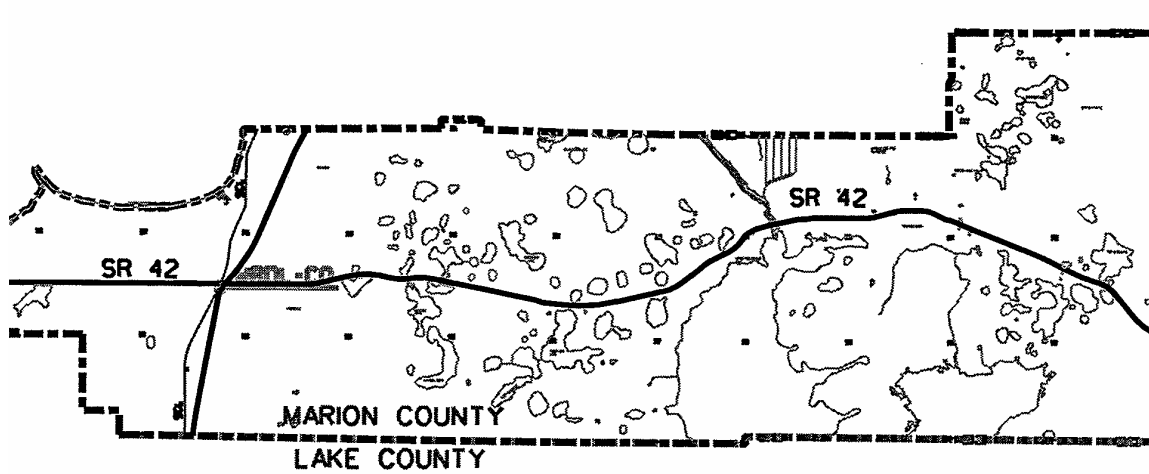
WEIRSDALE EXCHANGE



**LEGEND**

	<b>EXCHANGE BOUNDARY</b>
	<b>COUNTY BOUNDARY</b>
	<b>CENTRAL OFFICE LOCATION</b>

GENERAL EXCHANGE TARIFF

Embarq Florida, Inc.



By: F. B. Poag  
Director

Supplement Section 3  
Fourth Revised Sheet 96  
Cancelling Third Revised Sheet 96  
Effective: November 12, 2003

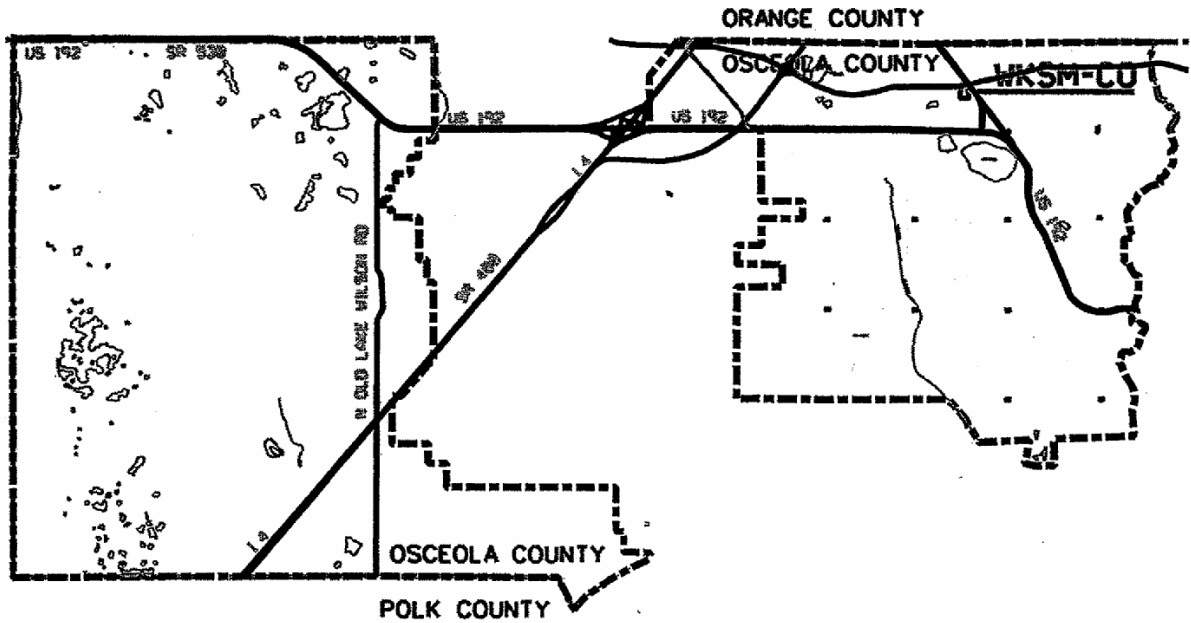
WEST KISSIMMEE EXCHANGE



LEGEND

	EXCHANGE BOUNDARY
	COUNTY BOUNDARY
	CENTRAL OFFICE LOCATION

GENERAL EXCHANGE TARIFF

Embarq Florida, Inc.

By: F. B. Poag  
Director

Supplement Section 3  
First Revised Sheet 97  
Cancelling Original Sheet 97  
Effective: January 1, 1997

WESTVILLE EXCHANGE

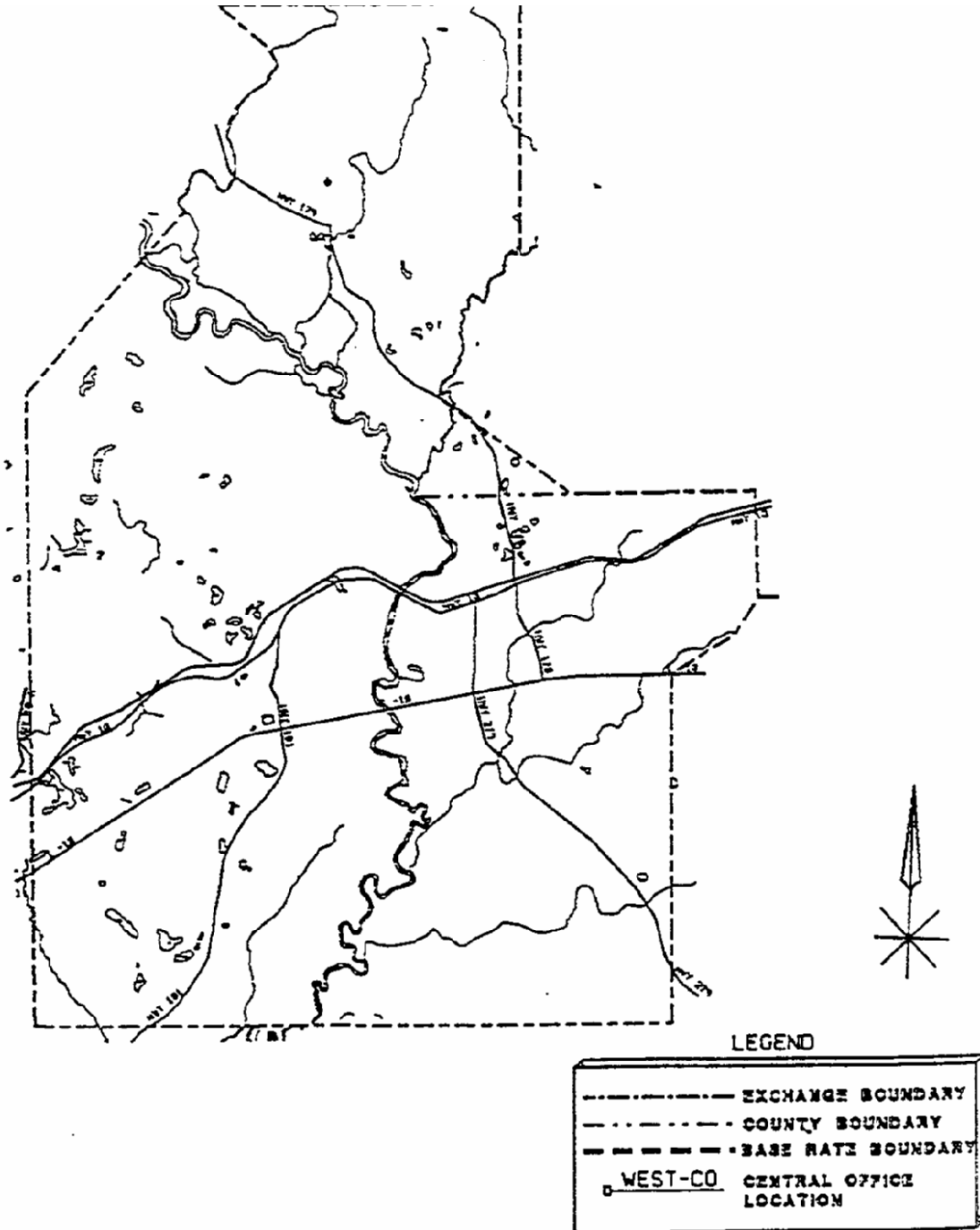

GENERAL EXCHANGE TARIFF

Embarq Florida, Inc.

By: F. B. Poag  
Director

Supplement Section 3  
Third Revised Sheet 98  
Cancelling Second Revised Sheet 98  
Effective: August 8, 2003

WILDWOOD EXCHANGE

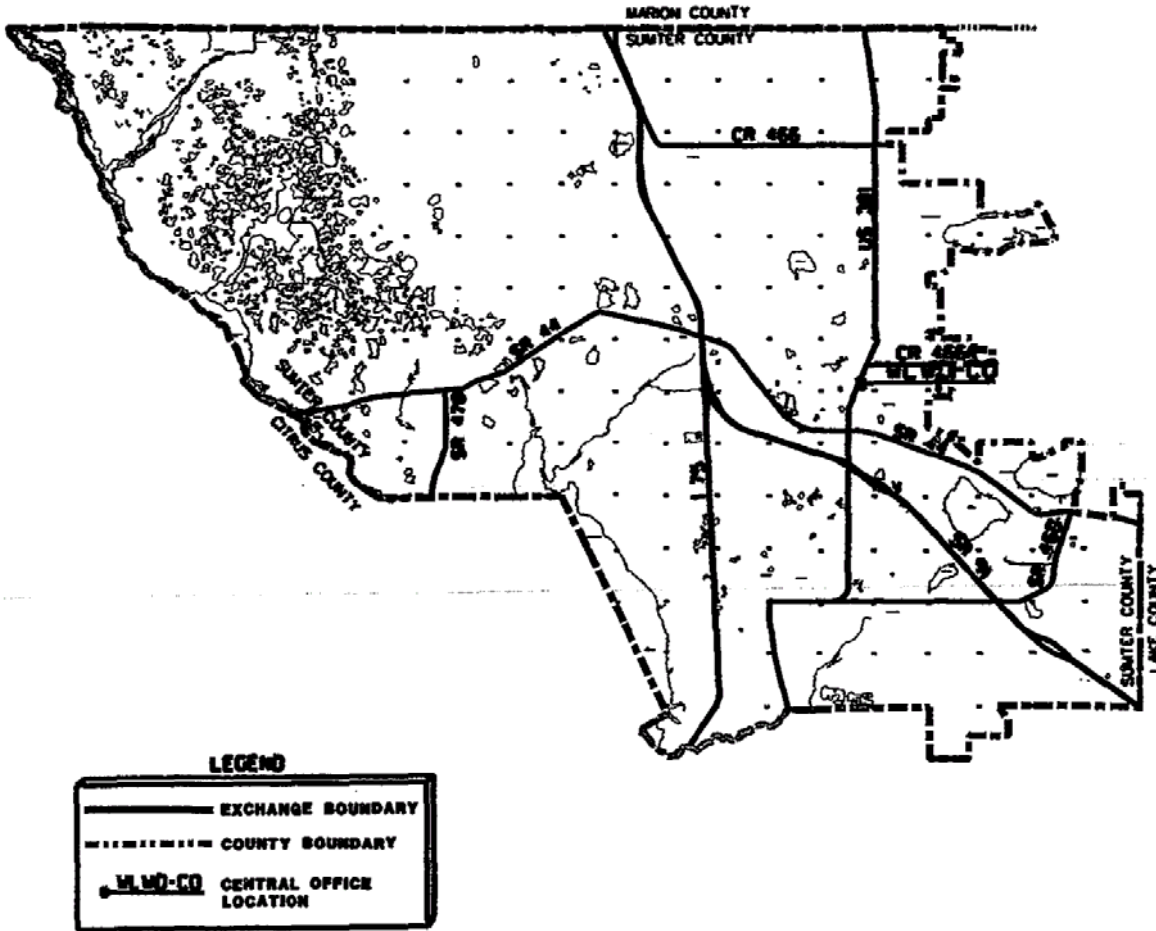

GENERAL EXCHANGE TARIFF

Embarq Florida, Inc.

By: F. B. Poag  
Director

Supplement Section 3  
First Revised Sheet 99  
Cancelling Original Sheet 99  
Effective: January 1, 1997

WILLISTON SPRINGS EXCHANGE

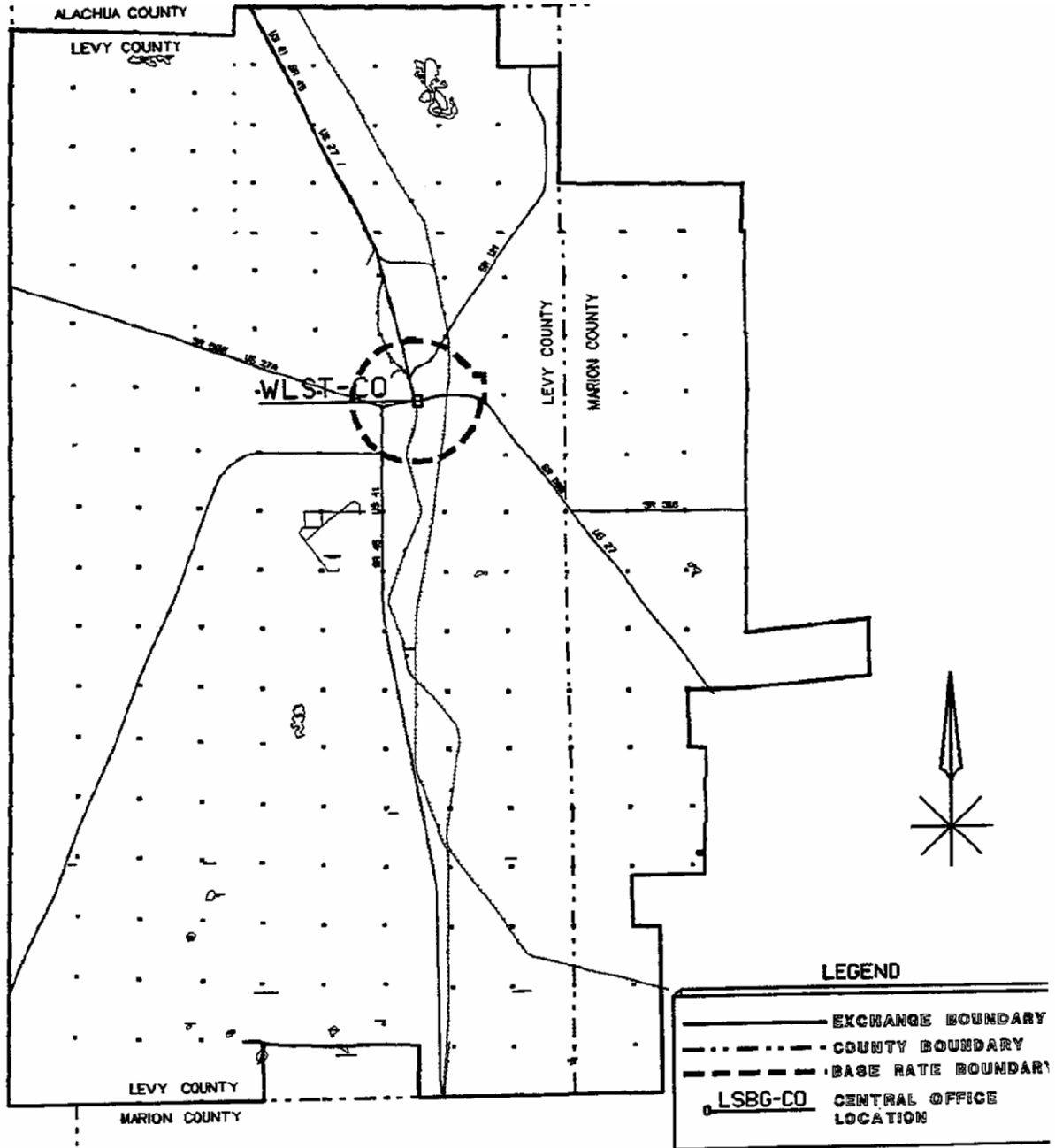



GENERAL EXCHANGE TARIFF

Embarq Florida, Inc.

SUPPLEMENT SECTION A3  
Ninth Revised Sheet 100  
Cancelling Eighth Revised Sheet 100  
Effective April 4, 2005

By: F. B. Poag  
Director

EXCHANGE SERVICE AREA MAP

WINDERMERE

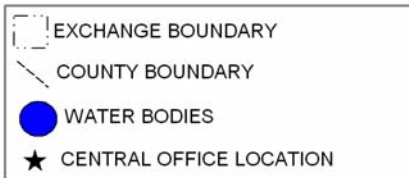
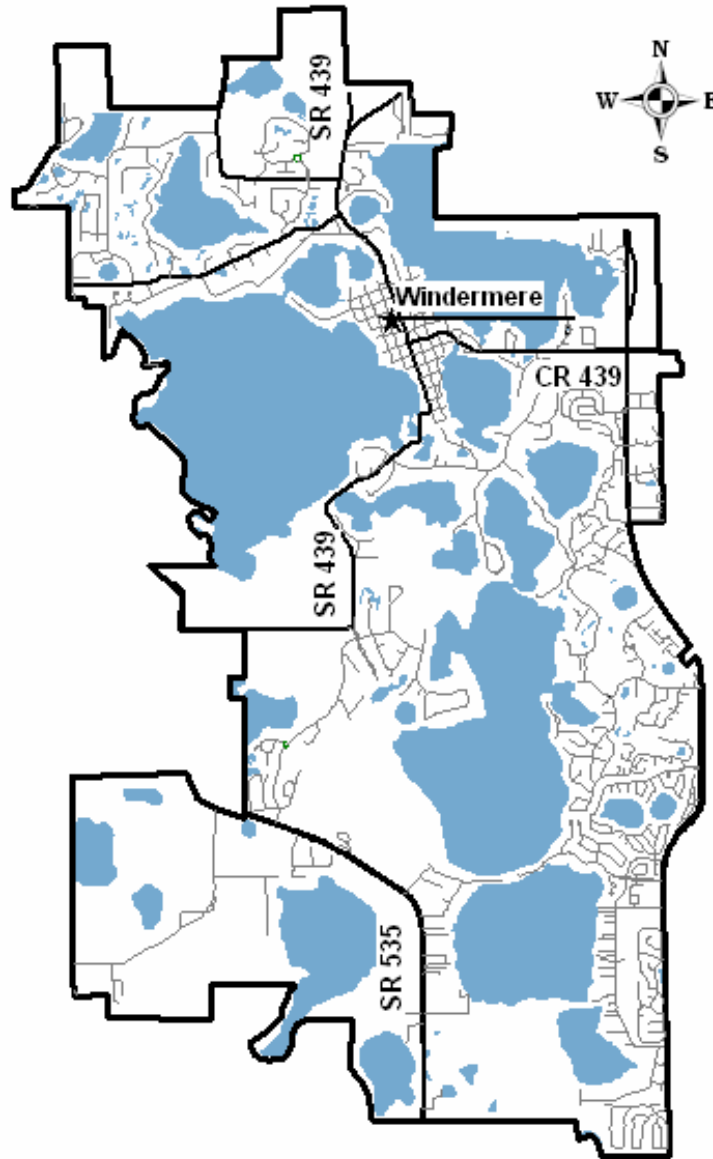

GENERAL EXCHANGE TARIFF

Embarq Florida, Inc.

SUPPLEMENT SECTION A3  
Tenth Revised Sheet 101  
Cancelling Ninth Revised Sheet 101  
Effective: June 1, 2005

By: F. B. Poag  
Director

EXCHANGE SERVICE AREA MAP  
WINTER GARDEN EXCHANGE

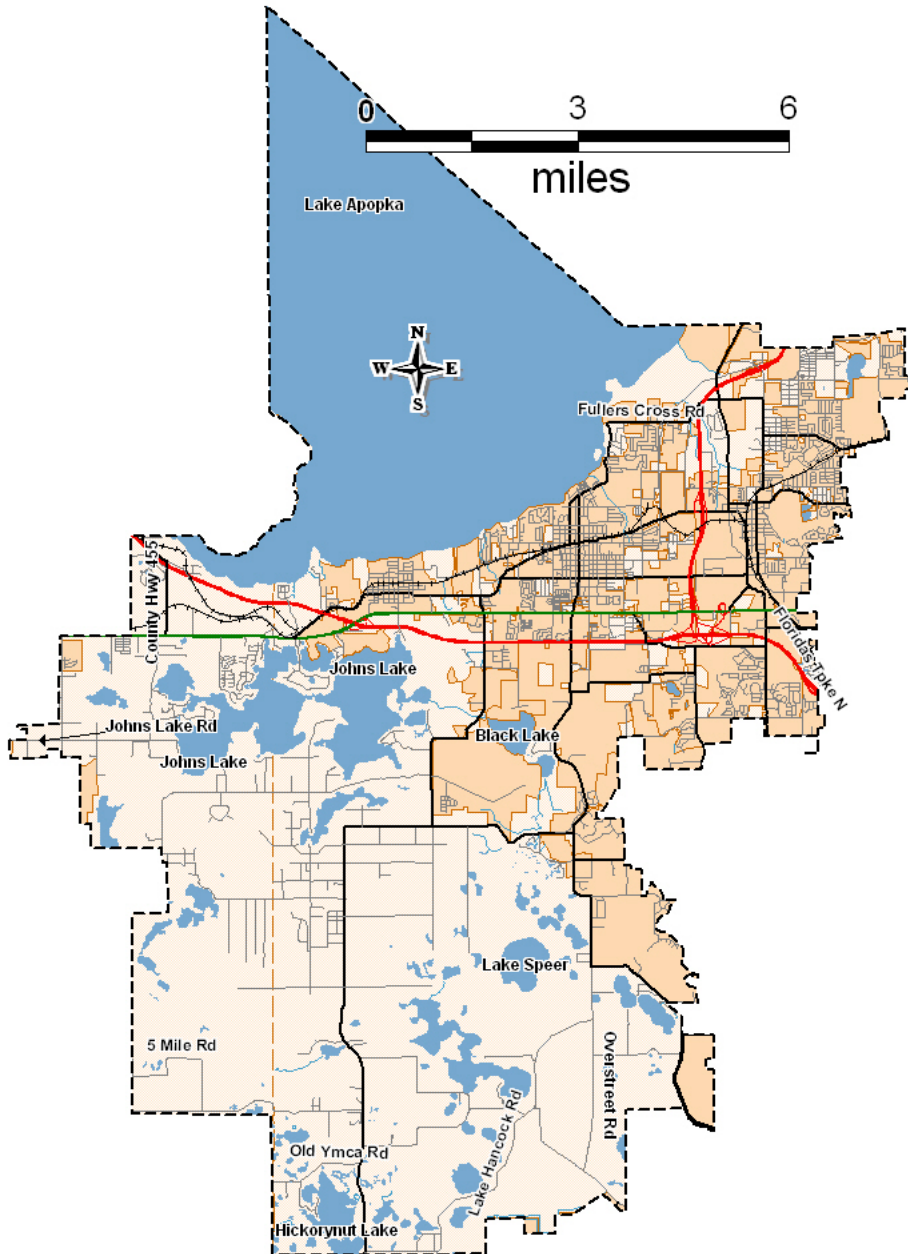

GENERAL EXCHANGE TARIFF

Embarq Florida, Inc.

By: F. B. Poag  
Director

Supplement Section 3  
Fourth Revised Sheet 102  
Cancelling Third Revised Sheet 102  
Effective: January 1, 2003

WINTER PARK EXCHANGE

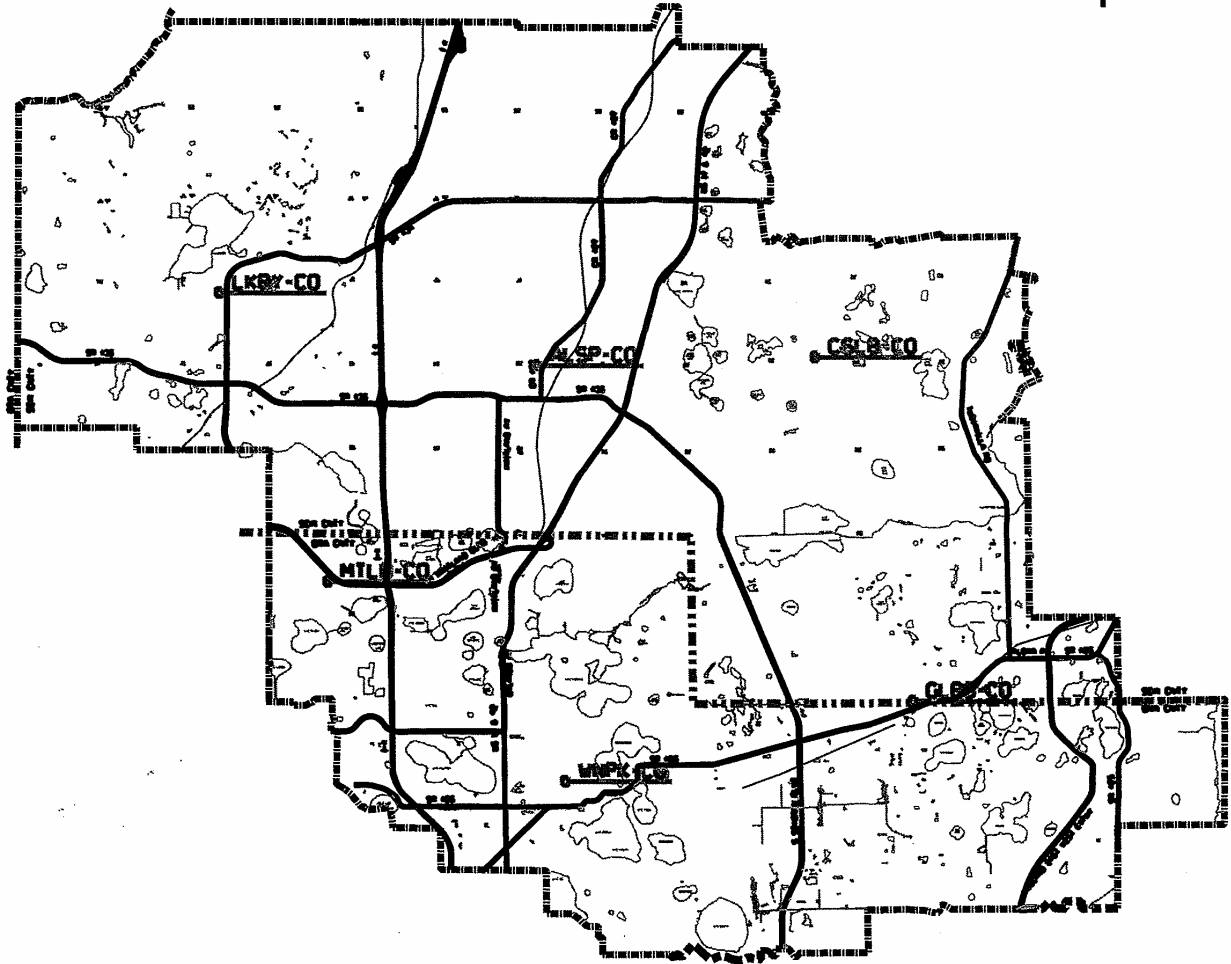

LEGEND

-----	EXCHANGE BOUNDARY
-----	COUNTY BOUNDARY
● WPK-CO	CENTRAL OFFICE LOCATION

GENERAL EXCHANGE TARIFF

Embarq Florida, Inc.

By: F. B. Poag  
Director

Supplement Section 3  
First Revised Sheet 103  
Cancelling Original Sheet 103  
Effective: January 1, 1997

ZOLFO SPRINGS EXCHANGE

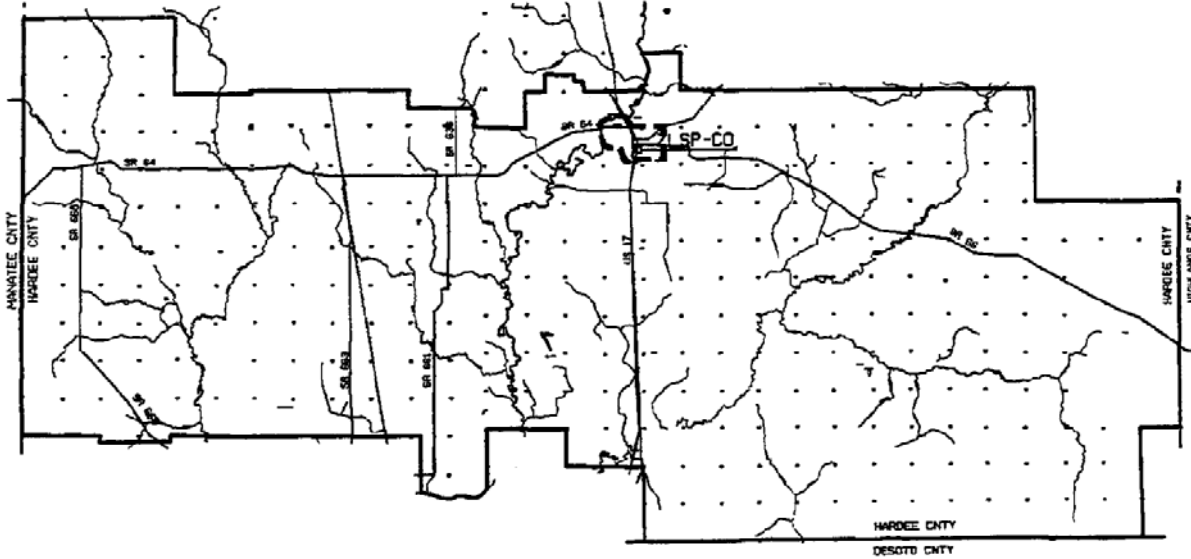

LEGEND

	EXCHANGE BOUNDARY
	COUNTY BOUNDARY
	BASE RATE BOUNDARY
	CENTRAL OFFICE LOCATION

