

MEMORANDUM

November 19, 1998

RECEIVED
NOV 19 1998
FEDERAL BUREAU OF INVESTIGATION
U.S. DEPARTMENT OF JUSTICE

TO: DIVISION OF RECORDS AND REPORTING

FROM: DIVISION OF LEGAL SERVICES (McKINNEY) *JCM MB*

RE: DOCKET NO. 981074-TP - Interim traffic termination and billing agreement between Vista-United Telecommunications and Teleport Communications Group South Florida.

98-1525-FOT-TP

Attached is an **Order Approving Interim Traffic Termination and Billing Agreement, with attachment**, to be issued in the above-referenced docket. (Number of pages in order - *21*)

29

JCM/slh
Attachment
cc: Division of Communications
I:981074.jcm

ATTACHMENT(S) NOT ON-LINE

BEFORE THE FLORIDA PUBLIC SERVICE COMMISSION

In re: Interim traffic termination and billing agreement between Vista-United Telecommunications and Teleport Communications Group South Florida.

DOCKET NO. 981074-TP
ORDER NO. PSC-98-1525-FOF-TP
ISSUED: November 19, 1998

The following Commissioners participated in the disposition of this matter:

JULIA L. JOHNSON, Chairman
J. TERRY DEASON
SUSAN F. CLARK
JOE GARCIA
E. LEON JACOBS, JR.

ORDER APPROVING INTERIM TRAFFIC TERMINATION
AND BILLING AGREEMENT

On August 26, 1998, Vista-United Telecommunications (Vista-United) and Teleport Communications Group South Florida (Teleport) filed a request for approval of an interim traffic termination and billing agreement under 47 U.S.C. §252(e) of the Telecommunications Act of 1996 (the Act). The agreement is attached to this Order as Attachment A and incorporated by reference herein.

Both the Act and Chapter 364, Florida Statutes, encourage parties to enter into negotiated agreements to bring about local exchange competition as quickly as possible. Under the requirements of 47 U.S.C. § 252 (e), negotiated agreements must be submitted to the state commission for approval. Section 252(e)(4) requires the state to reject or approve the agreement within 90 days after submission or it shall be deemed approved.

This agreement covers a two-year period and governs the relationship between the companies regarding the termination and the exchange of traffic between the facilities operated by the parties. Under 47 U.S.C. § 252(a)(1), the agreement shall include a detailed schedule of itemized charges for interconnection and each service or network element included in the agreement.

DOCUMENT NUMBER-DATE

13047 NOV 19 98

FPC-RECORDS/REPORTING

ORDER NO. PSC-98-1525-FOF-TP
DOCKET NO. 981074-TP
PAGE 2

Upon review of the proposed agreement, we believe that it complies with the Telecommunications Act of 1996; thus, we hereby approve it. Vista-United and Teleport are also required to file any subsequent supplements or modifications to their agreement with the Commission for review under the provisions of 47 U.S.C. § 252(e).

Based on the foregoing, it is

ORDERED by the Florida Public Service Commission that the interim traffic termination and billing agreement between Vista-United Telecommunications and Teleport Communications Group South Florida, as set forth in Attachment A and incorporated by reference in this Order, is hereby approved. It is further

ORDERED that any supplements or modifications to this agreement must be filed with the Commission for review under the provisions of 47 U.S.C. §252(e). It is further

ORDERED that this docket shall be closed.

By ORDER of the Florida Public Service Commission this 19th day of November, 1998.

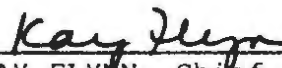

KAY FLYNN, Chief
Bureau of Records

(S E A L)

JCM

ORDER NO. PSC-98-1525-FOF-TP
DOCKET NO. 981074-TP
PAGE 3

NOTICE OF FURTHER PROCEEDINGS OR JUDICIAL REVIEW

The Florida Public Service Commission is required by Section 120.569(1), Florida Statutes, to notify parties of any administrative hearing or judicial review of Commission orders that is available under Sections 120.57 or 120.68, Florida Statutes, as well as the procedures and time limits that apply. This notice should not be construed to mean all requests for an administrative hearing or judicial review will be granted or result in the relief sought.

Any party adversely affected by the Commission's final action in this matter may request: 1) reconsideration of the decision by filing a motion for reconsideration with the Director, Division of Records and Reporting, 2540 Shumard Oak Boulevard, Tallahassee, Florida 32399-0850, within fifteen (15) days of the issuance of this order in the form prescribed by Rule 25-22.060, Florida Administrative Code; or 2) judicial review in Federal district court pursuant to the Federal Telecommunications Act of 1996, 47 U.S.C. § 252(e)(6).

ORDER NO. PSC-98-1525-FOF-TP

DOCKET NO. 981074-TP

PAGE 4

ATTACHMENT A

**INTERIM TRAFFIC TERMINATION AND BILLING
AGREEMENT**

dated as of August 19, 1998

between

VISTA-UNITED TELECOMMUNICATIONS

and

**TELEPORT COMMUNICATIONS GROUP SOUTH
FLORIDA**

TABLE OF CONTENTS

1. EXCHANGES INCLUDED	2
1.1. Exchanges Included	2
2. PROVISION OF SERVICE	2
2.1. Provision of Service	2
3. TRAFFIC RECORDING AND IDENTIFICATION	3
3.1. Traffic Recording and Identification	3
4. COMPENSATION ARRANGEMENT	4
4.1. Toll Traffic	4
4.2. Compensation Arrangement	4
5. ALTERNATE BILLED MESSAGES	5
5.1. Alternate Billed Messages	5
6. OPERATOR SERVICES	6
6.1. Operator Services	6
7. AUDITS	6
7.1. Audits	6
8. GOVERNING LAW	6
8.1. Governing Law	6
9. ENTIRE AGREEMENT; NO OFFER	6
9.1. Entire Agreement; No Offer	6
10. REPRESENTATIONS AND WARRANTIES	7
10.1. TCG's Representations	7
10.2. VISTA's Representations	8

ATTACHMENT A

11. LIMITATIONS OF LIABILITY AND INDEMNIFICATIONS	8
11.1. Limitations of Liability and Indemnifications	8
12. ASSIGNMENT AND BINDING EFFECT	10
12.1. Assignment and Binding Effect	10
13. RIGHTS CUMULATIVE	10
13.1. Rights Cumulative	10
14. FORCE MAJEURE	11
14.1. Force Majeure	11
15. NO WAIVER	11
15.1. No Waiver	11
16. CONFIDENTIALITY OF PROPRIETARY DATA	11
16.1. Confidentiality of Proprietary Data	11
17. AGREEMENT DOES NOT BENEFIT NON-PARTIES	12
17.1. Agreement Does Not Benefit Non-Parties	12
18. TERM	12
19.1. Term	12
19. NOTICES	13
19.1. Notices Requirements	13
19.2. Notices Addresses	13
19.3. Different Address	14
19.4. Refusal of Notice	14
20. SEVERABILITY	14
20.1. Severability	14

ATTACHMENT A

21. ACCORD AND SATISFACTION 14

 21.1. Accord and Satisfaction 14

22. DEFAULTS OR VIOLATIONS 15

 22.1. Defaults or Violations 15

23. PROMOTIONS 15

 23.1. VISTA's Promotions 15

 23.2. TCG's Promotions 15

24. COUNTERPARTS 16

 24.1. Counterparts 16

25. FORUM AND VENUE FOR LEGAL PROCEEDINGS 16

 25.1. Forum and Venue for Legal Proceedings 16

26. RELATIONSHIP DISCLAIMER 16

 26.1. Relationship Disclaimer 16

 26.2. Construction of Agreement 16

27. EXECUTION 17

 28.1. Execution 17

ORDER NO. PSC-98-025-FOF-TP
DOCKET NO. 981074-TP
PAGE 8

ATTACHMENT A
ATTACHMENT LIST

ATTACHMENT "A" Exchanges

ATTACHMENT "B" Arrangement of Facility Systems

ATTACHMENT A

INDEX OF DEFINED TERMS

"Act"	1
"Affiliates"	9
"Agreement"	1
"Alternate Billed Messages"	5
"ANT"	3
"BCC"	5
"CMDS"	5
"CMRSP"	2
"Commission"	1
"Confidential Information"	11
"Control"	9
"EMR"	3
"FCC"	2
"Governmental Authority"	7
"ICS"	5
"Indemnified Party"	9
"Indemnifying Party"	9
"LATA"	4
"LEC"	3
"Local Traffic"	2
"Meet Point"	2
"Mutual Traffic Exchange"	4
"Party"	1
"Systems"	2
"TCG"	1
"Toll Traffic"	2
"Unbillable Messages"	5
"Uncollectible Messages"	5
"VISTA"	1

INTERIM TRAFFIC TERMINATION AND BILLING AGREEMENT

This **INTERIM TRAFFIC TERMINATION AND BILLING AGREEMENT** ("Agreement") is effective as provided herein, by and between **TELEPORT COMMUNICATIONS GROUP SOUTH FLORIDA**, a New York general partnership ("TCG"), and **VISTA-UNITED TELECOMMUNICATIONS**, a Florida general partnership ("VISTA") (collectively, VISTA and TCG shall be referred to as the "Parties". "Party" shall be the singular reference to "Parties").

WITNESSETH:

WHEREAS, this Agreement sets forth the provisions under which TCG and VISTA will provide for originating, terminating, and/or transporting "Toll Traffic" (as defined hereinbelow in subsection 2.1.2) and "Local Traffic" (as defined hereinbelow in subsection 2.1.2) between the facilities operated by the Parties. This Agreement also sets forth the terms and conditions for the handling of telecommunications services for which charges are billed and collected by one Party for the other Party;

WHEREAS, this Agreement covers only traffic provided through the use of feature group type C access, feature group type D terminating access, or feature group type D originating access in those cases where either Party is the provider of services selected by an end-user, to the other Party's end offices;

WHEREAS, this Agreement is intended to fulfill VISTA's obligations under subsection 251 (a) of the Communications Act, as amended by the Telecommunications Act of 1996 ("Act"). This Agreement covers only the exchange of Local Traffic and Toll Traffic, which either TCG originates outside of VISTA's certificated service area and terminates inside VISTA's certificated service area; or VISTA originates inside of VISTA's certificated service area and terminates on TCG's network outside of VISTA's certificated service area, as described in each of the Party's respective applicable tariffs on file with the Florida Public Service Commission ("Commission"), and is intended to replicate the arrangements currently existing by and between VISTA and its neighboring incumbent local exchange companies for the exchange of Local Traffic; and

WHEREAS, it is specifically understood and agreed to by the Parties that nothing in this Agreement shall be construed as an attempt to reach agreement regarding matters contained in subsections 251 (b) and (c) of the Act; nor shall any act or omission by the Parties or any provision of this Agreement be construed as a waiver of the Parties rights under subsection 251 (f) of the Act.

NOW, THEREFORE, in consideration of the mutual obligations as set forth below the Parties hereby agree as follows:

1. EXCHANGES INCLUDED.

1.1. Exchanges Included.

The exchanges of VISTA covered by this Agreement are shown in Attachment "A", attached hereto and incorporated herein by reference. The exchanges of TCG covered by this Agreement are shown in Attachment "A", attached hereto.

2. PROVISION OF SERVICE.

2.1. Provision of Service.

The Parties provision of service shall be as follows:

2.1.1. The Parties agree, pursuant to the terms set out herein, to exchange traffic for the purpose of allowing origination and termination of telephone calls between the Parties' end users, including traffic originating from customers of a commercial mobile radio service provider ("CMRSP") and terminating to the Parties' end users, and including traffic originating from the Parties' end users and terminating to customers of "CMRSPs". For purposes hereof, "CMRSP" shall mean a common carrier provider of domestic public wireless or wireless telecommunication service, as defined in Part 22, Subpart H or Part 24 of the Federal Communication Commission ("FCC") Rules and Regulations.

2.1.2. Each Party will plan, design, construct and maintain the facilities within their respective "Systems". These facilities include, but are not limited to, a sufficient number of trunks to the point of connection, and sufficient interoffice and interexchange trunks between its own central offices to adequately handle traffic between all central offices within the service areas. The arrangement of the facility Systems including, but not limited to, routing and the "Meet Point" are shown in Attachment "B", attached hereto and incorporated herein by reference. Attachments "A" and "B", respectively, may be amended from time to time by mutual agreement in writing by the Parties as a result of changes in exchange boundaries, local calling areas or implementation of new NXX codes. For purposes hereof, "Systems" shall mean the exchange and interexchange switching, and transmission facilities that route, switch and transport a Party's Local Traffic and Toll Traffic as are necessary and proper for the provision of traffic covered by this Agreement. For purposes hereof, "Local Traffic" shall mean traffic which originates and terminates within the local service area of the Parties shown in Attachment "A" hereto, including extended area service and extended calling plan calls between the Parties. Traffic to, and from customers of CMRSP's shall be considered Local Traffic for purposes of this Agreement. For purposes hereof "Toll Traffic" shall mean traffic that is originated by an end user of the other Party and is not Local Traffic. For purposes hereof, "Meet Point" shall mean that point mutually agreed upon by the Parties at which their network facilities are interconnected for the reciprocal exchange of traffic.

ATTACHMENT A

2.1.3. The provisioning and engineering of such services and facilities will comply with generally accepted industry methods and practices and the Parties shall observe the rules and regulations of their respective lawfully established tariffs applicable to the services provided. To the extent that TCG requests a design which exceeds VISTA's standard cost, VISTA will provide TCG with such actual cost of such TCG requested design and TCG shall within thirty (30) days of the date of such notification by VISTA of such actual cost: (i) elect to promptly pay all such costs; or (ii) direct VISTA to proceed with the design planned by VISTA immediately prior to VISTA's receipt of such request by TCG. In the event TCG does not so notify VISTA of its election on or before such thirty (30) day election period, it shall be deemed that TCG elected option (ii) in this subsection 2.1.3.

2.1.4. The traffic covered by this Agreement shall be routed as indicated in Attachment "B". Any changes in routing shall be agreed upon in writing by the Parties before becoming effective.

3. TRAFFIC RECORDING AND IDENTIFICATION.

3.1. Traffic Recording and Identification.

The Parties traffic recording and identification is as follows:

3.1.1. The traffic recording and identification functions required to provide the services specified hereunder shall be performed by the Parties. Each Party shall calculate terminating minutes of use based on standard automatic message accounting recording made within each Party's network. The record shall contain the appropriate automatic number identification ("ANI") information or service provider information to identify the originating company. The Party originating traffic shall generate and provide the appropriate expanded message record ("EMR") or other agreed upon record format, to the terminating Party. The Parties shall each use commercially reasonable efforts to provide these records monthly, but in no event later than sixty (60) days after generation of the usage data. For purposes herein, "ANI" shall mean the process which identifies the telephone number of the line initiating a call in order to send this information to the automatic message accounting system. For purposes hereof, "EMR" shall mean industry accepted formatted records to be exchanged between local exchange carriers ("LEC") for billing purposes. For purposes hereof, "LEC" shall have the meaning ascribed to it in the Act.

3.1.2. TCG and VISTA agree they will, to the extent feasible, make every attempt to accurately capture and report the actual usage interchanged between them for use in calculating the necessary compensation under this Agreement.

3.1.3. Should actual traffic information (measured in minutes of use) not be available, the Parties will mutually agree on a suitable alternative basis for calculating compensation which most closely approximates the actual interchanged usage.

3.1.4. Each Party shall deliver monthly statements for terminating the other's traffic.

4. COMPENSATION ARRANGEMENT.

4.1. Toll Traffic.

Toll Traffic will be intra local access and transport area ("LATA") traffic where originating or terminating points are within the same LATA. For purposes hereof, "LATA" shall mean local access and transport area as defined in subsection 3(a)(43) of the Act.

4.2. Compensation Arrangement.

The Parties agree to compensate each other for the termination of Local Traffic and intraLATA Toll Traffic pursuant to this Agreement in accordance with the following:

4.2.1. Each Party shall generate a monthly bill for intraLATA Toll Traffic, as applicable, to the other Party for traffic terminating to its end offices.

4.2.2. Compensation for termination of Local Traffic will be by "Mutual Traffic Exchange". For purposes hereof, "Mutual Traffic Exchange" shall mean a form of compensation in which one Party is compensated for terminating the other Party's Local Traffic through the reciprocal termination of its traffic by the other Party.

4.2.3. Compensation for termination of Toll Traffic shall be calculated by applying the access rates set forth in the tariff or price list, filed by or on behalf of each Party with the Commission. As rates change, the latest effective rates will be used. Switched access service is intended to compensate the Parties pursuant to this Agreement, when the Parties provide: (i) loop, drop and associated equipment from the end office to the end user (carrier common line); (ii) end office switching functions (traffic sensitive), local switching including, line termination and intercept (applicable only if the element is included in such Party's intrastate access tariff or price list); and (iii) local transport facilities.

4.2.4. The Parties agree that the following billing percentages apply for the calculation of common transport charges from intraLATA Toll Traffic: For Toll Traffic originating from TCG and terminating to VISTA, the percentage of transport billed by VISTA will be thirty five percent (35%) based upon the location of the Meet Point shown in Attachment "B" attached hereto. For Toll Traffic originating from VISTA and terminating to TCG, the percentage of transport billed by TCG will be sixty five percent (65%) based upon the location of the Meet Point shown in Attachment "B" attached hereto.

4.2.5. All compensation payable pursuant to this Agreement for termination of traffic shall be payable within thirty (30) days of the bill date.

5. ALTERNATE BILLED MESSAGES.**5.1. Alternate Billed Messages.**

5.1.1. Each Party agrees to provide the other Party billing, collecting and remitting services on "Alternate Billed Messages". Each Party will provide to the other Party the EMR standard formatted record for billing of messages to their end users. These records may be exchanged over centralized message distribution systems ("CMDS"). The CMDS transport system is used by the Bellcore Client Companies ("BCC") and other LEC's (through a sponsor relationship with a BCC) for the efficient transmission and exchange of in-collect and out-collect (intercompany settlement ("ICS") and non-ICS messages) billable records, access usage records, and summary usage records or a tape generated and mailed to the billing company. These records must be exchanged at least monthly. For purposes herein, "Alternate Billed Messages" shall mean messages originating on one Party's facilities that are billed by another company. Alternate Billed Messages include, without limitation, calls that are collect, third number billed and billed to a LEC calling card. For purposes hereof, "CMDS" shall mean a generic term that refers to all applications using the centralized nationwide system for the interexchange of data through a network of private line transmission facilities.

5.1.2. Each Party agrees to remit to the other Party the revenue value of each Alternate Billed Message less a billing and collection fee of \$0.0666 per message.

5.1.3. For purposes hereof, "Unbillable Messages" shall mean messages with respect to which the end user customer account cannot be identified. Unbillable Messages will be the responsibility and liability of the originating company. The billing company shall appropriately account for and return the Unbillable Messages to the originating company pursuant to EMR standard guidelines.

5.1.4. For purposes hereof, "Uncollectible Messages" shall mean messages that are billed to a customer account, however, revenues cannot be collected including, without limitation, messages with respect to which the end user denies all knowledge. Uncollectible Messages shall be the responsibility and liability of the billing company.

5.1.5. Each Party shall promptly furnish to the other Party such information as may be required for monthly compensation purposes. Compensation statements for Alternate Billed Messages will be rendered monthly and remittance in full will be made by the debtor company thirty (30) days thereafter. The Parties hereby agree that if any monthly statement reflects a total amount payable less than Ten and NO/100 Dollars (\$10.00), no payment shall be due with respect to such statement.

6. OPERATOR SERVICES.

6.1. Operator Services.

Each Party will be responsible for maintaining its own customer information in currently available databases used in the provision of miscellaneous intercompany operator services (i.e. local assistance, directory assistance, directory assistance call completion, busy line verification/interrupt).

7. AUDITS.

7.1. Audits.

Each Party will keep adequate records of all collection, payments and other transactions hereunder. Upon thirty (30) days prior written notice, either Party may request an audit of the usage reports or billing data supplied by the other Party hereunder and any such audit shall be accomplished during normal business hours at the office designated by the Party being audited. Audit requests shall not be submitted more frequently than one time per calendar year. Audits may be performed by a mutually acceptable independent auditor paid for by the Party requesting the audit. A request for an audit must be received within one year of receipt of the records or usage reports from the audited Party. Auditors hereunder shall not be compensated on a contingent fee basis.

8. GOVERNING LAW.

8.1. Governing Law.

This Agreement shall be governed by, construed under, interpreted and enforced in accordance with the laws of the State of Florida, and, where applicable, the laws of the United States of America.

9. ENTIRE AGREEMENT: NO OFFER.

9.1. Entire Agreement: No Offer.

This Agreement contains the entire Agreement of VISTA and TCG with respect to the subject matter hereof, and no representations, warranties, inducements, promises or agreements, oral or otherwise, between the Parties not embodied in this Agreement shall be of any force or effect. This Agreement shall be modified only by a written agreement executed by both Parties with the same formalities as this Agreement. All prior agreements or communications that are the subject matter of this Agreement are and shall be merged into this Agreement and shall have no force or effect. Neither any submission of this Agreement by one Party to the other, nor any correspondence or other communications between the Parties in connection therewith, is intended or shall be deemed to constitute an offer of any kind or to create any obligations between the Parties unless and until one or more duplicates of this Agreement has been fully executed and delivered between the Parties. Accordingly, any such submission, communications or

correspondence between the Parties or their respective agents or attorneys is intended only as non-binding discussions prior to such execution, and either Party shall have the absolute right to withdraw from such discussions without any liability whatsoever to the other Party prior to such execution.

10. REPRESENTATIONS AND WARRANTIES.

10.1. TCG's Representations.

TCG represents and warrants to VISTA the following:

10.1.1. TCG is a general partnership duly organized, validly existing and in good standing under the laws of the State of New York and is authorized to transact business in the State of Florida;

10.1.2. TCG, and the undersigned signatory executing this Agreement on behalf of TCG, are duly authorized and empowered to enter into this Agreement with VISTA;

10.1.3. To the best of the undersigned's actual knowledge on behalf of TCG, neither the entering into of this Agreement nor the performance or satisfaction by TCG of its obligations and liabilities hereunder nor the exercise by TCG of any of its rights or options hereunder, will constitute or result in a violation or breach by TCG of any judgment, order, writ, injunction or decree issued against or imposed upon it, or to the best of the undersigned's actual knowledge on behalf of TCG will result in a violation of any applicable Law;

10.1.4. To the best of the undersigned's actual knowledge on behalf of TCG, there is no action, suit, proceeding or investigation pending or threatened, which would prevent, impair or which questions the validity or enforceability of this Agreement or any action taken pursuant hereto in any court or before or by any federal, district, county, or municipal department, commission, board, bureau, agency or other governmental instrumentality; and

10.1.5. Except as provided in subsection 18.1.1 of this Agreement, no further approval, consent, order or authorization of, or designation, registration or filing with, the United States and any state, county, city or political subdivision thereof, and any board, bureau, council, commission, department, agency, court, legislative body or other instrumentality of the United States or any state, county, city or political subdivision thereof including, without limitation, the Reedy Creek Improvement District, a political subdivision of the State of Florida (collectively, "Governmental Authority"), is required in connection with the due and valid execution and delivery of this Agreement and compliance with the provisions hereof by TCG.

10.1.6. TCG shall perform its obligations hereunder using reasonable care

10.2. VISTA's Representations.

VISTA represents and warrants to TCG the following:

10.2.1. VISTA is a general partnership duly organized, validly existing and in good standing under the laws of the State of Florida and is authorized to transact business and holds a certain Certificate of Public Convenience and Necessity in the State of Florida;

10.2.2. VISTA, and the undersigned signatory executing this Agreement on behalf of VISTA are duly authorized and empowered to enter into this Agreement with TCG;

10.2.3. To the best of the undersigned's actual knowledge on behalf of VISTA, neither the entering into of this Agreement nor the performance or satisfaction by VISTA of its obligations and liabilities hereunder nor the exercise by VISTA of any of its rights or options hereunder will constitute or result in a violation or breach by VISTA of any judgment, order, writ, injunction or decree issued against or imposed upon it, or to the best of the undersigned's actual knowledge on behalf of VISTA will result in a violation of any applicable Law;

10.2.4. To the best of the undersigned's actual knowledge on behalf of VISTA, there is no action, suit, proceeding or investigation pending or threatened, which would prevent, impair or which questions the validity or enforceability of this Agreement or any action taken pursuant hereto in any court or before or by any federal, district, county, or municipal department, commission, board, bureau, agency or other governmental instrumentality; and

10.2.5. Except as provided in subsection 18.1.1 of this Agreement, no further approval, consent, order or authorization of, or designation, registration or filing with, any Governmental Authority is required in connection with the due and valid execution and delivery of this Agreement and compliance with the provisions hereof by VISTA.

10.2.6. VISTA shall perform its obligations hereunder using reasonable care.

11. LIMITATIONS OF LIABILITY AND INDEMNIFICATIONS

11.1. Limitations of Liability and Indemnifications

The Parties agree that the following limitations of liability and indemnifications shall apply:

11.1.1. Except for the willful misconduct or gross negligence of either Party hereto, neither TCG nor VISTA will be liable to the other for either Party's indirect, incidental, special or consequential damages (including, but not limited to, lost profits) arising, in whole or in part, from either Party's actions, omissions, mistakes, or negligence relating to performance under this Agreement (including, but not limited to, breaches of this Agreement).

11.1.2. Neither Party shall be liable for any act or omission of another telecommunications company providing a portion of the services provided under this Agreement.

ATTACHMENT A

to the amount which the Indemnifying Party is able to demonstrate that it could have settled the matter for immediately prior to the time of such assumption

11.1.9. In the event that the Indemnifying Party does not accept the defense of any matter as above provided, the Indemnified Party shall have the full right to defend against any such claim or demand, and shall be entitled to settle or agree to pay in full such claim or demand, in its sole discretion without waiving its right to indemnification hereunder.

11.1.10. For purposes of this Agreement, "Affiliates" shall mean as to any entity, any other entity which is controlled by, controls, or is under common control with such entity. The term "control" in this definition (including, the terms "controlled", "controlled by" and "under common control with") shall mean the possession, direct or indirect, of the power to direct or cause the direction of the management and policies of an entity. The term "Affiliates" shall be the plural reference to "Affiliate".

11.1.11. The provisions of this Article 11 shall survive the expiration or sooner termination of this Agreement.

12. ASSIGNMENT AND BINDING EFFECT.

12.1. Assignment and Binding Effect.

Neither Party may assign, transfer, or sublease (whether by operation of law or otherwise) this Agreement (or any rights or obligations hereunder) to a third party (including, a partner, corporate Affiliate or an entity under its common control or an entity acquiring all or substantially all of its operations, assets or equity in Florida) without the prior written consent of the other Party, which consent shall not be unreasonably withheld. Any attempted assignment or transfer not permitted under this Agreement shall be void ab initio. Notwithstanding the foregoing, VISTA hereby consents to TCG's transfer, assignment or sublease of this Agreement to AT&T Corporation or any of its Affiliates, and upon any such transfer, assignment or sublease of this Agreement by TCG to AT&T Corporation or any of its Affiliates, AT&T Corporation or any of its Affiliates shall thereby be bound by and to all of the obligations and covenants of TCG under this Agreement and all of the terms and conditions of this Agreement. Without limiting the foregoing, with respect to any approved assignment, transfer and/or sublease hereunder, the assignor, transferor, and/or sublessor, as the case may be, shall be released from the rights, duties and obligations in this Agreement and such rights, duties and obligations shall extend to, be binding upon and inure to the benefit of such assignee, transferee and/or sublessee, as the case may be.

13. RIGHTS CUMULATIVE.

13.1. Rights Cumulative

All rights, remedies, powers and privileges conferred under this Agreement on the parties shall be cumulative of and in addition to, but not restrictive of or in lieu of, those conferred by Law.

14. FORCE MAJEURE.**14.1. Force Majeure.**

Except as otherwise expressly provided in this Agreement, and except with respect to any failure to pay any sum due hereunder as a result of bankruptcy, insolvency or refusal or inability to pay, if either Party shall be delayed or hindered in whole or in part, or prevented from, the performance of any non-monetary covenant or obligation hereunder as a result of acts of God, fire or other casualty, earthquake, hurricane, flood, epidemic, landslide, enemy act, war, riot, intervention by civil or military authorities of government, insurrection or other civil commotion, general unavailability of certain materials, strikes, boycotts, lockouts, labor disputes or work stoppage beyond the control of either Party hereto, then the performance of such covenant or obligation, shall be excused for the period of such delay, hindrance or prevention and the period of the performance of such covenant or obligation shall be extended by the number of days equivalent to the number of days of such delay, hindrance or prevention.

15. NO WAIVER.**15.1. No Waiver.**

No release, discharge or waiver of any provision hereof shall be enforceable against or binding upon either Party unless in writing and executed by the other Party as the case may be. Neither the failure of either Party to insist upon a strict performance of any of the agreements, terms, covenants and conditions hereof, nor the acceptance of any payments from either Party with knowledge of a breach of this Agreement by the other Party in the performance of its obligations hereunder, shall be deemed a waiver of any rights or remedies that VISTA or TCG may have or a waiver of any subsequent breach or default in any of such agreements, terms, covenants and conditions.

16. CONFIDENTIALITY OF PROPRIETARY DATA**16.1. Confidentiality of Proprietary Data.**

The Parties agree that it may be necessary to exchange certain confidential information during the term of this Agreement including, without limitation, technical and business plans, technical information, proposals, specifications, drawings, procedures, customer account data and similar information (collectively, "Confidential Information"). The Confidential Information shall either be in writing or other tangible forms and clearly marked with a confidential, private or proprietary legend (except for all information reviewed pursuant to Article 7 which shall be protected hereunder, whether or not so marked) or when the Confidential Information is communicated orally, it shall also be communicated that the Information is confidential, private or proprietary. The Confidential Information shall be returned to the owner within seven (7) days from such Party's receipt of owner's request for same. Except as otherwise required by Law or the rules of the Commission, VISTA and TCG agree not to disclose Confidential Information to any third party other than to their respective directors, officers, employees and agents and advisors (including, legal, financial and accounting advisors) as needed to effectuate this

ATTACHMENT A

18.1.4. The Parties acknowledge that this Agreement does not cover all aspects of the exchange of local and intraLATA toll traffic under the Act. If changes in business plans, traffic volumes or network configurations warrant, other exchanges of traffic between the Parties will be negotiated on a nondiscriminatory basis.

18.1.5. This Agreement shall have no precedential effect in the event the Parties negotiate or arbitrate a definitive agreement pursuant to subsections 251(b) and (c) of the Act as applicable.

19. NOTICES.

19.1. Notices Requirements.

Any notice, demand, request, offer, consent, approval or communication to be provided under this Agreement shall be in writing and shall be deemed received: (i) two business days after it is deposited, postage prepaid, in the United States mail, certified or registered mail with a return receipt requested, addressed (as the case may be) to VISTA at VISTA's address shown herein, or to TCG at TCG's address shown herein; (ii) the next day after it is deposited with a nationally recognized and reputable air courier addressed (as the case may be) to VISTA at VISTA's address shown herein, or to TCG at TCG's address shown herein; (iii) the same day it is personally delivered (as the case may be) to VISTA at VISTA's address shown herein, or to TCG at TCG's address shown herein; or (iv) by facsimile, which shall be effective on the next Business Day following the date of transmission, "Business Day" meaning Monday through Friday, except for holidays on which United States mail is not delivered.

19.2. Notices Addresses.

Notices Addresses for the Parties are set forth as follows:

Teleport Communications Group South Florida
Legal
1 Teleport Drive, Suite 300
Staten Island, NY 10311-1004
Attention: General Counsel

with a copy to:

Teleport Communications Group South Florida
429 Ridge Road
Dayton, NJ 08810
Attention: Vice President-Carrier Relations and Settlements

Vista-United Telecommunications
3100 Bonnet Creek Road
Lake Buena Vista, Florida 32830
Attention: Contracts and Tariffs Manager

ATTACHMENT A

with a copy to:

Vista-United Telecommunications
Post Office Box 10,000
Lake Buena Vista, Florida 32830-1000
Attention: General Counsel

19.3. Different Address.

Either Party may designate a different representative and/or address for receiving notice hereunder by giving thirty (30) days prior written notice to the other Party in accordance with the provisions hereof.

19.4. Refusal of Notice.

If any notice is tendered and is refused by the intended recipient, such notice shall, nonetheless, be considered to have been given and shall be effective as of the date provided herein.

20. SEVERABILITY.

20.1. Severability.

If any clause or provision of this Agreement is illegal, invalid or unenforceable under applicable present or future Laws effective during the term of this Agreement, the remainder of this Agreement shall not be affected. In lieu of each clause or provision of this Agreement which is illegal, invalid or unenforceable, there shall be added as a part of this Agreement a clause or provision as nearly identical as may be possible and as may be legal, valid and enforceable. Notwithstanding the foregoing, in the event any clause or provision of this Agreement is illegal, invalid or unenforceable as aforesaid and the effect of such illegality, invalidity or unenforceability is that either Party no longer has the substantial and material benefit of its bargain under this Agreement, then, in such event, such Party may, in its discretion, request good faith renegotiation with the other Party of such illegal, invalid or unenforceable provision. If the Parties do not reach agreement on such provision within thirty (30) days of the date of such request, either Party may cancel and terminate this Agreement (if allowable by applicable law) upon providing reasonable advance written notice thereof to the other Party.

21. ACCORD AND SATISFACTION.

21.1. Accord and Satisfaction.

Payment by either Party, or receipt or acceptance by a receiving Party hereto, of any payment due hereunder in an amount less than the amount required to be paid hereunder shall not be deemed an accord and satisfaction, or a waiver by the receiving Party of its right to receive and recover the full amount of such payment due hereunder, notwithstanding any statement to the contrary on any check or payment or on any letter accompanying such check or payment. The

receiving Party may accept such check or payment without prejudice to the receiving Party's right to recover the balance of such payment due hereunder or to pursue any other legal or equitable remedy provided in this Agreement.

22. DEFAULTS OR VIOLATIONS.

22.1. Defaults or Violations.

If disputes arise with regard to this Agreement or its Attachments during the term of this Agreement, the dispute resolution process established by the Commission shall apply and the resolution resulting from that process shall be binding on the Parties.

23. PROMOTIONS.

23.1. VISTA's Promotions.

Except as specifically permitted by VISTA in this Agreement, TCG shall acquire no right under this Agreement to use, and shall not use, the name of VISTA, "VISTA-UNITED TELECOMMUNICATIONS", the name "Disney" (either alone or in conjunction with or as a part of any other word, mark or name) or any marks, fanciful characters or designs of VISTA or The Walt Disney Company or any of its related, Affiliated or subsidiary companies, in any of its advertising, publicity or promotion; to express or imply any endorsement by VISTA of its services; or in any other manner whatsoever (whether or not similar to the uses hereinabove specifically prohibited). VISTA reserves the right to approve or disapprove, in its sole discretion, any advertising and promotional materials to be used on, within, in conjunction with, or in any way mentioning advertising or promoting TCG's business with respect to VISTA's systems. This Section 23.1 shall survive the expiration or sooner termination of this Agreement.

23.2. TCG's Promotions.

Except as specifically permitted by TCG in this Agreement, VISTA shall acquire no right under this Agreement to use, and shall not use, the name of TCG, the name "Teleport Communications Group South Florida" (either alone or in conjunction with or as a part of any other word, mark or name) or any marks, fanciful characters or designs of TCG or any of its related, Affiliated or subsidiary companies, in any of its advertising, publicity or promotion; to express or imply any endorsement by TCG of its services; or in any other manner whatsoever (whether or not similar to the uses hereinabove specifically prohibited). TCG reserves the right to approve or disapprove, in its sole discretion, any advertising and promotional materials to be used on, within, in conjunction with, or in any way mentioning advertising or promoting VISTA's business with respect to TCG's systems. This Section 23.2 shall survive the expiration or sooner termination of this Agreement.

24. COUNTERPARTS.

24.1. Counterparts.

This Agreement may be executed in several counterparts, each of which shall be deemed an original, and all of such counterparts together shall constitute one and the same instrument.

25. FORUM AND VENUE FOR LEGAL PROCEEDINGS.

25.1. Forum and Venue for Legal Proceedings.

Any legal proceeding of any nature brought by either Party against the other to enforce any right or obligation under this Agreement, or arising out of any matter pertaining to this Agreement, shall be submitted exclusively for trial, before the Circuit Court for Orange County, Florida; or if such court shall not have jurisdiction, then before any other court or administrative body sitting in the State of Florida having subject matter jurisdiction. The Parties consent and submit to the exclusive jurisdiction of any such court and agree to accept service of process outside the State of Florida in any matter to be submitted to any such court pursuant hereto.

26. RELATIONSHIP DISCLAIMER.

26.1. Relationship Disclaimer.

The Parties hereby acknowledge that it is not their intention to create between themselves a partnership, joint venture, fiduciary, employment or agency relationship for the purposes of this Agreement, or for any other purpose whatsoever. Accordingly, notwithstanding any expressions or provisions contained herein or in any other document, nothing in this Agreement or in any documents executed or delivered or to be executed or delivered shall be construed or deemed to create, or to express an intent to create, a partnership, joint venture, fiduciary, employment or agency relationship of any kind or nature whatsoever between the Parties hereto.

26.2. Construction of Agreement.

This Agreement has been fully reviewed and negotiated by the Parties hereto and their respective counsel. Accordingly, in interpreting this Agreement, no weight shall be placed upon which Party hereto or its counsel drafted the provisions being interpreted.

27. EXECUTION.

27.1. Execution.

TCG and VISTA hereby authorize and execute this Agreement.

**TELEPORT COMMUNICATIONS GROUP
SOUTH FLORIDA**

**VISTA-UNITED
TELECOMMUNICATIONS**

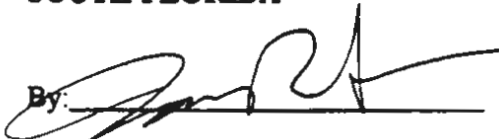
By: 

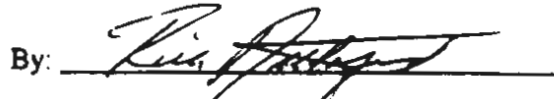
By: 

Name: Jim WASHINGTON

Name: Rick Astleford

Its: VP CARRIER RELATIONS & SETTLEMENTS

Its: General Manager

Date: 8/7/98

Date: 8/19/98

APPROVED AS TO FORM
LEGAL DEPARTMENT
Date 8/6/98 By MFL

ATTACHMENT A
ATTACHMENT "A"

Exchanges

1. TCG Exchanges include:

NPA-NXX	End Office CLLI	EO Vert	EO Horz	Serving	Local	Toll
A. 407-551	ORLEFLGVDSO	7954	1031	Maitland	abcdefgh	
B. 407-552	ORLEFLGVDSO	7954	1031	Kissimmee	b	acdefgh
C. 407-553	ORLEFLGVDSO	7954	1031	Apopka	abcdefgh	
D. 407-554	ORLEFLGVDSO	7954	1031	Winter Garden	abcdefgh	
E. 407-556	ORLEFLGVDSO	7954	1031	St. Cloud	b	acdefgh
F. 407-562	ORLEFLGVDSO	7954	1031	Sanford		abcdefgh
G. 407-563	ORLEFLGVDSO	7954	1031	Orlando	abcdefgh	

2. VISTA Exchanges include:

NPA-NXX	End Office CLLI	EO Vert	EO Horz	Serving	Local	Toll
a. 407-560	LKBNFLXBDSO	7998	1041	LBV	ACDG	BEF
b. 407-566	LKBNFLXBDSO	7998	1041	Celebration	ABCDEG	F
c. 407-824	LKBNFLXBDSO	7998	1041	LBV	ACDG	BEF
d. 407-827	LKBNFLXBDSO	7998	1041	LBV	ACDG	BEF
e. 407-828	LKBNFLXBDSO	7998	1041	LBV	ACDG	BEF
f. 407-934	LKBNFLXBDSO	7998	1041	LBV	ACDG	BEF
g. 407-938	LKBNFLXBDSO	7998	1041	LBV	ACDG	BEF
h. 407-939	LKBNFLXBDSO	7998	1041	LBV	ACDG	BEF

ORDER NO. PSC-98-1525-FOF-TP
DOCKET NO. 981074-TP
PAGE 28

ATTACHMENT A
ATTACHMENT "B"

(Arrangement of the Facility Systems To Be Attached)

ATTACHMENT A

ATTACHMENT "B"

OC-12 SONET TO BELLSOUTH

7100 MUNICIPAL DR.

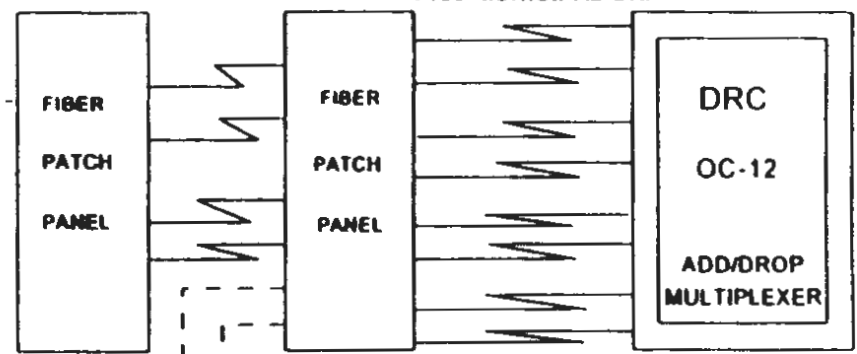

BELLSOUTH

SANDLAKE OFFICE

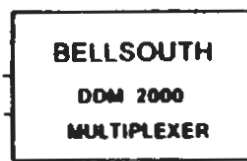

FIBER CABLE

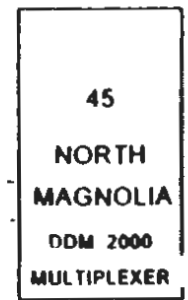

FLORIDA POWER CORP.

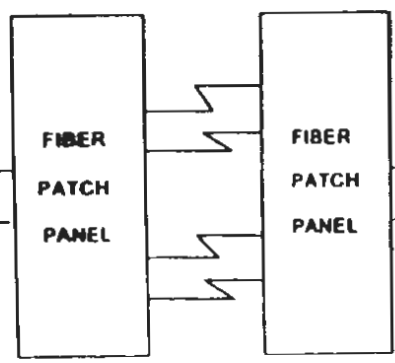

VISTA-UNITED TEL.

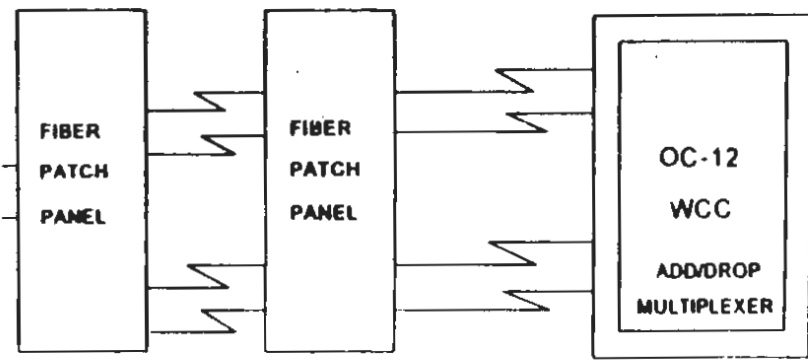

FIBER CABLE