

HOPPING GREEN SAMS & SMITH

PROFESSIONAL ASSOCIATION
ATTORNEYS AND COUNSELORS

123 SOUTH CALHOUN STREET
POST OFFICE BOX 6526
TALLAHASSEE, FLORIDA 32314

(850) 222-7500

FAX (850) 224-8551

FAX (850) 425-3415

Writer's Direct Dial No.
(850) 425-2313

April 26, 2000

GARY V. PERKO
MICHAEL P. PETROVICH
DAVID L. POWELL
WILLIAM D. PRESTON
CAROLYN S. RAEPPLE
DOUGLAS S. ROBERTS
D. KENT SAFRIET
GARY P. SAMS
TIMOTHY G. SCHOENWALDER
ROBERT P. SMITH
DAN R. STENGLE
CHERYL G. STUART
W. STEVE SYKES
OF COUNSEL
ELIZABETH C. BOWMAN

JAMES S. ALVES
BRIAN H. BIBEAU
RICHARD S. BRIGHTMAN
KEVIN B. COVINGTON
PETER C. CUNNINGHAM
RALPH A. DEMEO
RANDOLPH M. GIDDINGS
WILLIAM H. GREEN
WADE L. HOPPING
GARY K. HUNTER, JR.
JONATHAN T. JOHNSON
LEIGH H. KELLETT
ROBERT A. MANNING
FRANK E. MATTHEWS
RICHARD D. MELSON
ANGELA R. MORRISON
SHANNON L. NOVEY
ERIC T. OLSEN

BY HAND DELIVERY

Blanca Bayó
Director, Records and Reporting
Florida Public Service Commission
2540 Shumard Oak Boulevard
Tallahassee, FL 32399

000501-TP

RECEIVED-FPSC
00 APR 26 PM 3:07
RECORDS AND REPORTING

Re: Rhythms Links Inc. Petition for Arbitration
against BellSouth Telecommunications, Inc.

Dear Ms. Bayó:

Enclosed for filing on behalf of Rhythms Links Inc. are the original and fifteen copies of Rhythms' Petition for Expedited Arbitration against BellSouth Telecommunications, Inc.

By copy of this letter, this document is being furnished to the parties on the attached service list.

Very truly yours,

Richard D. Melson

Richard D. Melson

cc: Certificate of Service
Ms. Bedell
Ms. Keating
Mr. Dowds

RECEIVED & FILED

Mus
FPSC-BUREAU OF RECORDS

DOCUMENT NUMBER-DATE

05155 APR 26 8

FPSC-RECORDS/REPORTING

BEFORE THE FLORIDA PUBLIC SERVICE COMMISSION

In re: Petition of Rhythms Links Inc. for an Expedited Arbitration Award Implementing Line Sharing with BellSouth Telecommunications, Inc. pursuant to the Telecommunications Act of 1996.

Docket No. 000501-TP

Filed: April 26, 2000

RHYTHMS LINKS, INC. PETITION FOR EXPEDITED ARBITRATION

Pursuant to Section 252(b) of the Telecommunications Act of 1996 ("1996 Act"), Rhythms Links Inc. ("Rhythms") petitions the Florida Public Service Commission (the "Commission") for an expedited arbitration award on the unresolved line sharing issues between Rhythms and BellSouth Telecommunications, Inc. ("BellSouth").¹ Rhythms initiated negotiations, but has been unable to negotiate a line sharing amendment with BellSouth. Therefore, Rhythms petitions the Commission to issue an expedited arbitration award on the issues described below to ensure that line sharing is effectively available throughout the State of Florida on June 6, 2000, consistent with the Federal Communications Commission's ("FCC") Line Sharing Order.²

¹ Simultaneous with the filing of this Petition, Rhythms is filing a separate, but substantively similar, petition for arbitration against GTE Florida Incorporated ("GTE"), and Covad Communications Company ("Covad") is filing a separate, but substantively similar, petition for arbitration against both BellSouth and GTE. Indeed, the issues identified in this Petition are identical to those in Rhythms petition against GTE and to those included by Covad in its petition. Since the issues raised by, and the positions taken in, Rhythms' and Covad's petitions are the same, Rhythms urges the Commission to consolidate these arbitrations. Rhythms intends to file a separate Motion to Consolidate this Petition with Rhythms' other petition and with that filed by Covad.

² Deployment of Wireless Services Offering Advanced Telecommunications Capability, Third Report and Order in CC Docket No. 98-147 and Fourth Report and Order in CC Docket No. 96-98 (FCC 99-355) (rel. Dec. 9, 1999) ("Line Sharing Order").

DOCUMENT NUMBER-DATE

05155 APR 26 8

FPSC-RECORDS/REPORTING

I. PARTIES

1. Rhythms is an alternative local exchange carrier ("ALEC"), certificated by the Commission to provide local exchange services in the State of Florida. Rhythms' address is 6933 S. Revere Parkway, Englewood, Colorado 80112. Copies of notices, pleadings and documents in this proceeding should be provided to:

Richard D. Melson
HOPPING GREEN SAMS & SMITH
123 South Calhoun Street
P.O. Box 6526
Tallahassee, FL 32314
850.222.7500
850.224.8551 FAX
melsonr@hgss.com

Jeremy D. Marcus
Elizabeth Braman
BLUMENFELD & COHEN
– Technology Law Group
Suite 300
1625 Massachusetts Ave, NW
Washington, DC 20036
202.955.6300
202.955.6460 FAX
jeremy@technologylaw.com
elizabeth@technologylaw.com

Kimberley Scardino
Rhythms Links Inc.
c/o Blumenfeld & Cohen
Suite 300
1625 Massachusetts Avenue, NW
Washington, DC 20036

2. BellSouth is an incumbent local exchange carrier ("ILEC") providing telecommunications services to customers within its designated service areas in the State of Florida. A copy of this Petition is being served on Nancy White, c/o Nancy Sims, BellSouth Telecommunications, Inc., 150 South Monroe Street, Suite 400, Tallahassee, Florida 32301.

II. JURISDICTION OF THE COMMISSION

3. The Commission has jurisdiction over Rhythms' petition pursuant to Section 252 of the 1996 Act and Chapters 120 and 364, Florida Statutes.

III. BACKGROUND

4. Line sharing enables a competitive advanced services provider, such as Rhythms, to transmit digital subscriber line (“DSL”)-based services over the same loops by which BellSouth provides voice services to its customers. The tremendous consumer benefit of this arrangement cannot be overstated. Consumers can receive high-speed, high-capacity data and Internet access without waiting for the ILEC to install a separate loop dedicated to data services. Moreover, line sharing allows consumers to retain their desired local service provider while enjoying the benefits of competitively provided data services, all over a single loop. Line sharing thus truly provides the type of technological convergence that Congress envisioned in the 1996 Act.

5. Indeed, ILECs, including BellSouth, have been providing their own DSL services solely via line sharing arrangements for more than a year, while refusing to make this functionality available to ALECs.³ In this way, BellSouth has leveraged its local telephony monopoly into the nascent advanced services market, which the 1996 Act specifically intended to establish as a competitive market.⁴

A. The FCC’s Line Sharing Order

6. Recognizing the anticompetitive nature of the ILECs’ practice to provide line sharing for themselves but not for ALECs, the FCC found that the inability of ALECs to access the high frequency portion of the local loop “materially diminishes the ability of competitive LECs to provide certain types of advanced services to residential and small business users, delays broad facilities-based market entry, and materially limits

³ BellSouth Telecommunications, Inc., Tariff F.C.C. No. 1, BellSouth Transmittal No. 476 (Sept. 11, 1998).

⁴ Section 706 of the 1996 Act grants the FCC authority to ensure the rapid deployment of advanced services to all consumers.

the scope and quality of competitor service offerings.”⁵ Therefore, on December 9, 2000, the FCC, in its *Line Sharing Order*, determined that the high frequency portion of the local loop met the 1996 Act’s definition of a network element and ordered ILECs to provide unbundled access to ALECs according to Sections 251(d)(2) and (c)(3) of the Act.⁶ Noting “any delay in the provision of the high frequency portion of the loop will have a significant adverse impact on competition,”⁷ the FCC ordered ILECs to make line sharing available within 180 days of the release of its order.⁸ Thus, ILECs, including BellSouth, are obligated under the FCC’s *Line Sharing Order* to provide requesting carriers with unbundled access to the high frequency portion of the loop by June 6, 2000.

7. While Rhythms petitions the Commission to require BellSouth to provide line sharing consistent with its federal obligations, Rhythms urges the Commission to adopt line sharing as a matter of state law as well. A specific state requirement for line sharing is necessary based on previous BellSouth attempts to side step or delay their 1996 Act obligations in the individual states. This Commission clearly has the authority to require line sharing as a matter of state law under both Section 251 of the 1996 Act, which empowers state commissions to “establish [] access and interconnection obligations” of ILECs, as well as the FCC’s *UNE Remand Order*, which specifically interprets Section 251 as permitting state commissions to require ILECs to unbundle additional elements.⁹ Thus, the Florida Commission can, and should, order BellSouth to offer line sharing as an unbundled network element to Rhythms as a matter of state law as

⁵ *Line Sharing Order* at ¶ 5.

⁶ *Id.* ¶¶ 4-5.

⁷ *Id.* ¶¶ 161.

⁸ *Id.* (further noting that there may be interim measures that will allow access even before 180 days.)

well as federal law. By adopting line sharing as a matter of state law, this Commission will ensure that more Florida consumers have access to a greater choice in DSL services with faster installation and more ease than ever before.

B. Negotiations

8. On November 18, 1999, the same day that the FCC announced its *Line Sharing Order*, Rhythms sent, by overnight mail, a letter, pursuant to Section 252 of the 1996 Act, to BellSouth requesting interconnection agreement negotiations on line sharing.¹⁰ A copy of this letter is attached hereto at Exhibit "A." On November 22, 1999, BellSouth responded to Rhythms request for negotiation, stating that it would consider Rhythms' request to commence line sharing negotiations to be effective not when Rhythms made the request, but rather thirty (30) days after the *Line Sharing Order* was published in the Federal Register.¹¹ On December 10, 1999, Rhythms responded by inviting the BellSouth line sharing team to Rhythms headquarters in Denver at the date of BellSouth's choosing during the first two weeks of January 2000.¹² BellSouth did not substantively respond to Rhythms' invitation. Only on January 14, 2000, did BellSouth finally invite Rhythms, and other ALECs, to meet with BellSouth to begin to discuss its implementation of line sharing.¹³ At a meeting held on January 26, 2000, without having

⁹ *Implementation of the Local Competition Provisions of the Telecommunications Act of 1996*, CC Docket No. 96-98, Third Report and Order, FCC 99-238 at 11 (rel. Nov. 5, 1999) ("*UNE Remand Order*"); see also *id.* ¶¶ 163-168.

¹⁰ Letter from Jeremy D. Marcus, Counsel for Rhythms Links Inc., to Jerry Hendrix, Senior Director, BellSouth Telecommunications, Inc. (dated Nov. 18, 1999).

According to 47 U.S.C. § 252(c)(1), either party may file for arbitration between the 135th and 160th day from the date that the ILEC received the letter initiating negotiations. Therefore, Rhythms can file for arbitration between April 2, 2000 and April 27, 2000.

¹¹ Letter from Brian T. Campbell, BellSouth, to Jeremy D. Marcus, Counsel for Rhythms (dated Nov. 22, 1999) (attached hereto at Exhibit "B").

¹² Letter from Jeremy D. Marcus, Counsel for Rhythms, to Patricia C. Wanner, Manager-Interconnection Services Pricing, BellSouth (dated Dec. 10, 1999) (attached hereto at Exhibit "C").

¹³ Letter from Patricia C. Wanner, Manager-Interconnection Services Pricing, BellSouth, to Jeremy D. Marcus, Counsel for Rhythms (dated Jan. 14, 2000) (attached hereto at Exhibit "D").

taken any input from ALECs, BellSouth announced its plans to provide line sharing. BellSouth then began a series of (mostly) weekly meetings collectively with several ALECs, including Rhythms, designed to *trial* line sharing only. To date, BellSouth has yet to successfully install a single line sharing order from Rhythms or any other ALEC.

9. While BellSouth continued to host regular meetings to discuss the trialing of line sharing, BellSouth also insisted that Rhythms (and other ALECs) must execute a line sharing amendment to its existing interconnection agreement prior to June 6, 2000 or BellSouth would not provision any orders for line sharing as of June 6. Consequently, rather than waiting on BellSouth to start substantive negotiations, on March 31, 2000 Rhythms sent its proposed line sharing amendment language to BellSouth and requested that BellSouth provide Rhythms with the dates on which BellSouth would be willing to meet with Rhythms to negotiate the line sharing contract amendment.¹⁴ Having received no response by April 11, 2000, Rhythms again requested dates from BellSouth to begin negotiating the line sharing amendment proposed by Rhythms.¹⁵ Not only did BellSouth refuse to negotiate off of Rhythms' proposed language, but BellSouth failed to provide its proposed line sharing provisions until April 14, 2000,¹⁶ almost five (5) months after Rhythms sent its letter initiating line sharing negotiations. Moreover, BellSouth insisted that Rhythms must first redline BellSouth's proposed contract amendment before

¹⁴ Electronic mail message from Jeremy D. Marcus, Counsel for Rhythms, to Stephen Klimacek, Brian T. Campbell, and Tommy Williams, BellSouth (dated March 31, 2000) (attached hereto at Exhibit "E" (without e-mail attachment)).

¹⁵ Electronic mail message from Jeremy D. Marcus, Counsel for Rhythms, to Stephen Klimacek, Brian T. Campbell, and Tommy Williams, BellSouth (dated April 11, 2000) (attached hereto at Exhibit "F").

¹⁶ Electronic mail message from Brian T. Campbell, BellSouth, to Jeremy D. Marcus, Counsel for Rhythms (dated April 14, 2000) (attached hereto at Exhibit "G" (without e-mail attachment)).

BellSouth would commence negotiations with Rhythms.¹⁷ Thus, BellSouth effectively delayed the start of negotiations for over five (5) months.

10. By so egregiously delaying negotiations, BellSouth has jeopardized Rhythms' opportunity to access line sharing on nondiscriminatory terms and conditions in time to provide its DSL services over a shared line by June 6, 2000. In effect, BellSouth is attempting to constrain Rhythms to make the "Hobson's Choice" between signing BellSouth's initial, un-negotiated amendment or engaging in substantive negotiations for a more reasonable line sharing amendment, which would extend beyond the June 6 deadline. Neither of these options is acceptable and BellSouth should not be permitted to restrict Rhythms' right to aggressively offer its DSL services to a greater number of Florida consumers through line sharing. Because of BellSouth's delays, Rhythms must now exercise its statutory right and petition the Commission to arbitrate the issues associated with line sharing so that Rhythms is able to utilize line sharing to provide DSL services to Florida consumers beginning on June 6, 2000. In order to meet the June 6 deadline, Rhythms petitions the Commission for an expedited arbitration.

C. The Commission Should Conduct the Line Sharing Arbitration in Two Phases

11. Rhythms recognizes that the Commission may require the full statutory nine month arbitration period under Section 252(b)(4)¹⁸ to resolve all the line sharing related issues. Since the nine month resolution window extends to August 18, well beyond June 6, 2000, Rhythms requests that the Commission divide the arbitration into

¹⁷ *Id.*

¹⁸ "The State commission shall resolve each issue set forth in the petition and the response, if any, by imposing appropriate conditions as required to implement subsection (c) upon the parties to the agreement, and shall conclude the resolution of any unresolved issues not later than 9 months after the date on which the local exchange carrier received the request under this section." 47 U.S.C § 252(b)(4)(C).

two separate phases, and address the most critical and time sensitive line sharing issues prior to June 6, 2000.¹⁹

12. There is nothing in the 1996 Act that restricts the Commission's discretion to divide the issues in an arbitration and address them separately. Moreover, Rhythms proposal is consistent with the *Line Sharing Order's* recognition that, unless handled on an expedited basis, arbitrations could delay the availability of line sharing beyond June 6, 2000. In order to avoid any unnecessary delay, the FCC urged state commissions to grant petitions for expedited arbitration within an accelerated timeframe, and to include specific terms and conditions in the arbitration award to allow for the immediate deployment of line sharing.

We strongly encourage states to issue binding interim arbitration awards that would require the incumbent to begin provisioning this unbundled network element on interim arbitration terms and conditions within 180 days of release of this order. As detailed throughout this order, we have provided specific guidance for the states regarding arbitration awards. We believe that this is consistent with our goal of federal-state cooperation in facilitating the widespread deployment of advanced services.²⁰

Thus, Rhythms' Petition for an expedited arbitration on line sharing consistent with the spirit of the *Line Sharing Order* and will facilitate the deployment of line sharing by June 6, 2000. Therefore, the Commission can, and should, follow Rhythms' proposal to separate the line sharing arbitration issues into two phases in order to meet the June 6 deadline.

¹⁹ Section 252(b)(4) of the 1996 Act establishes the role of State commissions in arbitrations. Under this provision, a State commission may only resolve those issues included in the arbitration petition and any response, may require the arbitrating parties to provide any necessary information, and must resolve the arbitrated issues within nine months. The statute is silent, and thus leaves it to the State commission's discretion, on how the State commission should examine and consider the issues.

²⁰ *Line Sharing Order* ¶ 164.

13. The Commission should use Phase I to address the core issues for implementing line sharing by June 6, 2000. While these issues are detailed below, they include options for the ownership and location of the splitter, appropriate collocation cabling augmentation intervals, and recurring and nonrecurring rates for the necessary elements. Since these issues are fundamental prerequisites to line sharing, Rhythms urges the Commission to arbitrate these issues on a "fast track" and deliver a Phase I arbitration award in time for Rhythms to provide DSL services over a shared line by June 6, 2000.²¹

14. Specifically, for Phase I Rhythms proposes the Commission order Rhythms and BellSouth to submit all pre-filed testimony and/or other evidence, including BellSouth's cost-studies, work-papers and all supporting documents, on Phase I issues by May 5; to conduct hearings with full cross-examination on May 11th and 12th; to require Rhythms and BellSouth to file post-hearing briefs on May 23rd; and to issue a final decision by May 31st. While admittedly accelerated, Rhythms believes that this schedule is necessary in order for the Commission to issue a final decision in time for Rhythms to be able to use line sharing by June 6, 2000. Pursuant to this proposal, Rhythms has included in this Petition an issues list identifying the issues for arbitration in Phase I and in Phase II and the parties' positions on those issues,²² and has identified the relevant contract amendment sections for each issue.²³

²¹ While Rhythms prefers a permanent resolution on these issues, Rhythms recognizes that the Commission may find that in order to issue a Phase I award in time for the June 6 deadline, the award must be interim.

²² The issues identified herein are substantially identical to those contained in Covad's Petition.

²³ Rhythms' proposed High Bandwidth Line Sharing UNE Amendment to its existing interconnection agreement with BellSouth is attached hereto at Exhibit "H" and is incorporated herein by this reference.

15. Rhythms proposes that Phase II address the remaining line sharing issues that, while important to the long term and non discriminatory provision of DSL services over a shared voice line, are not a prerequisite to initiating line sharing by June 6. These issues address the effect of BellSouth's deployment of new technologies on Rhythms' ability to provide xDSL services utilizing line sharing, including the provision of line sharing over fiber fed digital loop carrier ("DLC") systems and Operations Support Systems ("OSS") (*i.e.*, interfaces for pre-ordering, ordering, provisioning and installation, billing and maintenance and repair) related issues. In addition, as part of its final arbitration award at the end of Phase II, Rhythms urges the Commission to adopt line sharing as a matter of state law.²⁴ In so doing, the Commission will ensure that more Florida consumers have access to a greater choice of DSL services with faster and easier installation than ever before.

16. While the issues identified herein and the attached contract amendment language incorporate these Phase II issues, Rhythms proposes to provide supporting testimony for these issues consistent with the following proposed procedural schedule for Phase II. Rhythms recommends that the Commission: require BellSouth to file an issues matrix, and both parties to file direct testimony during the 4th week in May (the week of May 22) and rebuttal testimony during the 2nd week of June (the week of June 5th); hold hearings during the 3rd and/or 4th week(s) in June (the weeks of June 19 and 26); require the parties to file briefs two weeks after the hearing concludes, thereby enabling the Commission to render a decision on this arbitration petition by August 2000. This

²⁴ A specific state requirement for line sharing is necessary based on previous attempts by ILECs to side step their federal obligations in the individual states.

schedule would allow the Commission to issue a decision within the statutory nine-month period.

IV. ISSUES FOR ARBITRATION

A. Phase I

17. The Phase I issues are quite straightforward. As noted above, BellSouth is already, and has been, line sharing at the retail level, for well over a year. Thus, BellSouth already established the technical feasibility of having POTS analog voice service and highband width DSL service occupy the same physical facility. As a result, the simple task for the Commission in this Phase I is to create the necessary conditions for Rhythms to be able to do what BellSouth is doing.

18. Phase I issues are fully captured in the attached interconnection agreement language and by the issues identified below. The rationales and justifications for the proposed language will be more fully explained in the various testimonies that Rhythms will file. As a result, this Petition simply and straight-forwardly summarizes these issues.

1. Network Architecture

19. The first general Phase I issue concerns the different network architectures available for line sharing. These architectures are addressed in Sections IV, V and VI of the proposed amendment language (Exhibit "H") and in Issues 1-3 below. Section IV of the amendment introduces the network configurations of Home Run Copper and fiber fed DLC systems, while Sections V and VI provide detailed provisions on the network topology and necessary elements for line sharing in these two environments. While both of these configurations are provided in the attachment, Rhythms recommends that the Commission limit Phase I to the Home Run Copper architecture, which is the networking

configuration most familiar to the Commission and the parties. In this configuration, the ALEC utilizes the high frequency portion of a copper loop from the customers' premises to the serving central office, and obtains its DSL signal via a copper handoff at that central office. According to the FCC's *Line Sharing Order*, BellSouth must provide this portion of the loop as an unbundled network element.²⁵

20. As identified in Issues 1-2 below, one of the primary network configuration issues in a Home Run Copper scenario is the placement and ownership of splitters. Splitters are the devices used to separate the analog POTS voice signal from the high-bandwidth DSL signal that is carried on the same physical loop facility. Splitters can be installed in a number of different locations, including in the ALEC's collocation arrangement, in an intermediate frame or bay located in a common area accessible to both the ALEC and BellSouth, and in a frame or bay located in BellSouth-controlled space inaccessible to the ALEC. It is also possible for either the ALEC or BellSouth to own and maintain the splitter.

21. As the proposed interconnection agreement amendment,²⁶ and issues identified below²⁷ reflect, Rhythms proposes a "menu" approach to splitter location and ownership. Depending on their business plans, ALECs may prefer different arrangements for splitter ownership and placement. For example, different ALECs may desire to obtain the use of a BellSouth owned splitter on a port-by-port or dedicated splitter ("shelf") basis. Likewise, other ALECs, such as Rhythms, may prefer to own the splitter and place it in its collocation line-up to ensure unfettered access and control over

²⁵ *Line Sharing Order* ¶¶ 16-19.

²⁶ This issue is addressed in Section V(2) of the proposed line sharing language.

²⁷ Splitter ownership and location is addressed in Issues 1-2 below.

the splitter. Only this menu approach allows ALECs to make the choice that best serves their competitive needs.

22. An additional network configuration issue concerns the appropriate interval for adding to, or augmenting, the facilities that connect to Rhythms' collocation facilities needed to support line sharing. These facilities, commonly called tie-cables or cross-connects are installed by BellSouth. Installation of these tie cables is a straightforward task, and can be accomplished within 30 calendar days, which is the interval proposed by Rhythms in the attached interconnection agreement language.²⁸

23. Finally, Phase I should encompass provisioning intervals for line sharing. Rhythms urges the Commission to adopt a phased provisioning interval that starts at three business days, and is subsequently reduced to one business day.²⁹

2. Rates

24. The availability of line sharing is only effective in increasing the availability of advanced services to the extent that the recurring and nonrecurring rates for line sharing are nondiscriminatory. Indeed, obtaining line sharing at a nondiscriminatory price is as competitively necessary as obtaining line sharing functionality in the first instance.

25. As a UNE, the high frequency portion of a loop must be priced in accordance with the Act's cost-based pricing requirement.³⁰ According to the FCC, it is "reasonable to presume that the costs attributed by LECs in the interstate tariff filings to the high-frequency portion of the loop cover the incremental costs of providing xDSL on

²⁸ Section V(2) of the proposed line sharing language and Issue 3 below.

²⁹ Provisioning intervals are included in Section VIII of the attached contract language and at Issue 5 below.

³⁰ *Line Sharing Order* ¶ 134; 47 U.S.C. § 252(d)(1).

a loop already in use for voice services.”³¹ Thus, BellSouth’s cost of the loop to provide its tariffed DSL services is the best evidence of the cost actually incurred by the loop for addition of those services. BellSouth has stated publicly that it is inappropriate to allocate loop costs among the services provided over a loop and that 100% of loop costs should be allocated to basic services.³² As such, use of the data channel of an existing loop does not create additional incremental cost burden to that loop. Stated otherwise, BellSouth has assigned a loop cost of \$0.00 to the aggregate cost of providing its federally tariffed DSL services. BellSouth’s determinations in this regard present the best evidence that the addition of data services to existing copper voice loops does not create or cause additional incremental cost to the loop. Therefore, the rate for the high frequency portion of the loop should be set at \$0.00.³³

B. Phase II

26. Phase II should address the effect of BellSouth’s deployment of new technologies on Rhythms’ ability to provide xDSL services through line sharing, including, line sharing over fiber fed DLC systems and OSS issues. Reserving the right to more fully explore these issues in subsequent testimony during Phase II, Rhythms provides a brief overview of these issues below.³⁴

27. Line sharing in a Fiber-Fed DLC configuration utilizes copper facilities from the customer premises to the ILEC’s Remote Terminal, and fiber facilities from the

³¹ *Line Sharing Order* ¶ 140.

³² BellSouth Telecommunications, Inc., Tariff F.C.C. No. 1, BellSouth Transmittal No. 476 (Sept. 11, 1998); *see also* Universal Service Fund, Transition to Phase II Pursuant to O.C.G.A. § 45-5-167, Georgia PSC Docket No. 5825-U, BellSouth Telecommunications, Inc.’s Responses to Commission Staff’s First Set of Interrogatories, Item Nos. 13 – 14 (Feb. 9, 2000).

³³ The monthly cost of the high frequency portion of the loop is Issue 9 below. Rhythms’ proposed rate for the tie cable and splitter are described in Section X of the attached interconnection agreement and supporting testimony.

³⁴ These issues are also included in the proposed contract language and the issues matrix.

Remote Terminal to the serving central office or other appropriate handoff point.

Different serving arrangements apply to this type of network configuration.

Nevertheless, because Rhythms believes that BellSouth will soon be using the Fiber-Fed DLC configuration, the arbitration decision and final interconnection agreement language must address both Home Run Copper and Fiber-Fed DLC configurations.

28. With regard to OSS, BellSouth already solved all of the issues associated with the pre-ordering, ordering, provisioning and installation, and testing, repair and maintenance functions related to the use of a single facility for two services. As a result, the simple task for the Commission in this arbitration is to create the necessary conditions for Rhythms to be able to do what BellSouth itself currently is doing. These issues are addressed in Sections VII, VIII, and IX of the attached interconnection agreement language, and will be supported further through later testimony. The language in these Sections of the attachment address the fact that at the current time, BellSouth is not ready to accept and process ALEC line sharing orders on a fully mechanized flow-through basis. As a result, Rhythms will address manual and semi-mechanized OSS interfaces. It should be noted, however, that BellSouth already deployed OSS changes that allow it to utilize fully mechanized flow-through techniques for its own tariffed line-shared services. Under the 1996 Act, non-discrimination and parity requirements mandate that ALECs have available to them equally efficient OSS, processes, and intervals. Thus, Rhythms' proposed interconnection agreement language also addresses ALECs' equal access to efficient electronic flow through OSS.

C. Positions of the Parties

29. The specific issues that Rhythms seeks the Commission to resolve and the positions of Rhythms and BellSouth relative to these issues are as follows:

1. *Phase I Issues*

30. Issue No. 1: Should BellSouth be required to provide a menu of three splitter network configurations to address CLECs' differing business needs in all requesting central offices by June 6, 2000?

Rhythms' Position: Yes. BellSouth should be required to offer the CLECs a menu of options for splitter ownership and location. The CLECs should be able to choose from the following options on a central office by central office basis: (1) the CLEC purchases and owns the splitter and places it in CLEC's collocation arrangement; (2) the CLEC purchases and provides the splitter, or specifies the splitter for BellSouth to obtain, and chooses to have the splitter placed in a common area in BellSouth's serving wire center to which the CLEC has access; and (3) BellSouth owns and obtains the splitter and locates it in an area in the serving wire center to which the CLEC does not have access (*e.g.*, on or adjacent to the frame).

Each CLEC should be able to choose among these options on an individual central office basis. Only with such flexibility will each CLEC be able to implement its individualized business plan to provide advanced services to consumers on a widespread basis. (*See* Exhibit "H", High Bandwidth Line Sharing UNE Attachment, Section V.A.2(i).)

BellSouth's Position: BellSouth has only agreed to the following splitter scenario: BellSouth owns and obtains the splitter and locates it in an area of the serving

wire center to which CLEC will have access. Further, BellSouth has agreed to consider whether it will permit CLECs to purchase and own the splitter to place the splitter in the CLEC's collocation arrangement but only after June 6, 2000.

31. Issue No. 2: If BellSouth owns the splitter, should it provide splitter functionality to CLECs on a line-at-a-time and/or shelf-at-a-time basis?

Rhythms' Position: Yes. BellSouth should be required to offer CLECs both options (line-at-a-time and/or shelf-at-a-time). Installation of tie cables is a simple task that ILECs already perform. Since the FCC's order requiring line sharing requires that line sharing be available by June 6, 2000, ILECs should be planning to proactively install a large number of tie cables and splitters necessary for line sharing on an expedited basis and in bulk. (*See* Exhibit "H", High Bandwidth Line Sharing UNE Attachment, Sections V.A.2(i)(a)(2-3).)

BellSouth's Position: BellSouth proposes that CLECs order splitter functionality in increments of 24 (one shelf) or 96 (4 shelves = an entire splitter).

32. Issue No. 3: Is thirty (30) calendar days the appropriate interval for collocation cabling augments to provide line-sharing?

Rhythms' Position: Yes. Installation of tie cables is a simple task that ILECs already perform. Because of the FCC's order requiring line sharing to be available by a date certain, ILECs should be planning to install a large number of cross-connects and splitters, necessary for line sharing on an expedited basis and in bulk. Installation of multiple tie cables can be done efficiently and quickly at any particular serving wire center, making the 30-day installation interval quite achievable. (*See* Exhibit "H", High Bandwidth Line Sharing UNE Attachment, Sections V.A.2(ii) and VI.D.)

BellSouth's Position: Collocation cabling augments for line sharing should be governed by standard collocation intervals.

33. Issue No. 4: Should BellSouth be required to provide CLECs with direct access to the shared physical loop for testing purposes at any technically feasible point?

Rhythms' Position: Yes. Where BellSouth owns the splitter, BellSouth should permit CLECs to perform maintenance, repair, and testing work on, and shall provide CLECs with access to, the splitter twenty-four hours a day, seven days a week. Where a CLEC owns the splitter, that CLEC may perform any necessary testing involving the splitter. In no event is BellSouth to perform work that interferes with the flow of data to a CLEC customer without first coordinating with the CLECs. CLECs should also have physical access to the loop 24 hours a day, 7 days a week. CLECs should also have the option to access any loop testing functionality available to BellSouth and/or its data affiliate, including remote testing access. (*See Exhibit "H", High Bandwidth Line Sharing UNE Attachment, Sections IX.A.2(ii) and IX.A.3.*)

BellSouth's Position: The testing of the high frequency portion of the loop is the CLEC's responsibility. BellSouth will provide CLECs with access to the shared loop only at the splitter and only for testing purposes 24 hours a day, seven days a week.

34. Issue No. 5: Should BellSouth be required to provide the Line Sharing UNE in a three business day interval from June 6 to September 6, in a two day business interval from September 7 to December 7, and in a one day business interval thereafter and a five business day interval for loops that require deconditioning?

Rhythms' Position: Yes. BellSouth should be required to complete the provisioning and installation of the Line Sharing UNE within three business days for the period between June 6 to September 6, two business days from September 7 to December 7, and one business day thereafter. If the CLEC requests de-conditioning of the Line Sharing UNE, the provisioning and installation interval should be extended by an additional two business days, or a five business day interval.

Since line sharing is provisioned on a loop that is already being used to provide voice services by BellSouth, other than back office changes to billing records and central office wiring, BellSouth should not need to perform a significant work effort to provide the line sharing UNE to the CLEC. In particular, a dispatch should not be necessary. Therefore, a phased interval schedule from three to one business days is reasonable. For these same reasons, the intervals proposed by BellSouth are unnecessarily long. (See Exhibit "H", High Bandwidth Line Sharing UNE Attachment, Section VIII.)

BellSouth's Position: BellSouth will provision the Line Sharing UNE is a three business day interval that commences only after BellSouth has provided the CLEC with a firm order confirmation ("FOC"). BellSouth is unwilling to commit to intervals where deconditioning is required.

35. Issue No. 6: What are the appropriate recurring and non-recurring charges for all elements of the line sharing UNE?

Rhythms' Position: A one time, nonrecurring fee of \$5.94 should be charged for installing jumpers, and an additional \$3.01 for additional jumpers. For removing jumpers, a one time, nonrecurring fee of \$1.80 should be charged. No recurring costs should be charged for adding or removing jumpers. Use of the BellSouth splitter should

be at a rate of \$0.94 per port, month of use. Rates for cross-connect should be per commission-approved cross-connect prices. Rhythms proposes a \$0.00 rate for utilizing the high frequency portion of the loop. Deconditioning of loops should be based on TELRIC's forward looking methodology, and accordingly cost \$0.00 for both recurring and nonrecurring charges. To pre-order loops, there should be \$0.00 monthly recurring charges and a non-recurring charge that has yet to be determined. Additionally, nonrecurring rates for ordering loops should be per commission approved mechanized service order charge. (See Exhibit "H", High Bandwidth Line Sharing UNE Attachment, Sections II.F and X.)

BellSouth's Position: BellSouth has not proposed to allocate any costs to the loop. BellSouth proposes a recurring cost for line sharing per line sharing splitter, per system with a 96 line capacity of \$172.02 with a nonrecurring cost of \$225.55. Per line sharing splitter, per system with a 24 line capacity, BellSouth proposes \$43.01 in recurring charges and \$225.55 for nonrecurring costs. Finally, per line sharing splitter per line activation, BellSouth proposes a recurring cost of \$6.96 with a nonrecurring rate of \$39.88.

2. *Phase II*

36. Issue No. 7: In addition to providing line sharing over home run copper loops, must BellSouth also allow CLECs to provide xDSL services utilizing line sharing on loops that traverse fiber-fed digital loop carrier ("DLC") systems between the remote terminal and the central office?

Rhythms' Position: Yes. BellSouth must provide CLECs with the ability to utilize line sharing on loops that traverse fiber-fed DLC systems as well as loops that

traverse home run copper. It is technically feasible today for BellSouth to provide line sharing over both types of loops to CLECs. Parity demands that BellSouth enable CLECs to utilize line sharing over loops deployed in BellSouth's new network architecture. Any other outcome would result in BellSouth creating a new monopoly in the provision of advanced services to end-user customers served by loops that traverse fiber-fed DLC systems.

The specifics of how BellSouth should be required to provide line sharing on fiber-fed DLC loops is contained in the Rhythms' proposed line sharing contract amendment language. (See Exhibit "H", High Bandwidth Line Sharing UNE Attachment, Sections III, IV.A, V.A.1-2, VI, VII.B, VIII.B, IX.B, and X.)

BellSouth's Position: No. BellSouth will not allow CLECs to provide xDSL services utilizing line sharing on loops that traverse fiber-fed DLC systems between the remote terminal and the central office. BellSouth believes that fiber-fed DLC is part of its packet-switching network and therefore it does not have to unbundle this portion of the loop.

37. Issue No. 8: Should CLECs have direct electronic access to BellSouth's operational support systems ("OSS")?

Rhythms' Position: Yes. In order to have nondiscriminatory access to the ILECs OSS, CLECs should have direct electronic access to these systems. According to the FCC's *Line Sharing Order* ILECs OSS already support the xDSL-based services currently offered by the ILECs. In order for CLECs to enjoy nondiscriminatory access to OSS, direct access to all five functionalities are required: pre-ordering, ordering, provisioning and installation, billing, and repair and maintenance. For example, during

pre-ordering, the CLECs should have both electronic and manual access to BellSouth's OSS that contain Loop Makeup Information (including BellSouth's databases such as LFACS and TIRKS), so that CLECs may access Loop Makeup Information directly and make their own determinations as to whether a particular loop is suitable for the services that the CLEC intend to provide over the loop. CLECs should also be able to access any Loop Makeup Information that either currently exists, or is being—or can be developed in the future—anywhere within BellSouth's OSS, and that can be accessed by any of BellSouth's personnel. Only when a CLEC is able to access such information will BellSouth be complying with its *FCC UNE Remand Order* and *FCC Line Sharing Order* obligations and will a CLEC be able to determine the type of service it will provide to a customer when that customer is on the line. CLEC's must have access to such pre-ordering functionalities no later than June 6, 2000.

Similarly, CLECs must be able to order loops using line sharing via a real-time, electronic interface. This electronic ordering capability must be integrated with BellSouth's pre-ordering functionality of providing Loop Makeup Information. In its Executive Summary in the *Line Sharing Order*, the FCC concluded that “[t]he record shows that incumbents should be able to resolve operational issues associated with implementation of line sharing, including modifications to operations support systems, within six months [*i.e.*, by June 6, 2000].” (*See Exhibit “H”, High Bandwidth Line Sharing UNE Attachment, Section VII.*)

BellSouth's Position: Today, BellSouth does not offer CLECs direct electronic access to its OSS to support ordering or provisioning of DSL loops including line sharing.

38. Issue No. 9: In order to consider the installation of the line sharing UNE complete, must BellSouth test and the CLEC affirmatively accept the line sharing UNE?

Rhythms' Position: Yes. BellSouth should be required to verify continuity and balance relative to tip and ring on the copper portion of the loop prior to providing a loop to a CLEC. If BellSouth requires this in order to provide voice services to its end-users, BellSouth should be able to satisfy this requirement by verifying and informing the CLEC that the loop is actively being used in the provision of voice services. Once BellSouth completes testing of continuity and line balancing, CLEC may either accept the line or may conduct its own testing. If, after conducting its own testing, the line-sharing UNE is not capable of providing xDSL services, Rhythms may refuse to accept the line, and may instead open a trouble ticket with the provisioning group of BellSouth.

ILECs should not consider installation of the Line Sharing UNE complete until the CLEC has affirmatively accepted the Line Sharing UNE. CLECs have often experienced situations in which an ILEC informs the CLEC that installation of a loop was complete, only to find that the loop was either defective or was not installed properly. Yet, the ILEC technician had indicated to both the ILEC and the CLEC that the installation was complete. This forced the CLEC to open a maintenance trouble ticket in the general maintenance population that contains all troubles, rather than in a more focused installation ticket. This has proven particularly troubling to CLECs because maintenance technicians are not always fully trained on the nuances of installation issues. (See Exhibit "H", High Bandwidth Line Sharing UNE Attachment, Sections VIII.A.4 and VIII.B.2.)

BellSouth's Position: No. BellSouth does not permit the CLEC to test and affirmatively accept the line sharing UNE. Rather, BellSouth will simply test the loop for its voice and provide the loop to the CLEC. The CLEC is then responsible for opening a maintenance ticket for any trouble.

39. Issue No. 10: What is the appropriate maintenance and repair time interval?

Rhythms' Position: In response to CLEC requests for repair of the line sharing UNE, the line cards in the DLC or splitter. BellSouth should accept maintenance trouble tickets and perform maintenance and repair on a 24/7 basis. BellSouth shall maintain a mean-time-to-repair interval of two hours, applied monthly. Further, where BellSouth owns the splitter and provides CLECs with access to the splitter, CLECs require 24-hour per day, 7-days per week access to the splitter and to the test head for maintenance, repair, and testing. (See Exhibit "H", High Bandwidth Line Sharing UNE Attachment, Section IX.)

BellSouth's Position: BellSouth will accept maintenance trouble tickets on a 24/7 basis, but will only work trouble tickets during normal business hours. BellSouth's interval for repairing line cards is unknown. When BellSouth owns the splitter, it provides the CLEC with access to the splitter on a 24/7 basis.

40. Issue No. 11: Should BellSouth pay for the cable that carries voice traffic from the CLEC's splitter back to BellSouth's main distribution frame ("MDF")?

Rhythms' Position: Yes. Where the CLEC owns the splitter, BellSouth should pay for the cost of the cable from the CLEC splitter to the MDF. The splitter serves as a point of interconnection between the BellSouth network and that of the CLEC. Each

party is responsible for the costs of getting its traffic to this point of interconnection, where it then hands off traffic to the other party. Once the hand-off occurs, the other party is responsible for the costs it incurs in transporting the traffic.

BellSouth's Position: BellSouth's position on this issue is unknown.

41. Issue No. 12: What if any charges for OSS upgrades should CLECs pay to ILECs to accommodate line sharing?

Rhythms' Position: CLECs should be required to pay for only those charges to OSS upgrades that are uniquely caused by CLECs ordering line sharing. (See Exhibit "H", High Bandwidth Line Sharing UNE Attachment, Section X.)

BellSouth's Position: BellSouth's position on this issue is unknown.

42. Issue No. 13: Should BellSouth be allowed to charge for de-conditioning (or sometimes referred to as "conditioning") a loop to provide line sharing and, if so, what should that charge be?

Rhythms' Position: No. BellSouth should not be allowed to charge CLECs to de-condition a loop. The FCC's mandated TELRIC methodology requires that rates, both recurring and non-recurring, be based on a least-cost, forward-looking, network design and be based on the same such network design. Moreover, the FCC's TELRIC methodology explicitly precludes the consideration of embedded costs, which load coils and excessive bridged taps represent. Instead, the FCC has found that prices for interconnection and unbundled network elements should be based on the cost of a "reconstructed local network" deploying "the most efficient technology for reasonably foreseeable capacity requirements." TELRIC-based pricing of unbundled network elements mimics the outcome that would occur if BellSouth faced effective competition

in the provision of unbundled network elements. For example, in a forward-looking network design load coils and excessive bridged taps would not be deployed.

Consequently, in a least-cost, forward-looking network, there would be no load coils or bridged taps to remove from a loop. Accordingly, BellSouth should not be permitted to assess de-conditioning charges to provide line sharing. (See Exhibit "H", High Bandwidth Line Sharing UNE Attachment, Sections VIII.A.3 and X.)

BellSouth's Position: Yes. BellSouth intends to charge for loop de-conditioning for all loops over 12,000 feet.

43. Issue No. 14: Should CLECs pay for BellSouth to determine whether a loop desired for line sharing is capable of providing DSL and, if so, what should that charge be?

Rhythms' Position: No. Just as with OSS rates generally, rates for access to Loop Makeup Information must be based on forward-looking systems. The Loop Makeup Information sought by the CLECs would be in the BellSouth system in a forward-looking environment; indeed, the BellSouth system already contains most, if not all, of this information. Therefore, in a forward-looking network, the cost of mechanized access to Loop Makeup Information is de minimis. (See Exhibit "H", High Bandwidth Line Sharing UNE Attachment, Sections VII.A.1-2, VII.B.1 and X.)

BellSouth's Position: Yes. BellSouth intends to charge CLECs for access to Loop Makeup Information.

44. Issue No. 15: Should BellSouth be prohibited from deploying new technologies or otherwise engaging in activities that impede CLEC's provision of xDSL services?

Rhythms' Position: Yes. BellSouth must not deploy any technology, including fiber deployment that will limit or otherwise impede in any manner CLECs' ability to deploy multiple voice, video, or other advanced services. BellSouth also must not migrate any end-user who is presently receiving CLEC data services over the high frequency portion of the loop without obtaining the prior written consent of CLEC. When a CLEC leases an unbundled network element, the CLEC has paid for the right to utilize that element. BellSouth does not have the right to unilaterally interrupt CLECs provision of service over that UNE. (See Exhibit "H", High Bandwidth Line Sharing UNE Attachment, Sections II.D and IV.C.2-3.)

BellSouth's Position: BellSouth's position on this issue is unknown.

45. Issue No. 16: Should BellSouth be required to share with CLECs its fiber DLC deployment plans?

Rhythms' Position: Yes. BellSouth must provide CLECs with copies of all technical specifications and network architecture information, including any Network Operation Plans and any draft or final Methods and Procedures, regarding any BellSouth-planned DLC or other network deployment that may impact CLEC's provision of xDSL loops or line sharing. (See Exhibit "H", High Bandwidth Line Sharing UNE Attachment, Section IV.C.1.)

BellSouth's Position: No. BellSouth will not provide CLECs with its fiber deployment plans.

V. CONCLUSION

46. For the foregoing reasons, Rhythms requests that the Commission commence an expedited arbitration with a decision in time to commence line sharing by June 6 on the Phase I issues of line sharing network configurations and rates. In addition, Rhythms petitions the Commission to adopt Rhythms proposed list of Phase II issues, including line sharing over a fiber fed DLC and OSS, as well as Rhythms proposed procedural schedule.

Respectfully submitted,

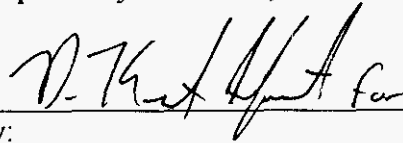

By:

Richard D. Melson
HOPPING GREEN SAMS & SMITH, P.A.
123 South Calhoun Street
P.O. Box 6526
Tallahassee, FL 32314
850.222.7500
850.224.8551 FAX
melsonr@hgss.com

Jeremy D. Marcus, Esq.
Elizabeth Braman, Esq.
BLUMENFELD & COHEN
– Technology Law Group
1625 Massachusetts Ave., N.W., Suite 300
Washington, D.C. 20036
202.955.6300
202.955.6460 facsimile
jeremy@technologylaw.com
elizabeth@technologylaw.com

Counsel for Rhythms Links Inc.

Dated: April 26, 2000

CERTIFICATE OF SERVICE

I HEREBY CERTIFY that a copy of the foregoing was served this 26 day of April, 2000, on the following:

Nancy White
c/o Nancy Sims
BellSouth Telecommunications, Inc.
150 South Monroe St.
Suite 400
Tallahassee, FL 32301

By Hand Delivery

Beth Keating
Division of Legal Services
Florida Public Service Commission
2540 Shumard Oak Boulevard
Tallahassee, FL 32399

By Hand Delivery



Attorney

BLUMENFELD & COHEN
SUITE 300
1625 MASSACHUSETTS AVENUE, NW
WASHINGTON, DC 20036

202.955.6300
FACSIMILE 202.955.6460

<http://www.technologylaw.com>
November 18, 1999

SUITE 1170
4 EMBARCADERO CENTER
SAN FRANCISCO, CA 94111
415.394.7500
FACSIMILE 415.394.7505

VIA FACSIMILE (404-529-7839) & FEDERAL EXPRESS

Jerry Hendrix
Senior Director
BellSouth Interconnection Services
BellSouth Telecommunications, Inc.
675 West Peachtree Street, NE
Atlanta, GA 30375

Dear Mr. Hendrix:

We represent Rhythms Links Inc. f/k/a ACI ("Rhythms"), a CLEC either providing or with plans to provide service in Alabama, Florida, Georgia, Kentucky, Louisiana, Mississippi, North Carolina and Tennessee. This letter constitutes Rhythms' formal request under sections 251 and 252 of the Telecommunications Act of 1996 to begin good faith negotiation of an interconnection agreement for line sharing or an amendment to its existing interconnection agreements with BellSouth for these states to provide for line sharing.

Rhythms seeks to negotiate in the most expeditious possible manner, and would therefore like to negotiate on a regional basis, as well as to ensure that an agreement is in place that would permit Rhythms to offer services over shared lines no later than six (6) months from the date of this letter. Rhythms negotiators will have authority to bind the company, and we expect that the BellSouth negotiators will similarly have the authority to bind BellSouth.

As time is of the essence for this amendment, we are prepared to meet within the next few days and would therefore appreciate a written response to this letter no later than November 23, 1999.

Sincerely,



Jeremy D. Marcus

Exhibit A

BLUMENFELD & COHEN

**cc: Ms. Tricia Wanner (via facsimile and Federal Express)
Ms. Mary Jo Peed (via facsimile and Federal Express)
BellSouth Telecommunications, Inc.**

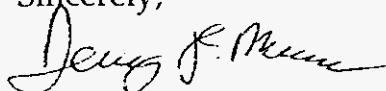
**Alabama Public Service Commission
Florida Public Service Commission
Georgia Public Service Commission
Kentucky Public Service Commission
Louisiana Public Service Commission
Mississippi Public Service Commission
North Carolina Utilities Commission
Tennessee Regulatory Authority**

BLUMENFELD & COHEN
SUITE 300
1625 MASSACHUSETTS AVENUE, NW
WASHINGTON, DC 20036

202.955.6300
FACSIMILE 202.955.6460

<http://www.technologylaw.com>
November 18, 1999

SUITE 1170
4 EMBARCADERO CENTER
SAN FRANCISCO, CA 94111
415.394.7500
FACSIMILE 415.394.7505

VIA FACSIMILE (404-529-7839) & FEDERAL EXPRESS

Jerry Hendrix
Senior Director
BellSouth Interconnection Services
BellSouth Telecommunications, Inc.
675 West Peachtree Street, NE
Atlanta, GA 30375

Dear Mr. Hendrix:

We represent Rhythms Links Inc. f/k/a ACI ("Rhythms"), a CLEC either providing or with plans to provide service in Alabama, Florida, Georgia, Kentucky, Louisiana, Mississippi, North Carolina and Tennessee. This letter constitutes Rhythms' formal request under sections 251 and 252 of the Telecommunications Act of 1996 to begin good faith negotiation of an interconnection agreement for line sharing or an amendment to its existing interconnection agreements with BellSouth for these states to provide for line sharing.

Rhythms seeks to negotiate in the most expeditious possible manner, and would therefore like to negotiate on a regional basis, as well as to ensure that an agreement is in place that would permit Rhythms to offer services over shared lines no later than six (6) months from the date of this letter. Rhythms negotiators will have authority to bind the company, and we expect that the BellSouth negotiators will similarly have the authority to bind BellSouth.

As time is of the essence for this amendment, we are prepared to meet within the next few days and would therefore appreciate a written response to this letter no later than November 23, 1999.

Sincerely,



Jeremy D. Marcus

Exhibit A

BLUMENFELD & COHEN

**cc: Ms. Tricia Wanner (via facsimile and Federal Express)
Ms. Mary Jo Peed (via facsimile and Federal Express)
BellSouth Telecommunications, Inc.**

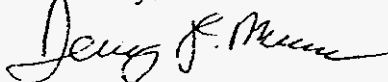
**Alabama Public Service Commission
Florida Public Service Commission
Georgia Public Service Commission
Kentucky Public Service Commission
Louisiana Public Service Commission
Mississippi Public Service Commission
North Carolina Utilities Commission
Tennessee Regulatory Authority**

Kodak 2110 Duplicator Key Sheet



Subset Staple - Upper Left

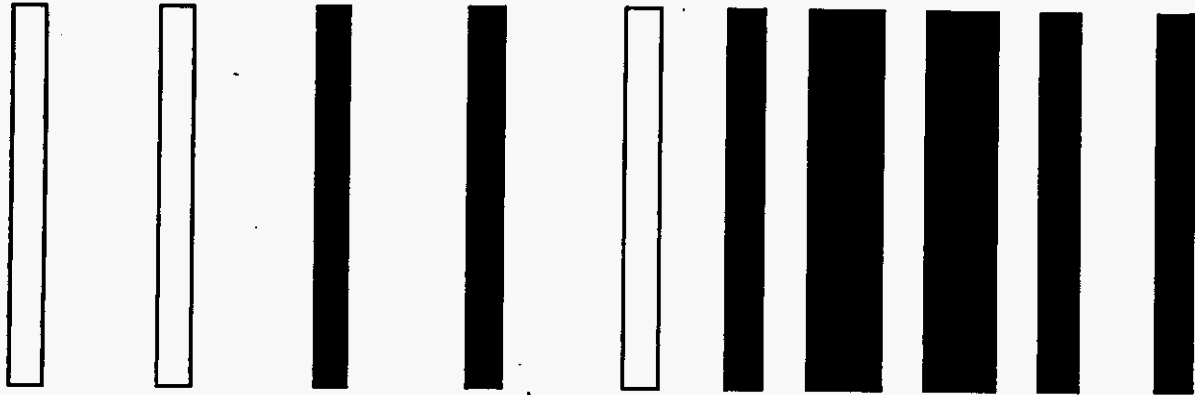

O P E R A T O R

I N S T R U C T I O N S

- Place the Key Sheet in front of the section to be stapled in upper left corner.

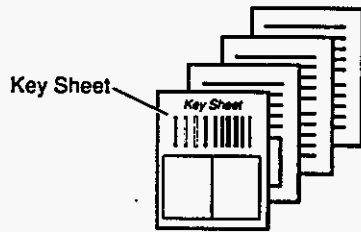

- Place your originals and Key Sheets in the feeder face up and make your Standard Features selections. Select Finisher paper exit.

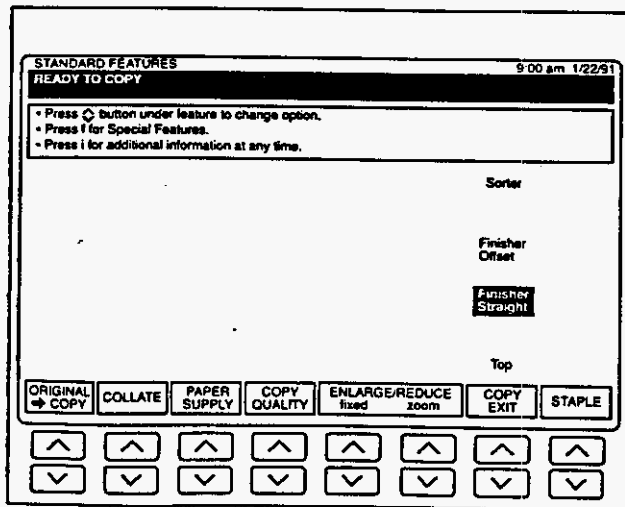

- Press "Star" then "Start" to activate the Key Sheet.

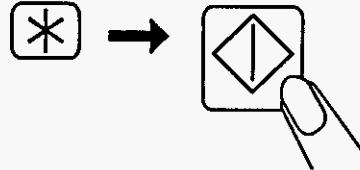

Note: The Key Sheets will exit into the positioner exit hopper. Copies of this Key Sheet may also be used.

BellSouth Interconnection Services

675 West Peachtree Street
Room 34S91
Atlanta, Georgia 30375

Patricia Wanner
404-927-1245
Fax #: 404-529-7839

November 22, 1999

Mr. Jeremy Marcus
Blumenfeld & Cohen
1625 Massachusetts Ave. NW
Suite 300
Washington D.C. 20036

Dear Mr. Marcus:

This letter is in response to your letter dated November 18, 1999, addressed to Mr. Jerry Hendrix, Senior Director – BellSouth Interconnection Services, wherein you request access to the high frequency portion of BellSouth’s UNE loops. BellSouth is aware of the FCC’s Advanced Services Third Report and Order pertaining to “Line Sharing” and the requirements established therein. The requirements set forth in the Order will go into effect thirty (30) days from publication in the Federal Register. BellSouth will consider your request effective the day the Order is effective.

BellSouth would like to demonstrate its willingness to negotiate in good faith by arranging an informal meeting with Rhythms Links, Inc. regarding this issue. BellSouth looks forward to a positive meeting that will establish the foundation for productive negotiations. If you wish to discuss this issue further, feel free to contact me at your earliest convenience.

Sincerely,

Brian T. Campbell
for Patricia Wanner

Patricia Wanner
Manager - Interconnection Services/Pricing

BLUMENFELD & COHEN
SUITE 300
1625 MASSACHUSETTS AVENUE, NW
WASHINGTON, DC 20036

202.955.6300
FACSIMILE 202.955.6460
<http://www.technologylaw.com>

SUITE 1170
4 EMBARGADERO CENT
SAN FRANCISCO, CA 94102
415.394.7500
FACSIMILE 415.394.7500

December 10, 1999

via **FEDERAL EXPRESS**

Ms. Patricia Wanner
Manager – Interconnection Services/Pricing
BellSouth Telecommunications, Inc.
Room 34S91
675 West Peachtree Street
Atlanta, GA 30375

Dear Ms. Wanner:

This letter is in response to your letter dated November 22, 1999 in which BellSouth Telecommunications, Inc. (“BellSouth”) responded to Rhythms Links Inc.’s (“Rhythms”) November 18, 1999 request to begin good faith negotiations of an interconnection agreement for line sharing or an amendment to its existing interconnection agreements with BellSouth to provide for line sharing.

Rhythms is encouraged by BellSouth’s statement in its November 22 letter that it is willing to meet with Rhythms “. . . to demonstrate its willingness to negotiate in good faith . . .” Rhythms is prepared to commence negotiations immediately. However, in light of the rapidly approaching holiday season and presuming that several of the BellSouth personnel necessary to such negotiations likely have vacation plans during this time, Rhythms proposes beginning formal negotiations in January. Therefore, Rhythms cordially invites BellSouth to bring its line sharing negotiation team to Denver, Colorado during the first two weeks in January 2000 to begin these negotiations. We request that you respond as soon as possible with two or three dates that the BellSouth negotiation team is available to meet with Rhythms during this time so that we can agree to a date (from your proposed list) expeditiously.

If you have any questions, please call. Thank you for your prompt attention.

Sincerely,



Jeremy D. Marcus
Counsel for Rhythms Links Inc.

Exhibit C

BLUMENFELD & COHEN

Patricia C. Wanner Letter
December 9, 1999
Page 2

cc: Stephen M. Klimacek, Esq. (via Federal Express)
BellSouth Telecommunications, Inc.
Mr. Robert Williams
Kristin Smith

BellSouth Interconnection Services

675 West Peachtree Street
34 S 91
Atlanta, Georgia 30375

Patricia C. Wanner
(404) 927-1245
Fax: (404) 529-7839

VIA E-MAIL & US MAIL

January 14, 2000

Mr. Jeremy Marcus
Counsel for Rhythms Links Inc.
Blumenfield & Cohen.
Suite 300
1625 Massachusetts Ave., NW
Washington, DC 20036

Dear Jeremy:

This letter is in response to your letter dated November 18, 1999 on behalf of Rhythms Links wherein you requested negotiations for access to the high frequency portion of BellSouth's UNE loops, also known as line sharing. BellSouth is prepared to negotiate terms and conditions for line sharing.

BellSouth would like to extend the offer of working in a collaborative effort with all CLECs interested in negotiating terms and conditions for line sharing; not unlike the collaborative effort used in Minnesota. The first collaborative line sharing meeting has been scheduled for the afternoon of January 26, 2000. The meeting will take place in Atlanta, Georgia at BellSouth Center. Please consider this as our invitation for Rhythms to attend this meeting.

BellSouth believes that a united effort with CLECs can only benefit all parties. We hope Rhythms will participate in this effort, and believe your input will be valuable and beneficial to all parties involved.

Please respond at your earliest convenience. If you would like to talk further about this, I can be reached on 404-927-1245.

Sincerely,



Patricia C. Wanner
Manager



Subject: Rhythms proposed line sharing amendment

Date: Thu, 30 Mar 2000 23:41:36 -0500

From: Jeremy Marcus <jeremy@technologylaw.com>

Organization: Blumenfeld & Cohen - Technology Law Group



To: "Klimacek, Stephen" <Stephen.Klimacek@BellSouth.COM>
 "Brian.Campbell@bridge.bellsouth.com" <Brian.Campbell@bridge.bellsouth.com>
 "Tommy.G.Williams@bridge.bellsouth.com" <Tommy.G.Williams@bridge.bellsouth.com>
 "Rob Williams (E-mail)" <rwilliams@rhythms.net>, "dhsiao@rhythms.net" <dhsiao@rhythms.net>
 "Rob Williams (E-mail)" <rwilliams@rhythms.net>, "kristin@technologylaw.com" <kristin@technologylaw.com>
 dick schell <rschell@rhythms.net>

Steve/Brian/Tommy,

Attached please find Rhythms Links Inc.'s proposed line sharing amendment to Rhythms existing interconnection agreement with BellSouth. Please review the attached and provide us with several possible dates and times to meet to negotiate this amendment. As June 6 is fast approaching, Rhythms appreciates your prompt response. Thanks you.

Jeremy

Jeremy D. Marcus, Esq.
 Blumenfeld & Cohen -- Technology Law Group
 Suite 300
 1625 Massachusetts Avenue, NW
 Washington, DC 20036
 (202) 955-6300
 (202) 955-6460 (fax)

 Rthm Model LS lang final.doc	Name: Rthm Model LS lang final.doc Type: Microsoft Word Document (application/msword) Encoding: base64 Description: Unknown Document
 Line_Sharing_Final.ppt	Name: Line_Sharing_Final.ppt Type: application/ms-powerpoint (application/ms-powerpoint) Encoding: base64 Description: Unknown Document

Subject: Re: Rhythms proposed line sharing amendment

Date: Tue, 11 Apr 2000 14:58:08 -0400

From: Jeremy Marcus <jeremy@technologylaw.com>

Organization: Blumenfeld & Cohen - Technology Law Group

To: "Klimacek, Stephen" <Stephen.Klimacek@BellSouth.COM>
"Brian.Campbell@bridge.bellsouth.com" <Brian.Campbell@bridge.bellsouth.com>,
"Tommy.G.Williams@bridge.bellsouth.com" <Tommy.G.Williams@bridge.bellsouth.com>,
"Rob.Williams (E-mail)" <rwilliams@rhythms.net>, "dhsiao@rhythms.net" <dhsiao@rhythms.net>,
Elizabeth.Braman <elizabeth@technologylaw.com>, dick.schell <rschell@rhythms.net>,
jim.scheltema <jim@technologylaw.com>

References: 1

Steve/Brian/Tommy,

We have heard no response from BellSouth about negotiating the permanent line sharing amendment to Rhythms' interconnection agreement with BellSouth. Again, as June 6 is fast approaching and because BellSouth has told Rhythms that a line sharing amendment must be negotiated prior to June 6 in order for BellSouth to process line sharing orders as of June 6, it is imperative that we begin negotiations quickly. Please provide several dates on which the BellSouth team is able to meet to negotiate with Rhythms. Rhythms is willing to travel to Atlanta or to host these meetings in Washington, DC.

Jeremy

Jeremy Marcus wrote:

>
> Steve/Brian/Tommy,
>
> Attached please find Rhythms Links Inc.'s proposed line sharing
> amendment to Rhythms existing interconnection agreement with BellSouth.
> Please review the attached and provide us with several possible dates
> and times to meet to negotiate this amendment. As June 6 is fast
> approaching, Rhythms appreciates your prompt response. Thanks you.

> Jeremy

>
> _____
> Jeremy D. Marcus, Esq.
> Blumenfeld & Cohen -- Technology Law Group
> Suite 300
> 1625 Massachusetts Avenue, NW
> Washington, DC 20036
> (202) 955-6300
> (202) 955-6460 (fax)

>
> -----
> Name: Rthm Model LS lang final.doc
> Rthm Model LS lang final.doc Type: Microsoft Word Document (application/msword)
> Encoding: base64
> Description: Unknown Document
>
> Name: Line_Sharing_Final.ppt
> Line_Sharing_Final.ppt Type: application/ms-powerpoint (application/ms-powerpoint)
> Encoding: base64
> Description: Unknown Document

--

Jeremy D. Marcus, Esq.
Blumenfeld & Cohen -- Technology Law Group
Suite 300
1625 Massachusetts Avenue, NW
Washington, DC 20036
(202) 955-6300
(202) 955-6460 (fax)

Subject: Rhythms proposed line sharing amendment

Date: Fri, 14 Apr 2000 13:38:05 -0500

From: Brian.Campbell@bridge.bellsouth.com

To: jeremy@technologylaw.com

CC: Stephen.Klimacek@BellSouth.COM, Patricia.C.Wanner@bridge.bellsouth.com, Tommy.G.Williams@bridge.bellsouth.com



Jeremy:

Attached is BellSouth's proposed amendment to your Interconnection Agreement incorporating unbundled access to the High Frequency Spectrum of the loop. Once you have had an opportunity to review it, please provide us with a redlined revision addressing Rhythms' issues. At that point, I believe we can establish a meeting to begin negotiations.

I am also aware that you requested an interim amendment for the provision of splitter ordering. I am in the process of revising our proposal and will provide it to you either Monday, April 14 or Tuesday, April 15.

If you need to discuss anything, feel free to contact me at 404-927-7596.

Brian Campbell
Manager- BellSouth

	FINAL.DOC	Name: FINAL.DOC Type: Microsoft Word Document (application/msword) Encoding: base64
--	------------------	--

**HIGH BANDWIDTH LINE SHARING UNE AMENDMENT
TO THE INTERCONNECTION AGREEMENT
BETWEEN BELL SOUTH TELECOMMUNICATIONS, INC. AND [CLEC]
DATED [INSERT DATE]**

Pursuant to this Agreement, (the "High Bandwidth Line Sharing UNE Amendment"), [CLEC] ("CLEC") and BellSouth Telecommunications, Inc. ("BellSouth"), hereinafter referred to individually as a "Party" and collectively as the "Parties," hereby agree to amend that certain Interconnection Agreement between the Parties dated [INSERT DATE] (the "Interconnection Agreement") for the State of Florida.

WHEREAS, CLEC and BellSouth entered into an Interconnection Agreement on [DATE], and

WHEREAS, CLEC and BellSouth seek to implement the Federal Communications Commission's ("FCC") Third Report and Order in CC Docket No. 98-147 and Fourth Report and Order in CC Docket No. 96-98 (released December 9, 1999) (FCC 99-355) ("Line Sharing Order"), including the implementation deadlines specified therein;

WHEREAS, CLEC and BellSouth seek to implement the FCC's Third Report and Order in CC Docket No. 96-98 (released November 5, 1999) (FCC 99-238) ("UNE Remand Order") as it relates to High Bandwidth Services;

NOW THEREFORE, in consideration of the mutual provisions contained herein and other good and valuable consideration, the receipt and sufficiency of which are hereby acknowledged, the Parties hereby covenant and agree as follows:

1. This High Bandwidth Line Sharing UNE Amendment, including without limitation the High Bandwidth Line Sharing UNE Attachment attached hereto, which is incorporated herein by this reference, sets forth the rights and obligations of each Party with respect to the rates, terms and conditions for High Bandwidth Services provided via Line Sharing.

2. The Parties agree that they intend for the High Bandwidth Line Sharing UNE Amendment to be construed and interpreted broadly by the Parties. The Parties further agree that the High Bandwidth Line Sharing UNE Amendment shall be construed and interpreted by the Parties to enable CLEC to offer the broadest possible array of advanced services to consumers in the State of Florida.

3. The Parties agree that they shall apply the High Bandwidth Line Sharing UNE Amendment to current technologies and to future technologies as they become available, regardless of whether or not BellSouth or BellSouth's data affiliate chooses to deploy such technology(ies).

4. The Interconnection Agreement entered into between BellSouth and CLEC is hereby amended to add this High Bandwidth Line Sharing UNE Amendment as a new Appendix to the Interconnection Agreement.

5. Capitalized terms used but not otherwise defined herein have the meanings ascribed to them in the Interconnection Agreement.

6. This High Bandwidth Line Sharing UNE Amendment shall have an effective date of June 6, 2000 and shall be coterminous with the Interconnection Agreement.

7. This High Bandwidth Line Sharing UNE Amendment, together with its preamble and recitals and with any exhibits, schedules, appendices or other attachments hereto, each of which is incorporated by this reference, sets forth the entire understanding of the Parties, supersedes all prior agreements between the Parties to the extent they relate to the subject matter contained herein, and merges all prior discussions between the Parties.

8. If any provision(s) of this High Bandwidth Line Sharing UNE Amendment conflicts or is otherwise inconsistent with any provision(s) of the Interconnection Agreement or with any provision(s) of any of the federal tariffs or schedules or state tariffs or schedules of BellSouth, the provision(s) of this High Bandwidth Line Sharing UNE Amendment shall control.

9. All of the other provisions of the Interconnection Agreement, dated [insert date], shall remain in full force and effect.

10. Either or both of the Parties may submit this High Bandwidth Line Sharing UNE Amendment to the Florida Public Service Commission (the "Commission") for approval subject to Section 252(e) of the Federal Telecommunications Act of 1996.

IN WITNESS WHEREOF, the Parties hereto have caused this High Bandwidth Line Sharing UNE Amendment to be executed by their respective duly authorized representatives on the date(s) indicated below.

[FULL CLEC NAME]

BellSouth Telecommunications, Inc.

By: _____

By: _____

Name: _____

Name: _____

Title: _____

Title: _____

Date: _____

Date: _____

HIGH BANDWIDTH LINE SHARING UNE ATTACHMENT

I. Purpose

- A. This High Bandwidth Line Sharing UNE Attachment ("Attachment") sets forth the rates, terms and conditions pursuant to which BellSouth will provide the services, network elements and interconnection components necessary for CLEC to provide High Bandwidth Services utilizing Line Sharing to customers in the State of Florida.

II. Scope

- A. BellSouth shall make available to CLEC the services, network elements and interconnection components described in this High Bandwidth Line Sharing UNE Attachment at the rates, terms and conditions set forth herein.
- B. The Parties agree that they will interpret, implement and apply the provisions of this Attachment broadly, in a manner enabling CLEC to provide the broadest possible array of High Bandwidth Services to customers in the State of Florida, through the use of Line Sharing.
- C. The Parties agree that they will interpret, implement and apply the provisions of this Attachment to current technologies and to future technologies as they become available, regardless of whether BellSouth or the data affiliate of BellSouth has deployed or chooses to deploy such technology(ies).
- D. The Parties agree that pursuant to this Attachment CLEC may deploy any High Bandwidth or advanced services technology that (i) complies with industry standards; (ii) is approved by an industry standards body, the FCC or any state commission; or (iii) has been (at the time CLEC is seeking deployment) successfully deployed by any carrier in any state. BellSouth shall permit deployment of any technology meeting any of these three (3) criteria unless BellSouth has obtained from the Florida Public Service Commission an order or other decision concluding that the deployment of the particular technology will significantly degrade the performance of other advanced services or traditional voice band services. As of the effective date of this High Bandwidth Line Sharing UNE Attachment, BellSouth shall permit CLEC to deploy any technology meeting any one of the above three (3) criteria, including without limitation Asynchronous Digital Subscriber Line ("ADSL"), Rate-Adaptive ADSL ("RADSL"), Multiple Virtual Lines ("MVL"), and G.Lite.

- E. BellSouth shall make available the services, network elements and interconnection components described herein to CLEC at rates, terms and conditions detailed herein. Such rates, terms and conditions shall be at least equal to those provided by BellSouth to itself, to any BellSouth Affiliate (including without limitation BellSouth's data affiliate), to any other telecommunications carrier, to any BellSouth customer or end-user, or to any other party.
- F. The Parties agree that the rates and charges for any services, unbundled network elements or interconnection components contained herein are all-inclusive, and, with the sole exception of any applicable collocation rates, no other rates or charges shall apply.

III. Definitions

- A. High Bandwidth Line Sharing Unbundled Network Element ("HBL S UNE") is an unbundled network element that utilizes Line Sharing on a twisted copper pair when entering the end-user premises, and that provides for a hand-off of High Frequency traffic to CLEC at any technically feasible point specified by CLEC, over which CLEC may provide High Bandwidth Services to the end-user.
- B. High Bandwidth Services are services with a transmission rate of at least 128 kilobits per second.
- C. Line Sharing is a method by which CLEC provides High Bandwidth Services (i) that allows for CLEC, as a second carrier, to use the same copper twisted pair wire that serves a particular end-user customer as is used by said end-user customer to obtain voice services from the voice provider carrier (*i.e.*, the first carrier); (ii) that uses the frequency spectrum above the voice channel on said copper pair wire (*i.e.*, above 4000 Hz ("High Frequency")); and (iii) that provides for a hand-off of High Frequency traffic from BellSouth to CLEC at any technically feasible point specified by CLEC.
- D. Permanent Virtual Circuit ("PVC") is a logical communication path that provides the equivalent of a dedicated physical point-to-point path over an Asynchronous Transfer Mode ("ATM") packet switching network.
- E. Permanent Virtual Path ("PVP") is an ATM logical communications path that comprises multiple PVCs.
- F. Quality of Service refers to performance specifications for ATM service defined by the ATM Forum and the ITU-T. PVPs and PVCs shall be provided to CLEC at all of the following options: ITU-T Quality of Service Classes A, B, C, and D; ATM Forum Quality of Service Classes 1,

2, 3, and 4; and Service Class Categories Available Bit Rate, Constant Bit Rate, Variable Bit Rate – real time, Variable Bit Rate – not real time, and Unspecified Bit Rate.

- G. Remote Terminal means a controlled environmental vault, fiber hut, cabinet or other structure equipped with fiber-fed Digital Loop Carrier (“DLC”) equipment.

IV. Network Configurations

- A. BellSouth shall enable and allow CLEC to provide High Bandwidth Services utilizing either of the following network configurations for the HBL5 UNE:
 - 1. Home Run Copper – Home Run Copper consists of an all-copper pair between an end-user customer demarcation location and the Main Distribution Frame in BellSouth’s serving wire center that is jumpered and cross-connected to a CLEC collocation arrangement located in said serving wire center. Figures 1-3 (attached at the end of this Attachment) depict a diagram of this configuration. The specific terms and conditions for this configuration are contained in Section V – Home Run Copper (below); and
 - 2. Fiber-Fed DLC – Fiber-Fed DLC consists of an all-copper pair from the end-user customer demarcation location to a Remote Terminal, and fiber from the Remote Terminal to CLEC’s designated point of interconnection. Figure 4 (attached at the end of this Attachment) depicts a diagram of the possible Fiber-Fed DLC configurations. The specific terms and conditions for these configurations are contained in Section VI – Fiber-Fed DLC (below).
- B. In any instance in which CLEC is using Line Sharing to provide High Bandwidth Services, CLEC is responsible for providing the end-user with, and is responsible for the installation and maintenance of, a filter(s) or other customer premises equipment necessary for the end-user to receive separate voice and High Bandwidth Services across the same loop. CLEC shall determine the necessary customer premises equipment.
- C. BellSouth Network Deployment
 - 1. BellSouth shall provide CLEC, upon CLEC’s request, with copies of all technical specifications and network architecture information, including without limitation any Network Operation Plans and any draft or final Methods and Procedures, regarding any BellSouth planned DLC deployment that may impact CLEC’s

provision of any of the services, network elements or interconnection components described in this Attachment. For purposes of this BellSouth obligation, "planned DLC deployment" includes, but is not limited to, any BellSouth plans (i) covering the then-subsequent two year period, (ii) included or referenced in any BellSouth filing with the Securities and Exchange Commission; or (iii) included in any information provided as a matter of course to BellSouth shareholders or other investors (e.g., proxy statements, annual reports).

2. BellSouth agrees that it will not deploy any technology, including without limitation any Remote Terminal or DLC deployment (e.g., limiting PVCs to Unspecified Bit Rate transmissions), that will limit or otherwise impede in any manner whatsoever CLEC's ability to deploy multiple voice, video or other advanced services.
3. BellSouth agrees that it will not migrate any existing CLEC end-user customer that is then obtaining High Bandwidth Services from CLEC over an HBLS UNE using Home Run Copper to an HBLS UNE using Fiber-Fed DLC without first obtaining the prior, written consent of CLEC. CLEC agrees to not unreasonably withhold such consent, but may not be required by BellSouth to provide such consent. In instances where CLEC provides such consent, BellSouth and CLEC agree to work cooperatively to minimize any end-user customer downtime during any migration from the Home-Run-Copper-based HBLS UNE to the Fiber-Fed-DLC-based HBLS UNE.

V. Home Run Copper

A. Network Topology – This Section provides a description of the HBLS UNE when the HBLS UNE is provided over Home Run Copper.

1. BellSouth shall make available to CLEC HBLS UNEs provided over Home Run Copper (depicted in Figures 1-3). When provided over Home Run Copper, the HBLS UNE shall consist of the High Frequency portion of an all-copper pair that runs from the demarcation point at the end-user customer location to BellSouth's serving wire center. At the serving wire center, BellSouth shall connect the HBLS UNE to a CLEC tie cable via a BellSouth-provided jumper; provided, however, that CLEC must first have obtained said tie cable from BellSouth to connect to CLEC's collocation arrangement.
2. The Parties agree that CLEC may utilize Line Sharing to provide High Bandwidth Services over an HBLS UNE provided over

Home Run Copper; provided, however, that CLEC must obtain access to a voice and data splitter in order to so utilize Line Sharing.

(i) Splitters.

(a) The Parties agree that CLEC may obtain access to the voice and data splitter via any of the following three scenarios. The Parties further agree that CLEC will choose, at its sole option and discretion, which of these three scenarios it will use at each particular serving wire center.

- (1) Splitter Located in the Collocation Arrangement of CLEC (depicted in Figure 1). CLEC may choose to obtain the splitter directly and place the splitter in its collocation arrangement. CLEC shall purchase and own the splitter. In this scenario, both the non-CLEC voice traffic and the CLEC-provided High Bandwidth Services will arrive at the CLEC collocation arrangement via a tie cable obtained from BellSouth. At the collocation arrangement, the tie cable will terminate at the splitter, which will separate the voice traffic and the High Frequency traffic. CLEC will retain the High Frequency traffic. BellSouth shall be responsible for providing the tie cable required to interconnect with CLEC at the splitter in order to receive the voice traffic.
- (2) Splitter Located in an Area of the Serving Wire Center Outside of CLEC's Collocation Arrangement, But Accessible to CLEC (depicted in Figure 2). CLEC may choose to have the splitter placed in a common area in the serving wire center, to which CLEC has access. In this scenario, CLEC shall receive its High Frequency traffic via a tie cable obtained from BellSouth, running from the Main Distribution Frame to the splitter and then from the splitter to the CLEC's collocation arrangement. BellSouth shall be responsible for providing the tie cable required to interconnect with CLEC at

the splitter in order to receive the voice traffic. CLEC will determine whether it will own the splitter, or will require BellSouth to own and obtain the splitter from the third party vendor of CLEC's choosing. If BellSouth owns the splitter, CLEC may obtain the splitter functionality on an individual "port-at-a-time" basis. CLEC shall have access to the splitter in the common area. If CLEC owns the splitter, CLEC shall have the right to perform repair and maintenance work (as detailed further below in Section IX of this Attachment) on the splitter.

(3) Splitter Located in an Area of the Serving Wire Center Controlled Exclusively by BellSouth (depicted in Figure 3). CLEC may choose to have BellSouth own and obtain the splitter (either from a third party vendor or from CLEC) and locate the splitter in an area in the serving wire center to which CLEC does not have access (e.g., on or adjacent to the Main Distribution Frame). In this scenario, CLEC may obtain the splitter functionality on an individual "port-at-a-time" basis. BellSouth shall perform all maintenance and repair work (as detailed further below in Section IX of this Attachment). CLEC shall receive its High Frequency traffic via a tie cable obtained from BellSouth, running from the Main Distribution Frame to the splitter and then from the splitter to CLEC's collocation arrangement. BellSouth shall be responsible for providing the tie cable required to interconnect with CLEC at the splitter in order to receive the voice traffic.

(b) Under all three of the aforementioned scenarios, BellSouth shall make available to CLEC Interoffice Transport. CLEC may use Interoffice Transport to transport its High Frequency traffic between its collocation arrangement in the serving wire center and its point-of-presence, node, or collocation arrangement in a different wire center. BellSouth

shall offer CLEC Interoffice Transport as bandwidth dedicated to CLEC (*e.g.*, DS0, DS1, DS3, or OCn).

- (c) BellSouth shall complete the installation and provisioning of any tie cable ordered by CLEC pursuant to this Attachment within thirty calendar (30) days of BellSouth's receipt of an order for a tie cable from CLEC, unless a shorter interval is specified in the Interconnection Agreement, or becomes BellSouth practice, or is achieved by or offered to any other provider of High Bandwidth Services, in which case the shortest of such intervals shall apply. The Parties agree that this interval shall apply only to any tie cable ordered by CLEC pursuant to or consistent with this High Bandwidth Line Sharing UNE Attachment. CLEC may order and BellSouth shall provide tie cables at any available capacity (*e.g.*, voice grade, DS0, DS1, or DS3).
 - (d) BellSouth shall not require CLEC to provide forecasts for the number of splitters or jumpers CLEC may require. CLEC may, at its sole discretion, provide splitter and jumper forecasts to BellSouth.
- (ii) Augments
- (a) BellSouth shall process all CLEC applications and firm orders for augmenting its collocation arrangements to use Line Sharing to provide High Bandwidth Services in a sum total (for each application and subsequent firm order, combined) of not more than thirty (30) calendar days from BellSouth's receipt of the initial application. This thirty (30) calendar day interval shall apply to the addition of digital subscriber line access multiplexers ("DSLAMs"), splitters, tie cables and any other equipment necessary for CLEC to use Line Sharing to provide High Bandwidth Services, and shall apply to BellSouth's obtaining and installing splitters and tie cables to be used by CLEC.

- (b) The addition of additional line cards to a DSLAM or splitter located in CLEC's collocation arrangement shall not require the submission of any additional application or firm order by CLEC, and shall be accomplished on the schedule determined solely by CLEC.

VI. Fiber-Fed DLC

A. Network Topology – This Section provides a description of the HBLs UNE when the HBLs UNE is provided over Fiber-Fed DLC. There are several different variations of HBLs UNE provided over Fiber-Fed DLC (depicted below in Figures 4). In each variation, BellSouth shall make available to CLEC copper wire from the demarcation point at the end-user customer premises to the Remote Terminal, and shall make available fiber from the Remote Terminal to the first ATM switch located at BellSouth's serving wire center or other location. From the ATM switch, CLEC shall determine the method by which BellSouth will deliver the High Frequency traffic to CLEC. CLEC may specify, without limitation, any of the methods and points of interconnection indicated in this Section. The specific number and type of sub-elements CLEC may lease from BellSouth to obtain the HBLs UNE over Fiber-Fed DLC will vary, depending on the specific configuration chosen by CLEC.

B. Network Elements / Interconnection Components

1. BellSouth shall make available to CLEC and CLEC shall obtain certain of the following network elements and/or interconnection components, either individually or in any of the combinations of elements specified below, in order for CLEC to provide High Bandwidth Services over an HBLs UNE provided over Fiber-Fed DLC:
 - (i) The High Frequency portion of the all-copper-wire subloop between the end-user customer premises and BellSouth's Remote Terminal ("HFPSL");
 - (ii) BellSouth-integrated DSLAM line card/electronics in the Remote Terminal (when owned by BellSouth) ("LCRT");
 - (iii) Space rental for collocation of CLEC's DSLAM at BellSouth's Remote Terminal ("DSLAM Collocation");
 - (iv) Cross-connect between HFPSL and CLEC's DSLAM collocated in BellSouth's Remote Terminal ("CC1");

- (v) Cross-connect between CLEC's DSLAM collocated in BellSouth's Remote Terminal and the optical concentrator at the end of the Fiber-Fed DLC ("CC2");
- (vi) Fiber-Fed DLC as a Permanent Virtual Circuit ("PVC") from the DLC equipment in BellSouth's Remote Terminal terminating in the ATM switch ("FPVC");
- (vii) Fiber-Fed DLC as a Permanent Virtual Path ("PVP") from the DLC equipment in BellSouth's Remote Terminal terminating in the ATM switch ("FPVP");
- (viii) A port termination on the ATM switch ("ATM port");
- (ix) An ATM switch transit function "ATM switch";
- (x) Tie cable between ATM port and CLEC's collocation arrangement ("TC"); and
- (xi) Interoffice transport (1) between CLEC's collocation arrangement in the serving wire center and CLEC's point-of-presence, node, or collocation arrangement in another location; or (2) between an ATM port and CLEC's point-of-presence, node, or collocation arrangement in another location ("Interoffice Transport"). BellSouth shall offer CLEC the choice of Interoffice Transport in each of the following ways:
 - (a) As bandwidth dedicated to CLEC (*e.g.*, DS0, DS1, DS3, or OCn);
 - (b) As PVCs, at the Quality of Service Class(es) specified by CLEC; or
 - (c) As PVPs, at the Quality of Service Class(es) specified by CLEC.

Figure 4 (below) depicts each of these network elements.

2. CLEC may obtain from BellSouth any one or more of the aforementioned network elements on an individual basis.
3. BellSouth shall also make available to CLEC the aforementioned network elements in all technically feasible combinations, including without limitation the following combinations:

- (i) HFPSL + LCRT + FPVC + ATM port;
- (ii) HFPSL + LCRT + FPVC + ATM port + Interoffice Transport;
- (iii) HFPSL + LCRT + FPVC + ATM switch + Interoffice Transport + ATM port;
- (iv) HFPSL + LCRT + FPVC + ATM switch + Interoffice Transport + ATM port + Interoffice Transport;
- (v) HFPSL + LCRT;
- (vi) HFPSL + CC1;
- (vii) DSLAM Collocation + CC2;
- (viii) FPVP + ATM port;
- (ix) CC2 + FPVP + ATM port;
- (x) CC2 + FPVP + ATM port + Interoffice Transport;
- (xi) FPVP + ATM port + Interoffice Transport;
- (xii) CC2 + FPVP + ATM switch + Interoffice Transport + ATM Port;
- (xiii) FPVP + ATM switch + Interoffice Transport + ATM Port;
- (xiv) CC2 + FPVP + ATM switch + Interoffice Transport + ATM Port + Interoffice Transport;
- (xv) FPVP + ATM switch + Interoffice Transport + ATM Port + Interoffice Transport;
- (xvi) CC2 + FPVC + ATM switch + Interoffice Transport + ATM Port;
- (xvii) FPVC + ATM switch + Interoffice Transport + ATM Port;
- (xviii) CC2 + FPVC + ATM switch + Interoffice Transport + ATM Port + Interoffice Transport; and
- (xix) FPVC + ATM switch + Interoffice Transport + ATM Port + Interoffice Transport.

These combinations may be used by CLEC together with any other individual sub-element(s), or applicable combinations, described in this Section VI of the High Bandwidth Line Sharing UNE Attachment or elsewhere in the Interconnection Agreement.

- C. BellSouth shall complete the installation and provisioning of any tie cable ordered by CLEC pursuant to this Attachment within thirty (30) calendar days of BellSouth's receipt of an order for a tie cable from CLEC, unless a shorter interval is specified in the Interconnection Agreement, or becomes BellSouth practice, or is achieved by or offered to any other provider of High Bandwidth Services, in which case the shortest of such intervals shall apply. The Parties agree that this interval shall apply only to any tie cable ordered by CLEC pursuant to or consistent with this High Bandwidth Line Sharing UNE Attachment. CLEC may order and BellSouth shall provide tie cables at any available capacity (e.g., DS0, DS1, DS3, or OCn).

- D. Augments
 - 1. BellSouth shall process all CLEC applications and firm orders for augmenting its collocation arrangements to use Line Sharing to provide High Bandwidth Services in a sum total (for each application and subsequent firm order, combined) of not more than thirty (30) calendar days from BellSouth's receipt of the initial application. This thirty (30) calendar day interval shall apply to the addition of DSLAMs, tie cables and any other equipment necessary for CLEC to use Line Sharing to provide High Bandwidth Services, and shall apply to BellSouth's obtaining and installing tie cables to be used by CLEC.
 - 2. The addition of additional line cards to a DSLAM located in CLEC's collocation arrangement shall not require the submission of any additional application or firm order by CLEC.

- E. Remote Terminal Equipment Placement
 - 1. BellSouth shall permit CLEC to place, or shall place upon CLEC's request, a CLEC-specified DSLAM and/or splitter in BellSouth's Remote Terminal. CLEC may specify the specific type of DSLAM and/or splitter to be placed in BellSouth's Remote Terminal.
 - 2. BellSouth shall permit CLEC to specify, at each individual BellSouth Remote Terminal, the line card(s) to be placed in the DLC equipment in BellSouth's Remote Terminal for use in

providing service to CLEC's customers. CLEC may select either of the following line card options:

- (i) CLEC specifies the type and quantity of the line card(s) that BellSouth shall obtain and install in a Remote Terminal; or
 - (ii) CLEC obtains the desired line card(s) and transfers ownership of said card(s) to BellSouth (for \$1.00 per card). BellSouth then installs said card(s) in the Remote Terminal. Upon request of CLEC, BellSouth shall remove said card(s), return said card(s) to CLEC, and transfer ownership of said card(s) to CLEC for \$1.00 each.
3. Within 2 weeks of any request by CLEC, BellSouth shall provide to CLEC copies, both paper and electronic, of all technical specifications and network architecture data relevant to the development by any potential vendor of plug-in DLC line cards that will support CLEC High Bandwidth Services.

VII. Service Ordering

A. Home Run Copper Configuration for the HBLS UNE

1. Pre-ordering

- (i) During pre-ordering, BellSouth shall provide CLEC with nondiscriminatory access to Loop Makeup Information that identifies the physical attributes or characteristics of each loop. Such Loop Makeup Information includes, but is not limited to, the following:
 - (a) The composition of the available loop material (including without limitation fiber optics and copper);
 - (b) The existence, location and type of electronic or other equipment on the loop (including without limitation DLC or other remote concentration devices, feeder/distribution interfaces, bridged taps, load coils, pair gain devices, repeaters, remote switching units, range extenders, AMI T-1s in the same or adjacent binder groups, and other similar impediments);

- (c) Loop length, including the segment length and location of each type of transmission media;
 - (d) Loop length by wire gauge;
 - (e) The electrical parameters of the loop;
 - (f) The availability of alternative facilities; and
 - (g) Planned loop infrastructure modifications.
- (ii) BellSouth shall provide CLEC with both electronic and manual access to its Operations Support Systems, including without limitation its engineering records, outside plant databases (such as the Loop Facility Assignment Control System ("LFACS") and Trunk Inventory and Record Keeping System ("TIRKS")) and other systems containing Loop Makeup Information, so that CLEC may access such Loop Makeup Information directly and make its own determinations about whether a particular loop is suitable for the services that CLEC intends to provide over the loop. Consistent with BellSouth's nondiscrimination obligations, BellSouth shall provide Loop Makeup Information based on, *e.g.*, the individual telephone number or address of an end-user in a particular wire center or NXX code, or on any other basis that BellSouth maintains access to such information or provides such information to itself, to any of its Affiliates, to any of its employees, contractors or subcontractors, or to any other party.
- (iii) In providing CLEC with access to Loop Makeup Information, BellSouth must provide CLEC with not only the same information that BellSouth provides to itself (including without limitation to its retail and wholesale divisions) or to its Affiliates, but BellSouth must also provide CLEC with access to any Loop Makeup Information that either currently exists, is being or can be developed in the future anywhere within BellSouth's Operations Support Systems and that can be accessed by any of BellSouth's personnel.
2. BellSouth shall enable CLEC to perform all pre-ordering functions, including accessing all available systems and databases containing Loop Makeup Information, via a real-time, electronic interface no later than June 6, 2000. Until such time as said electronic interface is made available to CLEC by BellSouth,

BellSouth shall enable CLEC to perform all pre-ordering functions via a Web GUI. The mechanized order cost and price shall apply unless a standardized mechanized ordering option is available and CLEC chooses not to place its order using that system. If CLEC chooses not to use an available mechanized ordering option, then the Commission's adopted manual or semi-manual cost would apply, as appropriate, given CLEC's order method.

3. Line and Station Transfer Option. Where CLEC seeks to use Line Sharing to provide High Bandwidth Services over an HBLs UNE using Home Run Copper and the pre-qualification process determines (a) that the loop then associated with the telephone number initially inquired about by CLEC is served via a DLC, and (b) that there is an available spare copper pair that runs from the demarcation point at the end-user customer premises to the serving wire center, BellSouth shall:

- (i) Perform a line and station transfer (*i.e.*, a pair swap) to move the end-user's voice service to the available spare copper pair; and
- (ii) Make available the High Frequency portion of the spare copper pair to CLEC as an HBLs UNE.

4. Ordering

- (i) No later than June 6, 2000, BellSouth shall enable CLEC to order an HBLs UNE provided using Home Run Copper via a real-time, EDI electronic interface. Prior to June 6, 2000, BellSouth shall enable CLEC to order an HBLs UNE provided using Home Run Copper via a Web GUI electronic interface.
- (ii) Should CLEC request de-conditioning of an HBLs UNE provided using Home Run Copper, BellSouth shall enable CLEC to order such de-conditioning via its real-time, EDI electronic interface beginning on June 6, 2000. Prior to June 6, 2000, CLEC shall place all orders for de-conditioning via the manual or electronic processes in place as of the effective date of this Attachment.

B. Fiber-Fed DLC Configuration for the HBLs UNE

1. Pre-ordering

- (i) During pre-ordering, BellSouth shall provide CLEC with nondiscriminatory access to Loop Makeup Information that identifies the physical attributes or characteristics of each loop. Such Loop Makeup Information includes, but is not limited to, the following:
 - (a) The composition of the available loop material (including without limitation fiber optics and copper);
 - (b) The existence, location and type of electronic or other equipment on the loop (including without limitation DLC or other remote concentration devices, feeder/distribution interfaces, bridged taps, load coils, pair gain devices, repeaters, remote switching units, range extenders, AMI T-1s in the same or adjacent binder groups, and other similar impediments);
 - (c) Loop length, including the segment length and location of each type of transmission media;
 - (d) Loop length by wire gauge;
 - (e) The electrical parameters of the loop;
 - (f) The availability of alternative facilities; and
 - (g) Planned loop infrastructure modifications.
- (ii) BellSouth shall provide CLEC with both electronic and manual access to its Operations Support Systems, including without limitation its engineering records, outside plant databases (such as the Loop Facilities Assignment Control System ("LFACS") and Trunk Inventory and Record Keeping System ("TIRKS")) and other systems containing Loop Makeup Information, so that CLEC may access such Loop Makeup Information directly and make its own determinations about whether a particular loop is suitable for the services that CLEC intends to provide over the loop. Consistent with BellSouth's nondiscrimination obligations, BellSouth shall provide Loop Makeup Information based on, *e.g.*, the individual telephone number or address of an end-user in a particular wire center or NXX code, or on any other basis that BellSouth maintains access to such information or provides such information to itself, to any of

its Affiliates, to any of its employees, contractors or subcontractors, or to any other party.

- (iii) In providing CLEC with access to Loop Makeup Information, BellSouth must provide CLEC with not only the same information that BellSouth provides to itself (including without limitation to its retail and wholesale divisions) or to its Affiliates, but BellSouth must also provide CLEC with access to any Loop Makeup Information that either currently exists, is being or can be developed in the future anywhere within BellSouth's Operations Support Systems and that can be accessed by any of BellSouth's personnel.
- (iv) BellSouth shall enable CLEC to perform all pre-ordering functions, including accessing all available systems and databases containing Loop Makeup Information, via a real-time, electronic interface no later than June 6, 2000. Until such time as said electronic interface is made available to CLEC by BellSouth, BellSouth shall enable CLEC to perform all pre-ordering functions via a Web GUI.

2. Ordering

- (i) No later than June 6, 2000, BellSouth shall enable CLEC to order an HBLS UNE provided using Fiber-Fed DLC via a real-time, EDI electronic interface. Prior to June 6, 2000, BellSouth shall enable CLEC to order an HBLS UNE provided using Fiber-Fed DLC via a Web GUI electronic interface. The mechanized order cost and price shall apply unless a standardized mechanized ordering option is available and CLEC chooses not to place its order using that system. If CLEC chooses not to use an available mechanized ordering option, then the Commission's adopted manual or semi-manual cost would apply, as appropriate, given the CLEC's order method.
- (ii) The BellSouth's real-time, EDI electronic interface, once it is available to support the ordering of HBLS UNEs that use Fiber-Fed DLC, shall support the ordering of all possible configurations of Fiber-Fed DLC HBLS UNEs (individual and combinations) described in this High Bandwidth Line Sharing UNE Attachment.

VIII. Provisioning and Installation

A. HBLs UNE Using Home Run Copper Configuration

1. Intervals. BellSouth shall complete the provisioning and installation of HBLs UNEs using Home Run Copper configurations according to the following interval schedule: (i) HBLs UNEs ordered between June 6, 2000 and September 6, 2000 shall be completed within three (3) business days of BellSouth receiving an order from CLEC; (ii) HBLs UNEs ordered between September 7, 2000 and December 7, 2000 shall be completed within two (2) business days of BellSouth receiving an order from CLEC; and (iii) HBLs UNEs ordered after December 7, 2000 shall be completed within one (1) business day of BellSouth receiving an order from CLEC. This interval shall include the cooperative acceptance testing in subsection VIII.A.4 below.
2. Line and Station Transfers. Where CLEC requests BellSouth to perform a line and station transfer as part of the order for an HBLs UNE using Home Run Copper, BellSouth shall perform said line and station transfer. BellSouth shall determine the manner in which it performs a line and station transfer. BellSouth's need to perform a line and station transfer shall not impact the interval in which BellSouth is to provision and install an HBLs UNE using Home Run Copper.
3. De-conditioning. Where requested by CLEC to perform de-conditioning (*i.e.*, removal of any of the impediments identified in the pre-ordering section above, including without limitation load coils and bridged taps) of an HBLs UNE, BellSouth shall perform said de-conditioning. Performance of any CLEC-requested de-conditioning shall extend the provisioning and installation interval by an additional 2 business days. This interval shall include the cooperative acceptance testing in subsection VIII.A.4 below. BellSouth may not charge CLEC for de-conditioning.
4. Cooperative Acceptance Testing. BellSouth shall not consider installation of an HBLs UNE provided over Home Run Copper to be complete until CLEC has affirmatively accepted the HBLs UNE. BellSouth shall test the HBLs UNE for copper continuity and for pair balance prior to completing the installation. Once BellSouth completes such testing and obtains passing results, BellSouth shall inform CLEC that BellSouth believes the installation has been properly performed. At this point, CLEC shall either accept the line without conducting its own testing, or shall conduct its own test of the HBLs UNE. If CLEC conducts its own testing and the results demonstrate that the HBLs UNE is capable of being used to provide High Bandwidth Services, CLEC

shall accept the HBLs UNE from BellSouth. If CLEC conducts its own testing and the results demonstrate that the HBLs UNE is not capable of being used to provide High Bandwidth Services, CLEC may refuse to accept the line, and may instead open a trouble ticket. Such a trouble ticket shall not be placed in the general population of maintenance and repair trouble tickets, but rather shall remain an installation problem. Until BellSouth cures the problem(s) with the HBLs UNE (or until BellSouth and CLEC collectively agree that the problem(s) lies with the CLEC's equipment or facilities, including any customer premises equipment), the installation will be deemed by the Parties to be an incomplete, failed installation.

B. HBLs UNE Using Fiber-Fed DLC Configuration

1. Intervals. BellSouth shall complete the provisioning and installation of HBLs UNEs using Fiber-Fed DLC configurations according to the following interval schedule: (i) HBLs UNEs ordered between June 6, 2000 and September 6, 2000 shall be completed within three (3) business days of BellSouth receiving an order from CLEC; (ii) HBLs UNEs ordered between September 7, 2000 and December 7, 2000 shall be completed within two (2) business days of BellSouth receiving an order from CLEC; and (iii) HBLs UNEs ordered after December 7, 2000 shall be completed within one (1) business day of BellSouth receiving an order from CLEC. If BellSouth must install a CLEC-specific line card in a remote terminal as part of the installation of an HBLs UNE, then these intervals shall be extended by one (1) business day. The intervals in this subsection shall include the cooperative acceptance testing in subsection 2 below.
2. Cooperative Acceptance Testing. BellSouth shall not consider installation of an HBLs UNE provided over Fiber-Fed DLC to be complete until CLEC has affirmatively accepted the HBLs UNE. BellSouth shall test all fiber between the ATM port and the BellSouth Remote Terminal, and shall test the copper pair connecting the Remote Terminal to the end-user customer premises for copper continuity and for pair balance prior to completing the installation. Once BellSouth completes such testing and obtains passing results, BellSouth shall inform CLEC that BellSouth believes the installation has been properly performed. At this point, CLEC shall either accept the line without conducting its own testing, or shall conduct its own test of the HBLs UNE. If CLEC conducts its own testing and the results demonstrate that the HBLs UNE is capable of being used to provide High Bandwidth Services, CLEC shall accept the HBLs

UNE from BellSouth. If CLEC conducts its own testing and the results demonstrate that the HBLs UNE is not capable of being used to provide High Bandwidth Services, CLEC may refuse to accept the line, and may instead open a trouble ticket. Such a trouble ticket shall not be placed in the general population of maintenance and repair trouble tickets, but rather shall remain an installation problem. Until BellSouth cures the problem(s) with the HBLs UNE (or until BellSouth and CLEC collectively agree that the problem(s) lies with the CLEC's equipment or facilities (including any customer premises equipment), the installation will be deemed by the Parties to be an incomplete, failed installation.

IX. Testing, Repair and Maintenance

A. HBLs UNE Using Home Run Copper

1. HBLs UNE

- (i) In response to a trouble ticket opened by CLEC, BellSouth shall conduct any necessary repair work for an HBLs UNE on a twenty-four-hour-a-day, seven-day-a-week basis, and shall maintain a mean-time-to-repair interval of two (2) hours, applied monthly.

2. Splitter

- (i) BellSouth is responsible for all testing, repair and maintenance of facilities and equipment on its side of the splitter and CLEC is responsible for all testing, repair and maintenance of facilities and equipment on its side of the splitter.

- (ii) Procedures and Access

- (a) BellSouth owns the splitter.

- (1) Where BellSouth owns the splitter and does not provide CLEC with access to the splitter, BellSouth shall conduct any necessary repair work on the splitter on a twenty-four-hour-a-day, seven-day-a-week basis, and shall maintain a mean-time-to-repair interval of two (2) hours, applied monthly.

- (2) Where BellSouth owns the splitter and provides CLEC with access to the splitter,

BellSouth shall permit CLEC to perform maintenance, repair and testing work on, and shall provide CLEC with access to the splitter twenty-four hours a day, seven days a week.

(b) CLEC owns the splitter. Where the CLEC owns the splitter, CLEC is responsible for performing maintenance, repair and testing on the splitter.

(c) Coordination between BellSouth and CLEC. BellSouth and CLEC agree to coordinate in good faith any splitter testing, repair and maintenance that will significantly impact the service provided by the other party. In no event is BellSouth to perform any splitter testing, repair or maintenance that interrupts the flow of data to a CLEC customer without first coordinating with CLEC to reach a mutually agreeable time for the necessary testing, repair or maintenance work to occur. The foregoing sentence notwithstanding, CLEC shall not require BellSouth to provide CLEC with more than two (2) hours advance notice for any repair effort needed to restore service to a BellSouth end-user that has suffered a complete loss of voice services.

3. Test Head

(i) CLEC shall have physical and remote test access to the test head twenty-four hours a day, seven days a week.

B. HBLs UNE Using Fiber-Fed DLC

1. HBLs UNE

(i) In response to a trouble ticket opened by CLEC, BellSouth shall conduct any necessary repair work for an HBLs UNE on a twenty-four-hour-a-day, seven-day-a-week basis, and shall maintain a mean-time-to-repair interval of two (2) hours, applied monthly.

2. Remote Terminal DLC Line Cards

(i) In response to a trouble ticket opened by CLEC, BellSouth shall conduct any work necessary to repair or replace the line cards in BellSouth's DLC in a Remote Terminal on a

twenty-four-hour-a-day, seven-day-a-week basis, and shall maintain a mean-time-to-repair interval of two (2) hours, applied monthly.

- (ii) Where repair work or replacement is necessary on a line card in a Remote Terminal that is of a type not deployed by BellSouth for its own use [or use by its data affiliate], CLEC is responsible for providing BellSouth with a sufficient quantity of spare line cards for BellSouth to use for maintenance and repair purposes.

X. Rates

- A. With respect to the services, network elements and interconnection components described in this High Bandwidth Line Sharing UNE Attachment, BellSouth may charge CLEC the rates listed in the following Table 1 for the items listed in Table 1. No other rates or charges shall apply for these services, network elements and interconnection components.
- B. The Parties covenant and agree that BellSouth's charges to CLEC for each element comprising Line Sharing may not exceed the amount BellSouth allocated for such element in its federal digital subscriber line service(s) tariff(s) as of the effective date of this High Bandwidth Line Sharing UNE Attachment.

Rate Elements and Rates for BellSouth-Florida

Rate Element	Rate		
	Monthly Recurring	Non-Recurring	
		1 st /Additional Install	1 st /Additional Disconnect
I. Home Run Copper			
1. HBL5 UNE	\$0.00 ¹	N/A	N/A
2. BellSouth-Owned Splitter	\$0.94	N/A ²	N/A
3. Place Jumper	N/A	\$5.94 / \$3.01	\$4.21 / \$1.80
4. Remove Jumper ³	N/A	\$1.80 / N/A	N/A
5. Cross-Connect	Per Commission-approved cross-connect prices		
II. HBL5 UNE – Fiber Fed DLC (Individual Subelements)			
1. HFPSL ⁴	TBD	N/A	N/A
2. LCRT – I ⁵	TBD	TBD	TBD
3. LCRT – C ⁶	N/A	TBD	TBD
4. DSLAM Collocation ⁷	TBD	N/A	N/A
5. CC1	N/A	TBD	TBD
6. CC2	N/A	TBD	TBD
7. Configure PVCs within a PVP	N/A	TBD	N/A
8. ATM switch / OCD port	TBD	TBD	TBD
9. ATM switch / OCD transit	TBD	N/A	N/A
10. Fiber Cross-Connect @ FDF	TBD	TBD	TBD
11. Cross-Connect – DS3	Per Commission-approved cross-connect prices		
12. Cross-Connect – OCn	Per Commission-approved cross-connect prices		
13. Interoffice transport – PVC – Unspecified Bit Rate	TBD	N/A ⁸	N/A
14. Interoffice transport – PVP – Unspecified Bit Rate	TBD	N/A ⁹	N/A

¹ Assumes that BellSouth recovers the entire cost of the underlying voice loop through POTS rates, as stated in its federal DSL tariff.

² Installation is added to investment and included in the recurring cost calculation.

³ Assumes jumper removal is part of the same overall service order activity as a place jumper request.

⁴ Reflects the cost of the additional electronics at the RT needed to derive the greater feeder bandwidth needed for the ATM bitstream associated with ADSL. Assumes that BellSouth recovers the entire cost of the underlying voice loop through POTS rates, as stated in its federal DSL tariff.

⁵ LCRT – I reflects line sharing provided with a BellSouth-owned and installed line card at the RT.

⁶ LCTR- C reflects the cost of BellSouth installing a CLEC-provided line card in a “virtual collocation” type of arrangement at the RT.

⁷ Used in conjunction with the CC1 and CC2 elements for physical collocation of CLEC equipment (other than a plug-in installed by BellSouth) at the RT.

⁸ The nonrecurring cost to establish PVCs and PVPs will be included in the element associated with card placement.

⁹ The nonrecurring cost to establish PVCs and PVPs will be included in the element associated with card placement.

Rate Element	Rate		
	Monthly Recurring	Non-Recurring	
		1 st /Additional Install	1 st /Additional Disconnect
15. Combinations	Sum of the individual MRCs	TBD	TBD
III. MISCELLANEOUS			
1. De-conditioning	\$0.00	\$0.00 ¹⁰	N/A
2. Pre-ordering	\$0.00	TBD ¹¹	TBD
3. Ordering	N/A	Per Commission-approved mechanized service order charge	

¹⁰ In a forward-looking network, all loops are “conditioned” to be xDSL-capable; therefore, the cost of the “conditioning” functionality is included in the monthly recurring charge for the underlying loop.

¹¹ In a forward-looking network, the cost of mechanized access to loop makeup information is *de minimis*.

Line Sharing on Home Run Copper - Figure 1

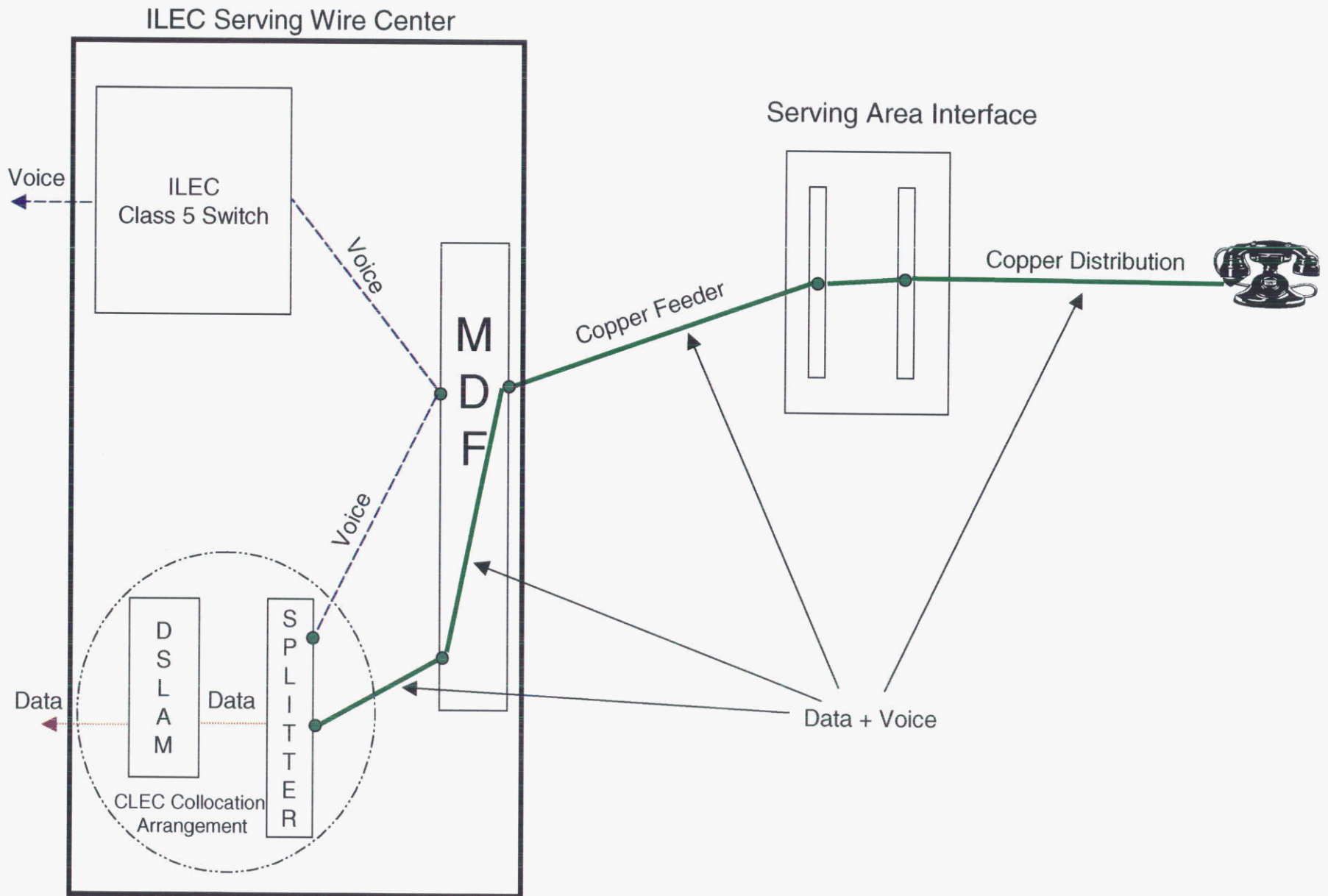

Line Sharing on Home Run Copper - Figure 2

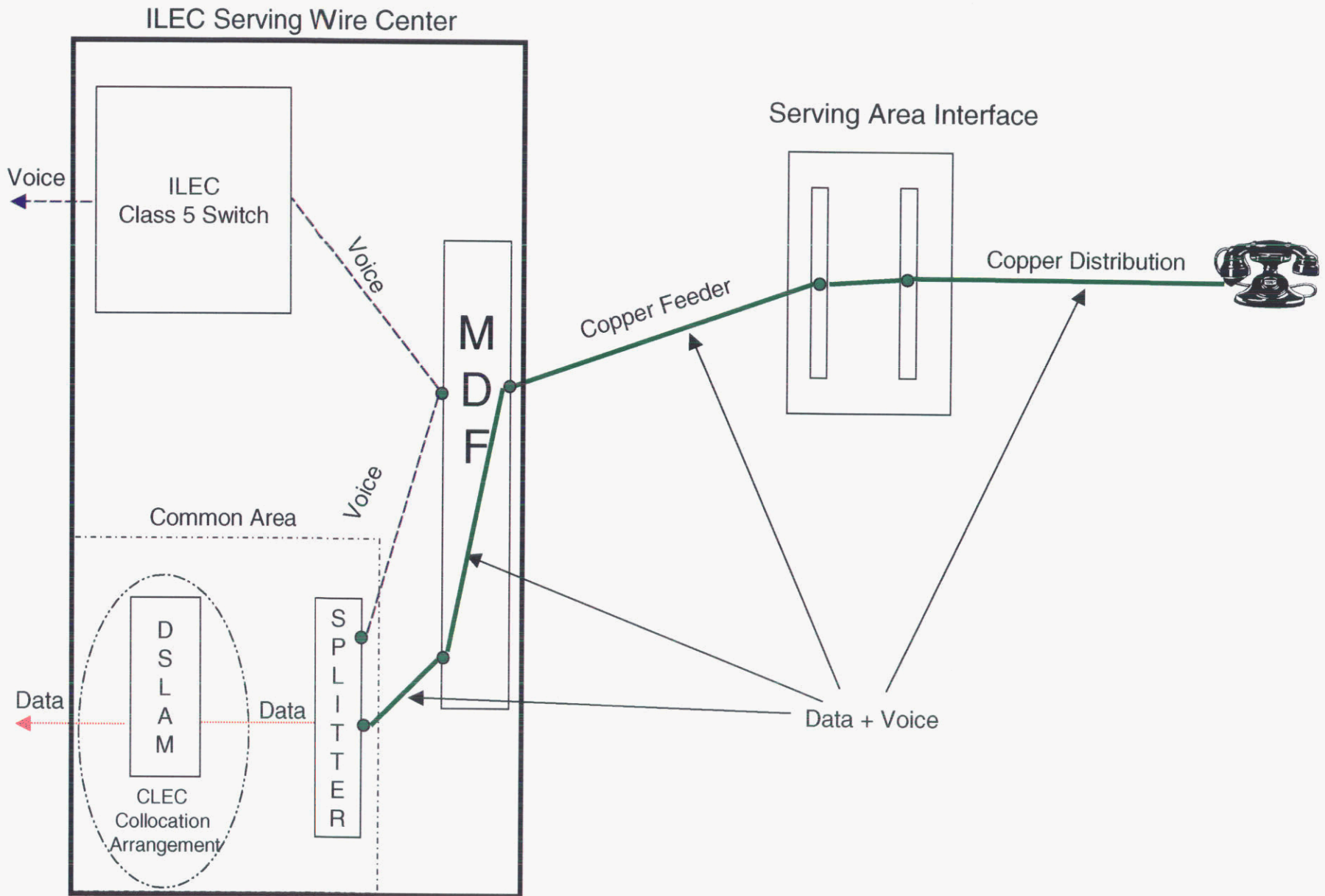

Line Sharing on Home Run Copper - Figure 3

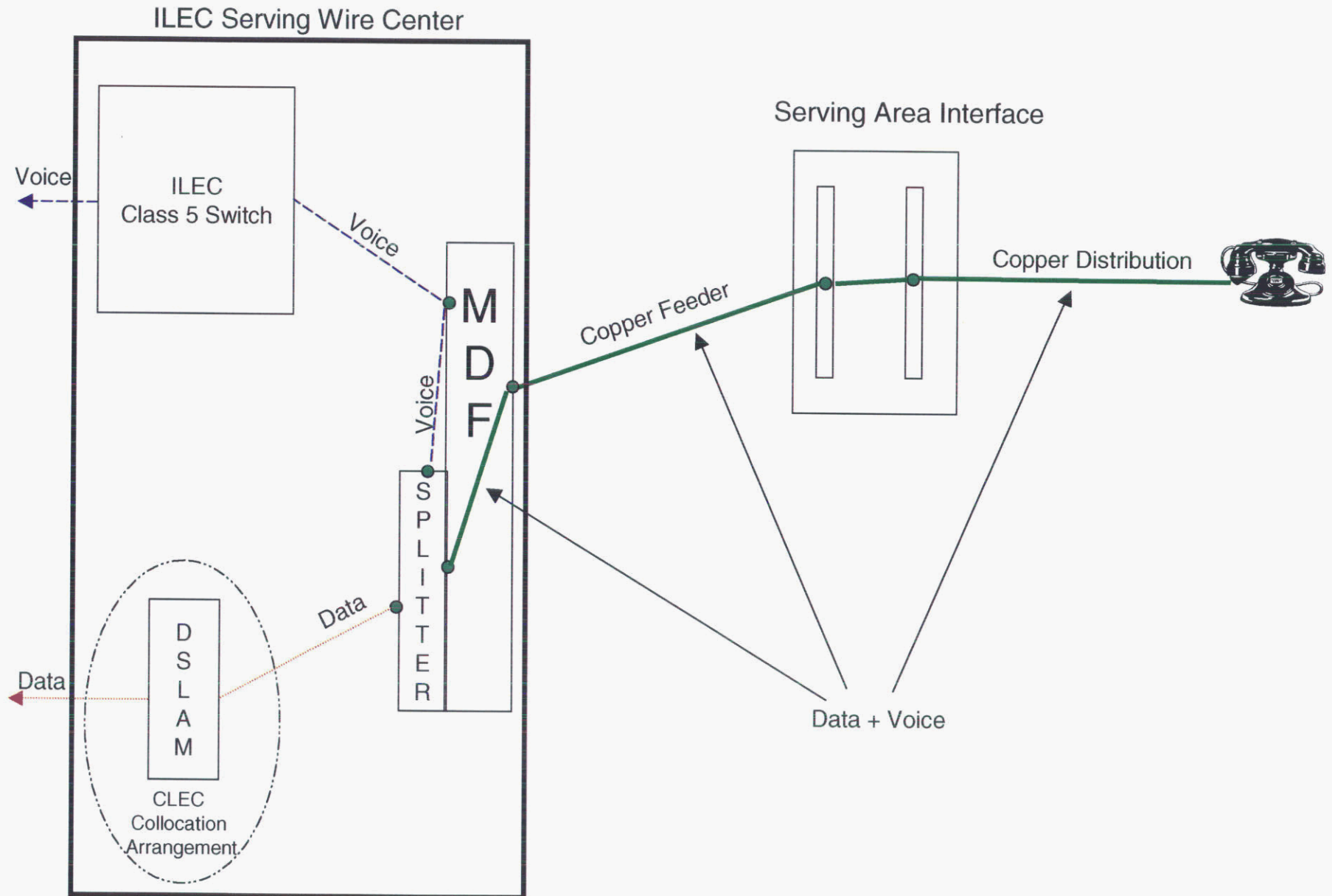

Line Sharing on Fiber-Fed DLC - Figure 4

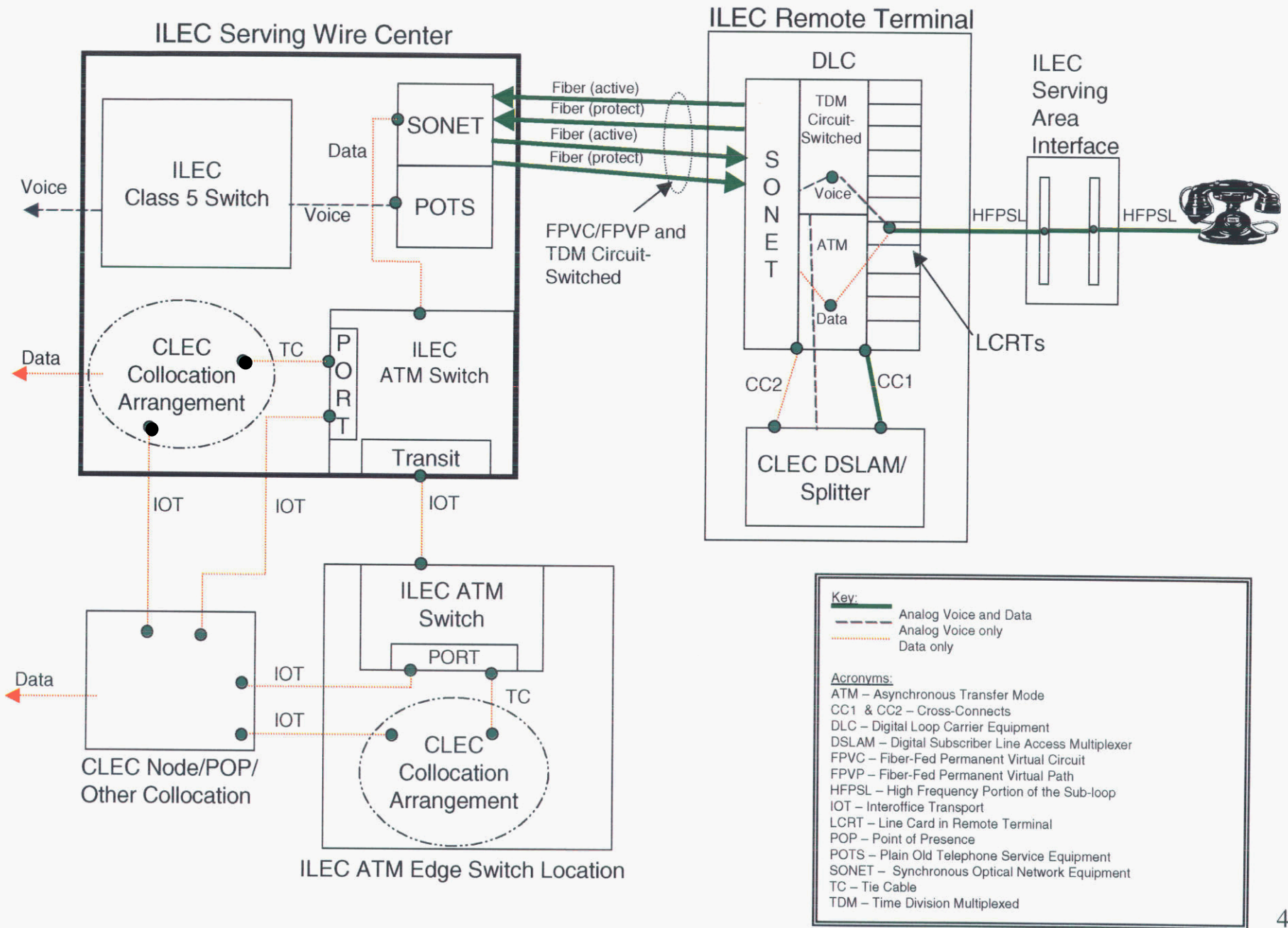

Line Sharing on Home Run Copper - Figure 1

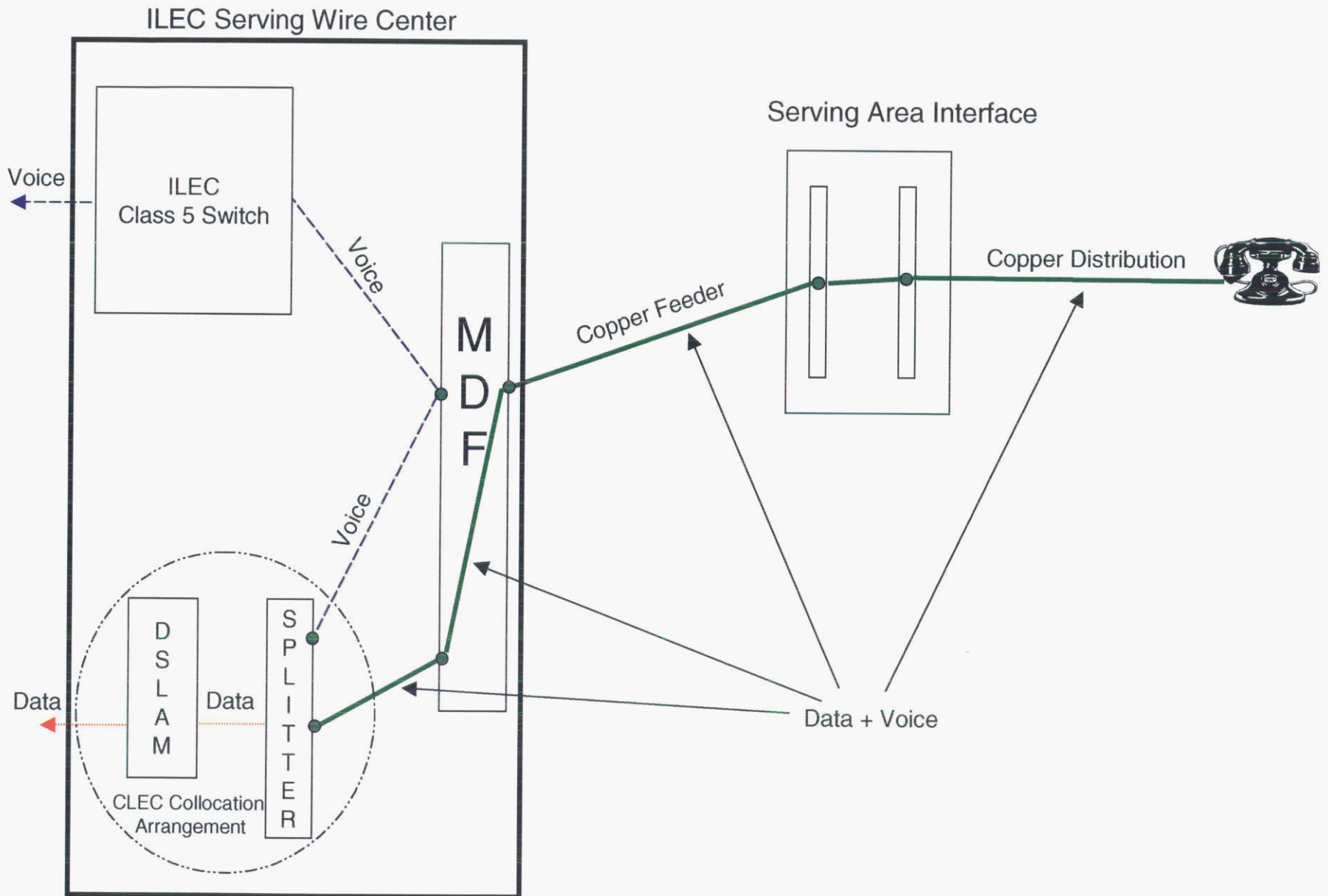

Line Sharing on Home Run Copper - Figure 2

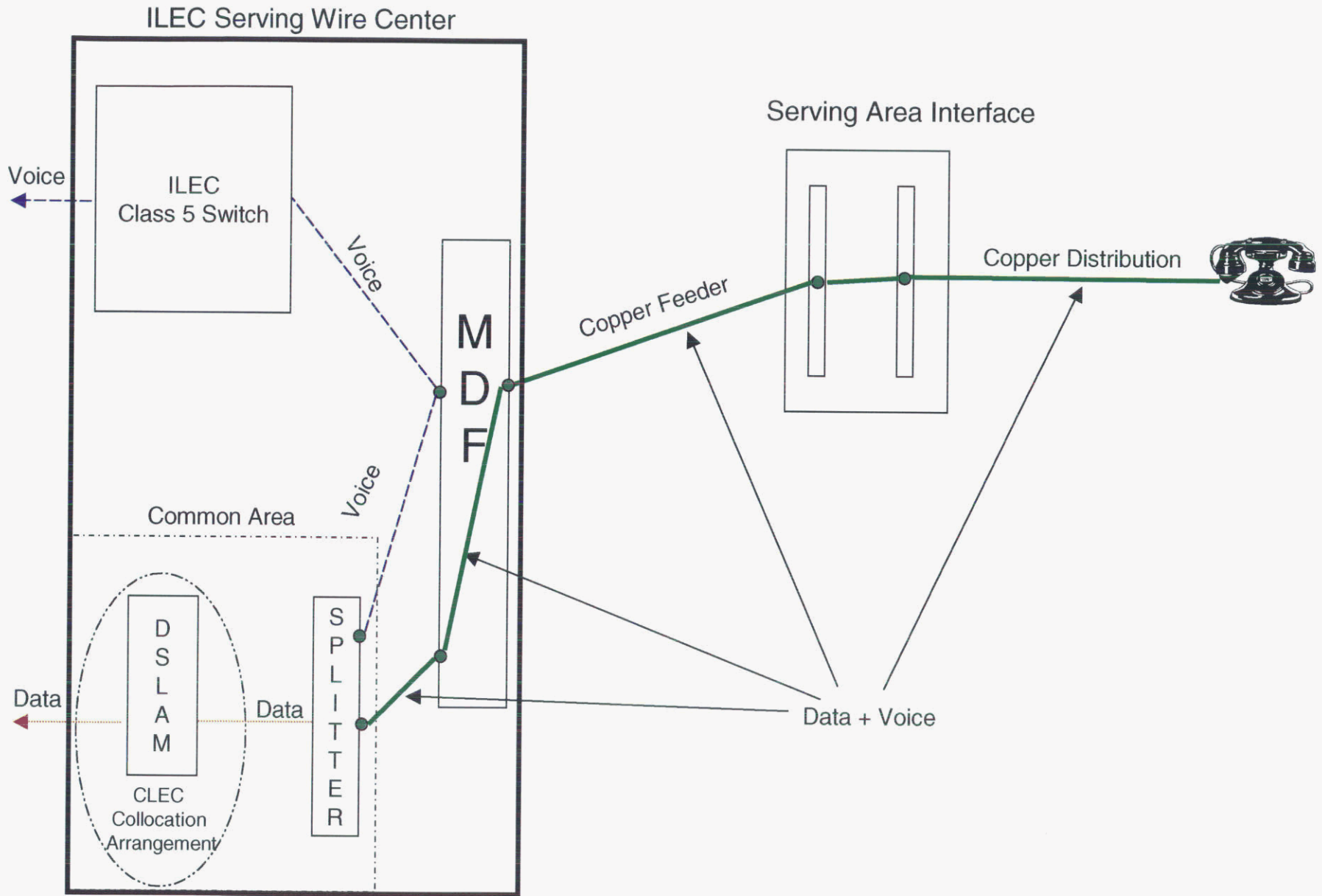

Line Sharing on Home Run Copper - Figure 3

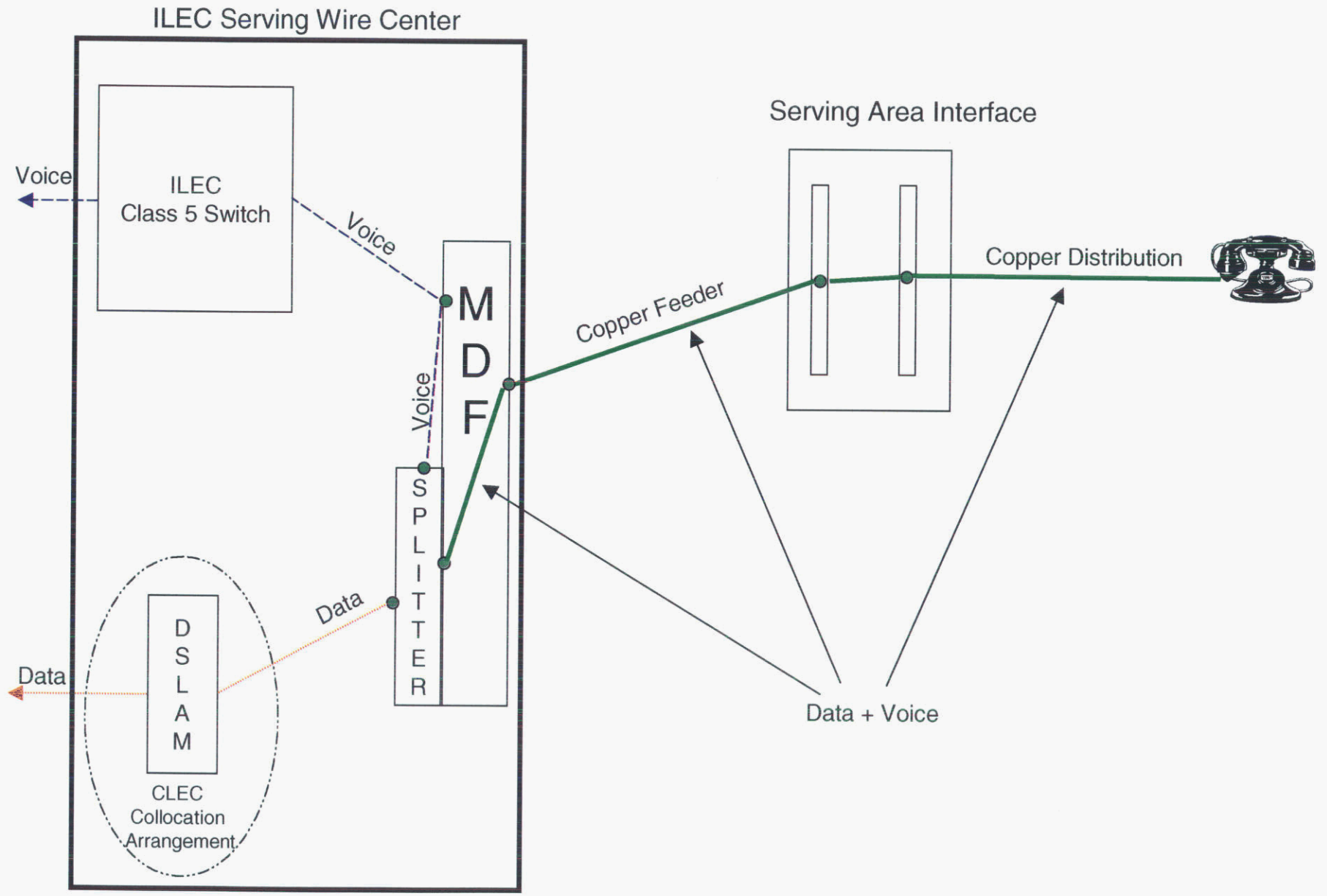

Line Sharing on Fiber-Fed DLC - Figure 4

