

ORIGINAL

DOCKET NO. 060512-EU

RECEIVED-FPSC

CERTIFICATION OF

06 NOV 21 PM 12:45

PUBLIC SERVICE COMMISSION ADMINISTRATIVE RULES

COMMISSION
CLERK

FILED WITH THE

DEPARTMENT OF STATE

I do hereby certify:

(1) That all statutory rulemaking requirements of Chapter 120, F.S., have been complied with; and

(2) There is no administrative determination under subsection 120.56(2), F.S., pending on any rule covered by this certification; and

(3) All rules covered by this certification are filed within the prescribed time limitations of paragraph 120.54(3)(e), F.S. They are filed not less than 28 days after the notice required by paragraph 120.54(3)(a), F.S., and;

(a) Are filed not more than 90 days after the notice; or

(b) Are filed not more than 90 days after the notice not including days an administrative determination was pending; or

(c) Are filed more than 90 days after the notice, but not less than 21 days nor

CMP _____ more than 45 days from the date of publication of the notice of change; or

COM _____

CTR _____ (d) Are filed more than 90 days after the notice, but not less than 14 nor more

ECR _____ than 45 days after the adjournment of the final public hearing on the rule; or

GCL _____ (e) Are filed more than 90 days after the notice, but within 21 days after the

OPC _____ date of receipt of all material authorized to be submitted at the hearing; or

RCA _____

SCR _____

SGA _____

SEC 1

OTH _____

DEPARTMENT OF STATE
TALLAHASSEE, FLORIDA
2006 NOV 20 PM 4:25
FILED

DOCUMENT NUMBER-DATE

10708 NOV 21 08

FPSC-COMMISSION CLERK

// (f) Are filed more than 90 days after the notice, but within 21 days after the date the transcript was received by this agency; or

// (g) Are filed not more than 90 days after the notice, not including days the adoption of the rule was postponed following notification from the Joint Administrative Procedures Committee that an objection to the rule was being considered; or

// (h) Are filed more than 90 days after the notice, but within 21 days after a good faith written proposal for a lower cost regulatory alternative to a proposed rule is submitted which substantially accomplishes the objectives of the law being implemented; or

// (i) Are filed more than 90 days after the notice, but within 21 days after a regulatory alternative is offered by the small business ombudsman.

Attached are the original and two copies of each rule covered by this certification. The rule is hereby adopted by the undersigned agency by and upon its filing with the Department of State.

Rule No.

25-6.0343

Under the provision of subparagraph 120.54(3)(e)6., F.S., the rule takes effect 20 days from the date filed with the Department of State or a later date as set out below:

Effective: _____
(month) (day) (year)

Maricela Sharma, for
BLANCA S. BAYO, Director
Division of the Commission Clerk
and Administrative Services

Number of Pages Certified



LDH

1 25-6.0343 Municipal Electric Utility and Rural Electric Cooperative Reporting Requirements

2 (1) Application and Scope. The purpose of this rule is to define certain reporting
3 requirements by municipal electric utilities and rural electric cooperatives providing
4 distribution service to end-use customers in Florida.

5 (2) The reports required by subsections (3), (4), and (5) of this rule shall be filed with
6 the Director of the Division of Economic Regulation by March 1 of each year for the
7 preceding calendar year.

8 (3) Standards of Construction. Each municipal electric utility and rural electric
9 cooperative shall report the extent to which its construction standards, policies, practices, and
10 procedures are designed to address the ability of transmission and distribution facilities to
11 mitigate damage caused by extreme weather. Each utility report shall, at a minimum, address
12 the extent to which its construction standards, policies, guidelines, practices, and procedures:

13 (a) Comply, at a minimum, with the National Electrical Safety Code (ANSI C-2)
14 [NESC], incorporated by reference in Rule 25-6.0345, F.A.C. For electrical facilities
15 constructed on or after February 1, 2007, the 2007 NESC shall apply. Electrical facilities
16 constructed prior to February 1, 2007, shall be governed by the edition of the NESC in effect
17 at the time of the facility's initial construction. A copy of the 2007 NESC, ISBN number 0-
18 7381-4893-8, may be obtained from the Institute of Electric and Electronic Engineers, Inc.
19 (IEEE).

20 (b) Are guided by the extreme wind loading standards specified by Figure 2502(d) of
21 the 2002 edition of the NESC for:

- 22 1. new construction;
23 2. major planned work, including expansion, rebuild, or relocation of existing
24 facilities, assigned on or after the effective date of this rule; and
25 3. targeted critical infrastructure facilities and major thoroughfares taking into account

CODING: Words underlined are additions; words in ~~struck through~~ type are deletions from existing law.

1 political and geographical boundaries and other applicable operational considerations.

2 (c) Address the effects of flooding and storm surges on underground distribution
3 facilities and supporting overhead facilities.

4 (d) Provide for placement of new and replacement distribution facilities so as to
5 facilitate safe and efficient access for installation and maintenance.

6 (e) Include written safety, pole reliability, pole loading capacity, and engineering
7 standards and procedures for attachments by others to the utility's electric transmission and
8 distribution poles.

9 (4) Facility Inspections. Each municipal electric utility and rural electric cooperative
10 shall report, at a minimum, the following information pertaining to its transmission and
11 distribution facilities:

12 (a) A description of the utility's policies, guidelines, practices, and procedures for
13 inspecting transmission and distribution lines, poles, and structures including, but not limited
14 to, pole inspection cycles and pole selection process.

15 (b) The number and percentage of transmission and distribution inspections planned
16 and completed.

17 (c) The number and percentage of transmission poles and structures and distribution
18 poles failing inspection and the reason for the failure.

19 (d) The number and percentage of transmission poles and structures and distribution
20 poles, by pole type and class of structure, replaced or for which remediation was taken after
21 inspection, including a description of the remediation taken.

22 (5) Vegetation Management. Each municipal electric utility and rural electric
23 cooperative shall report, at a minimum, the following information pertaining to the utility's
24 vegetation management efforts:

25 (a) A description of the utility's policies, guidelines, practices, and procedures for

CODING: Words underlined are additions; words in ~~struck through~~ type are deletions from existing law.

1 vegetation management, including programs addressing appropriate planting, landscaping, and
2 problem tree removal practices for vegetation management outside of road right-of-ways or
3 easements, and an explanation as to why the utility believes its vegetation management
4 practices are sufficient.

5 (b) The quantity, level, and scope of vegetation management planned and completed
6 for transmission and distribution facilities.

7 Specific Authority: 350.127(2), 366.05(1) FS.

8 Law Implemented: 366.04(2)(f), 366.04(6) FS.

9 History New_____.

10

11

12

13

14

15

16

17

18

19

20

21

22

23

24

25

CODING: Words underlined are additions; words in ~~struck through~~ type are deletions from existing law.

CERTIFICATION OF
MATERIALS INCORPORATED BY REFERENCE
IN RULES FILED WITH THE DEPARTMENT OF STATE

Pursuant to Rule 1S-1.005, Florida Administrative Code, I do hereby certify that the attached are true and correct copies of the following materials incorporated by reference in Rule 25-6.0343, F.A.C. Under the provisions of subparagraph 120.54(3)(e)(6), F.S., the attached materials take effect 20 days from the date filed with the Department of State, or a later date as specified in the rule.

National Electrical Safety Code C2-2007

Blanca S. Bayó

BLANCA S. BAYÓ, Director
Division of the Commission Clerk
and Administrative Services

Number of Pages Certified

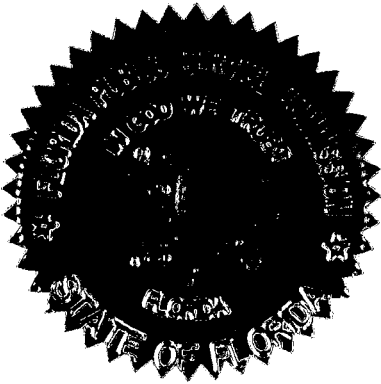

LDH

2006 NOV 20 PM 4:26
DEPARTMENT OF STATE
TALLAHASSEE, FLORIDA

FILED

National Electrical Safety Code[®]

C2-2007



FILED
2006 NOV 20 PM 4:26
DEPARTMENT OF STATE
TALLAHASSEE, FLORIDA



IEEE

3 Park Avenue, New York, NY 10016-5997, USA

National Electrical Safety Code®

Secretariat
Institute of Electrical and Electronics Engineers, Inc.

Approved 20 April 2006
Institute of Electrical and Electronics Engineers, Inc.

Approved 16 June 2006
American National Standards Institute

2007 Edition

Abstract: This standard covers basic provisions for safeguarding of persons from hazards arising from the installation, operation, or maintenance of (1) conductors and equipment in electric supply stations, and (2) overhead and underground electric supply and communication lines. It also includes work rules for the construction, maintenance, and operation of electric supply and communication lines and equipment. The standard is applicable to the systems and equipment operated by utilities, or similar systems and equipment, of an industrial establishment or complex under the control of qualified persons. This standard consists of the introduction, definitions, grounding rules, list of referenced and bibliographic documents, and Parts 1, 2, 3, and 4 of the 2007 Edition of the National Electrical Safety Code.

Keywords: communications industry safety; construction of communication lines; construction of electric supply lines; electrical safety; electric supply stations; electric utility stations; high-voltage safety; operation of communications systems; operation of electric supply systems; power station equipment; power station safety; public utility safety; safety work rules; underground communication line safety; underground electric line safety

The Institute of Electrical and Electronics Engineers, Inc.
3 Park Avenue, New York, NY 10016-5997, USA

Copyright © 2006 by the
Institute of Electrical and Electronics Engineers, Inc.

All rights reserved. Published 2006
Printed in the United States of America

National Electrical Safety Code and NESC are registered trademarks and service marks in the U.S. Patent & Trademark Office, owned by The Institute of Electrical and Electronics Engineers, Incorporated.

The NESC logo is a trademark in the U.S. Patent & Trademark Office, owned by
The Institute of Electrical and Electronics Engineers, Incorporated.

National Electrical Code and NEC are registered trademarks in the U.S. Patent & Trademark Office,
owned by the National Fire Protection Association.

ISBN 0-7381-4893-8

Public authorities are granted permission to republish the material herein in laws, regulations, administrative orders, ordinances, or similar documents. No other party may reproduce in any form, in an electronic retrieval system or otherwise, any portion of this document, without the prior written permission of the publisher.

**Recognized as an
American National Standard**

An American National Standard implies a consensus of those substantially concerned with its scope and provisions. An American National Standard is intended as a guide to aid the manufacturer, the consumer, and the general public. The existence of an American National Standard does not in any respect preclude anyone, whether he has approved the standard or not, from manufacturing, marketing, purchasing, or using products, processes, or procedures not conforming to the standard. American National Standards are subject to periodic review and users are cautioned to obtain the latest editions.



Foreword

This foreword is not a part of Accredited Standards Committee C2-2007, National Electrical Safety Code.

This publication consists of the parts of the National Electrical Safety Code® (NESC®) currently in effect. The former practice of designating parts by editions has not been practical for some time. In the 1977 Edition, Parts 1 and 4 were 6th editions; Part 2 was a 7th edition; Part 3 was a revision of the 6th edition; Part 2, Section 29, did not cover the same subject matter as the 5th edition; and Part 3 was withdrawn in 1970. In the 1987 Edition, revisions were made in all parts, and revisions to all parts have been made in subsequent editions. It is therefore recommended that reference to the NESC be made solely by the year of the published volume and desired part number. Separate copies of the individual parts are not available.

Work on the NESC started in 1913 at the National Bureau of Standards (NBS), resulting in the publication of NBS Circular 49. The last complete edition of the Code (the 5th edition, NBS Handbook H30) was issued in 1948, although separate portions had been available at various times starting in 1938. Part 2—Definitions, and the Grounding Rules, 6th edition, was issued as NBS Handbook H81, ANSI C2.2-1960, in November 1961, but work on other parts was not actively in process again until 1970.

In 1970 the C2 Committee decided to delete the Rules for the Installation and Maintenance of Electric Utilization Equipment (Part 3 of the 5th edition), now largely covered by the National Electrical Code® (NEC®) (NFPA 70, 2005 Edition), and the Rules for Radio Installation (Part 5 of the 5th edition) from future editions. The Discussion of the NESC, issued as NBS Handbook H4 (1928 Edition) for the 4th edition of the NESC and as NBS Handbook H39 for Part 2 of the Grounding Rules of the 5th edition, was not published for the 6th edition.

The 1981 Edition included major changes in Parts 1, 2, and 3, minor changes in Part 4, and the incorporation of the rules common to all parts into Section 1. The 1984 Edition was revised to update all references and to list those references in a new Section 3. Converted metric values, for information only, were added. Gender-related terminology was deleted. Section 1—Introduction, Section 2—Definitions, Section 3—References, and Section 9—Grounding Methods, were made applicable to each of the Parts 1, 2, 3, and 4.

The 1987 Edition was revised extensively. Definitions were changed or added. Requirements affecting grounding methods, electric supply stations, overhead line clearances and loading, underground lines, and work rules were revised.

The 1990 Edition included several major changes. General rules were revised. A significant change to the method for specifying overhead line clearances was made and the rationale added as Appendix A. Requirements for clearances of overhead lines from grain bins and an alternate method for determining the strength requirements for wood structures was added. Rules covering grounding methods, electric supply stations, underground lines, and work rules were changed.

In the 1993 Edition, changes were made in the rules applicable to emergency and temporary installations. In Section 9 and Parts 1, 2, and 3, rules were extended or clarified to include HVDC systems. The requirements for random separation of direct-buried supply and communications systems were modified for consistency and clarity, as was the rule in Part 4 on tagging electric supply circuits.

In the 1997 Edition, the most notable general change that took place is that numerical values in the metric (SI) system are shown in the preferred position, with customary inch-foot-pound values (inside parentheses) following. A bibliography, Appendix B, which consists of a list of resources identified in notes or recommendations, was added. Changes were made to rules affecting grounding, electric supply stations, and overhead lines, particularly with regard to clearance rules applicable to emergency and temporary installations. Strength requirements contained in Sections 24, 25, and 26 were revised completely.

Underground line requirements for random separation for underground lines of direct-buried cables were modified. The requirement for cable identification marking by means of sequentially placed logos was introduced. Work rules added a requirement that warning signs and tags comply with applicable ANSI standards, tagging requirements were clarified with regard to SCADA, and extensive requirements for fall protection were added.

In the 2002 Edition, several changes were made that affected all or several parts of the Code. Particularly, this edition clarifies interfaces between the NEC and NESC with regard to Code jurisdiction in the area of street lights and area lights. Also included is clarification for situations between utility workers and their authorized contractors and installations on industrial complexes.

The major revisions for the 2007 Edition include grounding, moving sag calculations to Section 23, moving guy and span wires insulator rules to Section 21, phasing out of the alternate method for load factors and strength factors, flammable materials transported, phase-to-phase cover-up, and minimum approach distance tables.

Subcommittee 1 concerned itself with assuring continuity between subcommittees and supervising the addition of definitions and references. Definitions included work on ducts, conduits, conduit systems raceways, overvoltage/transient conditions, shield wires/static wires, flashover/sparkover, sag, creep, readily climbable/not readily climbable, and others. Inspection and work rules as related to Rule 13 were clarified. The extensive changes made by Working Group 4.10 on overhead clearances was reviewed and accepted for inclusion in Section 23 as well as in a new Appendix B to the Code. A similar review of the work by Subcommittee 5 led to creation of new Appendix C to cover application of extreme wind loading covered in Rule 250C.

Section 9—Based on extensive studies, steel poles are now permitted as grounding electrodes, and Rule 97G mandates common bonding between communication and power grounding electrodes, with additional information on common bonding given in Rule 99. Metallic water piping systems are no longer a preferred grounding electrode. Changes to Rule 96 clarify ground resistance requirements, and changes to Rule 94B clarify dimensional requirements for ground rods.

Part 1—Selected column headings have been revised for clarity, and inconsistencies in Tables 124-1 and 125-1 corrected.

Part 2—Overhead clearances. A new approach for calculating clearances is detailed in new Section 23 and Appendix B. Rules related to sag calculation for conductor sags as related to clearances were moved from Sections 25 and 26 (loading and strength) into sections covering clearances. All calculations in which both loaded and unloaded conductors involving ice and wind when used for strength calculations remain in Sections 25 and 26. Rule 215C2 was revised to require all guys regardless of exposure to be insulated or grounded. Rules related to guy and span wire insulators moved from Rule 279 to Rule 215C2 to improve subject matter retrieval from the Code. The vertical clearance of a service drop attached to a mast, porch, deck, or balcony has been increased from 2.45 to 3 m (8 to 10 ft). Rule 235G has been changed to allow multiplex line cable up to 750 V to attach to the same support bracket as neutral conductors meeting Rule 230E1.

Part 2—Strength and loading. No modifications were made to Rule 250C to remove the exemption that excludes structures of less than 18 m (60 ft) height from having to meet the extreme wind requirements. The efficacy of doing so will be considered again for the 2012 Edition. Insulator strength ratings and conductor tensions are scheduled for study with possible changes to the 2012 Edition. Specific load factors in Tables 253-1 and 253-2 have been reduced. Tables 253-2 and 261-1B covering alternate load factors and strength factors, respectively, will be phased out in July 2010. They will be replaced by Tables 253-1 and 261-1A that are applicable to all materials. Load and strength factors have been specified for fiber reinforced plastic (FRP) materials, and strength factors for FRP structures, crossarms, and braces have been added. Rules 250A, 253, and 261N have been made more specific in dealing with construction maintenance loads.

Rule 261A2e, which permitted poles of reduced strength to remain in service under the specific condition of being supported by stronger poles on each side of the pole, has been removed. In the long-term view, pole design is tending to move in the direction of Probabilistic Design (LRFD) away from Deterministic Design, a trend which is in concert with a majority of other industries.

Part 3—Rule 311C was added to permit supply and communication cables to be laid directly on grade, providing they do not obstruct traffic or pedestrians and meet other applicable rules. Rule 351C1 was clarified to better describe the limitations of where aboveground pools may be located relative to supply cable, and also state the rule that applies to aboveground pools. It is now recognized that all flammable material transported in pipelines is under some conditions considered hazardous because of location. The Code now requires the same radial separation of 300 mm (12 in) for supply and communication cables from all lines that transport flammable material, not only fuel lines. The rule now defines a flammable liquid.

Part 4—Work revolved largely around expanding guidelines for use of fire resistant (FR) clothing and other safety equipment such as voltage protection devices. These guidelines include arc hazard analysis and reference tables. A new rule was introduced to address high-frequency radiation effects on workers in both the supply and communications spaces arising from communication antennas mounted in those spaces. A new rule requiring phase-to-phase cover-up when guarding against phase-to-phase contact was added. Changes were made to existing minimum approach distance tables. These distances agree with those published in IEEE Std IEEE 516™.①

Substantive changes in the 2007 Edition are identified by a bar in the left-hand margin. In several cases, rules have been relocated without substantive changes in the wording. In these cases, only the rule numbers have been indicated as having been changed.

The Institute of Electrical and Electronics Engineers, Inc., was designated as the administrative secretariat for C2 in January 1973, assuming the functions formerly performed by the National Bureau of Standards.

Comments on the rules and suggestions for their improvement are invited, especially from those who have experience in their practical application. In future editions every effort will be made to improve the rules, both in the adequacy of coverage and in the clarification of requirements. Comments should be addressed to:

Secretary
National Electrical Safety Code Committee
Institute of Electrical and Electronics Engineers, Inc.
445 Hoes Lane
P.O. Box 1331
Piscataway, NJ 08855-1331

A representative Interpretations Subcommittee has been established to prepare replies to requests for interpretation of the rules contained in the Code. Requests for interpretation should state the rule in question, as well as the conditions under which it is being applied. Interpretations are intended to clarify the intent of specific rules and are not intended to supply consulting information on the application of the Code. Requests for interpretation should be sent to the address above.

If the request is suitable for processing, it will be sent to the Interpretations Subcommittee. After consideration by the committee, which may involve many exchanges of correspondence, the inquirer will be notified of its decision. Decisions are published regularly and may be ordered or accessed online at no cost at <http://standards.ieee.org/nsec>.

The NESCC as written is a voluntary standard. However, some editions and some parts of the Code have been adopted, with and without changes, by some state and local jurisdictional authorities. To determine the legal

①Information on references can be found in Section 3.

status of the NESC in any particular state or locality within a state, the authority having jurisdiction should be contacted.

The revision cycle for the 2012 Edition of the NESC will be fully electronic. Change proposals and comments will be submitted to the NESC Secretary online via the Internet. For information on how this electronic revision process will take place and for updates and complete information on the NESC, please visit the National Electrical Safety Code Zone on the IEEE Standards Web site at <http://standards.ieee.org/nesc>.

Standards Committee Membership

At the time this Code was approved, Accredited Standards Committee C2 had the following membership:

O. Chuck Amrhyn, Chair **Frank A. Denbrock, Vice Chair**
William A. Ash, Secretary

<i>Organization Represented</i>	<i>Name</i>
Alliance for Telephone Industry Solutions	Lawrence M. Slavin
American Insurance Services Group, Inc.	Vacant
American Public Power Association	Michael J. Hyland Nathan Mitchell (<i>Alt.</i>)
American Public Transit Association	Vacant
Association of American Railroads	Vacant
Association of Edison Illuminating Companies	Doug Mader Billy Raley (<i>Alt.</i>)
Bonneville Power Administration, US Department of Energy	Jerry L. Reding
Canadian Standards Association Liaison Representative	David Singleton
Edison Electric Institute	David G. Komassa John W. Troglia (<i>Alt.</i>)
Electronic Industries Association	Percy E. Pool Joseph Muccilo (<i>Alt.</i>)
Independent Electrical Contractors	James C. Tuggle Robert W. Baird (<i>Alt.</i>)
Institute of Electrical and Electronics Engineers, Inc.	Frank A. Denbrock Vernon R. Lawson (<i>Alt.</i>)
International Association of Government Labor Officials	Vacant
International Brotherhood of Electrical Workers	James R. Tomaseski
International Municipal Signal Association	Warren Farrell
National Association of Regulatory Utility Commissioners	Vacant
National Cable & Telecommunication Association	Rex Bullinger Christopher Austin (<i>Alt.</i>) Steve Mace (<i>Alt.</i>)
National Electrical Contractors Association	O. L. Davis Brooke H. Stauffer (<i>Alt.</i>)
National Electrical Manufacturers Association	Vincent Baclawski
National Rural Electric Cooperative Association	Robert D. Saint Michael C. Pehosh (<i>Alt.</i>)
National Safety Council	Jeff Clark
National Society of Professional Engineers	William F. Fuller
Rural Utilities Service, US Department of Agriculture	Robert Lash
Society of Cable Telecommunications Engineers	Alan Amato Timothy Cooke (<i>Alt.</i>)
Tennessee Valley Authority	Clayton L. Clem Stephen Cantrell (<i>Alt.</i>)
Western Area Power Administration, US Department of Energy	Vacant
Individual Member	O. Chuck Amrhyn
Individual Member	Allen L. Clapp
Liaison Representative to Canadian Electrical Code	Susan L. Vogel

Subcommittee 1
Purpose, Scope, Application, Definitions, and References
(Sections 1, 2, and 3)

Allen L. Clapp, Chair

Charles C. Bleakley, Secretary

O. Chuck Amrhn	(Main)	Frank A. Denbrock	(SC5)
Charles C. Bleakley	(SC7)	Allen L. Clapp	(Alt.)
John C. Spence	(Alt.)	Donald E. Hooper	(Interpretations)
D. J. Christofersen	(SC3)	David G. Komassa	(SC4)
Gary R. Engmann	(Alt.)	Eric K. Engdahl	(Alt.)
John B. Dagenhart	(SC2)	James R. Tomaseski	(SC8)
Ewell T. Robeson	(Alt.)	J. David Mitchell	(Alt.)

Subcommittee 2
Grounding Methods
(Section 9)

John B. Dagenhart, Chair

Ewell T. Robeson, Secretary

J. Boksiner	ATIS	Robert Molde	EEl
Harvey L. Bowles	RUS	Michael A. Moore	APPA
A. C. Channaiah	SEEX	Percy E. Pool	EIA
Keith Reese	(Alt.)	Joseph Muccilo	(Alt.)
John B. Dagenhart	IEEE	Ewell T. Robeson	EEl
M. M. Dixon	EEl	Robert D. Saint	NRECA
L. E. Gaunt	(Alt.)	Michael C. Pehosh	(Alt.)
William J. Turner	(Alt.)	James R. Tomaseski	IBEW
N. Maxwell	NARUC	Donald W. Zipse	IEEE

Subcommittee 3
Electric Supply Stations
(Sections 10–19)

D. J. Christofersen, Chair

Gary R. Engmann, Secretary

D. J. Christofersen	IEEE	Mark A. Konz	SEEX
A. L. Comans	AEIC	Christopher A. Carson	(Alt.)
W. Bruce Dietzman	IEEE	Robert E. Sipler, Jr.	NARUC
Gary R. Engmann	IEEE	James R. Tomaseski	IBEW
Keith C. Harrison	NRECA	Philip Young	EEl
Robert D. Saint	(Alt.)	George Zaczek	APPA
S. J. Kollmann	EEl		
Brian Winoski	(Alt.)		

AAR—Association of American Railroads
 AEIC—Association of Edison Illuminating Companies
 AISG—American Insurance Services Group, Inc.
 AISI—American Iron and Steel Institute
 APPA—American Public Power Association
 APTA—American Public Transit Association
 ATIS—Alliance for Telephone Industry Solutions
 AWWA—American Wood Preserves Association
 BPA—Bonneville Power Admin., US Dept. of Energy
 EEl—Edison Electric Institute
 EIA—Electronic Industries Association
 IAGLO—Int'l. Assoc. of Government Labor Officials

IBEW—International Brotherhood of Electrical Workers
 IEEE—Institute of Electrical and Electronics Engineers, Inc.
 IMSA—International Municipal Signal Association
 NARUC—National Association of Regulatory Utility Commissioners
 NCTA—National Cable Television Association
 NECA—National Electrical Contractors Association
 NEMA—National Electrical Manufacturers Association
 NSC—National Safety Council
 NSPE—National Society of Professional Engineers
 RUS—Rural Utilities Services, US Dept. of Agriculture
 SEEX—Southeastern Electric Exchange
 TVA—Tennessee Valley Authority
 WAPA—Western Area Power Administration, US Dept. of Energy

Subcommittee 4
Overhead Lines—Clearances
(Section 20, 21, 22, and 23)

David G. Komassa, Chair

O. Chuck Amrhn	Self
Chris Austin	NCTA
Rex Bullinger	(Alt.)
Steve Mace	(Alt.)
R. J. Bednarz	Self
Charles C. Bleakley	AEIC
Keith Reese	(Alt.)
James. L. Bohlk	RUS
Allen L. Clapp	Self
Charles Crawford	NSPE
Thomas R. Crowell	EEI
Phillip S. Givens	(Alt.)
Kevin Drzewiecki	EEI
Chris Ann Sheller	(Alt.)
Eric K. Engdahl	EEI
Tracy Dencker	(Alt.)
Mickey B. Gunter	EEI
Andrew Metrick	(Alt.)
Dennis Henry	ATIS
Trevor Bowmer	(Alt.)
Donald E. Hooper	Self

Eric K. Engdahl, Secretary

Jan Howard	APPA
H. N. Johnson, Jr.	SEEX
Joseph J. White	(Alt.)
David G. Komassa	EEI
David J. Marne	NSPE
Ernest H. Neubauer	NRECA
Michael C. Pehosh	(Alt.)
Robert G. Oswald	IEEE
Oliver W. Perkins	WAPA
Jerry L. Reding	BPA
Joseph Renowden	Emeritus
James Ruehl	NARUC
Mathew C. Schwarz	IEBE
Lawrence M. Slavin	ATIS
R. H. Stevens	Self
James R. Tomaseski	IBEW
B. J. Washburn	NARUC
Alan T. Young	EIA
Joseph Muccilo	(Alt.)
David C. Young	EEI

Subcommittee 5
Overhead Lines—Strength and Loading
(Sections 24, 25, 26, and 27)

Frank A. Denbrock, Chair

Julian Ajello	NARUC
Alan J. Amato	SCTE
Ted S. Woo	(Alt.)
Nelson G. Bingel	AWPA
Rex Bullinger	NCTA
Chris Austin	(Alt.)
Steve Mace	(Alt.)
John Busel	ACMA
Brian Lacoursiere	(Alt.)
Daniel Lonergan	(Alt.)
Jim Byrne	NRECA
Michael C. Pehosh	(Alt.)
Helen Chen	AISI
Richard Aichinger	(Alt.)
Allen L. Clapp	Self
Clayton L. Clem	TVA
Frank A. Denbrock	IEEE
Bruce Freimark	EEI
Robert S. Fuller	NSPE
Douglas Hanson	WAPA
Terry Burley	(Alt.)

Allen L. Clapp, Secretary

Edward Harrel	EEI
Donald G. Heald	RUS
Robert Lash	(Alt.)
Richard W. Hensel	IEEE
Walter D. Jones	IEEE
Leon Kempner, Jr.	BPA
Jim Kinghorn	NCEMC
Jacob Joplin	(Alt.)
Robert O. Kluge	EEI
Joseph Muccilo	EIA
Alan T. Young	(Alt.)
Robert C. Peters	IEBE
Joseph Rempé	APPA
Andrew Schwalm	IEEE
Wade Shultz	SEEX
Ron Corzine	(Alt.)
Lawrence M. Slavin	ATIS
Richard J. Stanford	EEI
Jose L. Vivas	EEI
Jerry C. Wong	EEI

**Subcommittee 7
Underground Lines
(Sections 30–39)**

Charles C. Bleakley, *Chair*

Alan J. Amato
O. Chuck Amrhyn
Chris Austin
 Steve Mace
 Rex Bullinger
Charles C. Bleakley
Mickey B. Gunter
Michael L. Dyer
R. A. Fernandez
 Percy E. Pool
Lauren E. Gaunt
Dennis Henry
 Trevor Bowmer
Trung Hiu

SCTE
 Self
NCTA
 (Alt.)
 (Alt.)
SEEX
 (Alt.)
APPA
 EIA
 (Alt.)
 EEI
ATIS
 (Alt.)
RUS

David H. Kendall
James D. Mars
Andrew Metrick
Dennis B. Miller
Michael C. Pehosh
 Robert D. Saint
George S. Pristach
Ewell T. Robeson
Lawrence M. Slavin
John C. Spence
Monte Szendre
James R. Tomaseski
Richard Vencus
Ted S. Woo

John C. Spence, *Secretary*

NEMA
 Self
 EEI
 EEI
NRECA
 (Alt.)
APTA
IBEE
ATIS
 EEI
NECA
IBEW
IEEE
SCTE

**Subcommittee 8
Work Rules
(Sections 40–44)**

James R. Tomaseski, *Chair*

Wayne P. Blackley
F. M. Brooks
Kenneth Brubaker
 Mark Zavislan
J. F. Doering
Brian Erga
Robert A. Fass
 Maury Dunn
Michael Granata
C. W. Grose
Dennis Henry
 Trevor Bowmer
Edward Hunt
Henry J. Kientz
 Jeffrey Wild
Brent McKinney
J. D. Mitchell
 Thomas Verdecchio

ATC
NSPE
NRECA
 (Alt.)
 Self
NWPPA
 EEI
 (Alt.)
 EEI
 Self
ATIS
 (Alt.)
WAPA
 Self
 (Alt.)
APPA
IEEE
 (Alt.)

Stephen Poholski
Thomas Ryder
Lawrence Schweitzer
Albert Smoak
Samuel Stonerock
Steven Theis
James R. Tomaseski
Gene Tootle
 David J. Nagy
D. M. Wallis
Jeffery A. White
 William C. Weintritt
Chuck Woodings
James C. Tuggle
Robert W. Baird

J. David Mitchell, *Secretary*

NECA
 EIA
 IEEE
NSPE
 EEI
NUCA
IBEW
SEEX
 (Alt.)
OSHA
AEIC
 (Alt.)
IEC
 (Alt.)
 (Alt.)

Executive Subcommittee

O. Chuck Amrhyn, *Chair*

O. Chuck Amrhyn
Frank A. Denbrock

Self
IEEE

Michael J. Hyland
Leon Kempner

Frank A. Denbrock, *Vice Chair*

APPA
BPA

Jennie M. Steinhagen
IEEE Standards Project Editor

Interpretations Subcommittee

Donald E. Hooper, *Chair*

O. Chuck Amrhyn	A	Mickey B. Gunter	P2, P3
R. J. Bednarz	A	Donald E. Hooper	A
Charles C. Bleakley	A	Herman N. Johnson, Jr.	A
D. J. Christofersen	P1	Henry J. Kientz	P4
Allen L. Clapp	A	Robert G. Oswald	P2
John B. Dagenhart	P2, S9	Percy E. Pool	P3, S9
O. L. Davis	P3	Wayne B. Roelle	P2
Frank A. Denbrock	A	Lanny L. Smith	A
Gary R. Engmann	P1	James R. Tomaseski	A
Emerson W. Glancy	A	David C. Young	A
Charles W. Grose	P4		

A = All areas, P1 = Part 1, P2 = Part 2, P3 = Part 3, P4 = Part 4, S9 = Section 9

Contents

<i>Section</i>	<i>Page</i>
Letter symbols for units	xxxiii
Sec. 1. Introduction to the National Electrical Safety Code	
010. Purpose.....	1
011. Scope.....	1
012. General rules	1
013. Application.....	1
A. New installations and extensions	1
B. Existing installations	2
014. Waiver.....	2
A. Emergency installations.....	2
B. Temporary overhead installations	2
015. Intent	2
016. Effective date	3
017. Units of measure	3
018. Method of calculation	4
Sec. 2. Definitions of special terms	5
Sec. 3. References	5
Sec. 9. Grounding methods for electric supply and communications facilities	
090. Purpose.....	17
091. Scope.....	17
092. Point of connection of grounding conductor	17
A. Direct-current systems that are to be grounded	17
1. 750 V and below.....	17
2. Over 750 V.....	17
B. Alternating current systems that are to be grounded.....	17
1. 750 V and below	17
2. Over 750 V	17
3. Separate grounding conductor.....	18
C. Messenger wires and guys	18
1. Messenger wires	18
2. Guys.....	18
3. Common grounding of messengers and guys on the same supporting structure	18
D. Current in grounding conductor	19
E. Fences	19
093. Grounding conductor and means of connection	20
A. Composition of grounding conductors	20
B. Connection of grounding conductors	20
C. Ampacity and strength	20
1. System grounding conductors for single-grounded systems	20
2. System grounding conductors for multi-grounded alternating current systems	20
3. Grounding conductors for instrument transformers	20
4. Grounding conductors for primary surge arresters	21
5. Grounding conductors for equipment, messenger wires, and guys.....	21
6. Fences	21
7. Bonding of equipment frames and enclosures	21
8. Ampacity limit.....	21

Contents

<i>Section</i>	<i>Page</i>
9. Strength.....	21
D. Guarding and protection	21
E. Underground	22
F. Common grounding conductor for circuits, metal raceways, and equipment	22
094. Grounding electrodes.....	22
A. Existing electrodes	22
1. Metallic water piping system	23
2. Local systems	23
3. Steel reinforcing bars in concrete foundations and footings	23
B. Made electrodes	23
1. General	23
2. Driven rods	23
3. Buried wire, strips, or plates	24
4. Pole-butt plates and wire wraps	24
5. Concentric neutral cable	24
6. Concrete-encased electrodes	25
7. Directly embedded metal poles	25
095. Method of connection to electrode	25
A. Ground connections	25
B. Point of connection to piping systems	26
C. Contact surfaces	26
096. Ground resistance requirements.....	26
A. General	26
B. Supply stations	26
C. Multi-grounded systems	27
D. Single-grounded (unigrounded or delta) systems	27
097. Separation of grounding conductors.....	27
098. Number 098 not used in this edition.....	28
099. Additional requirements for grounding and bonding of communication apparatus.....	28
A. Electrode	28
B. Electrode connection	29
C. Bonding of electrodes	29

Part 1. Rules for the Installation and Maintenance of Electric Supply Stations and Equipment

Sec. 10. Purpose and scope of rules.....	31
100. Purpose	31
101. Scope	31
102. Application of rules	31
103. Referenced sections	31
Sec. 11. Protective arrangements in electric supply stations	32
110. General requirements	32
A. Enclosure of equipment	32
1. Types of enclosures	32
2. Safety clearance zone	32
B. Rooms and spaces	32
1. Construction	32
2. Use	32
3. Ventilation	33
4. Moisture and weather	33
C. Electric equipment	33

Contents

<i>Section</i>	<i>Page</i>
111. Illumination.....	34
A. Under normal conditions	34
B. Emergency lighting	34
C. Fixtures	34
D. Attachment plugs and receptacles for general use	35
E. Receptacles in damp or wet locations	35
112. Floors, floor openings, passageways, and stairs	37
A. Floors	37
B. Passageways	37
C. Railings	37
D. Stair guards	37
E. Top rails	37
113. Exits	37
A. Clear exits.....	37
B. Double exits.....	37
C. Exit doors	38
114. Fire-extinguishing equipment.....	38
 Sec. 12. Installation and maintenance of equipment.....	 39
120. General requirements	39
121. Inspections	39
A. In-service equipment	39
B. Idle equipment	39
C. Emergency equipment	39
D. New equipment	39
122. Guarding shaft ends, pulleys, belts, and suddenly moving parts.....	39
A. Mechanical transmission machinery	39
B. Suddenly moving parts	39
123. Protective grounding.....	39
A. Protective grounding or physical isolation of non-current-carrying metal parts	39
B. Grounding method	40
C. Provision for grounding equipment during maintenance	40
D. Grounding methods for direct-current systems over 750 V	40
124. Guarding live parts.....	40
A. Where required	40
B. Strength of guards	40
C. Types of guards	40
1. Location or physical isolation	40
2. Shields or enclosures	41
3. Supplemental barriers or guards within electric supply stations	41
4. Mats	41
5. Live parts below supporting surfaces for persons	41
6. Insulating covering on conductors or parts	41
125. Working space about electric equipment.....	51
A. Working space (600 V or less).....	51
1. Clear spaces	51
2. Access and entrance to working space	51
3. Working space	52
4. Headroom working space	52
5. Front working space	52
B. Working space over 600 V	52
126. Equipment for work on energized parts.....	52
127. Classified locations	52
A. Coal-handling areas	53

Contents

Section	Page
B. Flammable and combustible liquids	53
C. Flammable liquid storage area.....	54
D. Loading and unloading facilities for flammable and combustible liquids	54
E. Gasoline-dispensing stations	54
F. Boilers	54
G. Gaseous hydrogen systems for supply equipment	54
H. Liquid hydrogen systems	54
I. Sulfur	55
J. Oxygen	55
K. Liquefied petroleum gas (LPG)	55
L. Natural gas (methane)	55
128. Identification.....	55
129. Mobile hydrogen equipment.....	55
Sec. 13. Rotating equipment.....	56
130. Speed control and stopping devices.....	56
A. Automatic overspeed trip device for prime movers.....	56
B. Manual stopping devices	56
C. Speed limit for motors	56
D. Number 130D not used in this edition	56
E. Adjustable-speed motors	56
F. Protection of control circuits	56
131. Motor control.....	56
132. Number 132 not used in this edition.....	57
133. Short-circuit protection.....	57
Sec. 14. Storage batteries	58
140. General.....	58
141. Location	58
142. Ventilation.....	58
143. Racks.....	58
144. Floors in battery areas.....	58
145. Illumination for battery areas.....	58
146. Service facilities.....	58
Sec. 15. Transformers and regulators	60
150. Current-transformer secondary circuits protection when exceeding 600 V	60
151. Grounding secondary circuits of instrument transformers.....	60
152. Location and arrangement of power transformers and regulators	60
A. Outdoor installations	60
B. Indoor installations	60
153. Short-circuit protection of power transformers.....	61
Sec. 16. Conductors	62
160. Application.....	62
161. Electrical protection.....	62
A. Overcurrent protection required	62
B. Grounded conductors	62
C. Insulated power cables	62
162. Mechanical protection and support.....	62
163. Isolation.....	62
164. Conductor terminations.....	62
A. Insulation	62
B. Metal-sheathed or shielded cable	62

Contents

<i>Section</i>	<i>Page</i>
Sec. 17. Circuit breakers, reclosers, switches, and fuses	63
170. Arrangement	63
171. Application.....	63
172. Circuit breakers, reclosers, and switches containing oil	63
173. Switches and disconnecting devices	63
A. Capacity	63
B. Provisions for disconnecting	63
174. Disconnection of fuses.....	63
Sec. 18. Switchgear and metal-enclosed bus	65
180. Switchgear assemblies	65
A. General requirements for all switchgear	65
B. Metal-enclosed power switchgear	65
C. Dead-front power switchboards	66
D. Motor control centers	66
E. Control switchboards.....	66
181. Metal-enclosed bus	66
A. General requirements for all types of bus	66
B. Isolated-phase bus	67
Sec. 19. Surge arresters.....	68
190. General requirements.....	68
191. Indoor locations	68
192. Grounding conductors.....	68
193. Installation.....	68
 Part 2. Safety Rules for the Installation and Maintenance of Overhead Electric Supply and Communication Lines	
Sec. 20. Purpose, scope, and application of rules	69
200. Purpose.....	69
201. Scope.....	69
202. Application of rules.....	69
Sec. 21. General requirements	70
210. Referenced sections	70
211. Number 211 not used in this edition	70
212. Induced voltages	70
213. Accessibility.....	70
214. Inspection and tests of lines and equipment	70
A. When in service	70
1. Initial compliance with rules	70
2. Inspection	70
3. Tests	70
4. Record of defects	70
5. Remedying defects	70
B. When out of service.....	71
1. Lines infrequently used	71
2. Lines temporarily out of service	71
3. Lines permanently abandoned	71
215. Grounding of circuits, supporting structures, and equipment.....	71
A. Methods	71
B. Circuits	71
1. Common neutral	71

Contents

Section	Page
2. Other neutrals	71
3. Other conductors.....	71
4. Surge arresters	71
5. Use of earth as part of circuit	71
C. Non-current-carrying parts	71
1. General	71
2. Anchor guys and span guys	72
3. Span wires carrying luminaires or traffic signals	72
4. Span wires carrying trolley or electric railway contact conductors	72
5. Use of insulators in anchor guys, span guys, and span wires supporting luminaires or traffic signals	72
6. Use of insulators in span wires supporting trolley or electric railroad contact conductors	72
7. Insulators used to limit galvanic corrosion	72
8. Multiple messengers on the same structure	73
216. Arrangement of switches	73
A. Accessibility	73
B. Indicating open or closed position	73
C. Locking	73
D. Uniform position	73
E. Remotely controlled, automatic transmission, or distribution overhead line switching devices.....	73
217. General.....	73
A. Supporting structures	73
1. Protection of structures	73
2. Readily climbable supporting structures	73
3. Identification	74
4. Obstructions	74
5. Decorative lighting	74
B. Unusual conductor supports	74
C. Protection and marking of guys	74
218. Vegetation management.....	75
A. General	75
B. At line crossings, railroad crossings and limited-access highway crossings.....	75
Sec. 22. Relations between various classes of lines and equipment.....	76
220. Relative levels.....	76
A. Standardization of levels	76
B. Relative levels: supply and communication conductors	76
1. Preferred levels	76
2. Special construction for supply circuits, the voltage of which is 600 V or less and carrying power not in excess of 5 kW	76
C. Relative levels: Supply lines of different voltage classifications (0 to 750 V, over 750 V to 8.7 kV, over 8.7 kV to 22 kV, and over 22 kV to 50 kV)	77
1. At crossings or conflicts	77
2. On structures used only by supply conductors	77
D. Identification of overhead conductors	77
E. Identification of equipment on supporting structures.....	77
221. Avoidance of conflict.....	77
222. Joint use of structures.....	77
223. Communications protective requirements	78
A. Where required	78
B. Means of protection	78

Contents

Section	Page
224. Communication circuits located within the supply space and supply circuits located within the communication space.....	78
A. Communication circuits located in the supply space	78
B. Supply circuits used exclusively in the operation of communication circuits	79
225. Electric railway construction	79
A. Trolley-contact conductor fastenings	79
B. High-voltage contact conductors	80
C. Third rails	80
D. Prevention of loss of contact at railroad crossings at grade	80
E. Guards under bridges	80
Sec. 23. Clearances	81
230. General.....	81
A. Application	81
1. Permanent and temporary installations	81
2. Emergency installations	81
3. Measurement of clearance and spacing	81
4. Rounding of calculation results	82
B. Ice and wind loading for clearances	82
C. Supply cables.....	83
D. Covered conductors	83
E. Neutral conductors	83
F. Fiber-optic cable	83
1. Fiber-optic—supply cable	83
2. Fiber-optic—communication cable	84
G. Alternating- and direct-current circuits.....	84
H. Constant-current circuits	84
I. Maintenance of clearances and spacings	84
231. Clearances of supporting structures from other objects.....	85
A. From fire hydrants	85
B. From streets, roads, and highways	86
C. From railroad tracks	86
232. Vertical clearances of wires, conductors, cables, and equipment above ground, roadway, rail, or water surfaces.....	86
A. Application	86
B. Clearance of wires, conductors, cables, equipment, and support arms mounted on supporting structures	87
1. Clearance to wires, conductors, and cables	87
2. Clearance to unguarded rigid live parts of equipment	87
3. Clearance to support arms, switch handles, and equipment cases.....	87
4. Street and area lighting	87
C. Additional clearances for wires, conductors, cables, and unguarded rigid live parts of equipment	87
1. Voltages exceeding 22 kV	87
D. Alternate clearances for voltages exceeding 98 kV ac to ground or 139 kV dc to ground	88
1. Sag conditions of line conductors	88
2. Reference heights	88
3. Electrical component of clearance	88
4. Limit	88
233. Clearances between wires, conductors, and cables carried on different supporting structures.....	98
A. General	98
1. Conductor movement envelope	99

Contents

Section	Page
2. Clearance envelope	99
B. Horizontal clearance	99
1. Clearance requirements	99
2. Alternate clearances for voltages exceeding 98 kV ac to ground or 139 kV dc to ground	99
C. Vertical clearance	99
1. Clearance requirements	99
2. Voltages exceeding 22 kV	100
3. Alternate clearances for voltage exceeding 98 kV ac to ground or 139 kV dc to ground.....	100
234. Clearance of wires, conductors, cables, and equipment from buildings, bridges, rail cars, swimming pools, and other installations	109
A. Application	109
1. Vertical and horizontal clearances (no wind displacement)	109
2. Horizontal clearances (with wind displacement)	110
3. Transition between horizontal and vertical clearances	110
B. Clearances of wires, conductors, and cables from other supporting structures	110
1. Horizontal clearances	110
2. Vertical clearances	111
C. Clearances of wires, conductors, cables, and rigid live parts from buildings, signs, billboards, chimneys, radio and television antennas, tanks, and other installations except bridges	111
1. Vertical and horizontal clearances	111
2. Guarding of supply conductors and rigid live parts.....	112
3. Supply conductors attached to buildings or other installations	112
4. Communication conductors attached to buildings or other installations	113
5. Ladder space	113
D. Clearance of wires, conductors, cables, and unguarded rigid live parts from bridges	113
1. Vertical and horizontal clearances	113
2. Guarding trolley-contact conductors located under bridges.....	114
E. Clearance of wires, conductors, cables, or unguarded rigid live parts installed over or near swimming areas with no wind displacement.....	114
1. Swimming pools	114
2. Beaches and waterways restricted to swimming	114
3. Waterways subject to water skiing	114
F. Clearances of wires, conductors, cables, and rigid live parts from grain bins	114
1. Grain bins loaded by permanently installed augers, conveyers, or elevator systems.....	114
2. Grain bins loaded by portable augers, conveyers, or elevators (with no wind displacement)	114
G. Additional clearances for voltages exceeding 22 kV for wires, conductors, cables, and unguarded rigid live parts of equipment	115
H. Alternate clearances for voltages exceeding 98 kV ac to ground or 139 kV dc to ground	115
1. Sag conditions of line conductors	115
2. Reference distances	115
3. Electrical component of clearance	115
4. Limit	116
I. Clearance of wires, conductors, and cables to rail cars	116
J. Clearance of equipment mounted on supporting structures	116
1. Clearance to unguarded rigid live parts of equipment	116
2. Clearance to equipment cases	116
235. Clearance for wires, conductors, or cables carried on the same supporting structure	134
A. Application of rule	134

Contents

Section	Page
1. Multiconductor wires or cables	134
2. Conductors supported by messengers or span wires	134
3. Line conductors of different circuits.....	134
B. Horizontal clearance between line conductors	135
1. Fixed supports	135
2. Suspension insulators	136
3. Alternate clearances for different circuits where one or both circuits exceed 98 kV ac to ground or 139 kV dc to ground	136
C. Vertical clearance between line conductors	137
1. Basic clearance for conductors of same or different circuits	137
2. Additional clearances	137
3. Alternate clearances for different circuits where one or both exceed 98 kV ac, or 139 kV dc to ground	139
4. Communication worker safety zone	139
D. Diagonal clearance between line wires, conductors, and cables located at different levels on the same supporting structure	140
E. Clearances in any direction from line conductors to supports, and to vertical or lateral conductors, span, or guy wires attached to the same support	140
1. Fixed supports	140
2. Suspension insulators	140
3. Alternate clearances for voltages exceeding 98 kV ac to ground or 139 kV dc to ground	140
F. Clearances between circuits of different voltage classifications located in the supply space on the same support arm	141
G. Conductor spacing: vertical racks or separate brackets	141
H. Clearance and spacing between communication conductors, cables, and equipment	142
I. Clearances in any direction from supply line conductors to communication antennas in the supply space attached to the same supporting structure	142
1. General	142
2. Communication antenna.....	142
3. Equipment case that supports a communication antenna	142
4. Vertical or lateral communication conductors and cables attached to a communication antenna.....	142
236. Climbing space.....	158
A. Location and dimensions.....	158
B. Portions of supporting structures in climbing space.....	158
C. Support arm location relative to climbing space	158
D. Location of equipment relative to climbing space	158
E. Climbing space between conductors	159
F. Climbing space on buckarm construction	159
G. Climbing space past longitudinal runs not on support arms	159
H. Climbing space past vertical conductors	160
I. Climbing space near ridge-pin conductors	160
237. Working space	162
A. Location of working spaces.....	162
B. Dimensions of working spaces	162
1. Along the support arm	162
2. At right angles to the support arm	162
3. Vertically	162
C. Location of vertical and lateral conductors relative to working spaces	162
D. Location of buckarms relative to working spaces	162
1. Standard height of working space	162
2. Reduced height of working space.....	162
E. Guarding of energized equipment	162

Contents

<i>Section</i>	<i>Page</i>
F. Working clearances from energized equipment	163
238. Vertical clearance between certain communications and supply facilities located on the same structure	163
A. Equipment	163
B. Clearances in general	163
C. Clearances for span wires or brackets	163
D. Clearance of drip loops of luminaire or traffic signal brackets	163
E. Communication worker safety zone	163
239. Clearance of vertical and lateral facilities from other facilities and surfaces on the same supporting structure	165
A. General	165
B. Location of vertical or lateral conductors relative to climbing spaces, working spaces, and pole steps	165
C. Conductors not in conduit	165
D. Guarding and protection near ground	166
E. Requirements for vertical and lateral supply conductors on supply line structures or within supply space on jointly used structures	166
1. General clearances	166
2. Special cases	166
F. Requirements for vertical and lateral communication conductors on communication line structures or within the communication space on jointly used structures	166
1. Clearances from communication conductors	166
2. Clearances from supply conductors	166
G. Requirements for vertical supply conductors and cables passing through communication space on jointly used line structures	167
1. Guarding—General	167
2. Cables and conductors in conduit or covering	167
3. Protection near trolley, ungrounded traffic signal, or ungrounded luminaire attachments	167
4. Aerial services	167
5. Clearance from through bolts and other metal objects	167
H. Requirements for vertical communication conductors passing through supply space on jointly used structures	168
1. Metal-sheathed communication cables	168
2. Communication conductors	168
3. Communication grounding conductors	168
4. Clearance from through bolts and other metal objects	168
I. Operating rods	168
J. Additional rules for standoff brackets	168
Sec. 24. Grades of construction	171
240. General	171
241. Application of grades of construction to different situations	171
A. Supply cables	171
B. Order of grades	171
C. At crossings	171
1. Grade of upper line	171
2. Grade of lower line	171
3. Multiple crossings	171
D. Conflicts	171
242. Grades of construction for conductors	172
A. Constant-current circuit conductors	172
B. Railway feeder and trolley-contact circuit conductors	172
C. Communication circuit conductors located in the supply space	172

Contents

Section	Page
D. Fire-alarm circuit conductors	172
E. Neutral conductors of supply circuits	172
F. Surge-protection wires	172
243. Grades of construction for line supports	176
A. Structures	176
B. Crossarms and support arms	176
C. Pins, armless construction brackets, insulators, and conductor fastenings	176
Sec. 25. Loadings for Grades B and C	177
250. General loading requirements and maps	177
A. General	177
B. Combined ice and wind district loading	177
C. Extreme wind loading	177
1. Velocity pressure exposure coefficient, k_z	178
2. Gust response factor, G_{RF}	178
D. Extreme ice with concurrent wind loading	179
251. Conductor loading	193
A. General	193
B. Load components	193
1. Vertical load component	193
2. Horizontal load component	193
3. Total load	194
252. Loads on line supports	194
A. Assumed vertical loads	194
B. Assumed transverse loads	194
1. Transverse loads from conductors and messengers	194
2. Wind loads on structures	194
3. At angles	195
4. Span lengths	195
C. Assumed longitudinal loading	195
1. Change in grade of construction	195
2. Jointly used poles at crossings over railroads, communication lines, or limited access highways	195
3. Deadends	195
4. Unequal spans and unequal vertical loads	196
5. Stringing loads	196
6. Longitudinal capability	196
7. Communication conductors on unguyed supports at railroad and limited access highway crossings	196
D. Simultaneous application of loads	196
253. Load factors for structures, crossarms, support hardware, guys, foundations, and anchors	196
Sec. 26. Strength requirements	199
260. General	199
A. Preliminary assumptions	199
B. Application of strength factors	199
261. Grades B and C construction	199
A. Supporting structures	199
1. Metal, prestressed-, and reinforced-concrete structures	200
2. Wood structures	200
3. Fiber-reinforced polymer structures	201
4. Transverse strength requirements for structures where side guying is required, but can be installed only at a distance	201

Contents

Section	Page
5. Longitudinal strength requirements for sections of higher grade in lines of a lower grade construction	201
B. Strength of foundations, settings, and guy anchors	202
C. Strength of guys and guy insulators	202
1. Metal and prestressed-concrete structures	202
2. Wood and reinforced-concrete structures	202
3. Fiber-reinforced polymer structures	202
D. Crossarms and braces	202
1. Concrete and metal crossarms and braces	202
2. Wood crossarms and braces	202
3. Fiber-reinforced polymer crossarms and braces	203
4. Crossarms and braces of other materials	203
5. Additional requirements	203
E. Insulators	203
F. Strength of pin-type or similar construction and conductor fastenings	204
1. Longitudinal strength	204
2. Double pins and conductor fastenings	204
3. Single supports used in lieu of double wood pins	204
G. Armless construction	204
1. General	204
2. Insulating material	204
3. Other components	204
H. Open supply conductors and overhead shield wires	204
1. Tensions	204
2. Splices, taps, dead-end fittings, and associated attachment hardware	205
3. Trolley-contact conductors	205
I. Supply cable messengers	205
J. Open-wire communication conductors	205
K. Communication cables	205
1. Communication cables	205
2. Messenger	205
L. Paired communication conductors	206
1. Paired conductors supported on messenger	206
2. Paired conductors not supported on messenger	206
M. Support and attachment hardware	206
N. Climbing and working steps and their attachments to the structure	206
262. Number 262 not used in this edition	209
263. Grade N construction	209
A. Poles	209
B. Guys	209
C. Crossarm strength	209
D. Supply-line conductors	209
1. Size	209
E. Service drops	209
1. Size of open-wire service drops	209
2. Tension of open-wire service drops	209
3. Cabled service drops	209
F. Trolley-contact conductors	210
G. Communication conductors	210
H. Street and area lighting equipment	210
I. Insulators	210
264. Guying and bracing	211
A. Where used	211
B. Strength	211

Section	Page
C. Point of attachment.....	211
D. Guy fastenings	212
E. Electrolysis	212
F. Anchor rods.....	212
Sec. 27. Line insulation.....	213
270. Application of rule	213
271. Material and marking.....	213
272. Ratio of flashover to puncture voltage.....	213
273. Insulation level.....	213
274. Factory tests	214
275. Special insulator applications	214
A. Insulators for constant-current circuits.....	214
B. Insulators for single-phase circuits directly connected to three-phase circuits	214
276. Number 276 not used in this edition.....	214
277. Mechanical strength of insulators	214
278. Aerial cable systems	215
A. Electrical requirements.....	215
B. Mechanical requirements	215
279. Guy and span insulators	215
A. Insulators	215
1. Properties of guy insulators	215
2. Galvanic corrosion and BIL insulation.....	216
B. Properties of span-wire insulators	216
1. Material.....	216
2. Insulation level	216
3. Mechanical strength.....	216
Sec. 28. Section number 28 not used in this edition.....	217
Sec. 29. Section number 29 not used in this edition.....	217

Part 3. Safety Rules for the Installation and Maintenance of Underground Electric Supply and Communication Lines

Sec. 30. Purpose, scope, and application of rules	219
300. Purpose.....	219
301. Scope.....	219
302. Application of rules.....	219
Sec. 31. General requirements applying to underground lines	220
310. Referenced sections	220
311. Installation and maintenance.....	220
312. Accessibility.....	220
313. Inspection and tests of lines and equipment	220
A. When in service	220
1. Initial compliance with safety rules.....	220
2. Inspection	220
3. Tests	220
4. Record of defects	220
5. Remedying defects	220
B. When out of service	220
1. Lines infrequently used	220
2. Lines temporarily out of service.....	220
3. Lines permanently abandoned	221
314. Grounding of circuits and equipment	221

Contents

Section	Page
A. Methods	221
B. Conductive parts to be grounded	221
C. Circuits	221
1. Neutrals	221
2. Other conductors	221
3. Surge arresters	221
4. Use of earth as part of circuit	221
315. Communications protective requirements	221
A. Where required	221
B. Means of protection	221
316. Induced voltage	222
Sec. 32. Underground conduit systems	223
320. Location	223
A. Routing	223
1. General	223
2. Natural hazards	223
3. Highways and streets	223
4. Bridges and tunnels	223
5. Crossing railroad tracks	223
6. Submarine crossing	223
B. Separation from other underground installations	224
1. General	224
2. Separations between supply and communication conduit systems	224
3. Sewers, sanitary and storm	224
4. Water lines	224
5. Gas and other lines that transport flammable material	224
6. Steam lines	224
321. Excavation and backfill	224
A. Trench	224
B. Quality of backfill	224
322. Ducts and joints	225
A. General	225
B. Installation	225
1. Restraint	225
2. Joints	225
3. Externally coated pipe	225
4. Building walls	225
5. Bridges	225
323. Manholes, handholes, and vaults	225
A. Strength	225
B. Dimensions	226
C. Manhole access	226
D. Covers	227
E. Vault and utility tunnel access	227
F. Ladder requirements	227
G. Drainage	227
H. Ventilation	227
I. Mechanical protection	227
J. Identification	227
Sec. 33. Supply cable	229
330. General	229
331. Sheaths and jackets	229

Contents

Section	Page
332. Shielding	229
A. General	229
B. Material	229
333. Cable accessories and joints.....	229
Sec. 34. Cable in underground structures	231
340. General.....	231
341. Installation.....	231
A. General.....	231
B. Cable in manholes and vaults	231
1. Supports.....	231
2. Clearance	231
3. Identification	232
342. Grounding and bonding	232
343. Fireproofing	232
344. Communication cables containing special supply circuits	233
Sec. 35. Direct-buried cable.....	234
350. General.....	234
351. Location and routing.....	235
A. General	235
B. Natural hazards	235
C. Other conditions.....	235
1. Swimming pools (in-ground)	235
2. Buildings and other structures	235
3. Railroad tracks	235
4. Highways and streets	235
5. Submarine crossings.....	235
352. Installation.....	236
A. Trenching	236
B. Plowing.....	236
C. Boring.....	236
D. Depth of burial	236
353. Deliberate separations—Equal to or greater than 300 mm (12 in) from underground structures or other cables.....	237
A. General	237
B. Crossings	237
C. Parallel facilities	237
D. Thermal protection	237
354. Random separation—Separation less than 300 mm (12 in) from underground structures or other cables	237
A. General	237
B. Supply cables or conductors.....	237
C. Communication cables or conductors	238
D. Supply and communication cables or conductors	238
1. General.....	238
2. Grounded bare or semiconducting jacketed neutral supply cables	238
3. Insulating jacketed grounded neutral supply cables	239
4. Insulating jacketed grounded neutral supply cables in nonmetallic duct.....	239
E. Supply and communication cables or conductors and non-metallic water and sewer lines	239
Sec. 36. Risers.....	240
360. General.....	240

Contents

<i>Section</i>	<i>Page</i>
361. Installation.....	240
362. Pole risers—Additional requirements.....	240
363. Pad-mounted installations.....	240
Sec. 37. Supply cable terminations.....	241
370. General.....	241
371. Support at terminations.....	241
372. Identification.....	241
373. Clearances in enclosures or vaults.....	241
374. Grounding.....	241
Sec. 38. Equipment.....	242
380. General.....	242
381. Design.....	242
382. Location in underground structures.....	243
383. Installation.....	243
384. Grounding and bonding.....	243
385. Identification.....	243
Sec. 39. Installation in tunnels.....	244
390. General.....	244
391. Environment.....	244
Part 4. Rules for the Operation of Electric Supply and Communications Lines and Equipment	
Sec. 40. Purpose and scope.....	245
400. Purpose.....	245
401. Scope.....	245
402. Referenced Sections.....	245
Sec. 41. Supply and communications systems—Rules for employers.....	246
410. General requirements.....	246
A. General.....	246
B. Emergency procedures and first aid rules.....	247
C. Responsibility.....	247
411. Protective methods and devices.....	250
A. Methods.....	250
B. Devices and equipment.....	250
C. Inspection and testing of protective devices.....	250
D. Signs and tags for employee safety.....	250
E. Identification and location.....	250
F. Fall protection.....	251
Sec. 42. General rules for employees.....	252
420. Personal general precautions.....	252
A. Rules and emergency methods.....	252
B. Qualifications of employees.....	252
C. Safeguarding oneself and others.....	252
D. Energized or unknown conditions.....	252
E. Ungrounded metal parts.....	253
F. Arcing conditions.....	253
G. Liquid-cell batteries.....	253
H. Tools and protective equipment.....	253
I. Clothing.....	253

Contents

Section	Page
J. Ladders and supports	253
K. Fall protection.....	253
L. Fire extinguishers.....	254
M. Machines or moving parts	254
N. Fuses	254
O. Cable reels	255
P. Street and area lighting	255
Q. Communication antennas	255
421. General operating routines.....	255
A. Duties of a first-level supervisor or person in charge.....	255
B. Area protection	255
1. Areas accessible to vehicular and pedestrian traffic	255
2. Areas accessible to employees only	255
3. Locations with crossed or fallen wires.....	256
C. Escort	256
422. Overhead line operating procedures	256
A. Setting, moving, or removing poles in or near energized electric supply lines	256
B. Checking structures before climbing.....	256
C. Installing and removing wires or cables.....	256
423. Underground line operating procedures.....	257
A. Guarding manhole and street openings	257
B. Testing for gas in manholes and unventilated vaults	257
C. Flames	257
D. Excavation	257
E. Identification.....	257
F. Operation of power-driven equipment.....	258
Sec. 43. Additional rules for communications employees.....	259
430. General.....	259
431. Approach to energized conductors or parts	259
432. Joint-use structures.....	260
433. Attendant on surface at joint-use manhole.....	260
434. Sheath continuity	261
Sec. 44. Additional rules for supply employees	262
440. General.....	262
441. Energized conductors or parts.....	262
A. Minimum approach distance to live parts	262
1. General.....	262
2. Precautions for approach—Voltages from 51 V to 300 V	262
3. Precautions for approach—Voltages from 301 V to 72.5 kV	262
4. Precautions for approach above 72.5 kV.....	263
5. Temporary (transient) overvoltage control device (TTOCD)	264
6. Altitude correction	264
7. Determining the minimum approach distances (distances to employee)	264
B. Additional approach requirements	264
C. Live-line tool clear insulation length.....	265
1. Clear live-line tool length.....	265
2. Live-line conductor support tool length	265
442. Switching control procedures	273
A. Designated person	273
B. Specific work.....	273
C. Operations at stations	273
D. Re-energizing after work	273
E. Tagging electric supply circuits associated with work activities	273
F. Restoration of service after automatic trip	274

Contents

Section	Page
G. Repeating oral messages	274
443. Work on energized lines and equipment.....	274
A. General requirements	274
B. Requirement for assisting employee	275
C. Opening and closing switches	275
D. Working position.....	275
E. Protecting employees by switches and disconnectors	275
F. Making connections	275
G. Switchgear	275
H. Current transformer secondaries	275
I. Capacitors	275
J. Gas-insulated equipment	276
K. Attendant on surface	276
L. Unintentional grounds on delta circuits.....	276
444. De-energizing equipment or lines to protect employees.....	276
A. Application of rule	276
B. Employee's request	276
C. Operating switches, disconnectors, and tagging.....	276
D. Employee's protective grounds	276
E. Proceeding with work	277
F. Reporting clear—Transferring responsibility	277
G. Removal of tags.....	277
H. Sequence of re-energizing	277
445. Protective grounds	277
A. Installing grounds	277
1. Current-carrying capacity of grounds.....	278
2. Initial connections.....	278
3. Test for voltage.....	278
4. Completing grounds	278
B. Removing grounds	278
446. Live work.....	278
447. Protection against arcing and other damage while installing and maintaining insulators and conductors.....	279
Appendix A—Uniform system of clearances (Adopted in the 1990 Edition).....	281
Appendix B—Uniform clearance calculations for conductors under ice and wind conditions (Adopted in the 2007 Edition).....	287
Appendix C—Example applications for Rule 250C Tables 250-2 and 250-3.....	290
Appendix D—Determining maximum anticipated per-unit overvoltage factor (T) at the worksite.....	301
Appendix E—Bibliography	302
Index	307
Procedure for revising the National Electrical Safety Code	329
Time schedule for the next revision of the National Electrical Safety Code.....	331
Working Group assignments and activities for the 2012 Edition.....	332

Contents

Figure	Rule	Page
Figure D-1	Sag and apparent sag.....	Sec. 2 11
Figure 110-1	Safety clearance to electric supply station fences.....	110A2 33
Figure 124-1	Clearance from live parts.....	124A1 42
Figure 124-2	Railings or fences used as guards.....	124 42
Figure 230-1	Clearance zone map of the United States.....	230B 84
Figure 233-1	Use of clearance envelope and conductor movement envelopes to determine applicable clearance.....	233A 101
Figure 233-2	Conductor movement envelope (m).....	233A1a 102
Figure 233-2	Conductor movement envelope (ft).....	233B 103
Figure 233-3	Clearance envelope.....	233B 104
Figure 234-1(a)	Clearance diagram for building.....	234A3 117
Figure 234-1(b)	Clearance diagram for other structures.....	234A3 118
Figure 234-1(c)	Transitional clearance when H is greater than V.....	234 118
Figure 234-2	Clearances of service drop terminating on support mast.....	234C3d(1)(b) 119
Figure 234-3	Swimming pool clearances.....	234E3 119
Figure 234-4(a)	Clearance envelope for grain bins filled by permanently installed augers, conveyors, or elevators.....	234F2c 120
Figure 234-4(b)	Clearance envelope for grain bins filled by portable augers, conveyors, or elevators.....	234F2a 120
Figure 234-5	Rail car clearances.....	234I 121
Figure 235-1	Clearance diagram for energized conductor.....	235D 142
Figure 236-1	Rule 236G, <i>Exception 3</i>	236G 160
Figure 237-1	Obstruction of working space by buckarm.....	237D1 163
Figure 250-1	General loading map of United States with respect to loading of overhead lines.....	250B 179
Figure 250-2(a)	Basic wind speeds.....	250C 180
Figure 250-2(b)	Basic wind speeds.....	250C 181
Figure 250-2(c)	Western Gulf of Mexico hurricane coastline.....	250C 182
Figure 250-2(d)	Eastern Gulf of Mexico and southeastern US hurricane coastline.....	250C 182
Figure 250-2(e)	Mid and northern Atlantic hurricane coastline.....	250C 183
Figure 250-3(a)	Uniform ice thickness with concurrent wind.....	250D 184
Figure 250-3(b)	Uniform ice thickness with concurrent wind.....	250D 185
Figure 250-3(c)	Uniform ice thickness with concurrent wind.....	250D 186
Figure 250-3(d)	Uniform ice thickness with concurrent wind.....	250D 186
Figure 250-3(e)	Uniform ice thickness with concurrent wind.....	250D 187
Figure 250-3(f)	Uniform ice thickness with concurrent wind.....	250D 188
Figure 279-1	Insulator used for BIL insulation.....	279A2 217
Figure 323-1	Roadway vehicle load.....	323A1 228
Figure 323-2	Wheel load area.....	323A1 228
Figure 350-1	Symbols for identification of buried cables.....	350G 234
 <i>Appendix figure</i>		
Figure A-1	—Clearance at maximum sag.....	286

Contents

<i>Table</i>		<i>Rule</i>	<i>Page</i>
Table 110-1	Values for use with Figure 110-1.....	11B2	34
Table 111-1	Illumination levels	111A	35
Table 124-1	Clearances from live parts.....	124A1	43
Table 125-1	Working space.....	125A3	52
Table 230-1	Ice thickness for purposes of calculating clearances.....	230B	85
Table 230-2	Ice, wind pressures, temperatures, and additive constants for purposes of calculating final inelastic deformation	230B	85
Table 232-1	Vertical clearance of wires, conductors, and cables above ground, roadway, rail, or water surfaces	232B1	89
Table 232-2	Vertical clearance of equipment cases, support arms, platforms, braces and unguarded rigid live parts above ground, roadway, or water surfaces	232B2	95
Table 232-3	Reference heights	232D2	97
Table 232-4	Electrical component of clearance in Rule 232D3a	232D3a	98
Table 233-1	Vertical clearance between wires, conductors, and cables carried on different supporting structures	233C1	104
Table 233-2	Clearance between supply wires, conductors, and cables in Rule 233C3b(1).....	233C3b(1)	107
Table 233-3	Reference heights	233C3a	109
Table 234-1	Clearance of wires, conductors, cables, and unguarded rigid live parts adjacent but not attached to buildings and other installations except bridges.....	234C1a	122
Table 234-2	Clearance of wires, conductors, cables, and unguarded rigid live parts from bridges	234D1a	128
Table 234-3	Clearance of wires, conductors, cables, or unguarded rigid live parts over or near swimming pools	234E1	131
Table 234-4	Electrical component of clearance of buildings, bridges, and other installations	234H3a	133
Table 234-5	Reference distances	234H2	134
Table 235-1	Horizontal clearance between wires, conductors, or cables at supports	235B1a	143
Table 235-2	Horizontal clearances between line conductors smaller than AWG No. 2 at supports, based on sags	235B1b(1)	144
Table 235-3	Horizontal clearances between line conductors AWG No. 2 or larger at supports, based on sags	235B1b(2)	146
Table 235-4	Electrical clearances in Rule 235B3a(1)	235B3a(1)	148
Table 235-5	Vertical clearance between conductors at supports	235C1	149
Table 235-6	Clearance in any direction from line conductors to supports and to vertical or lateral conductors, span, or guy wires attached to the same support	235E1	153
Table 235-7	Clearance in any direction from line conductors to supports	235E3b	157
Table 235-8	Vertical spacing between conductors supported on vertical racks or separate brackets.....	235	158
Table 236-1	Horizontal clearance between conductors bounding the climbing space.....	236E	161
Table 238-1	Vertical clearance between supply conductors and communications equipment, between communication conductors and supply equipment, and between supply and communications equipment	238B	164
Table 238-2	Vertical clearance of span wires and brackets from communication lines	238C	164
Table 239-1	Clearance of open vertical and lateral conductors	239E1	169
Table 239-2	Clearance between open vertical conductors and pole surface.....	239E2a(1)	170

Contents

<i>Table</i>	<i>Rule</i>	<i>Page</i>
Table 242-1	Grades of construction for supply conductors alone, at crossing, or on the same structures with other conductors242	173
Table 242-2	Grades of construction for communication conductors alone or in upper position of crossing or on joint poles.....242	175
Table 250-1	Ice, wind, and temperature250C	189
Table 250-2	Velocity pressure exposure coefficient k_z , structure, structure location, component, and wire250C	190
Table 250-3	Structure and wire gust response factors, G_{RF}250C	191
Table 250-4	Wind speed conversions to pressure250D	193
Table 251-1	Temperatures and constants251B3	194
Table 253-1	Load factors for structures, crossarms, support hardware, guys, foundations, and anchors to be used with the strength factors of Table 261-1A253	197
Table 253-2	Alternate load factors for wood and reinforced (not prestressed) concrete structures to be used with the strength factors of Table 261-1B.....253	198
Table 261-1A	Strength factors for structures, crossarms, braces, support hardware, guys, foundations, and anchors for use with load factors of Table 253-1261M	207
Table 261-1B	Strength factors for structures, crossarms, and braces for use with load factors of Table 253-2261D2	208
Table 261-2	Dimensions of crossarm cross section of select Southern Pine and Douglas Fir261D2	208
Table 263-1	Sizes for Grade N supply line conductors263D1	210
Table 263-2	Sizes of service drops of 750 V or less263B1a(1)	211
Table 273-1	Insulation level requirements273	214
Table 277-1	Allowed percentages of strength ratings277	215
Table 341-1	Clearance between supply and communications facilities in joint-use manholes and vaults341B2b(5)	232
Table 352-1	Supply cable or conductor burial depth352D2	236
Table 410-1	Clothing and clothing systems—voltage, fault current, and maximum clearing time for voltages 1 to 46 kV.....410A3	247
Table 410-2	Live-line tool work clothing and clothing systems—voltage, fault current, and maximum clearing time for voltages 46.1 to 800 kV.....410A3	248
Table 431-1	Communication work minimum approach distances431	259
Table 441-1	AC live work minimum approach distance441A4	266
Table 441-2	AC live work minimum approach distances for altitudes less than 900 m above sea level, where T has been determined according to Rule 441A5441A4	267
Table 441-3	AC live work minimum approach distances for altitudes less than 3000 ft above sea level, where the T has been determined according to Rule 441A5441A4	269
Table 441-4	DC live work minimum approach distance for altitudes less than 900 m above sea level441A1	271
Table 441-5	Altitude correction factor441A4	272
Table 441-6	Maximum use voltage for rubber insulating equipment441A4	272
 <i>Appendix tables</i>		
Table A-1	282
Table A-2a—Reference components of Rule 232	283
Table A-2b—Reference components of Rule 234	285

Letter symbols for units

This Code uses standard symbols for units. They have the following meanings:

A	ampere
C	degree Celsius
ft	foot
ft ²	square foot
ft ³	cubic foot
F	degree Fahrenheit
g	gram
Hz	hertz
h	hour
in	inch
in ²	square inch
k	kilo (10 ³)
kg	kilogram
kPa	kilopascal
km ²	square kilometer
kV	kilovolt (1000 volts)
kVA	kilovoltampere
kW	kilowatt
m	meter
m ²	square meter
m ³	cubic meter
m	milli (10 ⁻³)
mA	milliampere
mi	mile (international)
mm	millimeter
min	minute (time)
N	newton
Pa	pascal
lb	pound
s	second (time)
V	volt
W	watt

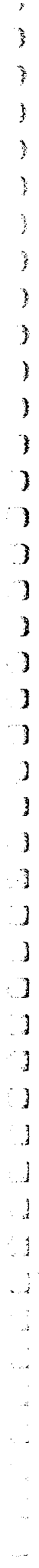

Section 1. Introduction to the National Electrical Safety Code®

010. Purpose

The purpose of these rules is the practical safeguarding of persons during the installation, operation, or maintenance of electric supply and communication lines and associated equipment.

These rules contain the basic provisions that are considered necessary for the safety of employees and the public under the specified conditions. This Code is not intended as a design specification or as an instruction manual.

011. Scope

A. These rules cover supply and communication lines, equipment, and associated work practices employed by a public or private electric supply, communications, railway, or similar utility in the exercise of its function as a utility. They cover similar systems under the control of qualified persons, such as those associated with an industrial complex or utility interactive system.

B. The NESC covers utility facilities and functions up to the service point.

NOTE: The National Electrical Code® (NEC®) (NFPA 70, 2005 Edition)^① covers utilization wiring requirements beyond the service point.

C. NESC rules cover street and area lights (supplied by underground or overhead conductors) under the exclusive control of utilities (including their authorized contractors) or other qualified persons (such as those associated with an industrial complex).

NOTE: Luminaires not under such exclusive control are governed by the requirements of the NEC.

D. NESC rules do not cover installations in mines, ships, railway rolling equipment, aircraft, or automotive equipment, or utilization wiring except as covered in Parts 1 and 3.

012. General rules

A. All electric supply and communication lines and equipment shall be designed, constructed, operated, and maintained to meet the requirements of these rules.

B. The utilities, authorized contractors, or other entities, as applicable, performing design, construction, operation, or maintenance tasks for electric supply or communication lines or equipment covered by this Code shall be responsible for meeting applicable requirements.

C. For all particulars not specified in these rules, construction and maintenance should be done in accordance with accepted good practice for the given local conditions known at the time by those responsible for the construction or maintenance of the communication or supply lines and equipment.

013. Application

A. New installations and extensions

1. These rules shall apply to all new installations and extensions, except that they may be waived or modified by the administrative authority. When so waived or modified, safety shall be provided in other ways.

^①Information on references can be found in Section 3.

EXAMPLE: Alternative working methods, such as the use of barricades, guards, or other electrical protective equipment, may be implemented along with appropriate alternative working clearances as a means of providing safety when working near energized conductors.

2. Types of construction and methods of installation other than those specified in the rules may be used experimentally to obtain information, if done where
 - a. Qualified supervision is provided,
 - b. Equivalent safety is provided, and
 - c. On joint use facilities, all affected parties agree.
- B. Existing installations
1. Where an existing installation meets, or is altered to meet, these rules, such installation is considered to be in compliance with this edition and is not required to comply with any previous edition.
 2. Existing installations, including maintenance replacements, that currently comply with prior editions of the Code, need not be modified to comply with these rules except (a) as may be required for safety reasons by the administrative authority or (b) as required by Rule 202.
 3. Where conductors or equipment are added, altered, or replaced on an existing structure, the structure or the facilities on the structure need not be modified or replaced if the resulting installation will be in compliance with either (a) the rules that were in effect at the time of the original installation, or (b) the rules in effect in a subsequent edition to which the installation has been previously brought into compliance, or (c) the rules of this edition in accordance with Rule 13B1.
- C. Inspection and work rules
- Inspection rules and work rules in the current edition of the NESC shall apply to inspection of or work on all new and existing installations.

014. Waiver

The person responsible for an installation may modify or waive rules in the case of emergency or temporary installations.

- A. Emergency installations
1. The clearances required in Section 23 may be decreased for emergency installations. See Rule 230A.
 2. The strength of material and construction for emergency installations shall be not less than that required for Grade N construction. See Rule 263.
 3. Emergency installations shall be removed, replaced, or relocated, as desired, as soon as practical.
- B. Temporary overhead installations
- When an installation is temporary, or where facilities are temporarily relocated to facilitate other work, the installation shall meet the requirements for non-temporary installation except that the strength of material and construction shall be not less than that required for Grade N construction. See Rule 263.

015. Intent

- A. The word "shall" indicates provisions that are mandatory.
- B. The word "should" indicates provisions that are normally and generally practical for the specified conditions. However, where the word "should" is used, it is recognized that, in certain instances, additional local conditions not specified herein may make these provisions impractical. When this occurs, the difference in conditions shall be appropriately recognized and Rule 12 shall be met.

- C. Footnotes to a table have the force and effect required or allowed by the rule that specifies the use of the table.
- D. Exceptions to a rule have the same force and effect required or allowed by the rule to which the exception applies.
- E. The word “*RECOMMENDATION*” indicates provisions considered desirable, but that are not intended to be mandatory.
- F. The word “*NOTE*” or the word “*EXAMPLE*” used in a rule indicates material provided for information or illustrative purposes only. “*NOTES*” and “*EXAMPLES*” are not mandatory and are not considered to be a part of Code requirements.
- G. A “*RECOMMENDATION*,” “*EXCEPTION*,” or “*NOTE*” applies to all text in that rule above its location that is indented to the same level.

016. Effective date

This edition may be used at any time on or after the publication date. Additionally, this edition shall become effective no later than 180 days following its publication date for application to new installations and extensions where both design and approval were started after the expiration of that period, unless otherwise stipulated by the administrative authority.

NOTE: A period of 180 days is allowed for utilities and regulatory authorities to acquire copies of the new edition and to change regulations, internal standards, and procedures as may be required. There is neither an intention to require or imply that this edition be implemented before 180 days from the publication date, nor an intention to prohibit earlier implementation.

017. Units of measure

- A. Numerical values in the requirements of this Code are stated in the metric system^① and in the customary inch-foot-pound system. In text, the metric value is shown first with the customary inch-foot-pound (inside parentheses) following. Extensive detailed tables are duplicated. The first, marked **m**, contains metric (SI) values; the second, marked **in**, **ft**, or **lb**, contains the inch-foot-pound values. Tensions and wind loads are stated in newtons, the SI unit of force.

The SI values and the customary inch-foot-pound values are not, nor are they intended to be, identical measures. The values shown in each system of measurement have been rounded to convenient numbers in order to simplify measurement and to minimize errors. The values shown in each system are functional equivalents for safety purposes.

The values required in this Code have been carefully developed and evaluated to ensure that the intended levels of safety are provided in both systems; neither is distinguishable from the other for safety purposes. The values specified in either system of measurement may be used, or the values of the two systems may be intermixed, as desired.^②

- B. Unless dimensions are specifically stated in this Code, the dimensions of physical items referenced in this Code, such as wires, are “nominal values” assigned for the purpose of convenient designation. Due to manufacturing limitations or other restraints, other standards may set tolerances, variations, or ranges for the dimensions of such items.

^①Le Systeme Internationale d’Unites (The International System of Units [or SI] in the modern version of the metric system). For basic information and conversion factors, see IEEE/ASTM SI 10™-1997 [B31], listed in Appendix E.

^②It is recognized that many equivalent utility system components may be purchased in both SI and customary units.

018. Method of calculation

Where calculations are required by these rules, the resultant value shall be rounded off to the nearest significant digit, unless otherwise specified in the applicable rule(s).

Section 2. Definitions of special terms

The following definitions are for use with the National Electrical Safety Code. For other use, and for definitions not contained herein, see *The Authoritative Dictionary of IEEE Standards Terms*.

administrative authority. The governmental authority exercising jurisdiction over application of this Code.

ampacity. The current-carrying capacity, expressed in amperes, of an electric conductor under stated thermal conditions.

anchorage. A secure point of attachment to which the fall protection system is connected.

automatic. Self-acting, operating by its own mechanism when actuated by some impersonal influence—as, for example, a change in current strength; not manual; without personal intervention. Remote control that requires personal intervention is not automatic, but manual.

backfill (noun). Materials such as sand, crushed stone, or soil, that are placed to fill an excavation.

ballast section (railroads). The section of material, generally trap rock, that provides support under railroad tracks.

bonding. The electrical interconnecting of conductive parts, designed to maintain a common electrical potential.

cable. A conductor with insulation, or a stranded conductor with or without insulation and other coverings (single-conductor cable), or a combination of conductors insulated from one another (multiple-conductor cable).

cable jacket. A protective covering over the insulation, core, or sheath of a cable.

cable sheath. A conductive protective covering applied to cables.

NOTE: A cable sheath may consist of multiple layers, of which one or more is conductive.

cable terminal. A device that provides insulated egress for the conductors. *Syn:* **termination**.

circuit. A conductor or system of conductors through which an electric current is intended to flow.

circuit breaker. A switching device capable of making, carrying, and breaking currents under normal circuit conditions and also making, carrying for a specified time, and breaking currents under specified abnormal conditions such as those of short circuit.

clearance. The clear distance between two objects measured surface to surface.

climbing. The vertical movement (ascending and descending) and horizontal movement to access or depart the worksite.

common use. Simultaneous use by two or more utilities of the same kind.

communication lines. *See:* **lines**.

conductor.

1. A material, usually in the form of a wire, cable, or bus bar, suitable for carrying an electric current.
2. **bundled conductor.** An assembly of two or more conductors used as a single conductor and employing spacers to maintain a predetermined configuration. The individual conductors of this assembly are called *subconductors*.
3. **covered conductor.** A conductor covered with a dielectric having no rated insulating strength or having a rated insulating strength less than the voltage of the circuit in which the conductor is used.
4. **fiber-optic conductor.** *See: fiber-optic cable—communication or fiber-optic cable—supply.*
5. **grounded conductor.** A conductor that is intentionally grounded, either solidly or through a noninterrupting current-limiting device.
6. **grounding conductor.** A conductor that is used to connect the equipment or the wiring system with a grounding electrode or electrodes.
7. **insulated conductor.** A conductor covered with a dielectric (other than air) having a rated insulating strength equal to or greater than the voltage of the circuit in which it is used.
8. **lateral conductor.** A wire or cable extending in a general horizontal direction at an angle to the general direction of the line conductors, and entirely supported on one structure.
9. **line conductor.** (Overhead supply or communication lines.) A wire or cable intended to carry electric currents, extending along the route of the line, supported by poles, towers, or other structures, but not including vertical or lateral conductors.
10. **open conductor.** A type of electric supply or communication line construction in which the conductors are bare, covered, or insulated and without grounded shielding, individually supported at the structure either directly or with insulators. *Syn: open wire.*

conductor shielding. An envelope that encloses the conductor of a cable and provides an equipotential surface in contact with the cable insulation.

conduit. A structure containing one or more ducts.

NOTE: Conduit may be designated as iron-pipe conduit, tile conduit, etc. If it contains only one duct, it is called *single-duct conduit*; if it contains more than one duct, it is called *multiple-duct conduit*, usually with the number of ducts as a prefix, e.g., *two-duct multiple conduit*.

conduit system. Any combination of duct, conduit, conduits, manholes, handholes, and/or vaults joined to form an integrated whole.

current-carrying part. A conducting part intended to be connected in an electric circuit to a source of voltage. Non-current-carrying parts are those not intended to be so connected.

de-energized. Disconnected from all sources of electrical supply by open switches, disconnectors, jumpers, taps, or other means.

NOTE: De-energized conductors or equipment could be electrically charged or energized through various means, such as induction from energized circuits, portable generators, lightning, etc.

designated person. A qualified person designated to perform specific duties under the conditions existing. *Syn: designated employee.*

disconnecting or isolating switch. A mechanical switching device used for changing the connections in a circuit or for isolating a circuit or equipment from a source of power.

NOTE: It is required to carry normal load current continuously as well as abnormal or short-circuit current for short intervals, as specified. It is also required to open or close circuits either when negligible current is broken or made, or when no significant change in the voltage across the terminals of each of the switch poles occurs. *Syn: disconnector, isolator.*

duct. A single enclosed raceway for conductors or cable.

effectively grounded. Intentionally connected to earth through a ground connection or connections of sufficiently low impedance and having sufficient current-carrying capacity to limit the buildup of voltages to levels below that which may result in undue hazard to persons or to connected equipment.

electric supply equipment. Equipment that produces, modifies, regulates, controls, or safeguards a supply of electric energy. *Syn:* **supply equipment.**

electric supply lines. *See:* **lines.**

electric supply station. Any building, room, or separate space within which electric supply equipment is located and the interior of which is accessible, as a rule, only to qualified persons. This includes generating stations and substations, including their associated generator, storage battery, transformer, and switchgear rooms or enclosures, but does not include facilities such as pad-mounted equipment and installations in manholes and vaults.

1. **generating station.** A plant wherein electric energy is produced by conversion from some other form of energy (e.g., chemical, nuclear, solar, mechanical, or hydraulic) by means of suitable apparatus. This includes all generating station auxiliaries and other associated equipment required for the operation of the plant. Not included are stations producing power exclusively for use with communications systems.
2. **substation.** An enclosed assemblage of equipment, e.g., switches, circuit breakers, buses, and transformers, under the control of qualified persons, through which electric energy is passed for the purpose of switching or modifying its characteristics.

enclosed. Surrounded by case, cage, or fence designed to protect the contained equipment and limit the likelihood, under normal conditions, of dangerous approach or accidental contact by persons or objects.

energized. Electrically connected to a source of potential difference, or electrically charged so as to have a potential significantly different from that of earth in the vicinity. *Syn:* **live.**

equipment. A general term including fittings, devices, appliances, fixtures, apparatus, and similar terms used as part of or in connection with an electric supply or communications system.

exposed. Not isolated or guarded.

fall arrest system. The assemblage of equipment, such as a line-worker's body belt, aerial belt, or full body harness in conjunction with a connecting means, with or without an energy absorbing device, and an anchor-age to limit the forces a worker can experience during a fall.

fall prevention system. A system, which may include a positioning device system, intended to prevent a worker from falling from an elevation.

fall protection program. A program intended to protect workers from injury due to falls from elevations.

fall protection system (hardware). Consists of either a fall prevention system or a fall arrest system.

fiber-optic cable—communication. A fiber optic cable meeting the requirements for a communication line and located in the communication space of overhead or underground facilities.

fiber-optic cable—supply. A fiber-optic cable located in the supply space of overhead or underground facilities.

fireproofing (of cables). The application of a fire-resistant covering.

generating station. *See:* electric supply station.

grounded. Connected to or in contact with earth or connected to some extended conductive body that serves instead of the earth.

grounded effectively. *See:* effectively grounded.

grounded system. A system of conductors in which at least one conductor or point is intentionally grounded, either solidly or through a noninterrupting current-limiting device.

guarded. Covered, fenced, enclosed, or otherwise protected, by means of suitable covers or casings, barrier rails or screens, mats or platforms, designed to limit the likelihood, under normal conditions, of dangerous approach or accidental contact by persons or objects.

NOTE: Wires that are insulated but not otherwise protected are not normally considered to be guarded. See exceptions under applicable rules.

handhole. An access opening, provided in equipment or in a below-the-surface enclosure in connection with underground lines, into which personnel reach but do not enter, for the purpose of installing, operating, or maintaining equipment or cable or both.

harness. A component with a design of straps that is fastened about the worker in a manner so as to contain the torso and distribute the fall arrest forces over at least the upper thighs, pelvis, chest, and shoulders with means for attaching it to other components and subsystems.

NOTE: Wherever the word *harness* is used in this Code, it refers to full body harness.

in service. Lines and equipment are considered in service when connected to the system and intended to be capable of delivering energy or communication signals, regardless of whether electric loads or signaling apparatus are presently being served from such facilities.

insulated. Separated from other conducting surfaces by a dielectric (including air space) offering a high resistance to the passage of current.

NOTE: When any object is said to be *insulated*, it is understood to be insulated for the conditions to which it is normally subjected. Otherwise, it is, within the purpose of these rules, uninsulated.

insulation (as applied to cable). That which is relied upon to insulate the conductor from other conductors or conducting parts or from ground.

insulation shielding. An envelope that encloses the insulation of a cable and provides an equipotential surface in contact with the cable insulation.

insulator. Insulating material in a form designed to support a conductor physically and electrically separate it from another conductor or object.

isolated. Not readily accessible to persons unless special means for access are used.

isolated by elevation. Elevated sufficiently so that persons may safely walk underneath.

isolator. *See:* disconnecting or isolating switch.

jacket. A protective covering over the insulation, core, or sheath of a cable.

joint use. Simultaneous use by two or more kinds of utilities.

lanyard. A flexible line or webbing, rope, wire rope, or strap that generally has a connector at each end for connecting the line-worker's body belt, aerial belt, or full body harness to an energy absorbing device, lifeline, or anchorage.

limited access highways. As used herein, limited access highways are fully controlled highways where access is controlled by a governmental authority for purposes of improving traffic flow and safety. Fully controlled access highways have no grade crossings and have carefully designed access connections.

lines.

1. **communication lines.** The conductors and their supporting or containing structures that are used for public or private signal or communications service, and which operate at potentials not exceeding 400 V to ground or 750 V between any two points of the circuit, and the transmitted power of which does not exceed 150 W. When operating at not more than 90 V ac or 150 V dc, no limit is placed on the transmitted power of the system. Under specified conditions, communication cables may include communication circuits exceeding the preceding limitation where such circuits are also used to supply power solely to communications equipment.

NOTE: Telephone, telegraph, railroad-signal, data, clock, fire, police-alarm, cable-television, and other systems conforming with the above are included. Lines used for signaling purposes, but not included under the above definition, are considered as supply lines of the same voltage and are to be so installed.

2. **electric supply lines.** Those conductors used to transmit electric energy and their necessary supporting or containing structures. Signal lines of more than 400 V are always supply lines within the meaning of the rules, and those of less than 400 V may be considered as supply lines, if so run and operated throughout. *Syn:* **supply lines.**

line-worker's body belt. A belt that consists of a belt strap and D-rings and which may include a cushion section or a tool saddle.

live. *See:* **energized.**

manhole. A subsurface enclosure that personnel may enter used for the purpose of installing, operating, and maintaining submersible equipment and cable.

manhole cover. A removable lid that closes the opening to a manhole or similar subsurface enclosure.

manhole grating. A grid that provides ventilation and a protective cover for a manhole opening.

manual. Capable of being operated by personal intervention.

minimum approach distance. The closest distance a qualified employee is permitted to approach either an energized or a grounded object, as applicable for the work method being used.

multigrounded/multiple grounded system. A system of conductors in which a neutral conductor is intentionally grounded solidly at specified intervals. A multigrounded or multiple grounded system may or may not be effectively grounded. *See:* **effectively grounded.**

neutral conductor. A system conductor other than a phase conductor that provides a return path for current to the source. Not all systems have a neutral conductor. An example is an ungrounded delta system containing only three energized phase conductors.

out of service. Lines and equipment are considered out of service when disconnected from the system and when not intended to be capable of delivering energy or communications signals.

overhead ground wire. *See: shield wire.*

overvoltage. Voltage between two points of a system that is greater than the highest value appearing between the same two points under normal service conditions. Overvoltages include, but are not limited to, switching impulse (switching surge) overvoltages and temporary (transient) overvoltages.

pad-mounted equipment. A general term describing enclosed equipment, the exterior of which enclosure is at ground potential, positioned on a surface-mounted pad.

positioning device system. A system of equipment or hardware that, when used with its line-worker's body belt or full body harness, allows a worker to be supported on an elevated vertical surface, such as a pole or tower, and work with both hands free.

positioning strap. A strap with snaphook(s) to connect to the D-rings of a line-worker's body belt or full body harness.

prestressed-concrete structures. Concrete structures that include metal tendons that are tensioned and anchored either before or after curing of the concrete.

pulling iron. An anchor secured in the wall, ceiling, or floor of a manhole or vault to attach rigging used to pull cable.

pulling tension. The longitudinal force exerted on a cable during installation.

qualified. Having been trained in and having demonstrated adequate knowledge of the installation, construction, or operation of lines and equipment and the hazards involved, including identification of and exposure to electric supply and communication lines and equipment in or near the workplace. An employee who is undergoing on-the-job training and who, in the course of such training, has demonstrated an ability to perform duties safely at his or her level of training, and who is under the direct supervision of a qualified person, is considered to be a qualified person for the performance of those duties.

qualified climber. A worker who, by reason of training and experience, understands the methods and has routinely demonstrated proficiency in climbing techniques and familiarity with the hazards associated with climbing.

raceway. Any channel designed expressly and used solely for holding conductors.

random separation. Installed with no deliberate separation.

remotely operable (as applied to equipment). Capable of being operated from a position external to the structure in which it is installed or from a protected position within the structure.

roadway. The portion of highway, including shoulders, for vehicular use. *See also: shoulder; traveled way.*

NOTE: A divided highway has two or more roadways.

rural districts. All places not urban. This may include thinly settled areas within city limits.

sag.

1. The distance measured vertically from a conductor to the straight line joining its two points of support. Unless otherwise stated in the rule, the sag referred to is the sag at the midpoint of the span. See Figure D-1.
2. **initial unloaded sag.** The sag of a conductor prior to the application of any external load.

3. **final sag.** The sag of a conductor under specified conditions of loading and temperature applied, after it has been subjected for an appreciable period to the loading prescribed for the clearance zone in which it is situated, or equivalent loading, and the loading removed. Final sag shall include the effect of inelastic deformation.
4. **final unloaded sag.** The sag of a conductor after it has been subjected for an appreciable period to the loading prescribed for the clearance zone in which it is situated, or equivalent loading, and the loading removed. Final unloaded sag shall include the effect of inelastic deformation.
5. **total sag.** The distance measured vertically from the conductor to the straight line joining its two points of support, under conditions of ice loading equivalent to the total resultant loading for the clearance zone in which it is located.
6. **maximum total sag.** The total sag at the midpoint of the straight line joining the two points of support of the conductor.
7. **apparent sag of a span.** The maximum distance between the wire in a given span and the straight line between the two points of support of the wire, measured perpendicularly from the straight line. See Figure D-1.
8. **sag of a conductor at any point in a span.** The distance measured vertically from the particular point in the conductor to a straight line between its two points of support.
9. **apparent sag at any point in the span.** The distance, at the particular point in the span, between the wire and the straight line between the two points of support of the wire, measured perpendicularly from the straight line.

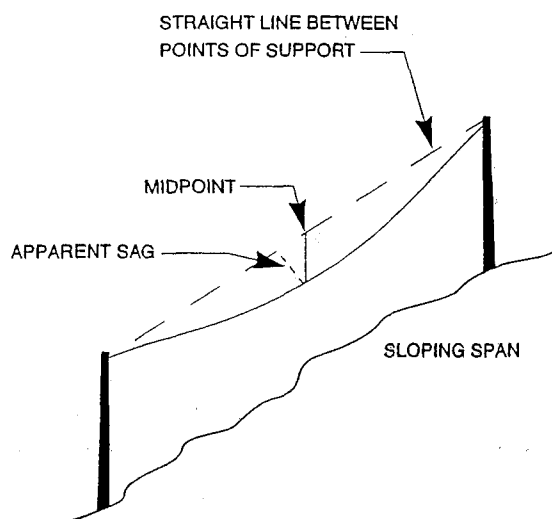

Figure D-1—Sag and apparent sag

separation. The distance between two objects, measured surface to surface, and usually filled with a solid or liquid material.

service drop. The overhead conductors between the electric supply or communication line and the building or structure being served.

service point. The point of connection between the facilities of the serving utility and the premises wiring.

shield wire (also referred to as overhead ground wire, static wire, or surge-protection wire). A wire or wires, which may or may not be grounded, strung parallel to and above phase conductors to protect the power system from lightning strikes.

shoulder. The portion of the roadway contiguous with the traveled way for accommodation of stopped vehicles for emergency use and for lateral support of base and surface course.

side-wall pressure. The crushing force exerted on a cable during installation.

single-grounded system/unigrounded system. A system of conductors in which one conductor is intentionally grounded solidly at a specific location, typically at the source.

spacer cable. A type of electric supply-line construction consisting of an assembly of one or more covered conductors, separated from each other and supported from a messenger by insulating spacers.

span length. The horizontal distance between two adjacent supporting points of a conductor.

span wire. An auxiliary suspension wire that serves to support one or more trolley contact conductors or a light fixture and the conductors that connect it to a supply system.

static wire. *See:* shield wire.

structure conflict. A line so situated with respect to a second line that the overturning of the first line will result in contact between its supporting structures or conductors and the conductors of the second line, assuming that no conductors are broken in either line.

substation. *See:* electric supply station.

supply equipment. *See:* electric supply equipment.

supply station. *See:* electric supply station.

supporting structure. The main supporting unit (usually a pole or tower) used to support supply and/or communication conductors, cables, and equipment.

1. **readily climbable.** A supporting structure having sufficient handholds or footholds so that the structure can be climbed easily by an average person without using a ladder, tools or devices, or extraordinary physical effort.
2. **not readily climbable.** A supporting structure not meeting the definition of a readily climbable structure, including but not limited to the following:
 - a. supporting structures, including poles and tower legs, with handholds or footholds arranged so that there is not less than 2.45 m (8 ft) between either: (1) the lowest handhold or foothold and ground or other accessible surface, or (2) the two lowest handholds or footholds. Diagonal braces on towers are not considered to be handholds or footholds except at their points of attachment.
 - b. guy wires

surge-protection wire. *See:* shield wire.

susceptiveness. The characteristics of a communication circuit, including its connected apparatus, that determine the extent to which it is adversely affected by inductive fields.

switch. A device for opening and closing or for changing the connection of a circuit. In these rules, a switch is understood to be manually operable, unless otherwise stated.

switchboard. A type of switchgear assembly that consists of one or more panels with electric devices mounted thereon, and associated framework.

tag. Accident prevention tag (DANGER, PEOPLE AT WORK, etc.) of a distinctive appearance used for the purpose of personnel protection to indicate that the operation of the device to which it is attached is restricted.

termination. *See:* cable terminal.

transferring (as applied to fall protection). The act of moving from one distinct object to another (e.g., between an aerial device and a structure).

transformer vault. An isolated enclosure either above or below ground with fire-resistant walls, ceiling, and floor, in which transformers and related equipment are installed, and which is not continuously attended during operation. *See also:* vault.

transitioning (as applied to fall protection). The act of moving from one location to another on equipment or a structure.

traveled way. The portion of the roadway for the movement of vehicles, exclusive of shoulders and full-time parking lanes.

ungrounded system. A system of conductors in which no conductor or point is intentionally grounded, either solidly or through a noninterrupting current-limiting device.

ungrounded system. *See:* single-grounded system/ungrounded system.

unloaded tension.

1. **initial.** The longitudinal tension in a conductor prior to the application of any external load.
2. **final.** The longitudinal tension in a conductor after it has been subjected for an appreciable period to the loading prescribed for the loading district in which it is situated, or equivalent loading, and the loading removed. Final unloaded tension shall include the effect of inelastic deformation (creep).

urban districts. Thickly settled areas (whether in cities or suburbs) or where congested traffic often occurs. A highway, even though in thinly settled areas, on which the traffic is often very heavy, is considered as urban.

utility. An organization responsible for the installation, operation, or maintenance of electric supply or communications systems.

utility interactive system. An electric power production system that is operating in parallel with and capable of delivering energy to a utility electric supply system.

utilization equipment. Equipment, devices, and connected wiring that utilize electric energy for mechanical, chemical, heating, lighting, testing, or similar purposes and are not a part of supply equipment, supply lines, or communication lines.

vault. A structurally solid enclosure, including all sides, top, and bottom, above or below ground where entry is limited to personnel qualified to install, maintain, operate, or inspect the equipment or cable enclosed. The enclosure may have openings for ventilation, personnel access, cable entrance, and other openings required for operation of equipment in the vault.

voltage.

1. The effective (rms) potential difference between any two conductors or between a conductor and ground. Voltages are expressed in nominal values unless otherwise indicated. The nominal voltage of a system or circuit is the value assigned to a system or circuit of a given voltage class for the

purpose of convenient designation. The operating voltage of the system may vary above or below this value.

2. **voltage of circuit not effectively grounded.** The highest nominal voltage available between any two conductors of the circuit.

NOTE: If one circuit is directly connected to and supplied from another circuit of higher voltage (as in the case of an autotransformer), both are considered to be of the higher voltage, unless the circuit of the lower voltage is effectively grounded, in which case its voltage is not determined by the circuit of higher voltage. Direct connection implies electric connection as distinguished from connection merely through electromagnetic or electrostatic induction.

3. **voltage of a constant-current circuit.** The highest normal full-load voltage of the circuit.
4. **voltage of an effectively grounded circuit.** The highest nominal voltage available between any conductor of the circuit and ground unless otherwise indicated.
5. **voltage to ground of:**
 - a. **a grounded circuit.** The highest nominal voltage available between any conductor of the circuit and that point or conductor of the circuit that is grounded.
 - b. **an ungrounded circuit.** The highest nominal voltage available between any two conductors of the circuit concerned.
6. **voltage to ground of a conductor of:**
 - a. **a grounded circuit.** The nominal voltage between such conductor and that point or conductor of the circuit that is grounded.
 - b. **an ungrounded circuit.** The highest nominal voltage between such conductor and any other conductor of the circuit concerned.

wire gages. Throughout these rules the American Wire Gage (AWG), formerly known as Brown & Sharpe (B&S), is the standard gage for copper, aluminum, and other conductors, excepting only steel conductors, for which the Steel Wire Gage (Stl WG) is used.

NOTE: The Birmingham Wire Gage is obsolete.

worksite (as applied to fall protection). The location on the structure or equipment where, after the worker has completed the climbing (horizontally and vertically), the worker is in position to perform the assigned work or task.

Section 3. References

The following standards form a part of the National Electrical Safety Code to the extent indicated in the rules herein. ④

- | ANSI C29.1-1988 (R2002), American National Standard Test Methods for Electrical Power Insulators. [Rules 272, 273, and 277 NOTE 1a] ⑤
- | ANSI C29.2-1992 (R1999), American National Standard for Wet-Process Porcelain and Toughened Glass Insulators (Suspension Type). [Rules 272 and 441B4c]
- | ANSI C29.3-1986 (R2002), American National Standard for Wet-Process Porcelain Insulators (Spool Type). [Rule 272]
- | ANSI C29.4-1989 (R2002), American National Standard for Wet-Process Porcelain Insulators (Strain Type). [Rule 272]
- | ANSI C29.5-1984 (R2002), American National Standard for Low- and Medium-Voltage Pin Type Wet-Process Porcelain Insulators. [Rule 272]
- | ANSI C29.6-1996 (R2002), American National Standard for High-Voltage Pin Type Wet-Process Porcelain Insulators. [Rule 272]
- | ANSI C29.7-1996 (R2002), American National Standard for High-Voltage Line-Post Type Wet-Process Porcelain Insulators. [Rules 272 and 277 NOTE 2]
- | ANSI C84.1-1995 (R2001), American National Standard for Voltage Ratings for Electric Power Systems and Equipment (60 Hz). [Rule 441]
- | ANSI O5.1-1992, American National Standard Specifications and Dimensions for Wood Poles. [Rule 261]
- | ANSI Z535.1-2006, American National Standard for Safety Color Code. [Rules 110A1 NOTE, 217A1c NOTE, 323C4 NOTE, 381G2 NOTE, and 411D]
- | ANSI Z535.2-2006, American National Standard for Environmental and Facility Safety Signs. [Rules 110A1 NOTE, 217A1c NOTE, 323C4 NOTE, 381G2 NOTE, and 411D]
- | ANSI Z535.3-2006, American National Standard for Criteria for Safety Symbols. [Rules 110A1 NOTE, 217A1c NOTE, 323C4 NOTE, 381G2 NOTE, and 411D]
- | ANSI Z535.4-2006, American National Standard for Product Safety Signs and Labels. [Rules 110A1 NOTE, 217A1c NOTE, 323C4 NOTE, 381G2 NOTE, and 411D]
- | ANSI Z535.5-2006, American National Standard for Accident Prevention Tags (for Temporary Hazards). [Rules 110A1 NOTE, 217A1c NOTE, 323C4 NOTE, 381G2 NOTE, and 411D]
- | ANSI/SIA A92.2-1992, American National Standard for Vehicle Mounted Elevating and Rotating Aerial Devices. [Rule 446]

④The standards listed here were the editions used in this revision of the Code. In some cases, newer editions may be in effect. Contact the publisher for information about availability.

⑤ANSI publications are available from the Sales Department, American National Standards Institute, 25 West 43rd Street, 4th Floor, New York, NY 10036, USA (<http://www.ansi.org/>).

- ASCE 7-2005, ASCE Standard for Minimum Design Loads for Buildings and Other Structures. [Rule 250C] ^⑥
- ASME B15.1-2000, ASME Standard for Mechanical Power Transmission Apparatus. [Rule 122]
- ASTM D 178-1993 (R1998), ASTM Standard Specification for Rubber Insulating Matting. [Rule 124] ^⑦
- IEEE 100, *The Authoritative Dictionary of IEEE Standards Terms*, Seventh Edition. [Section 2, General] ^⑧
- IEEE Std 4TM-1995, IEEE Standard Techniques for High-Voltage Testing. [Rule 441] ^⑨
- IEEE Std 516TM-2003, IEEE Guide for Maintenance Methods on Energized Power-Lines. [Rules 441 and 446]
- IEEE Std 1313TM-1993, IEEE Standard for Power Systems—Insulation Coordination. [Rule 124] ^⑩
- NFPA 30-2000, Flammable and Combustible Liquids Code. [Rule 127] ^⑪
- NFPA 58-2001, Storage and Handling of Liquefied Petroleum Gases. [Rule 127]
- NFPA 59-2001, Storage and Handling of Liquefied Petroleum Gases at Utility Gas Plants. [Rule 127]
- NFPA 59A-2001, Production, Storage, and Handling of Liquefied Natural Gas (LNG). [Rule 127]
- NFPA 70, 2005 Edition, National Electrical Code[®] (NEC[®]). [Rules 11, 124, and 127]
- NFPA 496-1998, Standard for Purged and Pressurized Enclosures for Electrical Equipment. [Rule 127]
- NFPA 8503-1997, Standard for the Installation and Operation of Pulverized Fuel Systems. [Rule 127]

^⑥ASCE publications are available from ASCE Publications, 1801 Alexander Bell Dr., Reston, VA 20191, (800) 548-ASCE (2723) (<http://www.asce.org>).

^⑦ASTM publications are available from the American Society for Testing and Materials, 100 Barr Harbor Drive, West Conshohocken, PA 19428-2959, USA (<http://www.astm.org/>).

^⑧IEEE publications are available from the Institute of Electrical and Electronics Engineers, 445 Hoes Lane, P.O. Box 1331, Piscataway, NJ 08855-1331, USA (<http://standards.ieee.org/>).

^⑨The IEEE standards or products referred to in this clause are trademarks of the Institute of Electrical and Electronics Engineers, Inc.

^⑩IEEE Std 1313-1993 has been withdrawn; however, copies can be obtained from Global Engineering, 15 Inverness Way East, Englewood, CO 80112-5704, USA, tel. (303) 792-2181 (<http://global.ihs.com/>).

^⑪NFPA publications are available from Publications Sales, National Fire Protection Association, 1 Batterymarch Park, P.O. Box 9101, Quincy, MA 02269-9101, USA (<http://www.nfpa.org/>).

Section 9. Grounding methods for electric supply and communications facilities

090. Purpose

The purpose of Section 9 of this Code is to provide practical methods of grounding, as one of the means of safeguarding employees and the public from injury that may be caused by electrical potential.

091. Scope

Section 9 of this Code covers methods of protective grounding of supply and communication conductors and equipment. The rules requiring grounding are in other parts of this Code.

These rules do not cover the grounded return of electric railways nor those lightning protection wires that are normally independent of supply or communication wires or equipment.

092. Point of connection of grounding conductor

A. Direct-current systems that are to be grounded

1. 750 V and below

Connection shall be made only at supply stations. In three-wire dc systems, the connection shall be made to the neutral.

2. Over 750 V

Connection shall be made at both the supply and load stations. The connection shall be made to the neutral of the system. The ground or grounding electrode may be external to or remotely located from each of the stations.

One of the two stations may have its grounding connection made through surge arresters provided the other station neutral is effectively grounded as described above.

EXCEPTION: Where the stations are not geographically separated as in back-to-back converter stations, the neutral of the system should be connected to ground at one point only.

B. Alternating current systems that are to be grounded

1. 750 V and below

The point of the grounding connection on a wye-connected three-phase four-wire system, or on a single-phase three-wire system, shall be the neutral conductor. On other one-, two-, or three-phase systems with an associated lighting circuit or circuits, the point of grounding connection shall be on the common circuit conductor associated with the lighting circuits.

The point of grounding connection on a three-phase three-wire system, whether derived from a delta-connected or an ungrounded wye-connected transformer installation not used for lighting, may be any of the circuit conductors, or it may be a separately derived neutral.

The grounding connections shall be made at the source, and at the line side of all service equipment.

2. Over 750 V

a. Nonshielded (bare or covered conductors or insulated nonshielded cables)

Grounding connection shall be made at the neutral of the source. Additional connections may be made, if desired, along the length of the neutral, where this is one of the system conductors.

b. Shielded

(1) Surge-arrester cable-shielding interconnection

Cable-shielding grounds shall be bonded to surge-arrester grounds, where provided, at points where underground cables are connected to overhead lines.

(2) Cable without insulating jacket

Connection shall be made to the neutral of the source transformer and at cable termination points.

(3) Cable with insulating jacket

Additional bonding and connections between the cable insulation shielding or sheaths and the system ground are recommended. Where multi-grounded shielding cannot be used for electrolysis or sheath-current reasons, the shielding sheaths and splice-enclosure devices shall be insulated for the voltage that may appear on them during normal operation.

Bonding transformers or reactors may be substituted for direct ground connection at one end of the cable.

3. Separate grounding conductor

If a separate grounding conductor is used as an adjunct to a cable run underground, it shall be connected either directly or through the system neutral to the source transformers, source transformer accessories, and cable accessories where these are to be grounded. This grounding conductor shall be located in the same direct burial or conduit run as the circuit conductors. If run in duct of magnetic material, the grounding conductor shall be run in the same duct as the circuit conductors.

EXCEPTION: The grounding conductor for a circuit that is installed in a magnetic duct need not be in the same duct if the duct containing the circuit is bonded to the separate grounding conductor at both ends.

C. Messenger wires and guys

1. Messenger wires

Messenger wires required to be grounded shall be connected to grounding conductors at poles or structures at maximum intervals as listed below:

- a. Where messenger wires are adequate for system grounding conductors (Rules 93C1, 93C2, and 93C5), four connections in each 1.6 km (1 mi).
- b. Where messenger wires are not adequate for system grounding conductors, eight connections in each 1.6 km (1 mi), exclusive of service grounds.

2. Guys

Guys that are required to be grounded shall be connected to one or more of the following:

- a. A grounded metallic supporting structure.
- b. An effective ground on a nonmetallic supporting structure.
- c. A line conductor that has at least four ground connections in each mile of line in addition to the ground connections at individual services.

3. Common grounding of messengers and guys on the same supporting structure

- a. Where messengers and guys on the same supporting structure are required to be grounded, they shall be bonded together and grounded by connection to:
 - (1) One grounding conductor that is grounded at that structure, or to
 - (2) Separate grounding conductors or grounded messengers that are bonded together and grounded at that structure, or to
 - (3) One or more grounded line conductors or grounded messengers that are (a) bonded together at this structure or elsewhere and (b) multi-grounded elsewhere at intervals as specified in Rules 92C1 and 92C2.

- b. At common crossing structures, messengers and guys that are required to be grounded shall be bonded together at that structure and grounded in accordance with Rule 92C3a.

EXCEPTION: This rule does not apply to guys that are connected to an effectively grounded overhead static wire.

D. Current in grounding conductor

Ground connection points shall be so arranged that under normal circumstances there will be no objectionable flow of current over the grounding conductor. If an objectionable flow of current occurs over a grounding conductor due to the use of multi-grounds, one or more of the following should be used:

1. Determine the source of the objectionable ground conductor current and take action necessary to reduce the current to an acceptable level at its source.
2. Abandon one or more grounds.
3. Change location of grounds.
4. Interrupt the continuity of the grounding conductor between ground connections.
5. Subject to the approval of the administrative authority, take other effective means to limit the current.

The system ground of the source transformer shall not be removed.

Under normal system conditions a grounding conductor current will be considered objectionable if the electrical or communication system's owner/operator deems such current to be objectionable, or if the presence and/or electrical characteristics of the grounding conductor current is in violation of rules and regulations governing the electrical system, as set forth by the authority having jurisdiction to promulgate such rules.

The temporary currents set up under abnormal conditions while the grounding conductors are performing their intended protective functions are not considered objectionable. The conductor shall have the capability of conducting anticipated fault current without thermal overloading or excessive voltage buildup. Refer to Rule 93C.

NOTE: Some amount of current will always be present on the grounding conductors of an operating AC electrical system.

E. Fences

Fences that are required to be grounded by other parts of this Code shall be designed to limit touch, step, and transferred voltages in accordance with industry practices.

NOTE: IEEE Std 80™-2000 [B32][®] is one source that may be utilized to provide guidance in meeting these requirements.

The grounding connections shall be made either to the grounding system of the enclosed equipment or to a separate ground.

1. Fences shall be grounded at each side of a gate or other opening.
2. Gates shall be bonded to the grounding conductor, jumper, or fence.
3. A buried bonding jumper shall be used to bond across a gate or other opening in the fence, unless a nonconducting fence section is used.
4. If barbed wire strands are used above the fence fabric, the barbed wire strands shall be bonded to the grounding conductor, jumper, or fence.
5. When fence posts are of conducting material, the grounding conductor shall be connected to the fence post or posts, as required, with suitable connecting means.
6. When fence posts are of nonconducting material, suitable bonding connection shall be made to the fence mesh strands and the barbed wire strands at each grounding conductor point.

[®]The numbers in brackets correspond to those of the bibliography in Appendix E.

093. Grounding conductor and means of connection

A. Composition of grounding conductors

In all cases, the grounding conductor shall be made of copper or other metals or combinations of metals that will not corrode excessively during the expected service life under the existing conditions and, if practical, shall be without joint or splice. If joints are unavoidable, they shall be so made and maintained as to not materially increase the resistance of the grounding conductor and shall have appropriate mechanical and corrosion-resistant characteristics. For surge arresters and ground detectors, the grounding conductor or conductors shall be as short, straight, and free from sharp bends as practical. Metallic electrical equipment cases or the structural metal frame of a building or structure may serve as part of a grounding conductor to an acceptable grounding electrode.

In no case shall a circuit-opening device be inserted in the grounding conductor or connection except where its operation will result in the automatic disconnection from all sources of energy of the circuit leads connected to the equipment so grounded.

EXCEPTION 1: For dc systems over 750 V, grounding conductor circuit-opening devices shall be permitted for changing between a remote electrode and a local ground through surge arresters.

EXCEPTION 2: Temporary disconnection of grounding conductors for testing purposes, under competent supervision, shall be permitted.

EXCEPTION 3: Disconnection of a grounding conductor from a surge arrester is allowed when accomplished by means of a surge-arrester disconnecter.

NOTE: The base of the surge arrester may remain at line potential following operation of the disconnecter.

B. Connection of grounding conductors

Connection of the grounding conductor shall be made by a means matching the characteristics of both the grounded and grounding conductors, and shall be suitable for the environmental exposure. These means include brazing, welding, mechanical and compression connections, ground clamps, and ground straps. Soldering is acceptable only in conjunction with lead sheaths.

C. Ampacity and strength

For bare grounding conductors, the short time ampacity is the current that the conductor can carry for the time during which the current flows without melting or affecting the design characteristics of the conductor. For insulated grounding conductors, the short time ampacity is the current that the conductor can carry for the applicable time without affecting the design characteristics of the insulation. Where grounding conductors at one location are paralleled, the increased total current capacity may be considered.

1. System grounding conductors for single-grounded systems

The system grounding conductor or conductors for a system with single-system grounding electrode or set of electrodes, exclusive of grounds at individual services, shall have a short time ampacity adequate for the fault current that can flow in the grounding conductors for the operating time of the system-protective device. If this value cannot be readily determined, continuous ampacity of the grounding conductor or conductors shall be not less than the full-load continuous current of the system supply transformer or other source of supply.

2. System grounding conductors for multi-grounded alternating current systems

The system grounding conductors for an ac system with grounds at more than one location exclusive of grounds at individual services shall have continuous total ampacities at each location of not less than one-fifth that of the conductors to which they are attached. (See also Rule 93C8.)

3. Grounding conductors for instrument transformers

The grounding conductor for instrument cases and secondary circuits for instrument transformers shall not be smaller than AWG No. 12 copper or shall have equivalent short time ampacity.

4. Grounding conductors for primary surge arresters

The grounding conductor or conductors shall have adequate short time ampacity under conditions of excess current caused by or following a surge. Individual arrester grounding conductors shall be no smaller than AWG No. 6 copper or AWG No. 4 aluminum.

EXCEPTION: Arrester grounding conductors may be copper-clad or aluminum-clad steel wire having not less than 30% of the conductivity of solid copper or aluminum wire of the same diameter, respectively.

Where flexibility of the grounding conductor, such as adjacent to the base of the arrester, is vital to its proper operation, a suitably flexible conductor shall be employed.

5. Grounding conductors for equipment, messenger wires, and guys

a. Conductors

The grounding conductors for equipment, raceways, cable, messenger wires, guys, sheaths, and other metal enclosures for wires shall have short time ampacities adequate for the available fault current and operating time of the system fault-protective device. If no overcurrent or fault protection is provided, the ampacity of the grounding conductor shall be determined by the design and operating conditions of the circuit, but shall be not less than that of AWG No. 8 copper. Where the adequacy and continuity of the conductor enclosures and their attachment to the equipment enclosures is assured, this path can constitute the equipment grounding conductor.

b. Connections

Connections of the grounding conductor shall be to a suitable lug, terminal, or device not disturbed in normal inspection, maintenance, or operation.

6. Fences

The grounding conductor for fences required to be grounded by other parts of this Code shall meet the requirements of Rule 93C5 or shall be steel wire not smaller than Stl WG No. 5.

7. Bonding of equipment frames and enclosures

Where required, a low-impedance metallic path shall be provided to conduct fault current back to the grounded terminal of the local supply. Where the supply is remote, the metallic path shall interconnect the equipment frames and enclosures with all other nonenergized conducting components within reach and shall additionally be connected to ground as outlined in Rule 93C5. Short time ampacities of bonding conductors shall be adequate for the duty involved.

8. Ampacity limit

No grounding conductor need have greater ampacity than either:

- a. The phase conductors that would supply the ground fault current, or
- b. The maximum current that can flow through it to the ground electrode or electrodes to which it is attached. For a single grounding conductor and connected electrode or electrodes, this would be the supply voltage divided by the electrode resistance (approximately).

9. Strength

All grounding conductors shall have mechanical strength suitable for the conditions to which they may reasonably be subjected.

Furthermore, unguarded grounding conductors shall have a tensile strength not less than that of AWG No. 8 soft-drawn copper, except as noted in Rule 93C3.

D. Guarding and protection

1. The grounding conductors for single-grounded systems and those exposed to mechanical damage shall be guarded. However, grounding conductors need not be guarded where not readily accessible to the public nor where grounding multi-grounded circuits or equipment.
2. Where guarding is required, grounding conductors shall be protected by guards suitable for the exposure to which they may reasonably be subjected. The guards should extend for not less

than 2.45 m (8 ft) above the ground or platform from which the grounding conductors are accessible to the public.

3. Where guarding is not required, grounds shall be protected by being substantially attached closely to the surface of the pole or other structure in areas of exposure to mechanical damage and, where practical, on the portion of the structure having least exposure.
4. Guards used for grounding conductors of lightning-protection equipment shall be of nonmetallic materials if the guard completely encloses the grounding conductor or is not bonded at both ends to the grounding conductor.

E. Underground

1. Grounding conductors laid directly underground shall be laid slack or shall be of sufficient strength to allow for earth movement or settling that is normal at the particular location.
2. Direct-buried uninsulated joints or splices in grounding conductors shall be made with methods suitable for the application and shall have appropriate corrosion resistance, required permanence, appropriate mechanical characteristics, and required ampacity. The number of joints or splices should be the minimum practical.
3. Grounding cable insulation shielding systems shall be interconnected with all other accessible grounded power supply equipment in manholes, handholes, and vaults.

EXCEPTION: Where cathodic protection or shield cross-bonding is involved, interconnection may be omitted.

4. Looped magnetic elements such as structural steel, piping, reinforcing bars, etc., should not separate grounding conductors from the phase conductors of circuits they serve.
5. Metals used for grounding, in direct contact with earth, concrete, or masonry, shall have been proven suitable for such exposure.

NOTE 1: Under present technology, aluminum has not generally been proven suitable for such use.

NOTE 2: Metals of different galvanic potentials that are electrically interconnected may require protection against galvanic corrosion.

6. Sheath transposition connections (cross-bonding)
 - a. Where cable insulating shields or sheaths, which are normally connected to ground, are insulated from ground to minimize shield circulating currents, they shall be insulated from personnel contact at accessible locations. Transposition connections and bonding jumpers shall be insulated for nominal 600 V service, unless the normal shielding voltage exceeds this level, in which case the insulation shall be ample for the working voltage to ground.
 - b. Bonding jumpers and connecting means shall be sized and selected to carry the available fault current without damaging jumper insulation or sheath connections.

F. Common grounding conductor for circuits, metal raceways, and equipment

Where the ampacity of a supply system grounding conductor is also adequate for equipment grounding requirements, this conductor may be used for the combined purpose. Equipment referred to includes the frames and enclosures of supply system control and auxiliary components, conductor raceways, cable shields, and other enclosures.

094. Grounding electrodes

The grounding electrode shall be permanent and adequate for the electrical system involved. A common electrode or electrode system shall be employed for grounding the electrical system and the conductor enclosures and equipment served by that system. This may be accomplished by interconnecting these elements at the point of connection of grounding conductor, Rule 92.

Grounding electrodes shall be one of the following:

A. Existing electrodes

Existing electrodes consist of conducting items installed for purposes other than grounding:

1. Metallic water piping system

Extensive metallic underground cold water piping systems may be used as grounding electrodes.

NOTE: Such systems normally have very low resistance to earth and have been extensively used in the past.

EXCEPTION: Water systems with nonmetallic, non-current-carrying pipe or insulating joints are not suitable for use as grounding electrodes.

2. Local systems

Isolated buried metallic cold water piping connecting to wells having sufficiently low measured resistance to earth may be used as grounding electrodes.

NOTE: Care should be exercised to ensure that all parts that might become disconnected are effectively bonded together.

3. Steel reinforcing bars in concrete foundations and footings

The reinforcing bar system of a concrete foundation or footing that is not insulated from direct contact with earth, and that extends at least 900 mm (3 ft) below grade, constitutes an effective and acceptable type of grounding electrode. Where steel supported on this foundation is to be used as a grounding conductor (tower, structure, etc.), it shall be interconnected by bonding between anchor bolts and reinforcing bars or by cable from the reinforcing bars to the structure above the concrete.

The normally applied steel ties are considered to provide adequate bonding between bars of the reinforcing cage.

NOTE: Where reinforcing bars in concrete are not suitably connected to a metal structure above the concrete, and the latter structure is subjected to grounding discharge currents (even connected to another electrode), there is likelihood of damage to the intervening concrete from ground-seeking current passing through the semiconducting concrete.

- B. Made electrodes

1. General

Where made electrodes are used, they shall, as far as practical, penetrate permanent moisture level and below the frostline. Made electrodes shall be of metal or combinations of metals that do not corrode excessively under the existing conditions for the expected service life.

All outer surfaces of made electrodes shall be conductive, that is, not having paint, enamel, or other covering of an insulating type.

2. Driven rods

- a. Driven rods may be sectional; the total length shall be not less than 2.44 (8 ft). Iron, zinc-coated steel, or steel rods shall have a cross-sectional dimension of not less than 15.87 mm (0.625 in). Copper-clad, stainless steel, or stainless steel-clad rods shall have a cross-sectional dimension of not less than 12.7 mm (0.5 in).

- b. Longer rods or multiple rods may be used to reduce the ground resistance. Spacing between multiple rods should be not less than 1.8 m (6 ft).

EXCEPTION: Other dimensions or configurations may be used if their suitability is supported by a qualified engineering study.

- c. Driven depth shall be not less than 2.45 m (8 ft). The upper end shall be flush with or below the ground level unless suitably protected.

EXCEPTION 1: Where rock bottom is encountered, driven depth may be less than 2.45 m (8 ft), or other types of electrode may be employed.

EXCEPTION 2: When contained within pad-mounted equipment, vaults, manholes, or similar enclosures, the driven depth may be reduced to 2.3 m (7.5 ft).

3. Buried wire, strips, or plates

In areas of high soil resistivity or shallow bedrock, or where lower resistance is required than attainable with driven rods, one or more of the following electrodes may be more useful:

a. Wire

Bare wires 4 mm (0.162 in) in diameter or larger, conforming to Rule 93E5, buried in earth at a depth not less than 450 mm (18 in) and not less than 30 m (100 ft) total in length, laid approximately straight, constitute an acceptably made electrode. (This is frequently designated a counterpoise.) The wire may be in a single length or may be several lengths connected at ends or at some point away from the ends. The wire may take the form of a network with many parallel wires spaced in two-dimensional array, referred to as a grid.

EXCEPTION 1: Where rock bottom is encountered, burial depth may be less than 450 mm (18 in).

EXCEPTION 2: Other lengths or configurations may be used if their suitability is supported by a qualified engineering study.

b. Strips

Strips of metal not less than 3.0 m (10 ft) in total length and with total (two sides) surface not less than 0.47 m² (5 ft²) buried in soil at a depth not less than 450 mm (18 in) constitute an acceptably made electrode. Ferrous metal electrodes shall be not less than 6 mm (0.25 in) in thickness and nonferrous metal electrodes not less than 1.5 mm (0.06 in).

NOTE: Strip electrodes are frequently useful in rocky areas where only irregularly shaped pits are practical to excavate.

c. Plates or sheets

Metal plates or sheets having not less than 0.185 m² (2 ft²) of surface exposed to the soil, and at a depth of not less than 1.5 m (5 ft), constitute an acceptable made electrode. Ferrous metal electrodes shall be not less than 6 mm (0.25 in) in thickness and nonferrous metal electrodes not less than 1.5 mm (0.06 in).

4. Pole-butt plates and wire wraps

a. General

In areas of very low soil resistivity there are two constructions, described in specifications b and c below, that may provide effective grounding electrode functions although they are inadequate in most other locations. Where these have been proven to have adequately low earth resistance by the application of Rule 96, two such electrodes may be counted as one made electrode and ground for application of Rules 92C1a, 92C2b, 96C, and 97C; however, these types shall not be the sole grounding electrode at transformer locations.

b. Pole-butt plates

Subject to the limitations of Rule 94B4a, a pole-butt plate on the base of a wooden pole, possibly folded up around the base of the pole butt, may be considered an acceptable electrode in locations where the limitations of Rule 96 are met. The plates shall be not less than 6 mm (1/4 in) thick if of ferrous metal and not less than 1.5 mm (0.06 in) thick if of nonferrous metal. Further, the plate area exposed to the soil shall be not less than 0.046 m² (0.5 ft²).

c. Wire wrap

Subject to the limitations of Rule 94B4a, made electrodes may be wire attached to the pole previous to the setting of the pole. The wire shall be of copper or other metals that will not corrode excessively under the existing conditions and shall have a continuous bare or exposed length below ground level of not less than 3.7 m (12 ft), shall extend to the bottom of the pole, and shall not be smaller than AWG No. 6.

5. Concentric neutral cable

Systems employing extensive [30 m (100 ft) minimum length] buried bare concentric neutral cable in contact with the earth may employ the concentric neutral as a grounding electrode. The

concentric neutral may be covered with a semi-conducting jacket that has a radial resistivity not exceeding $100 \text{ m} \cdot \Omega$ and that will remain essentially stable in service. The radial resistivity of the jacket material is that value calculated from measurements on a unit length of cable, of the resistance between the concentric neutral and a surrounding conducting medium. Radial resistivity equals resistance of unit length times the surface area of jacket divided by the average thickness of the jacket over the neutral conductors. All dimensions are to be expressed in meters.

6. Concrete-encased electrodes

A metallic wire, rod, or structural shape, meeting Rule 93E5 and encased in concrete, that is not insulated from direct contact with earth, shall constitute an acceptable ground electrode. The concrete depth below grade shall be not less than 300 mm (1 ft), and a depth of 750 mm (2.5 ft) is recommended. Wire shall be no smaller than AWG No. 4 if copper, or 9 mm (3/8 in) diameter or AWG No. 1/0 if steel. It shall be not less than 6.1 m (20 ft) long, and shall remain entirely within the concrete except for the external connection. The conductor should be run as straight as practical.

The metal elements may be composed of a number of shorter lengths arrayed within the concrete and connected together (e.g., the reinforcing system in a structural footing).

EXCEPTION: Other wire length or configurations may be used if their suitability is supported by a qualified engineering study.

NOTE 1: The lowest resistance per unit wire length will result from a straight wire installation.

NOTE 2: The outline of the concrete need not be regular, but may conform to an irregular or rocky excavation.

NOTE 3: Concrete-encased electrodes are frequently more practical or effective than driven rods or strips or plates buried directly in earth.

7. Directly embedded metal poles

Directly embedded steel poles shall constitute an acceptable electrode, if all of the following requirements are met:

- a. Backfill around the pole is native earth, concrete, or conductive grout (not gravel)
- b. Not less than 1.5 m (5.0 ft) of the embedded length is exposed directly to the earth, without nonconductive covering
- c. The pole diameter is not less than 125 mm (5 in), and
- d. The metal thickness is not less than 6 mm (1/4 in)

NOTE 1: Directly embedded steel poles having a nonconductive covering below ground that limits the length of direct exposure to earth to less than 1.5 m (5.0 ft) are not considered as an acceptable electrode. Aluminum installed below ground is not considered as an acceptable electrode. Weathering steel may not be an acceptable material for this application.

NOTE 2: There are structural and corrosion concerns that should be investigated prior to using metal poles as grounding electrodes. See Sections 25 and 26.

EXCEPTION: Other lengths or configurations may be used if their suitability is supported by a qualified engineering study.

095. Method of connection to electrode

A. Ground connections

The grounding connection shall be as accessible as practical and shall be made to the electrode by methods that provide the required permanence, appropriate mechanical characteristics, corrosion resistance, and required ampacity such as:

1. An effective clamp, fitting, braze, or weld.
2. A bronze plug that has been tightly screwed into the electrode.

3. For steel-framed structures, employing a concrete-encased reinforcing bar electrode, a steel rod similar to the reinforcing bar shall be used to join, by welding, a main vertical reinforcing bar to an anchor bolt. The bolt shall be substantially connected to the baseplate of the steel column supported on that footing. The electrical system may then be connected (for grounding) to the building frame by welding or by a bronze bolt tapped into a structural member of that frame.
4. For nonsteel frame structures employing a concrete-encased rod or wire electrode, an insulated copper conductor of size meeting the requirements of Rule 93C (except not smaller than AWG No. 4) shall be connected to the steel rod or wire using a cable clamp suitable for steel cable. This clamp and all the bared portion of the copper conductor, including ends of exposed strands within the concrete, shall be completely covered with mastic or sealing compound before concrete is poured. The copper conductor end shall be brought to or out of the concrete surface at the required location for connection to the electrical system. If the copper wire is carried beyond the surface of the concrete, it shall be no smaller than AWG No. 2.

Alternately, the copper wire may be brought out of the concrete at the bottom of the hole and carried external to the concrete for surface connection.

B. Point of connection to piping systems

1. The point of connection of a grounding conductor to a metallic water piping system shall be as near as is practical to the water-service entrance to the building or near the equipment to be grounded and shall be accessible. If a water meter is between the point of connection and the underground water pipe, the metallic water piping system shall be made electrically continuous by bonding together all parts between the connection and the pipe entrance that may become disconnected, such as meters and service unions.
2. Made grounds or grounded structures should be separated by 3.0 m (10 ft) or more from pipelines used for the transmission of flammable liquids or gases operating at high pressure [1030 kPa (150 lb/in²) or greater] unless they are electrically interconnected and cathodically protected as a single unit. Grounds within 3.0 m (10 ft) of such pipelines should be avoided or shall be coordinated so that hazardous ac conditions will not exist and cathodic protection of the pipeline will not be nullified.

RECOMMENDATION: It is recommended that calculations or tests be used to determine the required separation of ground electrodes for high-voltage direct-current (HVDC) systems from flammable liquid or high-pressure gas pipelines.

NOTE: Ground electrodes for HVDC systems over 750 V may require greater separation.

C. Contact surfaces

If any coating of nonconducting material, such as enamel, rust, or scale, is present on electrode contact surfaces at the point of connection, such a coating shall be thoroughly removed where required to obtain the requisite good connection. Special fittings so designed as to make such removal of nonconducting coatings unnecessary may also be used.

096. Ground resistance requirements

A. General

Grounding systems shall be designed to minimize hazard to personnel and shall have resistances to ground low enough to permit prompt operation of circuit protective devices. Grounding systems may consist of buried conductors and grounding electrodes.

B. Supply stations

Supply stations may require extensive grounding systems consisting of multiple buried conductors, grounding electrodes, or interconnected combinations of both. Grounding systems shall be designed to limit touch, step, mesh, and transferred potentials in accordance with industry practices.

NOTE: IEEE Std 80-2000 [B32] is one source that may be utilized to provide guidance in meeting these requirements.

C. Multi-grounded systems

The neutral, which shall be of sufficient size and ampacity for the duty involved, shall be connected to a made or existing electrode at each transformer location and at a sufficient number of additional points with made or existing electrodes to total not less than four grounds in each 1.6 km (1 mi) of the entire line, not including grounds at individual services.

EXCEPTION: Where underwater crossings are encountered, the requirement of made electrodes to total not less than four grounds in each 1.6 km (1 mi) of the entire line does not apply for the underwater portion if the neutral is of sufficient size and capacity for the duty involved and the requirements of Rule 92B2 are met.

NOTE 1: Multi-grounded systems extending over a substantial distance are more dependent on the multiplicity of grounding electrodes than on the resistance to ground of any individual electrode. Therefore, no specific values are imposed for the resistance of individual electrodes.

NOTE 2: The intent is to ensure that grounding electrodes are distributed at approximately 400 m (1/4 mi) or smaller intervals, although some intervals may exceed 400 m (1/4 mi).

RECOMMENDATION: This rule may be applied to shield wire(s) grounded at the source and which meet the multigrounding requirements of this rule.

D. Single-grounded (unigrounded or delta) systems

The ground resistance of an individual made electrode used for a single-grounded system should meet the requirements of Rule 96A and should not exceed 25 Ω . If a single electrode resistance cannot meet these requirements, then other methods of grounding as described in Rule 94B shall be used to meet the requirements of Rule 96A.

097. Separation of grounding conductors

A. Except as permitted in Rule 97B, grounding conductors from equipment and circuits of each of the following classes shall be run separately to the grounding electrode for each of the following classes:

1. Surge arresters of circuits over 750 V and frames of any equipment operating at over 750 V.
2. Lighting and power circuits under 750 V.
3. Shield wires of power circuits.
4. Lightning rods, unless attached to a grounded metal supporting structure.

Alternatively, the grounding conductors shall be run separately to a sufficiently heavy ground bus or system ground cable that is well connected to ground at more than one place.

B. The grounding conductors of the equipment classes detailed in Rules 97A1, 97A2, and 97A3 may be interconnected utilizing a single grounding conductor, provided:

1. There is a direct-earth grounding connection at each surge-arrester location, and
2. The secondary neutral or the grounded secondary phase conductor is common with or connected to a primary neutral or a shield wire meeting the grounding requirements of Rule 97C.

C. Primary and secondary circuits utilizing a single conductor as a common neutral shall have at least four ground connections on such conductor in each 1.6 km (1 mi) of line, exclusive of ground connections at customers' service equipment.

D. Ungrounded or single-grounded systems and multi-grounded systems

1. Ungrounded or single-grounded systems

Where the secondary neutral is not interconnected with the primary surge-arrester grounding conductor as in Rule 97B, interconnection may be made through a spark gap or device that performs an equivalent function. The gap or device shall have a 60 Hz breakdown voltage of at least twice the primary circuit voltage but not necessarily more than 10 kV. At least one other grounding connection on the secondary neutral shall be provided with its grounding electrode located at a distance of not less than 6.1 m (20 ft) from the surge-arrester grounding electrode

in addition to customer's grounds at each service entrance. The primary grounding conductor, or the secondary grounding conductor, shall be insulated for 600 V.

NOTE: For single-grounded systems, also see Rules 93C1, 93D, and 96D.

2. Multi-grounded systems

On multi-grounded systems, the primary and secondary neutrals should be interconnected according to Rule 97B. However, where it is necessary to separate the neutrals, interconnection of the neutrals shall be made through a spark gap or a device that performs an equivalent function. The gap or device shall have a 60 Hz breakdown voltage not exceeding 3 kV. At least one other grounding connection on the secondary neutral shall be provided with its grounding electrode located at a distance not less than 1.80 m (6 ft) from the primary neutral and surge-arrester grounding electrode in addition to the customer's grounds at each service entrance. Where the primary and secondary neutrals are not directly interconnected, (a) the primary grounding conductor, or the secondary grounding conductor, or both, shall be insulated for 600 V, and (b) the secondary grounding conductor shall be guarded according to Rule 93D2.

NOTE 1: A difference of voltage can exist where primary and secondary neutrals are not directly interconnected. For example, where metallic equipment is bonded to the secondary grounding conductor and is installed on the same pole, the primary grounding conductor would be insulated.

NOTE 2: Cooperation of all communications and supply utilities, customers of these utilities, and others may be necessary to obtain effective isolation between primary and secondary neutrals.

- E. Where separate electrodes are used for system isolation, separate grounding conductors shall be used. Where multiple electrodes are used to reduce grounding resistance, they may be bonded together and connected to a single grounding conductor.
- F. Made electrodes used for grounding surge arresters of ungrounded supply systems operated at potentials exceeding 15 kV phase to phase should be located at least 6.1 m (20 ft) from buried communication cables. Where lines with lesser separations are to be constructed, reasonable advance notice should be given to the owners or operators of the affected systems.
- G. Bonding of communication systems to electric supply systems
Where both electric supply systems and communication systems are grounded on a joint use structure, either a single grounding conductor shall be used for both systems or the electric supply and communication grounding conductors shall be bonded together, except where separation is required by Rule 97A. Where the electric supply utility is maintaining isolation between primary and secondary neutrals, the communication system ground shall be connected only to the primary grounding conductor.

098. Number 098 not used in this edition.

099. Additional requirements for grounding and bonding of communication apparatus

Where required to be grounded by other parts of this Code, communication apparatus shall be grounded in the following manner.

See *NOTE 2* in Rule 97D2.

A. Electrode

The grounding conductor shall be connected to an acceptable grounding electrode as follows:

1. Where available and where the supply service is grounded to an acceptable electrode, as described in Rule 94, to the grounded metallic supply service conduit, service equipment enclosure, grounding electrode conductors, or grounding electrode conductors' metal enclosure.
2. Where the grounding means of Rule 99A1 is not available, to a grounding electrode as described in Rule 94A.

3. Where the grounding means of Rule 99A1 or 99A2 are not available, to a grounding electrode as described in Rule 94B.

EXCEPTION: A variance to Rule 94B2 is allowed for this application. Iron or steel rods may have a cross-sectional dimension of not less than 13 mm (.50 in) and a length of not less than 1.50 m (5 ft). The driven depth shall be 1.50 m (5 ft), subject to *EXCEPTION 1* of Rule 94B2.

B. Electrode connection

The grounding conductor shall preferably be made of copper (or other material that will not corrode excessively under the prevailing conditions of use) and shall be not less than AWG No. 14 in size. The grounding conductor shall be attached to the electrode by means of a bolted clamp or other suitable methods.

NOTE: For requirements on proper materials, methods, and precautions to be taken in the selection and application of grounding and bonding, refer to Rules 93B and 95.

C. Bonding of electrodes

A bond not smaller than AWG No. 6 copper or equivalent shall be placed between the communication grounding electrode and the supply system neutral grounding electrode where separate electrodes are used at the structure or building being served. All separate electrodes shall be bonded together except where separation is required per Rule 97.

RECOMMENDATION: If water piping is used as a bonding means, care must be taken to assure that the metallic path is continuous between electrodes.

NOTE 1: See NEC Article 800-100(D) for corresponding NEC requirements.

NOTE 2: The bonding together of all separate electrodes limits potential differences between them and between their associated wiring systems.



Part 1.

Rules for the Installation and Maintenance of Electric Supply Stations and Equipment

Section 10. Purpose and scope of rules

100. Purpose

The purpose of Part 1 of this Code is the practical safeguarding of persons during the installation, operation, or maintenance of electric supply stations and their associated equipment.

101. Scope

Part 1 of this Code covers the electric supply conductors and equipment, along with the associated structural arrangements in electric supply stations, that are accessible only to qualified personnel. It also covers the conductors and equipment employed primarily for the utilization of electric power when such conductors and equipment are used by the utility in the exercise of its function as a utility.

102. Application of rules

The general requirements for application of these rules are contained in Rule 13.

103. Referenced sections

The Introduction (Section 1), Definitions (Section 2), References (Section 3), and Grounding methods (Section 9) shall apply to the requirements of Part 1.

Section 11. Protective arrangements in electric supply stations

110. General requirements

A. Enclosure of equipment

1. Types of enclosures

Rooms and spaces in which electric supply conductors or equipment are installed shall be so arranged with fences, screens, partitions, or walls to form an enclosure as to limit the likelihood of entrance of unauthorized persons or interference by them with equipment inside. Entrances not under observation of an authorized attendant shall be kept locked.

A safety sign shall be displayed at each entrance. For fenced electric supply stations, a safety sign shall be displayed on each side of the fenced enclosure.

NOTE: ANSI Z535.1-2006, ANSI Z535.2-2006, ANSI Z535.3-2006, ANSI Z535.4-2006, and ANSI Z535.5-2006 contain information regarding safety signs.

Metal fences, when used to enclose electric supply stations having energized electric conductors or equipment, shall have a height not less than 2.13 m (7 ft) overall and shall be grounded in accordance with Section 9.

The requirements for fence height may be satisfied with any one of the following:

- a. Fence fabric, 2.13 m (7 ft) or more in height.
- b. A combination of 1.80 m (6 ft) or more of fence fabric and an extension utilizing three or more strands of barbed wire to achieve an overall height of the fence of not less than 2.13 m (7 ft).
- c. Other types of construction, such as nonmetallic material, that present equivalent barriers to climbing or other unauthorized entry.

2. Safety clearance zone

Fences or walls, when installed as barriers for unauthorized personnel, shall be located such that exposed live parts are outside the safety clearance zone as illustrated in Figure 110-1 and shown in Table 110-1.

EXCEPTION 1: Where a fence, partition, or wall with no openings through which sticks or other objects can be inserted is utilized, live parts complying with the requirements of this Code may be installed within the safety clearance zone if they are below the horizontal line projected from the top of the fence or wall.

EXCEPTION 2: The safety clearance zone requirement is not applicable to internal fences within an electric supply station perimeter fence.

B. Rooms and spaces

All rooms and spaces in which electric supply equipment is installed shall comply with the following requirements:

1. Construction

They shall be as much as practical noncombustible.

NOTE: This rule is not intended to prevent wood poles from being used to support conductors or equipment in electric supply stations.

2. Use

They should be as much as practical free from combustible materials, dust, and fumes and shall not be used for manufacturing or for storage.

EXCEPTION 1: Equipment or material essential for maintenance of the installed equipment may be stored if guarded or separated from live parts as required by Rule 124.

EXCEPTION 2: Materials related to station, transmission, or distribution construction or maintenance work may be stored in the station if located in an area separated from the station electric supply equipment by a fence meeting the requirements of Rule 110A.

EXCEPTION 3: Stored material related to station, transmission, and distribution construction and maintenance work in progress may be temporarily located in a storage space meeting all of the following requirements:

- (a) Guarded or separated from live parts as required by Rule 124.
- (b) Station exits continue to meet the requirements of Rule 113.
- (c) Station working space continues to meet the requirements of Rule 125.
- (d) Access is limited to qualified personnel and persons escorted by qualified personnel.
- (e) The storage location and content is such that the risk of fire does not unreasonably jeopardize station operation.

(For battery areas, see Section 14; for guarding, see Rule 124; for auxiliary equipment in classified locations, see Rule 127.)

3. Ventilation

There should be sufficient ventilation to maintain operating temperatures within ratings, arranged to minimize accumulation of airborne contaminants under any operating conditions.

4. Moisture and weather

They should be dry. In outdoor stations or stations in wet tunnels, subways or other moist or high-humidity locations, the equipment shall be suitably designed to withstand the prevailing atmospheric conditions.

C. Electric equipment

All stationary equipment shall be supported and secured in a manner consistent with reasonably expected conditions of service. Consideration shall be given to the fact that certain heavy equipment, such as transformers, can be secured in place by their weight. However, equipment that generates dynamic forces during operation may require appropriate additional measures.

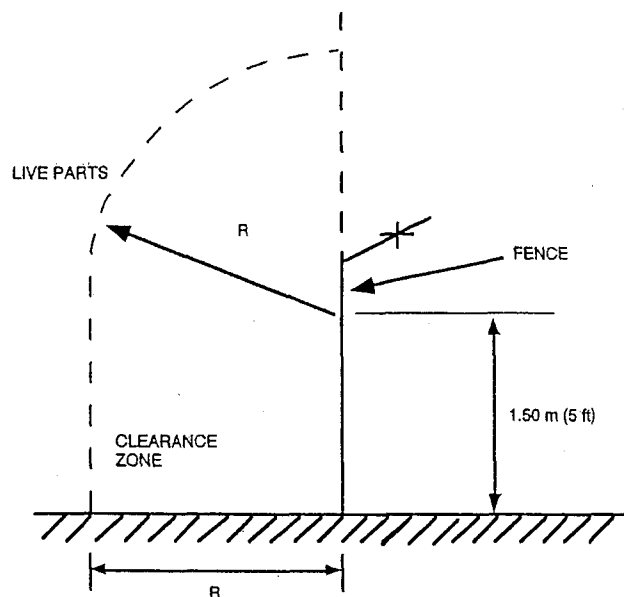

Figure 110-1—Safety clearance to electric supply station fences

Table 110-1—Values for use with Figure 110-1

Nominal voltage between phases	Typical BIL	Dimension "R"	
		m	
151-7200	95	3.0	
13 800	110	3.1	
23 000	150	3.1	
34 500	200	3.2	
46 000	250	3.3	
69 000	350	3.5	
115 000	550	4.0	
138 000	650	4.2	
161 000	750	4.4	
230 000	825	4.5	
230 000	900	4.7	
345 000	1050	5.0	
345 000	1175	5.3	
345 000	1300	5.5	
500 000	1550	6.0	
500 000	1800	6.6	
765 000	2050	7.1	

111. Illumination

A. Under normal conditions

Rooms and spaces shall have means for artificial illumination. Illumination levels not less than those listed in Table 111-1 are recommended for safety to be maintained on the task.

B. Emergency lighting

1. A separate emergency source of illumination with automatic initiation, from an independent generator, storage battery, or other suitable source, shall be provided in every attended station.
2. Emergency lighting of 11 lux (1 footcandle) shall be provided in exit paths from all areas of attended stations. Consideration must be given to the type of service to be rendered, whether of short or long duration. The minimum duration shall be 1-1/2 h. It is recommended that emergency circuit wiring shall be kept independent of all other wiring and equipment.

C. Fixtures

Arrangements for permanent fixtures and plug receptacles shall be such that portable cords need not be brought into dangerous proximity to live or moving parts. All lighting shall be controlled and serviced from safely accessible locations.

D. Attachment plugs and receptacles for general use

Portable conductors shall be attached to fixed wiring only through separable attachment plugs that will disconnect all poles by one operation. Receptacles installed on two- or three-wire single-phase, ac branch circuits shall be of the grounding type. Receptacles connected to circuits having different voltages, frequencies, or types of current (ac or dc) on the same premises shall be of such design that attachment plugs used on such circuits are not interchangeable.

E. Receptacles in damp or wet locations

All 120 V ac permanent receptacles shall either be provided with ground-fault interrupter (GFI) protection or be on a grounded circuit that is tested at such intervals as experience has shown to be necessary.

Table 111-1—Illumination levels

Location	lux	footcandles
Generating station		
Air-conditioning equipment, air preheater and fan floor, ash sluicing	55	
Auxiliaries, battery areas, boiler feed pumps, tanks, compressors, gage area	110	10
Boiler platforms	55	
Burner platforms	110	10
Cable room, circulator, or pump bay	55	
Chemical laboratory	270	25
Coal conveyor, crusher, feeder, scale area, pulverizer, fan area, transfer tower	55	
Condensers, deaerator floor, evaporator floor, heater floors	55	
Control rooms		
Vertical face of switchboards		
Simplex or section of duplex operator:		
Type A—Large centralized control room 1.68 m (66 in) above floor	270	25
Type B—Ordinary control room 1.68 m (66 in) above floor	160	15
Section of duplex facing away from operator	160	15
Bench boards (horizontal level)	270	25
Area inside duplex switchboards	55	5
Rear of all switchboard panels (vertical)	55	5
Dispatch boards		
Horizontal plane (desk level)	270	25
Vertical face of board [1.22 m (48 in) above floor, facing operator]:		
System load dispatch room	270	25
Secondary dispatch room	160	15
Hydrogen and carbon dioxide manifold area	110	10
Precipitators	55	5
Screen house	110	10

Table 111-1—Illumination levels (continued)

Location	lux	footcandles
Soot or slag blower platform	55	5
Steam headers and throttles	55	5
Switchgear, power	110	10
Telephone equipment room	110	10
Tunnels or galleries, piping	55	5
Turbine bay sub-basement	110	10
Turbine room	160	15
Visitors' gallery	110	10
Water treating area	110	10
Generating station (exterior)		
Catwalks	22	2
Cinder dumps	2.2	0.2
Coal-storage area	2.2	0.2
Coal unloading		
Dock (loading or unloading zone)	55	5
Barge storage area	5.5	0.5
Car dumper	5.5	0.5
Tipple	55	5
Conveyers	22	2
Entrances Generating or service building		
Main	110	10
Secondary	22	2
Gate house		
Pedestrian entrance	110	10
Conveyor entrance	55	5
Fence	2.2	0.2
Fuel-oil delivery headers	55	5
Oil storage tanks	11	1
Open yard	2.2	0.2
Platforms—boiler, turbine deck	55	5

Table 111-1—Illumination levels (continued)

Location	lux	footcandles
Roadway		
Between or along buildings	11	
Not bordered by buildings	5.5	
Substation		
General horizontal	22	
Specific vertical (on disconnects)	22	

112. Floors, floor openings, passageways, and stairs

A. Floors

Floors shall have even surfaces and afford secure footing. Slippery floors or stairs should be provided with antislip covering.

B. Passageways

Passageways, including stairways, shall be unobstructed and shall, where practical, provide at least 2.13 m (7 ft) head room. Where the preceding requirements are not practical, the obstructions should be painted, marked, or indicated by safety signs, and the area properly lighted.

NOTE: ANSI Z535.1-2006, ANSI Z535.2-2006, ANSI Z535.3-2006, ANSI Z535.4-2006, and ANSI Z535.5-2006 contain information regarding safety signs.

C. Railings

All floor openings without gratings or other adequate cover and raised platforms and walkways in excess of 300 mm (1 ft) in height shall be provided with railings. Openings in railings for units such as fixed ladders, cranes, and the like shall be provided with adequate guards such as grates, chains, or sliding pipe sections.

D. Stair guards

All stairways consisting of four or more risers shall be provided with handrails.

NOTE: For additional information, see ANSI A1264.1-1995 [B5].

E. Top rails

All top rails shall be kept unobstructed for a distance of 75 mm (3 in) in all directions except from below at supports.

113. Exits

A. Clear exits

Each room or space and each working space about equipment shall have a means of exit, which shall be kept clear of all obstructions.

B. Double exits

If the plan of the room or space and the character and arrangement of equipment are such that an accident would be likely to close or make inaccessible a single exit, a second exit shall be provided.

C. Exit doors

Exit doors shall swing out and be equipped with panic bars, pressure plates, or other devices that are normally latched but open under simple pressure.

EXCEPTION: This rule does not apply to exit doors in buildings and rooms containing low-voltage, nonexplosive equipment, and to gates in fences for outdoor equipment installations.

114. Fire-extinguishing equipment

Fire-extinguishing equipment approved for the intended use shall be conveniently located and conspicuously marked.

Section 12. Installation and maintenance of equipment

120. General requirements

- A. All electric equipment shall be constructed, installed, and maintained so as to safeguard personnel as far as practical.
- B. The rules of this section are applicable to both ac and dc supply stations.

121. Inspections

- A. In-service equipment

Electric equipment shall be inspected and maintained at such intervals as experience has shown to be necessary. Equipment or wiring found to be defective shall be put in good order or permanently disconnected.

- B. Idle equipment

Infrequently used equipment or wiring shall be inspected and tested before use to determine its fitness for service. Idle equipment energized but not connected to a load shall be inspected and maintained at such intervals as experience has shown to be necessary.

- C. Emergency equipment

Equipment and wiring maintained for emergency service shall be inspected and tested at such intervals as experience has shown to be necessary to determine its fitness for service.

- D. New equipment

New equipment shall be inspected and tested before being placed in service. New equipment shall be tested in accordance with standard industry practices.

122. Guarding shaft ends, pulleys, belts, and suddenly moving parts

- A. Mechanical transmission machinery

The methods for safeguarding pulleys, belts, and other equipment used in the mechanical transmission of power shall be in accordance with ANSI/ASME B15.1-2000.

- B. Suddenly moving parts

Parts of equipment that move suddenly in such a way that persons in the vicinity are likely to be injured by such movement shall be guarded or isolated.

123. Protective grounding

- A. Protective grounding or physical isolation of non-current-carrying metal parts

All electric equipment shall have the exposed non-current-carrying metal parts, such as frames of generators and switchboards, cases of transformers, switches, and operating levers, effectively grounded or physically isolated. All metallic guards including rails, screen fences, etc., about electric equipment shall be effectively grounded.

B. Grounding method

All grounding that is intended to be a permanent and effective protective measure, such as surge-arrester grounding, grounding of circuits, equipment, or wire raceways, shall be made in accordance with the methods specified in Section 9 of this Code.

NOTE: For additional information, see IEEE Std 80-2000 [B32].

C. Provision for grounding equipment during maintenance

Electric equipment or conductors normally operating at more than 600 V between conductors, on or about which work is occasionally done while isolated from a source of electric energy by disconnecting or isolating switches only, shall be provided with some means for grounding, such as switches, connectors, or a readily accessible means for connecting a portable grounding conductor. See Part 4 of this Code.

D. Grounding methods for direct-current systems over 750 V

On dc systems greater than 750 V, the dc system shall be grounded in accordance with the methods specified in Section 9 of this Code.

124. Guarding live parts**A. Where required**

1. Guards shall be provided around all live parts operating above 300 V phase-to-phase without an adequate insulating covering, unless their location gives sufficient horizontal or vertical clearance or a combination of these clearances to limit the likelihood of accidental human contact. Clearances from live parts to any permanent supporting surface for workers shall equal or exceed either of those shown in Table 124-1 and illustrated in Figure 124-1.

EXCEPTION: Where supplemental protection is used in accordance with Rule 124C3, the requirements to guard do not apply.

2. Parts over or near passageways through which material may be carried, or in or near spaces such as corridors, storerooms, and boiler rooms used for nonelectrical work, shall be guarded or given clearances in excess of those specified such as may be necessary to secure reasonable safety. The guards shall be substantial and completely shield or enclose the live parts without openings. In spaces used for nonelectrical work, guards should be removable only by means of tools or keys.
3. Each portion of parts of indeterminate potential, such as telephone wires exposed to induction from high-voltage lines, ungrounded neutral connections, ungrounded frames, ungrounded parts of insulators or surge arresters, or ungrounded instrument cases connected directly to a high-voltage circuit, shall be guarded in accordance with Rule 124A1 on the basis of the maximum voltage that may be present on the surface of that portion. The vertical clearance above grade of the bottom of such part shall be not less than 2.60 m (8.5 ft) unless it is enclosed or guarded in accordance with Rule 124C.

B. Strength of guards

Guards shall be sufficiently strong and shall be supported rigidly and securely enough to limit the likelihood of them being displaced or dangerously deflected by a person slipping or falling against them.

C. Types of guards

1. Location or physical isolation

Parts having clearances equal to or greater than specified in Table 124-1 are guarded by location. Parts are guarded by isolation when all entrances to enclosed spaces, runways, fixed ladders, and the like are kept locked, barricaded, or roped off, and safety signs are posted at all entrances.

NOTE: ANSI Z535.1-2006, ANSI Z535.2-2006, ANSI Z535.3-2006, ANSI Z535.4-2006, and ANSI Z535.5-2006 contain information regarding safety signs.

2. Shields or enclosures

Guards less than 100 mm (4 in) outside of the guard zone shall completely enclose the parts from contact up to the heights listed in column 2 of Table 124-1. They shall be not closer to the live parts than listed in column 4 of Table 124-1, except when suitable insulating material is used with circuits of less than 2500 V to ground. If more than 100 mm (4 in) outside the guard zone, the guards shall extend at least 2.60 m (8.5 ft) above the floor. Covers or guards, which must at any time be removed while the parts they guard are live, shall be so arranged that they cannot readily be brought into contact with live parts.

3. Supplemental barriers or guards within electric supply stations

If the vertical distance in Table 124-1 cannot be obtained, railings or fences may be used. Railings or fences, if used, shall be not less than 1.07 m (3.5 ft) high and shall be located at a horizontal distance of at least 900 mm (3 ft) [and preferably not more than 1.20 m (4 ft)] from the nearest point of the guard zone that is less than 2.60 m (8.5 ft) above the floor or grade (see Figure 124-2).

NOTE: It is preferred that the railing or fence be located as close as practical to the parts, while providing a sufficient clear distance to the side of the guard zone to allow appropriate working room with expected tools (such as hot sticks) and working methods—see Rules 125 and 441.

4. Mats

Mats of rubber or other suitable insulating material complying with ASTM D 178-88 may be used at switchboards, switches, or rotating machinery as supplementary protection.

5. Live parts below supporting surfaces for persons

The supporting surfaces for persons above live parts shall be without openings. Toe boards at least 150 mm (6 in) high and handrails shall be provided at all edges.

6. Insulating covering on conductors or parts

Conductors and parts may be considered as guarded by insulation if they have either of the following:

- a. Insulation covering of a type and thickness suitable for the voltage and conditions under which they are expected to be operated, and if operating above 2500 V to ground, having metallic insulation shielding or semiconducting shield in combination with suitable metallic drainage that is grounded to an effective ground.

EXCEPTION: Nonshielded insulated conductors listed by a qualified testing laboratory shall be permitted for use up to 8000 V (phase to phase) when the conductors meet the requirements of the NEC, Article 310-6.

- b. Barriers or enclosures that are electrically and mechanically suitable for the conditions under which they are expected to be operated.

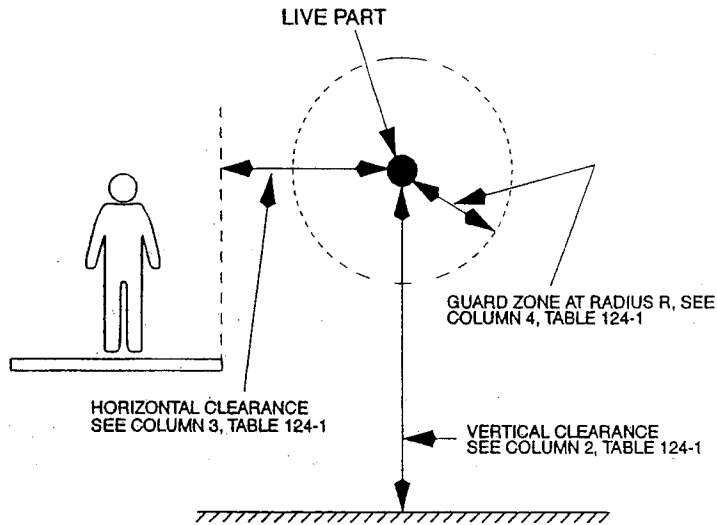

Figure 124-1—Clearance from live parts

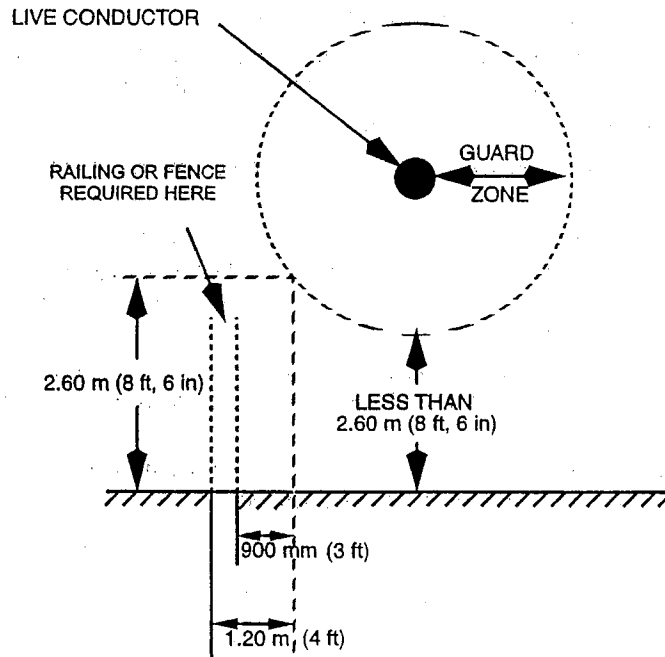

Figure 124-2—Railings or fences used as guards

m

Table 124-1—
Clearances from live parts
PART A—Low, medium, and high voltages (based on BIL factors)

Column 1	Column C	Column 2	Column 3	Column 4
Maximum design voltage between phases	Basic impulse insulation level ^⑤ (BIL)	Vertical clearance of unguarded parts ^①	Horizontal clearance of unguarded parts ^①	Clearance guard to live parts ^①
kV	kV	m	m	mm
0.3	—	Not specified	Not specified	Not specified
0.6	—	2.64	1.02	50
2.4	—	2.67	1.02	76
7.2	95	2.69	1.02	101
15	95	2.69	1.02	101
15	110	2.74	1.07	152
25	125	2.77	1.09	177
25	150	2.82	1.14	228
35	200	2.90	1.22	304
48	250	3.00	1.32	406
72.5	250	3.00	1.32	406
72.5	350	3.18	1.50	584
121	350	3.18	1.50	584
121	550	3.53	1.85	939
145	350	3.18	1.50	584
145	550	3.53	1.85	939
145	650	3.71	2.03	1117
169	550	3.53	1.85	939
169	650	3.71	2.03	1117
169	750	3.91	2.24	1320
242	550	3.53	1.85	939
242	650	3.71	2.03	1117
242	750	3.91	2.24	1320
242	900	4.19	2.51	1600
242	1050	4.52	2.84	1930

m

**Table 124-1—
PART B—Extra-high voltages (based on switching-surge factors)^②**

Column 1	Column A	Column B	Column 2	Column 3	Column 4
Maximum design voltage between phases	Switching-surge factor per unit ^③	Switching surge line to ground ^④	Vertical clearance of unguarded parts ^①	Horizontal clearance of unguarded parts ^①	Clearance guard to live parts ^①
kV		kV	m	m	m
362	2.2 or below	650	4.7	3.0	2.13
362	2.3	680	4.9	3.2	2.30
362	2.4	709	5.0	3.4	2.45
362	2.5	739	5.2	3.6	2.60
362	2.6	768	5.4	3.7	2.80
362	2.7	798	5.6	3.9	3.0
362	2.8	828	5.8	4.1	3.2
362	2.9	857	6.0	4.3	3.4
362	3.0	887	6.1	4.5	3.6
550	1.8 or below	808	5.7	4.1	3.2
550	1.9	853	5.9	4.3	3.4
550	2.0	898	6.2	4.6	3.6
550	2.1	943	6.6	4.9	4.0
550	2.2	988	6.9	5.2	4.3
550	2.3	1033	7.2	5.5	4.6
550	2.4	1078	7.5	5.8	4.9
550	2.5	1123	7.9	6.2	5.3
550	2.6	1167	8.2	6.6	5.6
550	2.7	1212	8.6	7.0	6.0
800	1.5	980	6.8	5.1	4.2
800	1.6	1045	7.3	5.6	4.7
800	1.7	1110	7.8	6.1	5.2
800	1.8	1176	8.3	6.6	5.7
800	1.9	1241	8.8	7.2	6.2

Table 124-1— (continued)
 PART B—Extra-high voltages (based on switching-surge factors)^②

m

Column 1	Column A	Column B	Column 2	Column 3	Column 4
Maximum design voltage between phases	Switching-surge factor ^③ per unit ^④	Switching surge line to ground ^④	Vertical clearance of unguarded parts ^①	Horizontal clearance of unguarded parts ^①	Clearance guard to live parts ^①
kV		kV	m	m	m
800	2.0	1306	9.4	7.7	6.8
800	2.1	1372	10.0	8.3	7.4
800	2.2	1437	10.6	8.9	8.0
800	2.3	1502	11.2	9.5	8.6
800	2.4	1567	11.8	10.0	9.2

Table 124-1—
 PART C — Extra-high voltages (based on BIL factors)^②

m

Column 1	Column C	Column 2	Column 3	Column 4
Maximum design voltage between phases	Basic impulse insulation level (BIL) ^⑤ ^④	Vertical clearance of unguarded parts ^①	Horizontal clearance of unguarded parts ^①	Clearance guard to live parts ^①
kV	kV	m	m	m
362	1050	4.7	3.0	2.13
362	1300	5.2	3.6	2.60
550	1550	5.7	4.1	3.2
550	1800	6.2	4.6	3.6
800	2050	6.8	5.2	4.2

m

Table 124-1—
PART D — High voltage direct current (based on transient overvoltage)

Column 1	Column A	Column B	Column 2	Column 3	Column 4
Maximum design voltage conductor to ground	Transient overvoltage per unit ^①	Transient overvoltage line to grnd ^②	Vertical clearance of unguarded parts ^③	Horizontal clearance of unguarded parts ^④	Clearance guard to live parts ^⑤
kV		kV	m	m	m
250	1.5 or below	375	3.81	2.13	1.22
250	1.6	400	3.89	2.22	1.30
250	1.7	425	3.97	2.30	1.38
250	1.8	450	4.05	2.38	1.46
400	1.5 or below	600	4.54	2.87	1.95
400	1.6	640	4.67	3.00	2.08
400	1.7	680	4.88	3.21	2.29
400	1.8	720	5.12	3.45	2.53
500	1.5 or below	750	5.29	3.62	2.70
500	1.6	800	5.60	3.92	3.01
500	1.7	850	5.96	4.29	3.37
500	1.8	900	6.35	4.67	3.76
600	1.5 or below	900	6.35	4.67	3.76
600	1.6	960	6.73	5.06	4.14
600	1.7	1020	7.13	5.45	4.54
600	1.8	1080	7.57	5.89	4.97
750	1.5 or below	1125	7.90	6.23	5.31
750	1.6	1200	8.44	6.76	5.85
750	1.7	1275	9.06	7.38	6.47
750	1.8	1350	9.72	8.04	7.13

- ① Interpolate for intermediate values. The clearances in column 4 of this table are solely for guidance in installing guards without definite engineering design and are not to be considered as a requirement for such engineering design. For example, the clearances in the tables above are not intended to refer to the clearances between live parts and the walls of the cells, compartments, or similar enclosing structures. They do not apply to the clearances between bus bars and supporting structures nor to clearances between the blade of a disconnecting switch and its base. However, where surge-protective devices are applied to protect the live parts, the vertical clearances, column 2 of Table 124-1 Part A may be reduced provided the clearance is not less than 2.6 m plus the electrical clearance between energized parts and ground as limited by the surge-protective devices.
- ② Clearances shall satisfy either switching-surge or BIL duty requirements, whichever are greater.
- ③ Switching-surge factor—an expression of the maximum switching-surge crest voltage in terms of the maximum operating line-to-neutral crest voltage of the power system.
- ④ The values of columns A, B, and C are power system design factors that shall correlate with selected clearances. Adequate data to support these design factors should be available.
- ⑤ The selection of station BIL shall be coordinated with surge-protective devices when BIL is used to determine clearance. BIL—basic impulse insulation level—for definition and application, see IEEE Std 1313-1993.

ft

Table 124-1—
Clearances from live parts
PART A—Low, medium, and high voltages (based on BIL factors)

Column 1	Column C	Column 2		Column 3		Column 4	
Maximum design voltage between phases	Basic impulse insulation level ^⑤ (BIL)	Vertical clearance of unguarded parts ^①		Horizontal clearance of unguarded parts ^①		Clearance guard to live parts ^①	
kV	kV	ft	in	ft	in	ft	in
0.3	—	Not specified		Not specified		Not specified	
0.6	—	8	8	3	4	0	2
2.4	—	8	9	3	4	0	3
7.2	95	8	10	3	4	0	4
15	95	8	10	3	4	0	4
15	110	9	0	3	6	0	6
25	125	9	1	3	7	0	7
25	150	9	3	3	9	0	9
35	200	9	6	4	0	1	0
48	250	9	10	4	4	1	4
72.5	250	9	10	4	4	1	4
72.5	350	10	5	4	11	1	11
121	350	10	5	4	11	1	11
121	550	11	7	6	1	3	1
145	350	10	5	4	11	1	11
145	550	11	7	6	1	3	1
145	650	12	2	6	8	3	8
169	550	11	7	6	1	3	1
169	650	12	2	6	8	3	8
169	750	12	10	7	4	4	4
242	550	11	7	6	1	3	1
242	650	12	2	6	8	3	8
242	750	12	10	7	4	4	4
242	900	13	9	8	3	5	3
242	1050	14	10	9	4	6	4

ft

Table 124-1—
PART B — Extra-high voltages (based on switching-surge factors)^②

Column 1	Column A	Column B	Column 2		Column 3		Column 4	
			Vertical clearance of unguarded parts ^①		Horizontal clearance of unguarded parts ^①		Clearance guard to live parts ^①	
Maximum design voltage between phases	Switching surge factor per unit ^①	Switching surge line to ground ^①	ft	in	ft	in	ft	in
kV		kv	ft	in	ft	in	ft	in
362	2.2 or below	650	15	6	10	0	7	0
362	2.3	680	16	0	10	6	7	6
362	2.4	709	16	6	11	0	8	0
362	2.5	739	17	2	11	8	8	8
362	2.6	768	17	9	12	3	9	3
362	2.7	798	18	4	12	10	9	10
362	2.8	828	18	11	13	5	10	5
362	2.9	857	19	7	14	1	11	1
362	3.0	887	20	2	14	8	11	8
550	1.8 or below	808	18	10	13	4	10	4
550	1.9	853	19	6	14	0	11	0
550	2.0	898	20	6	15	0	12	0
550	2.1	943	21	6	16	0	13	0
550	2.2	988	22	6	17	0	14	0
550	2.3	1033	23	7	18	1	15	1
550	2.4	1078	24	8	19	2	16	2
550	2.5	1123	25	10	20	4	17	4
550	2.6	1167	27	0	21	6	18	6
550	2.7	1212	28	4	22	10	19	10
800	1.5	980	22	4	16	10	13	10
800	1.6	1045	23	11	18	5	15	5
800	1.7	1110	25	6	20	0	17	1
800	1.8	1176	27	3	21	9	18	9
800	1.9	1241	29	0	23	6	2	6
800	2.0	1306	30	10	25	4	22	4
800	2.1	1372	32	9	27	3	24	3
800	2.2	1437	34	8	29	3	26	2
800	2.3	1502	36	9	31	3	28	3
800	2.4	1567	38	9	33	3	30	3

ft

Table 124-1—
PART C — Extra-high voltages (based on BIL factors)^②

Column 1	Column C	Column 2		Column 3		Column 4	
Maximum design voltage between phases	Basic impulse insulation level ^⑤ (BIL) ^④	Vertical clearance of unguarded parts ^①		Horizontal clearance of unguarded parts ^①		Clearance guard to live parts ^①	
kV	kV	ft	in	ft	in	ft	in
362	1050	15	6	10	0	7	0
362	1300	17	2	11	8	8	8
550	1550	18	10	13	4	10	4
550	1800	20	6	15	0	12	0
800	2050	22	5	16	11	13	11

Table 124-1—
PART D — High voltage direct current (based on transient overvoltage)

ft

Column 1	Column A	Column B	Column 2		Column 3		Column 4	
Maximum design voltage conductor to ground	Transient overvoltage per unit ^②	Transient overvoltage line to grnd ^④	Vertical clearance of unguarded parts ^①		Horizontal clearance of unguarded parts ^①		Clearance guard to live parts ^①	
kV		kV	ft	in	ft	in	ft	in
250	1.5 or below	375	12	6	7	0	4	0
250	1.6	400	12	9	7	3	4	3
250	1.7	425	13	0	7	7	4	6
250	1.8	450	13	3	7	10	4	9
400	1.5 or below	600	14	11	9	5	6	5
400	1.6	640	15	4	9	10	6	10
400	1.7	680	16	0	10	6	7	6
400	1.8	720	16	10	11	4	8	4
500	1.5 or below	750	17	4	11	11	8	10
500	1.6	800	18	4	12	10	9	11
500	1.7	850	19	7	14	1	11	1
500	1.8	900	20	10	15	4	12	4

Table 124-1— (continued)
PART D — High voltage direct current (based on transient overvoltage)

ft

Column 1	Column A	Column B	Column 2		Column 3		Column 4	
Maximum design voltage conductor to ground	Transient overvoltage per unit ^④	Transient overvoltage line to grnd ^④	Vertical clearance of unguarded parts ^①		Horizontal clearance of unguarded parts ^①		Clearance guard to live parts ^①	
kV		kV	ft	in	ft	in	ft	in
600	1.5 or below	900	20	10	15	4	12	4
600	1.6	960	22	1	16	7	13	7
600	1.7	1020	23	5	17	11	14	11
600	1.8	1080	24	10	19	4	16	4
750	1.5 or below	1125	25	11	20	5	17	5
750	1.6	1200	27	8	22	2	19	2
750	1.7	1275	29	9	24	3	21	3
750	1.8	1350	31	11	26	5	23	5

① Interpolate for intermediate values. The clearances in column 4 of this table are solely for guidance in installing guards without definite engineering design and are not to be considered as a requirement for such engineering design. For example, the clearances in the tables above are not intended to refer to the clearances between live parts and the walls of the cells, compartments, or similar enclosing structures. They do not apply to the clearances between bus bars and supporting structures nor to clearances between the blade of a disconnecting switch and its base. However, where surge-protective devices are applied to protect the live parts, the vertical clearances, column 2 of Table 124-1 Part A may be reduced provided the clearance is not less than 8.5 ft plus the electrical clearance between energized parts and ground as limited by the surge-protective devices.

② Clearances shall satisfy either switching-surge or BIL duty requirements, whichever are greater.

③ Switching-surge factor—an expression of the maximum switching-surge crest voltage in terms of the maximum operating line-to-neutral crest voltage of the power system.

④ The values of columns A, B, and C are power system design factors that shall correlate with selected clearances. Adequate data to support these design factors should be available.

⑤ The selection of station BIL shall be coordinated with surge-protective devices when BIL is used to determine clearance. BIL—basic impulse insulation level—for definition and application, see IEEE Std 1313-1993.

125. Working space about electric equipment

A. Working space (600 V or less)

Access and working space shall be provided and maintained about electric equipment to permit ready and safe operation and maintenance of such equipment.

1. Clear spaces

Working space required by this section shall not be used for storage. When normally enclosed energized parts are exposed for inspection or servicing, the working space, if in a passageway or general open space, shall be guarded.

2. Access and entrance to working space

At least one entrance shall be provided to give access to the working space about electric equipment.

3. Working space

The working space in the direction of access to energized parts operating at 600 V or less that require examination, adjustment, servicing, or maintenance while energized shall be not less than indicated in Table 125-1. In addition to the dimensions shown in Table 125-1, the working space shall be not less than 750 mm (30 in) wide in front of the electric equipment. Distances shall be measured from the energized parts if such are exposed or from the enclosure front or opening if such are enclosed. Concrete, brick, or tile walls shall be considered grounded.

4. Headroom working space

The headroom of working spaces about switchboards or control centers shall be not less than 2.13 m (7 ft).

5. Front working space

In all cases where there are energized parts normally exposed on the front of switchboards or motor control centers, the working space in front of such equipment shall not be less than 900 mm (3 ft).

B. Working space over 600 V

Working space shall be in accordance with Table 124-1.

Table 125-1—Working space

Voltage to ground	Clear distance					
	Condition 1		Condition 2		Condition 3	
	mm	ft	mm	ft	mm	ft
0-150	900		900		900	
151-600	900		1070		1200	

Where the *conditions* are as follows:

- Exposed energized parts on one side and no energized or grounded parts on the other side of the working space, or exposed energized parts on both sides effectively guarded by suitable wood or other insulating materials. Insulated wire or insulated bus bars operating at not over 300 V shall not be considered energized parts.
- Exposed energized parts on one side and grounded parts on the other side.
- Exposed energized parts on both sides of the work space (not guarded as provided in Condition 1) with the operator between.

EXCEPTION: Working space shall not be required in back of assemblies, such as dead-front switchboards or motor control centers where there are no renewable or adjustable parts such as fuses or switches on the back and where all connections are accessible from locations other than the back.

126. Equipment for work on energized parts

When it is necessary for personnel to move themselves, material, or tools within the guard zone of unguarded energized parts, protective equipment shall be provided.

This protective equipment shall be periodically inspected, tested, and kept in a safe condition. Protective equipment shall be rated for not less than the voltage involved. Refer to Section 3 for a list of specifications for equipment.

127. Classified locations

Electrical installations in classified areas shall meet the requirements of the NEC, Articles 500 through 517. Areas classified in accordance with NEC Article 500 shall comply with the

requirements of that Article and A. through L. below. Areas classified with the optional Zone method in accordance with NEC Article 505 shall comply with the requirements of that article.

A. Coal-handling areas

1. Unventilated spaces inside or above coal-storage silos or bunkers, or other enclosed coal-storage and coal-handling spaces where methane may accumulate in explosive or ignitable mixtures as defined in Article 500-5 of the NEC, are Class I, Division 1, Group D locations. Electric equipment in other locations in which flammable gases or vapors may exist shall be in accordance with the NEC, Article 500-5, or the locations shall be adequately ventilated.
2. Adequate ventilation exists when the method of ventilation will limit the likelihood of accumulation of significant quantities of vapor-air concentrations from exceeding 25% of the lower flammable limit.
3. Tunnels beneath stockpiles or surge piles; spaces inside, above, or below coal-storage silos or bunkers; or other enclosed coal-storage or coal-handling spaces or areas shall be Class II, Group F, Division 1 or Division 2 locations as determined by the NEC.
4. Enclosed sections where only wet coal is handled, or enclosed sections so cut off as to be free from dangerous amounts of coal dust, are not classified. Coal shall be considered to be wet if enough water sprays are installed and maintained to limit the atmospheric concentration of total entrapped volatiles to 8% or less. (See ASTM D 3175 for coal and coke dusts).
5. Locations having completely dust-tight pulverized fuel systems designed and installed in compliance with NFPA 8503-1997 shall not be considered classified.
6. Portable lamps for use in fuel bunkers or bins shall be suitable for Class II, Division 1 locations.
7. Sparking electric tools shall not be used where combustible dust or dust clouds are present.
8. An equipment grounding conductor shall be carried with the power conductors and serve to ground the frames of all equipment supplied from that circuit. The origin of the grounding conductor shall be:
 - a. Ungrounded delta or wye-transformer frame ground.
 - b. Grounded delta or wye-transformer grounded secondary connection.
 - c. Resistance grounded wye—the grounded side of the grounding resistor.
9. Ungrounded systems should be equipped with a ground-fault indicating device to give both a visual and audible alarm upon the occurrence of a ground fault in the system.

B. Flammable and combustible liquids

1. Flammable liquid shall mean a liquid having a flash point below 38 °C (100 °F) and having a vapor pressure not exceeding 275 kPa (40 lb/in²) (absolute) at 38 °C (100 °F) and shall be known as a Class I liquid.
2. Combustible liquid shall mean a liquid having a flash point greater than or equal to 38 °C (100 °F) and having a vapor pressure not exceeding 275 kPa (40 lb/in²) (absolute) at 38 °C (100 °F).
3. Class I liquids are subdivided as follows:
 - a. Class IA includes those having flash points below 23 °C (73 °F) and having a boiling point below 38 °C (100 °F).
 - b. Class IB includes those having flash points below 23 °C (73 °F).
 - c. Class IC includes those having flash points at or above 23 °C (73 °F) and below 38 °C (100 °F).
4. Combustible liquids are subdivided as follows:
 - a. Class II includes those having flash points equal to or greater than 38 °C (100 °F) but less than 60 °C (140 °F).

Section 13. Rotating equipment

Rotating equipment includes generators, motors, motor generators, and rotary converters.

130. Speed control and stopping devices

A. Automatic overspeed trip device for prime movers

When harmful overspeed can occur, prime movers driving generating equipment shall be provided with automatic overspeed trip devices in addition to their governors.

B. Manual stopping devices

An operator-initiated stopping device shall be provided for any machine that drives an electric power generator or rotary uninterruptible power supply (motor-generator). The operator-initiated stopping device shall be accessible to the operator during normal operation. Manual controls to be used in emergency for machinery and electric equipment shall be located so as to provide protection to the operator in the event of such emergency.

C. Speed limit for motors

Machines of the following types shall be provided with speed-limiting devices unless their inherent characteristics or the load and the mechanical connection thereto are such as to safely limit the speed.

1. Separately excited dc motors
2. Series motors

D. Number 130D not used in this edition.

E. Adjustable-speed motors

Adjustable-speed motors, controlled by means of field regulation, shall, in addition to the provisions of Rule 130C, be so equipped and connected that the field cannot be weakened sufficiently to permit dangerous speed.

F. Protection of control circuits

Where speed-limiting or stopping devices and systems are electrically operated, the control circuits by which such devices are actuated shall be protected from mechanical damage. Such devices and systems should be of the automatic tripping type.

131. Motor control

All motors arranged such that an unexpected starting of the motor might create an exposure of personnel to injury shall have the motor control circuit designed to block unintended re-energization of the motor after a power supply interruption of a duration sufficient for moving equipment to become stationary. The motor control shall be such that an operator must take some action to restart the motor, or automatic restarting shall be preceded by warning signals and a time delay sufficient for personnel action to limit the likelihood of injury. This requirement does not apply to those motors with an emergency use and where the opening of the circuit may cause less safe conditions.

132. Number 132 not used in this edition.**133. Short-circuit protection**

Means shall be provided to automatically disconnect an electric motor from the supply source in the event of high-magnitude short-circuit currents within the motor.

Section 14. Storage batteries

140. General

The provisions of this section are intended to apply to all stationary installations of storage batteries. For operating precautions, see Part 4 of this Code.

Space shall be provided around batteries for safe inspection, maintenance, testing, and cell replacement and space left above the cells to allow for operation of lifting equipment when required, addition of water, and taking measurements.

141. Location

Storage batteries shall be located within a protective enclosure or area accessible only to qualified persons. A protective enclosure can be a battery room, control building, or a case, cage, or fence that will protect the contained equipment and limit the likelihood of inadvertent contact with energized parts.

142. Ventilation

The battery area shall be ventilated, either by a natural or powered ventilation system to limit hydrogen accumulation to less than an explosive mixture. Failure of a continuously operated or automatically controlled powered ventilation system required by design to limit hydrogen accumulation to less than an explosive mixture shall be annunciated.

143. Racks

Racks refer to frames designed to support cells or trays. Racks shall be firmly anchored, preferably to the floor. Anchoring to both walls and floors is not recommended. Racks made of metal shall be grounded.

144. Floors in battery areas

Floors of battery areas should be of an acid-resistive material, painted with acid-resistive paint, or otherwise protected. Provision should be made to contain spilled electrolyte.

145. Illumination for battery areas

Lighting fixtures shall be protected from physical damage by guards or isolation. Receptacles and lighting switches should be located outside of battery areas.

146. Service facilities

- A. Proper eye protection and clothing shall be provided in the battery area during battery maintenance and installation and shall consist of the following:
 - 1. Goggles or face shield
 - 2. Acid-resistant gloves
 - 3. Protective aprons and overshoes

4. Portable or stationary water facilities or neutralizing agent for rinsing eyes and skin
- B. Safety signs inside and outside of a battery room or in the vicinity of a battery area, prohibiting smoking, sparks, or flame shall be provided.

NOTE: ANSI Z535.1-2006, ANSI Z535.2-2006, ANSI Z535.3-2006, ANSI Z535.4-2006, and ANSI Z535.5-2006 contain information regarding safety signs.

Section 15. Transformers and regulators

150. Current-transformer secondary circuits protection when exceeding 600 V

Secondary circuits, when in the vicinity of primary circuits exceeding 600 V should, except for short lead lengths at the terminals of the transformer, have the secondary wiring adequately protected by means of conduit, covering, or some other protection. Any metallic covering used shall be effectively grounded, giving appropriate consideration to circulating currents. Current transformers shall have provision for shorting the secondary winding.

151. Grounding secondary circuits of instrument transformers

The secondary circuits of instrument transformers shall be effectively grounded where functional requirements permit.

152. Location and arrangement of power transformers and regulators

A. Outdoor installations

1. Power transformers and regulators shall be so installed that all energized parts are enclosed or guarded so as to limit the likelihood of inadvertent contact, or the energized parts shall be physically isolated in accordance with Rule 124. The case shall be effectively grounded or guarded.
2. The installation of liquid-filled transformers shall utilize one or more of the following methods to minimize fire hazards. The method to be applied shall be according to the degree of the fire hazard. Recognized methods are the use of less flammable liquids, space separation, fire-resistant barriers, automatic extinguishing systems, absorption beds, and enclosures.

The amount and characteristics of liquid contained should be considered in the selection of space separation, fire-resistant barriers, automatic extinguishing systems, absorption beds, and enclosures that confine the liquid of a ruptured transformer tank, all of which are recognized as safeguards.

B. Indoor installations

1. Transformers and regulators 75 kVA and above containing an appreciable amount of flammable liquid and located indoors shall be installed in ventilated rooms or vaults separated from the balance of the building by fire walls. Doorways to the interior of the building shall be equipped with fire doors and shall have means of containing the liquid.
2. Transformers or regulators of the dry type or containing a nonflammable liquid or gas may be installed in a building without a fireproof enclosure. When installed in a building used for other than station purposes, the case or the enclosure shall be so designed that all energized parts are enclosed in the case that is grounded in accordance with Rule 123. As an alternate, the entire unit may be enclosed so as to limit the likelihood of inadvertent contact by persons with any part of the case or wiring. When installed, the pressure-relief vent of a unit containing a nonbiodegradable liquid shall be furnished with a means for absorbing toxic gases.
3. Transformers containing less flammable liquid may be installed in a supply station building in such a way as to minimize fire hazards. The amount of liquid contained, the type of electrical protection, and tank venting shall be considered in the selection of space separation from combustible materials or structures, liquid confinement, fire-resistant barriers or enclosures, or extinguishing systems.

153. Short-circuit protection of power transformers

Power transformers shall be provided with means to disconnect automatically the source of supply of current for a high magnitude short circuit (fault) within the transformer.

The devices for automatically disconnecting the source of supply may be a circuit breaker, circuit switcher, fuse, thyristor blocking, or other reasonable methods either locally or remotely connected to the transformer. This includes disconnecting the generator electric field source together with the source of mechanical energy upon detection of a fault in either the generator step-up or station auxiliary transformer. Removing a single phase rather than all three phases to extinguish short-circuit current is acceptable.

EXCEPTION: Transformers other than power transformers are exempt from this rule. This includes instrument transformers, neutral grounding transformers, regulating transformers, and other transformers specifically for control, protection, or metering.

Section 16. Conductors

160. Application

Conductors shall be suitable for the location, use, and voltage. Conductors shall have ampacity that is adequate for the application.

161. Electrical protection

A. Overcurrent protection required

Conductors and insulation shall be protected against excessive heating by the design of the system and by overcurrent, alarm, indication, or trip devices.

B. Grounded conductors

Conductors normally grounded for the protection of persons shall be arranged without overcurrent protection or other means that could interrupt their continuity to ground.

C. Insulated power cables

Insulated power cable circuits shall be provided with short-circuit protection that will isolate the short circuit from the supply.

162. Mechanical protection and support

A. All conductors shall be adequately supported to withstand forces caused by the maximum short-circuit current to which they may be subjected. Where supported conductors extend outside the electric supply station, such conductors and their supports shall comply with the grades of construction, strength, and loading requirements of Part 2 of this Code.

B. Where conductors, conductor insulation, or conductor supports may be subjected to mechanical damage, casing, armor, or other means shall be employed to limit the likelihood of damage or disturbance.

163. Isolation

All nonshielded insulated conductors of more than 2500 V to ground and bare conductors of more than 150 V to ground shall be isolated by elevation or guarded in accordance with Rule 124.

Nonshielded, insulated, and jacketed conductors may be installed in accordance with Rule 124C6.

164. Conductor terminations

A. Insulation

Ends and joints of insulated conductors, unless otherwise adequately guarded, shall have insulating covering equivalent to that of other portions of the conductor.

B. Metal-sheathed or shielded cable

Insulation of the conductors, where leaving the metal sheath or shield, shall be protected from mechanical damage, moisture, and excessive electrical stress.

Section 17.

Circuit breakers, reclosers, switches, and fuses

170. Arrangement

Circuit breakers, reclosers, switches, and fuses shall be so installed as to be accessible only to persons qualified for operation and maintenance. Walls, barriers, latched doors, location, isolation, or other means shall be provided to protect persons from energized parts or arcing. Conspicuous markings (such as numbers/letters/symbols) shall be provided on each device and at any remote operating points so as to facilitate identification by employees authorized to operate the device. No device identification shall be duplicated within the same supply station. When the contact parts of a switching device are not normally visible, the device shall be equipped with an indicator to show all normal operating positions.

171. Application

Circuit breakers, circuit switchers, reclosers, switches, and fuses should be utilized with due regard to their assigned ratings of voltage and continuous and momentary currents. Devices that are intended to interrupt fault current shall be capable of safely interrupting the maximum short-circuit current they are intended to interrupt, and for the circumstances under which they are designed to operate. The interrupting capacity should be reviewed prior to each significant system change.

172. Circuit breakers, reclosers, and switches containing oil

Circuit-interrupting devices containing flammable liquids shall be adequately segregated from other equipment and buildings to limit damage in the event of an explosion or fire. Segregation may be provided by spacing, by fire-resistant barrier walls, or by metal cubicles. Gas-relief vents should be equipped with oil-separating devices or piped to a safe location. Means shall be provided to control oil that could be discharged from vents or by tank rupture. This may be accomplished by absorption beds, pits, drains, or by any combination thereof. Buildings or rooms housing this equipment shall be of fire-resistant construction.

173. Switches and disconnecting devices

A. Capacity

Switches shall be of suitable voltage and ampere rating for the circuit in which they are installed. Switches used to break load current shall be marked with the current that they are rated to interrupt.

B. Provisions for disconnecting

Switches and disconnectors shall be so arranged that they can be locked in the open and closed positions, or plainly tagged where it is not practical to install locks. (See Part 4 of this Code.) For devices that are operated remotely and automatically, the control circuit shall be provided with a positive disconnecting means near the apparatus to limit the likelihood of accidental operation of the mechanism.

174. Disconnection of fuses

Fuses in circuits of more than 150 V to ground or more than 60 A shall be classified as disconnecting fuses or be so arranged that before handling:

- A. The fuses can be disconnected from all sources of electric energy, or
- B. The fuses can be conveniently removed by means of insulating handles.

Fuses can be used to disconnect from the source when they are so rated.

Section 18.

Switchgear and metal-enclosed bus

180. Switchgear assemblies

A. General requirements for all switchgear

1. To minimize movement, all switchgear shall be secured in a manner consistent with conditions of service and applicable manufacturer's instructions.
2. Cable routed to switchgear shall be supported to minimize forces applied to conductor terminals.
3. Piping containing liquids, or corrosive or hazardous gases, shall not be routed in the vicinity of switchgear unless suitable barriers are installed to protect the switchgear from damage in the event of a pipe failure.
4. Switchgear shall not be located where foreign flammable or corrosive gases or liquids routinely and normally are discharged. Companion equipment such as transformers and switchgear are not considered foreign.
5. Switchgear should not be installed in a location that is still specifically under active construction, especially where welding and burning are required directly overhead. Special precautions should be observed to minimize impingement of slag, metal filings, moisture, dust, or hot particles.

EXCEPTION: Switchgear may be installed in a general construction area if suitable temporary protection is provided to minimize the risks associated with general construction activities.

6. Precautions shall be taken to protect energized switchgear from damage when maintenance is performed in the area.
7. Switchgear enclosure surfaces shall not be used as physical support for any item unless specifically designed for that purpose.
8. Enclosure interiors shall not be used as storage areas unless specifically designed for that purpose.
9. Metal instrument cases shall be grounded and enclosed in covers that are metal and grounded, or are of insulating material.

B. Metal-enclosed power switchgear

1. Switchgear shall not be located within 7.6 m (25 ft) horizontally indoors or 3.0 m (10 ft) outdoors of storage containers, vessels, utilization equipment, or devices containing flammable liquids or gases.

EXCEPTION: If an intervening barrier, designed to mitigate the potential effects of flammable liquids or gases, is installed, the distances listed above do not apply.

NOTE: Rule 180B1 is not intended to apply to the power transformer(s) supplying the switchgear.

2. Enclosed switchgear rooms shall have at least two means of egress, one at each extreme of the area, not necessarily in opposite walls. Doors shall swing out and be equipped with panic bars, pressure plates, or other devices that are normally latched but open under simple pressure.

EXCEPTION: One door may be used when required by physical limitations if means are provided for unhampered exit during emergencies.

3. Space shall be maintained in front of switchgear to allow breakers to be removed and turned without obstruction.
4. Space shall be maintained in the rear of the switchgear to allow for door opening to at least 90 degrees open, or a minimum of 900 mm (3 ft) without obstruction when removable panels are used.
5. Permanently mounted devices, panelboards, etc., located on the walls shall not encroach on the space requirements in 180B4.

6. Where columns extend into the room beyond the wall surface, the face of the column shall not encroach on the space requirements in 180B4.
7. Low-voltage cables or conductors, except those to be connected to equipment within the compartment, shall not be routed through the medium- or high-voltage divisions of switchgear unless installed in rigid metal conduit or isolated by rigid metal barriers.
8. Low-voltage conductors routed from medium- or high-voltage sections of switchgear shall terminate in a low-voltage section before being routed external to the switchgear.
9. Conductors entering switchgear shall be insulated for the higher operating voltage in that compartment or be separated from insulated conductors of other voltage ratings.
10. Switchgear enclosures shall be suitable for the environment in which they are installed.
11. A safety sign shall be placed in each cubicle containing more than one high-voltage source.
NOTE: ANSI Z535.1-2006, ANSI Z535.2-2006, ANSI Z535.3-2006, ANSI Z535.4-2006, and ANSI Z535.5-2006 contain information regarding safety signs.
12. The location of control devices shall be readily accessible to personnel. Instruments, relays, and other devices requiring reading or adjustments should be so placed that work can readily be performed from the working space.

C. Dead-front power switchboards

Dead-front power switchboards with uninsulated rear connections shall be installed in rooms or spaces that are capable of being locked, with access limited to qualified personnel.

D. Motor control centers

1. Motor control centers shall not be connected to systems having higher short-circuit capability than the bus bracing can withstand. Where current-limiting fuses are employed on the source side of the bus, the bus bracing and breaker-interrupting rating are determined by the peak let-through characteristic of the current-limiting fuse.
2. A safety sign shall be placed in each cubicle containing more than one voltage source.
NOTE: ANSI Z535.1-2006, ANSI Z535.2-2006, ANSI Z535.3-2006, ANSI Z535.4-2006, and ANSI Z535.5-2006 contain information regarding safety signs.

E. Control switchboards

1. Cabinets containing solid-state logic devices, electron tubes, or relay logic devices such as boiler analog, burner safety, annunciators, computers, inverters, precipitator logic, soot blower control, load control, telemetering, totalizing microwave radio, etc., are covered under these rules.
2. Where carpeting is installed in rooms containing control switchboards, it shall be of an antistatic type and shall minimize the release of noxious, corrosive, caustic, or toxic gas under any condition.
3. Layout of the installation shall provide adequate clearance in front of, or rear of, panels if applicable, to allow meters to be read without use of stools or auxiliary devices.
4. Where personnel access to control panels, such as benchboards, is required, cables shall be routed through openings separate from the personnel opening. Removable, sliding, or hinged panels are to be installed to close the personnel opening when not in use.

181. Metal-enclosed bus

A. General requirements for all types of bus

1. Busways shall be installed only in accessible areas.
2. Busways, unless specifically approved for the purpose, shall not be installed: where subject to severe physical damage or corrosive vapors; in hoistways; in any classified hazardous location; outdoors or in damp locations.

3. Deadends of busway shall be closed.
 4. Busways should be marked with the voltage and current rating for which they are designed, in such manner as to be visible after installation.
- B. Isolated-phase bus
1. The minimum clearance between an isolated-phase bus and any magnetic material shall be the distance recommended by the manufacturer to avoid overheating of the magnetic material.
 2. Nonmagnetic conduit should be used to protect the conductors for bus-alarm devices, thermocouples, space heaters, etc., if routed within the manufacturer's recommended minimum distance to magnetic material and parallel to isolated-phase bus enclosures.
 3. When enclosure drains are provided for isolated-phase bus, necessary piping shall be provided to divert water away from electrical equipment.
 4. Wall plates for isolated-phase bus shall be nonmagnetic, such as aluminum or stainless steel.
 5. Grounding conductors for isolated-phase bus accessories should not be routed through ferrous conduit.

Section 19. Surge arresters

190. General requirements

If arresters are required, they shall be located as close as practical to the equipment they protect.

NOTE: See IEEE Std C62.1TM-1989 [B55] and IEEE Std C62.11TM-1999 [B56] for additional information.

191. Indoor locations

Arresters, if installed inside of buildings, shall be enclosed or shall be located well away from passageways and combustible parts.

192. Grounding conductors

Grounding conductors shall be run as directly as practical between the arresters and ground and be of low impedance and ample current-carrying capacity and shall be grounded in accordance with the methods outlined in Section 9.

193. Installation

Arresters shall be installed in such a manner and location that neither the expulsion of gases nor the arrester disconnector is directed upon live parts in the vicinity.

Part 2.

Safety Rules for the Installation and Maintenance of Overhead Electric Supply and Communication Lines

Section 20.

Purpose, scope, and application of rules

200. Purpose

The purpose of Part 2 of this Code is the practical safeguarding of persons during the installation, operation, or maintenance of overhead supply and communication lines and their associated equipment.

201. Scope

Part 2 of this Code covers supply and communication conductors and equipment in overhead lines. It covers the associated structural arrangements of such systems and the extension of such systems into buildings. The rules include requirements for spacing, clearances, and strength of construction. They do not cover installations in electric supply stations except as required by Rule 162A.

NOTE 1: Part 4 contains the approach distances and work rules required of supply and communication employers and their employees working on or near supply and communication lines and equipment.

NOTE 2: The approach distances to energized parts, and other requirements applicable to the activities of utility or non-utility construction personnel, and others in close proximity to existing supply lines are governed by the Occupational Health and Safety Administration (OSHA), federal, state, or local statutes or regulations.

202. Application of rules

The general requirements for application of these rules are contained in Rule 13. However, when a structure is replaced, the arrangement of equipment shall conform to the current edition of Rule 238C.

Section 21. General requirements

210. Referenced sections

The Introduction (Section 1), Definitions (Section 2), References (Section 3), and Grounding methods (Section 9) shall apply to the requirements of Part 2.

211. Number 211 not used in this edition.

212. Induced voltages

Rules covering supply-line influence and communication-line susceptiveness have not been detailed in this Code. Cooperative procedures are recommended in the control of voltages induced from proximate facilities. Therefore, reasonable advance notice should be given to owners or operators of other proximate facilities that may be adversely affected by new construction or changes in existing facilities.

NOTE: Additional information about supply-line influence and communication-line susceptiveness may be obtained from IEEE Std 776™-1992 [B39] and IEEE Std 1137™-1991 [B51].

213. Accessibility

All parts that must be examined or adjusted during operation shall be arranged so as to be accessible to authorized persons by the provision of adequate climbing spaces, working spaces, working facilities, and clearances between conductors.

214. Inspection and tests of lines and equipment

A. When in service

1. Initial compliance with rules

Lines and equipment shall comply with these safety rules when placed in service.

2. Inspection

Lines and equipment shall be inspected at such intervals as experience has shown to be necessary.

NOTE: It is recognized that inspections may be performed in a separate operation or while performing other duties, as desired.

3. Tests

When considered necessary, lines and equipment shall be subjected to practical tests to determine required maintenance.

4. Record of defects

Any defects affecting compliance with this Code revealed by inspection or tests, if not promptly corrected, shall be recorded; such records shall be maintained until the defects are corrected.

5. Remedying defects

Lines and equipment with recorded defects that could reasonably be expected to endanger life or property shall be promptly repaired, disconnected, or isolated.

B. When out of service

1. Lines infrequently used

Lines and equipment infrequently used shall be inspected or tested as necessary before being placed into service.

2. Lines temporarily out of service

Lines and equipment temporarily out of service shall be maintained in a safe condition.

3. Lines permanently abandoned

Lines and equipment permanently abandoned shall be removed or maintained in a safe condition.

215. Grounding of circuits, supporting structures, and equipment

A. Methods

Grounding required by these rules shall be in accordance with the applicable methods given in Section 9.

B. Circuits

1. Common neutral

A conductor used as a common neutral for primary and secondary circuits shall be effectively grounded as specified in Section 9.

2. Other neutrals

Primary line, secondary line, and service neutral conductors shall be grounded as specified in Section 9.

EXCEPTION: Circuits designed for ground-fault detection and impedance-current-limiting devices.

3. Other conductors

Line or service conductors, other than neutral conductors, that are intentionally grounded, shall be grounded as specified in Section 9.

4. Surge arresters

Where the operation of surge arresters is dependent upon grounding, they shall be grounded in accordance with the methods outlined in Section 9.

5. Use of earth as part of circuit

- a. Supply circuits shall not be designed to use the earth normally as the sole conductor for any part of the circuit.
- b. Monopolar operation of a bipolar HVDC system is permissible for emergencies and limited periods for maintenance.

C. Non-current-carrying parts

1. General

Metal or metal-reinforced supporting structures, including lamp posts; metal conduits and raceways; cable sheaths; messengers; metal frames, cases, and hangers of equipment; and metal switch handles and operating rods shall be effectively grounded.

EXCEPTION 1: This rule does not apply to frames, cases, and hangers of equipment and switch handles and operating rods that are 2.45 m (8 ft) or more above readily accessible surfaces or are otherwise isolated or guarded and where the practice of not grounding such items has been a uniform practice over a well-defined area.

EXCEPTION 2: This rule does not apply to isolated or guarded equipment cases in certain specialized applications, such as series capacitors where it is necessary that equipment cases be either ungrounded or connected to the circuit. Such equipment cases shall be considered as energized and shall be suitably identified.

EXCEPTION 3: This rule does not apply to equipment cases, frames, equipment hangers, conduits, messengers, raceways, and cable sheaths enclosing or supporting only communication conductors, provided they are not exposed to contact with open supply conductors of over 300 V.

2. Anchor guys and span guys

Anchor guys and span guys shall be effectively grounded.

EXCEPTION: Where one or more guy insulators meeting the requirements of Rules 279A1 and 215C5 are inserted in an anchor guy or span guy, the guy is not required to be grounded.

NOTE: For the purpose of this rule, if a span guy and its associated anchor guy are bonded together, they may be considered as one guy.

3. Span wires carrying luminaires or traffic signals

Span wires carrying luminaires or traffic signals shall be effectively grounded.

EXCEPTION: Where one or more span-wire insulators meeting the requirements of Rules 279B and 215C5 are inserted in a luminaire or traffic signal span wire, the span wire is not required to be grounded.

4. Span wires carrying trolley or electric railway contact conductors

Span wires carrying trolley or electric railway contact conductors shall be effectively grounded at the structures.

EXCEPTION: Where one or more span-wire insulators meeting the requirements of Rules 279B and 215C6 are inserted in a contact conductor span wire, the span wire is not required to be grounded.

5. Use of insulators in anchor guys, span guys, and span wires supporting luminaires or traffic signals

Where insulators are used in lieu of grounding in anchor guys, span guys, or in span wires supporting luminaires or traffic signals in accordance with Rule 215C2 or 215C3, insulators shall be installed as follows:

- a. All guy insulators or span-wire insulators shall be located at a position such that the bottom of the insulator shall be not less than 2.45 m (8 ft) above the ground if the guy or span wire is broken below the insulator.
- b. Insulators shall be so placed that, in case any guy or span-wire contacts, or is contacted by, an energized conductor or part, the voltage will not be transferred to other facilities on the structure(s).
- c. Insulators shall be so placed that in case any guy or span wire sags down upon another, the insulators will not become ineffective.

6. Use of insulators in span wires supporting trolley or electric railroad contact conductors

- a. All span wires supporting trolley or electric railroad contact conductors, including bracket span wires, shall have a suitable insulator (in addition to an insulated hanger if used) inserted between each point of support of the span wire and the luminaire or trolley-contact conductor supported.

EXCEPTION 1: Single insulators, as provided by an insulated hanger, may be permitted when the span wire or bracket is supported on wood poles supporting only trolley, railway feeder, or communication conductors used in the operation of the railway concerned.

EXCEPTION 2: Insulators are not required if the span wire is effectively grounded.

EXCEPTION 3: This rule does not apply to insulated feeder taps used as span wires.

- b. In case insulated hangers are not used, the insulator shall be located so that in the event of a broken wire, the energized part of the span wire cannot be reached from the ground.

7. Insulators used to limit galvanic corrosion

An insulator in the guy strand used exclusively for the limitation of galvanic corrosion of metal in ground rods, anchors, anchor rods, or pipe in an effectively grounded system shall meet the requirements of Rule 279A1c and shall be installed such that (a) the upper portion of a guy has been effectively grounded according to Rule 215C, and (b) the top of insulators used to limit

galvanic corrosion shall be installed at an elevation below exposed energized conductors and parts.

NOTE: See Rule 279A2a.

8. Multiple messengers on the same structure

Communication cable messengers exposed to power contacts, power induction, or lightning, shall be bonded together at intervals specified in Rule 92C.

216. Arrangement of switches

A. Accessibility

Switches or their control mechanisms shall be installed so as to be accessible to authorized persons.

B. Indicating open or closed position

Switch position shall be visible or clearly indicated.

C. Locking

Switch-operating mechanisms that are accessible to unauthorized persons shall have provisions for locking in each operational position.

D. Uniform position

The handles or control mechanisms for all switches throughout any system should have consistent positions when opened and uniformly different positions when closed in order to minimize operating errors. Where this practice is not followed, the switches should be marked to minimize mistakes in operation.

E. Remotely controlled, automatic transmission, or distribution overhead line switching devices shall have local provisions to render remote or automatic controls inoperable.

217. General

A. Supporting structures

1. Protection of structures

a. Mechanical damage

Appropriate physical protection shall be provided for supporting structures subject to vehicular traffic abrasion that would materially affect their strength.

This rule does not require protection or marking of structural components located outside of the traveled ways of roadways or established parking areas.

NOTE: Experience has shown that it is not practical to protect structures from contact by out-of-control vehicles operating outside of established traveled ways.

b. Fire

Supporting structures shall be placed and maintained so as to be exposed as little as is practical to brush, grass, rubbish, or building fires.

c. Attached to bridges

Supporting structures attached to bridges for the purpose of carrying open supply conductors exceeding 600 V shall be posted with appropriate safety signs.

NOTE: ANSI Z535.1-2006, ANSI Z535.2-2006, ANSI Z535.3-2006, ANSI Z535.4-2006, and ANSI Z535.5-2006 contain information regarding safety signs.

2. Readily climbable supporting structures

a. Readily climbable supporting structures, such as closely latticed poles, towers, or bridge attachments, carrying open supply conductors energized at more than 300 V, which are adjacent to roads, regularly traveled pedestrian thoroughfares, or places where persons

frequently gather (such as schools or public playgrounds), shall be equipped with barriers to inhibit climbing by unqualified persons or posted with appropriate safety signs.

EXCEPTION: This rule does not apply where access to the supporting structure is limited by a fence meeting the height requirements of Rule 110A1.

NOTE: ANSI Z535.1-2006, ANSI Z535.2-2006, ANSI Z535.3-2006, ANSI Z535.4-2006, and ANSI Z535.5-2006 contain information regarding safety signs.

b. Steps

Steps permanently installed on supporting structures shall not be closer than 2.45 m (8 ft) from the ground or other accessible surface.

EXCEPTION 1: This rule does not apply where supporting structures are isolated.

EXCEPTION 2: This rule does not apply where access to the supporting structure is limited by a fence meeting the height requirements of Rule 110A1.

c. Standoff brackets

Standoff brackets on supporting structures shall be arranged so that there is not less than 2.45 m (8 ft) between either:

- (1) The lowest bracket and ground or other accessible surface, or
- (2) The two lowest brackets.

EXCEPTION: This rule does not apply where supporting structures are isolated.

3. Identification

Supporting structures, including those on bridges, on which supply or communication conductors are maintained shall be so constructed, located, marked, or numbered so as to facilitate identification by employees authorized to work thereon.

4. Obstructions

Signs, posters, notices, and other attachments shall not be placed on supporting structures without concurrence of the owner. Supporting structures should be kept free from other climbing hazards such as tacks, nails, vines, and through bolts not properly trimmed.

5. Decorative lighting

Attachment of decorative lighting on structures shall not be made without the concurrence of the owners and occupants.

B. Unusual conductor supports

Where line conductors are attached to structures other than those used solely or principally for their support, all rules shall be complied with as far as they apply. Such additional precautions as may be deemed necessary by the administrative authority shall be taken to avoid damage to the structures or injury to the persons using them. The supporting of conductors on trees and roofs should be avoided.

C. Protection and marking of guys

1. The ground end of anchor guys exposed to pedestrian traffic shall be provided with a substantial and conspicuous marker.

NOTE: Visibility of markers can be improved by the use of color or color patterns that provide contrast with the surroundings.

2. Where an anchor is located in an established parking area, the guy shall either be protected from vehicle contact or marked.
3. This rule does not require protection or marking of anchor guys located outside of the traveled ways of roadways or established parking areas.

NOTE: Experience has shown that it is not practical to protect guys from contact by out of control vehicles operating outside of established traveled ways.

218. Vegetation management

A. General

1. Vegetation that may damage ungrounded supply conductors should be pruned or removed. Vegetation management should be performed as experience has shown to be necessary.

NOTE: Factors to consider in determining the extent of vegetation management required include, but are not limited to: line voltage class, species' growth rates and failure characteristics, right-of-way limitations, the vegetation's location in relation to the conductors, the potential combined movement of vegetation and conductors during routine winds, and sagging of conductors due to elevated temperatures or icing.

2. Where pruning or removal is not practical, the conductor should be separated from the tree with suitable materials or devices to avoid conductor damage by abrasion and grounding of the circuit through the tree.

B. At line crossings, railroad crossings and limited-access highway crossings

The crossing span and the adjoining span on each side of the crossing should be kept free from overhanging or decayed trees or limbs that otherwise might fall into the line.

Section 22. Relations between various classes of lines and equipment

220. Relative levels

A. Standardization of levels

The levels at which different classes of conductors are to be located should be standardized by agreement of the utilities concerned.

B. Relative levels: supply and communication conductors

1. Preferred levels

Where supply and communication conductors cross each other or are located on the same structures, the supply conductors should be carried at the higher level.

EXCEPTION: This rule does not apply to trolley feeders, which may be located for convenience approximately at the level of the trolley-contact conductor.

2. Special construction for supply circuits, the voltage of which is 600 V or less and carrying power not in excess of 5 kW

Where all circuits are owned or operated by one party or where cooperative consideration determines that the circumstances warrant and the necessary coordinating methods are employed, single-phase ac or two-wire dc circuits carrying a voltage of 600 V or less between conductors, with transmitted power not in excess of 5 kW, when involved in the joint use of structures with communication circuits, may be installed in accordance with footnote 1 of Table 235-5, under the following conditions:

- a. That such supply circuits are of covered conductor not smaller than AWG No. 8 medium hard-drawn copper or its equivalent in strength, and the construction otherwise conforms with the requirements for supply circuits of the same class.
- b. That the supply circuits be placed on the end and adjacent pins of the lowest through signal support arm and that a 750 mm (30 in) climbing space be maintained from the ground up to a point at least 600 mm (24 in) above the supply circuits. The supply circuits shall be rendered conspicuous by the use of insulators of different form or color from others on the pole line or by stenciling the voltage on each side of the support arm between the pins carrying each supply circuit, or by indicating the voltage by means of metal characters.
- c. That there shall be a vertical clearance of at least 600 mm (2 ft) between the support arm carrying these supply circuits and the next support arm above. The other pins on the support arm carrying the supply circuits may be occupied by communication circuits used in the operation or control of signal system or other supply system if owned, operated, and maintained by the same company operating the supply circuits.
- d. That such supply circuits shall be equipped with arresters and fuses installed in the supply end of the circuit and where the signal circuit is ac, the protection shall be installed on the secondary side of the supply transformer. The arresters shall be designed so as to break down at approximately twice the voltage between the wires of the circuit, but the break-down voltage of the arrester need not be less than 1 kV. The fuses shall have a rating not in excess of approximately twice the maximum operating current of the circuit, but their rating need not be less than 10 A. The fuses likewise in all cases shall have a rating of at least 600 V, and where the supply transformer is a step-down transformer, shall be capable of opening the circuit successfully in the event the transformer primary voltage is impressed upon them.
- e. Such supply circuits in cable meeting the requirements of Rule 230C1, 230C2, or 230C3 may be installed below communication attachments, with not less than 400 mm (16 in) vertical separation between the supply cable and the lowest communication attachment.

Communication circuits other than those used in connection with the operation of the supply circuits shall not be carried in the same cable with such supply circuits.

- f. Where such supply conductors are carried below communication conductors, transformers and other apparatus associated therewith shall be attached only to the sides of the support arm in the space between and at no higher level than such supply wires.
 - g. Lateral runs of such supply circuits carried in a position below the communication space shall be protected through the climbing space by wood molding or equivalent covering, or shall be carried in insulated multiple-conductor cable, and such lateral runs shall be placed on the underside of the support arm.
- C. Relative levels: Supply lines of different voltage classifications (0 to 750 V, over 750 V to 8.7 kV, over 8.7 kV to 22 kV, and over 22 kV to 50 kV)
- 1. At crossings or conflicts

Where supply conductors of different voltage classifications cross each other or structure conflict exists, the higher-voltage lines should be carried at the higher level.
 - 2. On structures used only by supply conductors

Where supply conductors of different voltage classifications are on the same structures, relative levels should be as follows:

 - a. Where all circuits are owned by one utility, the conductors of higher voltage should be placed above those of lower voltage.
 - b. Where different circuits are owned by separate utilities, the circuits of each utility may be grouped together, and one group of circuits may be placed above the other group provided that the circuits in each group are located so that those of higher voltage are at the higher levels and that any of the following conditions is met:
 - (1) A vertical clearance of not less than that required by Table 235-5 is maintained between the nearest line conductors of the respective utilities.
 - (2) Conductors of a lower voltage classification placed at a higher level than those of a higher classification shall be placed on the opposite side of the structure.
 - (3) Ownership and voltage are prominently displayed.
- D. Identification of overhead conductors
- All conductors of electric supply and communication lines should, as far as is practical, be arranged to occupy uniform positions throughout, or shall be constructed, located, marked, numbered, or attached to distinctive insulators or crossarms, so as to facilitate identification by employees authorized to work thereon. This does not prohibit systematic transposition of conductors.
- E. Identification of equipment on supporting structures
- All equipment of electric supply and communication lines should be arranged to occupy uniform positions throughout or shall be constructed, located, marked, or numbered so as to facilitate identification by employees authorized to work thereon.

221. Avoidance of conflict

Two separate lines, either of which carries supply conductors, should be so separated from each other that neither conflicts with the other. If this is not practical, the conflicting line or lines should be separated as far as practical and shall be built to the grade of construction required by Section 24 for a conflicting line, or the two lines shall be combined on the same structures.

222. Joint use of structures

Joint use of structures should be considered for circuits along highways, roads, streets, and alleys. The choice between joint use of structures and separate lines shall be determined through

cooperative consideration of all the factors involved, including the character of circuits, the total number and weight of conductors, tree conditions, number and location of branches and service drops, structure conflicts, availability of right-of-way, etc. Where such joint use is mutually agreed upon, it shall be subject to the appropriate grade of construction specified in Section 24.

223. Communications protective requirements

A. Where required

Where communication apparatus is handled by other than qualified persons, it shall be protected by one or more of the means listed in Rule 223B if such apparatus is permanently connected to lines subject to any of the following:

1. Lightning
2. Contact with supply conductors whose voltage to ground exceeds 300 V
3. Transient rise in ground potential exceeding 300 V
4. Steady-state induced voltage of a hazardous level

Where communication cables will be in the vicinity of supply stations where large ground currents may flow, the effect of these currents on communication circuits should be evaluated.

NOTE: Additional information may be obtained from IEEE Std 487™-2000 [B34] and 1590™-2003 [B54].

B. Means of protection

Where communication apparatus is required to be protected under Rule 223A, protective means adequate to withstand the voltage expected to be impressed shall be provided by insulation, protected where necessary by surge arresters used in conjunction with fusible elements. Severe conditions may require the use of additional devices such as auxiliary arresters, drainage coils, neutralizing transformers, or isolating devices.

224. Communication circuits located within the supply space and supply circuits located within the communication space

A. Communication circuits located in the supply space

1. Communication circuits located in the supply space shall be installed and maintained only by personnel authorized and qualified to work in the supply space in accordance with the applicable rules of Sections 42 and 44.
2. Communication circuits located in the supply space shall meet the following clearance requirements, as applicable:
 - a. Insulated communication cables supported by an effectively grounded messenger shall have the same clearances as neutrals meeting Rule 230E1 from communication circuits located in the communication space and from supply conductors located in the supply space. See Rules 235 and 238.
 - b. Fiber-optic cables located in the supply space shall meet the requirements of Rule 230F.
 - c. Open-wire communication circuits permitted by other rules to be in the supply space shall have the same clearances from communication circuits located in the communication space and from other circuits located in the supply space as required by Rule 235 for ungrounded open supply conductors of 0–750 V.

EXCEPTION: Service drops meeting Rules 224A3a and 224A3b may originate in the supply space on a line structure or in the span and terminate in the communication space on the building or structure being served.
3. Communication circuits located in the supply space in one portion of the system may be located in the communication space in another portion of the system if the following requirements are met:

- a. Where the communication circuit is, at any point, located above an energized supply conductor or cable, the communication circuit shall be protected by fuseless surge arresters, drainage coils, or other suitable devices to limit the normal communication circuit voltage to 400 V or less to ground.

NOTE: The grades of construction for communication conductors with inverted levels apply.

- b. Where the communication circuit is always located below the supply conductors, the communication protection shall meet the requirements of Rule 223.
- c. The transition(s) between the supply space and the communication space shall occur on a single structure; no transition shall occur between line structures.

EXCEPTION: Service drops meeting Rules 224A3a and 224A3b may originate in the supply space on a line structure or in the span and terminate in the communication space on the building or structure being served.

- d. The construction and protection shall be consistently followed throughout the extent of such section of the communications system.

B. Supply circuits used exclusively in the operation of communication circuits

Circuits used for supplying power solely to apparatus forming part of a communications system shall be installed as follows:

1. Open-wire circuits shall have the grades of construction, clearances, insulation, etc., prescribed elsewhere in these rules for supply or communication circuits of the voltage concerned.
2. Special circuits operating at voltages in excess of 90 V ac or 150 V dc and used for supplying power solely to communications equipment may be included in communication cables under the following conditions:
 - a. Such cables shall have a conductive sheath or shield that is effectively grounded, and each such circuit shall be carried on conductors that are individually enclosed with an effectively grounded shield.
 - b. All circuits in such cables shall be owned or operated by one party and shall be maintained only by qualified personnel.
 - c. Supply circuits included in such cables shall be terminated at points accessible only to qualified personnel.
 - d. Communication circuits brought out of such cables, if they do not terminate in a repeater station or terminal office, shall be protected or arranged so that in the event of failure within the cable, the voltage on the communication circuit will not exceed 400 V to ground.
 - e. Terminal apparatus for the power supply shall be so arranged that the live parts are inaccessible when such supply circuits are energized.

EXCEPTION: The requirements of Rule 224B2 do not apply to communication circuits where the transmitted power does not exceed 150 W.

225. Electric railway construction

A. Trolley-contact conductor fastenings

All overhead trolley-contact conductors shall be supported and arranged so that the breaking of a single contact conductor fastening will not allow the trolley conductor live span wire, or current-carrying connection, to come within 3.0 m (10 ft) (measured vertically) from the ground, or from any platform accessible to the general public.

Span-wire insulation for trolley-contact conductors shall comply with Rule 279B.

4. Rounding of calculation results

Unless otherwise specified in a table or rule within Section 23 that requires a calculation, the resultant of the calculation shall be rounded up to the same level of decimal places as the basic value shown in the rule or table, regardless of the numbers of significant digits of individual values required to be used in the calculation.

EXCEPTION: Rules or tables with values in millimeters are shown in units of 5 mm; as a result, resultants of calculations to be expressed in millimeters shall be rounded up to the next multiple of 5 mm.

EXAMPLES: If the basic value shown in a rule or table has no decimal places, such as 3 in, the resultant will be rounded up to the next whole number. If the basic value shown in the table or rule is shown as having one decimal place, such as 18.5 ft, the resultant of the calculation will be rounded up to one decimal place. If the table or rule contains a basic value expressed in two decimal places, such as 1.27 m, the resultant will be rounded up to two decimal places.

B. Ice and wind loading for clearances

1. Three general degrees of loading due to weather conditions are recognized and are designated as clearance zones 1, 2, and 3. Figure 230-1 shows the zones where these loadings apply.

NOTE: The localities are classified in the different zones according to the relative simultaneous prevalence of the wind velocity and thickness of ice that accumulates on wires. Zone 3 is for places where little, if any, ice accumulates on wires. See Appendix B.

2. Table 230-1 shows the radial thickness of ice to be used in calculating sags for clearance purposes. See applicable clearance rules in Section 23.

3. Ice and wind loads are specified in Rule 230B1.

- a. Where a cable is attached to a messenger, the specified loads shall be applied to both cable and messenger.
- b. In determining wind loads on a conductor or cable without ice covering, the assumed projected area shall be that of a smooth cylinder whose outside diameter is the same as that of the conductor or cable. The force coefficient (shape factor) for cylindrical surfaces is assumed to be 1.0.

NOTE: Experience has shown that as the size of multiconductor cable decreases, the actual projected area decreases, but the roughness factor increases and offsets the reduction in projected area.

- c. An appropriate mathematical model shall be used to determine the wind and weight loads on ice-coated conductors and cables. In the absence of a model developed in accordance with Rule 230B5, the following mathematical model shall be used:

- (1) On a conductor, lashed cable, or multiple-conductor cable, the coating of ice shall be considered to be a hollow cylinder touching the outer strands of the conductor or the outer circumference of the lashed cable or multiple-conductor cable.

- (2) On bundled conductors, the coating of ice shall be considered as individual hollow cylinders around each subconductor.

- d. It is recognized that the effects of conductor stranding or of non-circular cross section may result in wind and ice loadings more or less than those calculated according to assumptions stated in Rules 230B3b and 230B3c. No reduction in these loadings is permitted unless testing or a qualified engineering study justifies a reduction.

4. Table 230-2 shows the radial thickness of ice, wind pressures, temperatures, and additive constants to be used in calculating inelastic deformation.

The load components shall be determined as follows:

- a. Vertical load component

The vertical load on a wire, conductor, or messenger shall be its own weight plus the weight of conductors, spacers, or equipment that it supports, ice covered where required by Rule 230B1 and Table 230-2.

b. Horizontal load component

The horizontal load shall be the horizontal wind pressure determined under Rule 230B1 and Table 230-2, applied at right angles to the direction of the line using the projected area of the conductor or messenger and conductors, spacers, or equipment that it supports, ice covered where required by Rule 230B1 and Table 230-2.

c. Total load

The total load on each wire, conductor, or messenger shall be the resultant of components in a) and b) above, calculated at the applicable temperature in Table 230-2, plus the corresponding additive constant in Table 230-2.

5. Final sag calculations shall include the effects of inelastic deformation due to both (a) initial and subsequent combined ice and wind loading, and (b) long-term material deformation (creep). See applicable sag definitions. Ice is assumed to weigh 913 kg/m^3 (57 lb/ft^3).

C. Supply cables

For clearance purposes, supply cables, including splices and taps, conforming to any of the following requirements are permitted lesser clearances than open conductors of the same voltage. Cables should be capable of withstanding tests applied in accordance with an applicable standard.

1. Cables that are supported on or cabled together with an effectively grounded bare messenger or neutral, or with multiple concentric neutral conductors, where any associated neutral conductor(s) meet(s) the requirements of Rule 230E1 and where the cables also meet one of the following:
 - a. Cables of any voltage having an effectively grounded continuous metal sheath or shield
 - b. Cables designed to operate on a multi-grounded system at 22 kV or less and having semiconducting insulation shielding in combination with suitable metallic drainage
2. Cables of any voltage, not included in Rule 230C1, covered with a continuous auxiliary semiconducting shield in combination with suitable metallic drainage and supported on and cabled together with an effectively grounded bare messenger.
3. Insulated, nonshielded cable operated at not over 5 kV phase to phase, or 2.9 kV phase to ground, supported on and cabled together with an effectively grounded bare messenger or neutral.

D. Covered conductors

Covered conductors shall be considered bare conductors for all clearance requirements except that clearance between conductors of the same or different circuits, including grounded conductors, may be reduced below the requirements for open conductors when the conductors are owned, operated, or maintained by the same party and when the conductor covering provides sufficient dielectric strength to limit the likelihood of a short circuit in case of momentary contact between conductors or between conductors and the grounded conductor. Intermediate spacers may be used to maintain conductor clearance and to provide support.

E. Neutral conductors

1. Neutral conductors that are effectively grounded throughout their length and associated with circuits of 0 to 22 kV to ground may have the same clearances as guys and messengers.
2. All other neutral conductors of supply circuits shall have the same clearances as the phase conductors of the circuit with which they are associated.

F. Fiber-optic cable

1. Fiber-optic—supply cable
 - a. Cable defined as “fiber-optic—supply” supported on a messenger that is effectively grounded throughout its length shall have the same clearance from communications facilities as required for a neutral conductor meeting Rule 230E1.

- b. Cable defined as “fiber-optic—supply” that is entirely dielectric, or supported on a messenger that is entirely dielectric, shall have the same clearance from communications facilities as required for a neutral conductor meeting Rule 230E1.
 - c. Fiber-optic—supply cables supported on or within messengers not meeting Rule 230F1a or 230F1b shall have the same clearances from communications facilities required for such messengers.
 - d. Fiber-optic—supply cables supported on or within a conductor(s), or containing a conductor(s) or cable sheath(s) within the fiber-optic cable assembly shall have the same clearances from communications facilities required for such conductors. Such clearance shall be not less than that required under Rule 230F1a, 230F1b, or 230F1c, as applicable.
 - e. Fiber-optic—supply cables meeting Rule 224A3 are considered to be communication cables when located in the communication space.
2. Fiber-optic—communication cable
Cable defined as “fiber-optic—communication” shall have the same clearance from supply facilities as required for a communication messenger.

G. Alternating- and direct-current circuits

The rules of this section are applicable to both ac and dc circuits. For dc circuits, the clearance requirements shall be the same as those for ac circuits having the same crest voltage to ground.

NOTE: Although the corresponding crest voltage for a common sinusoidal ac circuit may be calculated by multiplying its rms value by 1.414 (square root of 2), this may not be appropriate for other type ac circuits. An example of the latter is represented by non-sinusoidal power supplies such as used in some coaxial cable type communication systems.

H. Constant-current circuits

The clearances for constant-current circuits (such as series lighting circuits) shall be determined on the basis of their normal full-load voltage.

I. Maintenance of clearances and spacings

The clearances and spacing required shall be maintained at the values and under the conditions specified in Section 23 of the applicable edition. The clearances of Section 23 are not intended to be maintained during the course of or as a result of abnormal events such as, but not limited to, actions of others or weather events in excess of those described under Section 23.

NOTE: See Rule 13 to determine the applicable edition.

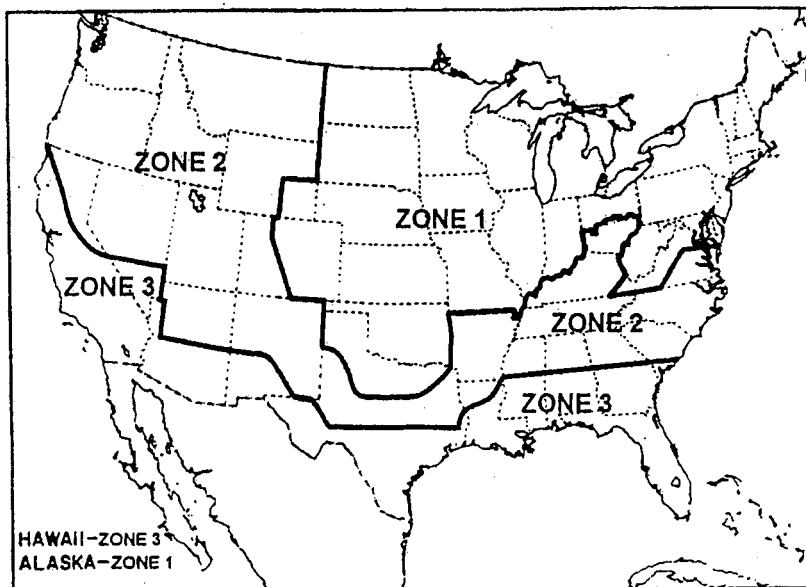

Figure 230-1—Clearance zone map of the United States

Table 230-1—Ice thickness for purposes of calculating clearances

	Clearance zone (for use with Rules 232, 233, 234, and 235)		
	Zone 1	Zone 2	Zone 3
Radial thickness of ice			
(mm)	12.5	6.5	0
(in)	0.50	0.25	0

Table 230-2—Ice, wind pressures, temperatures, and additive constants for purposes of calculating final inelastic deformation

	Clearance zone (for use with Rule 230B)		
	Zone 1	Zone 2	Zone 3
Radial thickness of ice			
(mm)	12.5	6.5	0
(in)	0.50	0.25	0
Horizontal wind pressure			
(Pa)	190	190	430
(lb/ft ²)	4	4	9
Temperature			
(°C)	-20	-10	-1
(°F)	0	+15	+30
Constant to be added to the resultant			
(N/m)	4.40	2.90	0.73
(lb/ft)	0.30	0.20	0.05

231. Clearances of supporting structures from other objects

Supporting structures, support arms, anchor guys, and equipment attached thereto, and braces shall have the following clearances from other objects. The clearance shall be measured between the nearest parts of the objects concerned.

A. From fire hydrants

Not less than 1.2 m (4 ft).

EXCEPTION 1: Where conditions do not permit, a clearance of not less than 900 mm (3 ft) is allowed.

EXCEPTION 2: Clearances in Rule 231A may be reduced by agreement with the local fire authority and the pole owner.

B. From streets, roads, and highways

1. Where there are curbs: supporting structures, support arms, anchor guys, or equipment attached thereto, up to 4.6 m (15 ft) above the road surface shall be located a sufficient distance from the street side of the curbs to avoid contact by ordinary vehicles using and located on the traveled way. For a redirection curb, such distance shall be not less than 150 mm (6 in). For paved or concrete swale-type curbs, such facilities shall be located behind the curb.
2. Where there are no curbs, supporting structures should be located a sufficient distance from the roadway to avoid contact by ordinary vehicles using and located on the traveled way.
3. Location of overhead utility installations on roads, streets, or highways with narrow rights-of-way or closely abutting improvements are special cases that must be resolved in a manner consistent with the prevailing limitations and conditions.
4. Where a governmental authority exercising jurisdiction over structure location has issued a permit for, or otherwise approved, specific locations for supporting structures, that permit or approval shall govern.

C. From railroad tracks

Where railroad tracks are parallel to or crossed by overhead lines, all portions of the supporting structures, support arms, anchor guys, and equipment attached thereto less than 6.7 m (22 ft) above the nearest track rail shall have horizontal clearances not less than the values required by Rule 231C1 or 231C2 for the situation concerned.

NOTE: See Rule 234I.

1. Not less than 3.6 m (12 ft) from the nearest track rail.

EXCEPTION 1: A clearance of not less than 2.13 m (7 ft) may be allowed where the supporting structure is not the controlling obstruction, provided sufficient space for a driveway is left where cars are loaded or unloaded.

EXCEPTION 2: Supports for overhead trolley-contact conductors may be located as near their own track rail as conditions require. If very close, however, permanent screens on cars will be necessary to protect passengers.

EXCEPTION 3: Where necessary to provide safe operating conditions that require an uninterrupted view of signals, signs, etc., along tracks, the parties concerned shall cooperate in locating structures to provide the necessary clearance.

EXCEPTION 4: At industrial sidings, a clearance of not less than 2.13 m (7 ft) shall be permitted, provided sufficient space is left where cars can be loaded or unloaded.

2. The clearances of Rule 231C1 may be reduced by agreement with the railroad(s).

232. Vertical clearances of wires, conductors, cables, and equipment above ground, roadway, rail, or water surfaces

A. Application

The vertical clearances specified in Rule 232B1 apply under the following conductor temperature and loading conditions, whichever produces the largest final sag:

1. 50 °C (120 °F), no wind displacement
2. The maximum conductor temperature for which the line is designed to operate, if greater than 50 °C (120 °F), with no wind displacement
3. 0 °C (32 °F), no wind displacement, with radial thickness of ice, if any, specified in Table 230-1 for the zone concerned

EXCEPTION: The conductor temperature and loading condition for trolley and electrified railroad contact conductors shall be 15 °C (60 °F), no wind displacement, final unloaded sag, or initial unloaded sag in cases where these facilities are maintained approximately at initial unloaded sags.

NOTE: The phase and neutral conductors of a supply line are normally considered separately when determining the sag of each due to temperature rise.

- B. Clearance of wires, conductors, cables, equipment, and support arms mounted on supporting structures
1. Clearance to wires, conductors, and cables

The vertical clearance of wires, conductors, and cables aboveground in generally accessible places, roadway, rail, or water surfaces, shall be not less than that shown in Table 232-1.
 2. Clearance to unguarded rigid live parts of equipment

The vertical clearance above ground, roadway, or water surfaces for unguarded rigid live parts such as potheads, transformer bushings, surge arresters, and short lengths of supply conductors connected thereto, which are not subject to variation in sag, shall be not less than that shown in Table 232-2. For clearances of drip loops of service drops, see Table 232-1.
 3. Clearance to support arms, switch handles, and equipment cases

The vertical clearance of switch handles, equipment cases, support arms, platforms, and braces that extend beyond the surface of the structure shall be not less than that shown in Table 232-2. These clearances do not apply to internal structural braces for latticed towers, X-braces between poles, and pole-type push braces.
 4. Street and area lighting
 - a. The vertical clearance of street and area lighting luminaires shall be not less than that shown in Table 232-2. For this purpose, grounded luminaire cases and brackets shall be considered as effectively grounded equipment cases; ungrounded luminaire cases and brackets shall be considered as a rigid live part of the voltage contained.

EXCEPTION: This rule does not apply to post-top mounted luminaires with grounded or entirely dielectric cases.
 - b. Insulators, as specified in Rule 279A, should be inserted at least 2.45 m (8 ft) from the ground in metallic suspension ropes or chains supporting lighting units of series circuits.
- C. Additional clearances for wires, conductors, cables, and unguarded rigid live parts of equipment
Greater clearances than specified by Rule 232B shall be provided where required by Rule 232C1.
1. Voltages exceeding 22 kV
 - a. For voltages between 22 and 470 kV, the clearance specified in Rule 232B1 (Table 232-1) or Rule 232B2 (Table 232-2) shall be increased at the rate of 10 mm (0.4 in) per kilovolt in excess of 22 kV. For voltages exceeding 470 kV, the clearance shall be determined by the method given in Rule 232D. All clearances for lines over 50 kV shall be based on the maximum operating voltage.

EXCEPTION: For voltages exceeding 98 kV ac to ground or 139 kV dc to ground, clearances less than those required above are permitted for systems with known maximum switching-surge factors (see Rule 232D).
 - b. For voltages exceeding 50 kV, the additional clearance specified in Rule 232C1a shall be increased 3% for each 300 m (1000 ft) in excess of 1000 m (3300 ft) above mean sea level.
 - c. For voltages exceeding 98 kV ac to ground, either the clearances shall be increased or the electric field, or the effects thereof, shall be reduced by other means as required to limit the steady-state current due to electrostatic effects to 5 mA rms if the largest anticipated truck, vehicle, or equipment under the line were short-circuited to ground. The size of the anticipated truck, vehicle, or equipment used to determine these clearances may be less than but need not be greater than that limited by federal, state, or local regulations governing the area under the line. For this determination, the conductors shall be at a final unloaded sag at 50 °C (120 °F).

D. Alternate clearances for voltages exceeding 98 kV ac to ground or 139 kV dc to ground

The clearances specified in Rules 232B and 232C may be reduced for circuits with known switching-surge factors, but shall be not less than the alternate clearance, which is computed by adding the reference height from Rule 232D2 to the electrical component of clearance from Rule 232D3.

1. Sag conditions of line conductors

The vertical clearance shall be maintained under the conductor temperature and loading condition given in Rule 232A.

2. Reference heights

The reference height shall be selected from Table 232-3.

3. Electrical component of clearance

- a. The electrical component (D) shall be computed using the following equations. Selected values of D are listed in Table 232-4.

$$D = 1.00 \left[\frac{V \cdot (PU) \cdot a}{500K} \right]^{1.667} bc \quad (\text{m})$$

$$D = 3.28 \left[\frac{V \cdot (PU) \cdot a}{500K} \right]^{1.667} bc \quad (\text{ft})$$

where

V = maximum ac crest operating voltage to ground or maximum dc operating voltage to ground in kilovolts

PU = maximum switching-surge factor expressed in per-unit peak voltage to ground and defined as a switching-surge level for circuit breakers corresponding to 98% probability that the maximum switching surge generated per breaker operation does not exceed this surge level, or the maximum anticipated switching-surge level generated by other means, whichever is greater

a = 1.15, the allowance for three standard deviations

b = 1.03, the allowance for nonstandard atmospheric conditions

c = 1.2, the margin of safety

K = 1.15, the configuration factor for conductor-to-plane gap

- b. The value of D shall be increased 3% for each 300 m (1000 ft) in excess of 450 m (1500 ft) above mean sea level.
- c. For voltages exceeding 98 kV ac to ground, either the clearances shall be increased or the electric field, or the effects thereof, shall be reduced by other means as required to limit the steady state current due to electrostatic effects to 5 mA, rms, if the largest anticipated truck, vehicle, or equipment under the line were short-circuited to ground. The size of the anticipated truck, vehicle, or equipment used to determine these clearances may be less than but need not be greater than that limited by federal, state, or local regulations governing the area under the line. For this determination, the conductors shall be at a final unloaded sag at 50 °C (120 °F).

4. Limit

The alternate clearance shall be not less than the clearance given in Table 232-1 or 232-2 computed for 98 kV ac to ground in accordance with Rule 232C.

m

**Table 232-1—
Vertical clearance of wires, conductors, and cables above ground,
roadway, rail, or water surfaces[Ⓢ]**

(Voltages are phase to ground for effectively grounded circuits and those other circuits where all ground faults are cleared by promptly de-energizing the faulted section, both initially and following subsequent breaker operations. See the definitions section for voltages of other systems.

See Rules 232B1, 232C1a, and 232D4.)

Nature of surface underneath wires, conductors, or cables	Insulated communication conductors and cable; messengers; overhead shield/surge-protection wires; grounded guys; ungrounded guys exposed to 0 to 300 V [Ⓢ] ; neutral conductors meeting Rule 230E1; supply cables meeting Rule 230C1 (m)	Noninsulated communication conductors; supply cables of 0 to 750 V meeting Rule 230C2 or 230C3 (m)	Supply cables over 750 V meeting Rule 230C2 or 230C3; open supply conductors, 0 to 750 V [Ⓢ] ; ungrounded guys exposed to over 300 V to 750 V [Ⓢ] (m)	Open supply conductors, over 750 V to 22 kV; ungrounded guys exposed to 750 V to 22 kV [Ⓢ] (m)	Trolley and electrified railroad contact conductors and associated span or	
					0 to 750 V to ground (m)	Over 750 V to 22 kV to ground (m)
Where wires, conductors, or cables cross over or overhang						
1. Track rails of railroads (except electrified railroads using overhead trolley conductors) [Ⓢ] Ⓢ Ⓢ	7.2	7.3	7.5	8.1	6.7 [Ⓢ]	6.7 [Ⓢ]
2. Roads, streets, and other areas subject to truck traffic [Ⓢ]	4.7	4.9	5.0	5.6	5.5 [Ⓢ]	6.1 [Ⓢ]
3. Driveways, parking lots, and alleys [Ⓢ]	4.7 [Ⓢ]	4.9 [Ⓢ]	5.0 [Ⓢ]	5.6	5.5 [Ⓢ]	6.1 [Ⓢ]
4. Other land traversed by vehicles, such as cultivated, grazing, forest, orchard, etc. [Ⓢ]	4.7	4.9	5.0	5.6	—	—
5. Spaces and ways subject to pedestrians or restricted traffic only [Ⓢ]	2.9	3.6 [Ⓢ]	3.8 [Ⓢ]	4.4	4.9	5.5
6. Water areas not suitable for sailboating or where sailboating is prohibited [Ⓢ]	4.0	4.4	4.6	5.2	—	—
7. Water areas suitable for sailboating including lakes, ponds, reservoirs, tidal waters, rivers, streams, and canals with an unobstructed surface area of [Ⓢ] Ⓢ Ⓢ Ⓢ						
a. Less than 0.08 km ²	5.3	5.5	5.6	6.2	—	—

m

Table 232-1— (continued)
**Vertical clearance of wires, conductors, and cables above ground,
roadway, rail, or water surfaces[Ⓢ]**

(Voltages are phase to ground for effectively grounded circuits and those other circuits where all ground faults are cleared by promptly de-energizing the faulted section, both initially and following subsequent breaker operations. See the definitions section for voltages of other systems.

See Rules 232B1, 232C1a, and 232D4.)

Nature of surface underneath wires, conductors, or cables	Insulated communication conductors and cable; messengers; overhead shield/surge-protection wires; grounded guys; ungrounded guys exposed to 0 to 300 V [Ⓢ] ; neutral conductors meeting Rule 230E1; supply cables meeting Rule 230C1 (m)	Noninsulated communication conductors; supply cables of 0 to 750 V meeting Rule 230C2 or 230C3 (m)	Supply cables over 750 V meeting Rule 230C2 or 230C3; open supply conductors, 0 to 750 V [Ⓢ] ; ungrounded guys exposed to over 300 V [Ⓢ] to 750 V [Ⓢ] (m)	Open supply conductors, over 750 V to 22 kV; ungrounded guys exposed to 750 V to 22 kV [Ⓢ] (m)	Trolley and electrified railroad contact conductors and associated span or	
					0 to 750 V to ground (m)	Over 750 V to 22 kV to ground (m)
b. Over 0.08 to 0.8 km ²	7.8	7.9	8.1	8.7	—	—
c. Over 0.8 to 8 km ²	9.6	9.8	9.9	10.5	—	—
d. Over 8 km ²	11.4	11.6	11.7	12.3	—	—
8. Established boat ramps and associated rigging areas; areas posted with sign(s) for rigging or launching sail boats	Clearance aboveground shall be 1.5 m greater than in 7 above, for the type of water areas served by the launching sites					
Where wires, conductors, or cables run along and within the limits of highways or other road rights-of-way but do not overhang the roadway						
9. Roads, streets, or alleys	4.7 [Ⓢ]	4.9	5.0	5.6	5.5 [Ⓢ]	6.1 [Ⓢ]
10. Roads where it is unlikely that vehicles will be crossing under the line	4.1 [Ⓢ]	4.3 [Ⓢ]	4.4 [Ⓢ]	5.0	5.5 [Ⓢ]	6.1 [Ⓢ]

[Ⓢ]Where subways, tunnels, or bridges require it, less clearance above ground or rails than required by Table 232-1 may be used locally. The trolley and electrified railroad contact conductor should be graded very gradually from the regular construction down to the reduced elevation.

[Ⓣ]For wires, conductors, or cables crossing over mine, logging, and similar railways that handle only cars lower than standard freight cars, the clearance may be reduced by an amount equal to the difference in height between the highest loaded car handled and 6.1 m, but the clearance shall not be reduced below that required for street crossings.

[Ⓤ]Does not include neutral conductors meeting Rule 230E1.

[Ⓦ]In communities where 6.4 m has been established, this clearance may be continued if carefully maintained. The elevation of the contact conductor should be the same in the crossing and next adjacent spans. (See Rule 225D2 for conditions that must be met where uniform height above rail is impractical.)

[Ⓧ]In communities where 4.9 m has been established for trolley and electrified railroad contact conductors 0 to 750 V to ground, or 5.5 m for trolley and electrified railroad contact conductors exceeding 750 V, or where local conditions make it impractical to obtain in the clearance given in the table, these reduced clearances may be used if carefully maintained.

[Ⓨ]This footnote not used in this edition.

- ⑦ Where the height of a residential building does not permit its service drop(s) to meet these values, the clearances over residential driveways only may be reduced to the following:
- | | |
|---|-----|
| | (m) |
| (a) Insulated supply service drops limited to 300 V to ground | 3.8 |
| (b) Insulated drip loops of supply service drops limited to 300 V to ground | 3.2 |
| (c) Supply service drops limited to 150 V to ground and meeting Rule 230C1 or 230C3 | 3.6 |
| (d) Drip loops only of service drops limited to 150 V to ground and meeting Rule 230C1 or 230C3 | 3.0 |
| (e) Insulated communication service drops | 3.5 |
- ⑧ Where the height of a residential building does not permit its service drop(s) to meet these values, the clearances may be reduced to the following:
- | | |
|--|-----|
| | (m) |
| (a) Insulated supply service drops limited to 300 V to ground | 3.2 |
| (b) Insulated drip loops of supply service drops limited to 300 V to ground | 3.2 |
| (c) Supply service drops limited to 150 V to ground and meeting Rule 230C1 or 230C3 | 3.0 |
| (d) Drip loops only of supply service drops limited to 150 V to ground and meeting Rule 230C1 or 230C3 | 3.0 |
- ⑨ Spaces and ways subject to pedestrians or restricted traffic only are those areas where riders on horses or other large animals, vehicles, or other mobile units exceeding a total height of 2.45 m, are prohibited by regulation or permanent terrain configurations, or are otherwise not normally encountered nor reasonably anticipated.
- ⑩ Where a supply or communication line along a road is located relative to fences, ditches, embankments, etc., so that the ground under the line would not be expected to be traveled except by pedestrians, the clearances may be reduced to the following values:
- | | |
|--|-----|
| | (m) |
| (a) Insulated communication conductor and communication cables | 2.9 |
| (b) Conductors of other communication circuits | 2.9 |
| (c) Supply cables of any voltage meeting Rule 230C1, supply cables limited to 150 V to ground meeting Rule 230C2 or 230C3, and neutral conductors meeting Rule 230E1 | 2.9 |
| (d) Insulated supply conductors limited to 300 V to ground | 3.8 |
| (e) Guys | 2.9 |
- ⑪ No clearance from ground is required for anchor guys not crossing tracks, rails, streets, driveways, roads, or pathways.
- ⑫ This clearance may be reduced to 4.0 m for communication conductors and guys.
- ⑬ Where this construction crosses over or runs along alleys, driveways, or parking lots not subject to truck traffic this clearance may be reduced to 4.6 m.
- ⑭ Ungrounded guys and ungrounded portions of span guys between guy insulators shall have clearances based on the highest voltage to which they may be exposed due to a slack conductor or guy.
- ⑮ Anchor guys insulated in accordance with Rule 279 may have the same clearance as grounded guys.
- ⑯ Adjacent to tunnels and overhead bridges that restrict the height of loaded rail cars to less than 6.1 m, these clearances may be reduced by the difference between the highest loaded rail car handled and 6.1 m, if mutually agreed to by the parties at interest.
- ⑰ For controlled impoundments, the surface area and corresponding clearances shall be based upon the design high-water level.
- ⑱ For uncontrolled water flow areas, the surface area shall be that enclosed by its annual high-water mark. Clearances shall be based on the normal flood level; if available, the 10-year flood level may be assumed as the normal flood level.
- ⑲ The clearance over rivers, streams, and canals shall be based upon the largest surface area of any 1.6 km-long segment that includes the crossing. The clearance over a canal, river, or stream normally used to provide access for sailboats to a larger body of water shall be the same as that required for the larger body of water.
- ⑳ Where an overwater obstruction restricts vessel height to less than the applicable reference height given in Table 232-3, the required clearance may be reduced by the difference between the reference height and the overwater obstruction height, except that the reduced clearance shall be not less than that required for the surface area on the line-crossing side of the obstruction.
- ㉑ Where the US Army Corps of Engineers, or the state, or surrogate thereof has issued a crossing permit, clearances of that permit shall govern.
- ㉒ See Rule 234I for the required horizontal and diagonal clearances to rail cars.
- ㉓ For the purpose of this rule, trucks are defined as any vehicle exceeding 2.45 m in height. Areas not subject to truck traffic are areas where truck traffic is not normally encountered nor reasonably anticipated.
- ㉔ Communication cables and conductors may have a clearance of 4.6 m where poles are back of curbs or other deterrents to vehicular traffic.
- ㉕ The clearance values shown in this table are computed by adding the applicable Mechanical and Electrical (M & E) value of Table A-1 to the applicable Reference Component of Table A-2a of Appendix A.
- ㉖ When designing a line to accommodate oversized vehicles, these clearance values shall be increased by the difference between the known height of the oversized vehicle and 4.3 m.

ft

**Table 232-1—
Vertical clearance of wires, conductors, and cables above ground,
roadway, rail, or water surfaces[Ⓢ]**

(Voltages are phase to ground for effectively grounded circuits and those other circuits where all ground faults are cleared by promptly de-energizing the faulted section, both initially and following subsequent breaker operations. See the definitions section for voltages of other systems.

See Rules 232B1, 232C1a, and 232D4.)

Nature of surface underneath wires, conductors, or cables	Insulated communication conductors and cable; messengers; overhead shield/surge-protection wires; grounded guys; ungrounded guys exposed to 0 to 300 V ^{①⑤} ; neutral conductors meeting Rule 230E1; supply cables meeting Rule 230C1 (ft)	Noninsulated communication conductors; supply cables of 0 to 750 V meeting Rule 230C2 or 230C3 (ft)	Supply cables over 750 V meeting Rule 230C2 or 230C3; open supply conductors, 0 to 750 V ^③ ; ungrounded guys exposed to over 300 V to 750 V ^④ (ft)	Open supply conductors, over 750 V to 22 kV; ungrounded guys exposed to 750 V to 22 kV ^④ (ft)	Trolley and electrified railroad contact conductors and associated span or messenger wires	
					0 to 750 V to ground (ft)	Over 750 V to 22 kV to ground (ft)
Where wires, conductors, or cables cross over or overhang						
1. Track rails of railroads (except electrified railroads using overhead trolley conductors) ^{①⑥②}	23.5	24.0	24.5	26.5	22.0 ^①	22.0 ^①
2. Roads, streets, and other areas subject to truck traffic ^③	15.5	16.0	16.5	18.5	18.0 ^③	20.0 ^③
3. Driveways, parking lots, and alleys ^{⑦⑧}	15.5 ^{⑦⑧}	16.0 ^{⑦⑧}	16.5 ^⑦	18.5	18.0 ^③	20.0 ^③
4. Other land traversed by vehicles, such as cultivated, grazing, forest, orchards, etc.	15.5	16.0	16.5	18.5	—	—
5. Spaces and ways subject to pedestrians or restricted traffic only ^①	9.5	12.0 ^①	12.5 ^①	14.5	16.0	18.0
6. Water areas not suitable for sailboating or where sailboating is prohibited ^④	14.0	14.5	15.0	17.0	—	—
7. Water areas suitable for sailboating including lakes, ponds, reservoirs, tidal waters, rivers, streams, and canals with an unobstructed surface area of ^{⑦⑧⑨⑩⑪}						

ft

Table 232-1— (continued)
**Vertical clearance of wires, conductors, and cables above ground,
roadway, rail, or water surfaces[Ⓢ]**

(Voltages are phase to ground for effectively grounded circuits and those other circuits where all ground faults are cleared by promptly de-energizing the faulted section, both initially and following subsequent breaker operations. See the definitions section for voltages of other systems.

See Rules 232B1, 232C1a, and 232D4.)

Nature of surface underneath wires, conductors, or cables	Insulated communication conductors and cable; messengers; overhead shield/surge-protection wires; grounded guys; ungrounded guys exposed to 0 to 300 V [Ⓢ] ; neutral conductors meeting Rule 230E1; supply cables meeting Rule 230C1 (ft)	Noninsulated communication conductors; supply cables of 0 to 750 V meeting Rule 230C2 or 230C3 (ft)	Supply cables over 750 V meeting Rule 230C2 or 230C3; open supply conductors, 0 to 750 V [Ⓢ] ; ungrounded guys exposed to over 300 V to 750 V [Ⓢ] (ft)	Open supply conductors, over 750 V to 22 kV; ungrounded guys exposed to 750 V to 22 kV [Ⓢ] (ft)	Trolley and electrified railroad contact conductors and associated span or messenger wires	
					0 to 750 V to ground (ft)	Over 750 V to 22 kV to ground (ft)
a. Less than 20 acres	17.5	18.0	18.5	20.5	—	—
b. Over 20 to 200 acres	25.5	26.0	26.5	28.5	—	—
c. Over 200 to 2000 acres	31.5	32.0	32.5	34.5	—	—
d. Over 2000 acres	37.5	38.0	38.5	40.5	—	—
8. Established boat ramps and associated rigging areas; areas posted with sign(s) for rigging or launching sail boats	Clearance aboveground shall be 5 ft greater than in 7 above, for the type of water areas served by the launching site					
Where wires, conductors, or cables run along and within the limits of highways or other road rights-of-way but do not overhang the roadway						
9. Roads, streets, or alleys	15.5 [Ⓢ]	16.0	16.5	18.5	18.0 [Ⓢ]	20.0 [Ⓢ]
10. Roads where it is unlikely that vehicles will be crossing under the line	13.5 [Ⓢ] [Ⓢ]	14.0 [Ⓢ]	14.5 [Ⓢ]	16.5	18.0 [Ⓢ]	20.0 [Ⓢ]

Ⓢ Where subways, tunnels, or bridges require it, less clearance above ground or rails than required by Table 232-1 may be used locally. The trolley and electrified railroad contact conductor should be graded very gradually from the regular construction down to the reduced elevation.

Ⓢ For wires, conductors, or cables crossing over mine, logging, and similar railways that handle only cars lower than standard freight cars, the clearance may be reduced by an amount equal to the difference in height between the highest loaded car handled and 20 ft, but the clearance shall not be reduced below that required for street crossings.

Ⓢ Does not include neutral conductors meeting Rule 230E1.

Ⓢ In communities where 21 ft has been established, this clearance may be continued if carefully maintained. The elevation of the contact conductor should be the same in the crossing and next adjacent spans. (See Rule 225D2 for conditions that must be met where uniform height above rail is impractical.)

Ⓢ In communities where 16 ft has been established for trolley and electrified railroad contact conductors 0 to 750 V to ground, or 18 ft for trolley and electrified railroad contact conductors exceeding 750 V, or where local conditions make it impractical to obtain the clearance given in the table, these reduced clearances may be used if carefully maintained.

Ⓢ This footnote not used in this edition.

① Where the height of a residential building does not permit its service drop(s) to meet these values, the clearances over residential driveways only may be reduced to the following:

	(ft)
(a) Insulated supply service drops limited to 300 V to ground	12.5
(b) Insulated drip loops of supply service drops limited to 300 V to ground	10.5
(c) Supply service drops limited to 150 V to ground and meeting Rule 230C1 or 230C3	12.0
(d) Drip loops only of service drops limited to 150 V to ground and meeting Rule 230C1 or 230C3	10.0
(e) Insulated communication service drops	11.5

① Where the height of a residential building does not permit its service drop(s) to meet these values, the clearances may be reduced to the following:

	(ft)
(a) Insulated supply service drops limited to 300 V to ground	10.5
(b) Insulated drip loops of supply service drops limited to 300 V to ground	10.5
(c) Supply service drops limited to 150 V to ground and meeting Rule 230C1 or 230C3	10.0
(d) Drip loops only of supply service drops limited to 150 V to ground and meeting Rule 230C1 or 230C3	10.0

① Spaces and ways subject to pedestrians or restricted traffic only are those areas where riders on horses or other large animals, vehicles, or other mobile units exceeding a total height of 8 ft are prohibited by regulation or permanent terrain configurations, or are otherwise not normally encountered nor reasonably anticipated.

① Where a supply or communication line along a road is located relative to fences, ditches, embankments, etc., so that the ground under the line would not be expected to be traveled except by pedestrians, the clearances may be reduced to the following values:

	(ft)
(a) Insulated communication conductor and communication cables.	9.5
(b) Conductors of other communication circuits	9.5
(c) Supply cables of any voltage meeting Rule 230C1, supply cables limited to 150 V to ground meeting Rule 230C2 or 230C3, and neutral conductors meeting Rule 230E1	9.5
(d) Insulated supply conductors limited to 300 V to ground	12.5
(e) Guys	9.5

① No clearance from ground is required for anchor guys not crossing tracks, rails, streets, driveways, roads, or pathways.

② This clearance may be reduced to 13 ft for communication conductors and guys.

① Where this construction crosses over or runs along alleys, driveways, or parking lots not subject to truck traffic this clearance may be reduced to 15 ft.

① Ungrounded guys and ungrounded portions of span guys between guy insulators shall have clearances based on the highest voltage to which they may be exposed due to a slack conductor or guy.

① Anchor guys insulated in accordance with Rule 279 may have the same clearance as grounded guys.

① Adjacent to tunnels and overhead bridges that restrict the height of loaded rail cars to less than 20 ft, these clearances may be reduced by the difference between the highest loaded rail car handled and 20 ft, if mutually agreed to by the parties at interest.

① For controlled impoundments, the surface area and corresponding clearances shall be based upon the design high-water level.

① For uncontrolled water flow areas, the surface area shall be that enclosed by its annual high-water mark. Clearances shall be based on the normal flood level; if available, the 10-year flood level may be assumed as the normal flood level.

① The clearance over rivers, streams, and canals shall be based upon the largest surface area of any 1-mi-long segment that includes the crossing. The clearance over a canal, river, or stream normally used to provide access for sailboats to a larger body of water shall be the same as that required for the larger body of water.

① Where an overwater obstruction restricts vessel height to less than the applicable reference height given in Table 232-3, the required clearance may be reduced by the difference between the reference height and the overwater obstruction height, except that the reduced clearance shall be not less than that required for the surface area on the line-crossing side of the obstruction.

① Where the US Army Corps of Engineers, or the state, or surrogate thereof has issued a crossing permit, clearances of that permit shall govern.

② See Rule 234I for the required horizontal and diagonal clearances to rail cars.

② For the purpose of this rule, trucks are defined as any vehicle exceeding 8 ft in height. Areas not subject to truck traffic are areas where truck traffic is not normally encountered nor reasonably anticipated.

② Communication cables and conductors may have a clearance of 15 ft where poles are back of curbs or other deterrents to vehicular traffic.

② The clearance values shown in this table are computed by adding the applicable Mechanical and Electrical (M & E) value of Table A-1 to the applicable Reference Component of Table A-2a of Appendix A.

② When designing a line to accommodate oversized vehicles, these clearance values shall be increased by the difference between the known height of the oversized vehicle and 14 ft.

m

Table 232-2—

Vertical clearance of equipment cases, support arms, platforms, braces and unguarded rigid live parts above ground, roadway, or water surfaces ^①

(Voltages are phase to ground for effectively grounded circuits and those other circuits where all ground faults are cleared by promptly de-energizing the faulted section, both initially and following subsequent breaker operations. See the definitions section for voltages of other systems.

See Rules 232B2, 232B3, 232C1a, and 232D4.)

Nature of surface below	Nonmetallic or effectively grounded support arms, switch handles, platforms, braces, and equipment cases (m)	Unguarded rigid live parts of 0 to 750 V and ungrounded cases that contain equipment connected to circuits of not more than 750 V (m)	Unguarded rigid live parts of over 750 V to 22 kV and ungrounded cases that contain equipment connected to circuits of over 750 V to 22 kV (m)
1. Where rigid parts overhang			
a. Roads, streets, and other areas subject to truck traffic ^④	4.6	4.9	5.5
b. Driveways, parking lots, and alleys	4.6	4.9 ^⑥	5.5
c. Other land traversed by vehicles such as cultivated land, grazing land, forest, orchard, etc.	4.6 ^⑦	4.9	5.5
d. Spaces and ways subject to pedestrians or restricted traffic only ^⑤	3.4 ^⑦	3.6 ^①	4.3
2. Where rigid parts are along and within the limits of highways or other road rights-of-way but do not overhang the roadway			
a. Roads, streets, and alleys	4.6 ^⑦	4.9	5.5
b. Roads where it is unlikely that vehicles will be crossing under the line	4.0 ^⑦	4.3 ^②	4.9
3. Water areas not suitable for sailboating or where sailboating is prohibited ^①	4.3	4.4	4.6

^①For insulated live parts limited to 150 V to ground, this value may be reduced to 3.0 m.

^②Where a supply line along a road is limited to 300 V to ground and is located relative to fences, ditches, embankments, etc., so that the ground under the line would not be expected to be traveled except by pedestrians, this clearance may be reduced to 3.6 m.

^③This footnote not used in this edition.

^④For the purpose of this rule, trucks are defined as any vehicle exceeding 2.45 m in height. Areas not subject to truck traffic are areas where truck traffic is not normally encountered nor reasonably anticipated.

^⑤Spaces and ways subject to pedestrians or restricted traffic only are those areas where riders on horseback or other large animals, vehicles, or other mobile units exceeding 2.45 m in height, are prohibited by regulation or permanent terrain configurations or are otherwise not normally encountered nor reasonably anticipated.

⑥ This clearance may be reduced to the following values for driveways, parking lots, and alleys not subject to truck traffic:

- | | |
|---|------------|
| (a) Insulated live parts limited to 300 V to ground | (m)
3.6 |
| (b) Insulated live parts limited to 150 V to ground | 3.0 |

⑦ Effectively grounded switch handles and supply or communication equipment cases (such as fire alarm boxes, control boxes, communication terminals, meters or similar equipment cases) may be mounted at a lower level for accessibility, provided such cases do not unduly obstruct a walkway.

NOTE: See also Rule 234J2c.

⑧ The clearance values shown in this table are computed by adding the applicable Mechanical and Electrical (M & E) value of Table A-1 to the applicable Reference Component of Table A-2a of Appendix A.

⑨ Where the US Army Corps of Engineers, or the state, or surrogate thereof has issued a crossing permit, clearances of that permit shall govern.

ft

Table 232-2—

Vertical clearance of equipment cases, support arms, platforms, braces and unguarded rigid live parts above ground, roadway, or water surfaces

(Voltages are phase to ground for effectively grounded circuits and those other circuits where all ground faults are cleared by promptly de-energizing the faulted section, both initially and following subsequent breaker operations. See the definitions section for voltages of other systems.)

See Rules 232B2, 232B3, 232C1a, and 232D4.)

Nature of surface below	Nonmetallic or effectively grounded support arms, switch handles, platforms, braces, and equipment cases (ft)	Unguarded rigid live parts of 0 to 750 V and ungrounded cases that contain equipment connected to circuits of not more than 750 V (ft)	Unguarded rigid live parts of over 750 V to 22 kV and ungrounded cases that contain equipment connected to circuits of over 750 V to 22 kV (ft)
1. Where rigid parts overhang			
a. Roads, streets, and other areas subject to truck traffic ⑥	15.0	16.0	18.0
b. Driveways, parking lots, and alleys	15.0	16.0 ⑦	18.0
c. Other land traversed by vehicles such as cultivated land, grazing land, forest, orchard, etc.	15.0 ⑦	16.0	18.0
d. Spaces and ways subject to pedestrians or restricted traffic only ⑥	11.0 ⑦	12.0 ⑦	14.0
2. Where rigid parts are along and within the limits of highways or other road rights-of-way but do not overhang the roadway			
a. Roads, streets, and alleys	15.0 ⑦	16.0	18.0
b. Roads where it is unlikely that vehicles will be crossing under the line	13.0 ⑦	14.0 ⑦	16.0
3. Water areas not suitable for sailboating or where sailboating is prohibited ⑥	14.0	14.5	15.0

- ①For insulated live parts limited to 150 V to ground, this value may be reduced to 10 ft.
- ②Where a supply line along a road is limited to 300 V to ground and is located relative to fences, ditches, embankments, etc., so that the ground under the line would not be expected to be traveled except by pedestrians, this clearance may be reduced to 12 ft.
- ③This footnote not used in this edition.
- ④For the purpose of this rule, trucks are defined as any vehicle exceeding 8 ft in height. Areas not subject to truck traffic are areas where truck traffic is not normally encountered nor reasonably anticipated.
- ⑤Spaces and ways subject to pedestrians or restricted traffic only are those areas where riders on horseback or other large animals, vehicles, or other mobile units exceeding 8 ft in height, are prohibited by regulation or permanent terrain configurations or are otherwise not normally encountered nor reasonably anticipated.
- ⑥This clearance may be reduced to the following values for driveways, parking lots, and alleys not subject to truck traffic:

(a) Insulated live parts limited to 300 V to ground	(ft)
(b) Insulated live parts limited to 150 V to ground	12
	10
- ⑦Effectively grounded switch handles and supply or communication equipment cases (such as fire alarm boxes, control boxes, communication terminals, meters, or similar equipment cases) may be mounted at a lower level for accessibility, provided such cases do not unduly obstruct a walkway.
NOTE: See also Rule 234J2c.
- ⑧The clearance values shown in this table are computed by adding the applicable Mechanical and Electrical (M & E) value of Table A-1 to the applicable Reference Component of Table A-2a of Appendix A.
- ⑨Where the US Army Corps of Engineers, or the state, or surrogate thereof has issued a crossing permit, clearances of that permit shall govern.

Table 232-3—Reference heights
(See Rule 232D2.)

Nature of surface underneath lines	(m)	(ft)
a. Track rails of railroads (except electrified railroads using overhead trolley conductors) ①	6.7	22
b. Streets, alleys, roads, driveways, and parking lots	4.3	14
c. Spaces and ways subject to pedestrians or restricted traffic only ②	3.0	10
d. Other land, such as cultivated, grazing, forest, or orchard, that is traversed by vehicles	4.3	14
e. Water areas not suitable for sailboating or where sailboating is prohibited	3.8	12.5
f. Water areas suitable for sailboating including lakes, ponds, reservoirs, tidal waters, rivers, streams, and canals with unobstructed surface area ③ ④		
(1) Less than 0.08 km ² (20 acres)	4.9	16
(2) Over 0.08 to 0.8 km ² (20 to 200 acres)	7.3	24
(3) Over 0.8 to 8 km ² (200 to 2000 acres)	9.0	30
(4) Over 8 km ² (2000 acres)	11.0	36
g. In public or private land and water areas posted for rigging or launching sailboats, the reference height shall be 1.5 m (5 ft) greater than in f above, for the type of water areas serviced by the launching site		

- ①See Rule 234I for the required horizontal and diagonal clearances to rail cars.
- ②Spaces and ways subject to pedestrians or restricted traffic only are those areas where riders on horseback or other large animals, vehicles, or other mobile units exceeding 2.45 m (8 ft) in height, are prohibited by regulation or permanent terrain configurations or are otherwise not normally encountered nor reasonably anticipated.
- ③For controlled impoundments, the surface area and corresponding clearances shall be based upon the design high-water level. For other waters, the surface area shall be that enclosed by its annual high-water mark, and clearances shall be based on the normal flood level. The clearances over rivers, streams, and canals shall be based upon the largest surface area of any 1600 m (1 mi) long segment that includes the crossing. The clearance over a canal or

similar waterway providing access for sailboats to a larger body of water shall be the same as that required for the larger body of water.

- ④ Where an overwater obstruction restricts vessel height to less than the applicable reference height, the required clearance may be reduced by the difference between the reference height and the overwater obstruction height, except that the reduced clearance shall not be less than that required for the surface area on the line-crossing side of the obstruction.

Table 232-4—Electrical component of clearance in Rule 232D3a
 [Add 3% for each 300 m (1000 ft) in excess of 450 m (1500 ft) above mean sea level.
 Increase clearance to limit electrostatic effects in accordance with Rule 232D3c.]

Maximum operating voltage phase to phase (kV)	Switching-surge factor (per unit)	Switching surge (kV)	Electrical component of clearance	
			(m)	(ft)
242	3.54 or less	700 or less	2.17	7.12
362	2.37 or less	700 or less	2.17	7.12
550	1.56 or less	700 or less	2.17	7.12
	1.90	853	3.1	10.17
	2.00	898	3.3	10.84
	2.20	988	3.9	12.79
	2.40	1079	4.5	14.76
	2.60	1168	5.1	16.73
800	1.60	1045	4.3	14.11
	1.80	1176	5.2	17.06
	2.00	1306	6.2	20.34
	2.10 or more	1372 or more	6.7	22.00

① Limited by Rule 232D4.

② Limited by Rules 232A and 232B.

233. Clearances between wires, conductors, and cables carried on different supporting structures

A. General

Crossings should be made on a common supporting structure, where practical. In other cases, the clearance between any two crossing or adjacent wires, conductors, or cables carried on different supporting structures shall be not less than that required by Rules 233B and 233C at any location in the spans. The clearance shall be not less than that required by application of a clearance envelope developed under Rule 233A2 to the positions on or within conductor movement envelopes developed under Rule 233A1 at which the two wires, conductors, or cables would be closest together. For purposes of this determination, the relevant positions of the wires, conductors, or cables on or within their respective conductor movement envelopes are those that can occur when (1) both are simultaneously subjected to the same ambient air temperature and wind loading conditions, and (2) each is subjected individually to the full range of its icing conditions and applicable design electrical loading.

Figure 233-1 is a graphical illustration of the application of Rule 233A. Alternate methods that assure compliance with these rules may be used.

1. Conductor movement envelope

a. Development

The conductor movement envelope shall be developed from the locus of the most displaced conductor positions defined below and shown in Figure 233-2:

- (1) 15 °C (60 °F), no wind displacement, at both initial unloaded and final unloaded sag (conductor positions A and C).
- (2) With the wire, conductor, or cable displaced from rest by a 290 Pa (6 lb/ft²) wind at both initial and final sag at 15 °C (60 °F). The displacement of the wire, conductor, or cable shall include deflection of suspension insulators and flexible structures (conductor positions B and D).

EXCEPTION: Where the entire span is so close to a building, terrain feature, or other obstacle as to be sheltered from the wind flowing across the line in either direction, the wind pressure may be reduced to a 190 Pa (4 lb/ft²) wind. Trees are not considered to shelter a line.

- (3) Final sag at one of the following loading conditions, whichever produces the largest sag (conductor position E):
 - (a) 50 °C (120 °F), no wind displacement,
 - (b) The maximum conductor temperature for which the line is designed to operate, if greater than 50 °C (120 °F), with no wind displacement, or
 - (c) 0 °C (32 °F), no wind displacement, with radial thickness of ice, if any, specified in Table 230-1 for the zone concerned.

b. Sag increase

No sag increase for either high operating temperatures or ice loading is required for trolley and electrified railroad contact conductors. Rule 233A.1a(3) does not apply to these conductors.

2. Clearance envelope

The clearance envelope shown in Figure 233-3 shall be determined by the horizontal clearance (H) required by Rule 233B and the vertical clearance (V) required by Rule 233C.

B. Horizontal clearance

1. Clearance requirements

The horizontal clearance between crossing or adjacent wires, conductors, or cables carried on different supporting structures shall be not less than 1.50 m (5 ft). For voltages between the wires, conductors, or cables exceeding 22 kV, additional clearance of 10 mm (0.4 in) per kV over 22 kV shall be provided.

EXCEPTION: The horizontal clearance between anchor guys of different supporting structures may be reduced to 150 mm (6 in) and may be reduced to 600 mm (2 ft) between other guys, span wires, and neutral conductors meeting Rule 230E1.

2. Alternate clearances for voltages exceeding 98 kV ac to ground or 139 kV dc to ground

The clearances specified in Rule 233B1 may be reduced for circuits with known switching-surge factors, but shall be not less than the alternate clearance derived from the computations required in Rules 235B3a and 235B3b.

C. Vertical clearance

1. Clearance requirements

The vertical clearance between any crossing or adjacent wires, conductors, or cables carried on different supporting structures shall be not less than that shown in Table 233-1.

EXCEPTION: No vertical clearance is required between wires, conductors, or cables that are electrically interconnected at the crossing.

2. Voltages exceeding 22 kV

- a. The clearance given in Table 233-1 shall be increased by the sum of the following: For the upper-level conductors between 22 and 470 kV, the clearance shall be increased at the rate of 10 mm (0.4 in) per kV in excess of 22 kV. For the lower-level conductors exceeding 22 kV, the additional clearance shall be computed at the same rate. For voltages exceeding 470 kV, the clearance shall be determined by the method given in Rule 233C3. The additional clearance shall be computed using the maximum operating voltage if above 50 kV and nominal voltage if below 50 kV.

EXCEPTION: For voltages exceeding 98 kV ac to ground or 139 kV dc to ground, clearances less than those required above are permitted for systems with known switching-surge factors. (See Rule 233C3.)

- b. For voltages exceeding 50 kV, the additional clearance specified in Rule 233C2a shall be increased 3% for each 300 m (1000 ft) in excess of 1000 m (3300 ft) above mean sea level.
3. Alternate clearances for voltage exceeding 98 kV ac to ground or 139 kV dc to ground

The clearances specified in Rules 233C1 and 233C2 may be reduced where the higher-voltage circuit has a known switching-surge factor, but shall be not less than the alternate clearance, which is computed by adding the reference height from Rule 233C3a to the electrical component of clearance from Rule 233C3b. For these computations, communication conductors and cables, guys, messengers, neutral conductors meeting Rule 230E1, and supply cables meeting Rule 230C1 shall be considered at zero voltage.

- a. Reference heights

The reference height shall be selected from Table 233-3.

- b. Electrical component of clearance

- (1) The electrical component (D) shall be computed using the following equations. Selected values of D are listed in Table 233-2.

$$D = 1.00 \left[\frac{[V_H \cdot (PU) + V_L] a}{500K} \right]^{1.667} bc \quad (\text{m})$$

$$D = 3.28 \left[\frac{[V_H \cdot (PU) + V_L] a}{500K} \right]^{1.667} bc \quad (\text{ft})$$

where

V_H = higher-voltage circuit maximum ac crest operating voltage to ground or maximum dc operating voltage to ground in kilovolts

V_L = lower-voltage circuit maximum ac crest operating voltage to ground or maximum dc operating voltage to ground in kilovolts

PU = higher-voltage circuit maximum switching-surge factor expressed in per-unit peak voltage to ground and defined as a switching-surge level for circuit breakers corresponding to 98% probability that the maximum switching surge generated per breaker operation does not exceed this surge level, or the maximum anticipated switching-surge level generated by other means, whichever is greater

a = 1.15, the allowance for three standard deviations

b = 1.03, the allowance for nonstandard atmospheric conditions

c = 1.2, the margin of safety

K = 1.4, the configuration factor for conductor-to-conductor gap

- (2) The value of D calculated by Rule 233C3b(1) shall be increased 3% for each 300 m (1000 ft) in excess of 450 m (1500 ft) above mean sea level.

c. Limit

The alternate clearance shall be not less than the clearance required by Rules 233C1 and 233C2 with the lower-voltage circuit at ground potential.

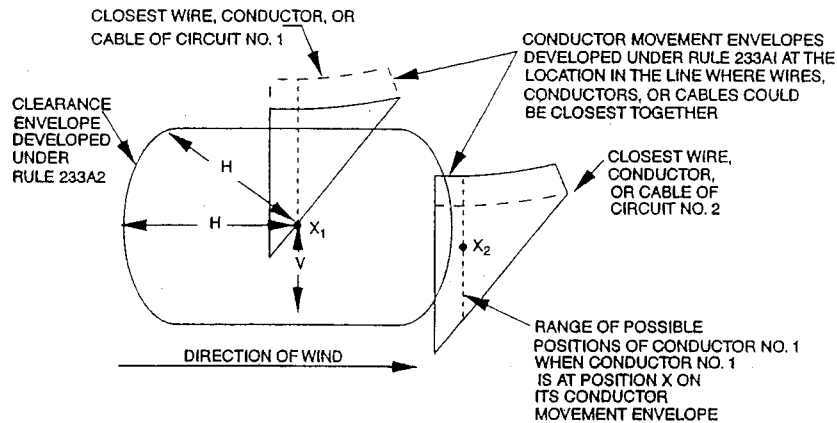

NOTE: In this illustration, Conductor No. 2 is closest at position X_2 to Conductor No. 1, where the latter is at position X_1 .

Figure 233-1—Use of clearance envelope and conductor movement envelopes to determine applicable clearance

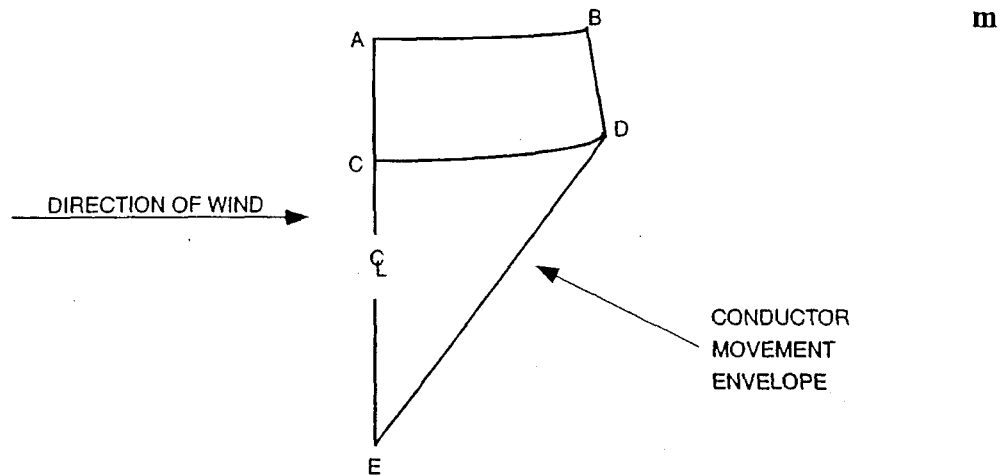

Figure 233-2—Conductor movement envelope

Point	Conductor temperature	Sag	Ice loading	Wind displacement ^①
A	15 °C ^⑤	Initial	None	None
B	15 °C ^⑤	Initial	None	290 Pa ^②
C	15 °C ^⑤	Final	None	None
D	15 °C ^⑤	Final	None	290 Pa ^②
E ₁ ^{① ④}	The greater of 50 °C or maximum operating temperature	Final	None	None
E ₂ ^{① ④}	0 °C	Final	As applicable	None

- ①The direction of the wind shall be that which produces the minimum distance between conductors. The displacement of the wires, conductors, or cables includes the deflection of suspension insulators and flexible structures.
- ②Where the entire span is so close to a building, terrain feature, or other obstacle as to be sheltered from the wind flowing across the line in either direction, the wind pressure may be reduced to a 190 Pa wind. Trees are not considered to shelter a line.
- ③Point E shall be determined by whichever of the conditions described under E₁ and E₂ produces the greatest sag.
- ④Line D–E shall be considered to be straight unless the actual concavity characteristics are known.
- ⑤When one conductor movement envelope is lower than that of the other conductor, the lower envelope shall be developed with points A, B, C, and D at a conductor temperature equal to the ambient temperature used in determining E of the upper conductor movement envelope.

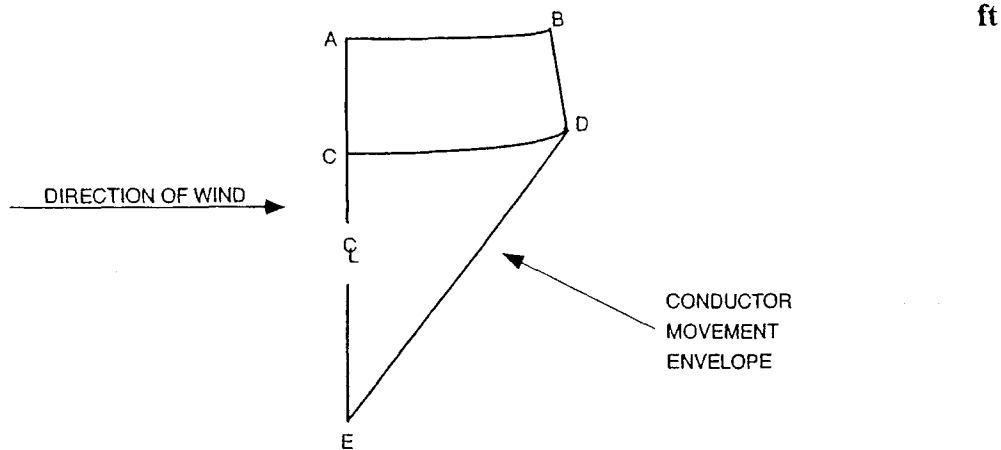

Figure 233-2—Conductor movement envelope

Point	Conductor temperature	Sag	Ice loading	Wind displacement ^①
A	60 °F ^③	Initial	None	None
B	60 °F ^③	Initial	None	6 lb/ft ² ^②
C	60 °F ^③	Final	None	None
D	60 °F ^③	Final	None	6 lb/ft ² ^②
E ₁ ^{③ ④}	The greater of 120 °F or maximum operating temperature	Final	None	None
E ₂ ^{③ ④}	32 °F	Final	As applicable	None

①The direction of the wind shall be that which produces the minimum distance between conductors. The displacement of the wires, conductors, or cables includes the deflection of suspension insulators and flexible structures.

②Where the entire span is so close to a building, terrain feature, or other obstacle as to be sheltered from the wind flowing across the line in either direction, the wind pressure may be reduced to a 4 lb/ft² wind. Trees are not considered to shelter a line.

③Point E shall be determined by whichever of the conditions described under E₁ and E₂ produces the greatest sag.

④Line D–E shall be considered to be straight unless the actual concavity characteristics are known.

⑤When one conductor movement envelope is lower than that of the other conductor, the lower conductor envelope shall be developed with points A, B, C, and D at a conductor temperature equal to the ambient temperature used in determining E of the upper conductor movement envelope.

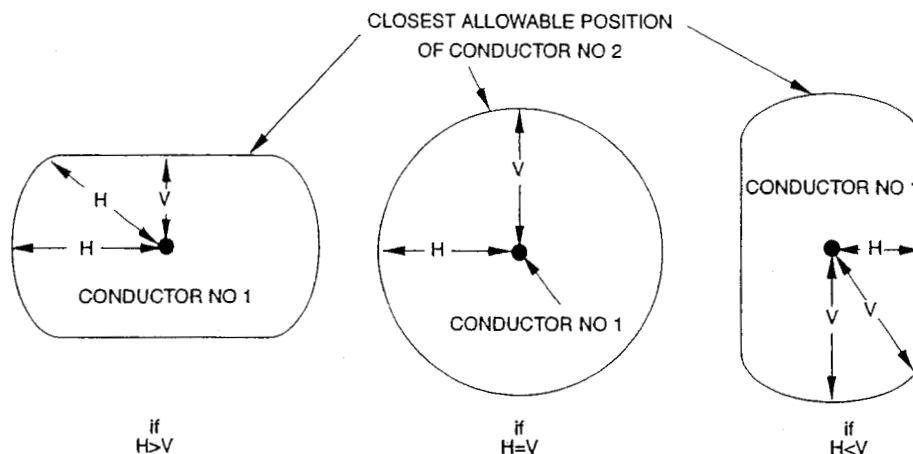

Figure 233-3—Clearance envelope

m

**Table 233-1—
Vertical clearance between wires, conductors, and cables
carried on different supporting structures**

(Voltages are phase to ground for effectively grounded circuits and those other circuits where all ground faults are cleared by promptly de-energizing the faulted section, both initially and following subsequent breaker operations. See the definitions section for voltages of other systems.

See Rules 233C1 and 233C2a.)

Lower level	Upper level				
	Effectively grounded communication guys, [Ⓢ] span wires and messengers, communication conductors and cables (m)	Effectively grounded supply guys, [Ⓢ] span wires and messengers, neutral conductors meeting Rule 230E1, and overhead shield/surge-protection wires (m)	Supply cables meeting Rule 230C1, and supply cables of 0 to 750 V meeting Rule 230C2 or 230C3 (m)	Open supply conductors 0 to 750 V, [Ⓢ] and supply cables over 750 V meeting Rule 230C2 or 230C3 (m)	Open supply conductors over 750 V to 22 kV (m)
1. Effectively grounded supply guys, [Ⓢ] span wires and messengers, neutral conductors meeting Rule 230E1, and overhead shield/surge-protection wires	0.60 [Ⓢ] [Ⓢ]	0.60 [Ⓢ] [Ⓢ]	0.60 [Ⓢ]	0.60	0.60
2. Effectively grounded communication guys, [Ⓢ] span wires and messengers; communication conductors and cables	0.60 [Ⓢ] [Ⓢ]	0.60 [Ⓢ]	0.60	1.20 [Ⓢ]	1.50 [Ⓢ]

m

Table 233-1— (continued)
Vertical clearance between wires, conductors, and cables
carried on different supporting structures

(Voltages are phase to ground for effectively grounded circuits and those other circuits where all ground faults are cleared by promptly de-energizing the faulted section, both initially and following subsequent breaker operations. See the definitions section for voltages of other systems.)

See Rules 233C1 and 233C2a.)

Lower level	Upper level				
	Effectively grounded communication guys, ^⑦ span wires and messengers, communication conductors and cables (m)	Effectively grounded supply guys, ^⑦ span wires and messengers, neutral conductors meeting Rule 230E1, and overhead shield/surge-protection wires (m)	Supply cables meeting Rule 230C1, and supply cables of 0 to 750 V meeting Rule 230C2 or 230C3 (m)	Open supply conductors 0 to 750 V, ^⑥ and supply cables over 750 V meeting Rule 230C2 or 230C3 (m)	Open supply conductors over 750 V to 22 kV (m)
3. Supply cables meeting Rule 230C1, and supply cables of 0 to 750 V meeting Rule 230C2 or 230C3	0.60	0.60	0.60	0.60	0.60
4. Open supply conductors, 0 to 750 V ^⑥ ; supply cables over 750 V meeting Rule 230C2 or 230C3	1.20 ^⑧	0.60	0.60	0.60	0.60
5. Open supply conductors, 750 V to 22 kV	1.50 ^{⑤ ⑧}	0.60	0.60 ^⑧	0.60 ^⑧	0.60
6. Trolley and electrified railroad contact conductors and associated span and messenger wires	1.20 ^③	1.20 ^③	1.20 ^③	1.20 ^{③ ④}	1.80

①No clearance is specified between guys or span wires that are electrically interconnected.

②The clearance of communication conductors and their guy, span, and messenger wires from each other in locations where no other classes of conductors are involved may be reduced by mutual consent of the parties concerned, except for fire-alarm conductors and conductors used in the operation of railroads.

③Trolley and electrified railroad contact conductors of more than 750 V should have at least 1.80 m of clearance. This clearance should also be provided over lower-voltage trolley and electrified railroad contact conductors unless the crossover conductors are beyond reach of a trolley pole leaving the trolley-contact conductor or are suitably protected against damage from trolley poles leaving the trolley-contact conductor.

④Trolley and electrified railroad feeders are exempt from this clearance requirement for contact conductors if they are of the same nominal voltage and of the same system.

⑤This clearance may be reduced to 1.20 m where supply conductors of 750 V to 8.7 kV cross a communication line more than 6 ft horizontally from a communications structure.

⑥ Does not include neutral conductors meeting Rule 230E1.

⑦These clearances may be reduced by not more than 25% to a guy insulator, provided that full clearance is maintained to its metallic end fittings and the guy wires. The clearance to an insulated section of a guy between two insulators may be reduced by not more than 25% provided that full clearance is maintained to the uninsulated portion of the guy.

⑧This clearance may be reduced to 0.60 m for supply service drops.

⑨In general, this type of crossing is not recommended.

ft

**Table 233-1—
Vertical clearance between wires, conductors, and cables
carried on different supporting structures**

(Voltages are phase to ground for effectively grounded circuits and those other circuits where all ground faults are cleared by promptly de-energizing the faulted section, both initially and following subsequent breaker operations. See the definitions section for voltages of other systems.

See Rules 233C1 and 233C2a.)

Lower level	Upper level				
	Effectively grounded communication guys, ^① span wires and messengers, communication conductors and cables (ft)	Effectively grounded supply guys, ^① span wires and messengers, neutral conductors meeting Rule 230E1, and overhead shield/surge-protection wires (ft)	Supply cables meeting Rule 230C1, and supply cables of 0 to 750 V meeting Rule 230C2 or 230C3 (ft)	Open supply conductors 0 to 750 V, ^⑥ and supply cables over 750 V meeting Rule 230C2 or 230C3 (ft)	Open supply conductors over 750 V to 22 kV (ft)
1. Effectively grounded supply guys, ^① span wires and messengers, neutral conductors meeting Rule 230E1, and overhead shield/surge-protection wires	2.0 ^{① ②}	2.0 ^{① ②}	2.0 ^②	2.0	2.0
2. Effectively grounded communication guys, ^① span wires and messengers; communication conductors and cables	2.0 ^{① ②}	2.0 ^①	2.0	4.0 ^①	5.0 ^①
3. Supply cables meeting Rule 230C1, and supply cables of 0 to 750 V meeting Rule 230C2 or 230C3	2.0	2.0	2.0	2.0	2.0
4. Open supply conductors, 0 to 750 V ^⑥ ; supply cables over 750 V meeting Rule 230C2 or 230C3	4.0 ^①	2.0	2.0	2.0	2.0
5. Open supply conductors, 750 V to 22 kV	5.0 ^{③ ④}	2.0	2.0 ^③	2.0 ^③	2.0
6. Trolley and electrified railroad contact conductors and associated span and messenger wires	4.0 ^③	4.0 ^③	4.0 ^③	4.0 ^{③ ④}	6.0

① No clearance is specified between guys or span wires that are electrically interconnected.

② The clearance of communication conductors and their guy span, and messenger wires from each other in locations where no other classes of conductors are involved may be reduced by mutual consent of the parties concerned, except for fire-alarm conductors and conductors used in the operation of railroads.

- ① Trolley and electrified railroad contact conductors of more than 750 V should have at least 6 ft of clearance. This clearance should also be provided over lower-voltage trolley and electrified railroad contact conductors unless the crossover conductors are beyond reach of a trolley pole leaving the trolley-contact conductor or are suitably protected against damage from trolley poles leaving the trolley-contact conductor.
- ④ Trolley and electrified railroad feeders are exempt from this clearance requirement for contact conductors if they are of the same nominal voltage and of the same system.
- ⑤ This clearance may be reduced to 4 ft where supply conductors of 750 V to 8.7 kV cross a communication line more than 6 ft horizontally from a communications structure.
- ⑥ Does not include neutral conductors meeting Rule 230E1.
- ⑦ These clearances may be reduced by not more than 25% to a guy insulator, provided that full clearance is maintained to its metallic end fittings and the guy wires. The clearance to an insulated section of a guy between two insulators may be reduced by not more than 25% provided that full clearance is maintained to the uninsulated portion of the guy.
- ⑧ This clearance may be reduced to 2 ft for supply service drops.
- ⑨ In general, this type of crossing is not recommended.

m

Table 233-2—
Clearance between supply wires, conductors, and cables in Rule 233C3b(1)
 (Add 3% for each 300 m in excess of 450 m above mean sea level.)

Higher-voltage circuit		Lower-voltage circuit						
Maximum operating voltage phase to phase (kV)	Switching-surge factor (per unit)	Maximum operating voltage phase to phase (kV)						
		121 (m)	145 (m)	169 (m)	242 (m)	362 (m)	550 (m)	800 (m)
242	3.3 or less	1.78 ^①	1.84	1.91	2.16			
362	2.4	2.48 ^①	2.48 ^①	2.48 ^①	2.48 ^①	2.86		
	2.6	2.48 ^①	2.48 ^①	2.48 ^①	22.67	3.2		
	2.8	2.49	2.58	2.67	3.0	3.5		
	3.0	2.76 ^①	2.86 ^①	3.0	3.3	3.8		
550	1.8	3.6 ^①	3.6 ^①	3.6 ^①	3.6 ^①	3.6 ^①	4.2	
	2.0	3.6 ^①	3.6 ^①	3.6 ^①	3.6 ^①	3.8 ^①	4.7	
	2.2	3.6 ^①	3.6 ^①	3.6 ^①	3.8	4.3	5.2	
	2.4	3.8	3.9	4.0	4.3	4.8	5.8	
	2.6	4.1 ^②	4.2 ^②	4.4 ^②	4.8 ^②	5.4	6.3	

m

Table 233-2— (continued)
Clearance between supply wires, conductors, and cables in Rule 233C3b(1)
 (Add 3% for each 300 m in excess of 450 m above mean sea level.)

Higher-voltage circuit		Lower-voltage circuit						
Maximum operating voltage phase to phase (kV)	Switching-surge factor (per unit)	Maximum operating voltage phase to phase (kV)						
		121 (m)	145 (m)	169 (m)	242 (m)	362 (m)	550 (m)	800 (m)
800	1.6	5.0 ^①	5.0 ^①	5.0 ^①	5.0 ^①	5.0 ^①	5.6	6.9
	1.8	5.0 ^①	5.0 ^①	5.0 ^①	5.0 ^①	5.4	6.4	7.8
	2.0	5.0 ^①	5.2	5.3	5.6	6.3	7.3	8.7
	2.2	5.5 ^②	5.7 ^②	5.8 ^②	6.2 ^②	6.9 ^②	8.0 ^②	9.4 ^②

① Limited by Rule 233C3c.

② Need not be greater than the values specified in Rules 233C1 and 233C2.

ft

Table 233-2—
Clearance between supply wires, conductors, and cables in Rule 233C3b(1)
 (Add 3% for each 1000 ft in excess of 1500 ft above mean sea level.)

Higher-voltage circuit		Lower-voltage circuit						
Maximum operating voltage phase to phase (kV)	Switching-surge factor (per unit)	Maximum operating voltage phase to phase (kV)						
		121 (ft)	145 (ft)	169 (ft)	242 (ft)	362 (ft)	550 (ft)	800 (ft)
242	3.3 or less	6.0 ^①	6.1	6.3	7.1			
362	2.4	8.3 ^①	8.3 ^①	8.3 ^①	8.3 ^①	9.4		
	2.6	8.3 ^①	8.3 ^①	8.3 ^①	8.8	10.3		
	2.8	8.3 ^①	8.5	8.8	9.7	11.3		
	3.0	9.1	9.4	9.7	10.7	12.3		

ft

Table 233-2— (continued)
Clearance between supply wires, conductors, and cables in Rule 233C3b(1)
 (Add 3% for each 1000 ft in excess of 1500 ft above mean sea level.)

Higher-voltage circuit		Lower-voltage circuit						
Maximum operating voltage phase to phase (kV)	Switching-surge factor (per unit)	Maximum operating voltage phase to phase (kV)						
		121 (ft)	145 (ft)	169 (ft)	242 (ft)	362 (ft)	550 (ft)	800 (ft)
550	1.8	11.9 ^①	11.9 ^①	11.9 ^①	11.9 ^①	11.9 ^①	13.6	
	2.0	11.9 ^①	11.9 ^①	11.9 ^①	11.9 ^①	12.5	15.3	
	2.2	11.9 ^①	11.9 ^①	11.9 ^①	12.4	14.1	17.0	
	2.4	12.2	12.6	12.9	14.0	15.8	18.8	
	2.6	13.5 ^②	14.0 ^②	14.4	15.6	17.5	20.7	
800	1.6	16.7 ^①	16.7 ^①	16.7 ^①	16.7 ^①	16.7	18.2	22.5
	1.8	16.7 ^①	16.7 ^①	16.7 ^①	16.7 ^①	17.7	20.9	25.4
	2.0	16.7 ^①	16.8	17.2	18.4	20.4	23.7	28.5
	2.2	18.3 ^②	18.8 ^②	19.2 ^②	20.6 ^②	22.9 ^②	26.6 ^②	31.4 ^②

① Limited by Rule 233C3c.

② Need not be greater than the values specified in Rules 233C1 and 233C2.

Table 233-3—Reference heights
 (See Rule 233C3a.)

Reference height	(m)	(ft)
(1) Supply lines	0	
(2) Communication lines	0.60	

234. Clearance of wires, conductors, cables, and equipment from buildings, bridges, rail cars, swimming pools, and other installations

A. Application

1. Vertical and horizontal clearances (no wind displacement)

The vertical and horizontal clearances specified in Rules 234B, 234C, 234D, 234E, 234F, and 234I apply under whichever conditions of the following conductor temperature and loading conditions produces the closest approach. Rules 234A1a, 234A1b, and 234A1c apply above

and alongside subject installations; Rule 234A1d applies below and alongside subject installations.

- a. 50 °C (120 °F), no wind displacement, final sag.
- b. The maximum conductor temperature for which the line is designed to operate, if greater than 50 °C (120 °F), no wind displacement, final sag.
- c. 0 °C (32 °F), no wind displacement, final sag, with radial thickness of ice, if any, specified in Table 230-1 for the zone concerned.
- d. The minimum conductor temperature for which the line is designed, no wind displacement, initial sag.

EXCEPTION: Vertical or lateral conductors or cables attached directly to the surface of a supporting structure in accordance with other rules are not subject to the provisions of this rule.

NOTE: The phase and neutral conductors of a supply line are normally considered separately when determining the sag of each due to temperature rise.

2. Horizontal clearances (with wind displacement)

Where consideration of horizontal displacement under wind conditions is required, the wires, conductors, or cables shall be considered to be displaced from rest toward the installation by a 290 Pa (6 lb/ft²) wind at final sag at 15 °C (60 °F). The displacement of a wire, conductor or cable shall include deflection of suspension insulators. The displacement of a wire, conductor, or cable shall also include deflection of a flexible structure if the highest wire, conductor, or cable attachment is 18 m (60 ft) or more above grade.

EXCEPTION: Where the entire span is so close to a building, terrain feature, or other obstacle as to be sheltered from the wind flowing across the line in either direction, the wind pressure may be reduced to a 190 Pa (4 lb/ft²) wind. Trees are not considered to shelter a line.

3. Transition between horizontal and vertical clearances

The horizontal clearance governs above the level of the roof or top of an installation to the point where the diagonal equals the vertical clearance requirement. Similarly, the horizontal clearance governs above or below projections from buildings, signs, or other installations to the point where the diagonal equals the vertical clearance requirement. From this point the transitional clearance shall equal the vertical clearance as shown in Figures 234-1(a) and 234-1(b). This rule should not be interpreted as restricting the installation of a trolley-contact conductor over the approximate center line of the track it serves.

EXCEPTION: When the horizontal clearance is greater than the vertical clearance, the vertical clearance governs beyond the roof or top of an installation, or projections from an installation, to the point where the diagonal equals the horizontal clearance requirement, as shown in Figure 234-1(c).

B. Clearances of wires, conductors, and cables from other supporting structures

Wires, conductors, or cables of one line passing near a lighting support, traffic signal support, or a supporting structure of a second line, without being attached thereto, shall have clearance from any part of such structure not less than the following:

1. Horizontal clearances

- a. A horizontal clearance, without wind, of 1.50 m (5 ft) for voltages up to 50 kV.

EXCEPTION: For effectively grounded guys and messengers, insulated communication conductors and cables, neutrals meeting Rule 230E1, and cables of 300 V or less to ground meeting the requirements of Rule 230C1, 230C2, or 230C3, the horizontal clearance may be reduced to 900 mm (3 ft).

- b. When the following conductors and cables are displaced from rest under the wind conditions of Rule 234A2, horizontal clearances from such conductors or cables to other supporting structures shall be not less than those shown below:

Conductor or cable	Horizontal clearance required when displaced by wind	
	(m)	(ft)
Open supply conductors, 0 to 750 V [ⓐ]	1.1	3.5
230C2 cable, above 750 V	1.1	3.5
230C3 cable, above 750 V	1.1	3.5
Open supply conductors, over 750 V to 22 kV	1.4	4.5

[ⓐ]Does not include neutral conductors meeting Rule 230E1. See footnotes [ⓐ] and [ⓑ] to Table 234-1.

2. Vertical clearances

A vertical clearance of 1.40 m (4.5 ft) for voltages below 22 kV and a vertical clearance of 1.70 m (5.5 ft) for voltages between 22 kV and 50 kV. *EXCEPTIONS 1* and *2* shall not be applied cumulatively.

EXCEPTION 1: For effectively grounded guys and messengers, insulated communication conductors and cables, and neutrals meeting Rule 230E1 and for cables of 300 V or less to ground meeting the requirements of Rule 230C1, 230C2, or 230C3, the vertical clearance may be reduced to 600 mm (2 ft).

NOTE: Clearances of wires, conductors, and cables from adjacent line structure guy wires are given in Rule 233.

EXCEPTION 2: The vertical clearances may be reduced by 600 mm (2 ft) if both of the following conditions are met:

- (a) The wires, conductors, or cables above and the supporting structure of another line below are operated and maintained by the same utility
- (b) Employees do not work above the top of the supporting structure unless:
 - (1) The upper circuit is de-energized and grounded per Rule 444D or temporarily insulated or repositioned, or
 - (2) Other equivalent measures are taken.

C. Clearances of wires, conductors, cables, and rigid live parts from buildings, signs, billboards, chimneys, radio and television antennas, tanks, and other installations except bridges

1. Vertical and horizontal clearances

a. Clearances

Unguarded or accessible wires, conductors, cables, or rigid live parts may be located adjacent to buildings, signs, billboards, chimneys, radio and television antennas, tanks, and other installations and any projections therefrom. The vertical and horizontal clearances of such rigid and nonrigid parts shall be not less than the values given in Table 234-1 when at rest under the conditions specified in Rule 234A1. These facilities may be installed beside, over or under buildings, building projections and other installations, as illustrated in Figures 234-1(a), 234-1(b), and 234-1(c).

b. Horizontal clearances under wind displacement conditions

When the following conductors and cables are displaced from rest under the wind conditions of Rule 234A2, horizontal clearances from such conductors or cables to buildings, signs, billboards, chimneys, radio and television antennas, and other installations shall be not less than those shown below:

Conductor or cable	Horizontal clearance required when displaced by wind	
	(m)	(ft)
Open supply conductors, 0 to 750 V [Ⓛ]	1.1	3.5
230C2 cable, above 750 V	1.1	3.5
230C3 cable, above 750 V	1.1	3.5
Open supply conductors, over 750 V to 22 kV	1.4	4.5

[Ⓛ]Does not include neutral conductors meeting Rule 230E1.
See footnotes [Ⓛ] and [Ⓜ] to Table 234-1.

2. Guarding of supply conductors and rigid live parts

Where the clearances set forth in Table 234-1 cannot be obtained, supply conductors and rigid live parts shall be guarded. Supply cables meeting Rule 230C1a are considered to be guarded within the meaning of this rule.

3. Supply conductors attached to buildings or other installations

Where the permanent attachment of supply conductors of any class to a building or other installation is necessary for an entrance, such conductors shall meet the following requirements over or along the installation to which the conductors are attached:

- a. Energized service drop conductors, including splices and taps, shall be insulated or covered in accordance with the following:
 - (1) For 0 to 750V, Rule 230C or 230D
 - (2) For over 750 V, Rule 230C1

This rule does not apply to neutral conductors meeting Rule 230E1.
- b. Conductors of more than 300 V to ground shall not be carried along or near the surface of the installation unless they are guarded or made inaccessible.
- c. Wires or cables attached to and run along side the installation shall have clearances from the surface of the installation not less than 75 mm (3 in).
- d. Service-drop conductors, including drip loops—shall have a clearance of not less than the following:
 - (1) 3.0 m (10 ft) vertical clearance from the highest point of roofs, balconies, porches, or attached decks over which they pass

EXCEPTION: Where the voltage between conductors meeting Rule 230D does not exceed 300 V, or where the voltage of cables meeting Rule 230C2 or 230C3 does not exceed 750 V, or where the cable meets Rule 230C1, and the roof, balcony, porch, or attached deck is not readily accessible, the clearance over the roof, balcony, porch, or attached deck including the drip loop shall be not less than either of the following:

 - (a) 900 mm (3 ft)
 - (b) 457 mm (18 in) for a horizontal distance of 1.8 m (6 ft) from an approved raceway or support located not more than 1.2 m (4 ft) from the edge of the roof and not less than 900 mm (3 ft) for the remainder of the horizontal distance that the cable or conductor passes over the roof or balcony

A roof, balcony, porch, or attached deck is considered readily accessible to pedestrians if it can be casually accessed through a doorway, window, ramp, stairway, or permanently mounted

ladder by a person, on foot, who neither exerts extraordinary physical effort nor employs tools or devices to gain entry. A permanently mounted ladder is not considered a means of access if its bottom rung is 2.45 m (8 ft) or more from the ground or other permanently installed accessible surface.

NOTE: See Figure 234-2.

- (2) 900 mm (3 ft) in any direction from windows, doors, porches, fire escapes, or similar locations.

EXCEPTION 1: This does not apply to service-drop conductors meeting Rule 230C3 above the top level of a window.

EXCEPTION 2: This does not apply to windows that are not designed to open.

- 4. Communication conductors attached to buildings or other installations

Communication conductors and cables may be attached directly to buildings or other installations.

- 5. Ladder space

Where buildings or other installations exceed three stories [or 15 m (50 ft)] in height, overhead lines should be arranged where practical so that a clear space or zone at least 1.8 m (6 ft) wide will be left either adjacent to the building or beginning not over 2.45 m (8 ft) from the building to facilitate the raising of ladders where necessary for fire fighting.

EXCEPTION: This requirement does not apply where it is the unvarying rule of the local fire departments to exclude the use of ladders in alleys or other restricted places that are generally occupied by supply conductors and cables.

D. Clearance of wires, conductors, cables, and unguarded rigid live parts from bridges

- 1. Vertical and horizontal clearances

- a. Clearances

Unguarded or accessible wires, conductors, cables, or rigid live parts may be located adjacent to or within a bridge structure. The vertical and horizontal clearances of such rigid and nonrigid parts shall be not less than the values given in Table 234-2 when at rest under the conditions specified in Rule 234A1, as illustrated in Figures 234-1(a) and 234-1(b).

EXCEPTION: This rule does not apply to insulated communication cables, effectively grounded guys, span wires, and surge protection wires; neutrals meeting Rule 230E1; and supply cables meeting Rule 230C1.

- b. Horizontal clearances under wind displacement conditions

When the following conductors and cables are displaced from rest under the wind conditions of Rule 234A2, horizontal clearances from such conductors or cables to bridges shall be not less than those shown below:

Conductor or cable	Horizontal clearance required when displaced by wind	
	(m)	(ft)
Open supply conductors, 0 to 750 V ^①	1.1	3.5
230C2 cable, above 750 V	1.1	3.5
230C3 cable, above 750 V	1.1	3.5
Open supply conductors, over 750 V to 22 kV	1.4	4.5

^①Does not include neutral conductors meeting Rule 230E1. See footnotes [Ⓞ] and [Ⓟ] to Table 234-2.

2. Guarding trolley-contact conductors located under bridges
 - a. Where guarding is required

Guarding is required where the trolley-contact conductor is located so that a trolley pole leaving the conductor can make simultaneous contact between it and the bridge structure.
 - b. Nature of guarding

Guarding shall consist of a substantial inverted trough of nonconducting material located above the contact conductor, or of other suitable means of limiting the likelihood of contact between the trolley support and the bridge structure.
- E. Clearance of wires, conductors, cables, or unguarded rigid live parts installed over or near swimming areas with no wind displacement
1. Swimming pools

Where wires, conductors, cables, or unguarded rigid live parts are over a swimming pool or the surrounding area, the clearances in any direction shall be not less than those shown in Table 234-3 and illustrated in Figure 234-3.

EXCEPTION 1: This rule does not apply to a pool fully enclosed by a solid or screened permanent structure.

EXCEPTION 2: This rule does not apply to communication conductors and cables, effectively grounded surge-protection wires, neutral conductors meeting Rule 230E1, guys and messengers, supply cables meeting Rule 230C1, and supply cables of 0 to 750 V meeting Rule 230C2 or 230C3 when these facilities are 3 m (10 ft) or more horizontally from the edge of the pool, diving platform, diving tower, water slide, or other fixed, pool-related structures.
 2. Beaches and waterways restricted to swimming

Where rescue poles are used by lifeguards at supervised swimming beaches, the vertical and horizontal clearances shall be not less than those shown in Table 234-3. Where rescue poles are not used, the clearances shall be as specified in Rule 232.
 3. Waterways subject to water skiing

The vertical clearance shall be the same as that specified in Rule 232.
- F. Clearances of wires, conductors, cables, and rigid live parts from grain bins
1. Grain bins loaded by permanently installed augers, conveyers, or elevator systems

All portions of grain bins that are expected to be loaded by the use of a permanently installed auger, conveyer, or elevator system shall be considered as a building or other installation under Rule 234C for the purpose of determining appropriate clearances of wires, conductors, cables, and rigid live parts. In addition, the following clearances shall also apply without wind displacement. See Figure 234-4(a).

 - a. A clearance of not less than 5.5 m (18 ft) in all directions above the grain bin shall be maintained from each probe port in the grain bin roof for all wires, conductors, and cables.
 - b. A horizontal clearance of not less than 4.6 m (15 ft) shall be maintained between grain bins and open supply conductors, 0 to 22 kV. This clearance does not apply to a neutral conductor meeting Rule 230E1.
 2. Grain bins loaded by portable augers, conveyers, or elevators (with no wind displacement)
 - a. The clearance of wires, conductors, cables, and rigid live parts from grain bins that are expected to be loaded by the use of a portable auger, conveyer, or elevator shall be not less than the values illustrated in Figure 234-4b.

EXCEPTION: Clearances of the following items on the nonloading side of grain bins shall be not less than those required by Rule 234C for clearances from buildings:

 - (a) Support arms; effectively grounded equipment cases
 - (b) Insulated communication conductors and cables, messengers, surge-protection wires, grounded guys, neutral conductors meeting Rule 230E1, and supply cables meeting Rule 230C1
 - (c) Supply cables of 0 to 750 V meeting Rule 230C2 or 230C3

- b. Any side of a grain bin is considered to be a nonloading side if it is so designated, or if it is so closely abutting another structure or obstruction, or so close to a public road or other right-of-way that a portable auger, conveyor, or elevator is not reasonably anticipated to be used over that side or portion to fill the grain bin.
 - c. Where an agreement excludes the use of portable augers, conveyors, or elevators from a designated portion of a grain bin, such portion is considered to be a nonloading side.
- G. Additional clearances for voltages exceeding 22 kV for wires, conductors, cables, and unguarded rigid live parts of equipment

Greater clearances than specified in Rules 234B, 234C, 234D, 234E, 234F, and 234J shall be provided where required as follows:

1. For voltages between 22 and 470 kV, the clearance specified in Rules 234B, 234C, 234D, 234E, 234F, and 234J shall be increased at the rate of 10 mm (0.4 in) per kV in excess of 22 kV. For voltages exceeding 470 kV, the clearance shall be determined by the method given in Rule 234H. All clearances for lines over 50 kV shall be based on the maximum operating voltage.

EXCEPTION 1: Where a clearance value is given for the 22 kV to 50 kV range, the voltage adder of Rule 234G1 applies to the voltage in excess of 50 kV.

EXCEPTION 2: For voltages exceeding 98 kV ac to ground or 139 kV dc to ground, clearances less than those required above are permitted for systems with known maximum switching-surge factor. (See Rule 234H.)

2. For voltages exceeding 50 kV, the additional clearance specified in Rule 234G1 shall be increased 3% for each 300 m (1000 ft) in excess of 1000 m (3300 ft) above mean sea level.
 3. For voltages exceeding 98 kV ac to ground, either the clearances shall be increased or the electric field, or the effects thereof, shall be reduced by other means, as required, to limit the steady-state current due to electrostatic effects to 5 mA, rms, if an ungrounded metal fence, building, sign, billboard, chimney, radio or television antenna, tank or other installation, or any ungrounded metal attachments thereto, were short-circuited to ground. For this determination, the conductor shall be at a final unloaded sag at 50 °C (120 °F).
- H. Alternate clearances for voltages exceeding 98 kV ac to ground or 139 kV dc to ground

The clearances specified in Rules 234B, 234C, 234D, 234E, 234F, 234G, and 234J may be reduced for circuits with known switching-surge factors, but shall be not less than the alternate clearance, which is computed by adding the reference distance from Rule 234H2 to the electrical component of clearance from Rule 234H3.

1. Sag conditions of line conductors

The vertical, horizontal, and diagonal clearances shall be maintained under the conductor temperature and loading conditions given in Rule 234A.

2. Reference distances

The reference distance shall be selected from Table 234-5.

3. Electrical component of clearance

- a. The electrical component (D) shall be computed using the following equations. Selected values of D are listed in Table 234-4.

$$D = 1.00 \left[\frac{V \cdot (PU) \cdot a}{500K} \right]^{1.667} bc \quad (\text{m})$$

$$D = 3.28 \left[\frac{V \cdot (PU) \cdot a}{500K} \right]^{1.667} bc \quad (\text{ft})$$

where

V = maximum ac crest operating voltage to ground or maximum dc operating voltage to ground in kilovolts

PU = maximum switching-surge factor expressed in per-unit peak voltage to ground and defined as a switching-surge level for circuit breakers corresponding to 98% probability that the maximum switching surge generated per breaker operation does not exceed this surge level, or the maximum anticipated switching-surge level generated by other means, whichever is greater

a = 1.15, the allowance for three standard deviations

b = 1.03, the allowance for nonstandard atmospheric conditions

c = the margin of safety:
1.2 for vertical clearances
1.0 for horizontal clearances

K = 1.15, the configuration factor for conductor-to-plane gap

- b. The value of D shall be increased 3% for each 300 m (1000 ft) in excess of 450 m (1500 ft) above mean sea level.

4. Limit

The alternate clearance shall be not less than the clearance of Rule 234B, Table 234-1, 234-2, or 234-3, as applicable, computed for 98 kV ac rms to ground by Rule 234G1.

I. Clearance of wires, conductors, and cables to rail cars

Where overhead wires, conductors, or cables run along railroad tracks, the clearance in any direction shall be not less than that shown in Figure 234-5. The values of V and H are as defined as follows:

V = vertical clearance from the wire, conductor, or cable above the top of the rail as specified in Rule 232 minus 6.1 m (20 ft), the assumed height of the rail car

H = horizontal clearance from the wire, conductor, or cable to the nearest rail, which is equal to the required vertical clearance above the rail minus 4.6 m (15 ft) as computed by the lesser of the following:

1. Rules 232B1 and 232C1
2. Rule 232D

These clearances are computed for railroads handling standard rail cars as common carriers in interchange service with other railroads. Where wires, conductors, or cables run along mine, logging, and similar railways that handle only cars smaller than standard freight cars, the value of H may be reduced by one-half the difference between the width of a standard rail car [3.3 m (10 ft, 8 in)] and the width of the narrower car.

J. Clearance of equipment mounted on supporting structures

1. Clearance to unguarded rigid live parts of equipment

The horizontal and vertical clearances of unguarded rigid live parts such as potheads, transformer bushings, surge arresters, and short lengths of supply conductors connected thereto, which are not subject to variation in sag, shall be not less than those required by Rule 234C or 234D, as applicable.

2. Clearance to equipment cases

Equipment shall be mounted so that clearances are not less than that given by Rules 234J2a, 234J2b, and 234J2c.

- a. Effectively grounded equipment cases may be located on or adjacent to buildings, bridges, or other structures provided that clearances for unguarded rigid live parts of such equipment, as specified in Rule 234J1, are maintained.
- b. Equipment cases that are not effectively grounded shall be located so that the clearances of Rule 234C or 234D, as applicable, are maintained.

- c. Equipment cases shall be located so as not to serve as a means of approach to unguarded rigid live parts by unqualified persons.

NOTE: Rule 234J is not subject to the loading conditions of Rule 234A.

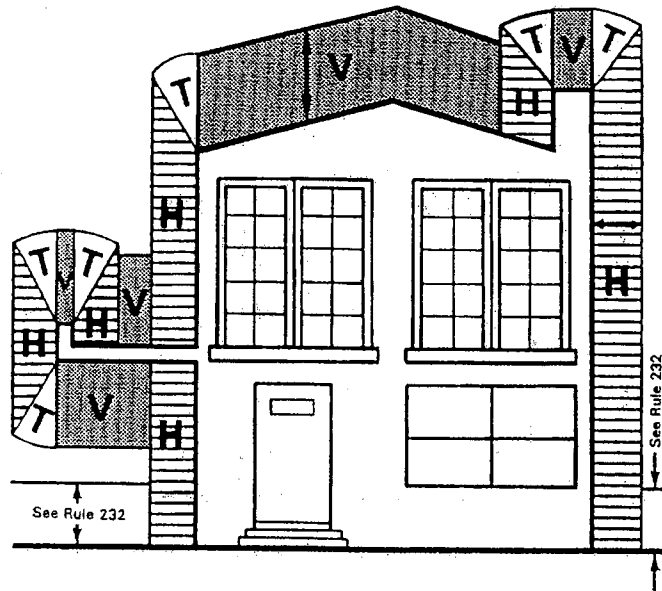

LEGEND

Regions Where Conductors Are Prohibited	Controlling Clearance
H	Horizontal
V	Vertical
T	Transitional = Vertical (Arc)

Figure 234-1(a)—Clearance diagram for building

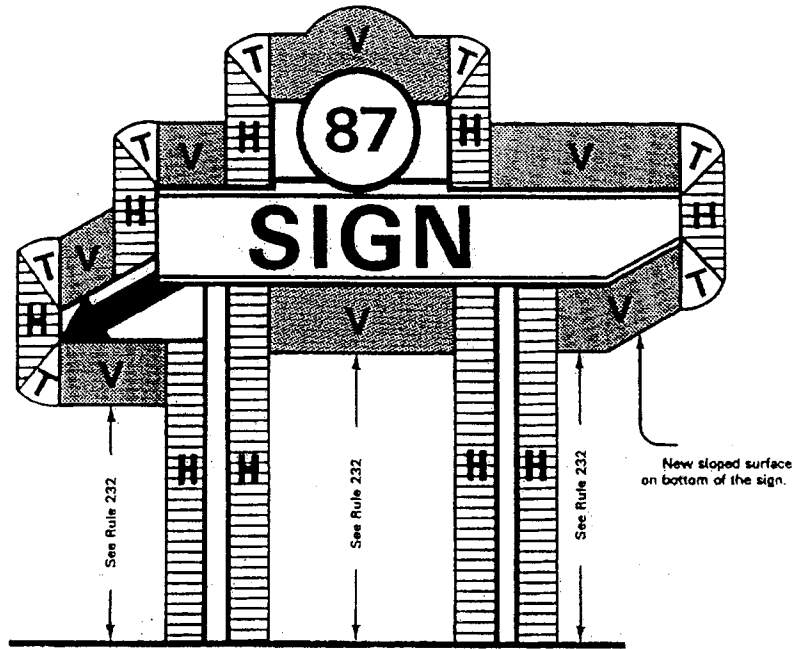

Figure 234-1(b)—Clearance diagram for other structures

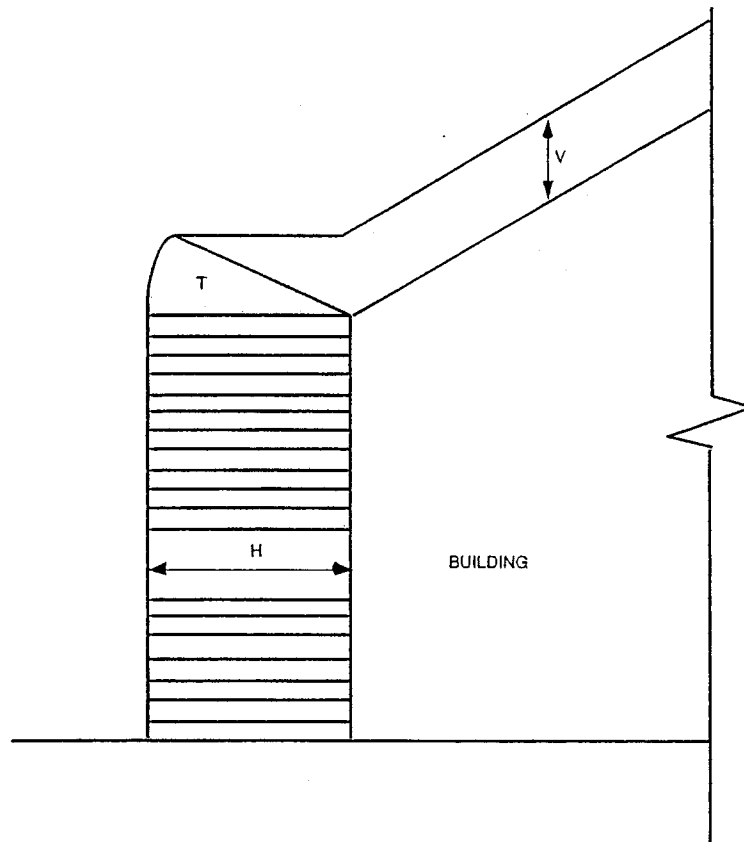
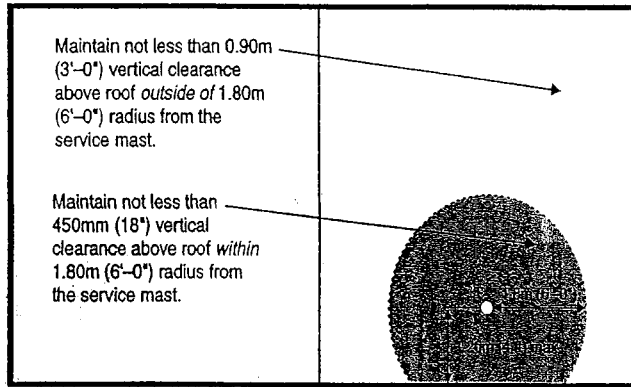
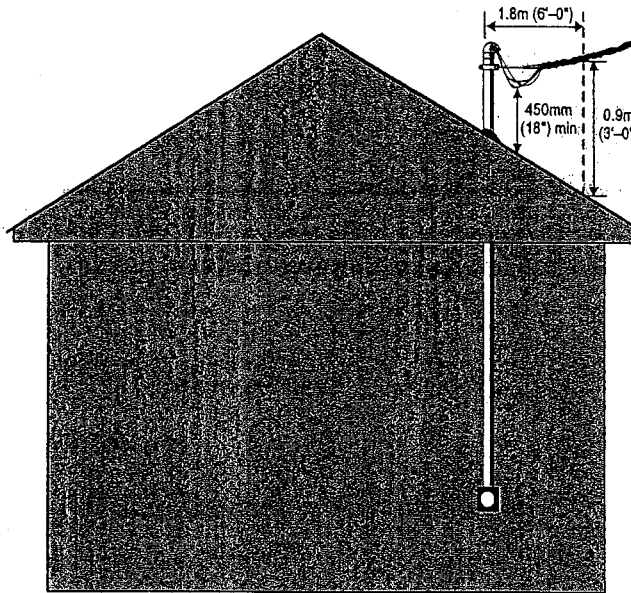

Figure 234-1(c)—Transitional clearance when H is greater than V



Plan View



Elevation View

Figure 234-2—Clearances of service drop terminating on support mast

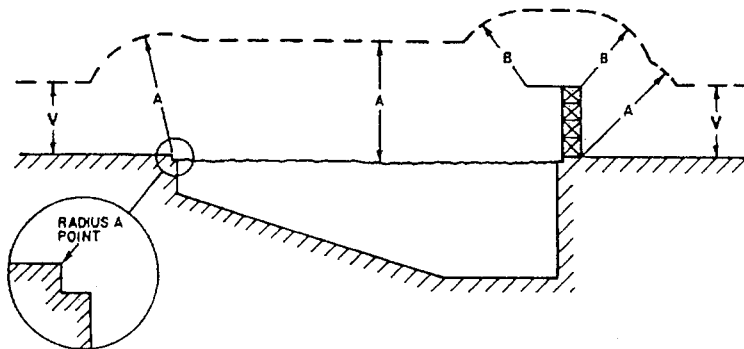

Figure 234-3—Swimming pool clearances

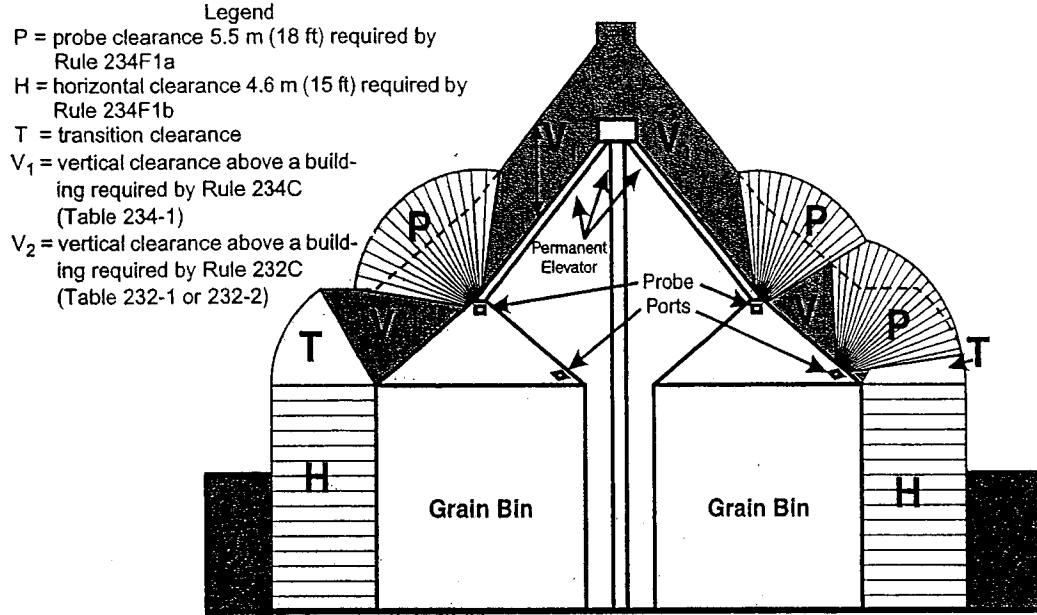
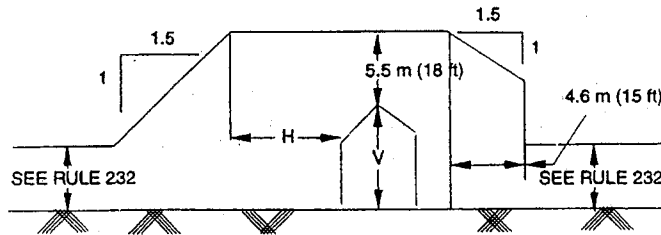

Figure 234-4(a)—Clearance envelope for grain bins filled by permanently installed augers, conveyors, or elevators



V = HEIGHT OF HIGHEST FILLING OR PROBING PORT ON GRAIN BIN
 $H = V + 5.5 \text{ m (18 ft)}$

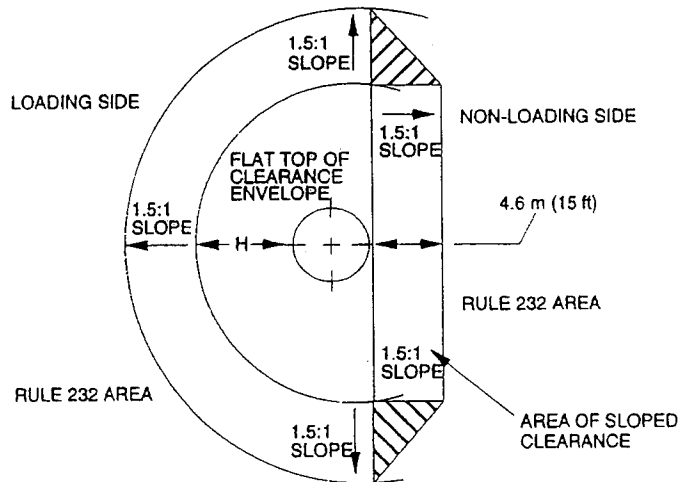

Figure 234-4(b)—Clearance envelope for grain bins filled by portable augers, conveyors, or elevators

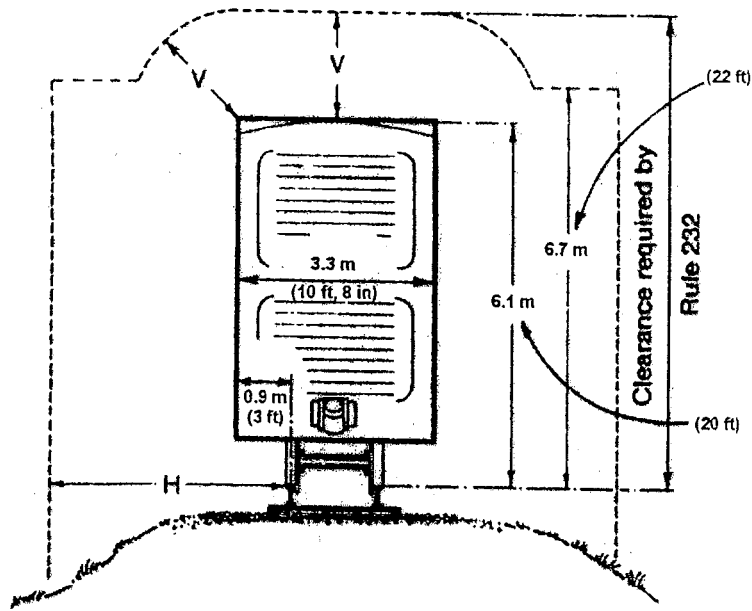

Figure 234-5—Rail car clearances

m

Table 234-1—

Clearance of wires, conductors, cables, and unguarded rigid live parts adjacent but not attached to buildings and other installations except bridges[®]

(Voltages are phase to ground for effectively grounded circuits and those other circuits where all ground faults are cleared by promptly de-energizing the faulted section, both initially and following subsequent breaker operations. See the definitions section for voltages of other systems. Clearances are with no wind displacement except where stated in the footnotes below.

See Rules 234C1a, 234C2, and 234H4.)

Clearance of	Insulated communication conductors and cables; messengers; surge-protection wires; grounded guys; ungrounded guys exposed to 0 to 300 V [®] ; neutral conductors meeting Rule 230E1; supply cables meeting Rule 230C1 (m)	Supply cables of 0 to 750 V meeting Rule 230C2 or 230C3 (m)	Unguarded rigid live parts, 0 to 750 V; noninsulated communication conductors; ungrounded equipment cases, 0 to 750 V; and ungrounded guys exposed to open supply conductors of over 300 V [®] to 750 V [®] (m)	Supply cables over 750 V meeting Rule 230C2 or 230C3; open supply conductors, 0 to 750 V (m) [®]	Unguarded rigid live parts, over 750 V to 22 kV; ungrounded equipment cases, 750 V to 22 kV; ungrounded guys exposed to over 750 V [®] to 22 kV [®] (m)	Open supply conductors, over 750 V to 22 kV (m)
1. Buildings						
a. Horizontal						
(1) To walls, projections, and guarded windows	1.40 ^{① ② ⑦}	1.50 ^{① ②}	1.50 ^{① ②}	1.70 ^{① ② ④}	2.00 ^{① ②}	2.30 ^{① ② ⑧ ⑩}
(2) To unguarded windows ^①	1.40	1.50	1.50	1.70 ^④	2.00	2.30 ^{⑧ ⑩}
(3) To balconies and areas readily accessible to pedestrians ^③	1.40	1.50	1.50	1.70 ^④	2.00	2.30 ^{⑧ ⑩}
b. Vertical[®]						
(1) Over or under roofs or projections not readily accessible to pedestrians ^③	0.90	1.07	3.0	3.2	3.6	3.8
(2) Over or under balconies and roofs readily accessible to pedestrians ^①	3.2	3.4	3.4	3.5	4.0	4.1

m

Table 234-1— (continued)

Clearance of wires, conductors, cables, and unguarded rigid live parts adjacent but not attached to buildings and other installations except bridges[Ⓜ]

(Voltages are phase to ground for effectively grounded circuits and those other circuits where all ground faults are cleared by promptly de-energizing the faulted section, both initially and following subsequent breaker operations. See the definitions section for voltages of other systems. Clearances are with no wind displacement except where stated in the footnotes below.

See Rules 234C1a, 234C2, and 234H4.)

Clearance of	Insulated communication conductors and cables; messengers; surge-protection wires; grounded guys; ungrounded guys exposed to 0 to 300 V [Ⓜ] ; neutral conductors meeting Rule 230E1; supply cables meeting Rule 230C1 (m)	Supply cables of 0 to 750 V meeting Rule 230C2 or 230C3 (m)	Unguarded rigid live parts, 0 to 750 V; noninsulated communication conductors; ungrounded equipment cases, 0 to 750 V; and ungrounded guys exposed to open supply conductors of over 300 V to 750 V [Ⓜ] (m)	Supply cables over 750 V meeting Rule 230C2 or 230C3; open supply conductors, 0 to 750 V (m) [Ⓜ]	Unguarded rigid live parts, over 750 V to 22 kV; ungrounded equipment cases, 750 V to 22 kV; ungrounded guys exposed to over 750 V to 22 kV [Ⓜ] (m)	Open supply conductors, over 750 V to 22 kV (m)
(3) Over roofs accessible to vehicles but not subject to truck traffic [Ⓜ]	3.2	3.4	3.4	3.5	4.0	4.1
(4) Over roofs accessible to truck traffic [Ⓜ]	4.7	4.9	4.9	5.0	5.5	5.6
2. Signs, chimneys, billboards, radio and television antennas, tanks, and other installations not classified as buildings or bridges						
a. Horizontal[Ⓜ]						
(1) To portions that are readily accessible to pedestrians [Ⓜ]	1.40	1.50	1.50	1.70 [Ⓜ]	2.00	2.30 [Ⓜ] [Ⓜ]
(2) To portions that are not readily accessible to pedestrians [Ⓜ]	0.90	1.07	1.50 [Ⓜ] [Ⓜ]	1.70 [Ⓜ] [Ⓜ] [Ⓜ]	2.00 [Ⓜ] [Ⓜ]	2.30 [Ⓜ] [Ⓜ] [Ⓜ]
b. Vertical						

m

Table 234-1— (continued)

Clearance of wires, conductors, cables, and unguarded rigid live parts adjacent but not attached to buildings and other installations except bridges[Ⓜ]

(Voltages are phase to ground for effectively grounded circuits and those other circuits where all ground faults are cleared by promptly de-energizing the faulted section, both initially and following subsequent breaker operations. See the definitions section for voltages of other systems. Clearances are with no wind displacement except where stated in the footnotes below.

See Rules 234C1a, 234C2, and 234H4.)

Clearance of	Insulated communication conductors and cables; messengers; surge-protection wires; grounded guys; ungrounded guys exposed to 0 to 300 V [Ⓜ] ; neutral conductors meeting Rule 230E1; supply cables meeting Rule 230C1 (m)	Supply cables of 0 to 750 V meeting Rule 230C2 or 230C3 (m)	Unguarded rigid live parts, 0 to 750 V; noninsulated communication conductors; ungrounded equipment cases, 0 to 750 V; and ungrounded guys exposed to open supply conductors of over 300 V [Ⓜ] to 750 V (m)	Supply cables over 750 V meeting Rule 230C2 or 230C3; open supply conductors, 0 to 750 V (m) [Ⓜ]	Unguarded rigid live parts, over 750 V to 22 kV; ungrounded equipment cases, 750 V to 22 kV; ungrounded guys exposed to over 750 V [Ⓜ] to 22 kV (m)	Open supply conductors, over 750 V to 22 kV (m)
(1) Over or under catwalks and other surfaces upon which personnel walk	3.2	3.4	3.4	3.5	4.0	4.1
(2) Over or under other portions of such installations [Ⓜ]	0.90	1.07	1.70	1.80 [Ⓜ]	2.30	2.45

Ⓜ Where building, sign, chimney, antenna, tank, or other installation does not require maintenance such as painting, washing, changing of sign letters, or other operations that would require persons to work or pass between wires, conductors, cables, or unguarded rigid live parts and structure, the clearance may be reduced by 0.60 m.

Ⓜ Where available space will not permit this value, the clearance may be reduced by 0.60 m wires, provided the wires, conductors, or cables, including splices and taps, and unguarded rigid live parts have a covering that provides sufficient dielectric strength to limit the likelihood of a short circuit in case of momentary contact with a structure or building.

Ⓜ A roof, balcony, or area is considered readily accessible to pedestrians if it can be casually accessed through a doorway, ramp, window, stairway, or permanently mounted ladder by a person on foot who neither exerts extraordinary physical effort nor employs tools or devices to gain entry. A permanently mounted ladder is not considered a means of access if its bottom rung is 2.45 m or more from the ground or other permanently installed accessible surface.

Ⓜ The required clearances shall be to the closest approach of motorized signs or moving portions of installations covered by Rule 234C.

Ⓜ Ungrounded guys and ungrounded portions of guys between guy insulators shall have clearances based on the highest voltage to which they may be exposed to a slack conductor or guy.

Ⓜ For the purpose of this rule, trucks are defined as any vehicle exceeding 2.45 m in height.

Ⓜ This clearance may be reduced to 75 mm for the grounded portions of guys.

Ⓜ Windows not designed to open may have the clearances permitted for walls and projections.

Ⓜ The clearance at rest shall be not less than the value shown in this table. Also, when the conductor or cable is displaced by wind, the clearance shall be not less than 1.07 m; see Rule 234C1b.

Ⓜ The clearance at rest shall be not less than the value shown in this table. Also, when the conductor or cable is displaced by wind, the clearance shall be not less than 1.40 m; see Rule 234C1b.

- ⑩ Where available space will not permit this value, the clearance may be reduced to 2.00 m for conductors limited to 8.7 kV to ground.
- ⑪ The clearance values shown in this table are computed by adding the applicable Mechanical and Electrical (M & E) value of Table A-1 to the applicable Reference Component of Table A-2b of Appendix A.
- ⑫ The anchor end of guys insulated in accordance with Rule 279 may have the same clearance as grounded guys.
- ⑬ For clearances above railings, walls, or parapets around balconies or roofs, use the clearances required for row 1b(1). For such clearances where an outside stairway exists, use the clearances required for row 2b(2).
- ⑭ Does not include neutral conductors meeting Rule 230E1.

ft

Table 234-1—

Clearance of wires, conductors, cables, and unguarded rigid live parts adjacent but not attached to buildings and other installations except bridges ⑮

(Voltages are phase to ground for effectively grounded circuits and those other circuits where all ground faults are cleared by promptly de-energizing the faulted section, both initially and following subsequent breaker operations. See the definitions section for voltages of other systems. Clearances are with no wind displacement except where stated in the footnotes below.
See Rules 234C1a, 234C2, and 234H4.)

Clearance of	Insulated communication conductors and cables; messengers; surge-protection wires; grounded guys; ungrounded guys exposed to 0 to 300 V ⑯; neutral conductors meeting Rule 230E1; supply cables meeting Rule 230C1 (ft)	Supply cables of 0 to 750 V meeting Rule 230C2 or 230C3 (ft)	Unguarded rigid live parts, 0 to 750 V; non-insulated communication conductors; ungrounded equipment cases, 0 to 750 V; ungrounded guys exposed to open supply conductors of over 300 V to 750 V ⑰ (ft)	Supply cables over 750 V meeting Rule 230C2 or 230C3; open supply conductors, 0 to 750 V (ft) ⑱	Unguarded rigid live parts, over 750 V to 22 kV; ungrounded equipment cases, 750 V to 22 kV; ungrounded guys exposed to over 750 V to 22 kV ⑲ (ft)	Open supply conductors, over 750 V to 22 kV (ft)
I. Buildings						
a. Horizontal						
(1) To walls, projections, and guarded windows	4.5 ^{①②⑦}	5.0 ^{①③}	5.0 ^{①②}	5.5 ^{①②③}	7.0 ^{①②}	7.5 ^{①②④⑩}
(2) To unguarded windows ①	4.5	5.0	5.0	5.5 ^①	7.0	7.5 ^{④⑩}
(3) To balconies and areas readily accessible to pedestrians ①	4.5	5.0	5.0	5.5 ^①	7.0	7.5 ^{④⑩}
b. Vertical ⑱						
(1) Over or under roofs or projections not readily accessible to pedestrians ①	3.0	3.5	10.0	10.5	12.0	12.5

ft

Table 234-1— (continued)

Clearance of wires, conductors, cables, and unguarded rigid live parts adjacent but not attached to buildings and other installations except bridges[®]

(Voltages are phase to ground for effectively grounded circuits and those other circuits where all ground faults are cleared by promptly de-energizing the faulted section, both initially and following subsequent breaker operations. See the definitions section for voltages of other systems. Clearances are with no wind displacement except where stated in the footnotes below.

See Rules 234C1a, 234C2, and 234H4.)

Clearance of	Insulated communication conductors and cables; messengers; surge-protection wires; grounded guys; ungrounded guys exposed to 0 to 300 V [®] ; neutral conductors meeting Rule 230E1; supply cables meeting Rule 230C1 (ft)	Supply cables of 0 to 750 V meeting Rule 230C2 or 230C3 (ft)	Unguarded rigid live parts, 0 to 750 V; non-insulated communication conductors; ungrounded equipment cases, 0 to 750 V; ungrounded guys exposed to open supply conductors of over 300 V to 750 V [®] (ft)	Supply cables over 750 V meeting Rule 230C2 or 230C3; open supply conductors, 0 to 750 V (ft) [®]	Unguarded rigid live parts, over 750 V to 22 kV; ungrounded equipment cases, 750 V to 22 kV; ungrounded guys exposed to over 750V to 22 kV [®] (ft)	Open supply conductors, over 750 V to 22 kV (ft)
(2) Over or under balconies and roofs readily accessible to pedestrians [®]	10.5	11.0	11.0	11.5	13.0	13.5
(3) Over roofs accessible to vehicles but not subject to truck traffic [®]	10.5	11.0	11.0	11.5	13.0	13.5
(4) Over roofs accessible to truck traffic [®]	15.5	16.0	16.0	16.5	18.0	18.5
2. Signs, chimneys, billboards, radio and television antennas, tanks, and other installations not classified as buildings or bridges						
a. Horizontal[®]						
(1) To portions that are readily accessible to pedestrians [®]	4.5	5.0	5.0 ^{①②}	5.5 ^①	7.0 ^{①②}	7.5 ^{⑥⑩}
(2) To portions that are not readily accessible to pedestrians [®]	3.0	3.5	5.0 ^{①②}	5.5 ^{①②④}	7.0 ^{①②}	7.5 ^{①②⑥⑩}
b. Vertical						

ft

Table 234-1— (continued)

Clearance of wires, conductors, cables, and unguarded rigid live parts adjacent but not attached to buildings and other installations except bridges^②

(Voltages are phase to ground for effectively grounded circuits and those other circuits where all ground faults are cleared by promptly de-energizing the faulted section, both initially and following subsequent breaker operations. See the definitions section for voltages of other systems. Clearances are with no wind displacement except where stated in the footnotes below.

See Rules 234C1a, 234C2, and 234H4.)

Clearance of	Insulated communication conductors and cables; messengers; surge-protection wires; grounded guys; ungrounded guys exposed to 0 to 300 V ^⑥ ; neutral conductors meeting Rule 230E1; supply cables meeting Rule 230C1 (ft)	Supply cables of 0 to 750 V meeting Rule 230C2 or 230C3 (ft)	Unguarded rigid live parts, 0 to 750 V; non-insulated communication conductors; ungrounded equipment cases, 0 to 750 V; ungrounded guys exposed to open supply conductors of over 300 V to 750 V ^⑥ (ft)	Supply cables over 750 V meeting Rule 230C2 or 230C3; open supply conductors, 0 to 750 V (ft) ^⑥	Unguarded rigid live parts, over 750 V to 22 kV; ungrounded equipment cases, 750 V to 22 kV; ungrounded guys exposed to over 750 V to 22 kV ^⑥ (ft)	Open supply conductors, over 750 V to 22 kV (ft)
(1) Over or under catwalks and other surfaces upon which personnel walk	10.5	11.0	11.0	11.5	13.0	13.5
(2) Over or under other portions of such installations ^④	3.0	3.5	5.5	6.0 ^⑦	7.5	8.0

①Where building, sign, chimney, antenna, tank, or other installation does not require maintenance such as painting, washing, changing of sign letters, or other operations that would require persons to work or pass between wires, conductors, cables or unguarded rigid live parts and structure, the clearance may be reduced by 2 ft.

②Where available space will not permit this value, the clearance may be reduced by 2 ft provided the wires, conductors, or cables, including splices and taps, and unguarded rigid live parts have a covering that provides sufficient dielectric strength to limit the likelihood of a short circuit in case of momentary contact with a structure or building.

③A roof, balcony, or area is considered readily accessible to pedestrians if it can be casually accessed through a doorway, ramp, window, stairway, or permanently mounted ladder by a person on foot who neither exerts extraordinary physical effort nor employs tools or devices to gain entry. A permanently mounted ladder is not considered a means of access if its bottom rung is 8 ft or more from the ground or other permanently installed accessible surface.

④The required clearances shall be to the closest approach of motorized signs or moving portions of installations covered by Rule 234C.

⑤Ungrounded guys and ungrounded portion of guys between guy insulators shall have clearances based on the highest voltage to which they may be exposed to a slack conductor or guy.

⑥For the purpose of this rule, trucks are defined as any vehicle exceeding 8 ft in height.

⑦This clearance may be reduced to 3 in for the grounded portions of guys.

⑧Windows not designed to open may have the clearances permitted for walls and projections.

⑨The clearance at rest shall be not less than the value shown in this table. Also, when the conductor or cable is displaced by wind, the clearance shall be not less than 3.5 ft; see Rule 234C1b.

⑩The clearance at rest shall be not less than the value shown in this table. Also, when the conductor or cable is displaced by wind, the clearance shall be not less than 4.5 ft; see Rule 234C1b.

⑪Where available space will not permit this value, the clearance may be reduced to 7.0 ft for conductors limited to 8.7 kV to ground.

- Ⓜ The clearance values shown in this table are computed by adding the applicable Mechanical and Electrical (M & E) value of Table A-1 to the applicable Reference Component of Table A-2b of Appendix A.
- Ⓝ The anchor end of guys insulated in accordance with Rule 279 may have the same clearance as grounded guys.
- Ⓞ For clearances above railings, walls, or parapets around balconies or roofs, use the clearances required for row 1b(1). For such clearances where an outside stairway exists, use the clearances required for row 2b(2).
- Ⓟ Does not include neutral conductors meeting Rule 230E1.

m

Table 234-2—

Clearance of wires, conductors, cables, and unguarded rigid live parts from bridges

(Voltages are phase to ground for effectively grounded circuits and those other circuits where all ground faults are cleared by promptly de-energizing the faulted section, both initially and following subsequent breaker operations. See the definitions section for voltages of other systems. Clearances are with no wind displacement except where stated in the footnotes below.

See Rules 234D1a and 234H4.)

	Unguarded rigid live parts, 0 to 750 V; noninsulated communication conductors; supply cables of 0 to 750 V meeting Rule 230C2 or 230C3 [Ⓜ] ; ungrounded equipment cases, 0 to 750 V; ungrounded guys exposed to open supply conductors over 300 V to 750 V [Ⓞ] (m)	Supply cables over 750 V meeting Rule 230C2 or 230C3 [Ⓜ] ; open supply conductors, 0 to 750 V (m) [Ⓟ]	Open supply conductors, over 750 V to 22 kV (m)	Unguarded rigid live parts, over 750 V to 22 kV, ungrounded equipment cases, 750 V to 22 kV; ungrounded guys exposed to open supply conductors of over 750 V to 22 kV [Ⓞ] (m)
1. Clearance over bridges [Ⓜ]				
a. Attached [Ⓜ]	0.90	1.07	1.70	1.50
b. Not attached	3.0	3.2	3.8	3.6
2. Clearance beside, under, [Ⓞ] or within bridge structure [Ⓞ]				
a. Readily accessible portions of any bridge including wing, walls, and bridge attachments [Ⓜ]				
(1) Attached [Ⓜ]	0.90	1.07 [Ⓞ]	1.70 [Ⓞ]	1.50
(2) Not attached	1.50	1.70 [Ⓞ]	2.30 [Ⓞ]	2.00
b. Ordinarily inaccessible portions of bridges (other than brick, concrete, or masonry) and from abutments [Ⓞ]				
(1) Attached [Ⓜ] Ⓞ	0.90	1.07 [Ⓞ]	1.70 [Ⓞ]	1.50
(2) Not attached [Ⓞ] Ⓞ	1.20	1.40 [Ⓞ]	2.00 [Ⓞ]	1.80

- ① Where over traveled ways on or near bridges, the clearances of Rule 232 apply also.
- ② Bridge seats of steel bridges carried on masonry, brick, or concrete abutments that require frequent access for inspection shall be considered as readily accessible portions.
- ③ Clearance from supply conductors to supporting arms and brackets attached to bridges shall be the same as specified in Table 235-6 (Rule 235E1) if the supporting arms and brackets are owned, operated, or maintained by the same utility.
- ④ Ungrounded guys and ungrounded portions of guys between guy insulators shall have clearances based on the highest voltage to which they may be exposed due to a slack conductor or guy.
- ⑤ Where conductors passing under bridges are adequately guarded against contact by unauthorized persons and can be de-energized and grounded per Rule 444D for maintenance of the bridge, clearances of the conductors from the bridge, at any point, may have the clearances specified in Table 235-6 for clearance from surfaces of support arms plus one-half the final unloaded sag of the conductor at that point.
- ⑥ Where the bridge has moving parts, such as a lift bridge, the required clearances shall be maintained throughout the full range of movement of the bridge or any attachment thereto.
- ⑦ Where permitted by the bridge owner, supply cables may be run in rigid conduit attached directly to the bridge. Refer to Part 3 for installation rules.
- ⑧ The clearance at rest shall be not less than the value shown in this table. Also, when the conductor or cable is displaced by wind, the clearance shall be not less than 1.07 m; see Rule 234D1b.
- ⑨ The clearance at rest shall be not less than the value shown in this table. Also, when the conductor or cable is displaced by wind, the clearance shall be not less than 1.40 m; see Rule 234D1b.
- ⑩ Does not include neutral conductors meeting Rule 230E1.

ft

Table 234-2—

Clearance of wires, conductors, cables, and unguarded rigid live parts from bridges

(Voltages are phase to ground for effectively grounded circuits and those other circuits where all ground faults are cleared by promptly de-energizing the faulted section, both initially and following subsequent breaker operations. See the definitions section for voltages of other systems. Clearances are with no wind displacement except where stated in the footnotes below.

See Rules 234D1a and 234H4.)

	Unguarded rigid live parts, 0 to 750 V; noninsulated communication conductors; supply cables of 0 to 750 V meeting Rule 230C2 or 230C3 ^① , ungrounded equipment cases, 0 to 750 V; ungrounded guys exposed to open supply conductors over 300 V to 750 V ^① (ft)	Supply cables over 750 V meeting Rule 230C2 or 230C3 ^① ; open supply conductors, 0 to 750 V (ft) ^②	Open supply conductors, over 750 V to 22 kV (ft)	Unguarded rigid live parts, over 750 V to 22 kV, ungrounded equipment cases, 750 V to 22 kV; ungrounded guys exposed to open supply conductors of over 750 V to 22 kV ^③ (ft)
1. Clearance over bridges ^①				
a. Attached ^①	3.0	3.5	5.5	5.0
b. Not attached	10.0	10.5	12.5	12.0
2. Clearance beside, under, or within bridge structure ^②				

ft

Table 234-2— (continued)

Clearance of wires, conductors, cables, and unguarded rigid live parts from bridges
(Voltages are phase to ground for effectively grounded circuits and those other circuits where all ground faults are cleared by promptly de-energizing the faulted section, both initially and following subsequent breaker operations. See the definitions section for voltages of other systems. Clearances are with no wind displacement except where stated in the footnotes below.

See Rules 234D1a and 234H4.)

	Unguarded rigid live parts, 0 to 750 V; noninsulated communication conductors; supply cables of 0 to 750 V meeting Rule 230C2 or 230C3 ^① , ungrounded equipment cases, 0 to 750 V; ungrounded guys exposed to open supply conductors over 300 V to 750 V ^④ (ft)	Supply cables over 750 V meeting Rule 230C2 or 230C3 ^② ; open supply conductors, 0 to 750 V (ft) ^⑤	Open supply conductors, over 750 V to 22 kV (ft)	Unguarded rigid live parts, over 750 V to 22 kV, ungrounded equipment cases, 750 V to 22 kV; ungrounded guys exposed to open supply conductors of over 750 V to 22 kV ^⑥ (ft)
a. Readily accessible portions of any bridge including wing, walls, and bridge attachments ^⑦				
(1) Attached ^⑧	3.0	3.5 ^⑧	5.5 ^⑧	5.0
(2) Not attached	5.0	5.5 ^⑧	7.5 ^⑧	7.0
b. Ordinarily inaccessible portions of bridges (other than brick, concrete, or masonry) and from abutments ^⑨				
(1) Attached ^{⑧ ⑩}	3.0	3.5 ^⑧	5.5 ^⑧	5.0
(2) Not attached ^{⑧ ⑩}	4.0	4.5 ^⑧	6.5 ^⑧	6.0

①Where over traveled ways on or near bridges, the clearances of Rule 232 apply also.

②Bridge seats of steel bridges carried on masonry, brick, or concrete abutments that require frequent access for inspection shall be considered as readily accessible portions.

③Clearance from supply conductors to supporting arms and brackets attached to bridges shall be the same as specified in Table 235-6 (Rule 235E1) if the supporting arms and brackets are owned, operated, or maintained by the same utility.

④Ungrounded guys and ungrounded portions of guys between guy insulators shall have clearances based on the highest voltage to which they may be exposed due to a slack conductor or guy.

⑤Where conductors passing under bridges are adequately guarded against contact by unauthorized persons and can be de-energized and grounded per Rule 444D for maintenance of the bridge, clearances of the conductors from the bridge, at any point, may have the clearances specified in Table 235-6 for clearance from surfaces of support arms plus one-half the final unloaded sag of the conductor at that point.

⑥Where the bridge has moving parts, such as a lift bridge, the required clearances shall be maintained throughout the full range of movement of the bridge or any attachment thereto.

⑦Where permitted by the bridge owner, supply cables may be run in rigid conduit attached directly to the bridge. Refer to Part 3 for installation rules.

- ⓐ The clearance at rest shall be not less than the value shown in this table. Also, when the conductor or cable is displaced by wind, the clearance shall be not less than 3.5 ft; see Rule 234D1b.
- ⓑ The clearance at rest shall be not less than the value shown in this table. Also, when the conductor or cable is displaced by wind, the clearance shall be not less than 4.5 ft; see Rule 234D1b.
- ⓒ Does not include neutral conductors meeting Rule 230E1.

Table 234-3—Clearance of wires, conductors, cables, or unguarded rigid live parts over or near swimming pools [ⓓ]

(Voltages are phase to ground for effectively grounded circuits and those other circuits where all ground faults are cleared by promptly de-energizing the faulted section, both initially and following subsequent breaker operations. See the definitions section for voltages of other systems.

Clearances are with no wind displacement.

See Rules 234E1, 234E2, and 234H4.)

	Insulated communication conductors and cables; messengers; surge-protection wires; grounded guys; ungrounded guys exposed to 0 to 300 V [ⓔ] ; neutral conductors meeting Rule 230E1; supply cables meeting Rule 230C1 (m)	Unguarded rigid live parts, 0 to 750 V; noninsulated communication conductors; supply cables of 0 to 750 V meeting Rule 230C2 or 230C3; ungrounded guys exposed to open supply conductors of over 300 V to 750 V [ⓔ] (m)	Supply cables over 750 V meeting Rule 230C2 or 230C3; open supply conductors, 0 to 750 V (m) [ⓔ]	Unguarded rigid live parts over 750 V to 22 kV; ungrounded guys exposed to over 750 V to 22 kV [ⓔ] (m)	Open supply conductors, over 750 V to 22 kV (m)
A. Clearance in any direction from the water level, edge of pool, base of diving platform, or anchored raft	6.7	6.9	7.0	7.5	7.6
B. Clearance in any direction to the diving platform, tower, water slide, or other fixed, pool-related structures	4.3	4.4	4.6	5.1	5.2
V. Vertical clearance over adjacent land	Clearance shall be as required by Rule 232.				

NOTE: A, B, and V are shown in Figure 234-3.

- ⓐ The clearance values shown in this table are computed by adding the applicable Mechanical and Electrical (M & E) value of Table A-1 to the applicable Reference Component of Table A-2b of Appendix A.
- ⓑ Ungrounded guys and ungrounded portions of guys between guy insulators shall have clearances based on the highest voltage to which they may be exposed due to a slack conductor or guy.
- ⓒ Anchor guys insulated in accordance with Rule 279 may have the same clearance as grounded guys.
- ⓓ Does not include neutral conductors meeting Rule 230E1.

ft

Table 234-3—Clearance of wires, conductors, cables, or unguarded rigid live parts over or near swimming pools ①

(Voltages are phase to ground for effectively grounded circuits and those other circuits where all ground faults are cleared by promptly de-energizing the faulted section, both initially and following subsequent breaker operations. See the definitions section for voltages of other systems.

Clearances are with no wind displacement.

See Rules 234E1, 234E2, and 234H4.)

	Insulated communication conductors and cables; messengers; surge-protection wires; grounded guys; ungrounded guys exposed to 0 to 300 V ②; neutral conductors meeting Rule 230E1; supply cables meeting Rule 230C1 (ft)	Unguarded rigid live parts, 0 to 750 V; noninsulated communication conductors; supply cables of 0 to 750 V meeting Rule 230C2 or 230C3; ungrounded guys exposed to open supply conductors of over 300 V to 750 V ② (ft)	Supply cables over 750 V meeting Rule 230C2 or 230C3; open supply conductors, 0 to 750 V (ft) ②	Unguarded rigid live parts over 750 V to 22 kV; ungrounded guys exposed to over 750 V to 22 kV ② (ft)	Open supply conductors, over 750 V to 22 kV (ft)
A. Clearance in any direction from the water level, edge of pool, base of diving platform, or anchored raft	22.0	22.5	23.0	24.5	25.0
B. Clearance in any direction to the diving platform, tower, water slide, or other fixed, pool-related structures	14.0	14.5	15.0	16.5	17.0
V. Vertical clearance over adjacent land	Clearance shall be as required by Rule 232.				

NOTE: A, B, and V are shown in Figure 234-3.

①The clearance values shown in this table are computed by adding the applicable Mechanical and Electrical (M & E) value of Table A-1 to the applicable Reference Component of Table A-2b of Appendix A.

②Ungrounded guys and ungrounded portions of guys between insulators shall have clearances based on the highest voltage to which they may be exposed due to a slack conductor or guy.

③Anchor guys insulated in accordance with Rule 279 may have the same clearance as grounded guys.

④Does not include neutral conductors meeting Rule 230E1.

Table 234-4—
Electrical component of clearance of buildings, bridges, and other installations
 [Add 3% for each 300 m (1000 ft) in excess of 450 m (1500 ft) above mean sea level.
 See Rule 234H3a.]

Maximum operating voltage phase to phase (kV)	Switching-surge factor (per unit)	Switching surge (kV)	Electrical component of clearances			
			Vertical		Horizontal	
			(m)	(ft)	(m)	(ft)
242	2.0	395	0.84	2.8	0.70	2.3
	2.2	435	0.98	3.3	0.82	2.7
	2.4	474	1.14	3.8	0.95	3.1
	2.6	514	1.30	4.3	1.08	3.6
	2.8	553	1.47	4.8	1.22	4.0
	3.0	593	1.64	5.4	1.37	4.5
362	1.8	532	1.38	4.5	1.15	3.8
	2.0	591	1.6	5.4	1.37	4.5
	2.2	650	1.92	6.3	1.60	5.3
	2.4	709	2.22	7.3	1.85	6.1
	2.6	768	2.53	8.3	2.11	6.9
	2.8	828	2.87	9.4	2.39	7.9
550	3.0	887	3.3	10.6	2.68	8.8
	1.6	719	2.27	7.5	1.86	6.2
	1.8	808	2.76	9.1	2.30	7.6
	2.0	898	3.3	10.8	2.74	9.0
	2.2	988	3.9	12.7	3.3	10.5
	2.4	1079	4.5	14.6	3.8	12.2
800	2.6	1168	5.1	16.7	4.3	13.9
	1.6	1045	4.3	13.9	3.6	11.6
	1.8	1176	5.2	16.9	4.3	14.1
	2.0	1306	6.2	20.1	5.2	16.7
	2.2	1437	7.2	23.6	6.0	19.6
	2.4	1568	8.4	27.2	7.0	22.7

Table 234-5—Reference distances
(See Rule 234H2.)

Reference distance	Vertical		Horizontal	
	(m)	(ft)	(m)	(ft)
a. Buildings	2.70	9	0.90	3
b. Signs, chimneys, radio and television antennas, tanks, and other installations not classified as bridges or buildings	2.70	9	0.90	3
c. Superstructure of bridges ^{① ②}	2.70	9	0.90	3
d. Supporting structures of another line	1.80	6	1.50	5
e. Dimension A of Figure 234-3	5.5	18	—	—
f. Dimension B of Figure 234-3	4.3	14	4.3	14

①Where over traveled ways on or near bridges, the clearances of Rule 232 apply also.

②Where the bridge has moving parts, such as a lift bridge, the required clearances shall be maintained throughout the full range of movement of the bridge or any attachment thereto.

235. Clearance for wires, conductors, or cables carried on the same supporting structure

A. Application of rule

1. Multiconductor wires or cables

Cables, and duplex, triple, or paired conductors supported on insulators or messengers meeting Rule 230C or 230D, whether single or grouped, for the purposes of this rule are considered single conductors even though they may contain individual conductors not of the same phase or polarity.

2. Conductors supported by messengers or span wires

Clearances between individual wires, conductors, or cables supported by the same messenger, or between any group and its supporting messenger, or between a trolley feeder, supply conductor, or communication conductor, and their respective supporting span wires, are not subject to the provisions of this rule.

3. Line conductors of different circuits

a. Unless otherwise stated, the voltage between line conductors of different circuits shall be the greater of the following:

- (1) The phasor difference between the conductors involved

NOTE: A phasor relationship of 180° is considered appropriate where the actual phasor relationship is unknown.

- (2) The phase-to-ground voltage of the higher-voltage circuit

b. When the circuits have the same nominal voltage, either circuit may be considered to be the higher-voltage circuit.

B. Horizontal clearance between line conductors

1. Fixed supports

Line conductors attached to fixed supports shall have horizontal clearances from each other not less than the larger value required by either Rule 235B1a or 235B1b for the situation concerned. Voltage is between the two conductors for which the clearance is being determined except for railway feeders, which are to ground.

EXCEPTION 1: The pin spacing at buckarm construction may be reduced as specified in Rule 236F to provide climbing space.

EXCEPTION 2: Grade N need meet only the requirements of Rule 235B1a.

EXCEPTION 3: These clearances do not apply to cables meeting Rule 230C or covered conductors of the same circuit meeting Rule 230D.

EXCEPTION 4: For voltages to ground exceeding 98 kV ac or 139 kV dc, clearances less than those required by a and b below are permitted for systems with known maximum switching-surge factors. (See Rule 235B3.)

a. Horizontal clearance between line conductors of the same or different circuits

Clearances shall be not less than those given in Table 235-1.

b. Clearance according to sags

The clearance at the supports of line conductors of the same or different circuits of Grade B or C in no case shall be less than the values given by the following formulas, at a conductor temperature of 15 °C (60 °F), at final unloaded sag, no wind. For the purpose of this rule, the line conductor clearances are between the surfaces of the conductors only, not including armor rods, tie wires, or other fasteners. The requirements of Rule 235B1a apply if they give a greater clearance than this rule.

EXCEPTION: No requirement is specified for clearance between conductors of the same circuit when rated above 50 kV.

In the following, S is the apparent sag in millimeters of the conductor having the greater sag, and the clearance is in millimeters. Voltage (kV) is the voltage between the conductors.

(1) For line conductors smaller than AWG No. 2: clearance = $7.6 \text{ mm}/(\text{kV}) + 20.4\sqrt{S - 610}$. (Table 235-2 shows selected values up to 46 kV.)

(2) For line conductors of AWG No. 2 or larger: clearance = $7.6 \text{ mm}/(\text{kV}) + 8\sqrt{2.125S}$. (Table 235-3 shows selected values up to 46 kV.)

(3) For voltages exceeding 814 kV, the clearance shall be determined by the alternate method given by Rule 235B3.

(4) The clearance for voltages exceeding 50 kV specified in Rule 235B1b(1) and (2) shall be increased 3% for each 300 m in excess of 1000 m above mean sea level. All clearances for lines over 50 kV shall be based on the maximum operating voltage.

In the following, S is the apparent sag in inches of the conductor having the greater sag, and the clearance is in inches. Voltage (kV) is the voltage between the conductors.

(1) For line conductors smaller than AWG No. 2: clearance = $0.3 \text{ in}/(\text{kV}) + 4.04\sqrt{S - 24}$. (Table 235-2 shows selected values up to 46 kV.)

(2) For line conductors of AWG No. 2 or larger: clearance = $0.3 \text{ in}/(\text{kV}) + 8\sqrt{S/12}$. (Table 235-3 shows selected values up to 46 kV.)

(3) For voltages exceeding 814 kV, the clearance shall be determined by the alternate method given by Rule 235B3.

(4) The clearance for voltages exceeding 50 kV specified in Rule 235B1b(1) and (2) shall be increased 3% for each 1000 ft in excess of 3300 ft above mean sea level. All clearances for lines over 50 kV shall be based on the maximum operating voltage.

2. Suspension insulators

Where suspension insulators are used and are not restrained from movement, the clearance between conductors shall be increased so that one string of insulators may swing transversely throughout a range of insulator swing up to its maximum design swing angle without reducing the values given in Rule 235B1. The maximum design swing angle shall be based on a 290 Pa (6 lb/ft²) wind on the conductor at final sag at 15 °C (60 °F). This may be reduced to a 190 Pa (4 lb/ft²) wind in areas sheltered by buildings, terrains, or other obstacles. Trees are not considered to shelter a line. The displacement of the wires, conductors, and cables shall include deflection of flexible structures and fittings, where such deflection would reduce the horizontal clearance between two wires, conductors, or cables.

3. Alternate clearances for different circuits where one or both circuits exceed 98 kV ac to ground or 139 kV dc to ground

The clearances specified in Rules 235B1 and 235B2 may be reduced for circuits with known switching-surge factors but shall be not less than the clearances derived from the following computations. For these computations, communication conductors and cables, guys, messengers, neutral conductors meeting Rule 230E1, and supply cables meeting Rule 230C1 shall be considered line conductors at zero voltage.

a. Clearance

- (1) The alternate clearance shall be maintained under the expected loading conditions and shall be not less than the electrical clearance between conductors of different circuits computed from the following equation. For convenience, clearances for typical system voltages are shown in Table 235-4.

$$D = 1.00 \left[\frac{V_{L-L} \cdot (PU) \cdot a}{500K} \right]^{1.667} b \quad (\text{m})$$

$$D = 3.28 \left[\frac{V_{L-L} \cdot (PU) \cdot a}{500K} \right]^{1.667} b \quad (\text{ft})$$

where

V_{L-L} = maximum ac crest operating voltage in kilovolts between phases of different circuits or maximum dc operating voltage between poles of different circuits. If the phases are of the same phase and voltage magnitude, one phase conductor shall be considered grounded

PU = maximum switching-surge factor expressed in per-unit peak operating voltage between phases of different circuits and defined as a switching-surge level between phases for circuit breakers corresponding to 98% probability that the maximum switching surge generated per breaker operation does not exceed this surge level, or the maximum anticipated switching-surge level generated by other means, whichever is greater

a = 1.15, the allowance for three standard deviations

b = 1.03, the allowance for nonstandard atmospheric conditions

K = 1.4, the configuration factor for a conductor-to-conductor gap

- (2) The value of D shall be increased 3% for each 300 m (1000 ft) in excess of 450 m (1500 ft) above mean sea level.

b. Limit

The clearance derived from Rule 235B3a shall not be less than the basic clearances given in Table 235-1 computed for 169 kV ac.

C. Vertical clearance between line conductors

All line wires, conductors, and cables located at different levels on the same supporting structure shall have vertical clearances not less than the following:

1. Basic clearance for conductors of same or different circuits

a. Between supply lines of the same or different circuits

The clearance requirements given in Table 235-5 shall apply to supply line wires, conductors, or cables of 0 to 50 kV attached to supports. No value is specified for clearances between conductors of the same circuit exceeding 50 kV, between cables meeting Rule 230C3 and neutral conductors meeting Rule 230E1 of the same utility, or between ungrounded open supply conductors 0 to 50 kV of the same phase and circuit of the same utility.

b. Between supply lines and communication lines

The clearance requirements given in Table 235-5 shall apply.

c. Between communication lines located in the communication space

The clearance and spacing requirements of Rule 235H shall apply to communication lines located in the communication space.

d. Between communication lines located in the supply space

The clearance requirements of Table 235-5 shall apply to communication lines located in the supply space.

EXCEPTION 1: Line wires, conductors, or cables on vertical racks or separate brackets placed vertically and meeting the requirements of Rule 235G may have spacings as specified in that rule.

EXCEPTION 2: Where communication service drops cross under supply conductors on a common crossing structure, the clearance between the communication conductor and an effectively grounded supply conductor may be reduced to 100 mm (4 in) provided the clearance between the communication conductor and supply conductors not effectively grounded meets the requirements of Rule 235C as appropriate.

EXCEPTION 3: Supply service drops of 0 to 750 V running above and parallel to communication service drops may have a clearance of not less than 300 mm (12 in) at any point in the span including the point of their attachment to the building or structure being served provided that the nongrounded conductors are insulated and that the clearance as otherwise required by this rule is maintained between the two service drops at the pole.

EXCEPTION 4: This rule does not apply to conductors of the same circuit meeting Rule 230D.

2. Additional clearances

Greater clearances than those required (by Rule 235C1) and given in Table 235-5 shall be provided under the following conditions. The increases are cumulative where more than one is applicable.

a. Voltage related clearances

- (1) For voltages between 50 and 814 kV, the clearance between line wires, conductors, or cables of different circuits shall be increased 10 mm (0.4 in) per kilovolt in excess of 50 kV.

EXCEPTION: For voltages to ground exceeding 98 kV ac or 139 kV dc, clearances less than those required above are permitted for systems with known switching-surge factors. (See Rule 235C3.)

EXAMPLES: Calculations of clearances required by Rule 235C2a for a 69.7 kV maximum operating voltage phase-to-ground conductor above a 7.2 kV phase-to-ground conductor, assuming conductors are 180° out of phase.

Rule 235C2a: Clearance required at support

(a) Same utility [basic clearance = 0.41 m (16 in)]:

SI units: $\{0.41 + [(50 - 8.7) \times 0.01]\} + [(69.7 + 7.2 - 50) \times 0.01] = 1.09$ m. No rounding required in this example.

Customary units: $\{16.0 + [(50 - 8.7) \times 0.4]\} + [(69.7 + 7.2 - 50) \times 0.4] = 43.3$ in. Round up to 44 in.

(b) Different utilities [basic clearance = 1.00 m (40 in)]:

SI units: $\{1.00 + [(50 - 8.7) \times 0.01]\} + [(69.7 + 7.2 - 50) \times 0.01] = 1.68$ m. No rounding required in this example.

Customary units: $\{40.0 + [(50 - 8.7) \times 0.4]\} + [(69.7 + 7.2 - 50) \times 0.4] = 67.3$ in. Round up to 68 in.

- (2) The increase in clearance for voltages in excess of 50 kV specified in Rule 235C2a(1) shall be increased 3% for each 300 m (1000 ft) in excess of 1000 m (3300 ft) above mean sea level.
- (3) All clearances for lines over 50 kV shall be based on the maximum operating voltage.
- (4) No value is specified for clearances between conductors of the same circuit.

b. Sag-related clearances

- (1) Line wires, conductors, and cables supported at different levels on the same structures shall have vertical clearances at the supporting structures so adjusted that the clearance at any point in the span shall be not less than any of the following:

- (a) For voltages less than 50 kV between conductors, 75% of that required at the supports by Table 235-5.

EXCEPTION 1: Neutral conductors meeting Rule 230E1, fiber-optic supply cables meeting Rule 230F1a or 230F1b, insulated communication cables located in the supply space and supported by an effectively grounded messenger, and supply cables meeting Rule 230C1 (including their support brackets) in the supply space running above and parallel to communication cables in the communications space where the supply neutral or messenger is bonded to the communication messenger at intervals specified in Rule 92C, may have a clearance of 300 mm (12 in) at any point in the span provided that a clearance of 0.75 m (30 in) is maintained between the supply space conductors and cables and the communication space cables at the supporting poles. Bonding is not required for entirely dielectric cables meeting Rule 230F1b.

EXCEPTION 2: When all parties involved are in agreement, for supply conductors of different utilities, vertical clearance at any point in the span need not exceed 75% of the values required at the supports for the same utility by Table 235-5.

- (b) For voltages more than 50 kV between conductors, use the value as calculated by the following appropriate formula:

If the basic value is 0.41 m (16 in): 0.62 m (24.4 in) plus 10 mm (0.4 in) per kV in excess of 50 kV.

If the basic value is 1.0 m (40 in): 1.08 m (42.4 in) plus 10 mm (0.4 in) per kV in excess of 50 kV.

EXAMPLES: Calculations of clearances required by Rule 235C2b(1)(b) for a 69.7 kV maximum operating voltage phase-to-ground conductor above a 7.2 kV phase-to-ground conductor, assuming conductors are 180 degrees out of phase.

Rule 235C2b(1)(b): Clearance required at any point in the span

(i) Same utility [basic clearance = 0.41 m (16 in)]:

SI units: $\{0.41 + [(50 - 8.7) \times 0.01]\} \times 0.75 + [(69.7 + 7.2 - 50) \times 0.01] = 0.89$ m. No rounding required in this example.

Customary units: $\{16.0 + [(50 - 8.7) \times 0.4]\} \times 0.75 + [(69.7 + 7.2 - 50) \times 0.4] = 35.2$ in. Round up to 36 in.

(ii) Different utilities [basic clearance = 1.00 m (40 in)]:

SI units: $\{1.00 + [(50 - 8.7) \times 0.01]\} \times 0.75 + [(69.7 + 7.2 - 50) \times 0.01] = 1.33$ m. No rounding required in this example.

Customary units: $\{40.0 + [(50 - 8.7) \times 0.4]\} \times 0.75 + [(69.7 + 7.2 - 50) \times 0.4] = 53.2$ in. Round up to 54 in.

(c) For purposes of this determination the vertical clearances required in Rule 235C2b(1)(a) and (b) apply to the following conductor temperature and loading conditions whichever produces the greater vertical clearance at the structure when:

- i. The upper conductor is at final sag at 120 °F or the maximum operating temperature for which the line is designed to operate and the lower conductor is at final sag at the same ambient conditions as the upper conductor without electrical loading, or
- ii. The upper conductor is at final sag at 32 °F with the radial thickness of ice, if any, specified in Table 230-1 for the zone concerned and the lower conductor is at final sag at the same ambient conditions as the upper conductor without electrical loading, and without ice loading.

EXCEPTION: Rule 235C2b(1)(c) does not apply to conductors of the same utility when the conductors are the same size and type, and are installed at the same sag and tension. However, where experience in an area has shown that different ice conditions do occur between the upper and lower conductors, then Rule 235C2b(1)(c)ii shall apply.

(2) Sags should be readjusted when necessary to accomplish the foregoing, but not reduced sufficiently to conflict with the requirements of Rule 261H1. In cases where conductors of different sizes are strung to the same sag for the sake of appearance or to maintain unreduced clearance throughout storms, the chosen sag should be such as will keep the smallest conductor involved in compliance with the sag requirements of Rule 261H1.

(3) For span lengths in excess of 45 m (150 ft), vertical clearance at the structure between open supply conductors and communication cables or conductors shall be adjusted so that under conditions of conductor temperature of 15 °C (60 °F), no wind displacement and final unloaded sag, no open supply conductor of over 750 V but less than 50 kV shall be lower in the span than a straight line joining the points of support of the highest communication cable or conductor.

EXCEPTION: Effectively grounded supply conductors associated with systems of 50 kV or less need meet only the provisions of Rule 235C2b(1).

3. Alternate clearances for different circuits where one or both exceed 98 kV ac, or 139 kV dc to ground

The clearances specified in Rules 235C1 and 235C2 may be reduced for circuits with known switching-surge factors, but shall not be less than the crossing clearances required by Rule 233C3.

4. Communication worker safety zone

The clearances specified in Rules 235C and 238 create a communication worker safety zone between the facilities located in the supply space and facilities located in the communication space, both at the structure and in the span between structures. Except as allowed by Rules 238C, 238D, and 239, no supply or communication facility shall be located in the communication worker safety zone.

- D. Diagonal clearance between line wires, conductors, and cables located at different levels on the same supporting structure

No wire, conductor, or cable may be closer to any other wire, conductor, or cable than defined by the dashed line in Figure 235-1, where V and H are determined in accordance with other parts of Rule 235.

- E. Clearances in any direction from line conductors to supports, and to vertical or lateral conductors, span, or guy wires attached to the same support

1. Fixed supports

Clearances shall be not less than those given in Table 235-6.

NOTE 1: For clearances in any direction from supply line conductors to communication antennas in the supply space attached to the same supporting structure, see Rule 235I.

NOTE 2: For antennas in the communication space, see Rule 236D1.

EXCEPTION: For voltages exceeding 98 kV ac to ground or 139 kV dc to ground, clearances less than those required by Table 235-6 are permitted for systems with known switching-surge factor. (See Rule 235E3.)

2. Suspension insulators

Where suspension insulators are used and are not restrained from movement, the clearance shall be increased so that the string of insulators may swing transversely throughout a range of insulator swing up to its maximum design swing angle without reducing the values given in Rule 235E1. The maximum design swing angle shall be based on a 290 Pa (6 lb/ft²) wind on the conductor at final sag at 15 °C (60 °F). This may be reduced to a 190 Pa (4 lb/ft²) wind in areas sheltered by buildings, terrain, or other obstacles. Trees are not considered to shelter a line. The displacement of the wires, conductors, and cables shall include deflection of flexible structures and fittings, where such deflection would reduce the clearance.

3. Alternate clearances for voltages exceeding 98 kV ac to ground or 139 kV dc to ground

The clearances specified in Rules 235E1 and 235E2 may be reduced for circuits with known switching-surge factors but shall not be less than the following:

- a. Alternate clearances to anchor guys, surge-protection wires, and vertical or lateral conductors

The alternate clearances shall be not less than the crossing clearances required by Rule 233B2 and Rules 233C3a and 233C3b for the conductor voltages concerned. For the purpose of this rule, anchor guys and surge-protection wires shall be assumed to be at ground potential. The limits of Rule 235E3b(2) shall apply to the clearance derived from Rules 233C3a and 233C3b.

- b. Alternate clearance to surface of support arms and structures

(1) Alternate clearance

(a) Basic computation

The alternate clearances shall be maintained under the expected loading conditions and shall be not less than the electrical clearances computed from the following equation. For convenience, clearances for typical system voltages are shown in Table 235-7.

$$D = 1.00 \left[\frac{V \cdot (PU) \cdot a}{500K} \right]^{1.667} b \quad (\text{m})$$

$$D = 39.37 \left[\frac{V \cdot (PU) \cdot a}{500K} \right]^{1.667} b \quad (\text{in})$$

where

V = maximum ac crest operating voltage to ground or maximum dc operating voltage to ground in kilovolts

PU = maximum switching-surge factor expressed in per-unit peak voltage to ground and defined as a switching-surge level for circuit breakers corresponding to 98% probability that the maximum switching surge generated per breaker operation does not exceed this surge level, or the maximum anticipated switching-surge level generated by other means, whichever is greater

a = 1.15, the allowance for three standard deviations with fixed insulator supports

= 1.05, the allowance for one standard deviation with free-swinging manipulators

b = 1.03, the allowance for nonstandard atmospheric conditions

K = 1.2, the configuration factor for conductor-to-tower window

(b) Atmospheric correction

The value of D shall be increased 3% for each 300 m (1000 ft) in excess of 450 m (1500 ft) above mean sea level.

(2) Limits

The alternate clearance shall not be less than the clearance of Table 235-6 for 169 kV ac. The alternate clearance shall be checked for adequacy of clearance to workers and increased, if necessary, where work is to be done on the structure while the circuit is energized. (Also see Part 4.)

F. Clearances between circuits of different voltage classifications located in the supply space on the same support arm

Circuits of any one voltage classification (0 to 750 V, over 750 V to 8.7 kV, over 8.7 kV to 22 kV, and over 22 kV to 50 kV) may be maintained in the supply space on the same support arm with supply circuits of the next consecutive voltage classification only under one or more of the five following conditions. For purposes of these determinations, a neutral conductor shall be considered as having the same voltage classification as the circuit with which it is associated:

1. If they occupy positions on opposite sides of the structure
2. If in bridge-arm or sidearm construction, the clearance is not less than the climbing space required for the higher voltage concerned and provided for in Rule 236
3. If the higher-voltage conductors occupy the outer positions and the lower-voltage conductors occupy the inner positions
4. If series lighting or similar supply circuits are ordinarily dead during periods of work on or above the support arm concerned
5. If the two circuits concerned are communication circuits (located in the supply space in accordance with Rule 224A), or one circuit is such a communication circuit and the other is a supply circuit of less than 8.7 kV, provided they are installed as specified in Rule 235F1 or 235F2

G. Conductor spacing: vertical racks or separate brackets

Conductors or cables may be carried on vertical racks or separate brackets other than wood placed vertically on one side of the structure and securely attached thereto with less clearance between the wires, conductors, or cables than specified in Rule 235C if all the following conditions are met:

1. All wires, conductors, and cables are owned and maintained by the same utility, unless by agreement between all parties involved.
2. The voltage shall be not more than 750 V, except supply cables and conductors meeting Rule 230C1 or 230C2, which may carry any voltage.

3. Conductors shall be arranged so that the vertical spacing shall be not less than that specified in Table 235-8 under the conditions specified in Rule 235C2b(1)(c)
 4. A supporting neutral conductor of a supply cable meeting Rule 230C3 or an effectively grounded messenger of a supply cable meeting Rule 230C1 or 230C2 may attach to the same insulator or bracket as a neutral conductor meeting Rule 230E1, so long as the clearances of Table 235-8 are maintained in mid-span and the insulated energized conductors are positioned away from the open supply neutral at the attachment.
- H. Clearance and spacing between communication conductors, cables, and equipment
1. The spacing between messengers supporting communication cables should be not less than 300 mm (12 in) except by agreement between the parties involved.
 2. The clearances between the conductors, cables, and equipment of one communication utility to those of another, anywhere in the span, shall be not less than 100 mm (4 in), except by agreement between the parties involved.
- I. Clearances in any direction from supply line conductors to communication antennas in the supply space attached to the same supporting structure
1. General
Communication antennas located in the supply space shall be installed and maintained only by personnel authorized and qualified to work in the supply space in accordance with the applicable rules of Sections 42 and 44. See also Rule 224A.
 2. Communication antenna
The clearance between a communication antenna operated at a radio frequency of 3 kHz to 300 GHz and a supply line conductor shall be not less than the value given in Table 235-6, row 1b.
NOTE 1: The antenna functions as a rigid, vertical, or lateral open wire communication conductor.
NOTE 2: See Rule 420Q.
 3. Equipment case that supports a communication antenna
The clearance between an equipment case that supports a communication antenna and a supply line conductor shall be not less than the value given in Table 235-6, Row 4a.
 4. Vertical or lateral communication conductors and cables attached to a communication antenna
The clearance between a supply line conductor and the vertical or lateral communication conductor and cable attached to a communication antenna shall be not less than the value given in Rule 239.

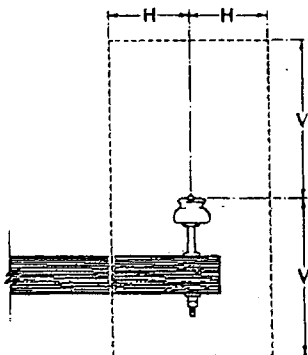

V = Vertical clearance
H = Horizontal clearance

Figure 235-1—Clearance diagram for energized conductor

Table 235-1—Horizontal clearance between wires, conductors, or cables at supports

(All voltages are between conductors involved except for railway feeders, which are to ground.)

See also Rules 235A, 235B3b, and 235B1a.)

Class of circuit	Clearance		Notes
	(mm)	(in)	
Open communication conductors	150	6	Does not apply at conductor transposition points.
	75	3	Permitted where pin spacings less than 150 mm (6 in) have been in regular use. Does not apply at conductor transposition points.
Railway feeders: 0 to 750 V, AWG No. 4/0 or larger 0 to 750 V, smaller than AWG No. 4/0 Over 750 V to 8.7 kV	150 300 300	6 12 12	Where 250 to 300 mm (10 to 12 in) clearance has already been established by practice, it may be continued, subject to the provisions of Rule 235B1b, for conductors having apparent sags not over 900 mm (3 ft) and for voltages not exceeding 8.7 kV.
Supply conductors of the same circuit: 0 to 8.7 kV Over 8.7 to 50 kV Above 50 kV	300 300 plus 10 per kV in excess of 8.7 kV No value specified	12 12 plus 0.4 per kV in excess of 8.7 kV No value specified	
Supply conductors of different circuits: 0 to 8.7 kV Over 8.7 to 50 kV Over 50 kV to 814 kV	300 300 plus 10 per kV in excess of 8.7 kV 725 plus 10 per kV over 50 kV	12 12 plus 0.4 per kV in excess of 8.7 kV 28.5 plus 0.4 per kV over 50 kV	For all voltages above 50 kV, the additional clearance shall be increased 3% for each 300 m (1000 ft) in excess of 1000 m (3300 ft) above mean sea level. All clearances for voltages above 50 kV shall be based on the maximum operating voltage.

m

**Table 235-2—Horizontal clearances between line conductors smaller than
AWG No. 2 at supports, based on sags**
(See also Rule 235B1b.)

Voltage between conductors (kV)	Sag (mm)							
	915	1220	1830	2440	3050	4570	6095	But not less than ^①
	Horizontal clearance (mm)							
2.4	375	525	735	895	1030	1305	1530	300
4.16	390	540	745	905	1040	1320	1545	300
12.47	455	600	810	970	1105	1380	1610	340
13.2	460	605	815	975	1100	1385	1615	345
13.8	465	610	820	980	1115	1390	1620	355
14.4	470	615	825	985	1120	1395	1625	360
24.94	550	695	905	1065	1200	1475	1705	465
34.5	620	770	975	1135	1270	1550	1775	560
46	710	855	1065	1225	1360	1635	1865	675

① Clearance determined by Table 235-1, Rule 235B1a.

NOTE: Clearance = $7.6 (kV) + 20.4 \sqrt{S} - 610$, where S is the sag in millimeters.

in

Table 235-2—Horizontal clearances between line conductors smaller than AWG No. 2 at supports, based on sags
(See also Rule 235B1b.)

Voltage between conductors (kV)	Sag (in)							
	36	48	72	96	120	180	240	But not less than [ⓐ]
	Horizontal clearance (in)							
2.4	15	21	29	36	41	52	61	12
4.16	16	22	30	36	41	52	61	12
12.47	18	24	32	39	44	55	64	14
13.2	18	24	32	39	44	55	64	14
13.8	19	24	33	39	44	55	64	15
14.4	19	25	33	39	44	55	64	15
24.94	22	28	36	42	48	58	67	19
34.5	25	31	39	45	50	61	70	23
46	28	34	42	49	54	65	74	27

[ⓐ]Clearance determined by Table 235-1, Rule 235B1a.

NOTE: Clearance = $0.3 (kV) + 4.04 \sqrt{S - 24}$, where S is the sag in inches.

m

Table 235-3—Horizontal clearances between line conductors AWG No. 2 or larger at supports, based on sags
(See also Rule 235B1b.)

Voltage between conductors (kV)	Sag (mm)							
	915	1220	1830	2440	3050	4570	6095	But not less than ^①
	Horizontal clearance (mm)							
2.4	375	430	520	595	665	810	930	300
4.16	385	440	530	610	675	820	945	300
12.47	450	505	595	675	740	885	1005	340
13.2	455	510	600	680	745	890	1010	345
13.8	460	515	605	685	750	895	1015	355
14.4	465	520	610	685	755	900	1020	360
24.94	545	600	690	765	835	980	1100	465
34.5	615	670	765	840	910	1050	1175	560
46	705	760	850	925	995	1140	1260	675

① Clearance determined by Table 235-1, Rule 235B1a.

NOTE: Clearance = $7.6 (kV) + 8\sqrt{2.12S}$, where S is the sag in millimeters.

in

Table 235-3—Horizontal clearances between line conductors AWG No. 2 or larger at supports, based on sags
(See also Rule 235B1b.)

Voltage between conductors (kV)	Sag (in)							
	36	48	72	96	120	180	240	But not less than [ⓐ]
	Horizontal clearance (in)							
2.4	15	17	21	24	27	32	37	12
4.16	16	18	21	24	27	33	38	12
12.47	18	20	24	27	30	35	40	14
13.2	18	20	24	27	30	35	40	14
13.8	18	21	24	27	30	36	40	15
14.4	19	21	24	27	30	36	41	15
24.94	22	24	28	31	33	39	44	19
34.5	25	27	30	33	36	42	47	23
46	28	30	34	37	40	45	50	27

[ⓐ]Clearance determined by Table 235-1, Rule 235B1a.

NOTE: Clearance = $0.3(kV) + 8\sqrt{S}/12$, where S is the sag in inches.

Table 235-4—Electrical clearances in Rule 235B3a(1)

[Add 3% for each 300 m (1000 ft) in excess of 450 m (1500 ft) above mean sea level.]

Maximum operating voltage phase to phase (kV)	Switching surge factor (per unit)	Switching surge (kV)	Electrical component of clearance	
			(m)	(ft)
242	2.6 or less	890 or less	1.94	
	2.8	958	2.20	
	3.0	1027	2.47	
	3.2 or more	1095 or more	2.65 ^①	
362	1.8	893 or less	2.06	
	2.0	1024	2.46	
	2.2	1126	2.88	
	2.4	1228	3.4	
	2.6	1330	3.8	
	2.7 or more	1382 or more	3.9 ^①	
550	1.6	1245	3.4	
	1.8	1399	4.2	
	2.0	1555	5.0	
	2.2	1711	5.8 ^①	
	2.3	1789 or more	5.8 ^①	
800	1.6	1810	6.4	
	1.8	2037	7.8	
	1.9 or more	2149 or more	8.3 ^②	

①Not used in this edition.

②Need not be greater than specified in Rules 235B1 and 235B2.

m

**Table 235-5—
Vertical clearance between conductors at supports**

(When using column and row headings, voltages are phase to ground for effectively grounded circuits and those other circuits where all ground faults are cleared by promptly de-energizing the faulted section, both initially and following subsequent breaker operations. When calculating clearance values within the table, all voltages are between the conductors involved. See the definitions section for voltages of other systems. See also Rules 235C1, 235C2, and 235F.)

Conductors and cables usually at lower levels	Conductors and cables usually at upper levels			
	Supply cables meeting Rule 230C1, 2, or 3; neutral conductors meeting Rule 230E1; communications cables meeting Rule 224A2 (m)	Open supply conductors		
		0 to 8.7 kV ^① (m)	Over 8.7 to 50 kV	
			Same utility ^⑦ (m)	Different utilities ^⑦ (m)
1. Communication conductors and cables				
a. Located in the communication space	1.00 ^{① ⑤}	1.00	1.00	1.00 plus 0.01 per kV ^⑥ in excess of 8.7 kV
b. Located in the supply space	0.41 ^{① ⑧}	0.41 ^⑧	1.00 ^⑧	1.00 plus 0.01 per kV ^⑥ in excess of 8.7 kV
2. Supply conductors and cables				
a. Open conductors 0 to 750 V; supply cables meeting Rule 230C1, 2, or 3; neutral conductors meeting Rule 230E1 ^⑧	0.41 ^④	0.41 ^②	0.41 plus 0.01 per kV ^⑥ in excess of 8.7 kV	1.00 plus 0.01 per kV ^⑥ in excess of 8.7 kV
b. Open conductors over 750 V to 8.7 kV		0.41 ^②	0.41 plus 0.01 per kV ^{④ ④} in excess of 8.7 kV	1.00 plus 0.01 per kV A ^④ in excess of 8.7 kV
c. Open conductors over 8.7 to 22 kV				
(1) If worked on energized with live-line tools and adjacent circuits are neither de-energized nor covered with shields or protectors			0.41 plus 0.01 per kV ^⑥	1.00 plus 0.01 per kV ^⑥

in

Table 235-5— (continued)
Vertical clearance between conductors at supports

(When using column and row headings, voltages are phase to ground for effectively grounded circuits and those other circuits where all ground faults are cleared by promptly de-energizing the faulted section, both initially and following subsequent breaker operations. When calculating clearance values within the table, all voltages are between the conductors involved. See the definitions section for voltages of other systems.

See also Rules 235C1, 235C2, and 235F.)

Conductors and cables usually at lower levels	Conductors and cables usually at upper levels			
	Supply cables meeting Rule 230C1, 2, or 3; neutral conductors meeting Rule 230E1; communications cables meeting Rule 224A2 (in)	Open supply conductors		
		0 to 8.7 kV ^⑧ (in)	Over 8.7 to 50 kV	
			Same utility ^⑦ (in)	Different utilities ^⑦ (in)
(2) If not worked on energized except when adjacent circuits (either above or below) are de-energized or covered by shields or protectors, or by the use of live-line tools not requiring line workers to go between live wires			16 plus $\frac{0.4}{3}$ per kV ^⑤ in excess of 8.7 kV	16 plus $\frac{0.4}{6}$ per kV ^⑥ in excess of 8.7 kV
d. Open conductors exceeding 22 kV, but not exceeding 50 kV			16 plus $\frac{0.4}{3}$ per kV ^⑤ in excess of 8.7 kV	40 plus $\frac{0.4}{6}$ per kV ^⑥ in excess of 8.7 kV

①Where supply circuits of 600 V or less, with transmitted power of 5000 W or less, are run below communication circuits in accordance with Rule 220B2, the clearance may be reduced to 16 in.

②Where conductors are operated by different utilities, a vertical clearance of not less than 40 in is recommended.

③These values do not apply to conductors of the same circuit or circuits being carried on adjacent conductor supports.

④May be reduced to 16 in where conductors are not worked on energized except when adjacent circuits (either above or below) are de-energized or covered by shields or protectors, or by the use of live line tools not requiring line workers to go between live wires.

⑤May be reduced to 30 in for supply neutrals meeting Rule 230E1, fiber-optic supply cables on an effectively grounded messenger meeting Rule 230F1a, entirely dielectric fiber-optic supply cables meeting Rule 230F1b, insulated communication cables located in the supply space and supported by an effectively grounded messenger, and cables meeting Rule 230C1 where the supply neutral or messenger is bonded to the communication messenger. Bonding is not required for entirely dielectric cables meeting Rule 230F1b.

⑥The greater of phasor difference or phase-to-ground voltage; see Rule 235A3.

⑦See examples of calculations in Rules 235C2a and 235C2b.

⑧Not used in this edition.

⑨No clearance is specified between neutral conductors meeting Rule 230E1 and insulated communication cables located in the supply space and supported by an effectively grounded messenger.

⑩No clearance is specified between fiber-optic supply cables meeting Rule 230F1b and supply cables and conductors.

⑪Does not include neutral conductors meeting Rule 230E1.

m

Table 235-6—
Clearance in any direction from line conductors to supports and to vertical or lateral conductors, span, or guy wires attached to the same support

[See also Rules 235E1, 235E3b(2), and 235I.]

Clearance of line conductors from	Communi- cation lines in general (mm)	Communi- cation lines on jointly used structures; neutral conductors meeting Rule 230E1 (mm)	Supply lines		
			Circuit phase-to-phase voltage		
			0 to 8.7 kV [ⓐ] (mm)	Over 8.7 to 50 kV (mm)	Over 50 to 814 kV ^{ⓐ ⓑ} (mm)
1. Vertical and lateral conductors:					
a. Of the same circuit	75	75	75	75 plus 6.5 per kV in excess of 8.7 kV	No value specified
b. Of other circuits ^{ⓐ ⓑ}	75	75	150 [ⓐ]	150 plus 10 per kV in excess of 8.7 kV	580 plus 10 per kV in excess of 50 kV
2. Span or guy wires,[ⓐ] or messengers attached to same structure:					
a. When parallel to line	75 [ⓑ]	150 ^{ⓐ ⓑ}	300 [ⓐ]	300 plus 10 per kV in excess of 8.7 kV	740 plus 10 per kV in excess of 50 kV
b. Anchor guys	75 [ⓑ]	150 ^{ⓐ ⓑ}	150 [ⓐ]	150 plus 6.5 per kV in excess of 8.7 kV	410 plus 6.5 per kV in excess of 50 kV
c. All other	75 [ⓑ]	150 ^{ⓐ ⓑ}	150	150 plus 10 per kV in excess of 8.7 kV	580 plus 10 per kV in excess of 50 kV
3. Surface of support arms	75 ^{ⓑ ⓐ}	75 ^{ⓑ ⓐ}	75 [ⓐ]	75 plus 5 per kV in excess of 8.7 kV ^{ⓐ ⓑ}	280 plus 5 per kV in excess of 50 kV

m

Table 235-6— (continued)
Clearance in any direction from line conductors to supports and to vertical or lateral conductors, span, or guy wires attached to the same support

[See also Rules 235E1, 235E3b(2), and 235I.]

Clearance of line conductors from	Communication lines in general (mm)	Communication lines on jointly used structures; neutral conductors meeting Rule 230E1 (mm)	Supply lines		
			Circuit phase-to-phase voltage		
			0 to 8.7 kV [ⓐ] (mm)	Over 8.7 to 50 kV (mm)	Over 50 to 814 kV [ⓐ] [ⓑ] (mm)
4. Surface of structures:					
a. On jointly used structures	—	125 [ⓐ] [ⓑ]	125 [ⓐ] [ⓑ]	125 plus 5 per kV in excess of 8.7 kV [ⓐ] [ⓑ]	330 plus 5 per kV in excess of 50 kV
b. All other	75 [ⓐ] [ⓑ]	—	75 [ⓐ]	75 plus 5 per kV in excess of 8.7 kV [ⓐ] [ⓑ]	280 plus 5 per kV in excess of 50 kV

ⓐFor guy wires, if practical. For clearances between span wires and communication conductors, see Rule 238C.

On jointly used structures, guys that pass within 300 mm of supply conductors, and also pass within 300 mm of communication cables, shall be protected with a suitable insulating covering where the guy passes the supply conductors, unless the guy is effectively grounded or insulated with a strain insulator at a point below the lowest supply conductor and above the highest communication cable.

The clearance from an insulated or effectively grounded guy to a communication cable may be reduced to 75 mm when abrasion protection is provided on the guy or communication cable.

ⓑCommunication conductors may be attached to supports on the sides or bottom of crossarms or surfaces of poles with less clearance.

ⓒThis clearance applies only to supply conductors at the support below communication conductors, on jointly used structures.

Where supply conductors are above communication conductors, this clearance may be reduced to 75 mm.

ⓓAll clearances for line over 50 kV shall be based on the maximum operating voltage. For voltages exceeding 814 kV, the clearance shall be determined by the alternate method given by Rule 235E3.

ⓔFor supply circuits of 0 to 750 V, this clearance may be reduced to 75 mm.

ⓕA neutral conductor meeting Rule 230E1 may be attached directly to the structure surface.

ⓖGuys and messengers may be attached to the same strain plates or to the same through bolts.

ⓗFor open supply circuits of 0 to 750 V and supply cables of all voltages meeting Rule 230C1, 2, or 3, this clearance may be reduced to 25 mm. No clearance is specified for phase conductors of such cables where they are physically restrained by a suitable bracket from abrasion against the pole.

ⓓThe additional clearance for voltages in excess of 50 kV specified in Table 235-6 shall be increased 3% for each 300 m in excess of 1000 m above mean sea level.

ⓓWhere the circuit is effectively grounded and the neutral conductor meets Rule 230E1, phase-to-neutral voltage shall be used to determine the clearance from the surface of support arms and structures.

ⓓThese clearances may be reduced by not more than 25% to a guy insulator, provided that full clearance is maintained to its metallic end fittings and the guy wires. The clearance to an insulated section of a guy between two insulators may be reduced by not more than 25% provided that full clearance is maintained to the uninsulated portion of the guy.

ⓓPhase-to-phase voltages shall be determined according to Rule 235A3.

ⓓThese clearances apply to communication antennas operated at a radio frequency of 3 kHz to 300 GHz. Also see Rules 235I4 and 239.

ⓓDoes not include neutral conductors meeting Rule 230E1.

in

Table 235-6—
Clearance in any direction from line conductors to supports and to
vertical or lateral conductors, span, or guy wires attached to the same support
 [See also Rules 235E1, 235E3b(2), and 235I.]

Clearance of line conductors from	Communi- cation lines in general (in)	Communi- cation lines on jointly used structures; neutral conductors meeting Rule 230E1 (in)	Supply lines		
			Circuit phase-to-phase voltage		
			0 to 8.7 kV [®] (in)	Over 8.7 to 50 kV (in)	Over 50 to 814 kV ^{①②} (in)
1. Vertical and lateral conductors:					
a. Of the same circuit	3	3	3	3 plus 0.25 per kV in excess of 8.7 kV	No value specified
b. Of other circuits ^{®②}	3	3	6 ^⑤	6 plus 0.4 per kV in excess of 8.7 kV	23 plus 0.4 per kV in excess of 50 kV
2. Span or guy wires,[®] or messengers attached to same structure:					
a. When parallel to line	3 ^⑦	6 ^{①⑦}	12 ^①	12 plus 0.4 per kV in excess of 8.7 kV	29 plus 0.4 per kV in excess of 50 kV
b. Anchor guys	3 ^⑦	6 ^{①⑦}	6 ^⑦	6 plus 0.25 per kV in excess of 8.7 kV	16 plus 0.25 per kV in excess of 50 kV
c. All other	3 ^⑦	6 ^{①⑦}	6	6 plus 0.4 per kV in excess of 8.7 kV	23 plus 0.4 per kV in excess of 50 kV
3. Surface of support arms	3 ^{②⑥}	3 ^{②⑥}	3 ^④	3 plus 0.2 per kV in excess of 8.7 kV ^{④⑥}	11 plus 0.2 per kV in excess of 50 kV

in

Table 235-6— (continued)
Clearance in any direction from line conductors to supports and to vertical or lateral conductors, span, or guy wires attached to the same support
 [See also Rules 235E1, 235E3b(2), and 235I.]

Clearance of line conductors from	Communication lines in general (in)	Communication lines on jointly used structures; neutral conductors meeting Rule 230E1 (in)	Supply lines		
			Circuit phase-to-phase voltage		
			0 to 8.7 kV [ⓐ] (in)	Over 8.7 to 50 kV (in)	Over 50 to 814 kV [ⓑ] (in)
4. Surface of structures:					
a. On jointly used structures	—	5 [ⓐ] ⑥	5 [ⓐ] ①	5 plus 0.2 per kV in excess of 8.7 kV [ⓐ] ⑦	13 plus 0.2 per kV in excess of 50 kV
b. All other	3 [ⓐ] ⑥	—	3 [ⓐ]	3 plus 0.2 per kV in excess of 8.7 kV [ⓐ] ⑦	11 plus 0.2 per kV in excess of 50 kV

①For guy wires, if practical. For clearances between span wires and communication conductors, see Rule 238C.

On jointly used structures, guys that pass within 12 in of supply conductors, and also pass within 12 in of communication cables, shall be protected with a suitable insulating covering where the guy passes the supply conductors, unless the guy is effectively grounded or insulated with a strain insulator at a point below the lowest supply conductor and above the highest communication cable.

The clearance from an insulated or effectively grounded guy to a communication cable may be reduced to 3 in when abrasion protection is provided on the guy or communication cable.

②Communication conductors may be attached to supports on the sides or bottom of crossarms or surfaces of poles with less clearance.

③This clearance applies only to supply conductors at the support below communication conductors, on jointly used structures.

Where supply conductors are above communication conductors, this clearance may be reduced to 3 in.

④All clearances for line over 50 kV shall be based on the maximum operating voltage. For voltages exceeding 814 kV, the clearance shall be determined by the alternate method given by Rule 235E3.

⑤For supply circuits of 0 to 750 V, this clearance may be reduced to 3 in.

⑥A neutral conductor meeting Rule 230E1 may be attached directly to the structure surface.

⑦Guys and messengers may be attached to the same strain plates or to the same through bolts.

⑧For open supply circuits of 0 to 750 V and supply cables of all voltages meeting Rule 230C1, 2 or 3, this clearance may be reduced to 1 in. No clearance is specified for phase conductors of such cables where they are physically restrained by a suitable bracket from abrasion against the pole.

⑨The additional clearance for voltages in excess of 50 kV specified in Table 235-6 shall be increased 3% for each 1000 ft in excess of 3300 ft above mean sea level.

⑩Where the circuit is effectively grounded and the neutral conductor meets Rule 230E1, phase-to-neutral voltage shall be used to determine the clearance from the surface of support arms and structures.

⑪These clearances may be reduced by not more than 25% to a guy insulator, provided that full clearance is maintained to its metallic end fittings and the guy wires. The clearance to an insulated section of a guy between two insulators may be reduced by not more than 25% provided that full clearance is maintained to the uninsulated portion of the guy.

⑫Phase-to-phase voltages shall be determined according to Rule 235A3.

⑬These clearances apply to communication antennas operated at a radio frequency of 3 kHz to 300 GHz. Also see Rules 235I4 and 239.

⑭Does not include neutral conductors meeting Rule 230E1.

Table 235-7—Clearance in any direction from line conductors to supports
 [See also Rules 235E3b and 235E3b(1)(a).]

Maximum operating voltage phase to phase (kV)	Switching-surge factor (per unit)	Switching surge (kV)	Computed clearance to supports			
			Fixed		Free swinging at maximum angle	
			(m)	(in)	(m)	(in)
242	2.4	474	0.88	35 ^①	0.88 ^①	35 ^①
	2.6	514	1.01	40	0.88 ^①	35 ^①
	2.8	553	1.14	45	0.98	39
	3.0	593	1.24 ^②	49 ^②	1.10	44
	3.2	632	1.24 ^②	49 ^②	1.22	49
362	1.6	473	0.88 ^①	35 ^①	0.88 ^①	35 ^①
	1.8	532	1.07	42	0.92	36
	2.0	591	1.27	50	1.09	43
	2.2	650	1.49	59	1.28	48
	2.4	709	1.72	68	1.48	59
	2.5	739	1.84	73	1.59	60
550	1.6	719	1.76	69	1.51	60
	1.8	808	2.14	84	1.84	75
	2.0	898	2.55	100	2.19	87
	2.2	988	2.78 ^②	111 ^②	2.57	102
800	1.6	1045	3.3	129	2.82	114
	1.8	1176	4.0	157	3.5	139
	1.9	1241	4.1 ^②	165 ^②	3.8	148
	2.0	1306	4.1 ^②	165 ^②	4.1 ^②	165

① Limited by Rule 235E3(b)(2).

② Need not be greater than specified in Rules 235E1 and 235E2.

Table 235-8—Vertical spacing between conductors supported on vertical racks or separate brackets

Span length		Vertical spacing between conductors	
(m)	(ft)	(mm)	(in)
0 to 45	0 to 150	100	4
Over 45 to 60	Over 150 to 200	150	6
Over 60 to 75	Over 200 to 250	200	8
Over 75 to 90	Over 250 to 300	300	12

EXCEPTION: The vertical spacing between open wire conductors may be reduced where the conductors are held apart by intermediate spacers, but may not be less than 100 mm (4 in).

236. Climbing space

The following requirements apply only to portions of structures that workers ascend.

A. Location and dimensions

1. A climbing space having the horizontal dimensions specified in Rule 236E shall be provided past any conductors, support arms, or other parts.
2. The climbing space need be provided on one side or corner of the support only.
3. The climbing space shall extend vertically past any conductor or other part between levels above and below the conductor as specified in Rules 236E, F, G, and I, but may otherwise be shifted from any side or corner of the support to any other side or corner.

B. Portions of supporting structures in climbing space

Portions of the supporting structure, when included in one side or corner of the climbing space, are not considered to obstruct the climbing space.

C. Support arm location relative to climbing space

RECOMMENDATION: Support arms should be located on the same side of the pole.

EXCEPTION: This recommendation does not apply where double crossarms are used on any pole or where crossarms on any pole are not all parallel.

D. Location of equipment relative to climbing space

1. All supply and communication equipment such as transformers, regulators, capacitors, cable terminals (potheads), amplifiers, loading coils, antennas, surge arresters, switches, etc., when located below conductors or other attachments, shall be mounted outside of the climbing space.
2. All exposed ungrounded conductive parts of luminaires and their supports that are not insulated from current-carrying parts shall be maintained at not less than 500 mm (20 in) from the surface of their supporting structure.

EXCEPTION 1: This may be reduced to 125 mm (5 in) if located on the side of the structure opposite the designated climbing space.

EXCEPTION 2: This does not apply where the equipment is located at the top or other vertical portion of the structure that is not subject to climbing.

E. Climbing space between conductors

Climbing space between conductors shall be not less than the horizontal dimensions specified in Table 236-1. These dimensions are intended to provide a clear climbing space of 600 mm (24 in) while the conductors bounding the climbing space are covered with temporarily installed protective covering rated for the voltage involved. The climbing space shall be provided both along and across the line and shall be projected vertically not less than 1.0 m (40 in) above and below the limiting conductors. Where communication conductors are above supply conductors of more than 8.7 kV to ground or 15 kV line to line, the climbing space shall be projected vertically at least 1.50 m (60 in) above the highest supply conductors.

EXCEPTION 1: This rule does not apply if it is the unvarying practice of the employers concerned to prohibit employees from ascending beyond the conductors or equipment of a given line or structure unless the conductors or equipment are de-energized and grounded per Rule 444D.

EXCEPTION 2: For supply conductors carried on a structure in a position below communications facilities in the manner permitted in Rule 220B2, the climbing space need not extend more than 600 mm (2 ft) above such supply space.

EXCEPTION 3: If the conductors are owned, operated, or maintained by the same utility, the climbing space may be provided by temporarily moving the line conductors using live-line tools.

F. Climbing space on buckarm construction

Method of providing climbing space on buckarm construction

The full width of climbing space shall be maintained on buckarm construction and shall extend vertically in the same position at least 1.0 m (40 in) [or 1.50 m (60 in) where required by Rule 236E] above and below any limiting conductor.

A six-pin crossarm having pin spacing of 370 mm (14.5 in) may be used to provide a 750 mm (30 in) climbing space on one corner of a junction pole by omitting the pole pins on all arms, and inserting pins midway between the remaining pins so as to give a spacing of 185 mm (7.25 in), provided that all of the following conditions are met:

1. Circuits are less than 8.7 kV to ground or 15 kV line to line
2. Span lengths do not exceed 45 m (150 ft)
3. Sags do not exceed 380 mm (15 in) for wires of AWG No. 2 and larger sizes, or 750 mm (30 in) for wires smaller than AWG No. 2
4. Each conductor on the end of every arm is tied to the same side of its insulator
5. The spacing on the next pole is not less than 370 mm (14.5 in)

G. Climbing space past longitudinal runs not on support arms

The full width of climbing space shall be provided past longitudinal runs and shall extend vertically in the same position from 1.0 m (40 in) below the run to a point 1.0 m (40 in) above [or 1.50 m (60 in) where required by Rule 236E]. The width of climbing space shall be measured from the longitudinal run concerned. Longitudinal runs on racks, or cables on messengers, are not considered as obstructing the climbing space if the location, size, and quantity of the cables permit qualified workers to climb past them. This does not apply where communication conductors are above the longitudinal runs concerned.

EXCEPTION 1: If a supply longitudinal run is placed on the side or corner of the supporting structure where climbing space is provided, the width of climbing space shall be measured horizontally from the center of the structure to the nearest supply conductors on support arms, under both of the following conditions:

- (a) Where the longitudinal run consists of neutral conductors meeting Rule 230E1, open supply conductors carrying not more than 750 V, or supply cables and conductors meeting Rule 230C, all voltages; and is supported close to the structure as by brackets, racks, or pins close to the structure
- (b) Where the nearest supply conductors on support arms are parallel to and on the same side of the structure as the longitudinal run and within 1.20 m (4 ft) above or below the run

EXCEPTION 2: For supply conductors carried on a structure in a position below communications facilities in the manner permitted in Rule 220B2, the climbing space need not extend more than 600 mm (2 ft) above such supply space.

EXCEPTION 3: A service drop less than 750 V and meeting Rule 230C is not considered to obstruct the climbing space if all conductors concerned are covered by rubber protective equipment or otherwise guarded as an unvarying practice before workers climb past them, provided that such a service drop is (1) not closer to the longitudinal run at the point of attachment than the diameter of the pole plus 125 mm (5 in) measured horizontally, and (2) not closer than 950 mm (38 in) measured horizontally to the longitudinal run at a point 750 mm (30 in) on the run measured from the point of attachment at the pole. See Figure 236-1.

H. Climbing space past vertical conductors

Vertical runs physically protected by suitable conduit or other protective covering and securely attached without spacers to the surface of the line structure are not considered to obstruct the climbing space.

I. Climbing space near ridge-pin conductors

The climbing space specified in Table 236-1 shall be provided above the top support arm to the ridge-pin conductor but need not be carried past it.

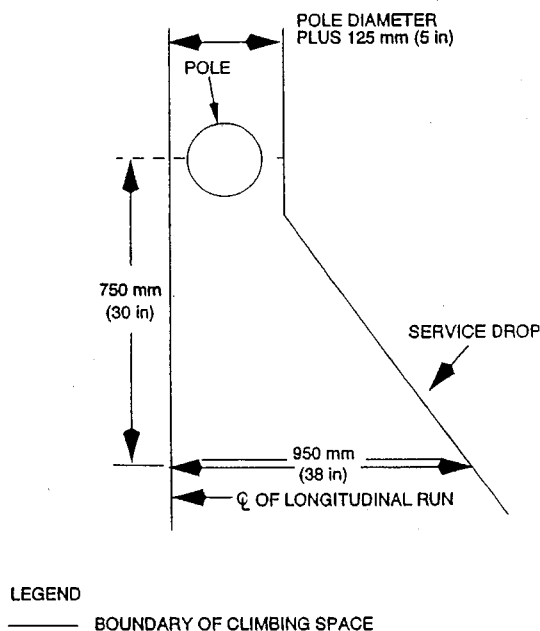

Figure 236-1—Rule 236G, *Exception 3*

Table 236-1— Horizontal clearance between conductors bounding the climbing space
 (All voltages are between the two conductors bounding the climbing space except for communication conductors, which are voltage to ground. Where the two conductors are in different circuits, the voltage between conductors shall be the arithmetic sum of the voltages of each conductor to ground for a grounded circuit, or phase to phase for an ungrounded conductor. See also Rule 236E.)

Character of conductors adjacent to climbing space	Voltage of conductors	Horizontal clearance between conductors bounding the climbing space ^①							
		On structures used solely by				On jointly used structures			
		Communication conductors		Supply conductors		Supply conductors above communication conductors		Communication conductors above supply conductors ^②	
		(m)	(in)	(m)	(in)	(m)	(in)	(m)	(in)
1. Communication conductors	0 to 150 V	0.60	No requirements		—		③	0.60	No requirements
	Exceeding 150 V		24 recommended		—		③		24 recommended
2. Supply cables meeting Rule 230C1	All voltages				—		②		No requirements
3. Supply cables meeting Rule 230C2 or 3	All voltages	—	—	0.60	24	0.60	24	0.75	30
4. Open supply line conductors and supply cables meeting Rule 230D	0 to 750 V	—	—	0.60	24	0.60	24	0.75	30
	750 V to 15 kV	—	—	0.75	30	0.75	30	0.75	30
	15 kV to 28 kV	—	—	0.90	36	0.90	36	0.90	36
	28 kV to 38 kV	—	—	1.00	40	1.00	40		
	38 kV to 50 kV	—	—	1.17	46	1.17	46		
	50 kV to 73 kV	—	—	1.40	54	1.40	54		
	Exceeding 73 kV	—	—	>1.40	54				

①This relation of levels in general is not desirable and should be avoided.

②Climbing space shall be the same as required for the supply conductors immediately above, with a maximum of 0.75 m (30 in) except that a climbing space of 0.41 m (16 in) across the line may be employed for communication cables or conductors where the only supply conductors at a higher level are secondaries (0 to 750 V) supplying airport or airway marker lights or crossing over the communication line and attached to the pole top or to a pole-top extension fixture.

③Attention is called to the operating requirements of Rules 441A and 446C, Part 4, of this Code.

237. Working space

A. Location of working spaces

Working spaces shall be provided on the climbing face of the structure at each side of the climbing space.

B. Dimensions of working spaces

1. Along the support arm

The working space shall extend from the climbing space to the outmost conductor position on the support arm.

2. At right angles to the support arm

The working space shall have the same dimension as the climbing space (see Rule 236E). This dimension shall be measured horizontally from the face of the support arm.

3. Vertically

The working space shall have a height not less than that required by Rule 235 for the vertical separation of line conductors carried at different levels on the same support.

C. Location of vertical and lateral conductors relative to working spaces

The working spaces shall not be obstructed by vertical or lateral conductors. Such conductors shall be located on the opposite side of the pole from the climbing side or on the climbing side of the pole at a distance from the support arm at least as great as the width of climbing space required for the highest voltage conductors concerned. Vertical conductors enclosed in suitable conduit may be attached on the climbing side of the structure.

D. Location of buckarms relative to working spaces

Buckarms may be used under any of the following conditions, provided the climbing space is maintained. Climbing space may be obtained as in Rule 236F.

1. Standard height of working space

Lateral working space of the height required by Table 235-5 shall be provided between the crossing or tap line conductors attached to the buckarm and the main line conductors. This may be accomplished by increasing the spacing between the line support arms, as shown in Figure 237-1.

2. Reduced height of working space

Where no circuits exceeding 8.7 kV to ground or 15 kV line to line are involved and the clearances of Rules 235B1a and 235B1b are maintained, conductors supported on buckarms may be placed between line conductors having normal vertical spacing, even though such buckarms obstruct the normal working space, provided that a working space of not less than 450 mm (18 in) in height is maintained either above or below line conductors and buckarm conductors.

EXCEPTION: The above working space may be reduced to 300 mm (12 in) if both of the following conditions exist:

- (a) Not more than two sets of the line arms and buckarms are involved
- (b) Working conditions are rendered safe by providing rubber protective equipment or other suitable devices to insulate and cover line conductors and equipment that are not being worked upon

E. Guarding of energized equipment

Exposed energized parts of equipment such as switches, circuit breakers, surge arresters, etc., shall be enclosed or guarded if all of the following conditions apply:

1. The equipment is located below the top conductor support
2. The equipment is located on the climbing side of the structure
3. The requirements of Rule 441, Part 4, of this Code cannot be met

F. Working clearances from energized equipment

All parts of equipment such as switches, fuses, transformers, surge arresters, luminaires and their support brackets, etc., or other connections that may require operation or adjustment while energized and exposed at such times, shall be so arranged with respect to each other, other equipment, vertical and lateral conductors, and portions of the supporting structure, including supporting platforms or structural members, that in adjustment or operation no portion of the body, including the hands, need be brought closer to any exposed energized parts or conductors than permitted in Part 4, Rule 441 or 446 of this Code.

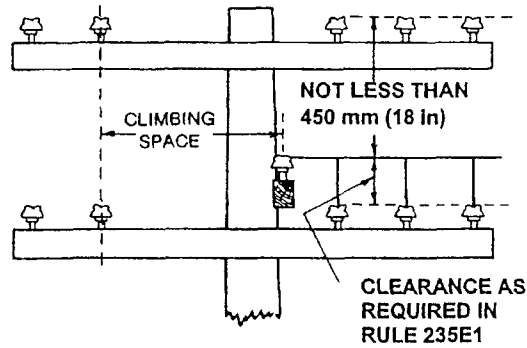

Figure 237-1—Obstruction of working space by buckarm

238. Vertical clearance between certain communications and supply facilities located on the same structure

A. Equipment

For the purpose of measuring clearances under this rule, equipment shall be taken to mean non-current-carrying metal parts of equipment, including metal supports for cables or conductors, and metal support braces that are attached to metal supports or are less than 25 mm (1 in) from transformer cases or hangers that are not effectively grounded.

B. Clearances in general

Vertical clearances between supply conductors and communications equipment, between communication conductors and supply equipment, and between supply and communications equipment shall be as specified in Table 238-1, except as provided in Rule 238C.

C. Clearances for span wires or brackets

Span wires or brackets carrying luminaires, traffic signals, or trolley conductors shall have at least the vertical clearances in millimeters or inches from communications equipment set forth in Table 238-2.

D. Clearance of drip loops of luminaire or traffic signal brackets

If a drip loop of conductors entering a luminaire bracket or traffic signal bracket from the surface of the structure is above a communication cable, the lowest point of the loop shall be at least 300 mm (12 in) above communication cable or through bolt.

EXCEPTION: The above clearance may be reduced to 75 mm (3 in) if the loop is covered by a suitable nonmetallic covering that extends at least 50 mm (2 in) beyond the loop.

E. Communication worker safety zone

The clearances specified in Rules 235C and 238 create a communication worker safety zone between the facilities located in the supply space and facilities located in the communication space, both at the structure and in the span between structures. Except as allowed by Rules 238C, 238D, and 239, no supply or communication facility shall be located in the communication worker safety zone.

Table 238-1—Vertical clearance between supply conductors and communications equipment, between communication conductors and supply equipment, and between supply and communications equipment

(Voltages are phase to ground for effectively grounded circuits and those other circuits where all ground faults are cleared by promptly de-energizing the faulted section, both initially and following subsequent breaker operations. See the definitions section for voltages of other systems. See also Rule 238B.)

Supply voltage (kV)	Vertical clearance	
	(m)	(in)
1. Grounded conductor and messenger hardware and supports	0.75	30
2. 0 to 8.7	1.00	40 ^①
3. Over 8.7	1.00 plus 0.01 per kV in excess of 8.7 kV	40 plus 0.4 per kV ^① in excess of 8.7 kV

①Where non-current-carrying parts of supply equipment are effectively grounded and the associated neutral meeting Rule 230E1 or supply cables meeting Rule 230C1 (including the support brackets) are bonded to communication messengers at intervals meeting Rule 92C through out well-defined areas and where communication is at lower levels, clearances may be reduced to 0.75 m (30 in).

Table 238-2—Vertical clearance of span wires and brackets from communication lines
(See also Rule 238C.)

	Carrying luminaires or traffic signals				Carrying trolley conductors			
	Not effectively grounded		Effectively grounded		Not effectively grounded		Effectively grounded	
	(mm)	(in)	(mm)	(in)	(mm)	(in)	(mm)	(in)
Above communication support arms	500	20 ^①	500	20 ^①	500	20 ^①	500	20 ^①
Below communication support arms	1000	40 ^①	600	24	600	24	600	24
Above messengers carrying communication cables	500	20 ^①	100	4	300	12	100	4
Below messengers carrying communication cables	1000	40 ^①	100	4	300	12	100	4
From terminal box of communication cable	500	20 ^①	100	4	300	12 ^②	100	4
From communication brackets, bridle wire rings, or drive hooks	410	16 ^①	100	4	100	4	100	4

①This may be reduced to 300 mm (12 in) for either span wires or metal parts of brackets at points 1.0 m (40 in) or more from the structure surface.

- ②Where it is not practical to obtain a clearance of 300 mm (1 ft) from terminal boxes of communication cables, all metal parts of terminals shall have the greatest possible clearance from fixtures or span wires including all supporting screws and bolts of both attachments.
- ③This may be reduced to 600 mm (24 in) for luminaires and traffic signals operating at less than 150 V to ground.
- ④This may be reduced to 500 mm (20 in) for luminaires and traffic signals operating at less than 150 V to ground.

239. Clearance of vertical and lateral facilities from other facilities and surfaces on the same supporting structure

Vertical and lateral conductors shall have the clearances required by this rule from other facilities or surfaces on the same supporting structure.

A. General

1. Grounding conductors, surge-protection wires, neutral conductors meeting Rule 230E1, insulated communication conductors and cables, supply cables meeting Rule 230C1 or 350B, insulated supply cables of 0 to 750 V, or conduits may be placed directly on the supporting structure. These conductors, wires, cables, and conduits shall be securely attached to the surface of the structure. Cables not in conduit shall be installed in such a manner as to avoid abrasion at the point of attachment.
2. Installation of supply cable and communication cable in same duct or U-guard type covering
 - a. Supply cables 0 to 600 V may be installed together in the same duct or U-guard, if all of the cables are operated and maintained by the same utility.
 - b. Supply cables exceeding 600 V meeting Rule 230C1 may be installed together in the same duct or U-guard if all of the cables are operated and maintained by the same utility.
 - c. Supply cables 0 to 600 V and supply cables exceeding 600 V meeting Rule 230C1 may be installed together in the same duct or U-guard if all of the cables are operated and maintained by the same utility.
 - d. Supply cables shall not be installed in the same duct or U-guard with communication cables unless all of the cables are operated and maintained by the same utility.
 - e. Communication cables may be installed together in the same duct or U-guard provided all utilities involved are in agreement.
3. Paired communication conductors in rings may be attached directly to a structure or messenger.
4. Insulated supply circuits of 600 V or less and not exceeding 5000 W may be placed in the same cable with control circuits with which they are associated.
5. The term nonmetallic covering as used in Rule 239 refers to material other than a cable jacket that provides an additional barrier against physical contact.
6. Where guarding and protection are required by other rules, either conduit or U-guards may be used.

B. Location of vertical or lateral conductors relative to climbing spaces, working spaces, and pole steps

Vertical or lateral conductors shall be located so that they do not obstruct climbing spaces, or lateral working spaces between line conductors at different levels, or interfere with the safe use of pole steps.

EXCEPTION: This rule does not apply to portions of the structure that workers do not ascend while the conductors in question are energized.

NOTE: See Rule 236H for vertical runs in conduit or other protective covering.

C. Conductors not in conduit

Conductors not encased in conduit shall have the same clearances from conduits as from other surfaces of structures.

D. Guarding and protection near ground

1. Where within 2.45 m (8 ft) of the ground, or other areas readily accessible to the public, all vertical conductors and cables shall be guarded.

EXCEPTION: This guarding may be omitted from grounding conductors used to ground multi-grounded circuits or equipment (communications or supply); communication cables or conductors; armored cables; or conductors used solely to protect structures from lightning.

2. Where guarding is required, either conduit or U-guards may be used. A backing plate shall be used with a U-guard unless the U-guard fits tightly to the supporting structure surface.
3. When guarding is not required, conductors and cables shall be securely attached to the surface of the structure or to standoff brackets and located, where practical, on the portion of the structure having the least exposure to mechanical damage.
4. Guards that completely enclose grounding conductors of lightning-protection equipment shall be of nonmetallic materials or shall be bonded at both ends to the grounding conductor.

E. Requirements for vertical and lateral supply conductors on supply line structures or within supply space on jointly used structures

1. General clearances

In general, clearances shall be not less than the values specified in Table 239-1 or Rule 235E.

2. Special cases

The following requirements apply only to portions of a structure that workers ascend while the conductors in question are energized.

- a. General

If open-line conductors are within 1.20 m (4 ft) of the pole, vertical conductors shall be run in one of the following ways:

- (1) The clearance between open vertical conductors and pole-surface shall be not less than that given in Table 239-2 within the zone specified in the table.
- (2) Within the zone above and below open supply conductors as given in Table 239-2, vertical and lateral conductors or cables attached to the surface of the structure shall be enclosed in nonmetallic conduit or protected by non-metallic covering.

EXCEPTION: This conduit or covering may be omitted from grounding conductors, surge-protection wires, neutral conductors meeting Rule 230E1, supply cables meeting Rule 230C1, and jacketed multiple-conductor supply cables of 0 to 750V, where such conductors or cable are not in the climbing space.

For the purpose of this exception, a jacketed multiple-conductor cable is a cable with a jacket enclosing the entire cable assembly.

- b. Conductors to luminaires

On structures used only for supply lines or on jointly used structures where the luminaire bracket is 1.0 m (40 in) or more above all communication attachments, open wires may be run from the supply line arm directly to the head of a luminaire, provided the clearances of Table 239-1 are obtained and the open wires are securely supported at both ends.

F. Requirements for vertical and lateral communication conductors on communication line structures or within the communication space on jointly used structures

1. Clearances from communication conductors

The clearances of uninsulated vertical and lateral communication conductors from other communication conductors (except those in the same ring run) and from guy, span, or messenger wires shall be not less than those given in Rule 235E1, Table 235-6.

2. Clearances from supply conductors

The vertical clearance of vertical and lateral insulated communication conductors shall be not less than 1.0 m (40 in) from any supply conductors (other than vertical runs or luminaire leads)

of 8.7 kV or less, or 1.0 m (40 in) plus 10 mm (0.4 in) per kV over 8.7 to 50 kV. The additional clearance of Rule 235C2 is applicable when the voltage exceeds 50 kV.

EXCEPTION 1: May be reduced to 0.75 m (30 in) from supply neutrals meeting Rule 230E1, cables meeting Rule 230C1, and fiber optic-supply cables where the supply neutral or messenger is bonded to the communication messenger.

EXCEPTION 2: These clearances do not apply where the supply circuits involved are those carried in the manner specified in Rule 220B2.

G. Requirements for vertical supply conductors and cables passing through communication space on jointly used line structures

1. Guarding—General

Vertical supply conductors or cables attached to the structure shall be guarded with suitable conduit or covering from 1.0 m (40 in) above the highest communication attachment to 1.80 m (6 ft) below the lowest communication attachment, except as allowed by Rule 238D.

EXCEPTION 1: This conduit or covering may be omitted from neutral conductors meeting Rule 230E1, supply cables meeting Rule 230C1a, and jacketed multiple-conductor supply cables of 0 to 750 V, where such conductors or cable are not in the climbing space.

For the purpose of this exception, a jacketed multiple-conductor cable is a cable with a jacket enclosing the entire cable assembly.

EXCEPTION 2: This conduit or covering may be omitted from supply grounding conductors where there are no trolley or ungrounded traffic signal attachments, or ungrounded street lighting fixtures located below the communication attachment, provided:

- (a) The grounding conductor is directly (metallically) connected to a conductor which forms part of an effective grounding system,
- (b) The grounding conductor has no connection to supply equipment between the grounding electrode and the effectively grounded conductor unless the supply equipment has additional connections to the effectively grounded conductor, and
- (c) The grounding conductor is bonded to grounded communication facilities at that structure.

2. Cables and conductors in conduit or covering

Cables and conductors of all voltages may be run in a nonmetallic conduit or covering or in a grounded metallic conduit or covering in accordance with Rule 239A1. Where a metallic conduit or covering is not bonded to grounded communications facilities at that structure, such metal conduit or covering shall have a nonmetallic covering from 1.0 m (40 in) above the highest communication attachment to 1.80 m (6 ft) below the lowest communication attachment.

3. Protection near trolley, ungrounded traffic signal, or ungrounded luminaire attachments

Vertical supply conductors or cables attached to the structure shall be guarded with suitable nonmetallic conduit or covering on structures that carry a trolley or ungrounded traffic signal attachment or an ungrounded luminaire that is attached below the communication cable. The cable shall be protected with nonmetallic covering from 1.0 m (40 in) above the highest communication wire to 1.80 m (6 ft) below the lowest trolley attachment or ungrounded luminaire fixture or ungrounded traffic signal attachment.

4. Aerial services

Where supply cables are used as aerial services, the point where such cables leave the structure shall be at least 1.0 m (40 in) above the highest or 1.0 m (40 in) below the lowest communication attachment. Within the communication space, all splices and connections in the energized phase conductors shall be insulated.

5. Clearance from through bolts and other metal objects

Vertical runs of supply conductors or cables shall have a clearance of not less than 50 mm (2 in) from exposed through bolts and other exposed metal objects attached thereto that are associated with communication line equipment.

EXCEPTION: Vertical runs of effectively grounded supply conductors may have a clearance of 25 mm (1 in).

H. Requirements for vertical communication conductors passing through supply space on jointly used structures

All vertical runs of communication conductors passing through supply space shall be installed as follows:

1. Metal-sheathed communication cables

Vertical runs of metal-sheathed communication cables shall be covered with suitable nonmetallic material, where they pass trolley feeders or other supply line conductors. This nonmetallic covering shall extend from a point 1.0 m (40 in) above the highest trolley feeders or other supply conductors, to a point 1.80 m (6 ft) below the lowest trolley feeders or other supply conductors, but need not extend below the top of any mechanical protection that may be provided near the ground.

EXCEPTION 1: Communication cables may be run vertically on the pole through space occupied by railroad signal supply circuits in the lower position, as permitted in Rule 220B2, without covering within the supply space.

EXCEPTION 2: Covering is not required in the supply space on metallic or concrete supporting structures.

2. Communication conductors

Vertical runs of insulated communication conductors shall be covered with suitable nonmetallic material, to the extent required for metal-sheathed communication cables in Rule 239H1, where such conductors pass trolley feeders or supply conductors.

EXCEPTION 1: Communication conductors may be run vertically on the structure through space occupied by railroad-signal supply circuits in the lower position, as permitted in Rule 220B2, without covering within the supply space.

EXCEPTION 2: Covering is not required in the supply space on metallic or concrete supporting structures.

3. Communication grounding conductors

Vertical communication grounding conductors shall be covered with suitable nonmetallic material between points at least 1.80 m (6 ft) below and 1.0 m (40 in) above any trolley feeders or other supply line conductors by which they pass.

EXCEPTION 1: Communication grounding conductors may be run vertically on the structure through space occupied by railroad-signal supply circuits in the lower position, as permitted in Rule 220B2, without covering within the supply space.

EXCEPTION 2: Covering is not required in the supply space on metallic or concrete supporting structures.

4. Clearance from through bolts and other metal objects

Vertical runs of communication conductors or cables shall have a clearance of one-eighth of the pole circumference but not less than 50 mm (2 in) from exposed through bolts and other exposed metal objects attached thereto that are associated with supply line equipment.

EXCEPTION: Vertical runs of effectively grounded communication cables may have a clearance of 25 mm (1 in).

I. Operating rods

Effectively grounded or insulated operating rods of switches are permitted to pass through the communication space, but shall be located outside of the climbing space.

J. Additional rules for standoff brackets

1. Standoff brackets may be used to support the conduit(s). Cable insulation appropriate for the intended service is required; non-metallic conduit shall not be used to meet basic insulation requirements.

NOTE: See Rule 217A2.

2. Standoff brackets may be used to support the following types of cable enclosed within a single outer jacket or sheath (cable only without conduit):
 - a. Communication
 - b. 230C1a supply (any voltage)
 - c. Supply less than 750 V

NOTE: See Rule 217A2.

m

Table 239-1—Clearance of open vertical and lateral conductors
(Circuit phase-to-phase voltage. See also Rules 239E1 and 239E2b.)

Clearance of open vertical and lateral conductors	0 to 8.7 kV (mm)	Over 8.7 to 50 kV (mm)	Over 50 kV ^④ (mm)
From surfaces of supports	75 ^{① ②}	75 plus 5 per kV in excess of 8.7 kV	280 plus 5 per kV in excess of 50 kV
From span, guy, and messenger wires ^⑤	150	150 plus 10 per kV in excess of 8.7 kV ^③	580 plus 10 per kV in excess of 50 kV ^③

- ①A neutral conductor meeting Rule 230E1 may be attached directly to the structure surface.
- ②For supply circuits of 0 to 750 V, this clearance may be reduced to 25 mm.
- ③Multiplier may be reduced to 6.5 mm/kV for anchor guys.
- ④The additional clearance for voltages in excess of 50 kV specified in Table 239-1 shall be increased 3% for each 300 m in excess of 1000 m above mean sea level.
- ⑤These clearances may be reduced by not more than 25% to a guy insulator, provided that full clearance is maintained to its metallic end fittings and the guy wires. The clearance to an insulated section of a guy between two insulators may be reduced by not more than 25% provided that full clearance is maintained to the uninsulated portion of the guy.

in

Table 239-1—Clearance of open vertical and lateral conductors
(Circuit Phase-to-Phase Voltage. See also Rules 239E1 and 239E2b.)

Clearance of open vertical and lateral conductors	0 to 8.7 kV (in)	Over 8.7 to 50 kV (in)	Over 50 kV ^④ (in)
From surfaces of supports	3 ^{① ②}	3 plus 0.2 per kV in excess of 8.7 kV	11 plus 0.2 per kV in excess of 50 kV
From span, guy, and messenger wires ^⑤	6	6 plus 0.4 per kV in excess of 8.7 kV ^③	23 plus 0.4 per kV in excess of 50 kV ^③

- ①A neutral conductor meeting Rule 230E1 may be attached directly to the structure surface.
- ②For supply circuits of 0 to 750 V, this clearance may be reduced to 1 in.
- ③Multiplier may be reduced to 0.25 in/kV for anchor guys.
- ④The additional clearance for voltages in excess of 50 kV specified in Table 239-1 shall be increased 3% for each 1000 ft in excess of 3300 ft above mean sea level.
- ⑤These clearances may be reduced by not more than 25% to a guy insulator, provided that full clearance is maintained to its metallic end fittings and the guy wires. The clearance to an insulated section of a guy between two insulators may be reduced by not more than 25% provided that full clearance is maintained to the uninsulated portion of the guy.

m

Table 239-2—Clearance between open vertical conductors and pole surface

[Voltages are phase to ground for effectively grounded circuits and those other circuits where all ground faults are cleared by promptly de-energizing the faulted section, both initially and following subsequent breaker operations. See the definitions section for voltages of other systems.

See also Rules 239E2a(1) and 239E2a(2).]

Voltage (kV)	Distance above and below open supply conductors where clearances apply (m)	Clearance between vertical conductor and pole surface (mm)
0 to 22 [Ⓣ]	1.80	480
22 to 30	1.80	560
30 to 50	1.80	760

ⓉDoes not include neutral conductors meeting Rule 230E1.

in

Table 239-2—Clearance between open vertical conductors and pole surface

[Voltages are phase to ground for effectively grounded circuits and those other circuits where all ground faults are cleared by promptly de-energizing the faulted section, both initially and following subsequent breaker operations. See the definitions section for voltages of other systems.

See also Rules 239E2a(1) and 239E2a(2).]

Voltage (kV)	Distance above and below open supply conductors where clearances apply (ft)	Clearance between vertical conductor and pole surface (in)
0 to 22 [Ⓣ]	6	19
22 to 30	6	22
30 to 50	6	30

ⓉDoes not include neutral conductors meeting Rule 230E1.

Section 24. Grades of construction

240. General

- A. The grades of construction are specified in this section on the basis of the required strengths for safety. Where two or more conditions define the grade of construction required, the grade used shall be the highest one required by any of the conditions.
- B. For the purposes of this section, the voltage values for direct-current circuits shall be considered equivalent to the rms values for alternating-current circuits.

241. Application of grades of construction to different situations

A. Supply cables

For the purposes of these rules, supply cables are classified by two types as follows:

Type 1—Supply cables conforming to Rule 230C1, 230C2, or 230C3 shall be installed in accordance with Rule 261I.

Type 2—All other supply cables are required to have the same grade of construction as open-wire conductors of the same voltage.

B. Order of grades

The relative order of grades for supply and communication conductors and supporting structures is B, C, and N, with Grade B being the highest.

C. At crossings

Wires, conductors, or other cables of one line are considered to be at crossings when they cross over another line, whether or not on a common supporting structure, or when they cross over or overhang a railroad track, the traveled way of a limited access highway, or navigable waterways requiring waterway crossing permits. Joint-use or collinear construction in itself is not considered to be at crossings.

1. Grade of upper line

Conductors and supporting structures of a line crossing over another line shall have the grade of construction specified in Rules 241C3, 242, and 243.

2. Grade of lower line

Conductors and supporting structures of a line crossing under another line need only have the grades of construction that would be required if the line at the higher level were not there.

3. Multiple crossings

- a. Where a line crosses in one span over two or more other lines, or where one line crosses over a span of a second line, which span in turn crosses a span of a third line, the grade of construction of the uppermost line shall be not less than the highest grade that would be required of either one of the lower lines when crossing the other lower line.
- b. Where communication conductors cross over supply conductors and railroad tracks in the same span, the grades of construction shall be in accordance with Grade B construction. It is recommended that the placing of communication conductors above supply conductors generally be avoided unless the supply conductors are trolley-contact conductors and their associated feeders.

D. Conflicts (see Section 2, **structure conflict**)

The grade of construction of the conflicting structure shall be as required by Rule 243A4.

242. Grades of construction for conductors

The grades of construction required for conductors are given in Tables 242-1 and 242-2. For the purpose of these tables certain classes of circuits are treated as follows:

A. Constant-current circuit conductors

The grade of construction for conductors of a constant-current supply circuit involved with a communication circuit and not in Type 1 cable shall be based on either its current rating or on the open-circuit voltage rating of the transformer supplying such circuit, as set forth in Tables 242-1 and 242-2. When the constant current supply circuit is in Type 1 cable, the grade of construction shall be based on its nominal full-load voltage.

B. Railway feeder and trolley-contact circuit conductors

Railway feeder and trolley-contact circuit conductors shall be considered as supply conductors for the purpose of determining the required grade of construction.

C. Communication circuit conductors located in the supply space

Communication circuit conductors located in the supply space shall have their grade of construction determined as follows:

1. Circuits meeting the requirements of Rule 224A3 may have the same grade of construction as ordinary communication circuits.
2. Circuits not meeting the requirements of Rule 224A3 shall have the same grade of construction as the supply circuits above which they are located.

D. Fire-alarm circuit conductors

Fire-alarm circuit conductors shall meet the strength and loading requirements of communication circuit conductors.

E. Neutral conductors of supply circuits

Supply-circuit neutral conductors, which are effectively grounded throughout their length and are not located above supply conductors of more than 750 V to ground, shall have the same grade of construction as supply conductors of not more than 750 V to ground, except that they need not meet any insulation requirements. Other neutral conductors shall have the same grade of construction as the phase conductors of the supply circuits with which they are associated.

F. Surge-protection wires

Surge-protection wires shall be of the same grade of construction as the supply conductors with which they are associated.

**Table 242-1—
Grades of construction for supply conductors alone, at crossing,
or on the same structures with other conductors**

(The voltages listed in this table are phase-to-ground values for: effectively grounded ac circuits, two-wire grounded circuits, or center-grounded dc circuits; otherwise phase-to-phase values shall be used. The grade of construction for supply conductors, as indicated across the top of the table, shall also meet the requirements for any lines at lower levels except when otherwise noted.)

Conductors, tracks, and rights-of-way at lower levels	Supply conductors at higher levels ^①							
	Constant-potential supply conductors					Constant-current supply conductors		Communication conductors located in the supply space
	0 to 750 V	751 V to 8.7 kV		Exceeding 8.7 kV		Open	Cable	
		Open or cable	Open	Cable	Open			Cable
Exclusive private rights-of-way	N	N ^②	N	N ^②	N ^②	B, C, or N; see Rule 242A		C or N; see Rule 242C
Common or public rights-of-way	N	C	N	C ^③	C	B, C, or N; see Rule 242A		B, C, or N; see Rule 242C
Railroad tracks, limited-access high-ways, ^④ and navigable water-ways requiring waterway crossing permits	B	B	B	B	B	B	B	B
Constant-potential supply conductors 0 to 750 V, open or cable	N	C	N	C ^③	C	B, C, or N; see Rule 242A		B, C, or N; see Rule 242C
750 V to 8.7 kV Open	C ^④	C	C	C ^③	C	B, C, or N; see Rule 242A		B, C, or N; see Rule 242C
Cable	N	C	N	C ^③	C	B, C, or N; see Rule 242A		B, C, or N; see Rule 242C
Exceeding 8.7 kV Open	B ^⑤	B	B	C ^③	C	B, C, or N; see Rule 242A		B, C, or N; see Rule 242C
Cable	C ^④	C	N	C ^③	C	B, C, or N; see Rule 242A		B, C, or N; see Rule 242C
Constant-current supply conductors: open or cable	B, C, or N; see Rule 242A					B, C, or N; see Rule 242A		B, C, or N; see Rules 242A and 242C
Communication conductors: open or cable, located in the supply space ^①	B, C, or N; see Rule 242C					B, C, or N; see Rules 242A and 242C		B, C, or N; see Rule 242C
Communication conductor: open or cable ^⑥	N	B ^⑦	C	B ^⑦	C	B ^⑦	C or N; see Rule 242A	B, C, or N; see Rule 242C

- ①The words *open* and *cable* appearing in the headings have the following meanings as applied to supply conductors: cable means the Type 1 cables described in Rule 241A; open means Type 2 cables described in Rule 241A and open wire.
- ②Lines that can fall outside the exclusive private rights-of-way shall comply with the grades specified for lines not on exclusive private rights-of-way.
- ③Supply conductors shall meet the requirements of Grade B construction if the supply circuits will not be promptly de-energized, both initially and following subsequent breaker operations, in the event of a contact with lower supply conductors or other grounded objects.
- ④If the wires are service drops, they may have Grade N sizes and tensions as set forth in Table 263-2.
- ⑤Grade N construction may be used where the communication conductors consist only of not more than one insulated twisted-pair or parallel-lay conductor, or where service drops only are involved.
- ⑥Grade C construction may be used if the voltage does not exceed 5.0 kV phase to phase or 2.9 kV phase to ground.
- ⑦The supply conductors need only meet the requirements of Grade C construction if both of the following conditions are fulfilled:
 - (a) The supply voltage will be promptly removed from the communications plant by de-energization or other means, both initially and following subsequent circuit-breaker operations in the event of a contact with the communications plant.
 - (b) The voltage and current impressed on the communications plant in the event of a contact with the supply conductors are not in excess of the safe operating limit of the communications-protective devices.
- ⑧Grade C construction may be used if the current cannot exceed 7.5 A or the open-circuit voltage of the transformer supplying the circuit does not exceed 2.9 kV.
- ⑨Communication circuits located below supply conductors shall not affect the grade of construction of the supply circuits.
- ⑩There is no intent to require Grade B over ordinary streets and highways.

**Table 242-2—
Grades of construction for communication conductors alone or
in upper position of crossing or on joint poles**

(The voltages listed in this table are phase-to-ground values for: effectively grounded ac circuits, two-wire grounded circuits, or center-grounded dc circuits; otherwise phase-to-phase values shall be used. The grade of construction for supply conductors, as indicated across the top of the table, shall also meet the requirements for any lines at lower levels except when otherwise noted.) (Placing of communication conductors at higher levels at crossings or on jointly used poles should generally be avoided, unless the supply conductors are trolley-contact conductors and their associated feeders.)

Conductors, tracks, and rights-of-way at lower levels	Communication conductors (communication conductors, open or cable, including those run in the supply space)
Exclusive private right-of-way	N
Common or public rights-of-way	N
Railroad tracks, limited-access highways, ^① and navigable waterways requiring waterway crossing permits	B
Constant-potential supply conductors ^① 0 to 750 V Open or cable	N
750 V to 2.9 kV Open or cable	C
Exceeding 2.9 kV Open Cable	B C
Constant-current supply conductors ^① 0 to 7.5 A Open ^②	C
Exceeding 7.5 A Open ^②	B ^③
Communication conductors, open or cable, including those run in the supply space	B, C, or N ^④

①The words *open* and *cable* appearing in the headlines have the following meaning as applied to supply conductors: cable means Type 1 cables as described in Rule 241A1; open means open-wire and also Type 2 cables, as described in Rule 241A2.

②Where constant-current circuits are in Type 1 cable, the grade of construction shall be based on the nominal full-load voltage.

③Grade C construction may be used if the open-circuit voltage of the transformer supplying the circuit does not exceed 2.9 kV.

④See Rule 242C.

⑤There is no intent to require Grade B over ordinary streets and highways.

243. Grades of construction for line supports

A. Structures

The grade of construction shall be that required for the highest grade of conductors supported except as modified by the following:

1. The grade of construction of jointly used structures, or structures used only by communication lines, need not be increased merely because the communication wires carried on such structures cross over trolley-contact conductors of 0 to 750 V to ground.
2. Structures carrying supply service drops of 0 to 750 V to ground shall have a grade of construction not less than that required for supply line conductors of the same voltage.
3. Where the communication lines cross over supply conductors and a railroad in the same span and Grade B is required by Rule 241C3b for the communication conductors, due to the presence of railroad tracks, the grade of the structures shall be B.
4. The grade of construction required for a conflicting structure (first circuit) shall be determined from the requirements of Rule 242 for crossings. The conflicting structure's conductors (first circuit) shall be assumed to cross the other circuit's conductors (second circuit) for the purposes of determining the grade of construction required for the conflicting structure.

NOTE: The resulting structure grade requirement could result in a higher grade of construction for the structure than for the conductors carried thereon.

B. Crossarms and support arms

The grade of construction shall be that required for the highest grade of conductors carried by the arm concerned except as modified by the following:

1. The grade of construction of arms carrying only communication conductors need not be increased merely because the conductors cross over trolley-contact conductors of 0 to 750 V to ground.
2. Arms carrying supply service drops of 0 to 750 V to ground shall have a grade of construction not less than that required for supply line conductors of the same voltage.
3. Where communication lines cross over supply conductors and a railroad in the same span and Grade B is required by Rule 241C3b for the communication conductors due to the presence of railroad tracks, the grade of the arm shall be B.

C. Pins, armless construction brackets, insulators, and conductor fastenings

The grade of construction for pins, armless construction brackets, insulators, and conductor fastenings shall be that required for the conductor concerned except as modified by the following:

1. The grade of construction need not be increased merely because the supported conductors cross over trolley-contact conductors of 0 to 750 V to ground.
2. Supply service drops of 0 to 750 V to ground require only the same grade of construction as supply line conductors of the same voltage.
3. When Grade B construction is required by Rule 241C3b for the communication conductors due to the presence of railroad tracks, Grade B construction shall be used when supporting communication lines that cross over supply conductors and a railroad in the same span.
4. When communication conductors are required to meet Grade B or C, only the requirements for mechanical strength for these grades are required.
5. Insulators for use on open conductor supply lines shall meet the requirements of Section 27 for all grades of construction.

Section 25. Loadings for Grades B and C

250. General loading requirements and maps

A. General

1. It is necessary to assume the wind and ice loads that may occur on a line. Three weather loadings are specified in Rules 250B, 250C, and 250D. Where all three rules apply, the required loading shall be the one that has the greatest effect.
2. Where construction or maintenance loads exceed those imposed by Rule 250A1, the assumed loadings shall be increased accordingly. When temporary loads, such as lifting of equipment, stringing operations, or a worker on a structure or its component, are to be imposed on a structure or component, the strength of the structure or component should be taken into account or other provisions should be made to limit the likelihood of adverse effects of structure or component failure.

NOTE: Other provisions could include cranes that can support the equipment loads, guard poles and spotters with radios, and stringing equipment capable of promptly halting stringing operations.

3. It is recognized that loadings actually experienced in certain areas in each of the loading districts may be greater, or in some cases, may be less than those specified in these rules. In the absence of a detailed loading analysis, using the same respective statistical methodologies used to develop the maps in Rule 250C or 250D, no reduction in the loadings specified therein shall be made without the approval of the administrative authority.
4. The structural capacity provided by meeting the loading and strength requirements of Sections 25 and 26 provides sufficient capability to resist earthquake ground motions.

B. Combined ice and wind district loading

Three general degrees of district loading due to weather conditions are recognized and are designated as heavy, medium, and light loading. Figure 250-1 shows the districts where these loadings apply.

NOTE: The localities are classified in the different loading districts according to the relative simultaneous prevalence of the wind velocity and thickness of ice that accumulates on wires. Light loading is for places where little, if any, ice accumulates on wires.

Table 250-1 shows the radial thickness of ice and the wind pressures to be used in calculating loads. Ice is assumed to weigh 913 kg/m³ (57 lb/ft³).

C. Extreme wind loading

If no portion of a structure or its supported facilities exceeds 18 m (60 ft) above ground or water level, the provisions of this rule are not required, except as specified in Rule 261A1c, 261A2e, or 261A3d. Where a structure or its supported facilities exceeds 18 m (60 ft) above ground or water level the structure and its supported facilities shall be designed to withstand the extreme wind load associated with the Basic Wind Speed, as specified by Figure 250-2. The wind pressures calculated shall be applied to the entire structure and supported facilities without ice. The following formula shall be used to calculate wind load.

$$\text{Load in newtons} = 0.613 \cdot (V_{m/s})^2 \cdot k_z \cdot G_{RF} \cdot I \cdot C_f \cdot A(m^2)$$

$$\text{Load in pounds} = 0.00256 \cdot (V_{mi/h})^2 \cdot k_z \cdot G_{RF} \cdot I \cdot C_f \cdot A(ft^2)$$

where

0.613 Velocity-pressure numerical coefficient reflects the mass density of air
 0.00256 for the standard atmosphere, i.e., temperature of 15 °C (59 °F) and sea level pressure of 760 mm (29.92 in) of mercury. The numerical coefficient 0.613 metric (0.00256 customary) shall be used except where sufficient climatic data are available to justify the selection of a different value of this factor for a design application.

Ambient air density value, the constants 0.613, metric, and 0.00256, customary, reflects the mass density of air for the standard atmosphere, i.e., temperature of 15 °C (59 °F) and sea level pressure of 760 mm (29.92 in) of mercury

k_z Velocity pressure exposure coefficient, as defined in Rule 250C1, Table 250-2

V Basic wind speed, 3 s gust wind speed in m/s at 10 m (mi/h at 33 ft) aboveground, Figure 250-2

G_{RF} Gust response factor, as defined in Rule 250C2

I Importance factor, 1.0 for utility structures and their supported facilities

C_f Force coefficient (shape factor). As defined in Rule 252B.

A Projected wind area, m^2 (ft^2)

The wind pressure parameters (k_z , V , and G_{RF}) are based on open terrain with scattered obstructions (Exposure Category C as defined in ASCE 7-05). Exposure Category C is the basis of the NESC extreme wind criteria. Topographical features such as ridges, hills, and escarpments may increase the wind loads on site-specific structures. A Topographic Factor, K_{zt} , from ASCE 7-05, may be used to account for these special cases.

1. Velocity pressure exposure coefficient, k_z

The velocity pressure exposure coefficient, k_z , is based on the height, h , to the center-of-pressure of the wind area for the following load applications:

- a. k_z for the structure is based on 0.67 of the total height, h , of the structure above ground line.

NOTE: In Table 250-2, for $h \leq 75$ m (250 ft), the structure k_z values are adjusted for the wind load to be determined at the center-of-pressure of the structure assumed to be at 0.67 h . The wind pressure is assumed uniformly distributed over the structure face normal to the wind.

- b. k_z for the wire is based on the height, h , of the wire at the structure.

NOTE: In special terrain conditions (i.e., mountainous terrain and canyon) where the height of the wire aboveground at mid-span may be substantially higher than at the structure, engineering judgment may be used in determining an appropriate value for the wire k_z .

- c. k_z for a specific structure location or component is based on the height, h , to the center-of-pressure of the wind area being considered.

The selected values of k_z , are tabulated in Table 250-2. When h is > 75 m (250 ft), the formulas shall be used to determine a k_z value.

2. Gust response factor, G_{RF}

Selected values of the structure and wire gust response factors are tabulated in Table 250-3. The structure gust response factor, G_{RF} , is determined using the total structure height, h . The wire gust response factor is determined using the height of the wire at the structure, h , and the design wind span, L . The structure and wire gust response factors may also be determined using the formulas in Table 250-3. For values of $h > 75$ m (250 ft) and $L > 600$ m (2000 ft) the G_{RF} shall be determined using the formulas in Table 250-3. In special terrain conditions (i.e., mountainous terrain and canyon) where the height of the conductor aboveground at mid-span

may be substantially higher than at the attachment point, engineering judgment may be used in determining an appropriate value for the wire G_{RF} . Wire attachment points that are 18 m (60 ft) or less above ground or water level must be considered if the total structure height is greater than 18 m (60 ft) above ground or water.

When calculating a wind load at a specific structure location, the structure gust response factor, G_{RF} , determined using the total structure height, h , shall be used. The gust response factor, G_{RF} , to be used on components, such as antennas, transformers, etc., shall be the structure gust response factor.

D. Extreme ice with concurrent wind loading

If no portion of a structure or its supported facilities exceeds 18 m (60 ft) above ground or water level, the provisions of this rule are not required. Where a structure or its supported facilities exceeds 18 m (60 ft) above ground or water level, the structure and its supported facilities shall be designed to withstand the ice and wind load associated with the Uniform Ice Thickness and Concurrent Wind Speed, as specified by Figure 250-3. The wind pressures for the concurrent wind speed shall be as indicated in Table 250-4. The wind pressures calculated shall be applied to the entire structure and supported facilities without ice and to the iced wire diameter determined in accordance with Rule 251.

Ice is assumed to weigh 913 kg/m^3 (57 lb/ft^3).

1. For Grade B, the radial thickness of ice from Figure 250-3 shall be multiplied by a factor of 1.00.
2. For Grade C, the radial thickness of ice from Figure 250-3 shall be multiplied by a factor of 0.80.
3. The concurrent wind shall be applied to the projected area resulting from Rules 250D1 and 250D2 multiplied by a factor of 1.00.

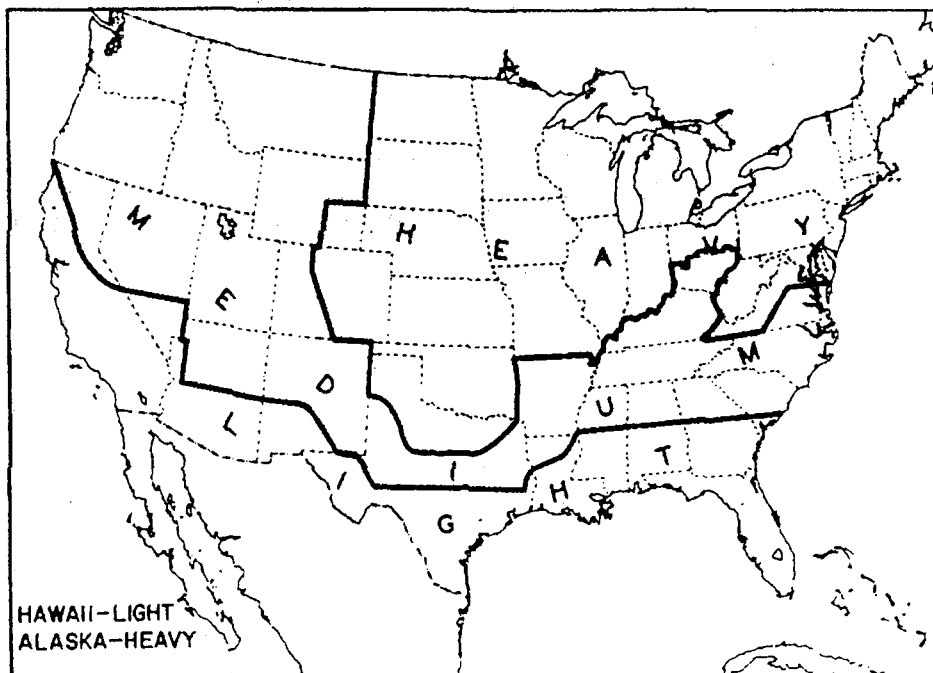

Figure 250-1—General loading map of United States with respect to loading of overhead lines

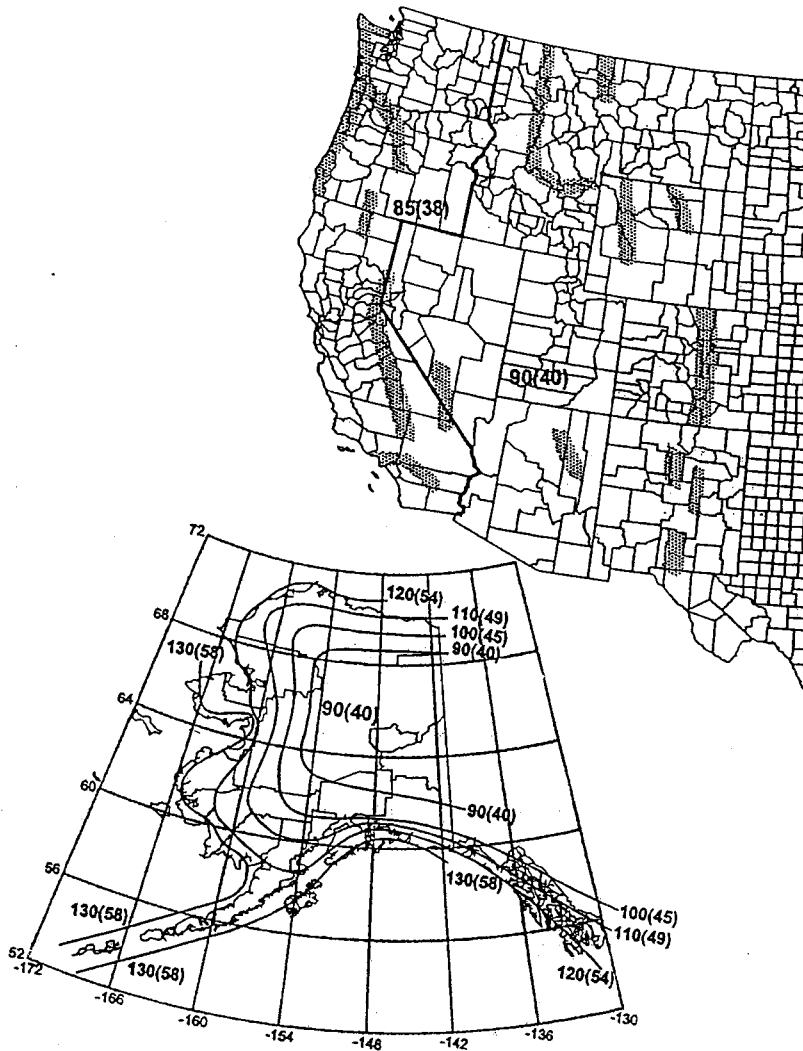
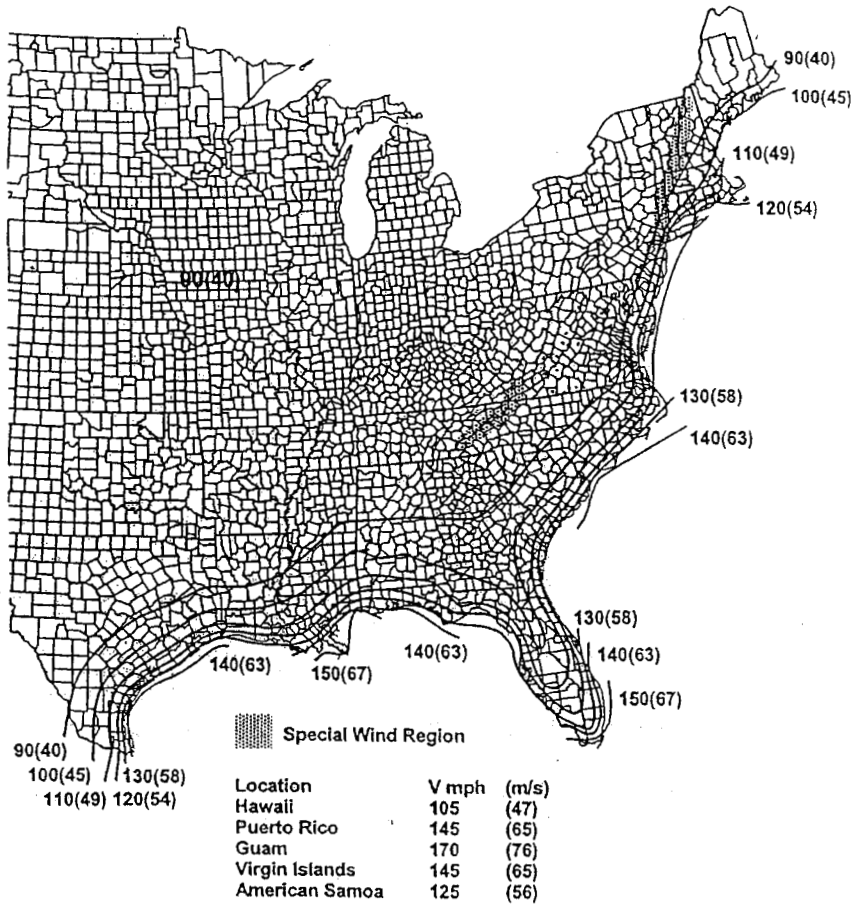

Figure 250-2(a)—Basic wind speeds

NOTE: Figure 250-2(a) reprinted with the permission of ASCE Publications, 1801 Alexander Bell Dr., Reston, VA 20191 from ASCE 7-05, Minimum Design Loads for Buildings and Other Structures. Copyright © 2005.



Notes:

1. Values are nominal design 3-second gust wind speeds in miles per hour (m/s) at 33 ft (10 m) above ground for Exposure C category.
2. Linear interpolation between wind contours is permitted.
3. Islands and coastal areas outside the last contour shall use the last wind speed contour of the coastal area.
4. Mountainous terrain, gorges, ocean promontories, and special wind regions shall be examined for unusual wind conditions.

Figure 250-2(b)—Basic wind speeds

NOTE: Figure 250-2(b) reprinted with the permission of ASCE Publications, 1801 Alexander Bell Dr., Reston, VA 20191 from ASCE 7-05, Minimum Design Loads for Buildings and Other Structures. Copyright © 2005.

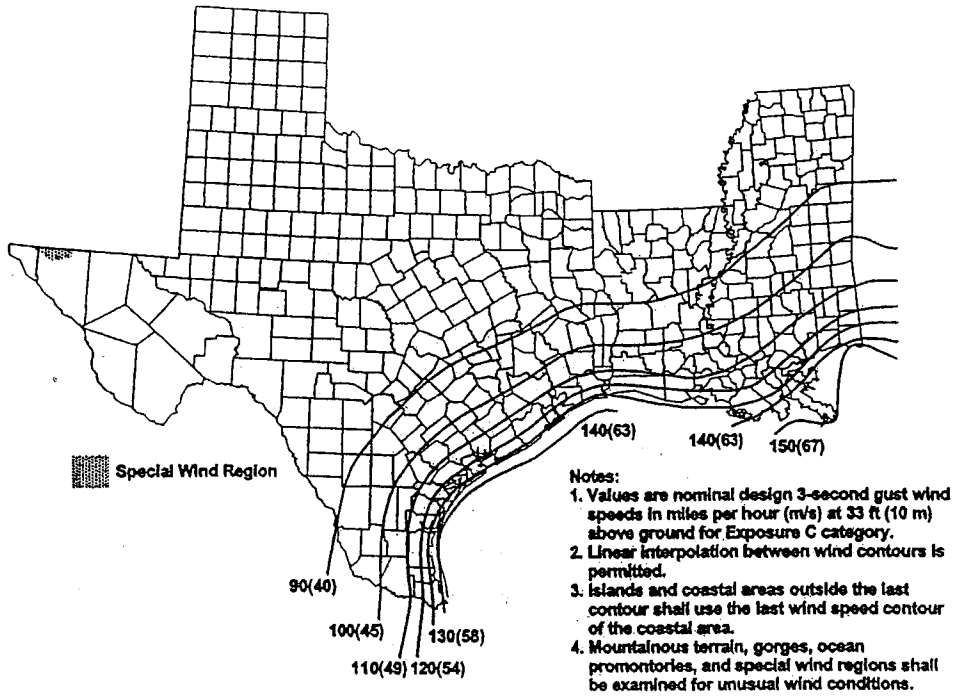

Figure 250-2(c)—Western Gulf of Mexico hurricane coastline

NOTE: Figure 250-2(c) reprinted with the permission of ASCE Publications, 1801 Alexander Bell Dr., Reston, VA 20191 from ASCE 7-05, Minimum Design Loads for Buildings and Other Structures. Copyright © 2005.

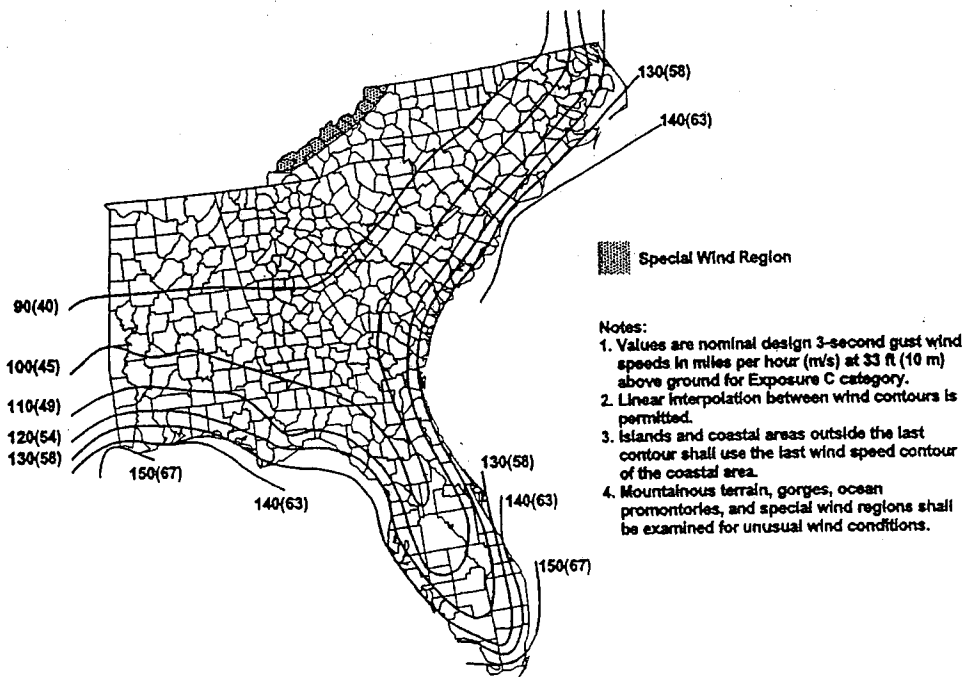

Figure 250-2(d)—Eastern Gulf of Mexico and southeastern US hurricane coastline

NOTE: Figure 250-2(d) reprinted with the permission of ASCE Publications, 1801 Alexander Bell Dr., Reston, VA 20191 from ASCE 7-05, Minimum Design Loads for Buildings and Other Structures. Copyright © 2005.

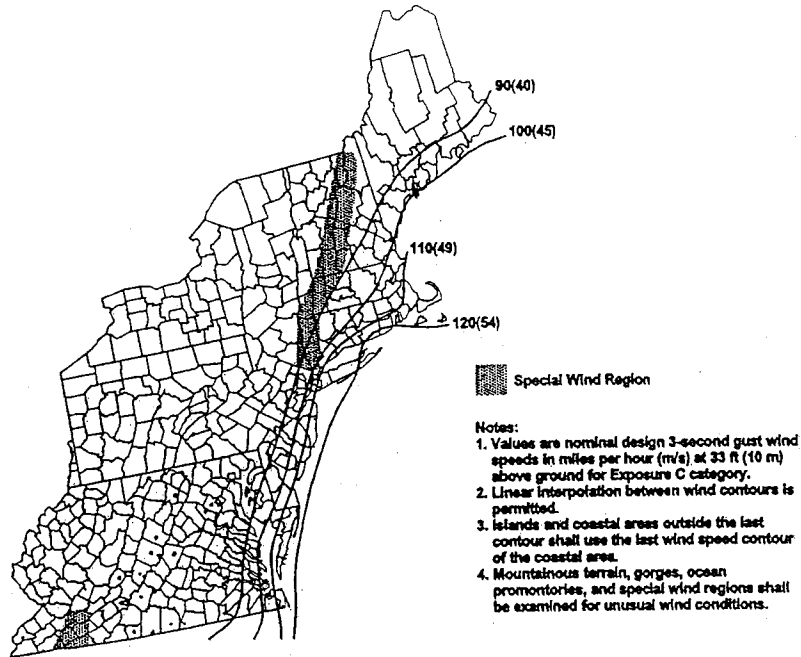
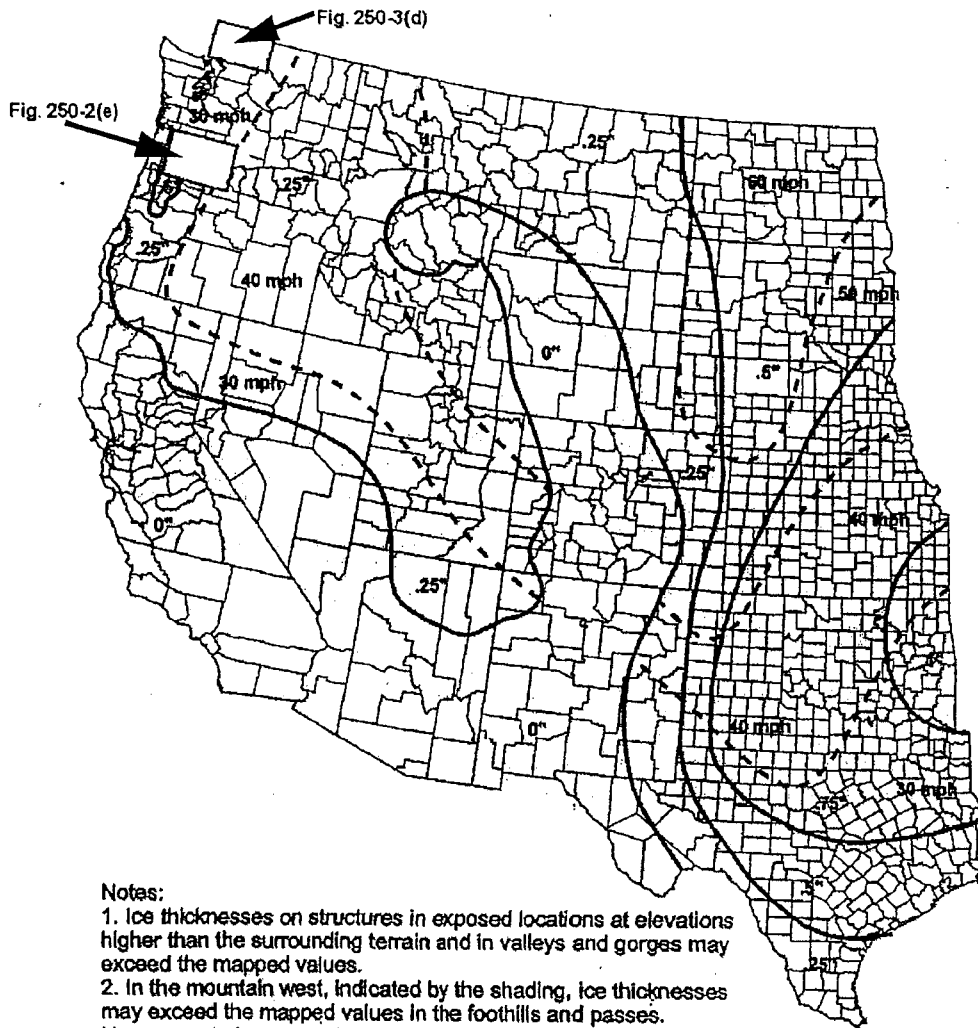

Figure 250-2(e)—Mid and northern Atlantic hurricane coastline

NOTE: Figure 250-2(e) reprinted with the permission of ASCE Publications, 1801 Alexander Bell Dr., Reston, VA 20191 from ASCE 7-05, Minimum Design Loads for Buildings and Other Structures. Copyright © 2005.



Notes:

1. Ice thicknesses on structures in exposed locations at elevations higher than the surrounding terrain and in valleys and gorges may exceed the mapped values.
2. In the mountain west, indicated by the shading, ice thicknesses may exceed the mapped values in the foothills and passes. However, at elevations above 5,000 ft, freezing rain is unlikely.
3. In the Appalachian Mountains, indicated by the shading, ice thicknesses may vary significantly over short distances.

50-YEAR MEAN RECURRENCE INTERVAL UNIFORM ICE THICKNESSES DUE TO FREEZING RAIN WITH CONCURRENT 3-SECOND GUST SPEEDS: CONTIGUOUS 48 STATES.

Figure 250-3(a)—Uniform ice thickness with concurrent wind

NOTE: Figure 250-3(a) reprinted with the permission of ASCE Publications, 1801 Alexander Bell Dr., Reston, VA 20191 from ASCE 7-05, Minimum Design Loads for Buildings and Other Structures. Copyright © 2005.

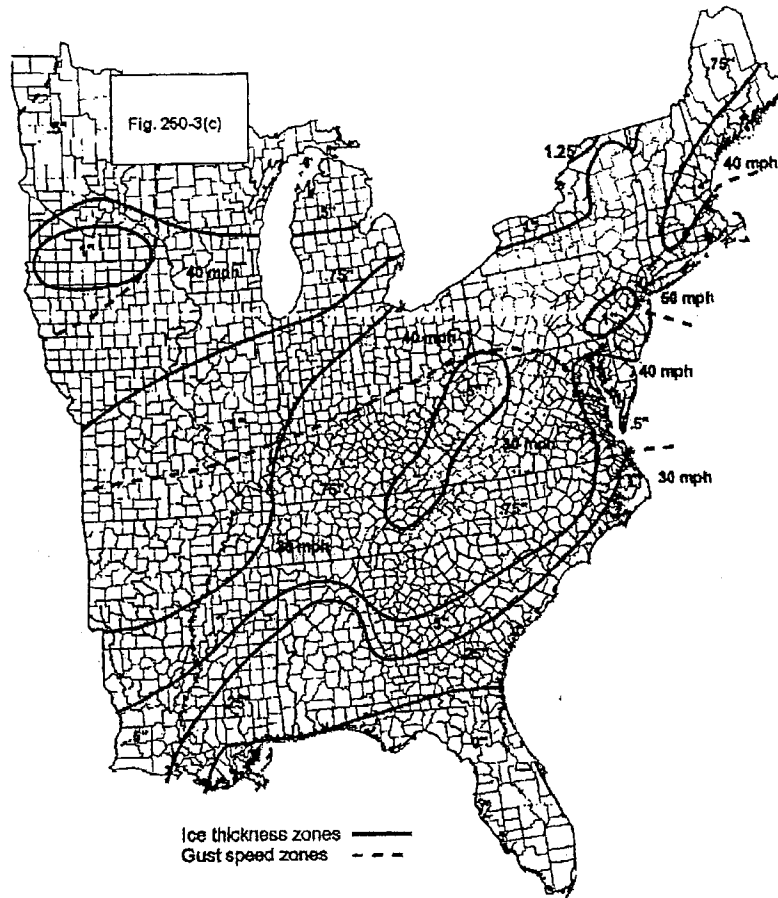

50-YEAR MEAN RECURRENCE INTERVAL UNIFORM ICE THICKNESSES DUE TO FREEZING RAIN WITH CONCURRENT 3-SECOND GUST SPEEDS: CONTIGUOUS 48 STATES.

Figure 250-3(b)—Uniform ice thickness with concurrent wind

NOTE: Figure 250-3(b) reprinted with the permission of ASCE Publications, 1801 Alexander Bell Dr., Reston, VA 20191 from ASCE 7-05, Minimum Design Loads for Buildings and Other Structures. Copyright © 2005.

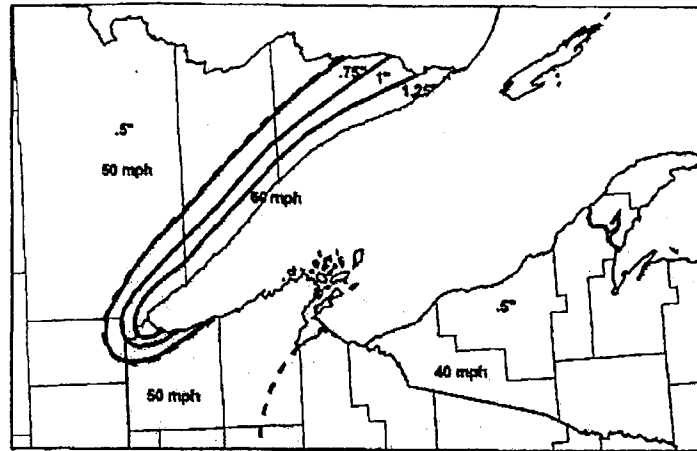

LAKE SUPERIOR DETAIL

Figure 250-3(c)—Uniform ice thickness with concurrent wind

NOTE: Figure 250-3(c) reprinted with the permission of ASCE Publications, 1801 Alexander Bell Dr., Reston, VA 20191 from ASCE 7-05, Minimum Design Loads for Buildings and Other Structures. Copyright © 2005.

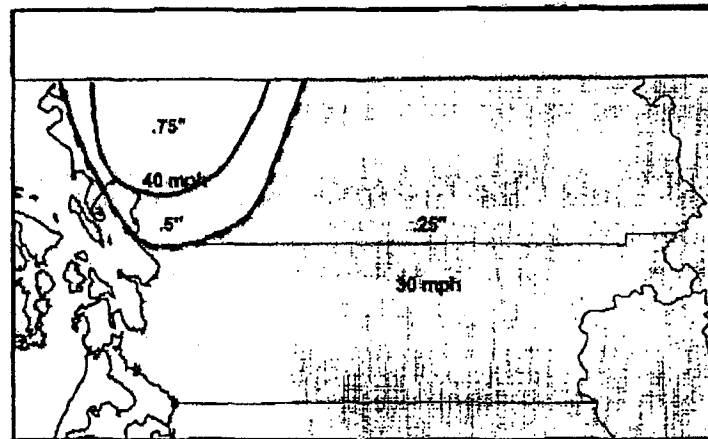

FRASER VALLEY, WASHINGTON DETAIL

Figure 250-3(d)—Uniform ice thickness with concurrent wind

NOTE: Figure 250-3(d) reprinted with the permission of ASCE Publications, 1801 Alexander Bell Dr., Reston, VA 20191 from ASCE 7-05, Minimum Design Loads for Buildings and Other Structures. Copyright © 2005.

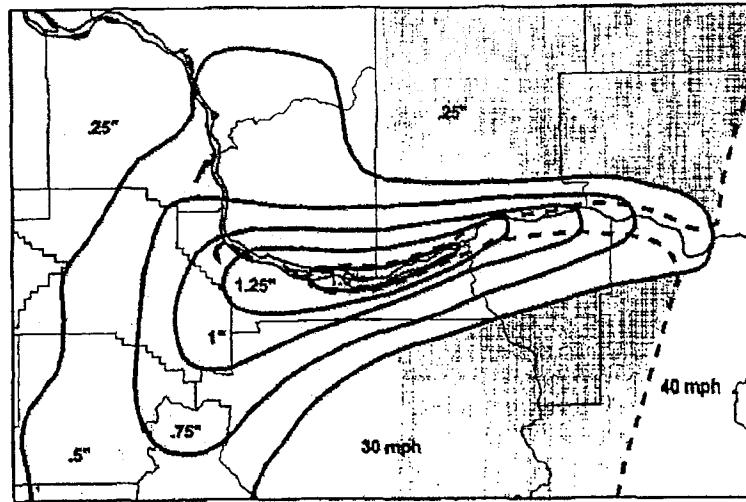

COLUMBIA RIVER GORGE, WASHINGTON DETAIL

Figure 250-3(e)—Uniform ice thickness with concurrent wind

NOTE: Figure 250-3(e) reprinted with the permission of ASCE Publications, 1801 Alexander Bell Dr., Reston, VA 20191 from ASCE 7-05, Minimum Design Loads for Buildings and Other Structures. Copyright © 2005.

NOTE: Figure 250-3(f) reprinted with the permission of ASCE Publications, 1801 Alexander Bell Dr., Reston, VA 20191 from ASCE 7-05, Minimum Design Loads for Buildings and Other Structures. Copyright © 2005.

Figure 250-3(f)—Uniform ice thickness with concurrent wind

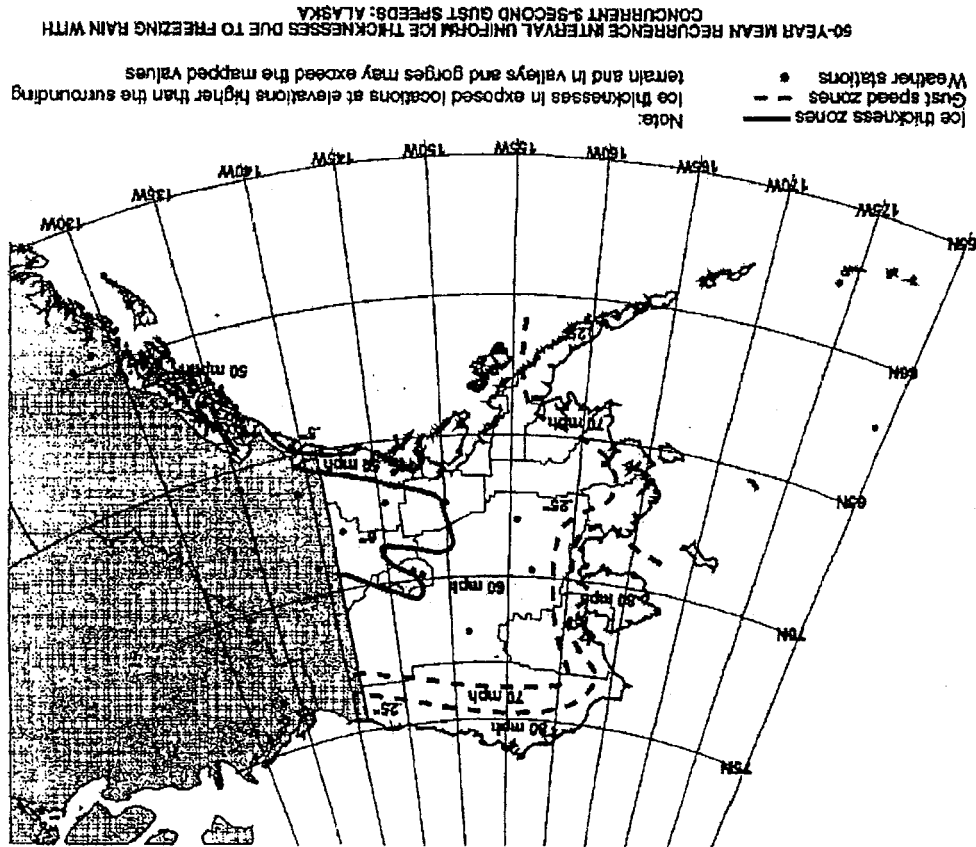

Table 250-1—Ice, wind, and temperature

	Loading districts (for use with Rule 250B)			Extreme wind loading (for use with Rule 250C)	Extreme ice loading with concurrent wind (for use with Rule 250D)
	Heavy	Medium	Light		
Radial thickness of ice (mm)	12.5	6.5	0	0	See Figure 250-3
(in)	0.50	0.25	0	0	See Figure 250-3
Horizontal wind pressure (Pa)	190	190	430	See Figure 250-2	See Figure 250-3
(lb/ft ²)	4	4	9	See Figure 250-2	See Figure 250-3
Temperature (°C)	-20	-10	-1	+15	-10
(°F)	0	+15	+30	+60	+15

Table 250-2—Velocity pressure exposure coefficient k_z , structure, structure location, component, and wire

Height, h (m)	Height, h (ft)	k_z (Structure)	k_z (Wire, structure, location, and component)
≤ 10	≤ 33	0.9	1.0
> 10 to 15	> 33 to 50	1.0	1.1
> 15 to 25	> 50 to 80	1.1	1.2
> 25 to 35	> 80 to 115	1.2	1.3
> 35 to 50	> 115 to 165	1.3	1.4
> 50 to 75	> 165 to 250	1.4	1.5
> 75	> 250	Use formulas	Use formulas
Formulas (metric):			
Structure	$k_z = 2.01 \cdot (0.67 \cdot h/275)^{(2/9.5)}$ $k_z = 1.85$		$h \leq 275$ m $h > 275$ m
Wire, structure location, and component	$k_z = 2.01 \cdot (h/275)^{(2/9.5)}$ $k_z = 2.01$		$h \leq 275$ m $h > 275$ m
Formulas (customary):			
Structure	$k_z = 2.01 \cdot (0.67 \cdot h/900)^{(2/9.5)}$ $k_z = 1.85$		$h \leq 900$ ft $h > 900$ ft
Wire, structure location, and component	$k_z = 2.01 \cdot (h/900)^{(2/9.5)}$ $k_z = 2.01$		$h \leq 900$ ft $h > 900$ ft
h = Structure, structure location, and component and wire height as defined in Rule 250C1			
Minimum $k_z = 0.85$			
Formulas are for Exposure Category C, ASCE 7-05.			

NOTE: Calculations in this table are based on the maximum values in the stated ranges.

m

Table 250-3—Structure and wire gust response factors, G_{RF}

Height	Structure	Wire G_{RF} , span length, L (m)						
		h (m)	G_{RF}	≤ 75	$75 < L \leq 150$	$150 < L \leq 225$	$225 < L \leq 300$	$300 < L \leq 450$
≤ 10	1.00	0.91	0.86	0.79	0.75	0.72	0.69	①
> 10 to 15	0.96	0.87	0.82	0.76	0.73	0.70	0.67	①
> 15 to 25	0.93	0.85	0.80	0.75	0.71	0.69	0.66	①
> 25 to 35	0.89	0.82	0.78	0.73	0.70	0.68	0.65	①
> 35 to 50	0.86	0.81	0.77	0.72	0.69	0.67	0.64	①
> 50 to 75	0.83	0.79	0.75	0.71	0.68	0.66	0.63	①
> 75	①	①	①	①	①	①	①	①

Formulas:

Structure $G_{RF} = [1 + (2.7 \cdot E_s \cdot B_s^{0.5})]/k_v^2$

Wire $G_{RF} = [1 + (2.7 \cdot E_w \cdot B_w^{0.5})]/k_v^2$

$E_s = 0.346 \cdot [10/(0.67 \cdot h)]^{1/7}$

$E_w = 0.346 \cdot (10/h)^{1/7}$

$B_s = 1/(1 + 0.56 \cdot (0.67 \cdot h)/67)$

$B_w = 1/(1 + 0.8 \cdot L/67)$

Where:

E_w = Wire exposure factor

E_s = Structure exposure factor

B_w = Dimensionless response term corresponding to the quasi-static background wind loads on the wire

B_s = Dimensionless response term corresponding to the quasi-static background wind loads on the structure

$k_v = 1.43$

h = Structure or wire height, as defined in Rule 250C2, in meters

L = Design wind span, in meters

Formulas are for Exposure Category C, ASCE 7-05.

①For heights greater than 75 m and/or spans greater than 600 m, the formulas shall be used.

ft

Table 250-3—Structure and wire gust response factors, G_{RF}

Height	Structure	Wire G_{RF} , span length, L (ft)						
		≤ 250	$250 < L \leq 500$	$500 < L \leq 750$	$750 < L \leq 1000$	$1000 < L \leq 1500$	$1500 < L \leq 2000$	$L > 2000$ ①
≤ 33	1.02	0.93	0.86	0.79	0.75	0.73	0.69	①
> 33 to 50	0.97	0.88	0.82	0.76	0.72	0.70	0.67	①
> 50 to 80	0.93	0.86	0.80	0.75	0.71	0.69	0.66	①
> 80 to 115	0.89	0.83	0.78	0.73	0.70	0.68	0.65	①
> 115 to 165	0.86	0.82	0.77	0.72	0.69	0.67	0.64	①
> 165 to 250	0.83	0.80	0.75	0.71	0.68	0.66	0.63	①
> 250	①	①	①	①	①	①	①	①

Formulas:

Structure $G_{RF} = [1 + (2.7 \cdot E_s \cdot B_s^{0.5})]/k_v^2$

Wire $G_{RF} = [1 + (2.7 \cdot E_w \cdot B_w^{0.5})]/k_v^2$

$E_s = 0.346 \cdot [33/(0.67 \cdot h)]^{1/7}$

$E_w = 0.346 \cdot (33/h)^{1/7}$

$B_s = 1/(1 + 0.56 \cdot (0.67 \cdot h)/220)$

$B_w = 1/(1 + 0.8 \cdot L/220)$

Where:

E_w = Wire exposure factor

E_s = Structure exposure factor

B_w = Dimensionless response term corresponding to the quasi-static background wind loads on the wire

B_s = Dimensionless response term corresponding to the quasi-static background wind loads on the structure

$k_v = 1.43$

h = Structure or wire height, as defined in Rule 250C2, in feet

L = Design wind span, in feet

Formulas are for Exposure Category C, ASCE 7-05.

①For heights greater than 250 ft and/or spans greater than 2000 ft, the formulas shall be used.

Table 250-4—Wind speed conversions to pressure
To be used only with the extreme ice with concurrent wind loading
of Rule 250D and Figure 250-3.

Wind speed (mph)	Horizontal wind pressure	
	Pascals	lb/ft ²
30	110	2.3
40	190	4.0
50	310	6.4
60	440	9.2

251. Conductor loading

A. General

Ice and wind loads are specified in Rule 250.

1. Where a cable is attached to a messenger, the specified loads shall be applied to both cable and messenger.
2. In determining wind loads on a conductor or cable without ice covering, the assumed projected area shall be that of a smooth cylinder whose outside diameter is the same as that of the conductor or cable. The force coefficient (shape factor) for cylindrical surfaces is assumed to be 1.0.

NOTE: Experience has shown that as the size of multiconductor cable decreases, the actual projected area decreases, but the roughness factor increases and offsets the reduction in projected area.

3. An appropriate mathematical model shall be used to determine the wind and weight loads on ice-coated conductors and cables. In the absence of a model developed in accordance with Rule 251A4, the following mathematical model shall be used:
 - a. On a conductor, lashed cable, or multiple-conductor cable, the coating of ice shall be considered to be a hollow cylinder touching the outer strands of the conductor or the outer circumference of the lashed cable or multiple-conductor cable.
 - b. On bundled conductors, the coating of ice shall be considered as individual hollow cylinders around each subconductor.
4. It is recognized that the effects of conductor stranding or of non-circular cross section may result in wind and ice loadings more or less than those calculated according to assumptions stated in Rules 251A2 and 251A3. No reduction in these loadings is permitted unless testing or a qualified engineering study justifies a reduction.

B. Load components

The load components shall be determined as follows:

1. Vertical load component

The vertical load on a wire, conductor, or messenger shall be its own weight plus the weight of conductors, spacers, or equipment that it supports, ice covered where required by Rule 250.

2. Horizontal load component

The horizontal load shall be the horizontal wind pressure determined under Rule 250 applied at right angles to the direction of the line using the projected area of the conductor or messenger and conductors, spacers, or equipment that it supports, ice covered where required by Rule 250.

3. Total load

The total load on each wire, conductor, or messenger shall be the resultant of components 1 and 2 above, calculated at the applicable temperature in Table 251-1, plus the corresponding constant in Table 251-1. In all cases the conductor or messenger tension shall be computed from this total load.

Table 251-1—Temperatures and constants

	Loading districts (for use with Rule 250B)			Extreme wind loading (for use with Rule 250C)	Extreme ice loading with concurrent wind (For use with Rule 250D)
	Heavy	Medium	Light		
Temperature(°C)	-20	-10	-1	+15	-10
(°F)	0	+15	+30	+60	+14
Constant to be added to the resultant (all conductors) (N/m)	4.4	2.9	0.73	0.0	0.0
(lb/ft)	0.30	0.20	0.05	0.0	0.0

252. Loads on line supports

A. Assumed vertical loads

The vertical loads on poles, towers, foundations, crossarms, pins, insulators, and conductor fastenings shall be their own weight plus the weight that they support, including all wires and cables, in accordance with Rules 251A and 251B1, together with the effect of any difference in elevation of supports. Loads due to radial ice shall be computed on wires, cables, and messengers, but need not be computed on supports.

B. Assumed transverse loads

The total transverse loads on poles, towers, foundations, crossarms, pins, insulators, and conductor fastenings shall include the following:

1. Transverse loads from conductors and messengers

The transverse loads from conductors and messengers shall be the horizontal load determined by Rule 251.

EXCEPTION: In medium- and heavy-loading districts, where supporting structures carry ten or more conductors on the same crossarm, not including cables supported by messengers, and where the horizontal pin spacing does not exceed 380 mm (15 in), the transverse wind load may be calculated on two-thirds of the total number of such conductors if at least ten conductors are used in the calculations.

2. Wind loads on structures

The transverse load on structures and equipment shall be computed by applying, at right angles to the direction of the line, the appropriate horizontal wind pressure determined under Rule 250. This load shall be calculated using the projected surfaces of the structures and equipment supported thereon, without ice covering. The following shape factors shall be used.

a. Cylindrical structures and components

Wind loads on straight or tapered cylindrical structures or structures composed of numerous narrow relatively flat panels that combine to form a total cross section that is circular or elliptical in shape shall be computed using a shape factor of 1.0.

b. Flat surfaced (not latticed) structures and components

Wind loads on structures or components, having solid or enclosed flat sided cross sections that are square or rectangular, with rounded corners, shall be computed using a force coefficient (shape factor) of 1.6.

c. Latticed structures

Wind loads on square or rectangular latticed structures or components shall be computed using a force coefficient (shape factor) of 3.2 on the sum of the projected areas of the members of the front face if structural members are flat surfaced or 2.0 if structural surfaces are cylindrical. The total, however, need not exceed the load that would occur on a solid structure of the same outside dimension.

EXCEPTION: The force coefficient (shape factor) listed under Rules 252B2a, 252B2b, and 252B2c may be reduced if wind tunnel tests or a qualified engineering study justifies a reduction.

3. At angles

Where a change in direction of wires occurs, the loads on the structure, including guys, shall be the vector sum of the transverse wind load and the wire tension load. In calculating these loads, a wind direction shall be assumed that will give the maximum resultant load. Proper reduction may be made to the loads to account for the reduced wind pressure on the wires resulting from the angularity of the application of the wind on the wire.

4. Span lengths

The calculated transverse load shall be based on the average of the two spans adjacent to the structure concerned.

C. Assumed longitudinal loading

1. Change in grade of construction

The longitudinal loads on supporting structures, including poles, towers, and guys at the ends of sections required to be of Grade B construction, when located in lines of lower than Grade B construction, shall be taken as an unbalanced pull in the direction of the higher grade section equal to the larger of the following values:

a. Conductors with rated breaking strength of 13.3 kN (3000 lb) or less

The pull of two-thirds, but not less than two, of the conductors having a rated breaking strength of 13.3 kN (3000 lb) or less. The conductors selected shall produce the maximum stress in the support.

b. Conductors with rated breaking strength of more than 13.3 kN (3000 lb)

The pull resulting from one conductor when there are eight or less conductors (including overhead ground wires) having rated breaking strength of more than 13.3 kN (3000 lb), and the pull of two conductors when there are more than eight conductors. The conductors selected shall produce the maximum stress in the support.

2. Jointly used poles at crossings over railroads, communication lines, or limited access highways

Where a joint line crosses a railroad, a communication line, or a limited access highway, and Grade B is required for the crossing span, the tension in the communication conductors of the joint line shall be considered as limited to one-half their rated breaking strength, provided they are smaller than Stl WG No. 8 if of steel, or AWG No. 6 if of copper.

3. Deadends

The longitudinal load on a supporting structure at a deadend shall be an unbalanced pull equal to the tensions of all conductors and messengers (including overhead ground wires); except that with spans in each direction from the dead-end structure, the unbalanced pull shall be the difference in tensions.

4. Unequal spans and unequal vertical loads

The structure should be capable of supporting the unbalanced longitudinal load created by the difference in tensions in the wires in adjacent spans caused by unequal vertical loads or unequal spans.

5. Stringing loads

Consideration should be given to longitudinal loads that may occur on the structure during wire stringing operations.

6. Longitudinal capability

It is recommended that structures having a longitudinal strength capability be provided at reasonable intervals along the line.

7. Communication conductors on unguyed supports at railroad and limited access highway crossings

The longitudinal load shall be assumed equal to an unbalanced pull in the direction of the crossing of all open-wire conductors supported, the pull of each conductor being taken as 50% of its rated breaking strength in the heavy loading district, 33-1/3% in the medium loading district, and 22-1/4% in the light-loading district.

D. Simultaneous application of loads

Where a combination of vertical, transverse, or longitudinal loads may occur simultaneously, the structure shall be designed to withstand the simultaneous application of these loads.

NOTE: Under the extreme wind conditions of Rule 250C, an oblique wind may require greater structural strength than that computed by Rules 252B and 252C.

253. Load factors for structures, crossarms, support hardware, guys, foundations, and anchors

Loads due to the district loads in Rule 250B, the extreme wind loading condition in Rule 250C, and the extreme ice with concurrent wind condition in Rule 250D shall be multiplied by the load factors in Table 253-1 or the alternate load factors in Table 253-2. Table 253-1 shall be used with Table 261-1A. Table 253-2 shall be used with Table 261-1B. The alternate method, including alternate load factors of Table 253-2 and strength factors of Table 261-1B, shall not be used after July 31, 2010.

For wood and reinforced (not prestressed) concrete, two methods for determining the capacity are included herein. Either method meets the basic requirements for safety.

Table 253-1—Load factors for structures,^① crossarms, support hardware, guys, foundations, and anchors to be used with the strength factors of Table 261-1A

Load Factors			
	Grade B	Grade C	
		At crossings ^⑥	Elsewhere
Rule 250B loads Vertical loads ^③	1.50	1.90 ^⑤	1.90 ^⑤
Transverse loads Wind Wire tension	2.50 1.65 ^②	2.20 1.30 ^④	1.75 1.30 ^④
Longitudinal loads In general At deadends	1.10 1.65 ^②	No requirement 1.30 ^④	No requirement 1.30 ^④
Rule 250C loads	1.00	0.87 ^⑦	0.87 ^⑦
Rule 250D loads	1.00	1.00	1.00

①Includes pole.

②For guys and anchors associated with structures supporting communication conductors and cables only, this factor may be reduced to 1.33.

③Where vertical loads significantly reduce the stress in a structure member a vertical load factor of 1.0 should be used for the design of such member. Such member shall be designed for the worst case loading.

④For metal or prestressed concrete, portions of structures, crossarms, guys, foundations, and anchors, use a value of 1.10.

⑤For metal prestressed concrete, or fiber-reinforced polymer portions of structures and crossarms, guys, foundations, and anchors, use a value of 1.50.

⑥This applies only where a line crosses another supply or communication line (see Rule 241C and Table 242-1).

⑦For wind velocities above 100 mph (except Alaska), a factor of 0.75 may be used.

Table 253-2—Alternate load factors for wood and reinforced (not prestressed) concrete structures^{① ③} to be used with the strength factors of Table 261-1B

The alternate method, including alternate load factors of Table 253-2 and strength factors of Table 261-1B, shall not be used after 31 July 2010

	Load Factors			
	Grade B		Grade C	
	When Installed	At Replacement ^{② ③}	When Installed	At Replacement ^{② ③}
Rule 250B loads Vertical loads ^④	2.20	1.50	2.20	1.50
Transverse loads				
Wind (at crossings)	4.00	2.67	2.67	1.33
Wind (elsewhere)	4.00	2.67	2.00	1.33
Wire tension	2.00	1.33	1.33	1.00
Longitudinal loads				
In general	1.33	1.00	No requirement	No requirement
At deadends	2.00 ^⑥	1.33 ^⑦	1.33	1.00
Rule 250C loads	1.33	1.00	1.00	0.87 ^⑧
Rule 250D loads	1.33	1.00	1.33	1.00

①Includes poles.

②Where a wood structure is built for temporary service, the load factors at replacement may be used provided the designated fiber stress is not exceeded during the life of the structure. Where a reinforced concrete (not prestressed) structure is built for temporary service, the load factors at replacement may be used.

③When structure strength deteriorates to the level of the loads multiplied by the load factors required at replacement, the structure shall be replaced or rehabilitated. If a structure or component is replaced, it shall meet the "when installed" load factors at replacement. Rehabilitated portions of structures shall have load factors at the time of rehabilitation greater than of those required "at replacement."

④Where vertical loads significantly reduce the stress in a structural member, a vertical load factor of 1.0 should be used for the design of such member. Such members shall be designed for the worst-case loading.

⑤Metal portions of a structure may be designed using the load factors in Table 253-1.

⑥For unguayed wood poles supporting communication conductors and cables only, this factor may be reduced to 1.33.

⑦For unguayed wood poles supporting communication conductors and cables only, this factor may be reduced to 1.0.

⑧For wind velocities above 100 mph (except Alaska) a factor of 0.75 may be used.

Section 26. Strength requirements

260. General (see also Section 20)

A. Preliminary assumptions

1. It is recognized that deformation, deflections, or displacement of parts of the structure may change the effects of the loads assumed. In the calculation of stresses, allowance may be made for such deformation, deflection, or displacement of supporting structures including poles, towers, guys, crossarms, pins, conductor fastenings, and insulators when the effects can be evaluated. Such deformation, deflection, or displacement should be calculated using Rule 250 loads prior to application of the load factors in Rule 253. For crossings or conflicts, the calculations shall be subject to mutual agreement.
2. It is recognized that new materials may become available. While these materials are in the process of development, they must be tested and evaluated. Trial installations are permitted where the requirements of Rule 13A2 are met.

B. Application of strength factors

1. Structures shall be designed to withstand the appropriate loads multiplied by the load factors in Section 25 without exceeding their strength multiplied by the strength factors in Section 26.

NOTE: The latest edition of the following document may be used for providing information for determining the 5% lower exclusion limit strength of a FRP structure or component for use with an appropriate strength factor (Table 261-1A) and the specified NESC loads and load factors (Table 253-1): ASCE-111, Reliability-Based Design of Utility Pole Structures.

2. Unless otherwise specified, a strength factor of 0.80 shall be used for the extreme wind loading conditions specified in Rule 250C and for the extreme ice with concurrent wind specified in Rule 250D for all supported facilities.

NOTE: The latest edition (unless a specific edition is referenced) of the following documents are among those available for determining structure design capacity with the specified NESC loads, load factors, and strength factors:

ANSI/ASCE-10, Design of Latticed Steel Transmission Structures

ASCE-91, Design of Guyed Electrical Transmission Structure

ASCE-PCI, Guide for the Design of Prestressed Concrete Poles

ASCE-72, Design of Steel Transmission Pole Structures

ASCE-104, Recommended Practice For Fiber-Reinforced Polymer Products For Overhead Utility Line Structures

PCI, Design Handbook-Precast and Prestressed Concrete

ACI-318, Building Code Requirements for Structural Concrete (for reinforced concrete designs)

ACI-318, 1983, Building Code Requirements for Structural Concrete (for anchor bolt bond strength)

IEEE Std 751™-1990, IEEE Trial-Use Design Guide for Wood Transmission Structures [B38]

AISI, Specification for the Design of Cold-Formed Steel Structural Members

The Aluminum Association, Aluminum Design Manual

261. Grades B and C construction

A. Supporting structures

The strength requirements for supporting structures may be met by the structures alone or with the aid of guys or braces or both.

1. Metal, prestressed-, and reinforced-concrete structures
 - a. These structures shall be designed to withstand the loads in Rule 252 multiplied by the appropriate load factors in Table 253-1 or 253-2 without exceeding the permitted stress.
 - b. The permitted stress shall be the strength multiplied by the strength factors in Table 261-1A or 261-1B (where guys are used, see Rule 261C).
 - c. All structures including those below 18 m (60 ft) shall be designed to withstand, without conductors, the extreme wind load in Rule 250C applied in any direction on the structure.
 - d. Spliced and reinforced structures
Reinforcements or permanent splices to a supporting structure are permitted provided they develop the required strength of the structure.
 - e. The alternate method, including alternate load factors of Table 253-2 and strength factors of Table 261-1B, shall not be used after July 31, 2010.

2. Wood structures

Wood structures shall be of material and dimensions to meet the following requirements:

- a. Wood structures shall be designed to withstand the loads in Rule 252 multiplied by the appropriate load factors in Table 253-1 or 253-2, without exceeding the permitted stress level. The alternate method, including alternate load factors of Table 253-2 and strength factors of Table 261-1B, shall not be used after July 31, 2010.

NOTE: When determining a fiber stress for column loads, buckling needs to be considered.

EXCEPTION 1: When installed, naturally grown wood poles, acting as single-based structures or unbraced multiple-pole structures, shall meet the requirements of Rule 261A2a without exceeding the permitted stress level at the ground line for unguyed poles or at the points of attachment for guyed poles.

EXCEPTION 2: At a Grade B crossing, in a straight section of line, wood structures complying with the transverse strength requirements of Rule 261A2a, without the use of transverse guys, shall be considered as having the required longitudinal strength, providing the longitudinal strength is comparable to the transverse strength of the structure. This *EXCEPTION* does not modify the requirements of this rule for deadends.

EXCEPTION 3: At a Grade B crossing of a supply line over a highway or a communication line where there is an angle in the supply line, wood structures shall be considered as having the required longitudinal strength if all of the following conditions are met:

- (a) The angle is not over 20 degrees.
 - (b) The angle structure is guyed in the plane of the resultant of the conductor tensions. The tension in this guy under the loading in Rule 252 multiplied by a load factor of 2.0 shall not exceed the rated breaking strength multiplied by the strength factor in Table 261-1A.
 - (c) The angle structure has sufficient strength to withstand, without guys, the transverse loading of Rule 252 multiplied by the appropriate load factors in Table 253-1 or 253-2, which would exist if there were no angle at that structure without exceeding the permitted stress level.
- b. Permitted stress level
 - (1) Natural wood pole
The permitted stress level of natural wood poles of various species meeting the requirements of ANSI O5.1-1992 shall be determined by multiplying the designated fiber stress set forth in that standard by the appropriate strength factors in Table 261-1A or 261-1B.
 - (2) Sawn or laminated wood structural members, crossarms, and braces
The permitted stress level of sawn or laminated wood structural members, crossarms, and braces meeting the requirements of ANSI O5.2-1996 [B15] or ANSI O5.3-2002 [B16] shall be determined by multiplying the appropriate designated fiber stress set forth in the respective standard, by the appropriate strength factors in Table 261-1A or 261-1B.

(3) The alternate method, including alternate load factors of Table 253-2 and strength factors of Table 261-1B, shall not be used after July 31, 2010.

c. Strength of guyed poles

Guyed poles shall be designed as columns, resisting the vertical component of the tension in the guy plus any other vertical loads.

d. Spliced and reinforced poles

Reinforcements or permanent splices at any section along the pole are permitted provided they develop the required strength of the pole.

e. All structures including those below 18 m (60 ft) shall be designed to withstand, without conductors, the extreme wind load in Rule 250C applied in any direction on the structure.

3. Fiber-reinforced polymer structures

a. These structures shall be designed to withstand the loads in Rule 252 multiplied by the appropriate load factors in Table 253-1 without exceeding the permitted load.

b. The permitted load shall be the 5th percentile strength (i.e., "5% lower exclusion limit") or less, multiplied by the strength factors in Table 261-1A (where guys are used, see Rule 261C).

c. Spliced and reinforced poles

Reinforcements or permanent splices to a supporting pole are permitted provided they develop the required strength of the pole.

d. All structures including those below 18 m (60 ft) shall be designed to withstand, without conductors, the extreme wind load in Rule 250C applied in any direction on the structure.

4. Transverse strength requirements for structures where side guying is required, but can be installed only at a distance

Grade B: If the transverse strength requirements of this section cannot be met except by the use of side guys or special structures, and where it is physically impractical to employ side guys, the transverse strength requirements may be met by side-guying the line at each side of, and as near as practical to, the crossing, or other transversely weak structure, and with a distance between such side-guyed structures of not over 250 m (800 ft), provided that:

a. The side-guyed structures for each such section of 250 m (800 ft) or less shall be designed to withstand the calculated transverse load due to wind on the supports and ice-covered conductors, on the entire section between side-guyed structures.

b. The line between such side-guyed structures shall be substantially in a straight line and the average span between the side-guyed structures shall not exceed 45 m (150 ft).

c. The entire section between the structures with the required transverse strength shall comply with the highest grade of construction concerned in the given section, except as to the transverse strength of the intermediate poles or towers.

Grade C: The above provisions do not apply to Grade C.

5. Longitudinal strength requirements for sections of higher grade in lines of a lower grade construction

a. Methods of providing longitudinal strength

Grade B: The longitudinal strength requirements for sections of line of higher grade in lines of a lower grade (for assumed longitudinal loading, see Rule 252) may be met by placing a structure of the required longitudinal strength at each end of the higher grade section.

Where this is impractical, the structures of the required longitudinal strength may be located away from the section of higher grade, within 150 m (500 ft) on each side and with not more than 250 m (800 ft) between the structures of the required longitudinal strength. This is permitted provided the following conditions are met:

- (1) The structures and the line between them meet the requirements for transverse strength and stringing of conductors of the highest grade occurring in the section, and
- (2) The line between the structures of the required longitudinal strength is approximately straight or suitably guyed.

The longitudinal strength requirement of the structures may be met by using guys.

Grade C: The above provisions do not apply to Grade C.

b. Flexible supports

Grade B: When supports of the section of higher grade are capable of considerable deflection in the direction of the line, it may be necessary to increase the clearances required in Section 23 or to provide line guys or special reinforcements to reduce the deflection.

Grade C: The above provision does not apply to Grade C.

B. Strength of foundations, settings, and guy anchors

Foundations, settings, and guy anchors shall be designed or be determined by experience to withstand the loads in Rule 252 multiplied by the load factors in Table 253-1 without exceeding the permitted load. The permitted load shall be equal to the strength multiplied by the strength factors in Table 261-1A.

NOTE: Excessive movement of foundations, settings, and guy anchors or errors in settings can reduce clearances or structure capacity.

C. Strength of guys and guy insulators

The strength requirements for guys and guy insulators are covered under Rules 264 and 279A1c, respectively.

1. Metal and prestressed-concrete structures

Guys shall be considered as an integral part of the structure.

2. Wood and reinforced-concrete structures

When guys are used to meet the strength requirements, they shall be considered as taking the entire load in the direction in which they act, the structure acting as a strut only, except for those structures considered to possess sufficient rigidity so that the guy can be considered an integral part of the structure.

NOTE: Excessive movement of guys can reduce clearances or structure capacity.

3. Fiber-reinforced polymer structures

When guys are used to meet the strength requirements, the guys shall be considered as taking the entire load in the direction in which they act, as if the structure is acting as a strut only, except for those structures considered to possess sufficient rigidity so that the guys can be considered an integral part of the structure.

NOTE: Excessive movement of guys can reduce clearances or structure capacity.

D. Crossarms and braces

1. Concrete and metal crossarms and braces

Crossarms and braces shall be designed to withstand the loads in Rule 252 multiplied by the load factors in Table 253-1 without exceeding the permitted load. The permitted load shall be equal to the strength multiplied by the strength factors in Table 261-1A.

2. Wood crossarms and braces

a. Strength

(1) Crossarms and braces shall be designed to withstand the loads in Rule 252 multiplied by the load factors in Table 253-1 without exceeding their permitted stress.

(2) The permitted stress level of solid sawn or laminated wood crossarms and braces shall be determined by multiplying their ultimate fiber stress by the strength factors in Table 261-1A or 261-1B.

b. Material and size

Wood crossarms and braces of select Southern pine or Douglas fir shall have a cross section of not less than those in Table 261-2. Crossarms of other species may be used provided they have equal strength.

3. Fiber-reinforced polymer crossarms and braces

Crossarms and braces shall be designed to withstand the loads in Rule 252 multiplied by the load factors in Table 253-1 without exceeding the permitted load. The permitted load shall be the 5th percentile strength (i.e., "5% lower exclusion limit") or less, multiplied by the strength factors in Table 261-1A.

4. Crossarms and braces of other materials

Crossarms and braces should meet the strength requirements of Rule 261D2.

5. Additional requirements

a. Longitudinal strength

(1) General

(a) Crossarms shall be designed to withstand a load of 3.1 kN (700 lb) applied at the outer conductor attachment point without exceeding the permitted stress level for wood crossarms or the permitted load for crossarms of other materials, as applicable.

(b) At each end of a transversely weak section, as described in Rule 261A4, the longitudinal load shall be applied in the direction of the weak section.

(2) Methods of meeting Rule 261D2a(1)

Grade B: Where conductor tensions are limited to a maximum of 9.0 kN (2000 lb) per conductor, double wood crossarms having cross sections in Table 261-2 and properly assembled will comply with the longitudinal strength requirements in Rule 261D2a(1).

Grade C: This requirement is not applicable.

(3) Location

At crossings, crossarms should be mounted on the face of a pole away from the crossing, unless special bracing or double crossarms are used.

b. Bracing

Crossarms shall be supported by bracing, if necessary, to support expected loads, including line personnel working on them. Crossarm braces used only to sustain unbalanced vertical loads need only to be designed for these unbalanced vertical loads.

c. Double crossarms, brackets, or equivalent support assembly

Grade B: Where pin-type construction is used, double wood crossarms, each crossarm having the strength required by Rule 261D2a, or a support assembly equivalent in strength to double wood crossarms shall be used at each crossing structure, at ends of joint use or conflict sections, at deadends, and at corners where the angle of departure from a straight line exceeds 20 degrees. Under similar conditions, where a bracket supports a conductor operated at more than 750 V to ground and there is no crossarm below, double brackets or a support assembly equivalent in strength to double wood crossarms shall be used.

EXCEPTION: The above does not apply where communication cables or conductors cross below supply conductors and either are attached to the same pole, or where supply conductors are continuous and of uniform tension in the crossing span and each adjacent span. This exception does not apply to railroad crossings and limited access highways except by mutual agreement.

Grade C: The above requirement is not applicable.

E. Insulators

The strength requirements for insulators are covered under Rules 277 and 279.

F. Strength of pin-type or similar construction and conductor fastenings

1. Longitudinal strength

a. General

Pin-type or similar construction and ties or other conductor fastenings shall be designed to withstand the applicable longitudinal loads in Rule 252, multiplied by the load factors for longitudinal loads in Table 253-1, or 3.1 kN (700 lb) applied at the pin, whichever is greater.

b. Method of meeting Rule 261F1a

Grade B: Where conductor tensions are limited to 9.0 kN (2000 lb) and such conductors are supported on pin insulators, double wood pins and ties or their equivalent will be considered to meet the requirements of Rule 261F1a.

Grade C: No requirement.

c. At deadends and at ends of higher grade construction in line of lower grade

Grade B: Pins and ties or other conductor fastenings connected to the structure at a deadend or at each end of the higher grade section shall be designed to withstand an unbalanced pull due to the conductor load in Rule 251 multiplied by the load factors in Rule 253-1.

Grade C: This requirement is not applicable except for deadends.

d. At ends of transverse sections described in Rule 261A4

Grade B: Pins and ties or other conductor fastenings connected to the structure at ends of the transverse section as described in Rule 261A4 shall be designed to withstand the unbalanced pull in the direction of that transverse section under the load in Rule 252 multiplied by the load factors in Rule 253-1.

Grade C: No requirement.

2. Double pins and conductor fastenings

Grade B: Double pins and conductor fastenings shall be used where double crossarms or brackets are required by Rule 261D4d.

EXCEPTION: The above does not apply where communication cables or conductors cross below supply conductors and either are attached to the same pole, or where supply conductors are continuous and of uniform tension in a crossing span and each adjacent span. This exception does not apply in the case of railroad crossings and limited access highway crossings except by mutual agreement.

Grade C: No requirement.

3. Single supports used in lieu of double wood pins

A single conductor support and its conductor fastening, when used in lieu of double wood pins, shall develop strength equivalent to double wood pins and their conductor fastenings as specified in Rule 261F1a.

G. Armless construction

1. General

Open conductor armless construction is a type of open conductor supply line construction in which conductors are individually supported at the structure without the use of crossarms.

2. Insulating material

Strength of insulating material shall meet the requirements of Section 27.

3. Other components

Strengths of other components shall meet the requirements of Rules 260 and 261.

H. Open supply conductors and overhead shield wires

1. Tensions

- a. The supply conductor and overhead shield wire tensions shall be not more than 60% of their rated breaking strength for the load of Rule 250B in Rule 251 multiplied by a load factor of 1.0.
- b. The tension at 15 °C (60 °F), without external load, shall not exceed the following percentages of their rated breaking strength:

Initial unloaded tension 35%

Final unloaded tension 25%

EXCEPTION: In the case of conductors with a generally triangular cross section, such as cables composed of three wires, the final unloaded tension at 15 °C (60 °F) shall not exceed 30% of the rated breaking strength of the conductor.

NOTE: The above limitations may not protect the conductor or facilities from damage due to aeolian vibration.

2. Splices, taps, dead-end fittings, and associated attachment hardware

- a. Splices should be avoided in crossings and adjacent spans. If it is impractical to avoid such splices, they shall have sufficient strength to withstand the maximum tension resulting from the loads of Rule 250B in Rule 251 multiplied by a load factor of 1.65. If Rules 250C and 250D are applicable, splices shall not be stressed beyond 80% of their rated breaking strength under the loads of Rules 250C and 250D in Rule 251 multiplied by a load factor of 1.0.
- b. Taps should be avoided in crossing spans but, if required, shall be of a type that will not impair the strength of the conductors to which they are attached.
- c. Dead-end fittings, including the associated attachment hardware, shall have sufficient strength to withstand the maximum tension resulting from the loads of Rule 250B in Rule 251 multiplied by a load factor of 1.65. If Rules 250C and 250D are applicable, deadend fittings shall not be stressed beyond 80% of their rated breaking strength under the loads of Rules 250C and 250D in Rule 251 multiplied by a load factor of 1.0.

3. Trolley-contact conductors

In order to provide for wear, no trolley-contact conductor shall be installed of less size than AWG No. 0, if of copper, or AWG No. 4, if of silicon bronze.

I. Supply cable messengers

Messengers shall be stranded and shall not be stressed beyond 60% of their rated breaking strength under the loads of Rule 250B in Rule 251 multiplied by a load factor of 1.0. If Rules 250C and 250D are applicable, messengers shall not be stressed beyond 80% of their rated breaking strength under the loads of Rules 250C and 250D in Rule 251 multiplied by a load factor of 1.0.

NOTE: There are no strength requirements for cables supported by messengers.

J. Open-wire communication conductors

Open-wire communication conductors in Grade B or C construction shall have the tensions in Rule 261H1 for supply conductors of the same grade.

EXCEPTION: Where supply conductors are trolley-contact conductors of 0 to 750 V to ground, WG No. 12 Stl may be used for communication conductors for spans of 0 to 30 m (0 to 100 ft), and Stl WG No. 9 may be used for spans of 38 to 45 m (125 to 150 ft).

K. Communication cables

1. Communication cables

There are no strength requirements for communication cables supported by messengers. See Rule 261K2 for the strength requirements for messengers supporting communication cables.

2. Messenger

The messenger shall not be stressed beyond 60% of its rated breaking strength under the loads of Rule 250B in Rule 251 multiplied by a load factor of 1.0. If Rules 250C and 250D are

applicable, messengers shall not be stressed beyond 80% of their rated breaking strength under the loads of Rules 250C and 250D in Rule 251 multiplied by a load factor of 1.0.

L. Paired communication conductors

1. Paired conductors supported on messenger

a. Use of messenger

A messenger may be used for supporting paired conductors in any location, but is required for paired conductors crossing over trolley-contact conductors of more than 7.5 kV to ground.

b. Tension of messenger

Messenger used for supporting paired conductors required to meet Grade B construction because of crossing over trolley-contact conductors shall meet the tension requirements for Grade B.

c. Size and sag of conductors

There are no requirements for paired conductors when supported on messenger.

2. Paired conductors not supported on messenger

a. Above supply lines

Grade B: Tensions shall not exceed those in Rule 261H1 for supply conductors of similar grade.

Grade C: Sizes and tensions

Spans 0 to 30 m (0 to 100 ft)—No requirements.

Each conductor shall have a rated breaking strength of not less than 0.75 kN (170 lb).

Spans 30 to 45 m (100 to 150 ft)—Tensions shall not exceed those required for Grade B communication conductors.

Spans exceeding 45 m (150 ft)—Tensions shall not exceed those required for Grade C supply conductors. (See Rule 261H1.)

b. Above trolley-contact conductors

Grade B: Sizes and tensions

Spans 0 to 30 m (0 to 100 ft)—No size requirements. Tensions shall not exceed those of Rule 261H1.

Spans exceeding 30 m (100 ft)—Each conductor shall have a rated breaking strength of not less than 0.75 kN (170 lb). Tensions shall be not less than those of Rule 261H1.

Grade C: Sizes and tensions

Spans 0 to 30 m (0 to 100 ft)—No requirements.

Spans exceeding 30 m (100 ft)—No tension requirements.

Each conductor shall have a rated breaking strength of not less than 0.75 kN (170 lb).

M. Support and attachment hardware

The strength required for all support and attachment hardware not covered by Rule 261F or 261H2 shall be not less than the load times the appropriate load factor given in Section 25 and the load factor shall not be less than 1.0. For appropriate strength factors, see Rule 260B.

N. Climbing and working steps and their attachments to the structure

The strength required for all climbing devices (includes steps, ladders, platforms and their attachments) shall be capable of supporting 2.0 times the maximum intended load without permanent deformation. Unless otherwise quantified by the owner, the maximum intended load shall be assumed to be 300 lb, which includes the weight of the lineman, harness, tools, and equipment being supported by the lineman.

NOTE: See IEEE Std 1307™-2004 [B52].

Table 261-1A—Strength factors for structures,^① crossarms, braces, support hardware, guys, foundations, and anchors for use with load factors of Table 253-1

[It is recognized that structures will experience some level of deterioration after installation, depending upon materials, maintenance, and service conditions. The table values specify strengths required at installation. Footnotes specify deterioration allowed, if any. When new or changed facilities add loads to existing structures (a) the strength of the structure when new shall have been great enough to support the additional loads and (b) the strength of the deteriorated structure shall exceed the strength required at replacement. If either (a) or (b) cannot be met, the structure must be replaced, augmented, or rehabilitated.]

	Grade B	Grade C
Strength factors for use with loads of Rule 250B		
Metal and prestressed-concrete structures, crossarms, and braces ^⑤	1.0	1.0
Wood and reinforced-concrete structures, crossarms, and braces ^{② ④}	0.65	0.85
Fiber-reinforced polymer structures ^⑥	1.0	1.0
Support hardware	1.0	1.0
Guy wire ^{③ ⑥}	0.9	0.9
Guy anchor and foundation ^⑥	1.0	1.0
Strength factors for use with loads of Rules 250C and 250D		
Metal and prestressed-concrete structures, crossarms, and braces ^⑥	1.0	1.0
Wood and reinforced-concrete structures, crossarms, and braces ^{③ ④}	0.75	0.75
Fiber-reinforced polymer structures ^⑥	1.0	1.0
Support hardware	1.0	1.0
Guy wire ^{③ ⑥}	0.9	0.9
Guy anchor and foundation ^⑥	1.0	1.0

①Includes poles.

②Wood and reinforced concrete structures shall be replaced or rehabilitated when deterioration reduces the structure strength to 2/3 of that required when installed. If a structure or component is replaced, it shall meet the strength required by Table 261-1A. Rehabilitated portions of structures shall have strength greater than 2/3 of that required when installed.

③Wood and reinforced concrete structures shall be replaced or rehabilitated when deterioration reduces the structure strength to 3/4 of that required when installed. If a structure or component is replaced, it shall meet the strength required by Table 261-1A. Rehabilitated portions of structures shall have strength greater than 3/4 of that required when installed.

④Where a wood or reinforced concrete structure is built for temporary service, the structure strength may be reduced to values as low as those permitted by footnotes (2) and (3) provided the structure strength does not decrease below the minimum required during the planned life of the structure.

⑤For guy insulator requirements, see Rule 279.

⑥Deterioration during service shall not reduce strength capability below the required strength.

Table 261-1B—Strength factors for structures,^{①②} crossarms, and braces for use with load factors of Table 253-2

The alternate method, including alternate load factors of Table 253-2 and strength factors of Table 261-1B, shall not be used after July 31, 2010.

[It is recognized that structures will experience some levels of deterioration after installation, depending upon materials, maintenance, and service conditions. The table values specify strengths required at installation. Footnotes specify deterioration allowed for wood and reinforced concrete structures. When new or changed facilities add loads to existing structures (a) the strength of the structure when new shall have been great enough to support the additional loads, and (b) the strength of the deteriorated structure shall exceed the strength required at replacement. If either (a) or (b) cannot be met, the structure must be replaced, augmented, or rehabilitated.]

	Grade B	Grade C
Strength factors for use with loads of Rules 250B, 250C, and 250D		
Wood and reinforced-concrete structures, crossarms, and braces	1.0	1.0

①Includes poles.

②Where a wood or reinforced-concrete structure is built for temporary service, the structure strength may be reduced to values as low as those permitted by the at replacement load factors in Table 253-2, footnotes (2) and (3) provided the structure strength does not decrease below the minimum required during the planned life of the structure.

Table 261-2—Dimensions of crossarm cross section of select Southern Pine and Douglas Fir

Crossarm Length		Grades of construction	
		Grade B	Grade C
1.20 m or less	mm:	75 × 100	70 × 95
4 ft or less	in:	3 × 4	2-3/4 × 3-3/4
2.45 m	mm:	82 × 108	75 × 100
8 ft	in:	3-1/4 × 4-1/4	3 × 4
3.0 m	mm:	82 × 108	75 × 100
10 ft	in:	3-1/4 × 4-1/4	3 × 4

262. Number 262 not used in this edition.

263. Grade N construction

The strength of Grade N construction need not be equal to or greater than Grade C.

A. Poles

Poles used for lines for which neither Grade B nor C is required shall be of initial size or guyed or braced to withstand expected loads, including line personnel working on them.

B. Guys

The general requirements for guys are covered in Rules 264 and 279A.

C. Crossarm strength

Crossarms shall be securely supported by bracing, if necessary, to withstand expected loads, including line personnel working on them.

NOTE: Double crossarms are generally used at crossings, unbalanced corners, and dead ends, in order to permit conductor fastenings at two insulators to limit the opportunity for slipping, although single crossarms might provide sufficient strength. To secure extra strength, double crossarms are frequently used, and crossarm guys are sometimes used.

D. Supply line conductors

1. Size

Supply-line conductors shall be not smaller than the sizes listed in Table 263-1.

RECOMMENDATION: It is recommended that these sizes for copper and steel not be used in spans longer than 45 m (150 ft) for the heavy-loading district, and 53 m (175 ft) for the medium- and light-loading districts.

E. Service drops

1. Size of open-wire service drops

a. Not over 750 V.

Service drops shall be as required by (1) or (2):

(1) Spans not exceeding 45 m (150 ft)

Sizes shall be not smaller than those in Table 263-2.

(2) Spans exceeding 45 m (150 ft)

Sizes shall be not smaller than 8 AWG.

b. Exceeding 750 V

Sizes of service drops of more than 750 V shall be not less than required for supply line conductors of the same voltage.

2. Tension of open-wire service drops

The tension of the service drop conductors shall not exceed the strength of the conductor attachment or its support under the expected loads.

3. Cabled service drops

Service conductors may be grouped together in a cable, provided the following requirements are met:

a. Size

The size of each conductor shall be not less than required for drops of separate conductors (Rule 263E1).

b. Tension of cabled service drops

The tension of the service drop conductors shall not exceed the strength of the conductor attachment or its support under the expected loads.

F. Trolley-contact conductors

In order to provide for wear, trolley-contact conductors shall be not smaller than size AWG No. 0, if of copper, or AWG No. 4, if of silicon bronze.

G. Communication conductors

There are no specific requirements for Grade N communication line conductors or service drops.

H. Street and area lighting equipment

The lowering rope or chain for luminaires arranged to be lowered for examination or maintenance shall be of a material and strength designed to withstand climatic conditions and to sustain the luminaire safely.

I. Insulators

The strength requirements for insulators are covered under Rules 277 and 279.

Table 263-1—Sizes for Grade N supply line conductors

	Required AWG ^① or Std WG ^②
Soft copper	6
Medium- or hard-drawn copper	8
Steel	9
Stranded aluminum:	
EC	2
ACSR	4
ALLOY	4
ACAR	2

①Copper or aluminum

②Steel

Table 263-2—Sizes of service drops of 750 V or less
 (Voltages of trolley-contact conductors are voltage to ground.
 AWG used for aluminum and copper wires; Stl WG used for steel wire.)

Situation	Copper wire		Steel wire	EC aluminum wire ^②
	Soft-drawn	Medium- or hard-drawn		
Alone	10	12	12	4
Concerned with communication conductor	10	12	12	4
Over supply conductors of				
0 to 750 V	10	12	12	4
750 V to 8.7 kV ^①	8	10	12	4
Exceeding 8.7 kV ^①	6	8	9	4
Over trolley-contact conductors				
0 to 750 V ac or dc	8	10	12	4
Exceeding 750 V ac or dc	6	8	9	4

①Installation of service drops of not more than 750 V above supply lines of more than 750 V should be avoided where practical.

②ACSR or high-strength aluminum alloy conductor size shall be not less than No. 6.

264. Guying and bracing

A. Where used

When the loads are greater than can be supported by the structure alone, additional strength shall be provided by the use of guys, braces, or other suitable construction. Such measures shall also be used where necessary to limit the increase of sags in adjacent spans and provide sufficient strength for those supports on which the loads are sufficiently unbalanced, for example, at corners, angles, dead ends, large differences in span lengths, and changes of grade of construction.

B. Strength

Guys shall be designed to withstand the loads in Rule 252 multiplied by the load factors in Table 253-1 without exceeding the permitted load. The permitted load shall be equal to the strength multiplied by the strength factors in Table 261-1A. For guy wires conforming to ASTM Standards, the minimum breaking strength value therein defined shall be the rated breaking strength required in this Code.

NOTE: For protection and marking of guys, see Rule 217C.

C. Point of attachment

The guy or brace should be attached to the structure as near as is practical to the center of the conductor load to be sustained. However, on lines exceeding 8.7 kV, the location of the guy or brace may be adjusted to minimize the reduction of the insulation offered by nonmetallic support arms and supporting structures.

D. Guy fastenings

Guys having a rated breaking strength of 9.0 kN (2000 lb) or more and that are subject to small radius bends should be stranded and should be protected by suitable guy thimbles or their equivalent. Any guy having a design loading of 44.5 kN (10 000 lb) or more wrapped around cedar or similar softwood poles should be protected by the use of suitable guy shims.

Where there is a tendency for the guy to slip off the shim, guy hooks or other suitable means of limiting the likelihood of this action should be used. Shims are not necessary in the case of supplementary guys, such as storm guys.

E. Electrolysis

Where anchors and rods are subject to electrolysis, suitable measures should be taken to minimize corrosion from this source.

F. Anchor rods

1. Anchor rods should be installed so as to be in line with the pull of the attached guy when under load.

EXCEPTION: This is not required for anchor rods installed in rock or concrete.

2. The anchor and rod assembly shall have an ultimate strength not less than that required of the guy(s) by Rule 264B.

Section 27. Line insulation

270. Application of rule

These requirements apply only to open-conductor supply lines.

NOTE 1: See Rule 243C5.

NOTE 2: See Rule 242E for insulation requirements for neutral conductors.

271. Material and marking

Insulators for operation of supply circuits shall be made of wet-process porcelain or other material that will provide equivalent or better electrical and mechanical performance. Insulators for use at or above 2.3 kV between conductors shall be marked by the maker with its name or trademark and an identification mark or markings that will permit determination of the electrical and mechanical properties. The marking shall be applied so as not to reduce the electrical or mechanical strength of the insulator.

NOTE: The identifying marking can be either a catalog number, trade number, or other means so that properties of the unit can be determined either through catalogs or other literature.

272. Ratio of flashover to puncture voltage

Insulators shall be designed so that the ratio of their rated low-frequency dry-flashover voltage to low-frequency puncture voltage is in conformance with applicable American National Standards. When a standard does not exist, this ratio shall not exceed 75%.

The applicable American National Standards are as follows:

ANSI C29.1-1988

ANSI C29.2-1992

ANSI C29.3-1986

ANSI C29.4-1989

ANSI C29.5-1984

ANSI C29.6-1996

ANSI C29.7-1996

EXCEPTION: Insulators specifically designed for use in areas of high atmospheric contamination may have a rated low-frequency dry-flashover voltage not more than 80% of their low-frequency puncture voltage.

273. Insulation level

The rated dry flashover voltage of the insulator or insulators, when tested in accordance with ANSI C29.1-1988, shall be not less than that shown in Table 273-1, unless based on a qualified engineering study. Higher insulation levels than those shown in Table 273-1, or other effective means, shall be used where severe lightning, high atmospheric contamination, or other unfavorable conditions exist. Insulation levels for system voltages in excess of those shown shall be based on a qualified engineering study.

Table 273-1—Insulation level requirements

Nominal voltage (between phases) (kV)	Rated dry flashover voltage of insulators ^⓪ (kV)	Nominal voltage (between phases) (kV)	Rated dry flashover voltage of insulators ^⓪ (kV)
0.75	5	115	315
2.4	20	138	390
6.9	39	161	445
13.2	55	230	640
23.0	75	345	830
34.5	100	500	965
46	125	765	1145
69	175		

⓪Interpolate for intermediate values.

274. Factory tests

Each insulator or insulating part thereof for use on circuits operating at or above 2.3 kV between conductors shall be tested by the manufacturer in accordance with applicable American National Standards, or, where such standards do not exist, other good engineering practices to ensure their performance.

The applicable American National Standards are listed in Rule 272.

275. Special insulator applications

A. Insulators for constant-current circuits

Insulators for use on constant-current circuits shall be selected on the basis of the rated full-load voltage of the supply transformer.

B. Insulators for single-phase circuits directly connected to three-phase circuits

Insulators used on single-phase circuits directly connected to three-phase circuits (without intervening isolating transformers) shall have an insulation level not less than that required for the three-phase circuit.

276. Number 276 not used in this edition.

277. Mechanical strength of insulators

Insulators shall withstand all applicable loads specified in Rules 250, 251, and 252 except those of Rules 250C and 250D without exceeding the percentages of their strength rating for the respective insulator type shown in Table 277-1. Proper allowance should be made for the loads in Rules 250C and 250D.

Table 277-1—Allowed percentages of strength ratings

Insulator type	Percent	Strength rating ^①	Reference standard
Ceramic			
Suspension	50%	Combined mechanical and electric strength	ANSI C29.2-1992
Line post	40% 50%	Cantilever strength Tension, compression strength	ANSI C29.7-1996
Station post	40%	Cantilever, tension, compression or torsion strength	ANSI C29.9-1983 [B8]
Station cap and pin	40%	Cantilever, tension, compression or torsion strength	ANSI C29.8-1985 [B7]
Nonceramic			
Suspension	50%	Specified mechanical load (SML)	ANSI C29.12-1997 [B11] and C29.13-2000 [B12]
Line post	50%	Specified cantilever load (SCL) or specified tension load (STL)	ANSI C29.17-2002 [B13] and C29.18-2003 [B14]
Station post	40%	All strength ratings	

^①All strengths shall be those supplied by the respective manufacturers.

278. Aerial cable systems

A. Electrical requirements

1. Covered or insulated conductors not meeting the requirements of Rule 230C1, 230C2, or 230C3 shall be considered as bare conductors for all insulation requirements.
2. The insulators or insulating supports shall meet the requirements of Rule 273.
3. The systems shall be so designed and installed as to minimize long-term deterioration from electrical stress.

B. Mechanical requirements

1. Insulators other than spacers used to support aerial cable systems shall meet the requirements of Rule 277.
2. Insulating spacers used in spacer cable systems shall withstand the loads specified in Section 25 (except those of Rules 250C and 250D) without exceeding 50% of their rated ultimate strength.

279. Guy and span insulators

A. Insulators

1. Properties of guy insulators

Where guy insulators are used in accordance with Rule 215C2, the guy insulators shall meet the following requirements:

a. Material

Insulators shall be made of wet-process porcelain, wood, fiberglass-reinforced plastic, or other material of suitable mechanical and electrical properties.

b. Electrical strength

The guy insulator shall have a rated dry flashover voltage at least double, and a rated wet flashover voltage at least as high as, the nominal line voltage between conductors of the guyed circuit. A guy insulator may consist of one or more units.

c. Mechanical strength

The rated ultimate strength of the guy insulator shall be at least equal to the required strength of the guy in which it is installed.

2. Galvanic corrosion and BIL insulation

a. Limitation of galvanic corrosion

An insulator in the guy strand used exclusively to limit galvanic corrosion of metal in ground rods, anchors, anchor rods, or pipe in an effectively grounded system shall not be classified as a guy insulator and shall not reduce the mechanical strength of the guy.

NOTE: See Rule 215C7.

b. BIL insulation

An insulator in the guy strand used exclusively to meet BIL requirements for the structure in an effectively grounded system, as shown in Figure 279-1, shall not be classified as a guy insulator, provided mechanical strength of the insulator meets Rule 279A1c and either of the following provisions is met:

- (1) The guy is otherwise insulated to meet the requirements of Rule 279A1
- (2) Anchor guys are grounded below the insulator in accordance with Rules 215C5 and 92C2

B. Properties of span-wire insulators

Where span-wire insulators are used in accordance with Rule 215C, the span-wire insulators shall meet the following requirements:

1. Material

Insulators shall be made of wet-process porcelain, wood, fiberglass, or other material of suitable mechanical and electrical properties.

2. Insulation level

The insulation level of span-wire insulators shall meet the requirements of Rule 274.

A hanger insulator, where used to provide single insulation as permitted by Rule 279B2, shall meet the requirements of Rule 274.

3. Mechanical strength

The rated ultimate strength of the span-wire insulator shall be at least equal to the required strength of the span wire in which it is located.

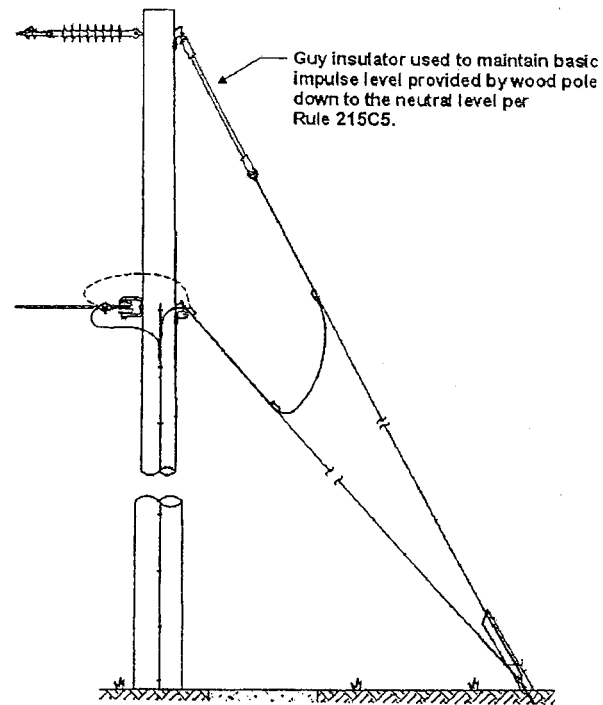

Figure 279-1—Insulator used for BIL insulation

28. Section number 28 not used in this edition.

29. Section number 29 not used in this edition.

Part 3.

Safety Rules for the Installation and Maintenance of Underground Electric Supply and Communication Lines

Section 30.

Purpose, scope, and application of rules

300. Purpose

The purpose of Part 3 of this Code is the practical safeguarding of persons during the installation, operation, or maintenance of underground or buried supply and communication cables and associated equipment.

301. Scope

Part 3 of this Code covers supply and communication cables and equipment in underground or buried systems. The rules cover the associated structural arrangements and the extension of such systems into buildings. It also covers the cables and equipment employed primarily for the utilization of electric power when such cables and equipment are used by the utility in the exercise of its function as a utility. They do not cover installations in electric supply stations.

302. Application of rules

The general requirements for application of these rules are contained in Rule 13.

Section 31. General requirements applying to underground lines

310. Referenced sections

The Introduction (Section 1), Definitions (Section 2), List of referenced documents (Section 3), and Grounding methods (Section 9) of this Code shall apply to the requirements of Part 3.

311. Installation and maintenance

- A. Persons responsible for underground facilities shall be able to indicate the location of their facilities.
- B. Reasonable advance notice should be given to owners or operators of other proximate facilities that may be adversely affected by new construction or changes in existing facilities.
- C. For emergency installations, supply and communication cables may be laid directly on grade if they are guarded or otherwise located so that they do not unduly obstruct pedestrian or vehicular traffic and are appropriately marked. Supply cables operating above 600 V shall meet either Rule 230C or 350B.

312. Accessibility

All parts that must be examined or adjusted during operation shall be arranged so as to be accessible to authorized persons by the provision of adequate working spaces, working facilities, and clearances.

313. Inspection and tests of lines and equipment

- A. When in service
 - 1. Initial compliance with safety rules
Lines and equipment shall comply with these safety rules upon being placed in service.
 - 2. Inspection
Accessible lines and equipment shall be inspected by the responsible party at such intervals as experience has shown to be necessary.
 - 3. Tests
When considered necessary, lines and equipment shall be subjected to practical tests to determine required maintenance.
 - 4. Record of defects
Any defects affecting compliance with this Code revealed by inspection, if not promptly corrected, shall be recorded; such record shall be maintained until the defects are corrected.
 - 5. Remedying defects
Lines and equipment with recorded defects that would endanger life or property shall be promptly repaired, disconnected, or isolated.
- B. When out of service
 - 1. Lines infrequently used
Lines and equipment infrequently used shall be inspected or tested as necessary before being placed into service.
 - 2. Lines temporarily out of service
Lines and equipment temporarily out of service shall be maintained in a safe condition.

3. Lines permanently abandoned

Lines and equipment permanently abandoned shall be removed or maintained in a safe condition.

314. Grounding of circuits and equipment

A. Methods

The methods to be used for grounding of circuits and equipment are given in Section 9.

B. Conductive parts to be grounded

Cable sheaths and shields (except conductor shields), equipment frames and cases (including pad-mounted devices), and conductive lighting poles shall be effectively grounded. Conductive-material ducts and riser guards that enclose electric supply lines or are exposed to contact with open supply conductors of greater than 300 V shall be effectively grounded.

EXCEPTION: This rule does not apply to parts that are 2.45 m (8 ft) or more above readily accessible surfaces or are otherwise isolated or guarded.

C. Circuits

1. Neutrals

Primary neutrals, secondary and service neutrals, and common neutrals shall be effectively grounded as specified in Rule 314A.

EXCEPTION: Circuits designed for ground-fault detection and impedance current-limiting devices.

2. Other conductors

Conductors, other than neutral conductors, that are intentionally grounded, shall be effectively grounded as specified in Rule 314A.

3. Surge arresters

Surge arresters shall be effectively grounded as specified in Rule 314A.

4. Use of earth as part of circuit

a. Supply circuits shall not be designed to use the earth normally as the sole conductor for any part of the circuit.

b. Monopolar operation of a bipolar HVDC system is permissible for emergencies and limited periods for maintenance.

315. Communications protective requirements

A. Where required

Where communications apparatus is handled by other than qualified persons, it shall be protected by one or more of the means listed in Rule 315B if such apparatus is permanently connected to lines subject to any of the following:

1. Lightning
2. Contact with supply conductors with voltages exceeding 300 V
3. Transient rise in ground potential exceeding 300 V
4. Steady-state induced voltage of a level that may cause personal injury

NOTE: When communication cables will be in the vicinity of supply stations where large ground currents may flow, the effect of these currents on communication circuits should be evaluated.

B. Means of protection

Where communications apparatus is required to be protected under Rule 315A, protective means adequate to withstand the voltage expected to be impressed shall be provided by insulation,

B. Separation from other underground installations

1. General

The separation between a conduit system and other underground structures paralleling it should be as large as necessary to permit maintenance of the system without damage to the paralleling structures. A conduit that crosses over another subsurface structure shall have a separation sufficient to limit the likelihood of damage to either structure. These separations should be determined by the parties involved.

EXCEPTION: When conduit crosses a manhole, vault, or subway tunnel roof, it may be supported directly on the roof with the concurrence of all parties involved.

2. Separations between supply and communication conduit systems

Conduit systems to be occupied by communication conductors shall be separated from conduit systems to be used for supply systems by not less than

- a. 75 mm (3 in) of concrete
- b. 100 mm (4 in) of masonry
- c. 300 mm (12 in) of well-tamped earth

EXCEPTION: Lesser separations may be used where the parties concur.

3. Sewers, sanitary and storm

- a. If conditions require a conduit to be installed parallel to and directly over a sanitary or storm sewer, it may be done provided both parties are in agreement as to the method.
- b. Where a conduit run crosses a sewer, it shall be designed to have suitable support on each side of the sewer to limit the likelihood of transferring any direct load onto the sewer.

4. Water lines

Conduit should be installed as far as is practical from a water main in order to protect it from being undermined if the main breaks. Conduit that crosses over a water main shall be designed to have suitable support on each side as required to limit the likelihood of transferring any direct loads onto the main.

5. Gas and other lines that transport flammable material

Conduit should have sufficient separation from gas and other lines that transport flammable material to permit the use of pipe maintenance equipment. Conduit shall not enter the same manhole, handhole, or vault with gas or other lines that transport flammable material.

6. Steam lines

Conduit should be installed so as to limit the likelihood of detrimental heat transfer between the steam and conduit systems.

321. Excavation and backfill

A. Trench

The bottom of the trench should be undisturbed, tamped, or relatively smooth earth. Where the excavation is in rock, the conduit should be laid on a protective layer of clean tamped backfill.

B. Quality of backfill

All backfill should be free of materials that may damage the conduit system.

RECOMMENDATION: Backfill within 150 mm (6 in) of the conduit should be free of solid material greater than 100 mm (4 in) in maximum dimension or with sharp edges likely to damage it. The balance of backfill should be free of solid material greater than 200 mm (8 in) in maximum dimension. Backfill material should be adequately compacted.

322. Ducts and joints

A. General

1. Duct material shall be corrosion-resistant and suitable for the intended environment.
2. Duct materials, the construction of the conduit, or both shall be designed so that a cable fault in one duct would not damage the conduit to such an extent that it would cause damage to cables in adjacent ducts.
3. The conduit system shall be designed to withstand external forces to which it may be subjected by the surface loadings set forth in Rule 323A, except that impact loading may be reduced one third for each 300 mm (12 in) of cover so no impact loading need be considered when cover is 900 mm (3 ft) or more.
4. The internal surface of the duct shall be free of sharp edges or burrs, which could damage supply cable.

B. Installation

1. Restraint

Conduit, including terminations and bends, should be suitably restrained by backfill, concrete envelope, anchors, or other means to maintain its design position under stress of installation procedures, cable pulling operations, and other conditions such as settling and hydraulic or frost uplift.

2. Joints

Ducts shall be joined in a manner so as to limit solid matter from entering the conduit line. Joints shall form a sufficiently continuous smooth interior surface between joining duct sections so that supply cable will not be damaged when pulled past the joint.

3. Externally coated pipe

When conditions are such that externally coated pipe is required, the coating shall be corrosion resistant and should be inspected, tested, or both, to see that the coating is continuous and intact prior to backfill. Precautions shall be taken to prevent damage to the coating when backfilling.

4. Building walls

Conduit installed through a building wall shall have internal and external seals intended to limit the likelihood of the entrance of gas into the building. The use of seals may be supplemented by gas-venting devices in order to minimize building up of positive gas pressures in the conduit.

5. Bridges

- a. Conduit installed in bridges shall include the capability to allow for expansion and contraction of the bridge.
- b. Conduits passing through a bridge abutment should be installed so as to avoid or resist any shear due to soil settlement.
- c. Conduit of conductive material installed on bridges shall be effectively grounded.

6. In vicinity of manholes

Conduit should be installed on compacted soil or otherwise supported when entering a manhole to limit the likelihood of detrimental shear stress on the conduit at the point of manhole entrance.

323. Manholes, handholes, and vaults

A. Strength

Manholes, handholes, and vaults shall be designed to sustain all expected loads that may be imposed upon the structure. The horizontal design loads, vertical design loads, or both shall consist of dead load, live load, equipment load, impact, load due to water table, frost, and any other load expected to

be imposed upon the structure, to occur adjacent to the structure, or both. The structure shall sustain the combination of vertical and lateral loading that produces the maximum shear and bending moments in the structure.

1. In roadway areas, the live load shall consist of the weight of a moving tractor-semitrailer truck illustrated in Figure 323-1. The vehicle wheel load shall be considered applied to an area as indicated in Figure 323-2. In the case of multilane pavements, the structure shall sustain the combination of loadings that results in vertical and lateral structure loadings that produce the maximum shear and bending moments in the structure.

NOTE: Loads imposed by equipment used in road construction may exceed loads to which the completed road may be subjected.

2. In designing structures not subject to vehicular loading, the design live load shall be not less than 14.5 kPa (300 lb/ft²).
3. Live loads shall be increased by 30% for impact.
4. When hydraulic, frost, or other uplift will be encountered, the structure shall either be of sufficient weight or so restrained as to withstand this force. The weight of equipment installed in the structure is not to be considered as part of the structure weight.
5. Where pulling iron facilities are furnished, they should be installed to withstand twice the expected load to be applied to the pulling iron.

B. Dimensions

Manholes shall meet the following requirements: A clear working space sufficient for performing the necessary work shall be maintained. The horizontal dimensions of the clear working space shall be not less than 900 mm (3 ft). The vertical dimensions shall be not less than 1.83 m (6 ft) except in manholes where the opening is within 300 mm (1 ft), horizontally, of the adjacent interior side wall of the manhole.

EXCEPTION 1: Where one boundary of the working space is an unoccupied wall and the opposite boundary consists of cables only, the horizontal working space between these boundaries may be reduced to 750 mm (30 in).

EXCEPTION 2: In manholes containing only communication cables, equipment, or both, one horizontal dimension of the working space may be reduced to not less than 600 mm (2 ft), provided the other horizontal dimension is increased so that the sum of the two dimensions is at least 1.83 m (6 ft).

C. Manhole access

1. Round access openings in a manhole containing supply cables shall be not less than 650 mm (26 in) in diameter. Round access openings in any manhole containing communication cables only, or manholes containing supply cables and having a fixed ladder that does not obstruct the opening, shall be not less than 600 mm (24 in) in diameter. Rectangular access openings should have dimensions not less than 650 mm × 560 mm (26 in × 22 in).
2. Openings shall be free of protrusions that will injure personnel or prevent quick egress.
3. Manhole openings shall be located so that safe access can be provided. When in the highway, they should be located outside of the paved roadway when practical. They should be located outside the area of street intersections and crosswalks whenever practical to reduce the traffic hazards to the workers at these locations.
4. Personnel access openings should be located so that they are not directly over the cable or equipment. When these openings interfere with curbs, etc., they can be located over the cable if one of the following is provided:
 - a. A conspicuous safety sign

NOTE: ANSI Z535.1-2006, ANSI Z535.2-2006, ANSI Z535.3-2006, ANSI Z535.4-2006, and ANSI Z535.5-2006 contain information regarding safety signs.
 - b. A protective barrier over the cable
 - c. A fixed ladder

5. Any manhole greater than 1.25 m (4 ft) in depth shall be designed so it can be entered by means of a ladder or other suitable climbing device. Equipment, cable, and hangers are not suitable climbing devices.

D. Covers

1. Manholes and handholes, when not being worked in, shall be securely closed by covers of sufficient weight or proper design so they cannot be easily removed without tools.
2. Covers should be suitably designed or restrained so that they cannot fall into manholes or protrude into manholes sufficiently far to contact cable or equipment.
3. Strength of covers and their supporting structure shall be at least sufficient to sustain the applicable loads of Rule 323A.

E. Vault and utility tunnel access

1. Access openings shall be located so that safe access can be provided.
2. Personnel access openings in vaults should be located so that they are not directly over or do not directly open into equipment or cable. In vaults, other types of openings (not personnel access) may be located over equipment to facilitate work on, replacement, or installation of equipment.
3. Where accessible to the public, access doors to utility tunnels and vaults shall be locked unless qualified persons are in attendance to restrict entry by unqualified persons. When vaults and utility tunnels contain exposed live parts, a prominent safety sign shall be visibly posted before entering the vault.

NOTE: ANSI Z535.1-2006, ANSI Z535.2-2006, ANSI Z535.3-2006, ANSI Z535.4-2006, and ANSI Z535.5-2006 contain information regarding safety signs.

4. Such doors shall be designed so that a person on the inside may exit when the door is locked from the outside.

EXCEPTION: This rule does not apply where the only means of locking is by padlock and the latching system is so arranged that the padlock can be closed on the latching system to prevent locking from the outside.

F. Ladder requirements

Fixed ladders shall be corrosion-resistant. Portable ladders shall be used in accordance with Rule 420J.

RECOMMENDATION: Ladders should conform to ANSI A14.1-1994 [B1], ANSI A14.2-1990 [B2], ANSI A14.3-1992 [B3], or ANSI A14.5-1992 [B4].

G. Drainage

Where drainage is into sewers, suitable traps or other means should be provided to limit the likelihood of sewer gas entering into manholes, vaults, or tunnels.

H. Ventilation

Adequate ventilation to open air shall be provided for manholes, vaults, and tunnels, having an opening into enclosed areas used by the public. Where such enclosures house transformers, switches, regulators, etc., the ventilating system shall be cleaned at necessary intervals.

EXCEPTION: This does not apply to enclosed areas under water or in other locations where it is impractical to comply.

I. Mechanical protection

Supply cables and equipment should be installed or guarded in such a manner as to avoid damage by objects falling or being pushed through the grating.

J. Identification

Manhole and handhole covers should have an identifying mark that will indicate ownership or type of utility.

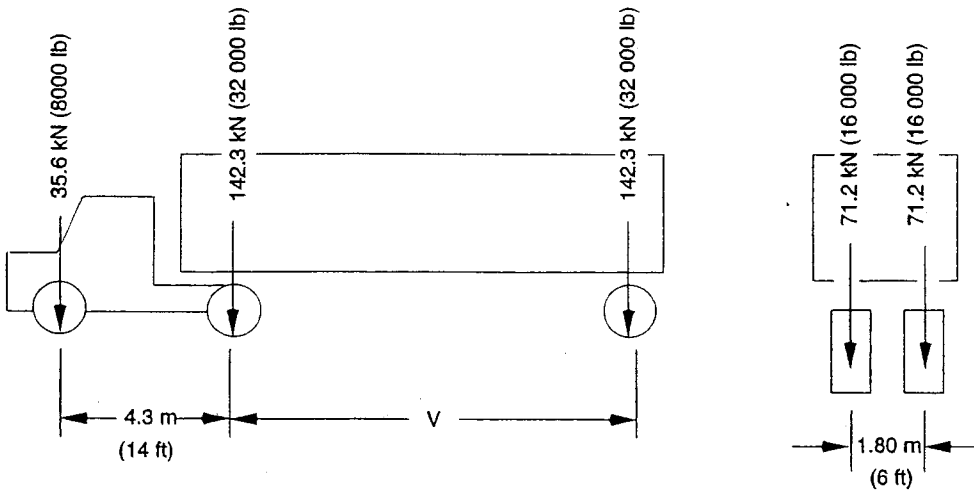

V = Variable spacing, 4.3 m to 9.0 m (14 ft to 30 ft), inclusive. Spacing to be used is that which results in vertical and lateral structure loading that produces the maximum shear and bending moments in the structure.

Figure 323-1—Roadway vehicle load

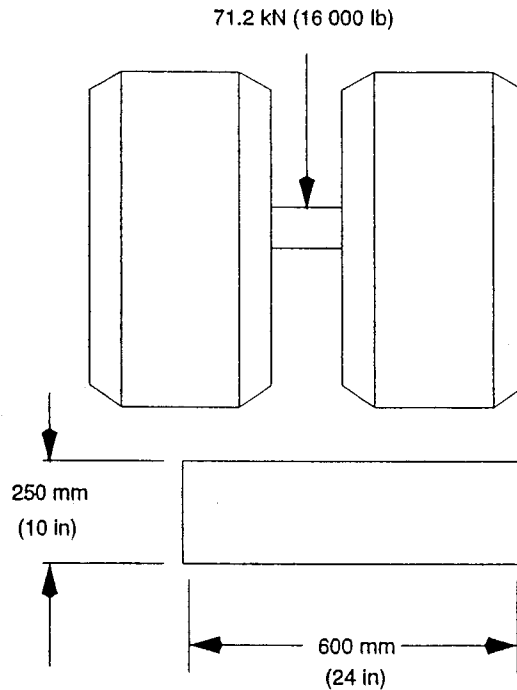

Figure 323-2—Wheel load area

Section 33. Supply cable

330. General

RECOMMENDATION: Cable should be capable of withstanding tests applied in accordance with an applicable standard issued by a recognized organization such as the American National Standards Institute (ANSI), the Association of Edison Illuminating Companies (AEIC), the Insulated Cable Engineers Association (ICEA), the National Electrical Manufacturers Association (NEMA), or the American Society for Testing and Materials (ASTM).

- A. The design and construction of conductors, insulation, sheath, jacket, and shielding shall include consideration of mechanical, thermal, environmental, and electrical stresses that are expected during installation and operation.
- B. Cable shall be designed and manufactured to retain specified dimensions and structural integrity during manufacture, reeling, storage, handling, and installation.
- C. Cable shall be designed and constructed in such a manner that each component is protected from harmful effects of other components.
- D. The conductor, insulation, and shielding shall be designed to withstand the effects of the expected magnitude and duration of fault current, except in the immediate vicinity of the fault.

331. Sheaths and jackets

Sheaths, jackets, or both shall be provided when necessary to protect the insulation or shielding from moisture or other adverse environmental conditions.

332. Shielding

- A. General
 - 1. Conductor shielding should, and insulation shielding shall, be provided as specified by an applicable document issued by a nationally recognized cable standardization organization.
NOTE: Typical cable standardization organizations include: the AEIC, the ICEA, and the NEMA.
EXCEPTION: Shielding is not required for short jumpers that do not contact a grounded surface within enclosures or vaults, provided the jumpers are guarded or isolated.
 - 2. Insulation shielding may be sectionalized provided that each section is effectively grounded.
- B. Material
 - 1. The shielding system may consist of semiconducting materials, nonmagnetic metal, or both. The shielding adjacent to the insulation shall be designed to remain in intimate contact with the insulation under all operating conditions.
 - 2. Shielding material shall either be designed to resist excessive corrosion under the expected operating conditions or shall be protected.

333. Cable accessories and joints

- A. Cable accessories and joints shall be designed to withstand the mechanical, thermal, environmental, and electrical stresses expected during operation.
- B. Cable accessories and joints shall be designed and constructed in such a manner that each component of the cable and joint is protected from harmful effects of the other components.

- C. Cable accessories and joints shall be designed and constructed to maintain the structural integrity of the cables to which they are applied and to withstand the magnitude and duration of the fault current expected during operation, except in the immediate vicinity of the fault.
- D. For insulating joints, see Rule 332A2.

Section 34. Cable in underground structures

340. General

- A. Section 33 shall apply to supply cable in underground structures.
- B. On systems operating above 2 kV to ground, the design of the conductors or cables installed in non-metallic conduit should consider the need for an effectively grounded shield, a sheath, or both.

341. Installation

- A. General
 - 1. Bending of the supply cable during handling, installation, and operation shall be controlled to avoid damage.
 - 2. Pulling tensions and sidewall pressures on the supply cable should be limited to avoid damage.
NOTE: Manufacturers' recommendations may be used as a guide.
 - 3. Ducts should be cleaned of foreign material that could damage the supply cable during pulling operations.
 - 4. Cable lubricants shall not be detrimental to cable or conduit systems.
 - 5. On slopes or vertical runs, consideration should be given to restraining cables to limit the likelihood of downhill movement.
 - 6. Supply cables shall not be installed in the same duct with communication cables unless all of the cables are operated and maintained by the same utility.
 - 7. Communication cables may be installed together in the same duct provided all utilities involved are in agreement.
- B. Cable in manholes and vaults
 - 1. Supports
 - a. Cable supports shall be designed to withstand both live and static loading and should be compatible with the environment.
 - b. Supports shall be provided to maintain specified clearance between cables.
 - c. Horizontal runs of supply cables shall be supported at least 75 mm (3 in) above the floor, or shall be suitably protected.
EXCEPTION: This rule does not apply to grounding or bonding conductors.
 - d. The installation should allow cable movement without destructive concentration of stresses. The cable should remain on supports during operation.
NOTE: Special protection may be necessary at the duct entrance.
 - 2. Clearance
 - a. Adequate working space shall be provided in accordance with Rule 323B.
 - b. Between supply and communications facilities (cable, equipment, or both):
 - (1) Where cable, equipment, or both are to be installed in a joint-use manhole or vault, it shall be done only with the concurrence of all parties concerned.
 - (2) Supply and communication cables should be racked from separate walls. Crossings should be avoided.
 - (3) Where supply and communication cables must be racked from the same wall, the supply cables should be racked below the communication cables.
 - (4) Supply and communications facilities shall be installed to permit access to either without moving the other.
 - (5) Clearances shall be not less than those specified in Table 341-1.

3. Identification

a. General

- (1) Cables shall be permanently identified by tags or otherwise at each manhole or other access opening of the conduit system.

EXCEPTION: This requirement does not apply where the position of a cable, in conjunction with diagrams or maps supplied to workers, gives sufficient identification.

- (2) All identification shall be of a corrosion-resistant material suitable for the environment.
- (3) All identification shall be of such quality and located so as to be readable with auxiliary lighting.

b. Joint-use manholes and vaults

Cables in a manhole or vault that are operated and maintained by different utilities shall be permanently identified by markings or tags denoting the utility name and type of cable use.

Table 341-1—Clearance between supply and communications facilities in joint-use manholes and vaults

Phase-to-phase supply voltage	Surface to surface	
	(mm)	(in)
0 to 15 000	150	6
15 001 to 50 000	230	9
50 001 to 120 000	300	12
120 001 and above	600	24

EXCEPTION 1: These clearances do not apply to grounding conductors.

EXCEPTION 2: These clearances may be reduced by mutual agreement between the parties concerned when suitable barriers or guards are installed.

342. Grounding and bonding

- A. Cable and joints with bare metallic shields, sheaths, or concentric neutrals that are exposed to personnel contact shall be effectively grounded.
- B. Cable sheaths or shields that are connected to ground at a manhole shall be bonded or connected to a common ground.
- C. Bonding and grounding leads shall be of a corrosion-resistant material suitable for the environment or suitably protected.

343. Fireproofing

Although fireproofing is not a requirement, it may be provided in accordance with each utility's normal service reliability practice to provide protection from external fire.

344. Communication cables containing special supply circuits

- A. Special circuits operating at voltages in excess of 90 V ac or 150 V dc and used for supplying power solely to communications equipment may be included in communication cables under the following conditions:
1. Such cables shall have a conductive sheath or shield that shall be effectively grounded and each such circuit shall be carried on conductors that are individually enclosed with an effectively grounded shield.
 2. All circuits in such cables shall be owned or operated by one party and shall be maintained only by qualified personnel.
 3. Supply circuits included in such cables shall be terminated at points accessible only to qualified employees.
 4. Communication circuits brought out of such cables, if they do not terminate in a repeater station or terminal office, shall be protected or arranged so that in event of a failure within the cable, the voltage on the communication circuit will not exceed 400 V to ground.
 5. Terminal apparatus for the power supply shall be so arranged that live parts are inaccessible when such supply circuits are energized.
 6. Such cables shall be identified, and the identification shall meet the pertinent requirements of Rule 341B3.

EXCEPTION: The requirements of Rule 344A do not apply to communication circuits where the transmitted power does not exceed 150 W.

Section 35. Direct-buried cable

350. General

- A. Section 33 shall apply to direct-buried supply cable.
- B. Cables operating above 600 V to ground shall have a continuous metallic shield, sheath, or concentric neutral that is effectively grounded.
EXCEPTION: At a splice or joint, the current path of the metallic shield, sheath, or neutral shall be made continuous but need not be concentric.
- C. Cables meeting Rule 350B of the same supply circuit may be buried with no deliberate separation.
- D. Cables of the same circuit operating below 600 V to ground and without an effectively grounded shield or sheath shall be placed in close proximity (no intentional separation) to each other.
- E. Communication cables containing special circuits supplying power solely to communications equipment shall comply with the requirements of Rules 344A1 through 344A5.
- F. All direct-buried jacketed supply cable meeting Rule 350B and all direct-buried communication cables shall be legibly marked as follows:

The appropriate identification symbol shown in Figure 350-1 shall be indented or embossed in the outermost cable jacket at a spacing of not more than 1 m (40 in). The symbol may be separate or sequentially combined with other data, or symbols, or both, printed on the jacket. If the symbol is sequentially combined, it shall be separated as indicated in Figure 350-1.

This rule became effective for cable installed on or after 1 January 1996.

EXCEPTION 1: Cables with jackets that cannot be effectively marked in accordance with Rule 350F need not be marked.

EXCEPTION 2: Unmarked cable from stock existing prior to 1 January 1996 may be used to repair unmarked direct-buried jacketed supply cables and communication cables.

- G. The rules in this section shall apply to direct-buried supply and communication cables installed in duct that is not part of a conduit system.

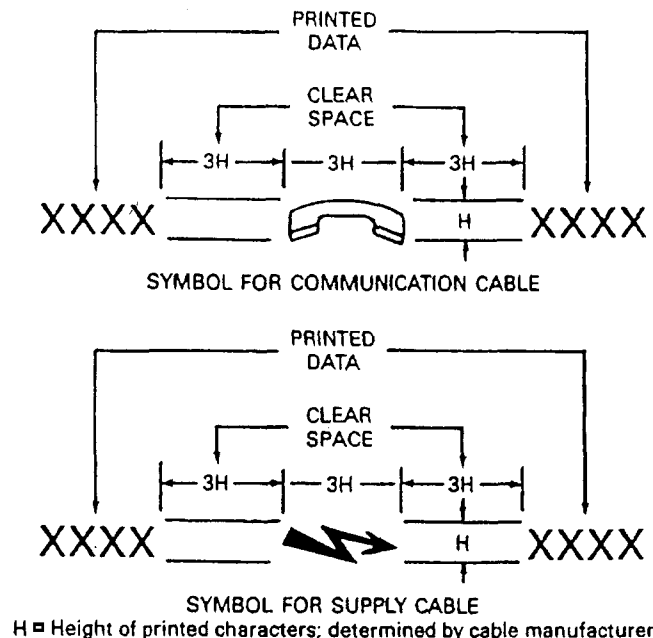

Figure 350-1—Symbols for identification of buried cables

351. Location and routing

A. General

1. Cables should be located so as to be subject to the least disturbance practical. When cables are to be installed parallel to and directly over or under other subsurface structures, the rules on separation in Rule 353 or 354, as applicable, shall be followed.
2. Cables should be installed in as straight and direct a line as practical. Where bends are required, the bending radius shall be sufficiently large to limit the likelihood of damage to the cable being installed.
3. Cable systems should be routed so as to allow safe access for construction, inspection, and maintenance.
4. The location of structures in the path of the projected cable route shall, as far as practical, be determined prior to trenching, plowing, or boring operation.

B. Natural hazards

Routes through unstable soil such as mud, shifting soils, corrosive soils, or other natural hazards should be avoided. If burying is required through areas with natural hazards, the cables shall be constructed and installed in such a manner as to protect them from damage. Such protective measures should be compatible with other installations in the area.

C. Other conditions

1. Swimming pools (in-ground)

Supply cable should not be installed within 1.5 m (5 ft) horizontally of a swimming pool or its auxiliary equipment. If 1.5 m (5 ft) is not attainable, supplemental mechanical protection shall be provided.

NOTE: For aboveground pools, see Rule 351C2.

2. Buildings and other structures

Cable should not be installed directly under the foundations of buildings or other structures. Where a cable must be installed under such a structure, the foundation shall be suitably supported to limit the likelihood of transfer of a detrimental load onto the cable.

3. Railroad tracks

- a. The installation of cable longitudinally under the ballast section for railroad tracks should be avoided. Where cable must be installed longitudinally under the ballast section of a railroad, it should be located at a depth of not less than 1.27 m (50 in) below the top of the rail.

EXCEPTION: Where this is impractical, or for other reasons, this clearance may be reduced by agreement between the parties concerned.

NOTE: Where unusual conditions exist or where proposed construction would interfere with existing installations, a greater depth than specified above would be required.

- b. Where a cable crosses under railroad tracks, the same clearances indicated in Rule 320A5 shall apply.

4. Highways and streets

The installation of cable longitudinally under traveled surfaces of highways and streets should be avoided. When cable must be installed longitudinally under the roadway, it should be installed in the shoulder or, if this is not practical, within the limits of one lane of traffic to the extent practical.

5. Submarine crossings

Submarine crossings should be routed, installed, or both, so they will be protected from erosion by tidal action or currents. They should not be located where ships normally anchor.

352. Installation

A. Trenching

The bottom of the trench receiving direct-buried cable should be relatively smooth, undisturbed earth; well-tamped earth; or sand. When excavation is in rock or rocky soils, the cable should be laid on a protective layer of well-tamped backfill. Backfill within 100 mm (4 in) of the cable should be free of materials that may damage the cable. Backfill should be adequately compacted. Machine compaction should not be used within 150 mm (6 in) of the cable.

B. Plowing

1. Plowing in of cable in soil containing rock or other solid material should be done in such a manner that the solid material will not damage the cable, either during the plowing operation or afterward.
2. The design of cable-plowing equipment and the plowing-in operation should be such that the cable will not be damaged by bending, side-wall pressure, or excessive cable tension.

C. Boring

Where a cable system is to be installed by boring and the soil and surface loading conditions are such that solid material in the region may damage the cable, the cable shall be adequately protected.

D. Depth of burial

1. The distance between the top of a cable and the surface under which it is installed (depth of burial) shall be sufficient to protect the cable from damage imposed by expected surface usage.
2. Burial depths as indicated in Table 352-1 are considered adequate for supply cables or conductors, except as noted in a, b, or c following:
 - a. In areas where frost conditions could damage cables, greater burial depths than indicated above may be desirable.
 - b. Lesser depths than indicated above may be used where supplemental protection is provided. The supplemental protection should be sufficient to protect the cable from damage imposed by expected surface usage.
 - c. Where the surface under which a cable is to be installed is not to final grade, the cable should be placed so as to meet or exceed the requirements indicated above, both at the time of installation and subsequent thereto.

E. Supply cables shall not be installed in the same duct with communication cables unless all of the cables are operated and maintained by the same utility.

F. Communication cables may be installed together in the same duct provided all utilities involved are in agreement.

Table 352-1—Supply cable or conductor burial depth

(See Rule 352D.)

Voltage (phase-to-phase)	Depth of burial	
	(mm)	(in)
0 to 600	600	
601 to 50 000	750	
50 001 and above	1070	

EXCEPTION: Where conflicts with other underground facilities exist, street and area lighting cables operating at not more than 150 V to ground may be buried at a depth not less than 450 mm (18 in).

353. Deliberate separations—Equal to or greater than 300 mm (12 in) from underground structures or other cables

A. General

1. These rules apply to a radial separation of supply and communication cables or conductors from each other and from other underground structures such as sewers, water lines, gas and other lines that transport flammable material, building foundations, steam lines, etc., when separation is equal to or greater than 300 mm (12 in).

NOTE: For radial separation less than 300 mm (12 in) see Rule 354.

2. The radial separation should be adequate to permit access to and maintenance of either facility to limit damage to the other.

B. Crossings

1. Where a cable crosses under another underground structure, the structure shall be suitably supported to limit the likelihood of transferring of a detrimental load onto the cable system.
2. Where a cable crosses over another underground structure, the cable shall be suitably supported to limit the likelihood of transferring a detrimental load onto the structure.
3. Adequate support may be provided by installing the facilities with sufficient vertical separation.

C. Parallel facilities

Where a cable system is to be installed directly over and parallel to another underground structure (or another underground structure installed directly over and parallel to a cable), it may be done providing all parties are in agreement as to the method. Adequate vertical separation shall be maintained to permit access to and maintenance of either facility without damage to the other cables.

D. Thermal protection

Cable should be installed with sufficient separation from other underground structures, such as steam or cryogenic lines, to avoid thermal damage to the cable. Where it is not practical to provide adequate clearance, a suitable thermal barrier shall be placed between the two facilities.

354. Random separation—Separation less than 300 mm (12 in) from underground structures or other cables

A. General

1. These rules apply to a radial separation of supply and communication cables or conductors from each other and from other underground structures when the radial separation between them will be less than 300 mm (12 in).
2. Radial separation of supply and communications cables or conductors from steam lines, gas, and other lines that transport flammable material shall be not less than 300 mm (12 in) and shall meet Rule 353.
3. Supply circuits operating above 300 V to ground or 600 V between conductors shall be so constructed, operated, and maintained that when faulted, they shall be promptly de-energized initially or following subsequent protective device operation (phase-to-ground faults for grounded circuits, phase-to-phase faults for ungrounded circuits).
4. Communication cables and conductors, and supply cables and conductors buried in random separation may be treated as one system when considering separation from other underground structures or facilities.

B. Supply cables or conductors

The cables or conductors of a supply circuit and those of another supply circuit may be buried together at the same depth with no deliberate separation between facilities, provided all parties involved are in agreement.

C. Communication cables or conductors

The cables or conductors of a communication circuit and those of another communication circuit may be buried together and at the same depth with no deliberate separation between facilities, provided all parties involved are in agreement.

D. Supply and communication cables or conductors

Supply cables or conductors and communication cables or conductors may be buried together at the same depth, with no deliberate separation between facilities, provided all parties involved are in agreement and the applicable rules in 354D1 are met and either Rule 354D2 or 354D3 is met.

EXCEPTION: Entirely dielectric fiber-optic communication cables may be buried together at the same depth with no deliberate separation from supply cables or conductors provided all parties involved are in agreement and Rules 354D1a, b, c, and d are met.

1. General

- a. Grounded supply systems shall not be operated in excess of 22 000 V to ground.
- b. Ungrounded supply systems shall not be operated in excess of 5300 V phase to phase.
- c. Cables of an ungrounded supply system operating above 300 V shall be of effectively grounded concentric shield construction. Such cables shall be maintained in close proximity to each other.
- d. Ungrounded supply circuits operating above 300 V between conductors and in random separation with communication conductors shall be equipped with a ground-fault indication system.
- e. Communication cables and communication service wire having metallic conductors or metallic components shall have a continuous metallic shield under the outer jacket.
EXCEPTION: This requirement does not apply to Rule 354C.
- f. Communications-protective devices shall be adequate for the voltage and currents expected to be impressed on them in the event of contact with the supply conductors.
- g. Adequate bonding shall be provided between the effectively grounded supply conductor or conductors and the communication cable shield or sheath at intervals that should not exceed 300 m (1000 ft).
- h. In the vicinity of supply stations where large ground currents may flow, the effect of these currents on communication circuits should be evaluated before communication cables are placed in random separation with supply cables.

2. Grounded bare or semiconducting jacketed neutral supply cables

- a. A supply facility operating above 300 V to ground shall include a bare or semiconducting jacketed grounded conductor in continuous contact with the earth. This conductor, adequate for the expected magnitude and duration of the fault current that may be imposed, shall be one of the following:
 - (1) A sheath, an insulation shield, or both
 - (2) Multiple concentric conductors closely spaced circumferentially
 - (3) A separate conductor in contact with the earth and in close proximity to the cable, where such cable or cables also have a grounded sheath or shield not necessarily in contact with the earth. The sheath, shield, or both, as well as the separate conductor, shall be adequate for the expected magnitude and duration of the fault currents that may be imposed.

NOTE: This is applicable when a cable in nonmetallic duct is considered as a direct-buried cable installation and random separation is desired.

EXCEPTION: Where buried cable passes through a short section of conduit such as under a roadway, the contact with earth of the grounded conductor can be omitted, provided the grounded conductor is continuous through the conduit.

- b. The bare conductor or conductors in contact with the earth shall be of suitable corrosion-resistant material. The conductor covered by a semiconducting jacket shall be compatible with the jacketing compound.

NOTE: Experience has shown that in many geographic areas, bare concentric copper neutral conductors experience severe corrosion.

- c. The radial resistivity of the semiconducting jacket shall be not more than $100 \Omega \cdot \text{m}$ and shall remain essentially stable in service. The radial resistivity of the jacket material is that value calculated from measurements on a unit length of cable, of the resistance between the concentric neutral and a surrounding conducting medium. Radial resistivity is equal to the resistance of a unit length times the surface area of the jacket divided by the average thickness of the jacket over the neutral conductors. All dimensions are to be expressed in meters.

3. Insulating jacketed grounded neutral supply cables

Each phase conductor of a multi-grounded supply system operating above 300 V to ground and having an overall insulating jacket shall have an effectively grounded copper concentric conductor meeting all of the following requirements:

- a. A conductance not less than one half that of the phase conductor
- b. Adequate for the expected magnitude and duration of fault current that may be imposed
- c. Grounded in accordance with Rule 314 except that the grounding interval required by Rule 96C shall be not less than eight in each 1.6 km (1 mile) of the random buried section, not including grounds at individual services

4. Insulating jacketed grounded neutral supply cables in nonmetallic duct

Insulating jacketed grounded neutral supply cables meeting the rules of 354D3, when installed in nonmetallic duct, may be random-laid with communication cables.

- E. Supply and communication cables or conductors and non-metallic water and sewer lines

1. Supply cables and conductors and non-metallic water and sewer lines may be buried together with no deliberate separation between facilities and at the same depth, provided all parties involved are in agreement.
2. Communication cables and conductors and non-metallic water and sewer lines may be buried together with no deliberate separation between facilities and at the same depth, provided all parties involved are in agreement.
3. Supply cables or conductors, communication cables or conductors, non-metallic water and sewer lines may be buried together with no deliberate separation between facilities and at the same depth, provided the applicable rules in Rule 354D are met and all parties involved are in agreement.

Section 36. Risers

360. General

- A. Mechanical protection for supply conductors or cables shall be provided as required by Rule 239D of this Code. This protection should extend at least 300 mm (1 ft) below ground level.
- B. Supply conductors or cable should rise vertically from the cable trench with only such deviation as necessary to permit a reasonable cable-bending radius.
- C. Exposed conductive pipes or guards containing supply conductors or cables shall be grounded in accordance with Rule 314.

361. Installation

- A. The installation should be designed so that water does not stand in riser pipes above the frost line.
- B. Conductors or cables shall be supported in a manner designed to limit the likelihood of damage to conductors, cables, or terminals.
- C. Where conductors or cables enter the riser pipe or elbow, they shall be installed in such a manner that shall minimize the possibility of damage due to relative movement of the cable and pipe.

362. Pole risers—Additional requirements

- A. Risers should be located on the pole in the safest available position with respect to climbing space and exposure to traffic damage.
- B. The number, size, and location of riser ducts or guards shall be limited to allow adequate access for climbing.

363. Pad-mounted installations

- A. Supply conductors or cables rising from the trench to transformers, switchgear, or other equipment mounted on pads shall be so placed and arranged that they will not bear on the edges of holes through the pad nor the edges of bends or other duct work below the pad.
- B. Cable entering pad-mounted equipment shall be maintained substantially at adequate depth for the voltage class until it becomes protected by being directly under the pad, unless other suitable mechanical protection is provided.

Section 37. Supply cable terminations

370. General

- A. Cable terminations shall be designed and constructed to meet the requirements of Rule 333.
- B. Riser terminations not located within a vault, pad-mounted equipment, or similar enclosure shall be installed in a manner designed to ensure that the clearance specified in Parts 1 and 2 of this Code are maintained.
- C. A cable termination shall be designed to limit the likelihood of moisture penetration into the cable where such penetration is detrimental to the cable.
- D. Where clearances between parts at different potentials are reduced below those adequate for the voltage and BIL (basic impulse insulation level), suitable insulating barriers or fully insulated terminals shall be provided to meet the required equivalent clearances.

371. Support at terminations

- A. Cable terminations shall be installed in a manner designed to maintain their installed position.
- B. Where necessary, cable shall be supported or secured in a manner designed to limit the likelihood of the transfer of damaging mechanical stresses to the termination, equipment, or structure.

372. Identification

Suitable circuit identification shall be provided for all terminations.

EXCEPTION: This requirement does not apply where the position of the termination, in conjunction with diagrams or maps supplied to workers, gives sufficient identification.

373. Clearances in enclosures or vaults

- A. Adequate electrical clearances of supply terminations shall be maintained, both between conductors and between conductors and ground, consistent with the type of terminator used.
- B. Where exposed live parts are in an enclosure, clearances or insulating barriers adequate for the voltages and the design BIL shall be provided.
- C. Where a termination is in a vault, uninsulated live parts are permissible provided they are guarded or isolated.

374. Grounding

- A. All exposed conducting surfaces of the termination device, other than live parts and equipment to which it is attached, shall be effectively grounded, bonded, or both.
- B. Conductive structures supporting cable terminations shall be effectively grounded.

EXCEPTION: Grounding, bonding, or both is not required where the above parts are isolated or guarded.

Section 38. Equipment

380. General

- A. Equipment includes:
1. Buses, transformers, switches, etc., installed for the operation of the electric supply system
 2. Repeaters, loading coils, etc., installed for the operation of the communications system
 3. Auxiliary equipment, such as sump pumps, convenience outlets, etc., installed incidental to the presence of the supply or communications systems
- B. Where equipment is to be installed in a joint-use manhole, it shall be done with the concurrence of all parties concerned.
- C. Supporting structures, including racks, hangers, or pads and their foundations, shall be designed to sustain all loads and stresses expected to be imposed by the supported equipment including those stresses caused by its operation.
- D. Pad-mounted equipment, pedestals, and other aboveground enclosures, should be located not less than 1.2 m (4 ft) from fire hydrants.
- EXCEPTION:* Where conditions do not permit a clearance of 1.2 m (4 ft), a clearance of not less than 900 mm (3 ft) is allowed.

381. Design

- A. The expected thermal, chemical, mechanical, and environmental conditions at the location shall be considered in the design of all equipment and mountings.
- B. All equipment, including auxiliary devices, shall be designed to withstand the effects of normal, emergency, and fault conditions expected during operation.
- C. Switches shall be provided with clear indication of contact position, and the handles or activating devices clearly marked to indicate operating directions.
- RECOMMENDATION:* The handles or control mechanism of all switches throughout the system should operate in a like direction to open and in a uniformly different direction to close in order to minimize errors.
- D. Remotely controlled or automatic devices shall have local provisions to render remote or automatic controls inoperable if such operation may result in a hazard to the worker.
- E. Enclosures containing fuses and interrupter contacts shall be designed to withstand the effects of normal, emergency, and fault conditions expected during operation.
- F. When tools are to be used to connect or disconnect energized devices, space or barriers shall be designed to provide adequate clearance from ground or between phases.
- G. Pad-mounted and other aboveground equipment
1. Pad-mounted and other aboveground equipment shall have an enclosure that is either locked or otherwise secured against unauthorized entry.
 2. Access to exposed live parts in excess of 600 V shall require two separate conscious acts. The first shall be the opening of a door or barrier that is locked or otherwise secured against unauthorized entry as required by Rule 381G1. The second act shall be either the opening of a door or the removal of a barrier.
- RECOMMENDATION:* A prominent and appropriate safety sign should be visible when the first door or barrier is opened or removed.
- NOTE:* ANSI Z535.1-2006, ANSI Z535.2-2006, ANSI Z535.3-2006, ANSI Z535.4-2006, and ANSI Z535.5-2006 contain information regarding safety signs.

382. Location in underground structures

- A. Equipment shall not obstruct personnel access openings in manholes or vaults, nor shall it impede egress by persons working in the structures containing the equipment.
- B. Equipment shall not be installed closer than 200 mm (8 in) to the back of fixed ladders and shall not interfere with the proper use of such ladders.
- C. Equipment should be arranged in a manhole or vault to permit installation, operation, and maintenance of all items in such structures.
- D. Switching devices that have provision for manual or electrical operation shall be operable from a safe position. This may be accomplished by use of portable auxiliary devices, temporarily attached.
- E. Equipment should not interfere with drainage of the structure.
- F. Equipment shall not interfere with the ability to ventilate any structure or enclosure.

383. Installation

- A. Provisions for lifting, rolling to final position, and mounting shall be adequate for the weight of the device.
- B. Live parts shall be guarded or isolated to limit the likelihood of contact by persons in a normal position adjacent to the equipment.
- C. Operating levers, inspection facilities, and test facilities shall be visible and readily accessible when equipment is in final location without moving permanent connections.
- D. Live parts shall be isolated or protected from exposure to conducting liquids or other material expected to be present in the structure containing the equipment.
- E. Operating controls of supply equipment, readily accessible to unauthorized personnel, shall be secured by bolts, locks, or seals.

384. Grounding and bonding

- A. Cases and enclosures made of conductive material shall be effectively grounded or guarded.
- B. Guards constructed of conductive material shall be effectively grounded.
- C. Bonding should be provided between all aboveground metallic power and communications apparatus (pedestals, terminals, apparatus cases, transformer cases, etc.) that are separated by a distance of 1.8 m (6 ft) or less. For the purpose of this rule, pole grounds are not considered an aboveground metallic power apparatus and therefore not required to be bonded to the communication apparatus.

385. Identification

Where transformers, regulators, or other similar equipment operate in multiple, tags, diagrams, or other suitable means shall be used to indicate that fact.

Section 39. Installation in tunnels

390. General

- A. The installation of supply and communications facilities in tunnels shall meet the applicable requirements contained elsewhere in Part 3 of this Code as supplemented or modified by this section.
- B. Where the space occupied by supply or communications facilities in a tunnel is accessible to other than qualified persons, or where supply conductors do not meet the requirements of Part 3 of this Code for cable systems, the installation shall be in accordance with the applicable requirements of Part 2 of this Code.
- C. All parties concerned must be in agreement with the design of the structure and designs proposed for installations within it.

391. Environment

- A. When the tunnel is accessible to the public or when workers must enter the structure to install, operate, or maintain the facilities in it, the design shall provide a controlled safe environment including, where necessary, barriers, detectors, alarms, ventilation, pumps, and adequate safety devices for all facilities. Controlled safe environment shall include the following:
 - 1. Design to avoid poisonous or suffocation atmosphere
 - 2. Design to protect persons from pressurized lines, fire, explosion, and high temperatures
 - 3. Design to avoid unsafe conditions due to induced voltages
 - 4. Design to limit the likelihood of hazards due to flooding
 - 5. Design to ensure egress; two directions for egress shall be provided for all points in tunnels
 - 6. Working space, in accordance with Rule 323B, the boundary of which shall be not less than 600 mm (2 ft) from a vehicular operating space or from exposed moving parts of machinery
 - 7. Safeguards designed to protect workers from hazards due to the operation of vehicles or other machinery in tunnels
 - 8. Unobstructed walkways for workers in tunnels
- B. A condition of occupancy in multiple-use tunnels by supply and communications facilities shall be that the design and installation of all facilities is coordinated to provide a safe environment for the operation of supply facilities, communications facilities, or both. Safe environment for facilities shall include the following:
 - 1. Means to protect equipment from harmful effects of humidity or temperature
 - 2. Means to protect equipment from harmful effects of liquids or gases
 - 3. Coordinated design and operation of corrosion-control systems

Part 4. Rules for the Operation of Electric Supply and Communications Lines and Equipment

Section 40. Purpose and scope

400. Purpose

The purpose of Part 4 of this Code is to provide practical work rules as one of the means of safeguarding employees and the public from injury. It is not the intent of these rules to require unreasonable steps to comply; however, all reasonable steps shall be taken.

401. Scope

Part 4 of this Code covers work rules to be followed in the installation, operation, and maintenance of electric supply and communications systems.

402. Referenced sections

The Introduction (Section 1), Definitions (Section 2), References (Section 3), and Grounding methods (Section 9) of this Code shall apply to the requirements of Part 4.

The standards listed in Section 3 shall be used with Part 4 where applicable.

NOTE: After ANSI C2-1973 [B6] was originally approved, 30 June 1972, the US Occupational Safety and Health Administration (OSHA) issued 29 CFR 1926, Subpart V [B62], applying to employee safety in construction. The differences between this document and the editions of the NESC through the 1993 Edition were noted in footnotes to the text of Part 4.

In 1989, OSHA published in the Federal Register [01/31/89], vol. 54, no. 19, pp. 4974–5024 inclusive, Docket S-015 [B65], a Notice of Proposed Rulemaking to issue new regulations as 29 CFR 1910.137 and 29 CFR 1910.269 to address the work practices to be used during the operation and maintenance of generation, transmission, and distribution facilities. Coordination between these OSHA proposals and the 1997 Edition of the NESC has been effected such that the technical content of each document is harmonized at this time to the extent possible with the closure of the rulemaking hearing docket. In some cases, it was thus not possible for the OSHA final rule published as 29 CFR 1910.137 and 29 CFR 1910.269 (as published in the Federal Register, [01/31/94] vol. 59, no. 20, pp. 4321–4477 [B66]) to address all the technical information considered in this revision of NESC Part 4.

Section 41.

Supply and communications systems—Rules for employers

410. General requirements

A. General

1. The employer shall inform each employee working on or about communications equipment or electric supply equipment and the associated lines, of the safety rules governing the employee's conduct while so engaged.

When deemed necessary, the employer shall provide a copy of such rules.

2. The employer shall provide training to all employees who work in the vicinity of exposed energized facilities. The training shall include applicable work rules required by this Part and other mandatory referenced standards or rules. The employer shall ensure that each employee has demonstrated proficiency in required tasks. The employer shall provide retraining for any employee who, as a result of routine observance of work practices, is not following work rules.
3. Effective as of January 1, 2009, the employer shall ensure that an assessment is performed to determine potential exposure to an electric arc for employees who work on or near energized parts or equipment. If the assessment determines a potential employee exposure greater than 2 cal/cm² exists (see Neal, Bingham, and Doughty [B59]), the employer shall require employees to wear clothing or a clothing system that has an effective arc rating not less than the anticipated level of arc energy.

When exposed to an electric arc or flame, clothing made from the following materials shall not be worn: acetate, nylon, polyester, or polypropylene.

The effective arc rating of clothing or a clothing system to be worn at voltages 1000 V and above shall be determined using Tables 410-1 and 410-2 or performing an arc hazard analysis.

When an arc hazard analysis is performed, it shall include a calculation of the estimated arc energy based on the available fault current, the duration of the arc (cycles), and the distance from the arc to the employee.

EXCEPTION 1: If the clothing required by this rule has the potential to create additional and greater hazards than the possible exposure to the heat energy of the electric arc, then clothing with an arc rating or arc thermal performance value (ATPV) less than that required by the rule can be worn.

EXCEPTION 2: For secondary systems below 1000 V, applicable work rules required by this part and engineering controls shall be utilized to limit exposure. In lieu of performing an arc hazard analysis, clothing or a clothing system with a minimum effective arc rating of 4 cal/cm² shall be required to limit the likelihood of ignition.

NOTE 1: A clothing system (multiple layers) that includes an outer layer of flame resistant material and an inner layer of non-flame resistant material has been shown to block more heat than a single layer. The effect of the combination of these multiple layers can be referred to as the *effective arc rating*.

NOTE 2: It is recognized that arc energy levels can be excessive with secondary systems. Applicable work rules required by this part and engineering controls should be utilized.

4. Employers shall utilize positive procedures to secure compliance with these rules. Cases may arise, however, where the strict enforcement of some particular rule could seriously impede the safe progress of the work at hand; in such cases the employee in charge of the work to be done should make such temporary modification of the rules as will accomplish the work without increasing the hazard.
5. If a difference of opinion arises with respect to the application of these rules, the decision of the employer or the employer's authorized agent shall be final. This decision shall not result in any employee performing work in a manner that is unduly hazardous to the employee or to the employee's fellow workers.

B. Emergency procedures and first aid rules

1. Employees shall be informed of procedures to be followed in case of emergencies and rules for first aid, including approved methods of resuscitation. Copies of such procedures and rules should be kept in conspicuous locations in vehicles and places where the number of employees and the nature of the work warrants.
2. Employees working on communications or electric supply equipment or lines shall be regularly instructed in methods of first aid and emergency procedures, if their duties warrant such training.

C. Responsibility

1. A designated person shall be in charge of the operation of the equipment and lines and shall be responsible for their safe operation.
2. If more than one person is engaged in work on or about the same equipment or line, one person shall be designated as in charge of the work to be performed. Where there are separate work locations, one person may be designated at each location.

Table 410-1—Clothing and clothing systems—voltage, fault current, and maximum clearing time for voltages 1 to 46 kV^①

(See Rule 410A3.)

Phase-to-phase voltage (kV)	Fault current (kA)	4-cal system	8-cal system	12-cal system
		Maximum clearing time (cycles)	Maximum clearing time (cycles)	Maximum clearing time (cycles)
1 to 15	5	46.5	93.0	139.5
	10	18.0	36.1	54.1
	15	10.0	20.1	30.1
	20	6.5	13.0	19.5
15.1 to 25	5	27.6	55.2	82.8
	10	11.4	22.7	34.1
	15	6.6	13.2	19.8
	20	4.4	8.8	13.2
25.1 to 36	5	20.9	41.7	62.6
	10	8.8	17.6	26.5
	15	5.2	10.4	15.7
	20	3.5	7.1	10.6

Table 410-1—Clothing and clothing systems—voltage, fault current, and maximum clearing time for voltages 1 to 46 kV^① (continued)
(See Rule 410A3.)

Phase-to-phase voltage (kV)	Fault current (kA)	4-cal system	8-cal system	12-cal system
		Maximum clearing time (cycles)	Maximum clearing time (cycles)	Maximum clearing time (cycles)
36.1 to 46	5	16.2	32.4	48.6
	10	7.0	13.9	20.9
	15	4.3	8.5	12.8
	20	3.0	6.1	0.1

①These calculations are based on open air phase-to-ground arc. This table is not intended for phase-to-phase arcs or enclosed arcs (arc in a box).

These calculations are based on a 15-in separation distance from the arc to the employee and arc gaps as follows: 1 to 15 kV = 2 in, 15.1 to 25 kV = 4 in, 25.1 to 36 kV = 6 in, 36.1 to 46 kV = 9 in. See IEEE Std 4-1995.

These calculations were derived using a commercially available computer software program. Other methods are available to estimate arc exposure values and may yield slightly different but equally acceptable results.

The use of the table in the selection of clothing is intended to reduce the amount or degree of injury but may not prevent all burns.

Table 410-2—Live-line tool work clothing and clothing systems—voltage, fault current, and maximum clearing time for voltages 46.1 to 800 kV^①
(See Rule 410A3.)

Phase-to-phase voltage (kV)	Fault current (kA)	4-cal system	8-cal system	12-cal system
		Maximum clearing time (cycles)	Maximum clearing time (cycles)	Maximum clearing time (cycles)
46.1 to 72.5	20	8.5	17.0	25.5
	30	5.3	10.5	15.8
	40	3.7	7.3	11.0
	50	2.8	5.5	8.3
72.6 to 121	20	8.2	16.5	24.7
	30	4.7	9.4	14.1
	40	3.1	6.2	9.3
	50	2.2	4.4	6.6
138 to 145	20	9.8	19.5	29.3
	30	5.6	11.2	16.8
	40	3.7	7.4	11.1
	50	2.6	5.3	7.9

Table 410-2—Live-line tool work clothing and clothing systems—voltage, fault current, and maximum clearing time for voltages 46.1 to 800 kV^① (continued)

(See Rule 410A3.)

Phase-to-phase voltage (kV)	Fault current (kA)	4-cal system	8-cal system	12-cal system
		Maximum clearing time (cycles)	Maximum clearing time (cycles)	Maximum clearing time (cycles)
161 to 169	20	9.3	18.6	27.9
	30	5.7	11.5	17.2
	40	4.0	8.0	12.0
	50	3.0	6.0	9.0
230 to 242	20	10.4	20.9	31.3
	30	6.4	12.9	19.3
	40	4.5	9.0	13.5
	50	3.4	6.8	10.1
345 to 362	20	22.6	45.3	67.9
	30	14.0	28.1	42.1
	40	9.8	19.6	29.4
	50	7.4	14.7	22.1
500 to 550	20	18.9	37.8	56.7
	30	11.7	23.3	35.0
	40	8.1	16.3	24.4
	50	6.1	12.2	18.3
765 to 800	20	43.6	87.3	130.9
	30	27.0	53.9	80.9
	40	18.9	37.8	56.7
	50	14.2	28.4	42.6

①Arc gap—calculated by using the phase-to-ground voltage of the circuit and dividing by 10. The dielectric strength of air is taken at 10 kV per inch. See IEEE Std 4-1995.

Distance from arc—calculated by using the minimum approach distance from Table 441-2 and subtracting two times the assumed arc gap length.

These calculations were derived using a commercially available computer software program. Other methods are available to estimate arc exposure values and may yield slightly different, but equally acceptable results.

The use of the table in the selection of clothing is intended to reduce the amount or degree of injury but may not prevent all burns.

Section 42. General rules for employees

420. Personal general precautions

A. Rules and emergency methods

1. Employees shall carefully read and study the safety rules, and may be called upon at any time to show their knowledge of the rules.
2. Employees shall familiarize themselves with approved methods of first aid, rescue techniques, and fire extinguishment.

B. Qualifications of employees

1. Employees whose duties require working on or in the vicinity of energized equipment or lines shall perform only those tasks for which they are trained, equipped, authorized, and so directed. Inexperienced employees shall: (a) work under the direction of an experienced and qualified person at the site, and (b) perform only directed tasks.
2. Employees operating mechanized equipment shall be qualified to perform those tasks.
3. If an employee is in doubt as to the safe performance of any assigned work, the employee shall request instructions from the employee's supervisor or person in charge.
4. Employees who do not normally work on or in the vicinity of electric supply lines and equipment but whose work brings them into these areas for certain tasks shall proceed with this work only when authorized by a qualified person.

C. Safeguarding oneself and others

1. Employees shall heed safety signs and signals and warn others who are in danger or in the vicinity of energized equipment or lines.
2. Employees shall report promptly to the proper authority any of the following:
 - a. Line or equipment defects such as abnormally sagging wires, broken insulators, broken poles, or lamp supports
 - b. Accidentally energized objects such as conduits, light fixtures, or guys
 - c. Other defects that may cause a dangerous condition
3. Employees whose duties do not require them to approach or handle electric equipment and lines shall keep away from such equipment or lines and should avoid working in areas where objects and materials may be dropped by persons working overhead.
4. Employees who work on or in the vicinity of energized lines shall consider all of the effects of their actions, taking into account their own safety as well as the safety of other employees on the job site, or on some other part of the affected electric system, the property of others, and the public in general.
5. No employee shall approach or bring any conductive object, without a suitable insulating handle, closer to any exposed energized part than allowed by Rule 431 (communication) or Rule 441 (supply), as applicable.
6. Employees should exercise care when extending metal ropes, tapes, or wires parallel to and in the proximity of energized high-voltage lines because of induced voltages. When it is necessary to measure clearances from energized objects, only devices approved for the purpose shall be used.

D. Energized or unknown conditions

Employees shall consider electric supply equipment and lines to be energized, unless they are positively known to be de-energized. Before starting work, employees shall perform preliminary inspections or tests to determine existing conditions. Operating voltages of equipment and lines should be known before working on or in the vicinity of energized parts.

E. Ungrounded metal parts

Employees shall consider all ungrounded metal parts of equipment or devices such as transformer cases and circuit breaker housings, to be energized at the highest voltage to which they are exposed, unless these parts are known by test to be free from such voltage.

F. Arcing conditions

Employees should keep all parts of their bodies as far away as practical from switches, brushes, commutators, circuit breakers, or other parts at which arcing may occur during operation or handling.

G. Liquid-cell batteries

1. Employees shall ascertain that battery areas are adequately ventilated before performing work.
2. Employees should avoid smoking, using open flames, or using tools that may produce sparks in the vicinity of liquid-cell batteries.
3. Employees shall use eye and skin protection when handling an electrolyte.
4. Employees shall not handle energized parts of batteries unless necessary precautions are taken to avoid short circuits and electrical shocks.

H. Tools and protective equipment

Employees shall use the personal protective equipment, the protective devices, and the special tools provided for their work. Before starting work, these devices and tools shall be carefully inspected to make sure that they are in good condition.

I. Clothing

1. Employees shall wear clothing suitable for the assigned task and the work environment.
2. When employees will be exposed to an electric arc, clothing or a clothing system shall be worn in accordance with Rule 410A3.
3. When working in the vicinity of energized lines or equipment, employees should avoid wearing exposed metal articles.

J. Ladders and supports

1. Employees shall not support themselves, or any material or equipment, on any portion of a tree, pole structure, scaffold, ladder, walkway, or other elevated structure or aerial device, etc., without it first being determined, to the extent practical, that such support is adequately strong, in good condition, and properly secured in place.
2. Portable wood ladders intended for general use shall not be painted except with a clear nonconductive coating, nor shall they be longitudinally reinforced with metal.
3. Portable metal ladders intended for general use shall not be used when working on or in the vicinity of energized parts.
4. If portable ladders are made partially or entirely conductive for specialized work, necessary precautions shall be taken to ensure that their use will be restricted to the work for which they are intended.

K. Fall protection

1. At elevated locations above 3 m (10 ft), climbers shall be attached to equipment or structures by a fall protection system while at the worksite, at a rest site, in aerial devices, helicopters, cable carts, and a boatswain's chair.
2. Qualified climbers may be permitted to be unattached to equipment or structures while climbing, transferring, or transitioning across obstacles on structures. Unqualified climbers shall be attached while performing these activities.
3. Fall protection equipment shall be inspected before use by the employee to ensure that the equipment is in safe working condition.
4. Fall arrest equipment shall be attached to a suitable anchorage.

5. The employee shall determine that all components of the fall protection system are properly engaged and that the employee is secure in the line-worker's body belt, harness, or any other fall protection system.

NOTE: Climbers need to be aware of accidental disengagement of fall protection components. Accidental disengagement is the sudden, unexpected release of a positioning strap snaphook from the D-ring of the line-worker's body belt without the user directly manipulating the latch of the snaphook. In general, there are two primary reasons for this occurrence.

- (a) Foreign objects may open the latch of the snaphook during normal use. It is possible for the snaphook to come in contact with such things as hand lines, guy wires, or other apparatus. These items may place pressure on the latch, causing the snaphook to separate from the D-ring without the user's knowledge. This could cause an accident. The worker must take care to keep the snaphooks away from any potential causes of release. Locking snaphooks reduce the possibility of this occurrence.
 - (b) Roll-out is the sudden separation of the snaphook/D-ring combination when the snaphook is twisted in the D-ring, but the user does not deliberately open the latch. This occurs when a twist is introduced into a positioning strap with a snaphook/D-ring combination that is incompatible. However, compatible hardware, when properly maintained, will not separate in this fashion.
6. Snaphooks shall be dimensionally compatible with the member to which they are connected so as to prevent unintentional disengagement of the connection.

NOTE:

- (a) The possibility exists for some snaphooks to roll out of D-rings. Attachment of a mismatched or multiple snaphooks, either of the nonlocking or locking type, to a single D-ring needs to be avoided. Multiple locking snaphooks may be attached to a single D-ring if they have been evaluated in the combination to be used. Locking snaphooks reduce the potential for roll-out.
 - (b) Disengagement through contact of the snaphook keeper with the connected member may be prevented by the use of a locking snaphook.
 - (c) Hardware compatibility can be verified. Simply attach the snaphook to the D-ring, then roll the snaphook placing the latch towards the body of the D-ring. This is similar to the action that occurs when the strap is twisted. If the rivet falls beyond the edge of the inside of the D-ring, placing pressure on the latch, the hardware is not compatible, and a roll-out potential exists.
 - (d) Other factors may increase the potential for accidental disengagement even if the hardware is compatible (e.g., foreign objects carried on the D-rings, condition of the snaphook, the shape of the D-ring).
7. Snaphooks shall not be connected to each other.
8. One hundred percent leather positioning straps shall not be used.
9. Wire rope lanyards shall be used in operations where the lanyard is subject to being cut. Wire rope lanyards shall not be used in the vicinity of energized lines or equipment.

L. Fire extinguishers

In fighting fires or in the vicinity of exposed energized parts of electric supply systems, employees shall use fire extinguishers or materials that are suitable for the purpose. If this is not possible, all adjacent and affected equipment should first be de-energized.

M. Machines or moving parts

Employees working on normally moving parts of remotely controlled equipment shall be protected against accidental starting by proper tags installed on the starting devices, or by locking or blocking where practical. Employees shall, before starting any work, satisfy themselves that these protective devices have been installed. When working or in the vicinity of automatically or remotely operated equipment such as circuit breakers that may operate suddenly, employees shall avoid being in a position where they might be injured from such operation.

N. Fuses

When fuses must be installed or removed with one or both terminals energized, employees shall use special tools or gloves insulated for the voltage involved. When installing expulsion-type fuses, employees shall wear personal eye protection and take precautions to stand clear of the exhaust path of the fuse barrel.

O. Cable reels

Cable reels shall be securely blocked so they cannot roll or rotate accidentally.

P. Street and area lighting

1. The lowering rope or chain, its supports, and fastenings shall be examined periodically.
2. A suitable device shall be provided by which each lamp on series-lighting circuits of more than 300 V may be safely disconnected from the circuit before the lamp is handled.

EXCEPTION: This rule does not apply where the lamps are always worked on from suitable insulated platforms or aerial lift devices, or handled with suitable insulated tools, and treated as under full voltage of the circuit concerned.

Q. Communication antennas

When working in the vicinity of communication antennas operating in the range of 3 kHz to 300 GHz, workers shall not be exposed to radiation levels that exceed those set forth by the regulatory authority having jurisdiction.

NOTE: See OSHA 29 CFR 1910.97, Subpart G [B63]; OSHA 29 CFR 1910.268, Subpart R [B64]; FCC Bulletin No. 65 [B30]; IEEE Std C95.1™-2005 [B57].

421. General operating routines

A. Duties of a first-level supervisor or person in charge

This individual shall:

1. Adopt such precautions as are within the individual's authority to prevent accidents.
2. See that the safety rules and operating procedures are observed by the employees under the direction of this individual.
3. Make all the necessary records and reports, as required.
4. Prevent unauthorized persons from approaching places where work is being done, as far as practical.
5. Prohibit the use of tools or devices unsuited to the work at hand or that have not been tested or inspected as required.

B. Area protection

1. Areas accessible to vehicular and pedestrian traffic
 - a. Before engaging in work that may endanger the public, safety signs or traffic control devices, or both, shall be placed conspicuously to alert approaching traffic. Where further protection is needed, suitable barrier guards shall be erected. Where the nature of work and traffic requires it, a person shall be stationed to warn traffic while the hazard exists.
 - b. When openings or obstructions in the street, sidewalk, walkways, or on private property are being worked on or left unattended during the day, danger signals, such as warning signs and flags, shall be effectively displayed. Under these same conditions at night, warning lights shall be prominently displayed and excavations shall be enclosed with protective barricades.
2. Areas accessible to employees only
 - a. If the work exposes energized or moving parts that are normally protected, safety signs shall be displayed. Suitable barricades shall be erected to restrict other personnel from entering the area.
 - b. When working in one section where there is a multiplicity of such sections, such as one panel of a switchboard, one compartment of several, or one portion of a substation, employees shall mark the work area conspicuously and place barriers to prevent accidental contact with energized parts in that section or adjacent sections.

3. Locations with crossed or fallen wires

An employee, finding crossed or fallen wires that are creating, or may create, a hazard, shall remain on guard or adopt other adequate means to prevent accidents. The proper authority shall be notified. If the employee is qualified, and can observe the rules for safely handling energized parts by the use of insulating equipment, this employee may correct the condition.

C. Escort

Persons accompanying nonqualified employees or visitors or in the vicinity of electric equipment or lines shall be qualified to safeguard the people in their care, and see that the safety rules are observed.

422. Overhead line operating procedures

Employees working on or with overhead lines shall observe the following rules in addition to applicable rules contained elsewhere in Sections 43 and 44.

A. Setting, moving, or removing poles in or near energized electric supply lines

1. When setting, moving, or removing poles in or in the vicinity of energized lines, precautions shall be taken to avoid direct contact of the pole with the energized conductors. Employees shall wear suitable insulating gloves or use other suitable means where voltages may exceed rating of gloves in handling poles where conductors energized at potentials above 750 V can be contacted. Employees performing such work shall not contact the pole with uninsulated parts of their bodies.
2. Contact with trucks, or other equipment that is not bonded to an effective ground being used to set, move, or remove poles in or in the vicinity of energized lines shall be avoided by employees standing on the ground or in contact with grounded objects unless employees are wearing suitable protective equipment.

B. Checking structures before climbing

1. Before climbing poles, ladders, scaffolds, or other elevated structures, employees shall determine, to the extent practical, that the structures are capable of sustaining the additional or unbalanced stresses to which they will be subjected.
2. Where there are indications that poles and structures may be unsafe for climbing, they shall not be climbed until made safe by guying, bracing, or other means.

C. Installing and removing wires or cables

1. Precautions shall be taken to prevent wires or cables that are being installed or removed from contacting energized wires or equipment. Wires or cables that are not bonded to an effective ground and which are being installed or removed in the vicinity of energized conductors shall be considered as being energized.
2. Sag of wire or cables being installed or removed shall be controlled to prevent danger to pedestrian and vehicular traffic.
3. Before installing or removing wires or cables, the strains to which poles and structures will be subjected shall be considered and necessary action taken to prevent failure of supporting structures.
4. Employees should avoid contact with moving winch lines, especially in the vicinity of sheaves, blocks, and take-up drums.
5. Employees working on or in the vicinity of equipment or lines exposed to voltages higher than those guarded against by the safety appliances provided shall take steps to be assured that the equipment or lines on which the employees are working are free from dangerous leakage or induction or have been effectively grounded.

423. Underground line operating procedures

Employees working on or with underground lines shall observe the following rules in addition to applicable rules contained elsewhere in Sections 43 and 44.

A. Guarding manhole and street openings

When covers of manholes, handholes, or vaults are removed, the opening shall be promptly protected with a barrier, temporary cover, or other suitable guard.

B. Testing for gas in manholes and unventilated vaults

1. The atmosphere shall be tested for combustible or flammable gas(es) before entry.
2. Where combustible or flammable gas(es) are detected, the work area shall be ventilated and made safe before entry.
3. Unless forced continuous ventilation is provided, a test shall also be made for oxygen deficiency.
4. Provision shall be made for an adequate continuous supply of air.

NOTE: The term *adequate* includes evaluation of both the quantity and quality of the air.

C. Flames

1. Employees shall not smoke in manholes.
2. Where open flames must be used in manholes or vaults, extra precautions shall be taken to ensure adequate ventilation.
3. Before using open flames in an excavation in areas where combustible gases or liquids may be present, such as in the vicinity of gasoline service stations, the atmosphere of the excavation shall be tested and found safe or cleared of the combustible gases or liquids.
4. When a torch or open flame is used (as in heat shrink splicing) in proximity to a visibly exposed gas or other line(s) that transport flammable material, adequate air space or a barrier shall be provided to protect the gas or line(s) that transport flammable material from the heat source.

D. Excavation

1. Cables and other buried utilities in the immediate vicinity shall be located, to the extent practical, prior to excavating.
2. When using guided boring or directional drilling methods, existing utilities should be exposed by the personnel performing the boring operation where the bore path crosses such facilities. See IEEE Std 1333TM-1994 [B53].
3. Hand tools used for excavating in the vicinity of energized supply cables shall be equipped with handles made of nonconductive material. See IEEE Std 1333-1994 [B53].
4. Mechanized equipment should not be used to excavate in close proximity to cables and other buried utilities.
5. If a gas or line that transports flammable material is broken or damaged, employees shall:
 - a. Leave the excavation open
 - b. Extinguish flames that could ignite the escaping gas or fuel
 - c. Notify the proper authority
 - d. Keep the public away until the condition is under control
6. When a worker is required to perform tasks in trenches or excavations where a cave-in hazard exists or the trench or excavation is in excess of 1.5 m (5 ft) in depth, shoring, sloping, or shielding methods shall be used to provide employee protection.

E. Identification

1. When underground facilities are exposed, they should be identified and shall be protected as necessary to avoid damage.

2. Where multiple cables exist in an excavation, cables other than the one being worked on shall be protected as necessary.
 3. Before cutting into a cable or opening a splice, the cable should be identified and verified to be the proper cable.
 4. When multiple cables exist in an excavation, the cable to be worked on shall be positively identified.
- F. Operation of power-driven equipment
- Employees should avoid being in manholes where power-driven rodding equipment is in operation.

Section 43. Additional rules for communications employees

430. General

Communications employees shall observe the following rules in addition to the rules contained in Section 42.

431. Approach to energized conductors or parts

- A. No employee shall approach, or bring any conductive object, within the distances to any exposed energized part as listed in Table 431-1. When repairing storm damage to communication lines that are joint use with electric supply lines at that or another point, employees shall:
1. Treat all such supply and communication lines as energized to the highest voltage to which they are exposed, or
 2. Assure that the supply lines involved are de-energized and grounded in accordance with Section 44.
- B. Altitude correction

The distances in Table 431-1 shall be used at elevations below 3600 m (12 000 ft). Altitude correction factors as indicated in Table 441-5 shall be applied above that altitude. Altitude correction factors shall be applied only to the electrical component of the minimum approach distance.

(m)

Table 431-1—Communication work minimum approach distances
(See Rule 431 in its entirety.)

Voltage range phase-to-phase (rms) ^①	Distance to employee at altitudes from sea level to 3600 m		
	0 to 50 V ^②	Not specified	
51 to 300 V ^②	Avoid contact		
301 to 750 V ^②	0.31 m		
751 V to 15 kV	0.65 m		
15.1 kV to 36 kV	0.91 m		
36.1 kV to 46 kV	1.06 m		
46.1 kV to 72.5 kV	1.22 m		
Voltage range phase-to-phase (rms) ^①	At altitudes from		
	0 to 900 m	90 to 1800 m	1801 to 3600 m
72.6 to 121 kV	1.43 m	1.50 m	1.64 m
121.1 to 169 kV	1.75 m	1.85 m	2.04 m
169.1 to 362 kV	3.70 m	3.95 m	4.48 m
362.1 to 800 kV	7.19 m	7.72 m	8.84 m

- ①For single-phase lines off three-phase systems, use the phase-to-phase voltage of that system.
 ②For single-phase systems, use the highest voltage available.
 ③The data used to calculate Table 431-1(m) was derived from test data taken under standard atmospheric conditions for dry and clean insulators. Standard atmospheric conditions are defined as temperatures above freezing, wind less than 24 km per hr, and normal barometric pressure with unsaturated and uncontaminated air.

(ft)

Table 431-1—Communication work minimum approach distances
 (See Rule 431 in its entirety.)

Voltage range phase-to-phase (rms) ^①	Distance to employee at altitudes from sea level to 12 000 ft		
	At altitudes from		
	0 to 3000 ft	3001 to 6000 ft	6001 to 12 000 ft
0 to 50 V ^②	Not specified		
51 to 300 V ^②	Avoid contact		
301 to 750 V ^②	1 ft-0 in		
751 V to 15 kV	2 ft-2 in		
15.1 kV to 36 kV	3 ft-0 in		
36.1 kV to 46 kV	3 ft-6 in		
46.1 kV to 72.5 kV	4 ft-0 in		
Voltage range phase-to-phase (rms) ^①	At altitudes from		
	0 to 3000 ft	3001 to 6000 ft	6001 to 12 000 ft
72.6 kV to 121 kV	4 ft-9 in	4 ft-11 in	5 ft-5 in
121.1 kV to 169 kV	5 ft-10 in	6 ft-1 in	6 ft-9 in
169.1 kV to 362 kV	12 ft-3 in	13 ft-0 in	14 ft-9 in
362.1 kV to 800 kV	23 ft-8 in	25 ft-4 in	29 ft-0 in

- ①For single-phase lines off three-phase systems, use the phase-to-phase voltage of that system.
 ②For single-phase systems, use the highest voltage available.
 ③The data used to calculate Table 431-1(ft) was derived from test data taken under standard atmospheric conditions for dry and clean insulators. Standard atmospheric conditions are defined as temperatures above freezing, wind less than 15 mi per hr, and normal barometric pressure with unsaturated and uncontaminated air.

432. Joint-use structures

When working on jointly used poles or structures, employees shall not approach closer than distances specified in Table 431-1 and shall not position themselves above the level of the lowest electric supply conductor exclusive of vertical runs and street lighting.

EXCEPTION: On voltages 140 kV and below, this rule does not apply where communications facilities are attached above electric supply conductors if a rigid fixed barrier has been installed between the supply and communications facilities.

433. Attendant on surface at joint-use manhole

While personnel are in a joint-use manhole, an employee shall be available on the surface in the immediate vicinity to render assistance as may be required.

434. Sheath continuity

Metallic or semiconductive sheath continuity shall be maintained by bonding across the opening, or by equivalent means, when working on buried cable or on cable in manholes.

Section 44. Additional rules for supply employees

440. General

Supply employees shall observe the following rules in addition to the rules contained in Section 42.

441. Energized conductors or parts

Employees shall not approach, or knowingly permit others to approach, any exposed ungrounded part normally energized except as permitted by this rule.

A. Minimum approach distance to live parts

1. General

Employees shall not approach or bring any conductive object within the minimum approach distance listed in Table 441-1 or 441-4 to exposed parts unless one of the following is met:

- a. The line or part is de-energized and grounded per Rule 444D.
- b. The employee is insulated from the energized line or part. Electrical protective equipment insulated for the voltage involved, such as tools, gloves, rubber gloves, or rubber gloves with sleeves, shall be considered effective insulation for the employee from the energized part being worked on.
- c. The energized line or part is insulated from the employee and from any other line or part at a different voltage.
- d. The employee is performing barehand live-line work according to Rule 446.

2. Precautions for approach—Voltages from 51 V to 300 V

Employees shall not contact exposed energized parts operating at 51 V to 300 V, unless the provisions of Rule 441A1 are met.

3. Precautions for approach—Voltages from 301 V to 72.5 kV

At voltages from 301 V to 72.5 kV, employees shall be protected from phase-to-phase and phase-to-ground differences in voltage. See Table 441-1 for the minimum approach distances to live parts.

- a. When exposed grounded lines, conductors, or parts are in the work area, they shall be guarded or insulated.
- b. When the Rubber Glove Work Method is employed, rubber insulating gloves, insulated for the maximum use voltage as listed in Table 441-6, shall be worn whenever employees are within the reach or extended reach of the minimum approach distances listed in Table 441-1, supplemented by one of the following two protective methods:
 - (1) The employee shall wear rubber insulating sleeves, insulated for the maximum use voltage as listed in Table 441-6, in addition to the rubber insulating gloves.
EXCEPTION: When work is performed on electric supply equipment energized at 750 V or less, rubber sleeves are not required if only the live parts being worked on are exposed.
 - (2) All exposed energized lines or parts, other than those temporarily exposed to perform work and maintained under positive control, located within maximum reach of the employee's work position, shall be covered with insulating protective equipment.
EXCEPTION: When work is being performed on parts energized between 300 V and 750 V within enclosed spaces, (e.g., control panels and relay cabinets), insulating or guarding of all exposed grounded lines, conductors, or parts in the work area is not required provided that employees use insulated tools and/or gloves and that exposed grounded lines, conductors, or parts are covered to the extent feasible.

- c. When the Rubber Glove Work Method is employed at voltages above 15 kV phase-to-phase, supplementary insulation (e.g., insulated aerial device or structure-mounted insulating work platform), tested for the voltage involved shall be used to support the worker.
 - d. Cover-up equipment used to insulate phase-to-phase exposure shall be rated for not less than the phase-to-phase voltage of the circuit(s) in the work area. All other cover-up equipment shall be rated for not less than the phase-to-ground voltage of the circuit(s). The determination of whether phase-to-phase or phase-to-ground exposure exists shall be based on factors such as but not limited to: work rules, conductor spacing, worker position, and task being performed.
 - e. Cover-up equipment, when used, shall be applied to the exposed facilities as the employee first approaches the facilities from any direction, be that from the structure or from an aerial device, and shall be removed in the reverse order. This protective cover-up shall extend beyond the reach of the employee's anticipated work position or extended reach distance.
4. Precautions for approach above 72.5 kV

The minimum approach distance (distance to employee) for live work is determined by the requirements in Rule 441A4a or 441A4b. If the requirements in Rule 441A4b cannot be met in their entirety, Rule 441A4a shall be used.

- a. For work on exposed parts operating at phase-to-phase voltage above 72.5 kV, where the maximum anticipated per-unit overvoltage factor (T) at the worksite has not been determined by an engineering analysis, the ac live work minimum approach distances (distance to employee) in Tables 441-2, 441-3, and 441-4 shall be used with a T of 3.0 for voltages up to 362.0 kV, 2.4 for voltages between 362.1 kV and 550.0 kV, and 2.0 for 550.1 kV to 800 kV. However, if the system is protected by single break interrupter devices, the ac live work minimum approach distances (distance to employee) in Tables 441-2, 441-3, and 441-4 shall be used with the maximum T for the specific voltage.
- b. For work on exposed parts operating at phase-to-phase voltage above 72.5 kV, where the T at the worksite has been determined by engineering analysis, the live work minimum approach distances (distance to employee) in Tables 441-2, 441-3, and 441-4 may be used with the determined value of T, providing that all of the following conditions are met.

EXCEPTION: If a temporary (transient) overvoltage control device (TTOCD), as defined in Rule 441A6, has been installed adjacent to the worksite to limit the maximum worksite maximum anticipated overvoltage (TOV), the value of the T to be used to determine the live work minimum approach distance in Tables 441-2, 441-3, and 441-4 shall be the T value determined in Rule 441A5 or the maximum anticipated per-unit overvoltage factor of the TTOCD (T_{TTOCD}) value obtained from Rule 441A6, plus 0.2 p.u., whichever is smaller. When installing or removing the TTOCD adjacent to the worksite, the T value determined by engineering analysis shall be used.

- (1) All of the equipment evaluated in determining the T value by the engineering analysis shall be operational.
- (2) Automatic reclosing shall be disabled at all terminals of the line on which live work is being performed.

EXCEPTION: If required for system stability, one high-speed automatic reclose may be permitted, providing that the circuit interrupters or isolating devices to be reclosed cannot produce at the worksite an overvoltage value exceeding the value of the T being used at the worksite. This value shall be determined from an engineering analysis.

- (3) The altitude corrections according to Rule 441A6b shall be used when the elevation of the worksite is above 900 m (3000 ft) above sea level.
- (4) For dc work, the relative humidity at the worksite shall be less than 85%.

5. Temporary (transient) overvoltage control device (TTOCD)

TTOCD, which are designed and tested for installation adjacent to the worksite to limit the TOV at the worksite, may be used to obtain a lower value of T.

An engineering analysis, including laboratory testing, of the TTOCD shall be performed to determine and identify the range of sparkover voltages. The withstand and sparkover characteristics of a TTOCD are determined by sparkover probability data for the particular protective gap geometry, gap distance, and conductor bundle geometry. The TOV rating for the TTOCD device shall be determined from test data and shall be the voltage at which the device sparks over 50% of the time. The T_{TTOCD} is calculated by dividing the TOV rating of the device by nominal peak voltage rounded-up to one decimal place.

As an example of determining T_{TTOCD} , for a line operating at 345 kV, using TTOCD which has been installed adjacent to the worksite to limit the maximum worksite T_{TTOCD} , having a TOV rating of 510 kV:

$$T_{TTOCD} = 510 / ((362 \cdot 1.414) / 1.732)$$

$$T_{TTOCD} = 510 / 295.53 = 1.72 \text{ or } 1.8$$

6. Altitude correction

The distances in Tables 441-2, 441-3, and 441-4 shall be used at elevations below 900 m (3000 ft). Above that altitude, the minimum approach distance shall be increased by:

- a. Multiplying the electrical component of the minimum approach distance by the applicable altitude correction factors of Table 441-5, and
- b. Adding the result to the values for inadvertent movement required by Rule 441A7a.

NOTE: The electrical component of clearance included in Tables 441-2, 441-3, and 441-4 is the table value less the value for inadvertent movement for that voltage shown in Rule 441A7a.

7. Determining the minimum approach distances (distances to employee)

- a. Minimum approach distances calculated under this rule for 0.301 kV to 0.750 kV contain the electrical component plus 0.30 m (1 ft) for inadvertent movement. Voltages 0.751 kV to 72.5 kV contain the electrical component plus 0.61 m (2 ft) for inadvertent movement. Above 72.5 kV, the inadvertent movement distance is 0.31 m (1 ft).
- b. Data for minimum approach distances between 1.1 and 72.5 kV shown in Table 441-1 was obtained from rod gap data measured in metric units; the values in Table 441-1 are derived from metric and converted to feet and inches.
- c. Data for minimum approach distances above 72.5 kV shown in Tables 441-2, 441-3, and 441-4 was taken from IEEE Std 516-2003. In IEEE Std 516-2003, the customary unit tables are calculated in feet to two decimal places. The second decimal place is rounded up if the third decimal place is other than zero. The metric tables were calculated from the ft tables and rounded up to two decimal places, using a conversion factor of 0.3048 m per ft. For this reason, the customary-unit tables do not exactly convert into the values shown in the metric tables.
- d. The voltage ranges are contained in ANSI C84.1-1995, Table 1.

B. Additional approach requirements

1. The clear insulation distance associated with insulators shall be the shortest straight-line air-gap distance from the nearest energized part to the nearest grounded part.
2. When working on insulators under live work procedures employing rubber gloves or live-line tools, the clear insulation distance shall be not less than the straight-line distance in air required by Rule 441A4.
3. Work may be performed at the grounded end of an open switch if all of the following conditions are met:

- a. The air-gap distance of the switch shall not be reduced in any manner. This distance shall be not less than the minimum approach distances determined by Rules 441A2, 441A3, and 441A4 less the inadvertent movement values. The inadvertent movement values of Rule 441A7(a) are not required in this distance.
 - b. The minimum approach distance to the energized part of the switch shall be not less than that required by Rules 441A2, 441A3, and 441A4.
4. Special rules for working on insulator assemblies operating above 72.5 kV
- a. When work is to be performed at the ground end of an insulator assembly, the minimum approach distance to the nearest energized part may equal the straight-line distance measured along the insulators.
 - b. For suspension insulator assembly installations (see ANSI C29.2-1992) operating above 72.5 kV (ac), the first insulator at the grounded end may be temporarily shorted out as part of the work procedure. Before temporarily shorting out any insulator units, as part of the work procedure, each of the insulator units in the string shall be tested to determine the number and location of any failed units.
EXCEPTION: For voltages at 230 kV (ac) and above, up to three insulator units may be temporarily shorted out as part of the work procedure, provided that the minimum approach distance requirements of Rule 441A4 are met.
 - c. When performing live work employing the barehand technique on installations operating above 72.5 kV (ac), the first insulator at the energized (hot) end of a suspension insulator assembly (see ANSI C29.2-1992) may be shorted out during the work. Before temporarily shorting out any insulator units, as part of the work procedure, each of the insulator units in the string shall be tested to determine the number and location of any failed units.
EXCEPTION: For voltages at 230 kV (ac) and above, up to three insulator units may be temporarily shorted out as part of the work procedure, provided that the minimum approach distance requirements of Rule 441A4 are met.
 - (1) The minimum approach distance to the grounded end of the insulator assembly may be equal to the straight-line distance from the nearest energized part to the closest grounded part across the insulators.
 - (2) The straight-line insulation distance shall be not less than the values required by Rule 441A4.

C. Live-line tool clear insulation length

1. Clear live-line tool length

The clear live-line tool distance shall be not less than the distance measured longitudinally along the live-line tool from the conductive part at the working end of the tool and any part of the employee. Distances for conducting sections (such as metallic splices and hardware) shall be subtracted from the clear live-line length. The clear live-line tool length shall equal or exceed the values for the minimum approach distance in Tables 441-1, 441-2, 441-3, and 441-4 for the indicated voltage ranges. The minimum clear live-line tool distance shall be the distance measured longitudinally along the live-line tool from the conductive part at the working end of the tool to any part of the employee.

2. Live-line conductor support tool length

Conductor support tools such as link sticks, strain carriers, and insulator cradles may be used provided that the clear insulating distance is at least as long as the insulator string or the maximum distance specified in Rule 441A4. When installing this equipment, the employee shall maintain the minimum approach distance required equal to the clear insulating length for the support tools.

NOTE: Conductive components of tools disturb the field in the gap and decrease the insulation value of the tool more than the linear subtraction of the length(s) of the conductive components.

Table 441-1—AC live work minimum approach distance^①
 (See Rule 441 in its entirety.)

Voltage in kilovolts phase-to-phase ^{① ②}	Distance to employee			
	Phase-to-ground		Phase-to-phase	
	(m)	(ft-in)	(m)	(ft-in)
0 to 0.050 ^①	Not specified		Not specified	
0.051 to 0.300 ^①	Avoid contact		Avoid contact	
0.301 to 0.750 ^①	0.31	1-0	0.31	1-0
0.751 to 15	0.65	2-3	0.67	2-3
15.1 to 36.0	0.77	2-10	0.86	2-10
36.1 to 46.0	0.84	3-3	0.96	3-3
46.1 to 72.5	1.00 ^③	3-11	1.20	3-11

①For single-phase systems, use the highest voltage available.

②For single-phase lines off three phase systems, use the phase-to-phase voltage of the system.

③The 46.1 to 72.5 kV phase-to-ground 3-3 distance contains a 1-3 electrical component and a 2-0 inadvertent movement component.

④Distances listed are for standard atmospheric conditions. The data used to formulate this table was obtained from test data taken with standard atmospheric conditions. Standard atmospheric conditions are defined as temperatures above freezing, wind less than 15 mi per hr or 24 km per hr, unsaturated air, normal barometer, uncontaminated air, and clean and dry insulators. If standard atmospheric conditions do not exist, extra care must be taken.

m

Table 441-2—AC live work minimum approach distances for altitudes less than 900 m above sea level, where T has been determined according to Rule 441A5^① ②

(See Rule 441 in its entirety.)

Maximum anticipated per unit overvoltage factor T	Distance to employee—phase-to-ground work, in air, barehand, and clear live-line tool						
	Maximum phase-to-phase voltage in kV						
	72.5 to 121.0	121.1 to 145.0	145.1 to 169.0	169.1 to 242.0	242.1 to 362.0	362.1 to 550.0	550.1 to 800.0
1.5	0.72	0.73	0.80	1.01	1.36	1.96	3.16
1.6	0.79	0.76	0.83	1.05	1.43	2.12	3.46
1.7	0.86	0.78	0.86	1.10	1.50	2.28	3.78
1.8	0.93	0.81	0.90	1.15	1.57	2.45	4.11
1.9	1.01	0.84	0.93	1.20	1.64	2.62	4.45
2.0	1.07	0.87	0.96	1.24	1.71	2.82	4.84 ^③
2.1	1.10	0.90	0.99	1.29	1.78	3.01	5.22
2.2	1.12	0.92	1.03	1.34	1.88	3.20	5.60
2.3	1.14	0.95	1.06	1.38	1.98	3.40	6.00
2.4	1.16	0.98	1.09	1.43	2.08	3.61 ^③	6.46
2.5	1.18	1.01	1.12	1.48	2.19	3.84	6.89
2.6	1.20	1.04	1.16	1.52	2.30	4.06	
2.7	1.23	1.06	1.19	1.57	2.41	4.30	
2.8	1.25	1.09	1.22	1.62	2.54	4.56	
2.9	1.27	1.12	1.26	1.66	2.65	4.80	
3.0 ^③	1.29	1.15	1.29	1.71	2.77	5.07	
3.1	1.31	1.18	1.32	1.76	2.89		
3.2	1.33	1.20	1.35	1.82	3.02		
3.3	1.36	1.23	1.39	1.88	3.15		
3.4	1.37	1.26	1.42	1.94	3.27		
3.5	1.39	1.29	1.45	2.02	3.40		

①Distances listed are for standard atmospheric conditions. The data used to formulate this table was obtained from test data taken with standard atmospheric conditions. Standard atmospheric conditions are defined as temperatures above freezing, wind less than 24 km per hr, unsaturated air, normal barometer, uncontaminated air, and clean and dry insulators. If standard atmospheric conditions do not exist, extra care must be taken.

②Distances are based on altitudes below 900 m above sea level. For altitudes above 900 m, Rule 441A6 applies.

③See Rule 441A4a.

ft

Table 441-2—AC live work minimum approach distances for altitudes less than 3000 ft above sea level, where T has been determined according to Rule 441A5^① ②
(See Rule 441 in its entirety.)

Maximum anticipated per unit overvoltage factor T	Distance to employee—phase-to-ground work, in air, barehand, and clear live-line tool													
	Maximum phase-to-phase voltage in kV													
	72.5 to 121.0		121.1 to 145.0		145.1 to 169.0		169.1 to 242.0		242.1 to 362.0		362.1 to 550.0		550.1 to 800.0	
	ft	in	ft	in	ft	in	ft	in	ft	in	ft	in	ft	in
1.5	2	2	2	5	2	8	3	4	4	6	6	6	10	5
1.6	2	3	2	6	2	9	3	6	4	9	7	0	11	5
1.7	2	4	2	7	2	10	3	8	4	11	7	6	12	5
1.8	2	5	2	8	3	0	3	10	5	2	8	1	13	6
1.9	2	6	2	9	3	1	4	0	5	5	8	8	14	8
2.0	2	7	2	11	3	2	4	1	5	8	9	4	15	11 ^①
2.1	2	8	3	0	3	4	4	3	5	10	9	11	17	2
2.2	2	9	3	1	3	5	4	5	6	2	10	7	18	5
2.3	2	10	3	2	3	6	4	7	6	6	11	2	19	9
2.4	2	11	3	3	3	7	4	9	6	10	11	10 ^①	21	3
2.5	3	0	3	4	3	9	4	11	7	3	12	8	22	8
2.6	3	0	3	5	3	10	5	0	7	7	13	4		
2.7	3	1	3	6	3	11	5	2	7	11	14	2		
2.8	3	2	3	7	4	1	5	4	8	4	14	12		
2.9	3	3	3	9	4	2	5	6	8	9	15	9		
3.0 ^③	3	4	3	10	4	3	5	8	9	2	16	8		
3.1	3	5	3	11	4	4	5	10	9	6				
3.2	3	6	4	0	4	6	6	0	9	11				
3.3	3	7	4	1	4	7	6	3	10	4				
3.4	3	8	4	2	4	8	6	5	10	9				
3.5	3	9	4	3	4	10	6	8	11	3				

①Distances listed are for standard atmospheric conditions. The data used to formulate this table was obtained from test data taken with standard atmospheric conditions. Standard atmospheric conditions are defined as temperatures above freezing, wind less than 15 mi per hr, unsaturated air, normal barometer, uncontaminated air, and clean and dry insulators. If standard atmospheric conditions do not exist, extra care must be taken.

②Distances are based on altitudes below 3000 ft above sea level. For altitudes above 3000 ft, Rule 441A6 applies.

③See Rule 441A4a.

Table 441-3—AC live work minimum approach distances for altitudes less than 3000 ft above sea level, where the T has been determined according to Rule 441A5^{① ②}
 (See Rule 441 in its entirety.)

Maximum anticipated per unit overvoltage factor T	Distance to employee—phase-to-phase work, in air, barehand, and clear live-line tool						
	Maximum phase-to-phase voltage in kV						
	72.5 to 121.0	121.1 to 145.0	145.1 to 169.0	169.1 to 242.0	242.1 to 362.0	362.1 to 550.0	550.1 to 800.0
1.5	0.76	0.85	0.94	1.21	1.65	2.43	3.96
1.6	0.84	0.94	1.05	1.36	1.89	2.86	4.76
1.7	0.92	1.04	1.16	1.53	2.13	3.33	5.62
1.8	1.00	1.13	1.27	1.68	2.36	3.80	6.51
1.9	1.08	1.23	1.38	1.85	2.61	4.32	7.48
2.0	1.15	1.32	1.48	2.00	2.83	4.84	8.47 ^③
2.1	1.18	1.35	1.53	2.05	2.91	5.09	9.00
2.2	1.20	1.38	1.56	2.09	3.03	5.32	9.47
2.3	1.22	1.41	1.59	2.14	3.15	5.57	9.99
2.4	1.25	1.44	1.62	2.19	3.27	5.82 ^③	10.58
2.5	1.27	1.46	1.65	2.23	3.39	6.11	11.10
2.6	1.29	1.49	1.69	2.28	3.53	6.39	
2.7	1.32	1.52	1.72	2.33	3.67	6.71	
2.8	1.35	1.55	1.76	2.38	3.83	7.03	
2.9	1.37	1.58	1.79	2.43	3.97	7.32	
3.0 ^③	1.39	1.61	1.82	2.48	4.10	4.64	
3.1	1.41	1.63	1.85	2.52	4.24		
3.2	1.43	1.66	1.88	2.58	4.37		
3.3	1.46	1.69	1.92	2.66	4.54		
3.4	1.48	1.71	1.94	2.71	4.67		
3.5	1.50	1.73	1.97	2.80	4.80		

①Distances listed are for standard atmospheric conditions. The data used to formulate this table was obtained from test data taken with standard atmospheric conditions. Standard atmospheric conditions are defined as temperatures above freezing, wind less than 24 km per hr, unsaturated air, normal barometer, uncontaminated air, and clean and dry insulators. If standard atmospheric conditions do not exist, extra care must be taken.
 ②Distances are based on altitudes below 900 m above sea level. For altitudes above 900 m, Rule 441A6 applies.
 ③See Rule 441A4a.

ft

Table 441-3—AC live work minimum approach distances for altitudes less than 3000 ft above sea level, where T has been determined according to Rule 441A5^① ②
(See Rule 441 in its entirety.)

Maximum anticipated per unit overvoltage factor T	Distance to employee—phase-to-phase work, in air, barehand, and clear live-line tool													
	Maximum phase-to-phase voltage in kV													
	72.5 to 121.0		121.1 to 145.0		145.1 to 169.0		169.1 to 242.0		242.1 to 362.0		362.1 to 550.0		550.1 to 800.0	
	ft	in	ft	in	ft	in	ft	in	ft	in	ft	in	ft	in
1.5	2	6	2	10	3	1	4	0	5	6	8	0	13	0
1.6	2	9	3	2	3	6	4	6	6	3	9	5	15	8
1.7	3	1	3	5	3	10	5	1	7	0	11	0	18	6
1.8	3	4	3	9	4	3	5	7	7	9	12	6	21	5
1.9	3	7	4	1	4	7	6	1	8	7	14	3	24	7
2.0	3	10	4	4	4	11	6	7	9	4	15	11	27	10 ^③
2.1	3	11	4	6	5	1	6	9	9	7	16	9	29	7
2.2	4	0	4	7	5	2	6	11	10	0	17	6	31	1
2.3	4	1	4	8	5	3	7	1	10	5	18	4	32	10
2.4	4	2	4	9	5	4	7	3	10	9	19	2 ^③	34	9
2.5	4	3	4	10	5	6	7	4	11	2	20	1	36	6
2.6	4	3	4	11	5	7	7	6	11	7	21	0		
2.7	4	4	5	0	5	8	7	8	12	1	22	0		
2.8	4	6	5	1	5	10	7	10	12	7	23	1		
2.9	4	6	5	3	5	11	8	0	13	1	24	0		
3.0 ^③	4	7	5	4	6	0	8	2	13	6	25	1		
3.1	4	8	5	5	6	1	8	4	13	11				
3.2	4	9	5	6	6	2	8	6	14	5				
3.3	4	10	5	7	6	4	8	9	14	11				
3.4	4	11	5	8	6	5	8	11	15	4				
3.5	5	0	5	9	6	6	9	3	15	9				

①Distances listed are for standard atmospheric conditions. The data used to formulate this table was obtained from test data taken with standard atmospheric conditions. Standard atmospheric conditions are defined as temperatures above freezing, wind less than 15 mi per hr, unsaturated air, normal barometer, uncontaminated air, and clean and dry insulators. If standard atmospheric conditions do not exist, extra care must be taken.

②Distances are based on altitudes below 3000 ft above sea level. For altitudes above 3000 ft, Rule 441A6 applies.

③See Rule 441A4a.

m

Table 441-4—DC live work minimum approach distance for altitudes less than 900 m above sea level

(See Rule 441 in its entirety.)

Maximum anticipated per unit overvoltage factor T	Distance to employee—pole-to-ground, air, barehand, clear live-line tool				
	Maximum pole-to-pole voltage in kV				
	0 to 250	251 to 400	401 to 500	501 to 600	601 to 750
1.5 or lower	1.12	1.60	2.06	2.62	3.61
1.6	1.17	1.69	2.24	2.86	3.98
1.7	1.23	1.82	2.42	3.12	4.37
1.8	1.28	1.95	2.62	3.39	4.79

ft

Table 441-4—DC Live work minimum approach distance for altitudes less than 3000 ft above sea level

(See Rule 441 in its entirety.)

Maximum anticipated per unit overvoltage factor T	Distance to employee—pole-to-ground, air, barehand, clear live-line tool									
	Maximum pole-to-pole voltage in kV									
	0 to 250		251 to 400		401 to 500		501 to 600		601 to 750	
	ft	in	ft	in	ft	in	ft	in	ft	in
1.5 or lower	3	8	5	3	6	9	8	7	11	10
1.6	3	10	5	7	7	4	9	5	13	1
1.7	4	1	6	0	7	11	10	3	14	4
1.8	4	3	6	5	8	7	11	2	15	9

NOTES for Table 441-4 (m and ft)

1. When the value of T at the worksite has not been determined according to Rule 441A5, T = 1.8 shall be used.
2. The data used to calculate these tables was obtained from test data taken with standard atmospheric conditions. Standard atmospheric conditions are defined as temperatures above freezing, wind less than 15 mi per hr or 24 km per hr, unsaturated air, normal barometer, uncontaminated air, and clean and dry insulators. If standard atmospheric conditions do not exist, extra care must be taken.
3. For altitudes above 3000 ft or 900 m, Rule 441A6 applies.

Table 441-5—Altitude correction factor
(See Rule 441 in its entirety.)

Altitude		Correction factor
(m)	(ft)	
Sea level to 900	Sea level to 3,000	1.00
901 to 1,200	3,001 to 4,000	1.02
1201 to 1500	4,001 to 5,000	1.05
1501 to 1800	5,001 to 6,000	1.08
1801 to 2100	6,001 to 7,000	1.11
2101 to 2400	7,001 to 8,000	1.14
2401 to 2700	8,001 to 9,000	1.17
2701 to 3000	9,001 to 10,000	1.20
3001 to 3600	10,001 to 12,000	1.25
3601 to 4200	12,001 to 14,000	1.30

Table 441-6—Maximum use voltage for rubber insulating equipment

Class of equipment	Maximum use voltage ^①
00	500
0	1000
1	7500
2	17 000
3	26 500
4	36 000

①The maximum use voltage is the ac voltage (rms) rating of the protective equipment that designates the maximum nominal design voltage of the energized system that may be safely worked. The nominal design voltage is equal to the phase-to-phase voltage on multiphase circuits.

EXCEPTION 1: If there is no multiphase exposure in a system area (at the worksite) and the voltage exposure is limited to the phase (polarity on dc systems) to ground potential, the phase (polarity on dc systems) to ground potential shall be considered to be the nominal design voltage.

EXCEPTION 2: If electric equipment and devices are insulated, isolated, or both, such that the multiphase exposure on a grounded wye circuit is removed and if supplemental insulation (e.g., insulated aerial device or structure-mounted insulating work platform) is used to insulate the employee from ground, then the nominal design voltage may be considered as the phase-to-ground voltage on that circuit.

442. Switching control procedures

A. Designated person

A designated person shall:

1. Keep informed of operating conditions affecting the safe and reliable operation of the system.
2. Maintain a suitable record showing operating changes in such conditions.
3. Issue or deny authorization for switching, as required, for safe and reliable operation.

B. Specific work

Authorization from the designated person shall be secured before work is begun on or in the vicinity of station equipment, transmission, or interconnected feeder circuits and where circuits are to be de-energized at stations. The designated person shall be notified when such work ceases.

EXCEPTION 1: In an emergency, to protect life or property, or when communication with the designated person is difficult because of storms or other causes, any qualified employee may make repairs on or in the vicinity of the equipment or lines covered by this rule without special authorization if the qualified employee can clear the trouble promptly with available help in compliance with the remaining rules. The designated person shall thereafter be notified as soon as possible of the action taken.

EXCEPTION 2: Suspension of normal rule or rules under disaster conditions: Where catastrophic service disruptions occur (e.g., earthquake, hurricane) and where multiple employer crews may be imported to assist in service restorations, the normal use of Rule 442 procedures may be suspended provided that:

- (a) Each individual involved in system repairs is informed of the suspension of normal rules.
- (b) Employees are required to observe all requirements of Rules 443 and 444, including protection designated from step and touch potentials.
- (c) Equipment used to de-energize or re-energize circuits at designated points of control (e.g., station breakers) is operated in conformance with Rules 442A and 442D.
- (d) Tagging requirements under Rule 444C, for this *EXCEPTION*, shall include, and may be limited to, designated points of control.

C. Operations at stations

Qualified employees shall obtain authorization from the designated person before switching sections of circuits.

In the absence of specific operating schedules, employees shall secure authorization from the designated person before opening and closing supply circuits or portions thereof or starting and stopping equipment affecting system operation at stations.

EXCEPTION 1: Sections of distribution circuits are excepted if the designated person is notified as soon as possible after the action is taken.

EXCEPTION 2: In an emergency, to protect life or property, any qualified employee may open circuits and stop moving equipment without special authorization if, in the judgment of the qualified employee, this action will promote safety, but the designated person shall be notified as soon as possible of such action, with reasons therefore.

D. Re-energizing after work

Instructions to re-energize equipment or lines that have been de-energized by permission of the designated person shall not be issued by the designated person until all employees who requested the line to be de-energized have reported clear. Employees who have requested equipment or lines de-energized for other employees or crews shall not request that equipment or lines be re-energized until all of the other employees or crews have reported clear. The same procedure shall be followed when more than one location is involved.

E. Tagging electric supply circuits associated with work activities

1. Equipment or circuits that are to be treated as de-energized and grounded per Rule 444D shall have suitable tags attached to all points where such equipment or circuits can be energized.
2. When the automatic reclosing feature of a reclosing device is disabled during the course of work on energized equipment or circuits, a tag shall be placed at the reclosing device location.

EXCEPTION: If the automatic reclosing feature of a reclosing device is disabled by a Supervisory Control and Data Acquisition System (SCADA), the system shall provide for the following:

- (a) At the SCADA operating point
 - (1) A signal is received by the SCADA operator confirming that the disabling operation has occurred at the reclosing device location, and
 - (2) A readily visible tag or electronic display is used to inform any potential SCADA operator that a disabling operation has been initiated, and
 - (3) The tag or electronic display is removed before action is taken to re-enable the automatic reclosing feature.
- (b) At the reclosing device location
 - (1) The reclosing feature is disabled in such a manner as to prevent manual override of the normal control by any potential on-site operator, or
 - (2) A signal, flag, or other display is used in such a manner as to alert any potential on-site operator that the reclosing feature has been disabled.
- 3. The required tags shall be placed to clearly identify the equipment or circuits on which work is being performed.

F. Restoration of service after automatic trip

- 1. When circuits or equipment upon which tags have been placed open automatically, the circuits or equipment shall be left open until reclosing has been authorized.
- 2. When circuits open automatically, local operating rules shall determine in what manner and how many times they may be closed with safety.

G. Repeating oral messages

Each employee receiving an oral message concerning the switching of lines and equipment shall immediately repeat it back to the sender and obtain the identity of the sender. Each employee sending such an oral message shall require it to be repeated back by the receiver and secure the latter's identity.

443. Work on energized lines and equipment

A. General requirements

- 1. When working on energized lines and equipment, one of the following safeguards shall be applied:
 - a. Insulate employee from energized parts
 - b. Isolate or insulate the employee from ground and grounded structures, and potentials other than the one being worked on
- 2. Employees shall not place dependence for their safety on the covering (nonrated insulation) of wires. All precautions (see Section 44) for working on energized parts shall be observed.
- 3. All employees working on or in the vicinity of lines or equipment exposed to voltages higher than those guarded against by the safety protective equipment provided shall assure themselves that the equipment or lines on which they are working are free from dangerous leakage or induction, or have been effectively grounded.
- 4. Cutting into insulating coverings of energized conductors
 - a. A supply cable to be worked on as de-energized that cannot be positively identified or determined to be de-energized shall be pierced or severed at the work location with a tool designed for the purpose.
 - b. Before cutting into an energized supply cable, the operating voltage shall be determined and appropriate precautions taken for handling conductors at that voltage.
 - c. When the insulating covering on energized wires or cables must be cut into, the employee shall use a tool designed for the purpose. While doing such work, suitable eye protection

and insulating gloves with protectors shall be worn. Employees shall exercise extreme care to prevent short-circuiting conductors when cutting into the insulation.

5. Metal measuring tapes, and tapes or ropes containing metal threads or strands, shall not be used closer to exposed energized parts than the distance specified in Rule 441A. Care should be taken when extending metallic ropes or tapes parallel to and in the proximity of high-voltage lines because of the effect of induced voltages.
 6. Equipment or material of a noninsulating substance that is not bonded to an effective ground and which extends into an energized area, and which could approach energized equipment closer than the distance specified in Rule 441A, shall be treated as though it is energized at the same voltage as the line or equipment to which it is exposed.
- B. Requirement for assisting employee
- In inclement weather or at night, no employee shall work alone outdoors on or dangerously in the vicinity of energized conductors or parts of more than 750 V between conductors.
- EXCEPTION:* This shall not preclude a qualified employee, working alone, from cutting trouble in the clear, switching, replacing fuses, or similar work if such work can be performed safely.
- C. Opening and closing switches
- Manual switches and disconnectors shall always be closed by a continuous motion. Care should be exercised in opening switches to avoid serious arcing.
- D. Working position
- Employees should avoid working on equipment or lines in any position from which a shock or slip will tend to bring the body toward exposed parts at a potential different than the employee's body. Work should, therefore, generally be done from below, rather than from above.
- E. Protecting employees by switches and disconnectors
- When equipment or lines are to be disconnected from any source of electric energy for the protection of employees, the switches, circuit breakers, or other devices designated and designed for operation under the load involved at sectionalizing points shall be opened or disconnected first. When re-energizing, the procedure shall be reversed.
- F. Making connections
- In connecting de-energized equipment or lines to an energized circuit by means of a conducting wire or device, employees should first attach the wire to the de-energized part. When disconnecting, the source end should be removed first. Loose conductors should be kept away from exposed energized parts.
- G. Switchgear
- Switchgear shall be de-energized and grounded per Rule 444D prior to performing work involving removal of protective barriers unless other suitable means are provided for employee protection. The personnel safety features in switchgear shall be replaced after work is completed.
- H. Current transformer secondaries
- The secondary of a current transformer shall not be opened while energized. If the entire circuit cannot be properly de-energized before working on an instrument, a relay, or other section of a current transformer secondary circuit, the employee shall bridge the circuit with jumpers so that the current transformer secondary will not be opened.
- I. Capacitors
- Before employees work on capacitors, the capacitors shall be disconnected from the energizing source, short-circuited, and grounded. Any line to which capacitors are connected shall be short-circuited and grounded before it is considered de-energized. Since capacitor units may be connected in series-parallel, each unit shall be shorted between all insulated terminals and the capacitor tank before handling. Where the tanks of capacitors are on ungrounded racks, the racks shall also be grounded. The internal resistor shall not be depended upon to discharge capacitors.

J. Gas-insulated equipment

Employees working on gas-insulated cable systems or circuit breakers shall be instructed concerning the special precautions required for possible presence of arcing by-products of sulfur-hexafluoride (SF₆).

NOTE: By-products resulting from arcing in sulfur-hexafluoride (SF₆) gas-insulated systems are generally toxic and irritant. Gaseous by-products can be removed for maintenance on the compartments by purging with air or dry nitrogen. The solid residue that must be removed is mostly metallic fluoride. This fine powder absorbs moisture and produces fluorides of sulfur and hydrofluoric acid, which are toxic and corrosive.

K. Attendant on surface

While electric supply personnel are in a manhole, an employee shall be available on the surface in the immediate vicinity to render assistance from the surface. This shall not preclude the employee on the surface from entering the manhole to provide short-term assistance.

EXCEPTION: This shall not preclude a qualified employee, working alone, from entering a manhole where energized cables or equipment are in service, for the purpose of inspection, housekeeping, taking readings, or similar work if such work can be performed safely.

L. Unintentional grounds on delta circuits

Unintentional grounds on delta circuits shall be removed as soon as practical.

444. De-energizing equipment or lines to protect employees

A. Application of rule

1. When employees must depend on others to operate switches or otherwise de-energize circuits on which they are to work, or must secure special authorization before they operate such switches themselves, the precautionary measures that follow shall be taken in the order given before work is begun.
2. If the employee under whose direction a section of a circuit is disconnected is in sole charge of the section and of the means of disconnection, those portions of the following measures that pertain to dealing with the designated person may be omitted.
3. Records shall be kept on all contractual utility interactive systems on any electric supply lines. When these lines are de-energized according to Rule 444C, the utility interactive system shall be visibly disconnected from the lines.

B. Employee's request

The employee in charge of the work shall apply to the designated person to have the particular section of equipment or lines de-energized, identifying it by position, letter, color, number, or other means.

C. Operating switches, disconnectors, and tagging

The designated person shall direct the operation of all switches and disconnectors through which electric energy may be supplied to the particular section of equipment and lines to be de-energized, and shall direct that such switches and disconnectors be rendered inoperable and tagged. If switches that are controlled automatically or remotely or both can be rendered inoperable, they shall be tagged at the switch location. If it is impractical to render such switches and disconnectors inoperable, then these remotely controlled switches shall also be tagged at all points of control. A record shall be made when placing the tag, giving the time of disconnection, the name of the person making the disconnection, the name of the employee who requested the disconnection, and the name or title or both, of the designated person.

D. Employee's protective grounds

When all the switches and disconnectors designated have been operated, rendered inoperable where practical, and tagged in accordance with Rule 444C, and the employee has been given permission to work by the designated person, the employee in charge should immediately proceed to make the employee's own protective grounds or verify that adequate grounds have been applied (see Rule

445) on the disconnected lines or equipment. During the testing for potential and/or application of grounds, distances not less than those shown in Tables 441-1 to 441-3, as applicable, shall be maintained.

Grounds shall be placed at each side of the work location and as close as practical to the work location, or a worksite ground shall be placed at the work location. If work is to be performed at more than one location on a line section, the line section shall be grounded and short-circuited at one location in the line section and the conductor to be worked on shall be grounded at each work location.

The distance in Table 441-1, 441-2, or 441-3, as applicable, shall be maintained from ungrounded conductors at the work location. Where the making of a ground is impractical, or the conditions resulting therefrom are more hazardous than working on the lines or equipment without grounding, the ground may be omitted by special permission of the designated person.

E. Proceeding with work

1. After the equipment or lines have been de-energized and grounded per Rule 444D, the employee in charge, and those under the direction of the employee in charge, may proceed with work on the de-energized parts.

Equipment may be re-energized for testing purposes only under the supervision of the employee in charge and subject to authorization by the designated person.

2. Each additional employee in charge desiring the same equipment or lines to be de-energized and grounded per Rule 444D for the protection of that person, or the persons under direction, shall follow these procedures to secure similar protection.

F. Reporting clear—Transferring responsibility

1. The employee in charge, upon completion of the work and after ensuring that all persons assigned to this employee in charge are in the clear, shall remove protective grounds and shall report to the designated person that all tags protecting that person may be removed.
2. The employee in charge who received the permission to work may, if specifically permitted by the designated person, transfer the permission to work and the responsibility for persons by personally informing the affected persons of the transfer.

G. Removal of tags

1. The designated person shall then direct the removal of tags and the removal shall be reported back to the designated person by the persons removing them. Upon the removal of any tag, there shall be added to the record containing the name of the designated person or title or both, and the person who requested the tag, the name of the person requesting removal, the time of removal, and the name of the person removing the tag.
2. The name of the person requesting removal shall be the same as the name of the person requesting placement, unless responsibility has been transferred according to Rule 444F.

H. Sequence of re-energizing

Only after all protective grounds have been removed from the circuit or equipment and after protective tags have been removed in accordance with Rule 444G at a specific location, may the designated person direct the operation of switches and disconnectors at that location.

445. Protective grounds

A. Installing grounds

When placing protective grounds on a previously energized part, the following sequence and precautionary measures shall be observed.

EXCEPTION: In certain situations, such as when grounding conductors are supported on some high-voltage towers, it may be appropriate to perform the voltage test before bringing the grounding device into the work area.

1. Current-carrying capacity of grounds

The grounding device shall be of such size as to carry the induced current and anticipated fault current that could flow at the point of grounding for the time necessary to clear the line.

2. Initial connections

Before grounding any previously energized part, the employee shall first securely connect one end of the grounding device to an effective ground. Grounding switches may be employed to connect the equipment or lines being grounded to the actual ground connections.

3. Test for voltage

The previously energized parts that are to be grounded shall be tested for voltage except where previously installed grounds are clearly in evidence. The employee shall keep every part of the body at the required distance by using insulating handles of proper length or other suitable devices.

4. Completing grounds

- a. If the part shows no voltage, the grounding may be completed.
- b. If voltage is present, the source shall be determined to ensure that presence of this voltage does not prohibit completion of the grounding.
- c. After the initial connections are made to ground, the grounding device shall next be brought into contact with the previously energized part using insulating handles or other suitable devices and securely clamped or otherwise secured thereto. Where bundled conductor lines are being grounded, grounding of each subconductor should be made. Only then may the employee come within the distances from the previously energized parts specified in Rule 441A or proceed to work upon the parts as upon a grounded part.

B. Removing grounds

1. The employee shall first remove the grounding devices from the de-energized parts using insulating tools or other suitable devices.
2. In the case of multiple ground cables connected to the same grounding point, all phase connections shall be removed before removing any of the ground connections.
EXCEPTION: If the application of Rule 445B2 produces a hazard such as unintentional contact of the ground with ungrounded parts, then the grounds may be removed individually from each phase and ground connection.
3. Extreme caution shall be exercised that the proper sequence of installing or removing grounds is followed. The connection to the effective ground shall be removed last. Otherwise, electric shock and injury may result.

446. Live work

All employees using live work practices shall observe the following rules in addition to applicable rules contained elsewhere in Sections 42 and 44.

The distances specified in Table 441-1, 441-2, 441-3, or 441-4 shall be maintained from all grounded objects and from other conductors, lines, and equipment having a potential different from that to which conductive equipment and devices are bonded in order to maintain the equipotentially energized work environment in an isolated state.

A. Training

Employees shall be trained in live work practices, which include rubber glove, hot stick, or barehand method, before being permitted to use these techniques on energized lines.

B. Equipment

1. Insulated aerial devices, ladders, and other support equipment used in live work shall be evaluated for performance at the voltages involved. Tests shall be conducted to ensure the

equipment's integrity. Insulated aerial devices used in barehand work shall be tested before the work is started to ensure the integrity of the insulation. See applicable references in Section 3, specifically IEEE Std 516-2003 and ANSI/SIA A92.2-1992.

2. Insulated aerial devices and other equipment used in this work shall be maintained in a clean condition.
 3. Tools and equipment shall not be used in a manner that will reduce the overall insulating strength of the insulated aerial device.
- C. When working on insulators under live-line procedures, the clear insulation distance shall be not less than the distances required by Tables 441-1, 441-2, 441-3, and 441-4.
- D. Bonding and shielding for barehand method
1. A conductive bucket liner or other suitable conducting device shall be provided for bonding the insulated aerial device to the energized line or equipment.
 2. The employee shall be bonded to the insulated aerial device by use of conducting shoes, leg clips, or other suitable means.
 3. Adequate electrostatic shielding in the form of protective clothing that has been evaluated for electrical performance shall be provided and used where necessary.
NOTE: Electrostatic shielding—Evaluation of protective clothing designed for this purpose is covered in IEEE Std 516-2003.
 4. Before the employee contacts the energized part to be worked on, the aerial device shall be bonded to the energized conductor by means of a positive connection.

447. Protection against arcing and other damage while installing and maintaining insulators and conductors

In installing and maintaining insulators and conductors, precautions shall be taken to limit the opportunity for, as far as is practical, any damage that might render the conductors or insulators liable to fall. Precautions shall also be taken to prevent, as far as is practical, any arc from forming and to prevent any arc that might be formed from injuring or burning any parts of the supporting structures, insulators, or conductors.

Appendix A

(This Appendix is not part of Accredited Standards Committee C2, National Electrical Safety Code, 2007 Edition, and is included for information only.)

Uniform system of clearances adopted in the 1990 Edition

Reference: Rules 232, 233, and 234

Introduction

The uniform clearance system reflects the dimensions of expected activities in each area (reference component), as well as the relative potential problem caused by each type of facility (mechanical and electrical component).

Conductor clearances are stated in terms of the "closest approach," i.e., the clear distance that must be maintained under specified conditions.

- Vertical clearances are required during maximum sag conditions; they provide for expected activity beneath a line.
- Horizontal clearances are required when the conductor is at rest; they provide for expected activity alongside a line. In addition, displacement of conductors by wind is considered under certain conditions.

Under this system, users consider the actual characteristics of the materials and construction, rather than the reference characteristics built into the early Code requirements.

Three components are considered to determine the total clearance required:

- A *reference component* to cover activity in the area to be cleared by the overhead supply and/or communication lines. For example, truck height for over-the-road transport is limited to 4.3 m (14 ft) by state regulation. Thus the reference component for roads in Table 232-3 is 4.3 m (14 ft). Reference components included in the required clearances are shown in Table A-2.
- A *mechanical component* appropriate for the supply or communication line item. The mechanical component for neutral conductors meeting Rule 230E2 and open supply conductors is 610 mm (2 ft) (Table A-1).
- An *electrical component* appropriate for the voltage involved. The electrical component for open supply conductors, over 750 V to 22 kV, is 760 mm (2.5 ft) (Table A-1).

The required clearance is the sum of the three components: thus, 5.6 m (18.5 ft) is required for open supply conductors, over 750 V to 22 kV, over roads (Table 232-1). For purposes of illustration, the mechanical and electrical components are combined in Table A-1, and items with the same total mechanical and electrical components are grouped into similar clearance categories. Six groups are thus created.

Table A-1

Group	Category	M&E (mm/ m)	R/NR (ft)	GI/O (ft)	M (ft)	E (ft)	M&E (ft)
I	Support arms	305 mm	1.0/—	0.0/—	1.0	0.0	1.0
	Effectively grounded equipment cases		1.0/—	0.0/—	1.0	0.0	
II	Insulated communication conductors and cables	455 mm	—/1.5	0.0/—	1.5	0.0	1.5
	Messengers		—/1.5	0.0/—	1.5	0.0	
	Surge protection wires		—/1.5	0.0/—	1.5	0.0	
	Grounded guys		—/1.5	0.0/—	1.5	0.0	
	230E1		—/1.5	0.0/—	1.5	0.0	
	230C1		—/1.5	0.0/—	1.5	0.0	
	III	URLP, 0 V to 750 V	610 mm	1.0/—	—/0.5	1.5	0.5
	Noninsulated communication conductors		—/1.5	—/0.5	2.0	0.0	
	230C2, 0 V to 750 V		—/1.5	0.0/—	1.5	0.5	
	230C3, 0 V to 750 V		—/1.5	0.0/—	1.5	0.5	
	Ungrounded cases of equipment at 0 to 750 V		1.0/—	—/0.5	1.5	0.5	
IV	230C2, greater than 750 V	760 mm	—/1.5	0.0/—	1.5	1.0*	2.5
	230C3, greater than 750 V		—/1.5	0.0/—	1.5	1.0*	
	Open supply conductors, 0 to 750 V [ⓐ]		—/1.5	0.0/—	2.0	0.5*	
	230E2		—/1.5	0.0/—	2.0	0.5*	
V	URLP, greater than 750 V to 22 kV	1.2 m	1.0/—	—/0.5	1.5	2.5	4.0
	Ungrounded cases of equipment at greater than 750 V to 22 kV		1.0/—	—/0.5	1.5	2.5	
VI	Open supply conductors, greater than 750 V to 22 kV	1.37 m	—/1.5	—/0.5	2.0	2.5	4.5

[ⓐ]Does not include neutral conductors meeting Rule 230E1.

LEGEND

- URLP — Unguarded rigid live parts
- R — Rigid = 305 mm (1.0 ft)
- NR — Nonrigid = 155 mm (1.5 ft)
- GI — Grounded or insulated = 0.0 m (0.0 ft)
- O — Bare, ungrounded, or open conductor or part = 152 mm (0.5 ft)
- M — Mechanical component = R/NR plus GI/O
- E — Electrical component
 - (a) Grounded & communication conductor = 0.0 m (0.0 ft)
 - (b)

0 V to 750 V = 152 mm (0.5 ft)

(c) Supply line greater than 750 V to 22 kV = 760 mm (2.5 ft)

M&E — Sum of M and E values

NOTES:

1. Ungrounded guys and ungrounded portions of guys between guy insulators have clearances based on the highest voltage to which they are exposed.
2. An asterisk (*) beside a value indicates an exception to the legend.

iii

Table A-2a—Reference components of Rule 232

	Table 232-1		Table 232-2	
	Item	Ref (m)	Item	Ref (m)
Where wires, conductors, or cables cross over or overhang				
Track rails	1	6.7	—	—
Roads, streets, and other areas subject to truck traffic	2	4.3	1a	4.3
Driveways, parking lots, and alleys	3	4.3	1b	4.3
Other land traversed by vehicles	4	4.3	1c	4.3
Spaces and ways—pedestrians/restricted traffic	5	2.45/3.0	1d	3.0
Water areas—no sailboating	6	3.8	—	—
Water areas—sailboating	7		—	
(a) Less than 0.08 km ²		4.9		—
(b) Over 0.08 to 0.8 km ²		7.3		—
(c) Over 0.8 to 8 km ²		9.0		—
(d) Over 8 km ²		11.0		—
Areas posted for rigging or launching sailboats	8	See 7	—	

m

Table A-2a—Reference components of Rule 232 (continued)

	Table 232-1		Table 232-2	
	Item	Ref (m)	Item	Ref (m)
Where wires, conductors, or cables run along and within the limits of highways or other road rights-of-way, but do not overhang the roadway				
Roads, streets, or alleys	9	4.3	2a	4.3
Areas where vehicles unlikely	10	3.65	2b	3.65

ft

Table A-2a—Reference components of Rule 232

	Table 232-1		Table 232-2	
	Item	Ref (ft)	Item	Ref (ft)
Where wires, conductors, or cables cross over or overhang				
Track rails	1	22.0	—	—
Roads, streets, and other areas subject to truck traffic	2	14.0	1a	14.0
Driveways, parking lots, and alleys	3	14.0	1b	14.0
Other land traversed by vehicles	4	14.0	1c	14.0
Spaces and ways—pedestrians/restricted traffic	5	8.0/10.0	1d	10.0
Water areas—no sailboating	6	12.5	—	—
Water areas—sailboating	7		—	—
(a) Less than 20 acres		16.0		—
(b) Over 20 to 200 acres		24.0		—
(c) Over 200 to 2000 acres		30.0		—
(d) Over 2000 acres		36.0		—
Areas posted for rigging or launching sailboats	8	See 7	—	—
Where wires, conductors, or cables run along and within the limits of highways or other road rights-of-way, but do not overhang the roadway				
Roads, streets, or alleys	9	14.0	2a	14.0
Areas where vehicles unlikely	10	12.0	2b	12.0

Table A-2b—Reference components of Rule 234

Table	Item	Ref (mm/m)	Ref (ft)
234-1	1. Buildings		
	a. Horizontal		
	(1) Walls, projections, and guarded windows	915 mm	3.0
	(2) Unguarded windows	915 mm	3.0
	(3) Balconies and areas accessible to pedestrians	915 mm	3.0
	b. Vertical		
	(1) Roofs/projections not accessible to pedestrians	2.44 m	8.0
	(2) Balconies and roofs accessible to pedestrians	2.74 m	9.0
	(3) Roofs—vehicles not over 2.4 m (8 ft)	2.74 m	9.0
	(4) Roofs—vehicles over 2.4 m (8 ft)	4.3 m	14.0
	2. Signs, chimneys, billboards, antennas, tanks, etc.		
	a. Horizontal	915 mm	3.0
	b. Vertical over or under	1.07 m	3.5
234-2	1. Over bridges		
	a. Attached	305 mm	1.0
	b. Not attached	2.44 m	8.0
	2. Beside, under, or within bridge structure		
	a. Accessible		
	(1) Attached	305 mm	1.0
	(2) Not attached	915 mm	3.0
	b. Inaccessible		
(1) Attached	305 mm	1.0	
(2) Not attached	610 mm	2.0	
234-3	1. From water level, edge of pool, etc.	6.25 m	20.5
	2. From diving platform or tower	3.8 m	12.5

Vertical clearances now apply at the maximum conductor sag condition, such as outlined in Rule 232A, rather than at a 15 °C (60 °F) conductor temperature condition as used in the 1987 Edition. This is illustrated in Figure A-1: 5.6 m (18.5 ft) is required for open supply conductors, over 750 V to 22 kV, over roads, for any sag condition or span length.

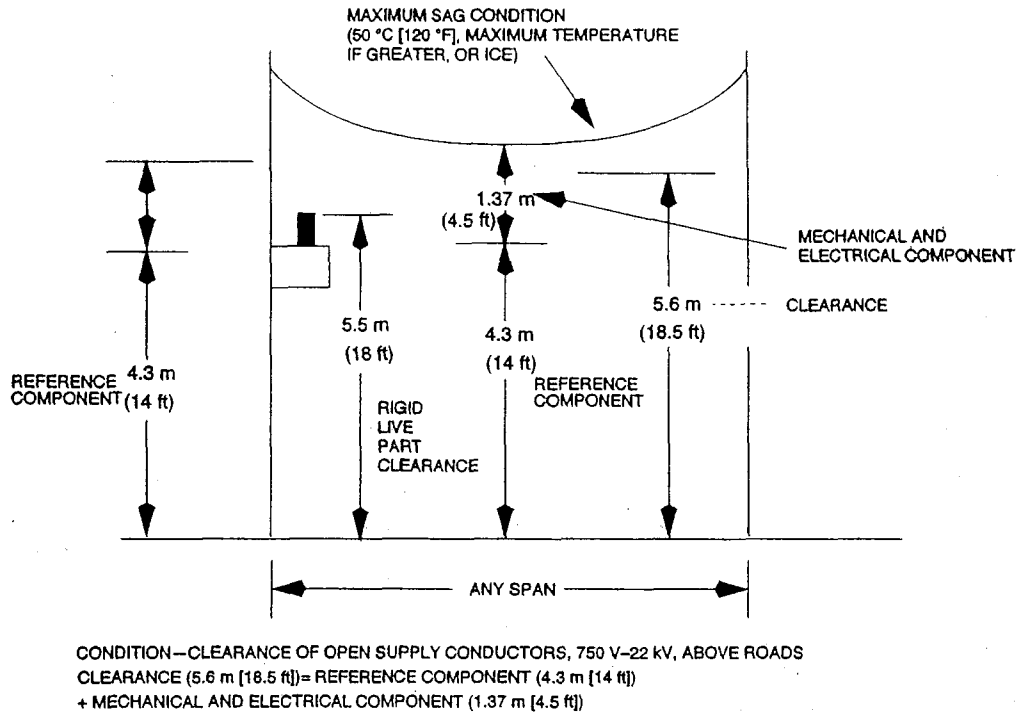

Figure A-1—Clearance at maximum sag

Horizontal clearances to buildings and other installations now apply with the conductor at rest (no wind displacement) as outlined in Rule 234A.

Wind displacement need be considered only for energized open supply conductors and 230C2–230C3 cables energized at more than 750 V; see Rule 234C1.

Because application rules were revised in 1990, *it must be understood that clearance values cannot be directly compared between the 1987 and later editions.*

The following changes were also made to consolidate requirements and simplify application:

- Voltages in the tables are limited to 0 V to 750 V and over 750 V to 22 kV, normal secondary and primary distribution ranges respectively. Voltages in the 22 kV to 50 kV range are covered by a 10 mm-per-kV (0.4-in-per-kV) adder; see Rules 232C1a, 232C2a, and 234G1. Exceptions at 22 kV to 50 kV are noted where they apply.
- Rules for voltages above 22 kV and the alternate clearances for voltages above 98 kV are consolidated.
- Clearances for equipment cases are relocated from Rules 286E and 286F to Rules 232B3 and 234J.

Appendix B

(This Appendix is not part of Accredited Standards Committee C2, National Electrical Safety Code, 2007 Edition, and is included for information only.)

Uniform clearance calculations for conductors under ice and wind conditions adopted in the 2007 Edition

Rules 230, 232A, 233A1a(3), 234A1, 235C2b(1)(c), Definitions

Considerable activity over a period of several years took place preparing Change Proposals for the 2007 Code Edition. These proposals reflect subcommittee response to proposed changes in strength and loading rules, and are in preparation for further potential changes.

A major issue addressed was that of the greater conductor sag that will result from the increased radial ice thickness shown on the new ice map (Figure 250-3) in Section 25. These increases have made it necessary to reevaluate the impact such sags would have by effectively reducing overhead clearances. Furthermore it appears that the revised map(s) may become the only source of icing information in the future and may be updated periodically. Ice and wind maps as published by the American Society of Civil Engineers are important sources of meteorological information especially prepared for structural design.

A study using a spread of commonly used power cables revealed that in many areas very significant sag increases would result from increased ice, as compared to those values shown in Table 250-1. To respond to this challenge a working group comprised of members from Subcommittees 4 and 5 was formed to devise viable solutions. Few constraints were placed on their work except that the *level of safety currently in effect must not be compromised*.

Working Group activities

Several approaches were suggested as possible mitigating solutions. Each had merit and essentially achieved a reduction in sag by rationalizing a lesser thickness than was called for in the revised ice map. One such method lowered the storm return period from the established base line of 50 years (2% probability in a given year) to 12 or 15 years (8-1/3% to 6-2/3% probability in a given year). The method had merit, was carefully evaluated, but had some apparent disadvantages.

A more simple and direct approach which received universal Working Group acceptance, recognized that the new ice map is used exclusively for *calculating ice and wind loads as related to strength and loading*. Alternatively, when calculating sag for *clearance purposes*, a separate and different ice/wind map appearing in Section 23 would be employed, which is equivalent to the present Figure 250-1.

The loading district terminology heavy, medium, and light has been replaced by clearance zones 1, 2, and 3, respectively. This eliminates the potential for confusion between the ice/wind requirements to be applied in both Sections 23 and 25, if Section 25 changes in the future. Section 23 will contain all clearance rules, as is appropriate, and will apply sags that are *derived* from radial ice thickness requirements in the 2002 Edition. The credibility of these clearances was established many years ago since they are based upon a safety record of some 70 years of success.

Calculating clearance 2007 Edition

The following is a brief description of the methodology for calculating clearance related sags:

- Rule 230B1. Clearance zones have replaced “loading districts” for classifying areas where combined ice and wind effects on conductors are essentially equivalent. Clearance zones 1, and 2, and 3 are equivalent to heavy, medium, and light loading districts in the 2002 Edition. These zones are shown in new Figure 230-1. The boundaries for this map are unchanged from previous editions of Rule 250.
- Table 230-1 and 230-2. These tables show in tabular form the radial ice thickness, wind pressure, temperatures, and additive constants used to calculate clearance sags. Long term creep determination requires additional information that is not provided in the code and may or may not be a factor in a given design. The specified radial ice, wind pressures, temperatures, and additive constants in the three zones are the same as those in Rule 250 of the 2002 Edition.
- Sag definitions. These have been slightly modified for reasons discussed under *conductor creep* in this Appendix.
- Rules 232A3, 233A1a(3), 234A1, and 235C2b(1)(c). Appropriate additions of, and deletions to, these rules were necessary in order to account for the move of clearance related calculations from Section 25 to Section 23 in the 2007 Edition.
- Rule 230B3. This rule is the equivalent of Rule 251A of the 2007 Edition.
- Rule 230B4. This rule is the equivalent of Rule 251B of the 2002 Edition.

Conductor creep

Creep is a complex physical property of most structural metals and relates to strain hardening and boundary movement at the molecular level. It is important in the design of many transmission lines, as well as in some distribution designs. It is mentioned in the 2002 and previous editions. Unfortunately, it is not always well understood, especially the difference between *initial stretch* and *creep*, the latter being a function of both temperature and time. Both, however, are forms of *inelastic deformation*, but occur over very different time periods.

All conductors and support messengers experience initial stretch immediately upon loading. Upon removal of the load, the conductor will return to an unloaded position that is displaced from the initial position. Repeated loading to higher magnitudes progressively shifts the elastic line, and the linear relationship between load and strain thereafter acts along this line.

Creep however, varies as a function of time, but not linearly. Some conductors are provided with creep curves covering different periods of time at specified temperatures. Many engineers consider 10 years as the practical limit for creep to increase, after which time it remains fairly static.

Experience has also shown that steel is much less prone to creep as compared to aluminum or copper, and is commonly ignored for steel wires and messengers. Aluminum conductors on the other hand are highly susceptible to creep, particularly at elevated temperatures, and usually require attention during the design stage.

The unique characteristics of creep and its occasional confusion with initial stretch led the working group to strike parenthetical creep from the definitions of sag. Creep remains a factor engineers must consider in their work with the Code because it is a form of inelastic deformation. The action also removed the apparent (and probably unintentional) emphasis placed on creep, when in fact for smaller conductors it generally has less impact on clearance than does initial stretch.

Summary

The Code safety principles, and design practices, have for over seventy years successfully protected both the public and utility workers from injury and death. The *same* standards have been carefully applied while developing these revisions. Changes in the 2007 Edition with respect to clearance calculations may be characterized as follows:

- All requirements for overhead line clearances are now incorporated in Section 23.
- Calculations to meet electrical and mechanical clearance requirements remain essentially unchanged.
- Responsible subcommittees exercise complete control in their area. This will allow for potentially different treatment of conductor tension and conductor sags when applied to structural loading and to clearances in the future.
- Persons not familiar with strength concerns are not encumbered with unrelated design issues, and vice versa.
- Subcommittees 4 and 5 will be better postured to work with other standards producing organizations.
- Improved and updated weather maps and similar aids can be more readily implemented.

Appendix C

(This Appendix is not part of Accredited Standards Committee C2, National Electrical Safety Code, 2007 Edition, and is included for information only.)

Example applications for Rule 250C Tables 250-2 and 250-3

The following four examples demonstrate the use of Tables 250-2 and 250-3. The method of selecting the design parameters should not be considered the recommended method for the structures presented in these examples. The method used for determining the design values should be based on engineering judgment.

Example 1 demonstrates the basic application for determining the tower and wire wind loads. The tower wind load is uniformly distributed over the tower height (h).

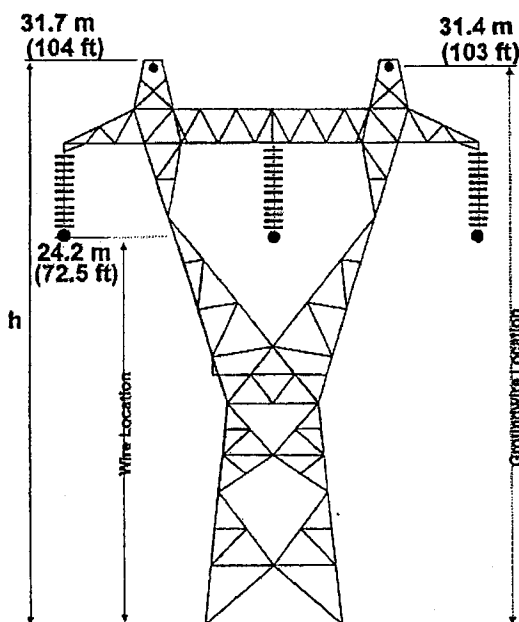

Example 1

Step 1: Determine the wind pressure for the phase conductors

Using Table 250-2, select a wire k_z value, velocity pressure exposure coefficient:

The k_z for the wire is based on the height, h , of the wire at the structure (Rule 250C1), $h = 24.2$ m (79.4 ft); therefore from Table 250-2, $k_z = 1.20$. The table k_z values represent, approximately, the upper limit for the range of heights, h . The equations of Table 250-2 can be used to determine the exact value of k_z .

$$k_z = 2.01 \cdot (24.2 \text{ m}/275 \text{ m})^{(2/9.5)} = 1.205$$

$$k_z = 2.01 \cdot (79.4 \text{ ft}/900 \text{ ft})^{(2/9.5)} = 1.205$$

Using Table 250-3, select a wire G_{RF} value, gust response factor:

The wire gust response factor, G_{RF} , is determined using the height of the wire at the structure, $h = 24.2$ m (79.4 ft), and the design wind span, L . The design span for this example is assumed to be 400 m (1310 ft). Using Table 250-3, the Wire G_{RF} equals 0.69. The table values represent, approximately, the upper limit of the G_{RF} value based on the upper limit for the range of heights, h , and lower limit for the range of span lengths, L . The equations of Table 250-3 can be used to determine the exact value of G_{RF} .

$$B_w = 1/(1 + 0.8 \cdot 400 \text{ m}/67) = 0.173$$

$$E_w = 0.346 \cdot (10/24.2 \text{ m})^{1/7} = 0.305$$

$$G_{RF} = [1 + (2.7 \cdot 0.305 \cdot (0.173)^{0.5})] / (1.43)^2 = 0.657$$

$$B_w = 1/(1 + 0.8 \cdot 1310 \text{ ft}/220) = 0.173$$

$$E_w = 0.346 \cdot (33/79.4 \text{ ft})^{1/7} = 0.305$$

$$G_{RF} = [1 + (2.7 \cdot 0.305 \cdot (0.173)^{0.5})] / (1.43)^2 = 0.657$$

The wire wind pressure, assuming 40 m/s (90 mph), I and C_d equal 1.0, and the table values for k_z and G_{RF} , is

$$\text{Wind pressure} = 0.613 \cdot (40 \text{ m/s})^2 \cdot 1.2 \cdot 0.69 \cdot 1.0 \cdot 1.0 = 812 \text{ newtons/m}^2$$

$$\text{Wind pressure} = 0.00256 \cdot (90 \text{ mph})^2 \cdot 1.2 \cdot 0.69 \cdot 1.0 \cdot 1.0 = 17.17 \text{ psi}$$

Step 2: Determine the wind pressure for the overhead groundwire

Using Table 250-2, select a wire k_z value, velocity pressure exposure coefficient:

The k_z for the wire is based on the height, h , of the wire at the structure (Rule 250C1), $h = 31.4$ m (103 ft); therefore from Table 250-2, $k_z = 1.30$. The equations of Table 250-2 can be used to determine the exact value of k_z .

$$k_z = 2.01 \cdot (31.4 \text{ m}/275 \text{ m})^{(2/9.5)} = 1.273$$

$$k_z = 2.01 \cdot (103 \text{ ft}/900 \text{ ft})^{(2/9.5)} = 1.273$$

Using Table 250-3, select a wire G_{RF} value, gust response factor:

The wire gust response factor, G_{RF} , is determined using the height of the wire at the structure, $h = 31.4$ m (103 ft), and the design wind span, $L = 400$ m (1310 ft). Using Table 250-3, the overhead groundwire G_{RF} equals 0.68. The equations of Table 250-3 can be used to determine the exact value of G_{RF} .

$$B_w = 1/(1 + 0.8 \cdot 400 \text{ m}/67) = 0.173$$

$$E_w = 0.346 \cdot (10/31.4 \text{ m})^{1/7} = 0.294$$

$$G_{RF} = [1 + (2.7 \cdot 0.294 \cdot (0.173)^{0.5})] / (1.43)^2 = 0.650$$

$$B_w = 1/(1 + 0.8 \cdot 1310 \text{ ft}/220) = 0.173$$

$$E_w = 0.346 \cdot (33/103 \text{ ft})^{1/7} = 0.294$$

$$G_{RF} = [1 + (2.7 \cdot 0.294 \cdot (0.173)^{0.5})] / (1.43)^2 = 0.650$$

The overhead groundwire wind pressure, assuming 40 m/s (90 mph), I and C_d equal 1.0, and the table values for k_z and G_{RF} , is

$$\text{Wind pressure} = 0.613 \cdot (40 \text{ m/s})^2 \cdot 1.3 \cdot 0.68 \cdot 1.0 \cdot 1.0 = 867 \text{ newtons/m}^2$$

$$\text{Wind pressure} = 0.00256 \cdot (90 \text{ mph})^2 \cdot 1.3 \cdot 0.68 \cdot 1.0 \cdot 1.0 = 18.33 \text{ psi}$$

Step 3: Determine the wind pressure for the structure

Using Table 250-2, select the structure k_z value, velocity pressure exposure coefficient:

The k_z for the structure is based on the total structure height, h , above the ground line (Rule 250C1), $h = 31.7 \text{ m}$ (104 ft); therefore from Table 250-2, $k_z = 1.20$. The equations of Table 250-2 can be used to determine the exact value of k_z .

$$k_z = 2.01 \cdot (0.67 \cdot 31.7 \text{ m}/275 \text{ m})^{(2/9.5)} = 1.172$$

$$k_z = 2.01 \cdot (0.67 \cdot 104 \text{ ft}/900 \text{ ft})^{(2/9.5)} = 1.172$$

It should be noted that the structure center of wind pressure is assumed at 2/3 the structure height for the values obtained from Table 250-2. This assumption is included in the table values and the table equation E_s with the adjustment factor 0.67. This assumption is appropriate when the wind speed is assumed uniformly distributed over the structure height and the structure height is equal to or less than 75 m. Example 3 will demonstrate when the 2/3 assumption should not be used.

Using Table 250-3, select a structure G_{RF} value, gust response factor:

The structure gust response factor, G_{RF} , is determined using the total structure height, $h = 31.7 \text{ m}$ (104 ft). Using Table 250-3, the structure G_{RF} equals 0.89. The equations of Table 250-3 can be used to determine the exact value of G_{RF} .

$$B_s = 1/(1 + 0.375 \cdot 31.7 \text{ m}/67) = 0.849$$

$$E_s = 0.346 \cdot (10/[0.67 \cdot 31.7 \text{ m}])^{1/7} = 0.311$$

$$G_{RF} = [1 + (2.7 \cdot 0.311 \cdot (0.849)^{0.5})] / (1.43)^2 = 0.867$$

$$B_s = 1/(1 + 0.375 \cdot 104 \text{ ft}/220) = 0.849$$

$$E_s = 0.346 \cdot (3.3/[0.67 \cdot 104 \text{ ft}])^{1/7} = 0.311$$

$$G_{RF} = [1 + (2.7 \cdot 0.311 \cdot (0.849)^{0.5})] / (1.43)^2 = 0.867$$

The structure wind pressure (uniformly distributed), assuming 40 m/s (90 mph), I and C_d equal 1.0, and the table values for k_z and G_{RF} , is

$$\text{Wind pressure} = 0.613 \cdot (40 \text{ m/s})^2 \cdot 1.20 \cdot 0.89 \cdot 1.0 \cdot 1.0 = 1047 \text{ newtons/m}^2$$

$$\text{Wind pressure} = 0.00256 \cdot (90 \text{ mph})^2 \cdot 1.2 \cdot 0.89 \cdot 1.0 \cdot 1.0 = 22.15 \text{ psi}$$

Example 2 demonstrates the engineer's judgment that the center of wind pressure for a Delta wire configuration is at the mid-height of the wire configuration.

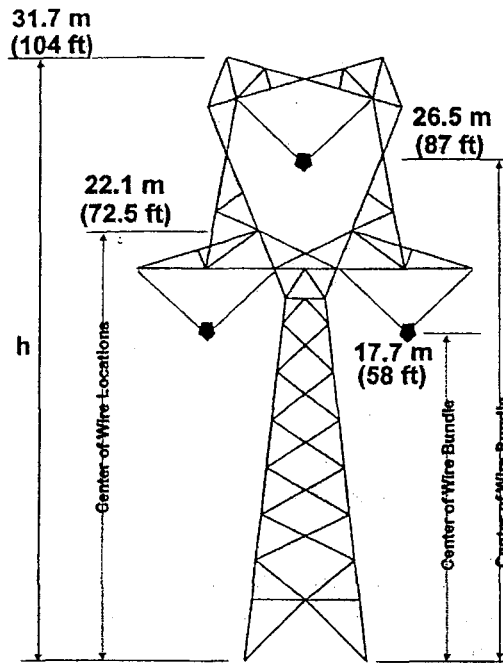

Example 2

Determine the wind pressure for the phase conductors.

Using Table 250-2, select a wire k_z value, velocity pressure exposure coefficient:

The k_z for the wire is based on the height, h , of the center of the wire locations, $h = 22.1$ m (72.5 ft); therefore from Table 250-2, $k_z = 1.20$. The equations of Table 250-2 can be used to determine the exact value k_z .

$$k_z = 2.01 \cdot (22.1 \text{ m}/275 \text{ m})^{(2/9.5)} = 1.182$$

$$k_z = 2.01 \cdot (72.5 \text{ ft}/900 \text{ ft})^{(2/9.5)} = 1.182$$

Using Table 250-3, select a wire G_{RF} value, gust response factor:

The wire gust response factor, G_{RF} , is determined using the height of the wire at the center of the wire Delta configuration, $h = 22.1$ m (72.5 ft), and the design wind span, L . The design wind span for this example is assumed to be 275 m (900 ft). Using the table, the wire G_{RF} equals 0.71. The equations of Table 250-3 can be used to determine the exact value of G_{RF} .

$B_w = 1/(1 + 0.8 \cdot 275 \text{ m}/67) = 0.233$ $E_w = 0.346 \cdot (10/22.1 \text{ m})^{1/7} = 0.309$ $G_{RF} = [1 + (2.7 \cdot 0.309 \cdot (0.233)^{0.5})]/(1.43)^2 = 0.686$
$B_w = 1/(1 + 0.8 \cdot 900 \text{ ft}/220) = 0.233$ $E_w = 0.346 \cdot (10/22.1 \text{ m})^{1/7} = 0.309$ $G_{RF} = [1 + (2.7 \cdot 0.309 \cdot (0.233)^{0.5})]/(1.43)^2 = 0.686$

The wire wind pressure, assuming 38 m/s (85 mph), I and C_d equal 1.0, and the table values for k_z and G_{RF} , is

$\text{Wind pressure} = 0.613 \cdot (38 \text{ m/s})^2 \cdot 1.2 \cdot 0.71 \cdot 1.0 \cdot 1.0 = 754 \text{ newtons/m}^2$
$\text{Wind pressure} = 0.00256 \cdot (85 \text{ mph})^3 \cdot 1.2 \cdot 0.71 \cdot 1.0 \cdot 1.0 = 15.76 \text{ psf}$

Example 3 demonstrates the application of a non-uniform wind load distribution for structures taller than 250 m. This procedure may also be used on structures less than 250 m when in the engineer's judgment a detailed wind load distribution is desired.

Step 1: Determine assumed wind load distribution

This structure is assumed to have 4 different wind sections (WS) each with its specific uniform wind load. Wind Section #1 (WS#1) was determined by engineering judgment to be the height, h , from the ground line to the top of the tapered leg, $h = 69.5 \text{ m}$ (228 ft). The center of wind pressure for WS#1 is assumed to be 2/3 the height of 69.5 m (228 ft). WS#2 is assumed to be the distance between the top of the tapered leg to the bottom of the middle crossarm. The center of wind pressure for WS#2 is assumed to be at the mid-height of this wind section, $h = 75.8 \text{ m}$ (248 ft). Similar assumptions are made for WS#3, $h = 88.3 \text{ m}$ (290 ft), and WS#4, $h = 100.3 \text{ m}$ (329 ft).

Step 2: Determine the wind load for each structure wind section

For WS#1, determine the uniformly distributed wind load.

Determine k_z , $h = 69.5 \text{ m}$ (228 ft), using Table 250-2, $k_z = 1.40$, using the equations:

$k_z = 2.01 \cdot (0.67 \cdot 69.5 \text{ m}/275 \text{ m})^{(2/9.5)} = 1.383$
$k_z = 2.01 \cdot (0.67 \cdot 228 \text{ ft}/900 \text{ ft})^{(2/9.5)} = 1.383$

Determine G_{RF} . The structure gust response factor is a function of the structures dynamic response. Therefore a single value of G_{RF} using the total structure height should be used on all structure wind sections. Given $h = 106.1 \text{ m}$ (348 ft), using the equations:

$$B_s = 1 / (1 + 0.375 \cdot 106.1 \text{ m} / 67) = 0.627$$

$$E_s = 0.346 \cdot (10 / [0.67 \cdot 106.1 \text{ m}])^{1/7} = 0.261$$

$$G_{RF} = [1 + (2.7 \cdot 0.261 \cdot (0.627)^{0.5})] / (1.43)^2 = 0.762$$

$$B_s = 1 / (1 + 0.375 \cdot 348 \text{ ft} / 220) = 0.627$$

$$E_s = 0.346 \cdot (33 / [0.67 \cdot 348 \text{ ft}])^{1/7} = 0.261$$

$$G_{RF} = [1 + (2.7 \cdot 0.261 \cdot (0.627)^{0.5})] / (1.43)^2 = 0.762$$

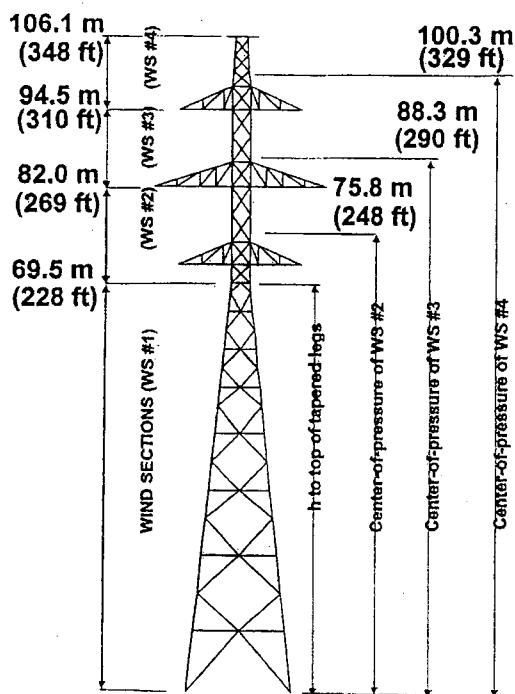

Example 3

The structure wind pressure (uniformly distributed over WS#1) assuming 40 m/s (90 mph), I and C_d equal 1.0:

$$\text{Wind pressure} = 0.613 \cdot (40 \text{ m/s})^2 \cdot 1.40 \cdot 0.762 \cdot 1.0 \cdot 1.0 = 1046 \text{ newtons/m}^2$$

$$\text{Wind pressure} = 0.00256 \cdot (90 \text{ mph})^2 \cdot 1.40 \cdot 0.762 \cdot 1.0 \cdot 1.0 = 22.12 \text{ psf}$$

For WS#2, determine the uniformly distributed wind load.

Determine k_z, h = 75.8 m (248 ft), using the equations:

$$k_z = 2.01 \cdot (75.8 \text{ m}/275 \text{ m})^{(2/9.5)} = 1.53$$

$$k_z = 2.01 \cdot (248 \text{ ft}/900 \text{ ft})^{(2/9.5)} = 1.53$$

$G_{RF} = 0.762$ for the overall structure, thus the structure wind pressure (uniformly distributed over WS#2) assuming 40 m/s (90 mph), I and C_d equal 1.0:

$$\text{Wind pressure} = 0.613 \cdot (40 \text{ m/s})^2 \cdot 1.53 \cdot 0.762 \cdot 1.0 \cdot 1.0 = 1143 \text{ newtons/m}^2$$

$$\text{Wind pressure} = 0.00256 \cdot (90 \text{ mph})^2 \cdot 1.53 \cdot 0.762 \cdot 1.0 \cdot 1.0 = 24.18 \text{ psf}$$

For WS#3, determine the uniformly distributed wind load.

Determine k_z , $h = 88.3 \text{ m}$ (290 ft), using the equations:

$$k_z = 2.01 \cdot (88.3 \text{ m}/275 \text{ m})^{(2/9.5)} = 1.58$$

$$k_z = 2.01 \cdot (290 \text{ ft}/900 \text{ ft})^{(2/9.5)} = 1.58$$

$G_{RF} = 0.762$. The structure wind pressure (uniformly distributed over WS#3) assuming 40 m/s (90 mph), I and C_d equal 1.0:

$$\text{Wind pressure} = 0.613 \cdot (40 \text{ m/s})^2 \cdot 1.58 \cdot 0.762 \cdot 1.0 \cdot 1.0 = 1181 \text{ newtons/m}^2$$

$$\text{Wind pressure} = 0.00256 \cdot (90 \text{ mph})^2 \cdot 1.58 \cdot 0.762 \cdot 1.0 \cdot 1.0 = 24.97 \text{ psf}$$

For WS#4, determine the uniformly distributed wind load. Determine k_z , $h = 100.3 \text{ m}$ (329 ft), using the equations:

$$k_z = 2.01 \cdot (100.3 \text{ m}/275 \text{ m})^{(2/9.5)} = 1.63$$

$$k_z = 2.01 \cdot (329 \text{ ft}/900 \text{ ft})^{(2/9.5)} = 1.63$$

$G_{RF} = 0.762$. The structure wind pressure (uniformly distributed over WS#4) assuming 40 m/s (90 mph), I and C_d equal 1.0:

$$\text{Wind pressure} = 0.613 \cdot (40 \text{ m/s})^2 \cdot 1.63 \cdot 0.762 \cdot 1.0 \cdot 1.0 = 1218 \text{ newtons/m}^2$$

$$\text{Wind pressure} = 0.00256 \cdot (90 \text{ mph})^2 \cdot 1.63 \cdot 0.762 \cdot 1.0 \cdot 1.0 = 25.75 \text{ psf}$$

Example 4 demonstrates the application of wind load on a distribution wood structure. The purpose of this example is to demonstrate the concept provided in Rule 250C. Engineering judgment should be used when selecting the wind parameters to use with Tables 250-2 and 250-3.

Step 1: Determine the wind pressure for the phase conductors

Using Table 250-2, select a wire k_z value, velocity pressure exposure coefficient:

The k_z for the wire is based on the height, h , of the center wire at the structure (Rule 250C1), $h = 16.6$ m (54.5 ft); therefore from Table 250-2, $k_z = 1.20$. The table k_z values represent, approximately, the upper limit of the range of height, h . The equations of Table 250-2 can be used to determine the exact value of k_z .

$k_z = 2.01 \cdot (16.6 \text{ m}/275 \text{ m})^{(2/9.5)} = 1.113$
$k_z = 2.01 \cdot (54.5 \text{ ft}/900 \text{ ft})^{(2/9.5)} = 1.113$

Using Table 250-3, select a wire G_{RF} value, gust response factor:

The wire gust response factor, G_{RF} , is determined using the height of the wire at the structure, $h = 16.6$ m (54.5 ft), and the design wind span, L . The design span for this example is assumed to be 152 m (500 ft). Using Table 250-3, the wire G_{RF} equals 0.75. The table wire G_{RF} values represent, approximately, the upper limit of the G_{RF} value based on the upper limit of height, h , and lower limit of span length, L . The equations of Table 250-3 can be used to determine the exact values of G_{RF} .

$B_w = 1/(1 + 0.8 \cdot 152 \text{ m}/67) = 0.355$
$E_w = 0.346 \cdot (10/16.6 \text{ m})^{1/7} = 0.322$
$G_{RF} = [1 + (2.7 \cdot 0.322 \cdot (0.355)^{0.5})] / (1.43)^2 = 0.742$
$B_w = 1/(1 + 0.8 \cdot 500 \text{ ft}/220) = 0.355$
$E_w = 0.346 \cdot (33/54.5 \text{ ft})^{1/7} = 0.322$
$G_{RF} = [1 + (2.7 \cdot 0.322 \cdot (0.355)^{0.5})] / (1.43)^2 = 0.742$

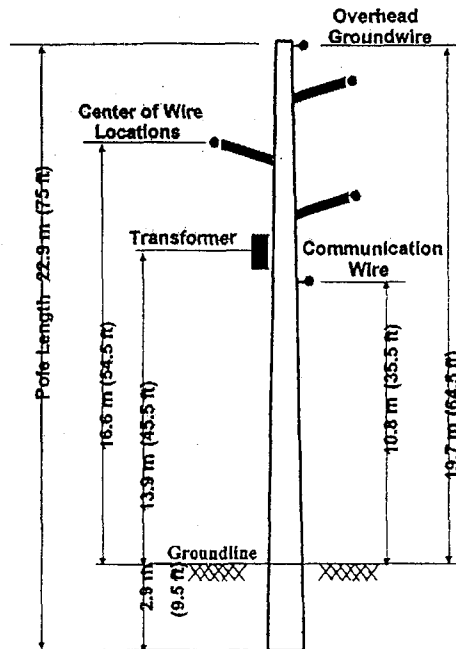

Example 4

The wire wind pressure, assuming 40 m/s (90 mph), I and C_d equal 1.0, and the table values for k_z and G_{RF} , is

$$\text{Wind pressure} = 0.613 \cdot (40 \text{ m/s})^2 \cdot 1.2 \cdot 0.75 \cdot 1.0 \cdot 1.0 = 883 \text{ newtons/m}^2$$

$$\text{Wind pressure} = 0.00256 \cdot (90 \text{ mph})^2 \cdot 1.2 \cdot 0.75 \cdot 1.0 \cdot 1.0 = 18.66 \text{ psf}$$

Step 2: Determine the wind pressure for the overhead groundwire

Using Table 250-2, select a wire k_z value, velocity pressure exposure coefficient:

The k_z for the wire is based on the height, h , of the wire at the structure (Rule 250C1), $h = 19.7 \text{ m}$ (64.5 ft); therefore from Table 250-2, $k_z = 1.20$. The equations of Table 250-2 can be used to determine the exact value of k_z .

$$k_z = 2.01 \cdot (19.7 \text{ m}/275 \text{ m})^{(2/9.5)} = 1.154$$

$$k_z = 2.01 \cdot (64.5 \text{ ft}/900 \text{ ft})^{(2/9.5)} = 1.154$$

Using Table 250-3, select a wire G_{RF} value, gust response factor:

The wire gust response factor, G_{RF} , is determined using the height of the wire at the structure, $h = 19.7 \text{ m}$ (64.5 ft), and the design wind span, $L = 152 \text{ m}$ (500 ft). Using Table 250-3, the overhead groundwire G_{RF} equals 0.75. The equations of Table 250-3 can be used to determine the exact value of G_{RF} .

$$B_w = 1/(1 + 0.8 \cdot 152 \text{ m}/67) = 0.355$$

$$E_w = 0.346 \cdot (10/19.7 \text{ m})^{1/7} = 0.314$$

$$G_{RF} = [1 + (2.7 \cdot 0.314 \cdot (0.355)^{0.5})] / (1.43)^2 = 0.736$$

$$B_w = 1/(1 + 0.8 \cdot 500 \text{ ft}/220) = 0.355$$

$$E_w = 0.346 \cdot (33/64.5 \text{ ft})^{1/7} = 0.314$$

$$G_{RF} = [1 + (2.7 \cdot 0.314 \cdot (0.355)^{0.5})] / (1.43)^2 = 0.736$$

The overhead groundwire wind pressure, assuming 40 m/s (90 mph), I and C_d equal 1.0, and the table values for k_z and G_{RF} , is

$$\text{Wind pressure} = 0.613 \cdot (40 \text{ m/s})^2 \cdot 1.2 \cdot 0.75 \cdot 1.0 \cdot 1.0 = 883 \text{ newtons/m}^2$$

$$\text{Wind pressure} = 0.00256 \cdot (90 \text{ mph})^2 \cdot 1.2 \cdot 0.75 \cdot 1.0 \cdot 1.0 = 18.66 \text{ psf}$$

Step 3: Determine the wind pressure for the structure

Using Table 250-2, select the structure k_z value, velocity pressure exposure coefficient:

The k_z for the structure is based on the total structure height, h , above the ground line (Rule 250C1), $h = 22.9 \text{ m} - 2.9 \text{ m} = 20.0 \text{ m}$ (75 ft - 9.5 ft = 65.5 ft); therefore from Table 250-2, $k_z = 1.10$. The equations of Table 250-2 can be used to determine the exact value of k_z .

$$k_z = 2.01 \cdot (0.67 \cdot 20.0 \text{ m}/275 \text{ m})^{(2/9.5)} = 1.064$$

$$k_z = 2.01 \cdot (0.67 \cdot 65.5 \text{ ft}/900 \text{ ft})^{(2/9.5)} = 1.064$$

It should be noted that the structure center of wind pressure is assumed at 2/3 the structure height for the values obtained from Table 250-2. This assumption is included in the table values and the table equation E_s with the adjustment factor 0.67. This assumption is appropriate when the wind speed is assumed uniformly distributed over the structure height and the structure height is equal to or less than 75 m. Example 3 demonstrates when the 2/3 assumption should not be used.

Using Table 250-3, select a structure G_{RF} value, gust response factor:

The structure gust response factor, GRF, is determined using the total structure height, $h = 31.7 \text{ m}$. Gust response factor, G_{RF} , is determined using the height of the wire at the structure, $h = 20.0 \text{ m}$ (65.5 ft). Using Table 250-3, the structure G_{RF} equals 0.93. The equations of Table 250-3 can be used to determine the exact values of G_{RF} .

$$B_s = 1/(1 + 0.375 \cdot 20 \text{ m}/67) = 0.899$$

$$E_s = 0.346 \cdot (10/[0.67 \cdot 20 \text{ m}])^{1/7} = 0.332$$

$$G_{RF} = [1 + (2.7 \cdot 0.332 \cdot (0.899)^{0.5})] / (1.43)^2 = 0.905$$

$$B_s = 1/(1 + 0.375 \cdot 65.5 \text{ ft}/220) = 0.899$$

$$E_s = 0.346 \cdot (10/[0.67 \cdot 65.5 \text{ ft}])^{1/7} = 0.332$$

$$G_{RF} = [1 + (2.7 \cdot 0.332 \cdot (0.899)^{0.5})] / (1.43)^2 = 0.905$$

The structure wind pressure (uniformly distributed), assuming 40 m/s (90 mph), I and C_d equal 1.0, and the table values for k_z and G_{RF} , is

$$\text{Wind pressure} = 0.613 \cdot (40 \text{ m/s})^2 \cdot 1.10 \cdot 0.93 \cdot 1.0 \cdot 1.0 = 1003 \text{ newtons/m}^2$$

$$\text{Wind pressure} = 0.00256 \cdot (90 \text{ mph})^2 \cdot 1.10 \cdot 0.93 \cdot 1.0 \cdot 1.0 = 21.2 \text{ lpsf}$$

Step 4: Determine the wind pressure for the communication wire

Using Table 250-2, select a wire k_z value, velocity pressure exposure coefficient:

The k_z for the communication wire is based on the height, h , of the communication wire on the structure (Rule 250C1), $h = 10.8 \text{ m}$ (35.5 ft); therefore from Table 250-2, $k_z = 1.10$. The equations of Table 250-2 can be used to determine the exact value of k_z .

$$k_z = 2.01 \cdot (10.8 \text{ m}/275 \text{ m})^{(2/9.5)} = 1.017$$

$$k_z = 2.01 \cdot (35.5 \text{ ft}/900 \text{ ft})^{(2/9.5)} = 1.017$$

Using Table 250-3, select a communication wire G_{RF} value, gust response factor:

The wire gust response factor, G_{RF} , is determined using the height of the communication wire at the structure, $h = 10.8 \text{ m}$ (35.5 ft), and the design wind span, $L = 152 \text{ m}$ (500 ft). Using Table 250-3, the communication wire G_{RF} equals 0.76. The equations of Table 250-3 can be used to determine the exact value of G_{RF} .

$$B_w = 1/(1 + 0.8 \cdot 152 \text{ m}/67) = 0.355$$

$$E_w = 0.346 \cdot (10/10.8 \text{ m})^{1/7} = 0.342$$

$$G_{RF} = [1 + (2.7 \cdot 0.342 \cdot (0.355)^{0.5})] / (1.43)^2 = 0.758$$

The communication wire wind pressure, assuming 40 m/s (90 mph), I and C_d equal 1.0, and the table values for k_z and G_{RF} , is

$$\text{Wind pressure} = 0.613 \cdot (40 \text{ m/s})^2 \cdot 1.1 \cdot 0.76 \cdot 1.0 \cdot 1.0 = 820 \text{ newtons/m}^2$$

Step 5: Determine the wind pressure for the transformer

Using Table 250-2, select a transformer k_z value, velocity pressure exposure coefficient:

The k_z for the transformer is based on the height, h , of the transformer on the structure (Rule 250C1), $h = 13.9 \text{ m}$ (45.5 ft); therefore from Table 250-2, $k_z = 1.10$. The equations of Table 250-2 can be used to determine the exact value of k_z .

$$k_z = 2.01 \cdot (13.9 \text{ m}/275 \text{ m})^{(2/9.5)} = 1.072$$

The transformer G_{RF} value, gust response factor, is 0.93, Rule 250C2.

The transformer wind pressure, assuming 40 m/s (90 mph), I and C_d equal 1.0, and the table values for k_z and G_{RF} , is

$$\text{Wind pressure} = 0.613 \cdot (40 \text{ m/s})^2 \cdot 1.1 \cdot 0.93 \cdot 1.0 \cdot 1.0 = 1003 \text{ newtons/m}^2$$

Appendix D

(This Appendix is not part of Accredited Standards Committee C2, National Electrical Safety Code, 2007 Edition, and is included for information only.)

Determining maximum anticipated per-unit overvoltage factor (T) at the worksite

1. The engineering analysis used to determine and identify the TOV at the worksite should include, but not be limited to, the following:

- a. Engineering analysis of the energy sources, phase angle regulators, static var compensators, reactors, and capacitors connected to the power transmission system operating at the voltage level at which the work is being done, to determine and identify the maximum anticipated temporary overvoltage (OV), which can be produced at the worksite.

If the capacitors and/or shunt reactors are fuse protected or switchable, the engineering analysis should be made with them in and out of service to determine the OV. The analysis should also evaluate the maximum effect on OV from the phase angle regulators and static var compensators throughout their operating range. Analysis should also evaluate the overvoltage, which results from closing of a circuit interrupting device on to a line or cable with trapped charges. Analysis of the circuit impedances to determine possibility of resonance conditions and the resulting OV should also be considered.

The OV at the worksite should include the fundamental 60 Hz waveform combined with the major harmonics.

Harmonic voltage should be determined by assuming simultaneous peaks for all frequencies using the limits in IEEE 519-1992 [B35].

- b. Engineering analysis of the interrupting and isolating devices used on the power transmission system, operating at that voltage, to determine and identify the maximum anticipated switching surge (switching surge or switching impulse) (SI), which they produce.
 - c. Engineering analysis of the surge reduction and protection equipment permanently connected to the power transmission system operating at that voltage to determine and identify the OV and SI levels at which they operate.
 - d. Data from digital transient recorder and similar devices may be used to determine the peak value of OV and/or SI, if it has been determined from an engineering analysis and testing that the data is true and its peaks are not limited by the equipment or equipment protection devices. Testing to determine the worst-case conditions should also be made.
2. T at the worksite is calculated by adding the peak value of OV to SI and dividing it by maximum peak voltage.

As an example, for a line operating at 235 kV with maximum anticipated OV_{peak} corresponding to 355 kV (phase-to-phase rms) and a SI of 200 kV.

$$T = (OV_{peak} + SI) / V_{P-G peak} \text{ [in kV]}$$

$$T = (((355 \cdot 1.414) / 1.732) + 200) / ((242 \cdot 1.414) / 1.732)$$

$$T = (289.82 + 200) / 197.57$$

$$T = 489.82 / 197.57 = 2.48 \text{ or } 2.5$$

Appendix E

Bibliography

[B1] ANSI A14.1-1994, American National Standard Safety Requirements for Portable Wood Ladders. [Rule 323F REC][®]

[B2] ANSI A14.2-1990, American National Standard Safety Requirements for Portable Metal Ladders [and supplement ANSI 14.2a (1985)]. [Rule 323F REC]

[B3] ANSI A14.3-1992, American National Standard Safety Requirements for Fixed Ladders. [Rule 323F REC]

[B4] ANSI A14.5-1992, American National Standard Safety Requirements for Portable Reinforced Plastic Ladders [and supplement ANSI A14.5a (1985)]. [Rule 323F REC]

[B5] ANSI A1264.1-1995, American National Safety Requirements for Workplace Floor and Wall Openings. [Rule 112D NOTE]

[B6] ANSI C2-1973, National Electrical Safety Code. [Rule 402 NOTE]

[B7] ANSI C29.8-1985 (R2002), American National Standard for Wet-Process Porcelain Insulators—Apparatus, Cap, and Pin Type.

[B8] ANSI C29.9-1983 (R2002), American National Standard for Wet-Process Porcelain Insulators—Apparatus, Post Type. [Rule 277 NOTE 2]

[B9] ANSI C29.10-1989 (R2002), American National Standard for Wet-Process Porcelain Insulators—Indoor Apparatus Type.

[B10] ANSI C29.11-1989 (R1996), American National Standard for Composite Suspension Insulators for Overhead Transmission Lines—Tests. [Rule 277 NOTE 1b]

[B11] ANSI C29.12-1997 (R2002), American National Standard for Insulators—Composite Suspension Type.

[B12] ANSI C29.13-2000, American National Standard for Insulators—Composite-Distribution Deadend Type.

[B13] ANSI C29.17-2002, American National Standard for Insulators—Composite-Line Post Type.

[B14] ANSI C29.18-2003, American National Standard for Insulators—Composite-Distribution Line Post Type.

[B15] ANSI O5.2-1996 (Reaff 2001), American National Standard for Wood Products—Structural Glued Laminated Timber for Utility Structures. [Rule 261A]

[B16] ANSI O5.3-2002, American National Standard for Solid Sawn-wood Crossarms and Braces—Specifications and Dimensions. [Rule 261A]

[®]ANSI publications are available from the Sales Department, American National Standards Institute, 25 West 43rd Street, 4th Floor, New York, NY 10036, USA (<http://www.ansi.org/>).

[B17] API RP 500, Recommended Practice for Classification of Locations for Electrical Installations at Petroleum Facilities, 7 January 1998. [Rule 127L NOTE][ⓐ]

[B18] ASTM F 478-92 (1999), Standard Specification for In-Service Care of Insulating Line Hose and Covers.[ⓑ]

[B19] ASTM F 479-95 (2001), Standard Specification for In-Service Care of Insulating Blankets.

[B20] ASTM F 496-02A/e01, Standard Specification for In-Service Care of Insulating Gloves and Sleeves.

[B21] ASTM F 696-02, Standard Specification for Leather Protectors for Rubber Insulating Gloves and Mittens.

[B22] ASTM F 711-02, Standard Specification for Fiberglass-Reinforced Plastic (FRP) Rod and Tube Used in Live Line Tools.

[B23] ASTM F 855-04, Standard Specification for Temporary Grounding Systems to Be Used on De-energized Electric Power Lines and Equipment.

[B24] ASTM F 887-05, Standard Specification for Personal Climbing Equipment.

[B25] ASTM F 914-03, Standard Test Method for Acoustic Emission for Insulated Aerial Personnel Devices.

[B26] ASTM F 968-93 (2002/e01), Standard Specification for Electrically Insulating Plastic Guard Equipment for Protection of Workers.

[B27] ASTM F 1116-03, Standard Test Method for Determining Dielectric Strength of Dielectric Footwear.

[B28] ASTM F 1236-96 (2001), Standard Guide for Visual Inspection of Electrical Protective Rubber Products.

[B29] ASTM F 1959-04, Standard Test Method for Determining the Arc Thermal Performance Value of Materials for Clothing.

[B30] FCC Bulletin No. 65 (August 1997), Evaluating Compliance with FCC Guidelines for Human Exposure to Radiofrequency Electromagnetic Fields. [Rule 420Q][ⓐ]

[B31] IEEE/ASTM SI 10TM-1997, Standard for the Use of the International System of Units (SI). [Rule 17A, Footnote 2][ⓑ] [ⓐ]

[B32] IEEE Std 80TM-2000, IEEE Guide for Safety in AC Substation Grounding. [Rule 92E, 96B NOTE, and 123B NOTE]

[ⓐ]API publications are available from the Publications Section, American Petroleum Institute, 1200 L Street NW, Washington, DC 20005, USA (<http://www.api.org/>).

[ⓑ]ASTM publications are available from the American Society for Testing and Materials, 100 Barr Harbor Drive, West Conshohocken, PA 19428-2959, USA (<http://www.astm.org/>).

[ⓐ]This publication available from <http://www.fcc.gov/eot/info/documents/bulletins/#65>.

[ⓑ]The IEEE standards or products referred to in this clause are trademarks of the Institute of Electrical and Electronics Engineers, Inc.

[ⓐ]IEEE publications are available from the Institute of Electrical and Electronics Engineers, Inc., 445 Hoes Lane, Piscataway, NJ 08854, USA (<http://standards.ieee.org/>).

- [B33] IEEE Std 268™-1992, IEEE Standard for Metric Practice (ANSI) (DoD adopted).
- [B34] IEEE Std 487™-2000, IEEE Recommended Practice for the Protection of Wireline Communication Facilities Serving Electric Supply Locations.
- [B35] IEEE Std 519™-1992, IEEE Recommended Practices and Requirements for Harmonic Control in Electrical Power Systems.
- [B36] IEEE Std 524™-1992, IEEE Guide to the Installation of Overhead Transmission Line Conductors (ANSI).
- [B37] IEEE Std 738™-1993, IEEE Standard for Calculating the Current-Temperature of Bare Overhead Conductors (ANSI).
- [B38] IEEE Std 751™-1990, IEEE Trial-Use Design Guide for Wood Transmission Structures (ANSI).
- [B39] IEEE Std 776™-1992, IEEE Recommended Practice for Inductive Coordination of Electric Supply and Communication Lines.
- [B40] IEEE Std 935™-1989 (R1995), IEEE Guide on Terminology for Tools and Equipment to Be Used in Live Line Working (ANSI).
- [B41] IEEE Std 951™-1996, IEEE Guide to the Assembly and Erection of Metal Transmission Structures (ANSI).
- [B42] IEEE Std 957™-1995, IEEE Guide for Cleaning Insulators (ANSI).
- [B43] IEEE Std 977™-1991, IEEE Guide to Installation of Foundations for Transmission Line Structures (ANSI).
- [B44] IEEE Std 978™-1984 (R1990), IEEE Guide for In-Service Maintenance and Electrical Testing of Live-Line Tools (ANSI).[Ⓢ]
- [B45] IEEE Std 987™-1985, IEEE Guide for Application of Composite Insulators (ANSI).
- [B46] IEEE Std 1024™-1988, IEEE Recommended Practice for Specifying Distribution Composite Insulators (Suspension Type) (ANSI).[Ⓢ]
- [B47] IEEE Std 1048™-1990, IEEE Guide for Protective Grounding of Power Lines (ANSI).
- [B48] IEEE Std 1067™-1996, IEEE Guide for In-Service Use, Care, Maintenance, and Testing of Conductive Clothing for Use on Voltages up to 765 kV AC (ANSI).
- [B49] IEEE Std 1070™-1988, IEEE Guide for the Design and Testing of Transmission Modular Restoration Structure Components (ANSI).
- [B50] IEEE Std 1119™-1988 (R1993), IEEE Guide for Fence Safety Clearances in Electric-Supply Stations (ANSI).

[Ⓢ]IEEE Std 987-1985 has been withdrawn; however, copies can be obtained from Global Engineering, 15 Inverness Way East, Englewood, CO 80112-5704, USA, tel. (303) 792-2181 (<http://global.ihs.com/>).

[Ⓢ]IEEE Std 1024-1988 has been withdrawn; however, copies can be obtained from the Institute of Electrical and Electronics Engineers, Inc., 445 Hoes Lane, Piscataway, NJ 08854, USA (<http://standards.ieee.org/>).

[B51] IEEE Std 1137™-1991, IEEE Guide for the Implementation of Inductive Coordination Mitigation Techniques and Applications.

[B52] IEEE Std 1307™-2004, IEEE Standard for Fall Protection for Utility Work.

[B53] IEEE Std 1333™-1994, IEEE Guide for Installation of Cable Using the Guided Boring Method.

[B54] IEEE Std 1590™-2003, IEEE Recommended Practice for the Electric Protection of Optical Fiber Communication Facilities Serving, or Connected to, Electrical Supply Locations.

[B55] IEEE Std C62.1™-1989 (R1994), IEEE Standard for Gapped Silicon-Carbide Surge Arresters for AC Power Circuits (ANSI). [Rule 190 NOTE]

[B56] IEEE Std C62.11™-1999, IEEE Standard for Metal-Oxide Surge Arresters for Alternating Current Power Circuits (ANSI). [Rule 190 NOTE]

[B57] IEEE Std C95.1™-2005, IEEE Standard for Safety Levels with Respect to Human Exposure to Radio Frequency Electromagnetic Fields, 3 kHz to 300 GHz. [Rule 420Q]

[B58] IEEE Working Group on Switching Surges, "Switching Surges, pt. IV—Control on AC Transmission Lines," *IEEE Transactions on Power Apparatus and Systems*, vol. PAS-101, No. 8, pp. 2694–2702, Aug. 1982.

[B59] Neal, T. E., Bingham, A. H., Doughty, R. L., "Protective clothing guidelines for electric arc exposure," *IEEE Transactions on Industry Applications*, vol. 33-4, pp. 1041–1054, July/Aug. 1997. [Rule 410A]

[B60] NFPA 77-1993, Recommended Practice on Static Electricity. [Rule 127D3 NOTE]®

[B61] NFPA 497M-1997, Classification of Gases, Vapors, and Dusts for Electrical Equipment in Hazardous (Classified) Locations. [Rule 127L NOTE]

[B62] OSHA 29 CFR 1926, Subpart V—Power Transmission and Distribution. [Rule 402 NOTE]®

[B63] OSHA 29 CFR 1910.97, Subpart G—Nonionizing radiation. [Rule 420Q]

[B64] OSHA 29 CFR 1910.268, Subpart R—Telecommunications. [Rule 420Q]

[B65] OSHA Federal Register [01/31/89] 54: 4974–5024—Electric Power Generation, Transmission, and Distribution; Electrical Protective Equipment; Proposed Rule (1910.269). [Rule 402 NOTE]

[B66] OSHA Federal Register [01/31/94] 59: 4320–4476—Electric Power Generation, Transmission, and Distribution; Electrical Protective Equipment (1910.269). [Rule 402 NOTE]

®NFPA publications are available from Publications Sales, National Fire Protection Association, 1 Batterymarch Park, P.O. Box 9101, Quincy, MA 02269-9101, USA (<http://www.nfpa.org>).

®OSHA publications available from <http://www.osha.gov>.



Index

Italic type is used for C2 rule, section, part, figure, or table identification. The corresponding page numbers follow in upright type.

A

- Adjustable-speed motors, *130E*; 56
- Administrative authority, definition of, *Sec. 2*; 5
- Aerial cable systems, insulation requirements, *278*; 215
- Aerial services, *239G4*; 167
- Altitude corrections (for approach distance to live parts), *431, 441A6, Table 441-5*; 259, 264, 272
- American Wire Gage (AWG), *Sec. 2*; 14
- Ampacity
 - definition of, *Sec. 2*; 5
 - grounding conductor, *93C*; 20
- Anchorage, definition of, *Sec. 2*; 5
- Anchors, *253, 261B*; 196, 202
- Annunciators, *180E*; 66
- Antennas, conductor clearance from, *234C, Table 234-1, Table 234-5, 235I*; 111, 122, 134, 142
- Apparent sag at any point in the span, definition of, *Sec. 2*; 11
- Apparent sag of a span, definition of, *Sec. 2*; 11
- Application of National Electrical Safety Code, *13*; 1
- Approach distance
 - live parts, *441A*; 262
 - minimum, definition of, *Sec. 2*; 9
- Arcing, *420F, 447*; 253, 279
- Armless construction, *243C, 261G*; 176, 204
- Augers (grain bins), clearance considerations, *234F, Fig 234-4*; 114, 120
- Automatic overspeed trip device for prime movers, *130A*; 56
- Automatic, definition of, *Sec. 2*; 5
- AWG (American Wire Gauge), *Sec. 2*; 14

B

- B grade construction. *See* Grades of construction
- Backfill, *321B*; 224
 - definition of, *Sec. 2*; 5
- Ballast section (railroads), definition of, *Sec. 2*; 5
- Basic Impulse Insulation Level (BIL), *Table 124-1*; 43
- Batteries. *See* Storage batteries
- Beaches, conductor clearance from, *234E2*; 114
- Belt (line-worker's body), *Sec. 2, 420K*; 7, 254
- BIL (Basic Impulse Insulation Level), *Table 124-1*; 43
- Billboards, conductor clearance from, *234C, Table 234-1*; 111, 122
- Birmingham Wire Gage, *Sec. 2*; 14
- Boilers, *127F, 180E1*; 54, 66
- Bonding, definition of, *Sec. 2*; 5
- Bonding jumpers, buried, *92E, 93E6*; 19, 22
- Boring, *352C*; 236
- Braces for line supports, *261D*; 202
- Breaker, circuit. *See* Circuit breakers
- Bridges
 - clearance from, *234*; 109
 - conduit location, *320A4*; 223
 - trolley guards under, *225E*; 80

- Brown & Sharpe (B&S)**, *Sec. 2*; 14
- Buckarm construction**, 236F, 237D, *Fig 237-1*; 159, 162, 163
- Buildings, clearance from**, 234, *Fig 234-1, Table 234-1, Table 234-4*; 109, 117, 122, 133
buried under cable, 351C2; 235
- Bundled conductor**, definition of, *Sec. 2*; 6
- Buried lines**. *See* Underground communication lines; Underground electric supply lines
- Burner safety devices**, 180E; 66
- Bus, metal-enclosed**, 181; 66
isolated-phase, 181B; 67
- C**
- C grade construction**. *See* Grades of construction
- Cable jacket**, definition of, *Sec. 2*; 5
- Cable sheath**, definition of, *Sec. 2*; 5
- Cable terminal**, definition of, *Sec. 2*; 5
- Cables**
aerial, insulation requirements, 278; 215
fiber-optic—communication
clearances, 230F; 83
definition of, *Sec. 2*; 7
fiber-optic—supply
clearances, 230F; 83
definition of, *Sec. 2*; 7
fireproofing, definition of, *Sec. 2*; 8
insulation, definition of, *Sec. 2*; 8
supply, 230C, 241A; 83, 171
- Cables, communication**, 261K; 205
- Cables**, definition of, *Sec. 2*; 5
- Cables, spacer**, definition of, *Sec. 2*; 12
- Capacitors**, 443I; 275
- Chimneys, conductor clearance from**, 234C, *Table 234-1, Table 234-5*; 111, 122, 134
- Circuit**
definition of, *Sec. 2*; 5
voltage in, definitions of, *Sec. 2*; 13
- Circuit breakers**
application, 171; 63
arrangement, 170; 63
capacity, 173A; 63
definition of, *Sec. 2*; 5
oil containing, 172; 63
provisions for disconnecting, 173B; 63
- Classified locations, electrical installations in**
boilers, 127F, 180E1; 54, 66
coal-handling areas, 127A; 53
flammable and combustible liquids, 127B; 53
loading and unloading facilities, 127D; 54
storage areas, 127C; 54
gaseous hydrogen systems for supply equipment, 127G; 54
gasoline-dispensing stations, 127E; 54
liquefied petroleum gas (LPG), 127K; 55
liquid hydrogen systems, 127H; 54
loading and unloading facilities, 127D; 54
natural gas (methane), 127L; 55
sulfur, 127I; 55
- Clearance**. *See* Overhead communication lines, clearances; Overhead electric supply lines, clearances
- Climbable, readily**, definition of, *Sec. 2*; 12
- Climber, qualified**, *Sec. 2, 420K2*; 10, 253
- Climbing space**, 230A; 81
buckarm construction on, 236F; 159
conductors bounding, 236E, *Table 236-1*; 159, 161
dimensions, 236A; 158
equipment location in relation to, 236D; 158
inhibiting climbing of supporting structures, 217A2; 73
lateral conductors, past, 239B; 165
location, 236A; 158
longitudinal runs not on support arms, past, 236G; 159
portions of supporting structures in, 236B; 158
ridge-pin conductors, near, 236I; 160
steps and standoff brackets for supporting structures, 217A2; 73
support arm location relative to, 236C; 158
vertical conductors, past, 236H, 239B; 160, 165
- Climbing**, definition of, *Sec. 2*; 5
- Clothing, protective**, 420I; 253
- Coal-handling areas**, 127A; 53

- Combustible liquids, 127B; 53**
 loading and unloading facilities, 127D; 54
 storage areas, 127C; 54
- Common use, definition of, Sec. 2; 5**
- Communication lines. See Lines, communication**
- Communication worker safety zone, 235C4, 238E; 139, 163**
- Computers, 180E1; 66**
- Concentric neutral cable as grounding electrode, 94B5; 24**
- Concrete structures. See Prestressed-concrete structures; Reinforced concrete structures**
- Concrete-encased electrodes as ground electrodes, 94B6, 95A; 25**
- Conductors, Sec. 16; 62**
 application, 160; 62
 bundled, definition of, Sec. 2; 6
 clearance envelope, 233A2, Fig 233-1, Fig 233-3; 99, 101, 104
 climbing space bounding, 236E; 159
 Communication. *See also* Lines, communication
 open-wire, 261J; 205
 communication. *See also* Lines, communication
 paired, 261L; 206
 constant-current, 242A; 172
 covered, Sec. 2, 230D; 6, 83
 definition of, Sec. 2; 6
 electrical protection, 161; 62
 grounded, 161B; 62
 insulated power cables, 161C; 62
 overcurrent protection required, 161A; 62
 fastenings, 243C, 252, 261F; 176, 194, 204
 fiber-optic, definition of, Sec. 2; 6
 fire-alarm circuits, 242D; 172
 grades of construction
 communication conductors, 242C, Table 242-1, Table 242-2; 172, 173, 175
 constant-current circuit conductors, 242A; 172
 neutral conductors of supply circuits, 242E; 172
 railway feeder conductors, 242B; 172
 supply, 241A, Table 242-1; 171, 173
 surge-protection wires, 242F; 172
 trolley-contact circuit conductors, 242B; 172
- grounded, 161B; 62
 definition of, Sec. 2; 8
 grounding. *See* Grounding, conductors
 installing, 447; 279
 insulated, 161C; 62
 definition of, Sec. 2; 8
 isolation, 163; 62
 lateral, definition of, Sec. 2; 6
 line. *See* Overhead communication lines; Overhead electric supply lines
 loading, 251; 193
 maintaining, 447; 279
 mechanical protection and support, 162; 62
 movement envelope, 233A1, Fig 233-1, Fig 233-2; 98, 101, 102
 neutral, Sec. 2, 230E, 242E; 9, 83, 172
 open, Sec. 2, 261H; 6, 204
 overcurrent protection required, 161A; 62
 railway feeder, 242B; 172
 ridge-pin, 236I; 160
 sag, definition of, Sec. 2; 11
 shielded, 92B2b; 18
 shielding, definition of, Sec. 2; 6
 spacing, 236G; 159
 strength requirements. *See* Strength requirements
 supply. *See* Overhead communication lines; Overhead electric supply lines
 surge-protection, 242F; 172
 terminations
 insulation, 164A; 62
 metal-sheathed or shielded cable, 164B; 62
 trolley-contact circuit, 225A, 234A3, 234D2, 239G, 241C3b, 242B, 243, 261H3; 79, 110, 114, 167, 171, 172, 176, 205
 voltage to ground, definition of, Sec. 2; 14
- Conduit**
 definition of, Sec. 2, Sec. 32; 6, 223
 multiple-duct, Sec. 2; 6
 single-duct conduit, Sec. 2; 6
- Conduit system, definition of, Sec. 2; 6**
- Conflict**
 between lines, avoidance of, 221; 77
 structure, definition of, Sec. 2; 12
- Constant-current circuit, voltage of, definition of, Sec. 2; 14**
- Control switchboards, 180E; 66**
- Control, motor, 130, 131, 180D; 56, 66**

- Conveyors (grain bins), clearance conditions,** 234F, Fig 234-4; 114, 120
- Cover, manhole, definition of,** Sec. 2; 9
- Covered conductors, 230D; 83**
definition of, Sec. 2; 6
- Crossarms for line supports. See also Supporting structures**
grades of construction, 243B, 263C; 176, 209
loads upon, 252, 253; 194, 196
strength, determining, 261D; 202
- Crossings, 225D, 241C; 80, 171**
- Current-carrying part, definition of,** Sec. 2; 6
- Current-transformers, 150; 60. See also Transformers**
- Cylindrical structures and components, 252B2a; 194**
- D**
- DC. See Direct current systems**
- Deadends, 252C3, 261F1c; 195, 204**
- Dead-front power switchboards, 180C; 66**
- Decorative lighting, 217A5; 74**
- De-energized, definition of,** Sec. 2; 6
- De-energizing lines and equipment, 444; 276**
- Definitions of National Electrical Safety Code terms, Sec. 2; 5**
- Designated person, definition of,** Sec. 2; 6
- Diagonal clearance, 235D; 140**
- Direct-current systems**
clearances, 230G; 84
grounding methods, 123D; 40
grounding point, 92A; 17
- Disconnecting switch, Sec. 17; 63**
definition of, Sec. 2; 6
- Districts**
rural, definition of, Sec. 2; 10
urban, definition of, Sec. 2; 13
- Drop, service, definition of,** Sec. 2; 11
- Ducts, 322; 225**
definition of, Sec. 2, Sec. 32; 7, 223
installation, 322B; 225
- E**
- Effective date of National Electrical Safety Code, 16; 3**
- Effectively grounded circuits, voltage of (definition), Sec. 2; 14**
- Effectively grounded, definition of,** Sec. 2; 7
- Electric railway construction, 225; 79. See also Railroads**
guards under bridges, 225E; 80
high-voltage contact conductors, 225B; 80
prevention of contact loss at railroad crossings at grade, 225D; 80
third rails, 225C; 80
trolley-contact conductors, 225A, 234A3, 234D2, 239G, 241C3b, 242B, 243, 261H3; 79, 110, 114, 167, 171, 172, 176, 205
- Electric supply equipment, definition of,** Sec. 2; 7
- Electric supply lines. See Lines, electric supply**
- Electric supply stations. See Supply stations, electric**
- Electric supply systems, operation of. See Operation of electric supply systems, employee rules; Operation of electric supply systems, employer rules**
- Electrical code. See National Electrical Code; National Electrical Safety Code**
- Electrodes, grounding. See Grounding, electrodes**
- Electron-tube-containing devices, 180E; 66**
- Elevation**
correction for approach distance to live parts, 441A6, Table 441-5; 264, 272
isolated by, definition of, Sec. 2; 8

- Elevators, grain, clearance considerations, 234F**,
Fig 234-4; 114, 120
- Emergency installations, 14A; 2**
clearances for, 230A2; 81
inspections, 121C; 39
- Emergency lighting, supply station, 111B; 34**
- Emergency procedures, 410B; 247**
- Emergency rules.** See Operation of electric supply systems, employer rules
- Employee rules.** See Operation of electric supply systems, employee rules
- Employer rules.** See Operation of electric supply systems, employer rules
- Enclosed, definition of, Sec. 2; 7**
- Enclosure of equipment, 110A, 124C2; 32, 41**
- Energized**
definition of, Sec. 2; 7
equipment
guarding, 237E; 162
working on. See Operation of electric supply systems, employee rules, energized lines, and equipment
parts, equipment for work on, 126, 446B; 52, 278
- Envelope, clearance, 233A2, Fig 233-1, Fig 233-3, Fig 234-4; 99, 101, 104, 120**
- Equipment**
cases, 234J2; 116
clearance, 234J; 116. See also Overhead communication lines, clearance; Overhead electric supply lines, clearance
climbing space, location relative to, 236D; 158
definition of, Sec. 2; 7
electric supply. See Supply stations, electric
grounding conductors, 93C5; 21
installation. See Installation and maintenance of equipment
maintenance. See Installation and maintenance of equipment
remotely operable, definition of, Sec. 2; 10
rotating. See Rotating equipment
underground, Sec. 38; 242
design, 381; 242
grounding, 384; 243
identification, 385; 243
installation, 382; 243
utilization, definition of, Sec. 2; 13
- Excavation, 321A, 423D; 224, 257**
- Existing installations, 13B; 2**
- Exits, supply station, 113; 37**
- Exposed, definition of, Sec. 2; 7**
- Extension of installation, 13A; 1**
- Extreme wind loading, example applications**
Rule 250C, Appendix C; 290
- F**
- Fall arrest system, definition of, Sec. 2; 7**
- Fall prevention system, definition of, Sec. 2; 7**
- Fall protection, 411F, 420K; 251, 253**
- Fall protection program, definition of, Sec. 2; 7**
- Fall protection system (hardware), Sec. 2, 420K; 7, 253**
- Fastenings, conductor, 243C, 252, 261F; 176, 194, 204**
- Fences**
grounding of, 93C6, 93E; 21, 22
safety clearance zone, 110A2, Fig 110-1; 32, 33
types of, 110A1; 32
- Fiber stress, wood, 261A2; 200**
- Fiber-optic cable—communication**
clearances, 230F; 83
definition of, Sec. 2; 7
- Fiber-optic cable—supply**
clearances, 230F; 83
definition of, Sec. 2; 7
- Fiber-optic conductor, definition of, Sec. 2; 6**
- Final sag, definition of, Sec. 2; 11**
- Final unloaded sag, definition of, Sec. 2; 11**
- Final unloaded tension, definition of, Sec. 2; 13**

- Fire hydrants, clearances from, 231A; 85**
- Fire-alarm circuit conductors, 242D; 172**
- Fire-extinguishing equipment, 114, 420L; 38, 254**
- Fireproofing (of cables), definition of, Sec. 2; 8**
- First aid rules, 410B; 247**
- Flammable liquids, 127B; 53**
loading and unloading facilities, 127D; 54
storage areas, 127C; 54
- Flashover voltage, insulation, 272; 213**
- Flat surfaced structures and components, 252B2b; 195**
- Floors, supply station, 112A; 37**
- Foundations, loads upon, 252, 253, 261B; 194, 196, 202**
- Fuel lines, separation from underground conduit, 320B5; 224**
- Fuses, Sec. 17, 420N; 63, 254**
application, 171; 63
arrangement, 170; 63
capacity, 173A; 63
disconnecting, 173B, 174; 63
- G**
- Gages, wire, definition of, Sec. 2; 14**
- Gas lines, separation from underground conduit, 320B5; 224**
- Gaseous hydrogen systems for supply equipment, 127G; 54**
- Gas-insulated equipment, 443J; 276**
- Gasoline-dispensing stations, 127E; 54**
- Gates, 92E; 19**
- Generating station, definition of, Sec. 2; 8**
- Generators, Sec. 13; 56**
motor control, 131; 56
short-circuit protection, 133; 57
speed control and stopping devices, 130; 56
- Grades of construction**
application, 241; 171
B and C
loading. *See* Loading, line
strength requirements. *See* Strength requirements
conductors
communication conductors, 242C, Table 242-1, Table 242-2; 172, 173, 175
constant-current circuit conductors, 242A; 172
fire-alarm circuit conductors, 242D; 172
neutral conductors of supply circuits, 242E; 172
railway feeder conductors, 242B; 172
supply, 241A, Table 242-1; 171, 173
surge-protection wires, 242F; 172
trolley-contact circuit conductors, 242B; 172
crossings, 241C; 171
line supports, 243; 176
armless construction brackets, 243C; 176
conductor construction grade, change in, 252C1; 195
conductor fastenings, 234C; 111
crossarms, 243B; 176
insulators, 243C; 176
pins, 243C; 176
structures, 243A; 176
support arms, 243B; 176
N, strength requirements. *See* Strength requirements
order of grades, 241B; 171
- Grain bins, conductor clearance from, 234F, Fig 234-4; 114, 120**
- Grating, manhole, definition of, Sec. 2; 9**
- Ground wire, overhead, definition of, Sec. 2; 10**
- Ground, clearances above, 231B, 232, Table 232-1, Table 232-2; 86, 89, 95. *See also* Overhead communication lines, clearances; Overhead electric supply lines, clearances**
- Grounded circuit, voltage of (definition), Sec. 2; 14**
- Grounded conductor, 161B; 62**
definition of, Sec. 2; 6
- Grounded system, definition of, Sec. 2; 8**
- Grounded, definition of, Sec. 2; 8**

Grounded, effectively, definition of, Sec. 2; 8

Grounding

circuits and equipment, underground, 314; 221
 communication lines, 99, 315; 28, 221
 conductors, 215B; 71
 ampacity, 93C; 20
 common, for circuits and equipment, 93F; 22
 composition of, 93A; 20
 connection methods, 93, 95; 20, 25
 connection points, 92, 95B; 17, 26
 current in, 92D; 19
 definition of, Sec. 2; 6
 guarding, 93D; 21
 protection, 93D; 21
 separate, 92B3; 18
 separation of, 97; 27
 strength of, 93C; 20
 underground, 93E; 22
 conductors, definition of, Sec. 2; 6
 direct-current systems, 123D; 40
 electrodes, 94, 99; 22, 28
 existing, 94A; 22
 made, 94B; 23
 equipment, 93C5, 123; 21, 39
 during maintenance, 123C; 40
 guys, 92C, 93C5, 215C2; 18, 21, 72
 messenger wires, 92C, 93C5; 18, 21
 purpose of Code, 90; 17
 resistance requirements, 96; 26
 multi-grounded systems, 96C; 27
 single-grounded systems, 96D; 27
 supply stations, 96B; 26
 scope of code, 91; 17
 supporting structures, 215C1; 71

Guarded, definition of, Sec. 2; 8

Guarding

grounding conductors, 93D, 239D; 21, 166
 live parts, 124, 237E; 40, 162
 strength of guards, 124B; 40
 transmission machinery and suddenly moving parts, 122; 39
 types of guards, 124C; 40
 where required, 124A; 40

Guys

anchors, 253, 261B; 196, 202
 grounding, 92C, 93C5, 215C2; 18, 21, 72
 insulators, 261C, 279A; 202, 215
 load factors, 253; 196
 side guy, 261A4; 201

strength of, 261C, 263B; 202, 209

H

Handhole. See Manholes, handholes, and vaults

Harness, 420K; 253

definition of, Sec. 2; 8

Highways. See also Roadways

limited access, definition of, Sec. 2; 9

Horizontal clearance, 233B, 234A2, 234C1b, 234D1; 99, 110, 111, 113

between line conductors, 235B, Table 235-1, Table 235-2, Table 235-3; 135, 143, 144, 146

from live parts, Fig 124-1, Table 124-1; 42, 43

Horizontal load component, 251B2; 193

Hydrogen systems

gaseous, for supply equipment, 127G; 54

liquid, 127H; 54

mobile, 129; 55

I

Ice. See Loading, line

Identification, 128, 411E, 423E; 55, 250, 257

Idle equipment, inspection of, 121B; 39

Illumination

attachment plugs and receptacles, 111D; 35

battery areas, 145; 58

decorative, 217A5; 74

emergency lighting, 111B; 34

fixtures, 111C; 34

levels, Table 111-1; 35

receptacles in damp or wet locations, 111E; 35

street and area, 263H, 420P; 210, 255

supply stations, 111; 34

under normal conditions, 111A; 34

In service, definition of, Sec. 2; 8

Inch-foot-pound system, 17A; 3

Indoor installations

power transformers and regulators, 152B; 60

surge arresters, 191; 68

Initial unloaded sag, definition of, Sec. 2; 11

- Initial unloaded tension**, definition of, *Sec. 2*; 13
- In-service equipment, inspection of**, *121A, 214A*; 39, 70
- Inspections**, *121, 214*; 39, 70
 emergency equipment, *121C*; 39
 idle equipment, *121B*; 39
 in-service lines and equipment, *121A, 214A*; 39, 70
 lines, *214*; 70
 new equipment, *121D*; 39
 out-of-service lines and equipment, *214B*; 71
 protective devices, *411C*; 250
 underground lines and equipment, *313*; 220
 when in service, *313A*; 220
 when out of service, *313B*; 220
- Installation and maintenance of equipment**, *Sec. 12*; 39
 classified locations, *127*; 52
 boilers, *127F*; 54
 coal-handling areas, *127A*; 53
 flammable and combustible liquids, *127B*; 53
 flammable liquid storage area, *127C*; 54
 gaseous hydrogen systems for supply equipment, *127G*; 54
 gasoline-dispensing stations, *127E*; 54
 liquefied petroleum gas (LPG), *127K*; 55
 liquid hydrogen systems, *127H*; 54
 loading and unloading facilities, *127D*; 54
 natural gas (methane), *127L*; 55
 sulfur, *127I*; 55
 emergency equipment, *121C*; 39
 energized parts, equipment for work on, *126*; 52
 general requirements, *120*; 39
 guarding live parts, *124, 237E*; 40, 162
 strength of guards, *124B*; 40
 types of guards, *124C*; 40
 where required, *124A*; 40
 guarding shaft ends, pulleys, belts, and suddenly moving parts, *122*; 39
 identification, *128*; 55
 idle equipment, *121B*; 39
 in-service equipment, *121A*; 39
 inspections, *121*; 39
 mobile hydrogen equipment, *129*; 55
 new equipment, *121D*; 39
 protective grounding, *123*; 39
 during maintenance, *123C*; 40
 working space about electric equipment, *125*; 51
- Installation and maintenance of overhead communication lines**. *See* Overhead communication lines
- Installation and maintenance of overhead electric supply lines**. *See* Overhead electric supply lines
- Installation and maintenance of underground communication lines**. *See* Underground communication lines
- Installation and maintenance of underground electric supply lines**. *See* Underground electric supply lines
- Instrument transformers**. *See also* Transformers
 grounding of, *151*; 60
 grounding conductor ampacity, *93C3*; 20
- Insulated**
 conductor, *161C*; 62
 definition of, *Sec. 2*; 6
 definition of, *Sec. 2*; 8
- Insulation**
 aerial cable systems, *278*; 215
 definition of, *Sec. 2*; 8
 factory tests, *274*; 214
 guy insulators, *279A*; 215
 level, *273*; 213
 material and marking, *271*; 213
 mechanical strength, *277*; 214
 open-conductor supply lines. *See* Overhead electric supply lines, insulation
 ratio of flashover to puncture voltage, *272*; 213
 shielding, definition of, *Sec. 2*; 8
 span-wire insulators, *279B*; 216
 special applications, *275*; 214
- Insulator**
 definition of, *Sec. 2*; 8
 grade of construction, *243C, 263I*; 176, 209
 installing, *447*; 279
 loads upon, *252*; 194
 maintaining, *447*; 279
 span, *279B*; 216
 suspension, *235B2, 235E2*; 136, 140
- Intent of National Electrical Safety Code**, *15*; 2
- Interactive system, utility**, definition of, *Sec. 2*; 13
- International System of Units (SI)**, *17A*; 3

- Introduction to National Electrical Safety Code, Sec. 1;** 1
- Inverters, 180E1;** 66
- Iron, pulling, definition of, Sec. 2;** 10
- Isolated by elevation, definition of, Sec. 2;** 8
- Isolated, definition of, Sec. 2;** 8
- Isolated-phase bus, 181B;** 67
- Isolating switch, definition of, Sec. 2;** 6
- Isolation of conductors, 163;** 62
- Isolator. See** Disconnecting switch; Isolating switch
- J**
- Jacket, cable, definition of, Sec. 2;** 5
- Jacket, definition of, Sec. 2;** 8
- Joint use, 222;** 77
definition of, *Sec. 2;* 9
- Joints, 322;** 225
- L**
- Ladders, 420J;** 253
- Lanyards, 411C;** 250
definition of, *Sec. 2;* 9
- Lateral conductor, definition of, Sec. 2;** 6
- Latticed structures, 252B2c;** 195
- Length, span, definition of, Sec. 2;** 12
- Lighting circuits, 92B1, 97A;** 17, 27
- Lighting. See** Illumination
- Lightning-protection equipment, 93D4;** 22
- Limited access highways, definition of, Sec. 2;** 9
- Line conductor, definition of, Sec. 2;** 6
- Line supports. See** Supporting structures
- Line worker's body belt, 420K;** 254
definition of, *Sec. 2;* 9
- Lines, communication**
definition of, *Sec. 2;* 9
fiber-optic cable, *Sec. 2, 230F;* 7, 83
grounding, 97, 99, 315; 27, 28, 221
installation and maintenance
 Overhead. *See* Overhead communication lines
 Underground. *See* Underground communication lines
operation. *See* Operation of electric supply systems, employee rules; Operation of electric supply systems, employer rules
- Lines, electric supply**
definition of, *Sec. 2;* 9
fiber-optic cable, *Sec. 2, 230F;* 7, 83
installation and maintenance
 overhead. *See* Overhead electric supply lines
 underground. *See* Underground electric supply lines
operation. *See* Operation of electric supply systems, employee rules; Operation of electric supply systems, employer rules
- Lines. See** Lines, communication; Lines, electric supply
- Liquefied petroleum gas (LPG), 127K;** 55
- Liquid hydrogen systems, 127H;** 54
- Liquid-cell batteries, 420G;** 253
- Liquids, flammable. See** Flammable liquids
- Live lines and equipment, work on**
approach distance, 441A, 441B; 262, 264
barehand method, bonding and shielding for, 446D; 279
capacitors, 443I; 275
clear live-line tool insulation length, 441C; 265
connections, making, 443F; 275
current transformer secondaries, 443H; 275
de-energizing to protect employees, 444; 276
 employee's protective grounds, 444D; 276
 employee's request, 444B; 276

- Live lines and equipment, work on** (*continued*)
 operating switches, disconnectors, and tagging, 444C; 276
 proceeding with work, 444E; 277
 re-energizing, sequence of, 444H; 277
 tags, removal of, 444G; 277
 transferring responsibility, 444F2; 277
 delta circuits, unintentional grounds on, 443L; 276
 employee-assisting requirements, 443B; 275
 equipment, 446B; 278
 gas-insulated, 443J; 276
 general requirements, 443A; 274
 protective grounds, 445; 277
 installing, 445A; 277
 removing, 445B; 278
 reporting clear, 444F1; 277
 switching control procedures, 442, 443C, 443E; 273, 275
 designated person, 442A; 273
 operations at stations, 442C; 273
 oral messages, repeating, 442G; 274
 re-energizing after work, 442D; 273
 restoration of service after automatic trip, 442F; 274
 specific work, 442B; 273
 tagging circuits associated with work activities, 442E; 273
 training, 446A; 278
 working position, 443D; 275
- Live parts**
 approach distance to, 441A, 441B; 264
 clearance from, 232C, 234C, 234D; 87, 111, 113
 guarding, 124, 234C2; 40, 112
- Load control devices**, 180E1; 66
- Loading facilities, flammable and combustible liquids**, 127D; 54
- Loading, line**, Sec. 25; 177
 combined ice and wind loading, 250B, 253, Table 253-1, Table 253-2; 177, 196, 197, 198
 components, 251B; 193
 conductors, 251; 193
 extreme wind loading, 250C, 253, Table 253-1, Table 253-2, 260B2; 177, 196, 197, 198, 199
 example applications, Appendix C; 290
 line supports, 252; 194
 longitudinal, assumed, 252C; 195
 simultaneous, application of loads, 252D; 196
 transverse, assumed, 252B; 194
 vertical, assumed, 252A; 194
 maps, Fig 250-1, Fig 250-2; 179, 180
- Logic devices**, 180E1; 66
- Longitudinal loading, assumed**, 252C; 195
 changes in grade of construction, 252C1; 195
 communication conductors on unguyed supports, 252C7; 196
 deadends, 252C3; 195
 poles, jointly used, 252C2; 195
 stringing loads, 252C5; 196
 unequal spans, 252C4; 196
- Longitudinal strength requirements**, 261A5; 201
- LPG (liquefied petroleum gas)**, 127K; 55
- Luminaires**, 238C, 238D, Table 238-2, 239E2b, 239G3; 163, 164, 166, 167
- M**
- Maintenance**. See Installation and maintenance
- Manholes, handholes, and vaults**, 323; 225
 access, 323C, 423A, 433K; 226, 257, 276
 covers, 323D; 227
 definition of, Sec. 2; 9
 definition of, Sec. 2; 8, 9, 13
 dimensions, 323B; 226
 drainage, 323G; 227
 grating, definition of, Sec. 2; 9
 identification, 323J; 227
 ladder requirements, 323F; 227
 mechanical protection, 323I; 227
 routing, 320A; 223
 bridges, 320A4; 223
 highways and streets, 320A3; 223
 natural hazards, 320A2; 223
 railroad tracks, 320A5; 223
 submarine crossing, 320A6; 223
 tunnels, 320A4, Sec. 39; 223, 244
 separation from other underground installations, 320B; 224
 lines that transport flammable material, 320B5; 224
 sewers, sanitary and storm, 320B3; 224
 steam lines, 320B6; 224
 supply conduit systems, 320B2; 224
 water lines, 320B4; 224

- strength, 323A; 225
 testing for gas in, 423B; 257
 vault and tunnel utility access, 323E; 227
 ventilation, 323H; 227
- Manual stopping devices**, 130B; 56
- Manual**, definition of, Sec. 2; 9
- Maps, overhead line loading**, Fig 250-1, Fig 250-2; 179, 180
- Mats**, 124C4; 41
- Maximum anticipated per-unit overvoltage factor (I)**, determining, Appendix D; 301
- Maximum total sag**, definition of, Sec. 2; 11
- Measure, units of**, 17; 3
- Mechanical protection of conductors**, 162, 239D; 62, 166
- Mechanical transmission machinery, guarding**, 122A; 39
- Messenger wires, grounding**, 92C, 93C5; 18, 21
- Metal supporting structures**, 261A, 251C1; 199, 202
- Methane, natural gas**, 127L; 55
- Metric system**, 17A; 3
- Microwave radios, totalizing**, 180E1; 66
- Minimum approach distance**, definition of, Sec. 2; 9
- Mobile hydrogen systems**, 129; 55
- Motor generators**. See Generators
- Motors**
 adjustable-speed, 130E; 56
 control, 130, 131, 180D; 56, 66
 short-circuit protection, 133; 57
 speed limit, 130C; 56
- Movement envelope, conductor**, 233A1, Fig 233-1, Fig 233-2; 99, 101, 102
- Multigrounded/multiple grounded systems**, 96C, 97D2; 20, 28
 definition of, Sec. 2; 9
- Multiple-duct conduit**, definition of, Sec. 2; 6
- N**
- N grade construction**. See Grades of construction
- National Electrical Code (NEC)**, 11; 1
- National Electrical Safety Code (NESC)**
 application, 13; 1
 definitions of special terms, Sec. 2; 5
 effective date, 16; 3
 intent, 15; 2
 introduction to, Sec. 1; 1
 purpose, 10; 1
 rules, 12; 1
 scope, 11; 1
 units of measure, 17; 3
 waiver, 14; 2
- Natural gas (methane)**, 127L; 55
- NEC**. See National Electrical Code
- NESC**. See National Electrical Safety Code
- Neutral conductors**, 230E, 242E; 83, 172
 definition of, Sec. 2; 9
- New equipment, inspection of**, 121D; 39
- New installations**, 13A; 1
- Nonshielded conductors**, 92B2a; 17
- O**
- Oil-containing circuit-interrupting devices**, 172; 63
- Open conductors**, 261H; 204
 definition of, Sec. 2; 6
- Operation of communication systems, employee rules**, Sec. 42, Sec. 43; 252, 259
 general operating routines, 421, 430; 255, 259
 area protection, 421B; 255
 duties of a first-level supervisor or person in charge, 421A; 255
 escort, 421C; 256
 overhead line operating procedures, 422; 256

Operation of communication systems, employee rules (continued)

- checking structures before climbing, 422B; 256
- installing and removing wires or cables, 422C; 256
- joint-use structures, 432; 260
- setting, moving, or removing poles in or near energized electric supply lines, 422A; 256
- personal general precautions, 420; 252
 - arcing conditions, 420F; 253
 - cable reels, 420O; 255
 - clothing, 420I; 253
 - communication work minimum approach distances, Table 431-1; 260
 - energized or unknown conditions, 420D, 431; 252, 259
 - fall protection, 420K; 253
 - fire extinguishers, 420L; 254
 - fuses, 420N; 254
 - ladders and supports, 420J; 253
 - lighting, street and area, 420P; 255
 - liquid-cell batteries, 420G; 253
 - machines or moving parts, 420M; 254
 - purpose of Code, 400; 245
 - qualifications of employees, 420B; 252
 - rules and emergency methods, 420A; 252
 - safeguarding oneself and others, 420C; 252
 - scope of Code, 401; 245
 - tools and protective equipment, 420H; 253
 - ungrounded metal parts, 420E; 253
- purpose of Code, 400; 245
- scope of Code, 401; 245
- underground line operating procedures, 423; 257
 - excavation, 423D; 257
 - flames, 423C; 257
 - guarding manhole and street openings, 423A, 433; 257, 260
 - identification, 423E; 257
 - operation of power-driven equipment, 423F; 258
 - sheath continuity, 434; 261
 - testing for gas in manholes and unventilated vaults, 423B; 257

Operation of communication systems, employer rules, Sec. 41; 246

- emergency procedures and first-aid rules, 410B; 247
- general requirements, 420; 252
- protective methods and devices, 411; 250
 - devices and equipment, 411B; 250

- fall protection, 411F; 251
- identification and location, 411E; 250
- inspection and testing of protective devices, 411C; 250
- methods, 411A; 250
- warning signs, 411D; 250
- purpose of Code, 400; 245
- scope of Code, 401; 245

Operation of electric supply systems, employee rules, Sec. 42, Sec. 44; 252, 262

- energized lines and equipment. *See also* Live lines and equipment, work on
 - approach distance, 441A, 441B; 262, 264
 - clear live-line tool length, 441C; 265
 - de-energizing to protect employees, 444; 276
 - work on, 443, 446; 274, 278
- general operating routines, 421, 440; 255, 262
 - area protection, 421B; 255
 - duties of a first-level supervisor or person in charge, 421A; 255
 - escort, 421C; 256
- overhead line operating procedures, 422; 256
 - checking structures before climbing, 422B; 256
 - installing and removing wires or cables, 422C; 256
 - setting, moving, or removing poles in or near energized electric supply lines, 422A; 256
- personal general precautions, 420; 253
 - arcing conditions, 420F; 253
 - cable reels, 420O; 255
 - clothing, 420I; 253
 - energized or unknown conditions, 420D, 441; 252, 262
 - fall protection, 420K; 253
 - fire extinguishers, 420L; 254
 - fuses, 420N; 254
 - ladders and supports, 420J; 253
 - lighting, street and area, 420P; 255
 - liquid-cell batteries, 420G; 253
 - machines or moving parts, 420M; 254
 - purpose of Code, 400; 245
 - qualification of employees, 420B; 252
 - rules and emergency methods, 420A; 252
 - safeguarding oneself and others, 420C; 252
 - scope of Code, 401; 245
 - tools and protective equipment, 420H; 253
 - ungrounded metal parts, 420E; 253
- protective grounds, 445; 277
 - installing, 445A; 277
 - removing, 445B; 278

- purpose of Code, 400; 245
- scope of Code, 401; 245
- switching control procedures, 442; 273
 - designated person, 442A; 273
 - operation at stations, 442C; 273
 - oral messages, repeating, 442G; 274
 - re-energizing after work, 442D; 273
 - restoration of service after automatic trip, 442F; 274
 - specific work, 442B; 273
 - tagging circuits associated with work activities, 442D; 273
- underground operating procedures, 423; 257
 - excavation, 423D; 257
 - flames, 423C; 257
 - guarding manhole and street openings, 423A, 443K; 257, 276
 - identification, 423E; 257
 - operation of power-driven equipment, 423F; 258
 - testing for gas in manholes and unventilated vaults, 423B; 257
- Operation of electric supply systems, employer rules, Sec. 41; 246**
 - emergency procedures and first-aid rules, 410B; 247
 - general requirements, 410; 246
 - protective methods and devices, 411; 250
 - devices and equipment, 411B; 250
 - fall protection, 411F; 251
 - identification and location, 411E; 250
 - inspection and testing of protective devices, 411C; 250
 - methods, 411A; 250
 - warning signs, 411D; 250
 - purpose of Code, 400; 245
 - scope of Code, 401; 245
- Out of service, definition of, Sec. 2; 9**
- Outdoor installations, power transformers and regulators, 152A; 60**
- Overhead communication lines**
 - accessibility, 213, 216; 70, 73
 - application of rules, 202; 69
 - clearances, Sec. 23; 81
 - antennas, 234, Table 234-1, Table 234-5, 235I; 109, 122, 134, 142
 - application of Code, 230A; 81
 - beaches, 234E2; 114
 - billboards, 234C, Table 234-1; 111, 122
 - bridges, 234, Table 234-1; 109, 122
 - buildings, 234, 234C, Fig 234-1, Table 234-1, Table 234-4; 109, 111, 117, 122, 133
 - chimneys, 234C, Table 234-1, Table 234-5; 111, 122, 134
 - climbing space. *See* Climbing space
 - covered conductors, 230D; 83
 - dc circuits, 230G; 84
 - definition of, Sec. 2; 5
 - diagonal, 235D; 140
 - envelope, 233A2, Fig 233-1, Fig 233-3, Fig 234-4; 99, 101, 104, 120
 - equipment, 234J; 116
 - fiber-optic cable, 230F; 83
 - grain bins, 234F; 114
 - ground, 231B, 232, Table 232-1, Table 232-2; 86, 89, 95
 - horizontal, 233B, 234A, Fig 234-1, 234CI, 234DI, 235B, Table 235-1, Table 235-2, Table 235-3; 99, 109, 111, 113, 117, 135, 143, 144, 146
 - movement envelope, 233A1, Fig 233-1, Fig 233-2; 99, 101, 102
 - neutral conductors, 230E; 83
 - rail cars, 234I, Fig 234-5; 116, 121
 - roadways, 231B, 232, Table 232-1, Table 232-2; 86, 89, 95
 - signs, Table 234-5; 134
 - spacing between, 235H; 142
 - supporting structures, 231, 233, 234B, 234J; 85, 98, 116
 - swimming pools, 234, Fig 234-3, Table 234-3; 109, 119, 131
 - tanks, 234C, Table 234-1, Table 234-5; 111, 122, 134
 - uniform system of (adopted in the 1990 NESC Edition), Appendix A; 281
 - vertical, 232, 233C, 234, Fig 234-1, 235C, 238; 86, 99, 109, 117, 137, 163
 - water surfaces. *See* Water, clearance from wind displacement. *See* Loading, line working space. *See* Working space
 - climbing space. *See* Climbing space
 - communication circuits located in the supply space, 224A; 78
 - communications and supply facilities located on same structure, 238; 163
 - conductors. *See* Conductors
 - conflict between lines, avoiding, 221; 77
 - electric railway construction, 225; 79
 - guards under bridges, 225E; 80
 - high-voltage contact conductors, 225B; 80
 - prevention of loss of contact at railroad crossings at grade, 225D; 80

Overhead communication lines (continued)

trolley-contact conductor fastenings, 225A, 234A3, 234D2, 241C3b, 242B, 243, 261H3; 79, 110, 114, 171, 172, 176, 205

general requirements, *Sec. 21*; 70

grades of construction. *See* Grades of construction

grounding, 215; 71

 circuits, 215B; 71

 guys, 92C, 93C5, 215C2; 18, 21, 72

 messengers, 92C, 93C5, 215C8; 18, 21, 73

 supporting structures, 215C1; 71

identification, 220D; 77

inspection

 when in service, 214A; 70

 when out of service, 214B; 71

joint use of structures, 222; 77

loading. *See* Loading, line

protective requirements, 223; 78

purpose of Code, 200; 69

relative levels, 220; 76

scope of Code, 201; 69

span wires, 238C, *Table 238-2*; 163, 164

strength requirements. *See* Strength requirements

supply circuits located within the communication space, 224B, 239F; 79, 166

supporting structures. *See* Supporting structures

switches. *See* Switches

tests

 when in service, 214A, 313A; 70, 220

 when out of service, 214B, 313B; 71, 220

vegetation management, 218; 75

Overhead electric supply lines

accessibility, 213, 216; 70, 73

application of rules, 202; 69

clearances, *Sec. 23*; 81

 antennas, 234, *Table 234-1*, *Table 234-5*, 235I; 109, 122, 134, 142

 application of Code, 230A; 81

 beaches, 234E2; 114

 billboards, 234C, *Table 234-1*; 111, 122

 bridges, 234, *Table 234-4*; 109, 133

 buildings, 234, *Fig 234-1*, 234C, *Table 234-1*, *Table 234-4*; 109, 111, 117, 122, 133

 chimneys, 234C, *Table 234-1*, *Table 234-5*; 111, 122, 134

 climbing space. *See* Climbing space

 covered conductors, 230D; 83

 dc circuits, 230G; 84

 definition of, *Sec. 2*; 5

 diagonal, 235D; 140

 envelope, 233A1, *Fig 233-1*, *Fig 233-3*; 99, 101, 104

 equipment, 234J; 116

 fiber-optic cable, 230F; 83

 grain bins, 234F; 114

 horizontal, 233B, 234A, *Fig 234-1*, 234C1, 234D1, 235B, *Table 235-1*, *Table 235-2*, *Table 235-3*; 99, 109, 111, 113, 117, 135, 143, 144, 146

 measurement envelope, 233A1, *Fig 233-1*, *Fig 233-1*; 99, 101, 102

 measurement, 230A3; 81

 neutral conductors, 230E; 83

 rail cars, 234I, *Fig 234-5*; 116, 121

 roadways, 231B, 232, *Table 232-1*, *Table 232-2*; 86, 89, 95

 signs, *Table 234-5*; 134

 supply cables, 230C; 83

 supporting structures, 231, 233, 234B, 234J; 85, 98, 110, 116

 swimming pools, 234, *Fig 234-3*, *Table 234-3*; 109, 119, 131

 tanks, 234C, *Table 234-1*, *Table 234-5*; 111, 122, 134

 uniform calculations (adopted in NESC 2007 Edition), *Appendix B*; 287

 uniform system of (adopted in 1990 NESC Edition), *Appendix A*; 281

 vertical, 232, 233C, 234, *Fig 234-1*, 235C, 238; 86, 99, 109, 117, 137, 163

 water surfaces. *See* Water, clearance from

 wind displacement. *See* Loading, line

climbing space. *See* Climbing space

communication and supply facilities located on same structure, 238; 163

communication circuits located in the supply space, 224A; 78

conductors. *See* Conductors

conflict between lines, avoiding, 221; 77

electric railway construction, 225; 79

 guards under bridges, 225E; 80

 high-voltage contact conductors, 225B; 80

 prevention of contact loss at railroad crossings at grade, 225D; 80

 third rails, 225C; 80

 trolley-contact conductor fastenings, 225A, 234A3, 234D2, 241C3b, 242B, 243, 261H3; 79, 110, 114, 171, 172, 176, 205

 general requirements, *Sec. 21*; 70

 grades of construction. *See* Grades of construction

 grounding, 215B; 71

- circuits, 215B; 71
 - guys, 92C, 93C5, 215C2; 18, 21, 72
 - messengers, 92C, 93C5, 215C8; 18, 21, 73
 - supporting structures, 215C1; 71
 - identification, 220D; 77
 - inspection
 - when in service, 214A; 70
 - when out of service, 214B; 71
 - insulation, Sec. 27; 213
 - aerial cable systems, 278; 215
 - definition of, Sec. 2; 8
 - factory tests, 274; 214
 - guy insulators, 279A; 215
 - level, 273; 213
 - material and marking, 271; 213
 - mechanical strength, 277; 214
 - open conductor supply line. *See* Overhead electric supply lines, insulation
 - ratio of flashover to puncture voltage, 272; 213
 - shielding, definition of, Sec. 2; 8
 - span-wire insulators, 279B; 216
 - special applications, 275; 214
 - joint use of structures, 222; 77
 - loading. *See* Loading, line
 - purpose of Code, 200; 69
 - relative levels, 220; 76
 - scope of Code, 201; 69
 - strength requirements. *See* Strength requirements
 - supply circuits located within the communication space, 224B, 239F, 239G; 79, 166, 167
 - supporting structures. *See* Supporting structures
 - switches. *See* Switches
 - tests
 - when in service, 214A, 313A; 70, 220
 - when out of service, 214B, 313B; 71, 220
 - vegetation management, 218; 75
- Overhead ground wire**, definition of, Sec. 2; 10
- Overhead shield wires**, 261H; 204
- Overspeed trip device for prime movers**, automatic, 130A; 56
- Overvoltage**, definition of, Sec. 2; 10
- P**
- Pad-mounted equipment**, definition of, Sec. 2; 10
- Part, current-carrying**, definition of, Sec. 2; 6
- Passageways, supply station**, 112B; 37
- Person, designated**, definition of, Sec. 2; 6
- Pins (line support)**, 234C, 252, 261F; 111, 194, 204
- Piping systems as grounding electrodes**, 94A, 95B; 22, 26
- Plates, buried, as grounding electrodes**, 94B3c; 24
- Plowing**, 352B; 236
- Poles**. *See also* Supporting structures
 - butt plates as grounding electrodes, 94B4; 24
 - loads on, 252; 194
 - strength requirements, Sec. 26; 199
- Positioning device system**, definition of, Sec. 2; 10
- Positioning straps**, 411B, 420K; 250, 253
 - definition of, Sec. 2; 10
- Power transformers**, 152. *See also* Transformers
 - indoor installations, 152B; 60
 - outdoor installations, 152A; 60
 - short-circuit protection, 153; 61
- Precipitator logic devices**, 180E1; 66
- Pressure, side-wall**, definition of, Sec. 2; 12
- Prestressed-concrete structures**, 261A1, 261C1, Table 261-1; 200, 202, 207
 - definition of, Sec. 2; 10
- Protective grounding**. *See* Grounding
- Protective methods and devices**. *See* Operation of electric supply systems, employee rules; Operation of electric supply systems, employer rules
- Pulling iron**, definition of, Sec. 2; 10
- Pulling tension**, definition of, Sec. 2; 10
- Puncture voltage, insulation**, 272; 213
- Purpose of National Electrical Safety Code**, 10; 1
- Q**
- Qualified climber**, definition of, Sec. 2; 10
- Qualified**, definition of, Sec. 2; 10

R**Raceway**

- definition of, *Sec. 2; 10*
- grounding conductors, *93C5; 21*

Racks, 143; 58**Radios, microwave, totalizing, 180E1; 66****Railings, 112, Fig 124-2; 37, 42**

- Railroads.** *See also* Electric railway construction
- ballast section, definition of, *Sec. 2; 5*
 - clearances, *231C, 232, 234; 86, 109*
 - underground, *320A5, 351C3; 223, 235*
 - grades of construction, *241C3b, 242B, 243; 171, 172, 176*

Random separation

- definition of, *Sec. 2; 10*
- direct buried cable, *354; 237*

Readily climbable supporting structure, Sec. 2, 217A2; 12, 73**Reclosers, Sec. 17; 63**

- application, *171; 63*
- arrangement, *170; 63*
- capacity, *173A; 63*
- oil-containing, *172; 63*
- provisions for disconnecting, *173B; 63*

Re-energizing after work, 442D, 444H; 273, 277**Regulators**

- indoor installations, *152B; 60*
- outdoor installations, *152A; 60*

Reinforced concrete structures, Table 253-2, 261A1, 261C2, Table 261-1; 198, 200, 202, 207**Reinforcing bars as grounding electrodes, 94A3, 95A3; 23, 26****Relay logic devices, 180E1; 66****Remotely operable (as applied to equipment), definition of, Sec. 2; 10**

- Resistance requirements, grounding systems, 96; 26**
- multi-grounded systems, *96C; 27*
 - single-grounded systems, *96D; 27*
 - supply stations, *96B; 26*

Ridge-pin conductors, 236I; 160**Risers, Sec. 36; 240**

- installation, *361; 240*
- pad-mounted installations, *363; 240*
- pole risers, *362; 240*

Roadways

- clearances from
 - overhead, *231B, 232, Table 232-1, Table 232-2; 86, 89, 95*
 - underground, *320A3, 351C4; 223, 235*
- definition of, *Sec. 2; 10*
- shoulder, definition of, *Sec. 2; 12*
- traveled way, definition of, *Sec. 2; 13*

Rods as grounding electrodes, 94B2; 23**Rotating equipment, Sec. 13; 49**

- motor control, *131; 56*
- short-circuit protection, *133; 57*
- speed control and stopping devices, *130; 56*

Rules, National Electrical Safety Code, 12; 1**Rural districts, definition of, Sec. 2; 10****S****Safety clearance zone, electric supply station, 110A2, Fig 110-1; 32, 33****Safety zone, communication worker, 354C4, 238E; 139, 163****Safety, employee. See Operation of electric supply systems, employee rules****Safety, employer. See Operation of electric supply systems, employer rules****Sag**

- apparent, at any point in the span, definition of, *Sec. 2; 11*
- apparent, of a span (definition), *Sec. 2; 11*
- clearance considerations
 - conductors of different sag on same support, *235C2b; 138*
 - horizontal clearance, *255B1b, Table 235-2, Table 235-3; 135, 144, 146*
- conductor, definition of, *Sec. 2; 11*
- definition of, *Sec. 2; 10*
- final unloaded, definition of, *Sec. 2; 11*
- final, definition of, *Sec. 2; 11*

- initial unloaded, definition of, *Sec. 2; 10*
total, definition of, *Sec. 2; 11*
- Scope of the National Electrical Safety Code, 11;**
1
- Separation of grounding conductors, 97; 27**
- Separation, definition of, *Sec. 2; 11***
- Separation, random**
definition of, *Sec. 2; 10*
direct buried cable, *354; 237*
- Service drop, definition of, *Sec. 2; 11***
- Service point, definition of, *Sec. 2; 11***
- Service.** *See* In service; Out of service
- Settings, strength of, 261B; 202**
- Sewers, separation from underground lines, 320B3, 354E; 224, 239**
- Sheath transposition connections (cross-bonding), 93E6; 22**
- Sheath, cable, definition of, *Sec. 2; 5***
- Shield wire, definition of, *Sec. 2; 11***
- Shielded conductors, 92B2b; 18**
- Shielding, conductor, definition of, *Sec. 2; 6***
- Shielding, insulation, definition of, *Sec. 2; 8***
- Shields, 124C2; 41**
- Short-circuit protection**
motors, *133; 57*
power transformers, *153; 61*
- Short-time ampacity, grounding conductor, 93C; 20**
- Shoulder, definition of, *Sec. 2; 12***
- SI (International System of Units), 17A; 3**
- Side-wall pressure, definition of, *Sec. 2; 12***
- Signs, 217A4, Table 234-5, 411D; 74, 134, 250**
- Single-duct conduit, definition of, *Sec. 2; 6***
- Single-grounded system, definition of, *Sec. 2; 12***
- Snap hooks, positioning strap, 420K; 253**
- Solid-state logic devices, 180E1; 66**
- Soot blower control devices, 180E1; 66**
- Spacer cable, definition of, *Sec. 2; 12***
- Span**
length, definition of, *Sec. 2; 12*
sag, definitions of, *Sec. 2; 10*
wire
clearances from communication lines, *238C, Table 238-2; 163, 164*
definition of, *Sec. 2; 12*
insulators, *279B; 216*
- Speed control and stopping devices, 130; 56**
adjustable-speed motors, *130E; 56*
automatic overspeed trip device for prime movers, *130A; 56*
manual stopping devices, *130B; 56*
protection of control circuits, *130F; 56*
speed limit for motors, *130C; 56*
- Stairs and steps**
supply stations, *112; 37*
supporting structures, *217A2, 239B; 73, 165*
- Standoff brackets, 217A2, 239J; 74, 168**
- Static wire, definition of, *Sec. 2; 12***
- Station, electric supply, definition of, *Sec. 2; 7***
- Station, generating, definition of, *Sec. 2; 7***
- Steam lines, separation from underground conduit, 320B6; 224**
- Steel Wire Gage (Stl WG), *Sec. 2; 14***
- Steps.** *See* Stairs and steps
- Stopping devices.** *See* Speed control and stopping devices
- Storage batteries, *Sec. 14; 58***
employee precautions, *420G; 253*
floors in battery areas, *144; 58*
illumination for battery areas, *145; 58*
location, *141; 58*
racks, *143; 58*

- Storage batteries (continued)**
 service facilities, 146; 58
 ventilation, 142; 58
- Strap (positioning)**, 411B, 420K; 250, 253
 definition of, Sec. 2; 10
- Streets, clearances from**, 231B; 86
 underground, 320A3, 351C4; 81, 235
- Strength requirements**, Sec. 26; 199
 Grade N construction, 263; 209
 communication conductors, 263G; 210
 crossarm strength, 263C; 209
 guys, 263B; 209
 insulators, 263I; 210
 poles, 263A; 209
 service drops, 263E, Table 263-2; 209, 211
 street and area lighting equipment, 263H;
 210
 supply line conductors, 263D, Table 263-1;
 209, 210
 trolley-contact conductors, 263F; 210
 Grades B and C construction, 261; 199
 armless, 261G; 204
 braces, 261D; 202
 communication cables, 261K; 205
 communication conductors, open-wire,
 261J; 205
 communication conductors, paired, 261L;
 206
 crossarms, 261D; 202
 fastenings, 261F; 204
 foundations, 261B; 202
 guy anchors, 261B; 202
 guys and guy insulators, 261C; 202
 open supply conductors, 261H; 204
 overhead shield wires, 261H; 204
 pins, 261F; 204
 settings, 261B; 202
 supply cable messengers, 261I; 205
 support hardware, 261M; 206
 supporting structures, 261A; 199
 guying and bracing, 264; 211
 anchor rods, 264F; 212
 electrolysis, 264E; 212
 fastenings, 264D; 212
 point of attachment, 264C; 211
 strength, 264B; 211
 where used, 264A; 211
- Strips, buried, as grounding electrodes**, 94B3b; 24
- Structure conflict**, definition of, Sec. 2; 12
- Structures, supporting**. *See* Supporting structures
- Submarine crossings**, 320A6, 351C5; 223, 235
- Substation**, definition of, Sec. 2; 7, 12
- Suddenly moving parts**, 122B; 39
- Sulfur dust**, 127I; 55
- Supply equipment, electric**, definition of, Sec. 2; 7
- Supply lines, electric**. *See* Lines, electric supply
- Supply stations, electric**
 definition of, Sec. 2; 7
 generating station, definition of, Sec. 2; 7
 ground resistance requirements, 96B; 26
 protective arrangements, Sec. 11; 32
 electric equipment, 110C; 33
 enclosures, 110A; 32
 exits, 113; 37
 fire-extinguishing equipment, 114; 38
 floors, 112A; 37
 illumination, 111; 34
 passageways, 112B; 37
 railings, 112C; 37
 rooms and spaces, 110B; 32
 stair guards, 112D; 37
 top rails, 112E; 37
 purpose of Code, 100; 31
 scope of Code, 101; 31
 substation, definition of, Sec. 2; 12
- Support arms**, 232B, 243B; 87, 176
- Support hardware**, 253, 261M; 196, 206
- Supporting structures**
 armless construction brackets, 243C; 176
 clearances from other objects, 231; 85
 fire hydrants, 231A; 85
 railroad tracks, 231C; 86
 streets, roads, highways, 231B; 86
 climbing. *See* Climbing space
 conductor fastenings, 243C, 252, 261F; 176,
 194, 204
 crossarms, 243B, 253, Table 253-1; 176, 196,
 197
 decorative lighting, 217A5; 74
 definition of, Sec. 2; 12
 different, clearances between conductors
 carried on, 233, Table 233-1; 98, 104
 grades of construction, 243A; 176
 grounding of, 215C1; 71

- identification, 217A3; 74
 - insulators, 243C; 176
 - loads upon, 252; 194
 - longitudinal, assumed, 252C; 195
 - simultaneous application of, 252D; 196
 - transverse, assumed, 252B; 194
 - vertical, assumed, 252A; 194
 - metal, 261A, 261C1, Table 261-1; 199, 202, 207
 - not readily climbable, definition of, Sec. 2; 12
 - obstructions, 217A4; 74
 - pins, 243C; 176
 - prestressed-concrete, 261A1, 261C1, Table 261-1; 200, 202, 207
 - protection of, 217A1; 73
 - readily climbable, Sec. 2, 217A2; 12, 73
 - reinforced concrete, Table 253-2, 261A1, 261C2, Table 261-1; 198, 200, 202, 207
 - standoff brackets, 217A2c; 74
 - steps, 217A2b; 74
 - strength requirements. *See* Strength requirements
 - support arms, 243B; 176
 - support hardware, 253, 261M; 196, 206
 - unusual, 217B; 74
 - wood, 261A2, 261C2, Table 261-2; 200, 202, 208
 - working space. *See* Working space
- Surge arresters**, Sec. 19; 68
- grounding conductors, 192; 68
 - ampacity, 93C4; 21
 - indoor locations, 191; 68
 - installation, 193; 68
- Surge-protection wire**, definition of, Sec. 2; 12
- Susceptiveness**, definition of, Sec. 2; 12
- Suspension insulators**, 235B2, 235E2; 136, 140
- Swimming pools**, 234, Fig 234-3, Table 234-3, 351C1; 109, 119, 131, 235
- Switchboards**
- control, 180E; 66
 - dead-front, 180C; 66
 - definition of, Sec. 2; 12
- Switches**
- application, 171; 63
 - arrangement, 170; 63
 - capacity, 173A; 63
 - definition of, Sec. 2; 12
 - disconnecting, Sec. 17; 63
 - definition of, Sec. 2; 6
 - isolating, definition of, Sec. 2; 6
 - oil-containing, 172; 63
 - protecting employees by, 443E; 275
- Switchgear assemblies**, 180; 65
- control switchboards, 180E; 66
 - dead-front power switchboards, 180C; 66
 - de-energizing, 443G; 275
 - general requirements, 180A; 65
 - metal-enclosed power switchgear, 180B; 65
 - motor control centers, 180D; 66
- System, conduit**, definition of, Sec. 2; 6
- System, grounded**, definition of, Sec. 2; 8
- Systeme International d'Units (SI)**, 17A; 3
- T**
- Tag**, definition of, Sec. 2; 13
- Tanks, conductor clearance from**, 234C, Table 234-1, Table 234-5; 111, 122, 134
- Telemetry devices**, 180E1; 66
- Temporary overhead installations**, 14B; 2
- Tension, pulling of**, definition of, Sec. 2; 10
- Tension, unloaded**
- final, definition of, Sec. 2; 13
 - initial, definition of, Sec. 2; 13
- Terminal, cable**, definition of, Sec. 2; 5
- Terminations, conductor**, 164; 62
- Terminations, underground supply cable**, Sec. 37; 241
- clearances in enclosures or vaults, 373; 241
 - grounding, 374; 241
 - identification, 372; 241
 - support, 371; 241
- Terms**, definitions of, Sec. 2; 5
- Tests**
- for gas in manholes and unventilated vaults, 423B; 257
 - insulation, 274; 214

- Tests (continued)**
 lines and equipment
 when in service, 214A, 313A; 70, 220
 when out of service, 214B, 313B; 71, 220
 protective devices, 411C; 250
- Third rails, 225C; 80**
- Total sag, definition of, Sec. 2; 11**
- Total sag, maximum, definition of, Sec. 2; 11**
- Totalizing microwave radios, 180E1; 66**
- Towers. See Supporting structures**
- Traffic signals, 238, Table 238-2, 239G; 163, 164, 167**
- Training, 446A; 278**
- Transferring (fall protection), definition of, Sec. 2; 13**
- Transformer vault, definition of, Sec. 2; 13**
- Transformers, Sec. 15; 60**
 current-transformer secondary circuits
 protection when exceeding 600 V, 150; 60
 grounding secondary circuits of instrument transformers, 151; 60
 instrument, 93C3, 151; 20, 60
 location and arrangement of power transformers and regulators, 152; 60
 indoor installations, 152B; 60
 outdoor installations, 152A; 60
 short-circuit protection, 153; 61
- Transitioning (fall protection), definition of, Sec. 2; 13**
- Transverse loading, assumed, 252B; 194**
 at angles, 252B3; 195
 conductors, 252B1; 194
 messengers, 252B1; 194
 span lengths, 252B4; 195
 structure, 252B2, 261A3; 194, 201
- Traveled way, definition of, Sec. 2; 13**
- Trenching, 352A; 236**
- Trolley-contact conductors, 225A, Table 233-1, 234A3, 234D2, 238C, 239G, 241C3b, 242B, 243, 261H3; 79, 104, 110, 114, 163, 167, 171, 172, 176, 205**
- Tunnels, 320A4, Sec. 39; 223, 244**
- U**
- Underground communication lines, Part 3; 219**
 accessibility, 312; 220
 application of rules, 302; 219
 direct buried cable, Sec. 35; 234
 deliberate separations, 353; 237
 installation, 352; 236
 random separation, 354; 237
 routing, 351; 235
 symbols for identification, Fig. 350-1; 234
 equipment, Sec. 38; 242
 design, 381; 242
 grounding, 384; 243
 identification, 385; 243
 installation, 383; 243
 location in underground structures, 382; 243
 general requirements, Sec. 31; 220
 grounding, 314; 221
 circuits, 314C; 221
 conductive parts to be grounded, 314B; 221
 methods, 314A; 221
 induced voltage, 316; 222
 inspection
 when in service, 313A; 220
 when out of service, 313B; 220
 installation, 311; 220
 maintenance, 311; 220
 operating procedures, 423; 257
 protective requirements, 315; 221
 purpose of Code, 300; 219
 risers, Sec. 36; 240
 installation, 361; 240
 pad-mounted; 363; 240
 pole, 362; 240
 scope of Code, 301; 219
 supply cable
 cable accessories and joints, 333; 229
 sheaths and jackets, 331; 229
 shielding, 332; 229
 terminations, Sec. 37; 241
 tunnels, installation of, Sec. 39; 244
 environment, 391; 244

- underground structures, cable in, *Sec. 34*; 231
 - bonding, 342; 232
 - communication cables containing special supply circuits, 344; 233
 - fireproofing, 343; 232
 - grounding, 342; 232
 - installation, 341; 231
 - in manholes and vaults, 341B; 231
 - Underground electric supply lines, Part 3**; 219
 - accessibility, 312; 220
 - application of rules, 302; 219
 - direct buried cable, *Sec. 35*, 234
 - deliberate separation, 353; 237
 - installation, 352; 236
 - random separation, 354; 237
 - routing, 351; 235
 - symbols for identification, *Fig 350-1*; 234
 - equipment, *Sec. 38*; 242
 - design, 381; 242
 - grounding, 384; 243
 - identification, 385; 243
 - installation, 383; 243
 - location in underground structures, 382; 243
 - general requirements, *Sec. 31*; 220
 - grounding, 314; 221
 - circuits, 314C; 221
 - conductive parts to be grounded, 314B; 221
 - methods, 314A; 221
 - induced voltage, 316; 222
 - inspection
 - when in service, 313A; 220
 - when out of service, 313B; 220
 - installation, 311; 220
 - maintenance, 311; 220
 - operating procedures, 423; 257
 - purpose of Code, 300; 219
 - risers, *Sec. 36*; 240
 - installation, 361; 240
 - pad-mounted, 363; 240
 - pole, 362; 240
 - scope of Code, 301; 219
 - supply cable
 - cable accessories and joints, 333; 229
 - sheaths and jackets, 331; 229
 - shielding, 332; 229
 - terminations, *Sec. 37*; 241
 - tunnels, installation in, *Sec. 39*; 244
 - environment, 391; 244
 - underground structures, cable in, *Sec. 34*; 231
 - bonding, 342; 232
 - communication cables containing special supply circuits, 344; 233
 - fireproofing, 343; 232
 - grounding, 342; 232
 - installation, 341; 231
 - in manholes and vaults, 341B; 231
 - Underground grounding conductors, 93E**; 22
 - Ungrounded circuits, voltage of (definition), Sec. 2**; 14
 - Ungrounded system, definition of, Sec. 2**; 13
 - Uniform clearance calculations (adopted in NESC 2007 Edition), Appendix B**; 287
 - Uniform system of clearances (adopted in 1990 NESC Edition), Appendix A**; 281
 - Ungrounded system, definition of, Sec. 2**; 13
 - Units of measure, 17**; 3
 - Unloaded sag**
 - final, definition of, *Sec. 2*; 11
 - initial, definition of, *Sec. 2*; 10
 - Unloaded tension**
 - final, definition of, *Sec. 2*; 13
 - initial, definition of, *Sec. 2*; 13
 - Unloading facilities, flammable and combustible liquids, 127D**; 54
 - Urban districts, definition of, Sec. 2**; 13
 - Use, common, definition of, Sec. 2**; 5
 - Utility interactive system, definition of, Sec. 2**; 13
 - Utility, definition of, Sec. 2**; 13
 - Utilization equipment, definition of, Sec. 2**; 13
- V**
- Vaults. See Manholes, handholes, and vaults**
 - Vegetation management, 218**; 75
 - Ventilation, battery area, 142**; 58
 - Vertical clearance, 232, 233C, 234, 235C, 238**; 86, 99, 109, 137, 163
 - from live parts, *Fig 124-1, Table 124-1*; 42, 43

- Vertical loading component**, 251B1, 252A; 193, 194
- Vertical racks**, 235G; 141
- Voltage**
 definition of, Sec. 2; 13
 of circuit not effectively grounded, definition of, Sec. 2; 14
 of constant-current circuit, definition of, Sec. 2; 14
 of effectively grounded circuit, definition of, Sec. 2; 14
 to ground of conductor of grounded circuit, definition of, Sec. 2; 14
 to ground of conductor of ungrounded circuit, definition of, Sec. 2; 14
 to ground of grounded circuit, definition of, Sec. 2; 14
 to ground of ungrounded circuit, definition of, Sec. 2; 14
- W**
- Waiver of National Electrical Safety Code rules**, 14; 2
- Water lines, separation from underground lines**, 320B4, 354E; 224, 239
- Water piping systems as grounding electrodes**, 94A, 95B; 22, 26
- Water, clearance from**, 232, Table 232-1, Table 232-2; 86, 89, 95
 beaches, 234E2; 114
 swimming pools, 234, Fig 234-3, Table 234-3, 351C1; 109, 119, 131, 235
- Way, traveled**, definition of, Sec. 2; 13
- Weather loading**. See Loading, line
- Wind**. See Loading, line
- Wire gages**, definition of, Sec. 2; 14
- Wire wraps as grounding electrodes**, 94B4; 24
- Wire, buried, as grounding electrode**, 94B3a; 24
- Wire, span**, definition of, Sec. 2; 12
- Wood structures**, Table 253-2, 261A2, Table 261-1, Table 261-2; 198, 200, 207, 208
- Wording of National Electrical Safety Code rules**, 15; 2
- Work rules**. See Operation of electric supply systems, employee rules; Operation of electric supply systems, employer rules
- Working space**
 buckarms, location relative to, 237D, Fig 237-1; 162, 163
 dimensions, 237B; 162
 energized equipment
 guarding of, 237E; 162
 working clearances from, 237F; 163
 equipment 600 V or less, 125A; 51
 equipment over 600 V, 125B; 52
 location, 237A; 162
 vertical and lateral conductors, location relative to, 237C, 239B; 162, 165
- Worksite (fall protection)**, definition of, Sec. 2; 14

Procedure for revising the National Electrical Safety Code

1. Preparation of proposals for amendment

NOTE: The procedures for the collection of change proposals are subject to change as the revision of the 2012 Edition of the NESC approaches. Log on to the NESC Zone at <http://standards.ieee.org/nesc/> for updates.

- 1.1 A proposal may be prepared by any
 - a. Substantially interested person
 - b. Interested organization
 - c. NESC Subcommittee
 - d. Member of the NESC Committee or its subcommittees
- 1.2 Change proposals shall be submitted to the Secretary of the National Electrical Safety Code Committee via the URL <http://standards.ieee.org/nesc/rp/welcome.html>, using the change proposal form on the Web site.
- 1.3 Each separate topic shall begin on a separate form and shall only address one rule, unless a change in a rule directly affects another rule. If a proposal references documents not readily available to all subcommittee members, sufficient copies of the referenced documents to supply the subcommittee must be furnished.
- 1.4 The proposal shall consist of
 - a. A statement, in NESC rule form, of the exact change, rewording, or new material proposed
 - b. Words to be deleted shall be indicated via strike-throughs and words to be added shall be underlined.
 - c. The name of the submitter (organization or individual as applicable)
 - d. Supporting comments, giving the reasons why the NESC should be revised

Note: A change proposal will not be accepted if these steps are not followed.

2. The NESC Secretary will

- a. Acknowledge receipt of proposals for revision
- b. Distribute to each member of the appropriate NESC Subcommittee all of the proposals received, arranged in a coordinated sequence

3. Subcommittee Recommendation

The NESC Subcommittee responsible will consider each proposal and take one or more of the following steps:

- a. Endorse the proposal as received.
- b. Prepare a proposed revision or addition for the NESC (this may be a coordination of several comments or a committee consensus on a modification of a proposal).
- c. Refer the proposal to a technical working group for detailed consideration.
- d. Request coordination with other NESC Subcommittees.
- e. Recommend rejection of the proposal, for stated reasons.

For each item, the responsible subcommittee shall prepare a voting statement, accompanied by all members' statements concerning their votes (cogent reasons are required for negative votes). Steps (c) and (d) are intended to result, eventually, in a proposal of category (b).

Action under steps (c) or (d) shall be completed and reported to the subcommittee before the end of the public review period if the item is to be included in the upcoming revision.

4. Preprint of proposals

The NESC Secretary shall organize and publish a preprint of the proposed revisions including

- a. The original proposal as received from the submitter.
- b. The recommendation of the subcommittee with respect to the proposal (including a voting statement and subcommittee members' statements).
- c. Copies of submittal form for comments.

The Preprint shall be distributed to all members of NESC Subcommittees and representatives of organizations comprising the NESC Committee. Copies shall be available for sale to other interested parties. Notice of availability of the Preprint shall be submitted to ANSI for publication in ANSI Standards Action. The Preprint shall carry information on how to submit comments on the proposals and the final date for such submissions.

5. Final processing of proposed revisions and comments

- 5.1 Following the public review period, the Secretary shall organize and distribute for subcommittee consideration all comments received electronically via the following URL: <http://standards.ieee.org/nesc/tp/welcome.html>.
- 5.2 The Preprint and the comments received shall be reconsidered by the subcommittees. No new change proposals may be considered.

- a. The subcommittee may recommend adoption or rejection of the proposal by majority vote.
- b. When extended technical consideration or resolution of differing or conflicting points of view is necessary, the subcommittee shall refer the problem to a working group of the subcommittee for proposed resolution. If expeditious resolution is not possible, the subject shall be held on the docket.

Each working group shall provide, to its parent subcommittee, recommendations on matters considered as a result of subcommittee referrals under items 3(c) and 5.2(b).

Each subcommittee shall prepare a report showing its proposed revisions and all items held on the docket together with a plan for their disposition.

- 5.3 The Secretary shall provide commenters with copies of actions taken on the rules affected by their comments, and shall make all such reports available for examination upon request.

6. Final approval

- 6.1 Based upon the subcommittee reports, the Secretary shall prepare a draft of the revision of the NESC and distribute copies to
 - a. The NESC Committee for approval by a six-week letter ballot
 - b. The ANSI Board of Standards Review for concurrent 60-day public review
- 6.2 Comments received in response to the letter ballot and public review shall be referred to the Executive Subcommittee for resolution or referral to the appropriate subcommittee. Those items on which consensus cannot be reached shall be referred to the appropriate subcommittee for consideration during the next revision cycle. Unless a consensus for revision is established, the requirements of the current edition shall carry over to the proposed edition.

Time schedule for the next revision of the National Electrical Safety Code

The revision schedule for the 2012 NESC is as follows:

17 July 2008	Final date to receive change proposals from the public for revision of the 2007 Edition of the NESC, preparatory to the publication of a 2012 Edition.
September–October 2008	NESC Subcommittees consider change proposals to the NESC and prepare their recommendations.
1 September 2009	Preprint of the change proposals for incorporation into the 2012 Edition of the NESC published for distribution to the NESC Committee and other interested parties. This opens the comment period, by interested parties, on the submitted change proposals and the subcommittee recommendations.
1 May 2010	The final date to submit comments on the submitted change proposal and the subcommittee recommendations. All comments and recommendations on these proposals are due to the Secretary, NESC Committee.
September–October 2010	Period for NESC Subcommittee Working Groups and NESC Subcommittees to reconsider all recommendations concerning the proposed amendments and prepare final report.
15 January 2011	Proposed revision of the NESC, Accredited Standards Committee C2, submitted to NESC Committee for letter ballot and to ANSI for concurrent public review.
15 May 2011	NESC Committee approved revisions of the NESC submitted to ANSI for recognition as an ANSI standard.
1 August 2011	Publication of the 2012 Edition of the NESC.

Working Group assignments and activities for the 2012 Edition

Subcommittee 1, Coordination (SC1)

Working Group 1.10, Definition and use of grounding terms. A WG of Subcommittee 1 was formed to clarify what is meant by the terms “grounded,” “effectively grounded,” etc., as relating to neutral conductors.

Chair: John Dagenhart (there has been a change in chairs)

Working Group 1.11, Inspection rules—for the 2012 Edition of SC2, SC3, SC4, SC7, and SC5 to address their own inspection rules with the intent to have uniform language for station, overhead line, and underground line inspection rules where the requirements are the same.

Chair: Jack Christofersen

Each SC chair to assign SC members to the WG. Allen Clapp suggested this WG at our October 2003 SC1 meeting to revise. Rule 121 to have inspections consistent with other parts of the code. This should only require a change proposal for the 2012 Edition.

Subcommittee 2, Grounding Methods (SC2)

Working Group 2.2, Steel poles as made electrodes. A WG was formed to investigate the feasibility of accepting steel poles as a man-made electrode.

Chair: John Dagenhart

Subcommittee 3, Electric Supply Stations (SC3)

Will form a WG to review the following references where it directly affects a rule for possible updating:

- ANSI/ASME B15.1 (Labbe)
- NFPA 70, NEC, Articles 500-517 (Tomaseski)
- NFPA 8503 (Labbe)
- ASTM D3175 (Winoski)
- NFPA 496 (Winoski)
- NFPA 58, 59, 59A (Kollman)
- API RP 500 (Kollman)
- ASTM D178 (Tomaseski)

Working Group 3.1, to address Table 111-1

Chairs: Robert Saint and Gary Engmann

Work Group 3.2, Inside fence clearances

Alton Comans will head a WG to develop a TIA to address this issue.

Chair: Alton Comans

Subcommittee 4, Clearances—Overhead Lines (SC4)

Working Group 4.8, Aerial facilities clearances—Disbanded

Working Group 4.9, Wire, conductor, and cable terminology. Subcommittee 4 created a WG to address the use of terms line wires, conductors, and cables.

Chair: Stephen Olinick

Members: Eric Engdahl and Chuck Amrhym

Working Group 4.10, New ice loads and clearances—Disbanded

Working Group 4.11, Vegetation management. Communicate with organizations and agencies significantly involved in establishing and/or implementing utility vegetation management practices and or policies. Determine vegetation management practices and/or policies necessary within the NESC for the safety of employees and the public. Develop a recommendation and rationale for revision to Rule 218 to accomplish the above for the 2012 Edition.

Chair: Eric Engdahl

Members: Tom Phillip and Keith Reese

Working Group 4.12 to revise Rules 235 and 238

Chair: Mickey Gunter

Members: Allen Clapp, Keith Reese, Rex Bullinger, Don Hooper, and Dennis Henry

SC4 request that SC5 join a subcommittee to look at the issue of removing the k-factor. Larry Slavin

Subcommittee 5, Overhead Lines—Strength and Loadings (SC5)

Working Group 5.1, Coordination of continuity of Sections 24, 25, and 26

Scope: To examine the appropriate placement of existing requirements of Sections 24, 25, and 26 and develop a basis for coordinating the relative values of present and future requirements for loading factors, material strength factors, importance factors, and similar requirements that will assure appropriate results from the present or from a possible future calculation system.

Chair: L. Kempner

Members: Bingel, Clapp, Clem, Heald

Task Forces

5.1.1 Load duration effects on material strength properties—Active

Scope: Review load duration effects on the strengths of various materials and make recommendations as may be appropriate for NESC to address these effects if any. Materials to be considered include, but not necessarily limit to, wood poles and crossarms, fiber-reinforced composites.

Members: Chair Kluge, Bingel, Rollins, Shultz

5.1.2 Review 60 ft exemption—Disbanded

Scope: To review and develop, if necessary, a change proposal to address the appropriate application of extreme winds below 60 ft.

Members: Chair D. Heald, Amato, Amrhyn, Bingel, Bishop, Bullinger, Corzine, Hensel, Jones, Kempner, Kinghorn, Rempe, Shultz, Slavin, Stanford, Wong

5.1.3 Inconsistencies of Sections 24, 25, and 26—Disbanded

Scope: Review and identify content of existing Sections 24, 25, and 26 that are inconsistent and develop change proposals to correct identified issues.

Members: Chair A. Clapp

5.1.4 Old/alternate vs. recommended method—Disbanded

Scope: Submit change proposal to remove the Alternate Method. SC 5 directed that this change proposal be submitted for the 2002 version.

Members: Chair R. Kluge

5.1.5 Review/update, as required, the extreme wind methodology—Active

Scope: Review current extreme wind methodology within the current NESC Code. The purpose of this review will determine if the methodology is consistent with national and international wind engineering practice as applied to distribution and transmission line facilities. An attempt will be made to provide a simplified approach, which is consistent with the recommended methodology.

Members: Chair L. Kempner, Kluge, Wong, Bingel, Fuller, Burley, Lacoursiere-Canada Liaison, Shultz, TBD (Peyrot, Peterka, Ghannoum, Others???)

5.1.6 Ice loading—Disbanded

Scope: To develop a change proposal to utilize the ASCE 7 2002 ice map. Coordinate with WG 4.10 with efforts to incorporate the new ice map for sags and clearances.

Members: Chair C. Clem, Bishop, Freimark, Kathy Jones, Walt Jones, Kluge, Kamber, Schwalm, Shultz, Slavin

5.1.7 Fiber-reinforced polymer structures and components—Disbanded

Scope: To review and develop if necessary, a change proposal to address the load and resistance factors for fiber-reinforced structures and components. This does not include changes to Rule 277 (Insulators).

Members: Chair Nelson Bingel, Glenn Barefoot, Brendan Conley, Jim Davidson, Fouad Fouad, Dick Hensel, Wes Oliphant, Joe Reilly, Doug Sherman, Wade Shultz, Larry Slavin, Dick Stanford

5.1.8 Grade B vs. Grade C reliability—Active

Scope: To review and develop, if necessary, change proposals to the load and strength factors for Grade B and C construction. Review and recommend as a separate change proposal appropriate loads and strength factors for Grade B and C vertical loads.

Members: Chair N. Bingel, Aichinger, Clapp, Dagher, Freimark, Kluge, Lacoursiere, Rollins, Slavin, Wong

5.1.9 Conductor tension limits—Active

Scope: To review and develop appropriate conductor tension limits for Grade B and C construction to limit the opportunity for aeolian vibration. Review and recommend as a separate change proposal conductor tension limits for Grade B and C vertical loads.

Members: Chair B. Freimark, Havard

5.1.10 Correlation of NESC with changes in ANSI O5.1 and related documents—Active

Scope: To review ANSI O5.1-2002 and develop appropriate changes in the NESC

Members: Chair N. Bingel, Heald, Kluge, Lash, Slavin

5.1.11 Eliminate the conductor constant (k-factor)

Scope: TBD

Members: Co-chairs Leon Kempner and Jerry L. Reding, Larry Slavin

Working Group 5.2, Complete revisions of Sections 25 and 26—Disbanded

Scope: To continue to review 2002 CP 2372 to finish development of the new calculation methodologies.

Members: Chair R. Peters, Aichinger, Bingel, Bullinger, Clem, Denbrock, DeSantis, Freimark, R. Fuller, David Grooms, Harrel, Hensel, Kempner, Kientz, Kluge, Oedermann, Rempe, Rojas, Slavin, Stanford, Wong

Working Group 5.6, Line insulation—Active

Scope: Continuing review of overhead line insulation component performance, analysis of insulator problems due to component age and other factors, along with the recommendations for appropriate recognition of newly developing synthetic insulating components and the appropriate methods to test for normal and extreme loading conditions.

Members: Chair A. Schwalm

Task Forces

5.6.1 Coordinate changes/improvements—Active

Scope: To coordinate changes in NESC rules with changes and improvements in insulator technology, reliability, etc.

Members: Chair A. Schwalm, Kluge

5.6.2 Test methods/extreme loading—Active

Scope: To coordinate changes in NESC rules with changes and improvements in insulator testing methods and improvements in extreme loading capabilities.

Members: Chair A. Schwalm

Working Group 5.7, Seminars and presentations—Active

Scope: To develop panel sessions to explain the changes in the NESC 2007 Edition to industry and the public.

Chair: L. Slavin

Task Forces

5.7.1 Seminars—Active

Scope: To present seminars on prospective code changes.

Members: Chair L. Slavin, additional as necessary

5.7.2 Solicit comments on WG 5.2 methodology—Disbanded

Scope: To present seminars and otherwise solicit comments on new calculation methodology.

Members: Chair L. Slavin, additional as necessary

Working Group 5.8, Liaison with ASCE Committee on pole reliability based design—Active

Scope: To monitor and assist the activities of the ASCE RBD committee and provide NESC SC5 with appropriate information and data with which to determine and develop appropriate changes to the 2012 NESC.

Members: Chair B. Lacoursiere, Bingel, Freimark, Kempner, Kluge, Rollins, Slavin

Working Group 5.9, Liaison with SC1 WG on coordination between NESC and ASCE 7—Active

Scope: To review areas in NESC and ASCE 7 that either overlap or complement, to assure that duplication and confusion are limited.

Members: Chair Bingel, Amrhyn, Heald, Kempner, Wong

Subcommittee 7, Underground Lines (SC7)

Working Group 7.6, Separation distance of conduit and gas Lines. Will look into the separation distance between conduit and gas lines. Also look at color coding and markings for conduit and direct burial cable. Look at the definition of duct, conduit, and duct bank.

Chair: Mickey Gunter

Members: Michael Pehosh, Mike Dyer, Tim Robeson, Dennis Henry, Monte Szendre, John Spence, and Trevor Bowmer

Subcommittee 8, Work Rules (SC8)

The following WGs were formed to address unresolved CPs:

Working Group 8.10, Maximum use voltage for rubber insulating gloves. Will address issues concerning CP 2820.

Members: Brian Erga, Gene Tootle, Ken Brubaker, Steve Theis, Tom Verdecchio, Robert Fass, Wayne Blackley, Brent McKinney, Albert Smoak, Sam Stonerock, Jeff White, David Wallis, Jim Tomaseski, Mike Granata

Working Group 8.11, to address “in the vicinity of.” Completed CP 2640 and CP 2564.

Chair: Kientz

Working Group 8.12, to address altitude adjustment for min approach distance. Completed CP 2524.

Working Group 8.13, to address maximum use voltage. Completed CP 2562, CP 2563, CP 2627, CP 2628, CP 2816, CP 2817, CP 2818, and CP 2820.

Chair: Theis

WGs have submitted revised CPs and have been acted on by Subcommittee 8 for inclusion in the preprint for the 2007 Edition.

OSHA 1910.269/Subpart V—David Wallis reviewed the status of the revision to these standards and where the process will go from this point.

SUMMARY OF RULE

The rule requires electrical cooperatives and municipally owned electric utilities to annually report the ways in which their systems are designed and constructed to address the effects of extreme weather events; annually report on their vegetation management practices; and annually report their facilities inspection practices.

SUMMARY OF HEARINGS ON THE RULE

A rule hearing was held October 4, 2006. Prior to the hearing, the Commission's staff and representatives of the electrical cooperatives and municipally owned electric utilities were able to negotiate alternative rule language which accomplished the purpose and intent of the rule as proposed. At the rule hearing, the Commission voted to adopt the rule, and to substitute the alternative negotiated language for the language as originally proposed and published.

FACTS AND CIRCUMSTANCES JUSTIFYING THE RULE

As a result of the past two storm seasons, and the severe damage done to the State by hurricanes, the Commission determined that increased electrical infrastructure reliability is needed. This rule is intended to result in the reporting of efforts electrical cooperatives and municipally owned systems are taking to reduce or mitigate damage from extreme weather events, so that the Commission can determine whether additional steps are needed to ensure the integrity of Florida's electrical grid following extreme weather events.