

State of Florida



FPSC
AM 11: 02
COMMISSION
CLERK

Public Service Commission

CAPITAL CIRCLE OFFICE CENTER • 2540 SHUMARD OAK BOULEVARD
TALLAHASSEE, FLORIDA 32399-0850

-M-E-M-O-R-A-N-D-U-M-

DATE: September 18, 2008
TO: Ann Cole, Commission Clerk, Office of Commission Clerk
FROM: Katherine Fleming, Senior Attorney, Office of General Counsel *KEF*
RE: Docket No. 070626 – EI - Review of Florida Power & Light Company's Sunshine Energy Program.

Please place the attached documents, which are FPL's responses to Staff's Data Request dated September 5, 2008, in the above-referenced docket file. Thank you.

KEF/tfw

DOCUMENT NUMBER-DATE
08787 SEP 18 8
FPSC-COMMISSION CLERK

Q.

Please provide evidence of any monitoring FPL conducted of Green Mountain during the life of the contract including, but not limited to, any audits performed or reviews of marketing materials.

A.

FPL monitored the activities of Green Mountain in a variety of ways. Quarterly meetings were held to review the program performance. Annual meetings were held to analyze the previous year's performance and to lay out activities for the new year. All marketing materials were reviewed to ensure consistency with the approved message map. A message map per the contract is defined as "a document that contains Marketing communication messages and claims that have been approved by both Parties for use in any and all Marketing materials."

All marketing materials were reviewed again once individual direct mail or press releases were developed. Weekly meetings were held to discuss program status and issues. There were also frequent calls between FPL and Green Mountain as the need arose.

The review of all marketing material was done in the following manner. Draft marketing material was sent by Green Mountain to FPL's Marketing and Product Management Departments for review. FPL reviewed the draft language to ensure that it was consistent with the message map including disclosure requirements approved by the PSC Staff. Feedback was provided to Green Mountain by FPL to prepare a final version for FPL's approval.

As an example, attached are copies of FPL's internal monthly program monitoring reports that show for 2004, 2005, 2006, 2007 and year-to-date 2008 monitoring. These reports are done on a monthly basis and updated each month for each year. Attestation statements, which were previously provided to the FPSC Staff, were obtained for all previous year's REC purchases to confirm that REC requirements were satisfied.

Programs of this type need a critical mass of participants in order to generate funds sufficient to make a difference. The only way to achieve critical mass is to tell people about the availability of the new program. That's exactly what happened. In fact, the marketing efforts were tremendously successful. As subscriptions increased, the purchase of renewable energy credits significantly increased, growing from 51,538 in 2004 to 373,596 in 2007, or more than 952,000 since inception, making this the fourth largest program in terms of REC purchases in the United States in 2007.

DOCUMENT NUMBER-DATE

08787 SEP 18 3

FPSC-COMMISSION CLERK

FPSC

DATA

REQUEST

NO. 1

5 ATTACHMENTS

2006
YTD ENROLLMENTS
DECEMBER

2006 Sunshine Energy Participants Program-To-Date

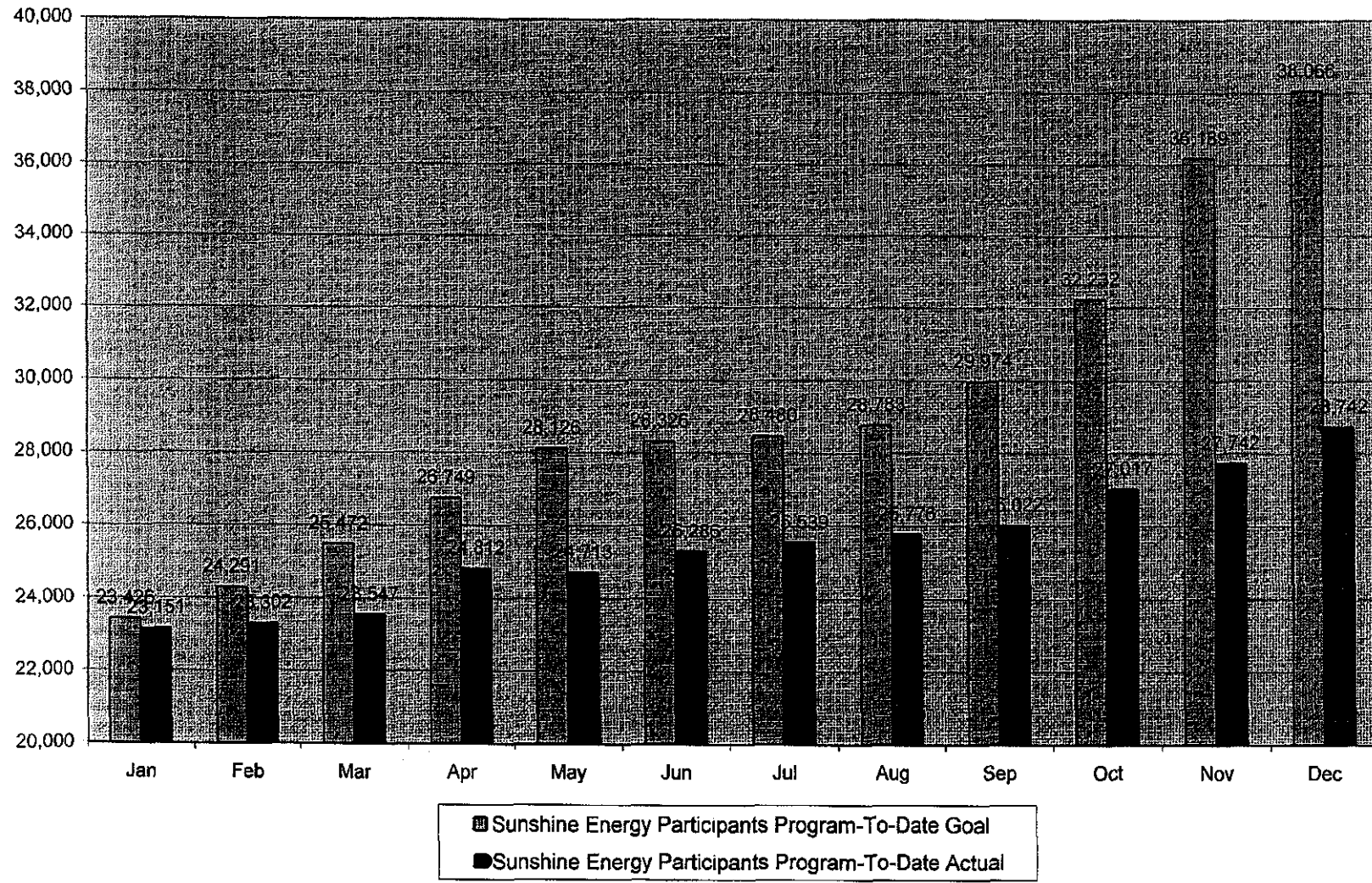

Sunshine Energy Enrollments - Program to Date / YTD / Channel

Original Marketing Plan Assumptions

Participants	Code	Jan		Feb		March		April		May		June		July		Aug		Sept		Oct		Nov		Dec	
		Goal	Actual	Goal	Actual	Goal	Actual	Goal	Actual	Goal	Actual	Goal	Actual	Goal	Actual	Goal	Actual	Goal	Actual	Goal	Actual	Goal	Actual	Goal	Actual
New Enrollments per CIS																									
TOTALS		360	419	865	428	1,181	444	1,277	1,527	1,377	183	200	911	154	539	303	660	1,192	503	2,258	1,282	3,957	932	1,877	1,125
Drops																									
Drops			-171		-138		-148		-132		-119		-127		-181		-182		-137		-141		-111		-104

Source: Datawarehouse Monthly Report
Sunshine Energy Enrollments by Channel

May 410 23275
24713

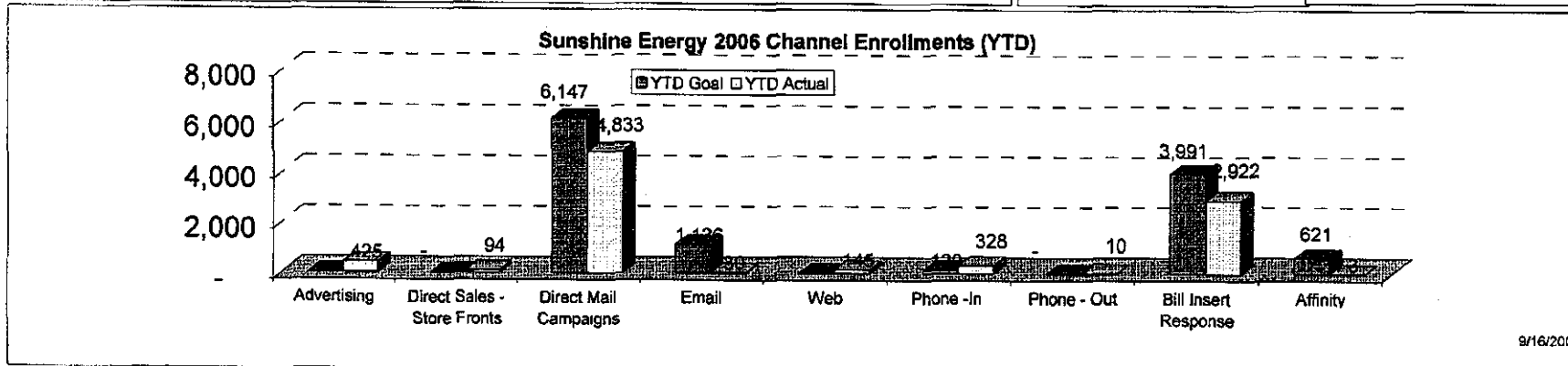
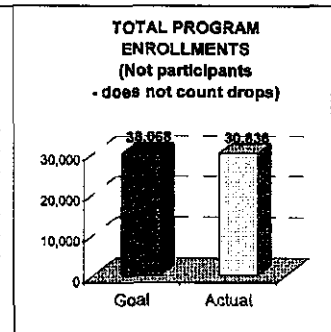
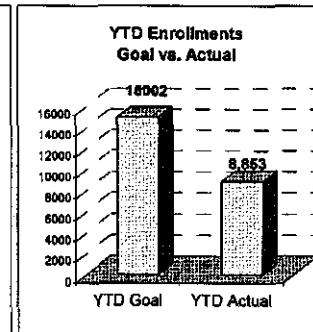
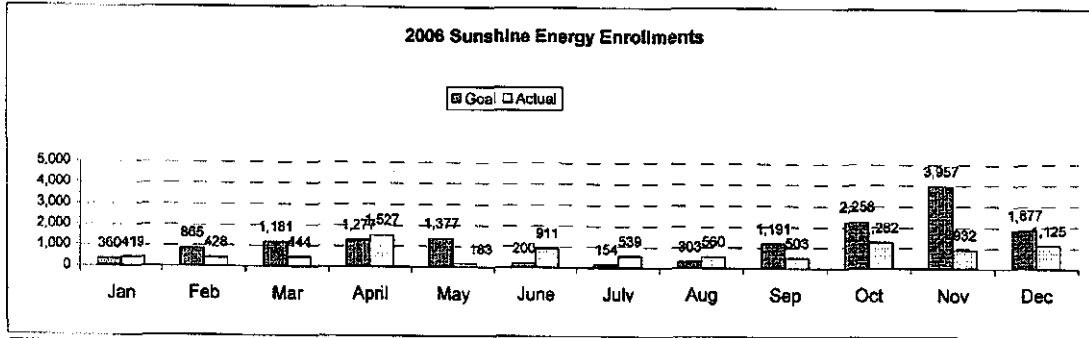

	Goal	Installs	Drops
Jan	360	419	-171
Feb	865	114	-138
Mar	1,181	444	-148
Apr	1,277	1,527	-132
May	1,377	183	-119
Jun	200	911	-127
Jul	154	539	-161
Aug	303	560	-152
Sep	1,191	503	-137
Oct	2,258	1,282	-141
Nov	3,957	932	-111
Dec	1,877	1,125	-104
Total	15,000	8,539	-1,641

Sunshine Energy Participants Program-To-Date

	Goal	Actual
Jan	23,426	23,151
Feb	24,291	23,302
Mar	25,472	23,547
Apr	26,749	24,812
May	28,126	24,713
Jun	28,326	25,286
Jul	28,480	25,539
Aug	28,783	25,776
Sep	29,974	26,022
Oct	32,232	27,017
Nov	36,189	27,742
Dec	38,066	28,742

2006 Sunshine Energy Enrollments

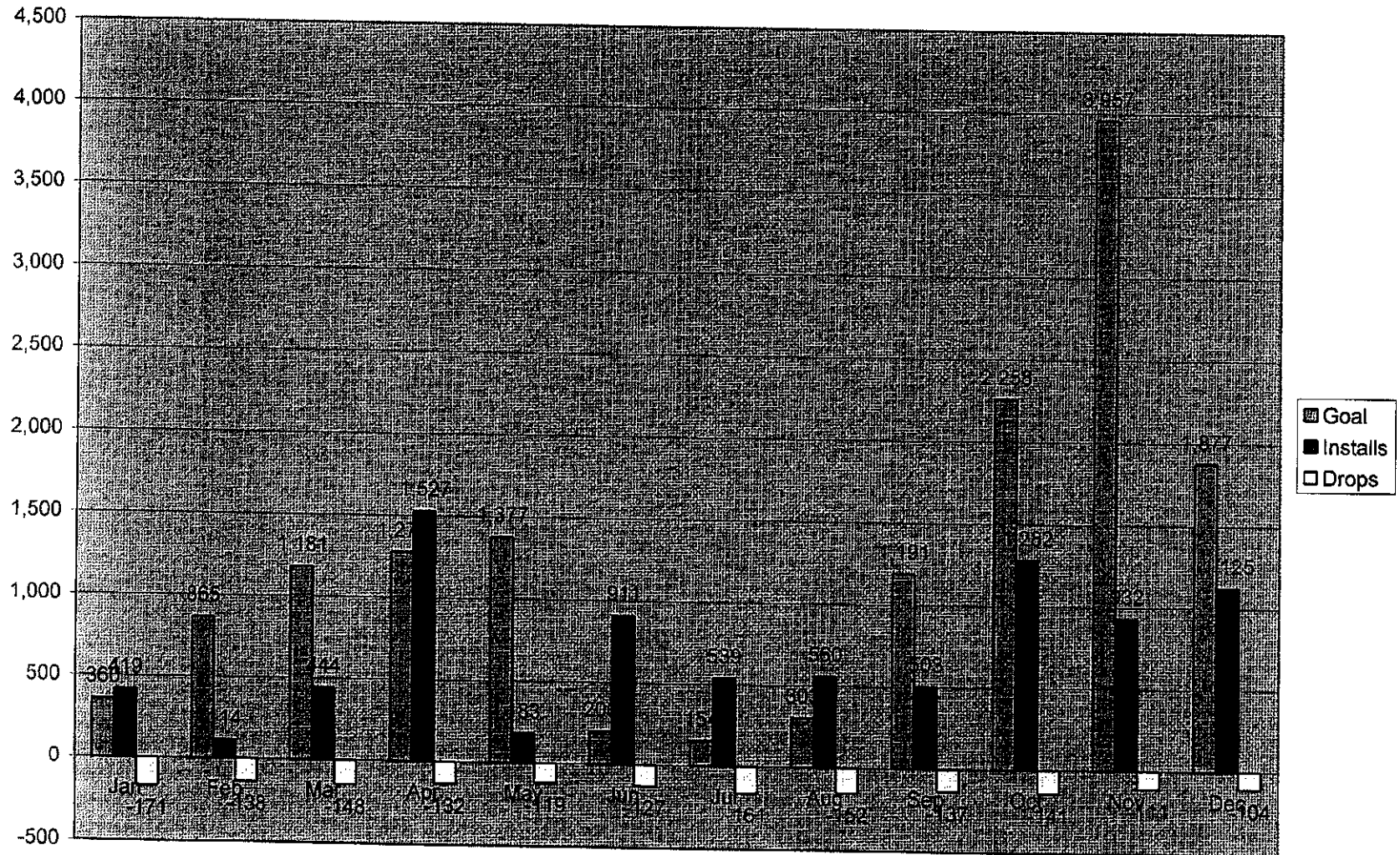

Green Power Project - 2006 Program Activity \$\$														
"SUNSHINE ENERGY"														
Account Description	Ferc Acct	TOTAL	Jan	Feb	Mar	Apr	May	Jun	Jul	Aug	Sep	Oct	Nov	Dec
Green Power Pricing-O&M Expenses	908.265	\$ 2,813,661	\$216,001	\$215,813	\$207,650	\$225,549	\$225,573	\$225,424	\$253,389	\$137,818	\$325,728	\$243,189	\$269,106	\$286,420
Green Power Pricing-P&W Benefits	926.211	\$ 7,632	\$384	\$399	\$393	\$404	\$808	\$2,580	\$404	\$634	\$404	\$404	\$606	\$404
GREEN PRICING PROGRAM		\$ 2,821,293	\$216,386	\$216,212	\$208,043	\$225,953	\$226,179	\$228,014	\$253,793	\$138,452	\$326,132	\$243,593	\$269,712	\$286,824
REVENUE ACCOUNTS:														
Res. Sales	440.030	(\$2,928,225)	(\$221,873)	(\$226,237)	(\$225,476)	(\$236,137)	(\$240,265)	(\$238,743)	(\$246,420)	(\$247,122)	(\$251,280)	(\$257,492)	(\$262,488)	(\$274,693)
Res. Sales - Public Authority	440.080	\$0												
Commercial Sales	442.130	\$0												
Commercial Sales - Public Authority	442.180	\$0												
Industrial Sales	442.230	\$0												
Industrial Sales-Public Authority	442.280	\$0												
Other Sales to Pub Authority	445.030	\$0												
Public Authority-Railway Sales	446.080	\$0												
REVENUES		(\$2,928,225)	(\$221,873)	(\$226,237)	(\$225,476)	(\$236,137)	(\$240,265)	(\$238,743)	(\$246,420)	(\$247,122)	(\$251,280)	(\$257,492)	(\$262,488)	(\$274,693)
Program Expenses - (Not of Revenues)		(\$106,932)	(\$5,487)	(\$10,025)	(\$17,432)	(\$10,184)	(\$14,086)	(\$10,730)	\$7,373	(\$108,670)	\$74,852	(\$13,899)	\$7,224	(\$5,869)

2006			
Month	Cash Received by FPL	Blocks Sold (MWh's)	Enrollments
Jan	\$228,740.39	23,460.55	419.00
Feb	\$223,578.46	22,931.12	428.00
Mar	\$223,915.75	22,965.72	444.00
Apr	\$238,597.18	24,471.51	444.00
May	\$238,737.00	24,485.85	183.00
Jun	\$237,462.79	24,355.16	911.00
Jul	\$248,785.29	25,516.44	539.00
Aug	\$242,814.29	24,904.03	560.00
Sep	\$248,108.85	25,447.06	503.00
Oct	\$253,804.51	26,031.23	1,282.00
Nov	\$283,904.24	29,118.38	932.00
Dec	\$283,773.73	29,105.00	1,125.00
YTD Actuals	\$2,952,222.48	302,792.05	7,770.00
Program to date	\$9,753,704.92	574,738.97	30,836.00

2004	\$4,611,880.78	47,372.39
2005	\$2,189,601.66	224,574.53

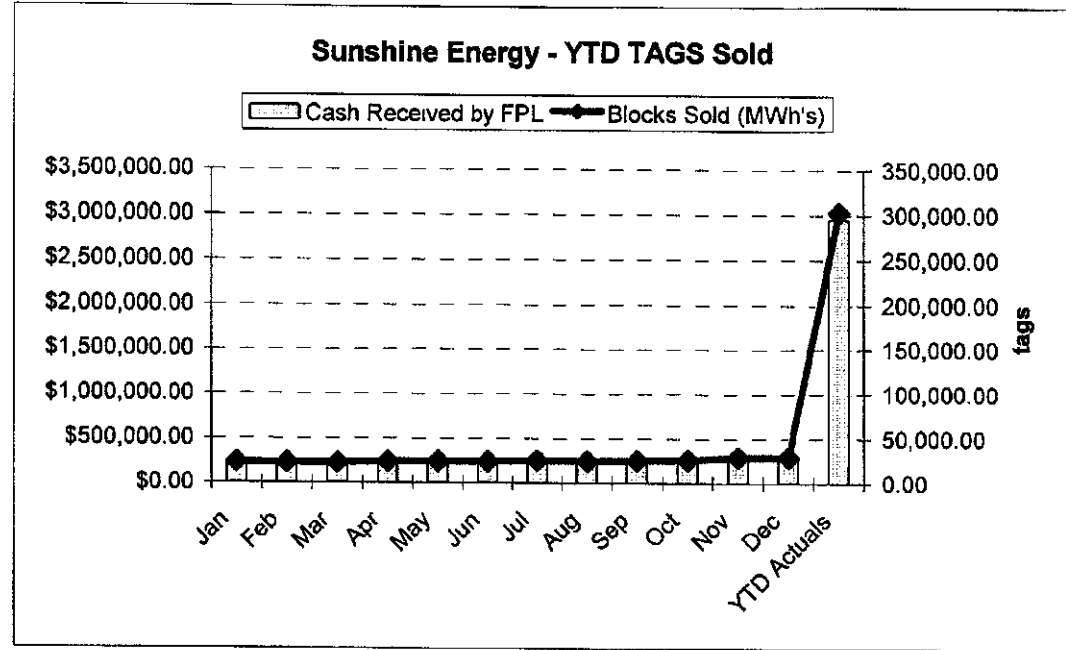

As filed with the 2005 ECCR Projection Filing

2005 Revenues	Proj. January	Proj. February	Proj. March	Proj. April	Proj. May	Proj. June	Proj. July	Proj. August	Proj. September	Proj. October	Proj. November	Proj. December	TOTAL
16. BuildSmart Program	0	0	0	0	0	0	0	0	0	0	0	0	\$ 0
17. Green Power Pricing (Sunshine)	(88,725)	(94,575)	(100,425)	(106,275)	(112,125)	(117,975)	(123,825)	(129,675)	(135,525)	(141,375)	(147,225)	(153,075)	\$ (1,450,900)
Total Program Revenues	\$ (88,725)	\$ (94,575)	\$ (100,425)	\$ (106,275)	\$ (112,125)	\$ (117,975)	\$ (123,825)	\$ (129,675)	\$ (135,525)	\$ (141,375)	\$ (147,225)	\$ (153,075)	\$ (1,450,900)

DUE DATE: JUNE 22, 2005

ENT - - ENTER ESTIMATES FOR JULY - DECEMBER - -

TO BE FILED WITH THE 2006 ESTIMATED/ACTUAL

2005 Revenues	Actuals January	Actuals February	Actuals March	Actuals April	Actuals May	Sub-Total Jan-May	Estimate June	Estimate July	Estimate August	Estimate September	Estimate October	Estimate November	Estimate December	Sub-Total July-Dec	2006 Est/Act Total
16. BuildSmart Program	(23,650)	(15,525)	(7,450)	(23,550)	(24,000)	(94,175)								\$ (94,175)	\$ (94,175)
17. Green Power Pricing (Sunshine)	(109,962)	(130,878)	(155,538)	(174,243)	(182,765)	(753,387)	(201,042)	(221,146)	(243,260)	(267,586)	(280,966)	(287,990)	(295,189)	\$ (2,560,965)	\$ (2,751,606)
Total Program Revenues	\$ (133,612)	\$ (146,403)	\$ (162,988)	\$ (197,793)	\$ (206,765)	\$ (847,562)	\$ (201,042)	\$ (221,146)	\$ (243,260)	\$ (267,586)	\$ (280,966)	\$ (287,990)	\$ (295,189)	\$ (2,644,740)	\$ (2,845,781)
														(1,598,137)	(2,845,781)

% Increase	
Total # of Customers	
Net from month to month	

June	July	Aug	Sept	Oct	Nov	Dec
110.00%	110.00%	110.00%	110.00%	105.00%	102.50%	102.50%
(20,620)	(2,682)	(24,960)	(27,445)	(28,817)	(29,537)	(30,276)
	(2,052)	(2,288)	(2,495)	(1,372)	(720)	(738)

2008
YTD ENROLLMENTS
JUNE

2008 Sunshine Energy Participation (Blocks) Program-To-Date Residential

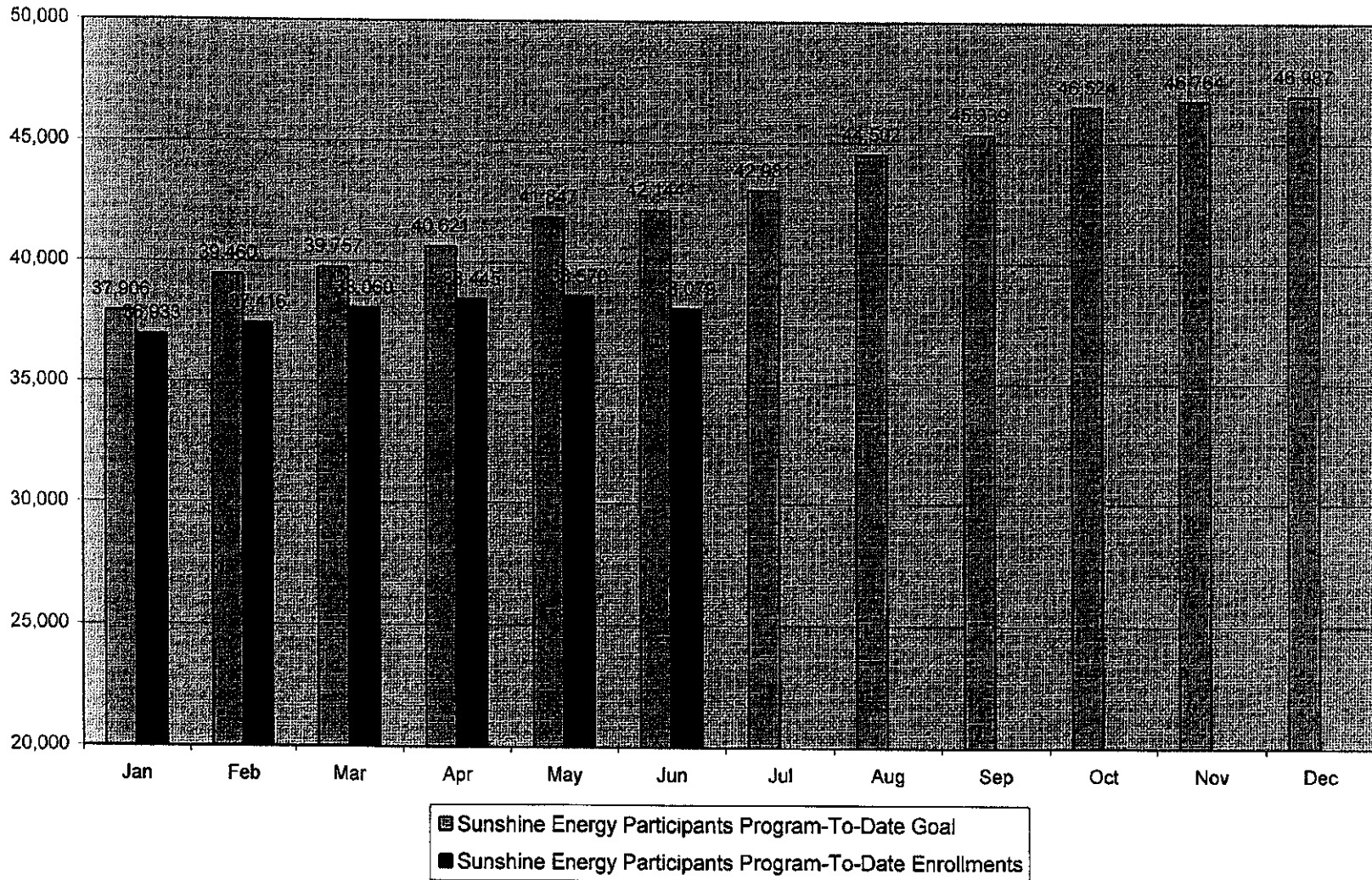

Sunshine Energy Enrollments - Program to Date / YTD / Channel

Original Marketing Plan Assumptions

Participants	Jan.		Feb.		March		April		May		June		July		Aug.		Sept.		Oct.		Nov.		Dec.		
	Goal	Actual	Goal	Actual	Goal	Actual	Goal	Actual	Goal	Actual	Goal	Actual	Goal	Actual	Goal	Actual	Goal	Actual	Goal	Actual	Goal	Actual	Goal	Actual	
New Enrollments per CIS	148	0	1,086	0	1,679	0	1,340	0	1,398	0	803	0	380	0	517	0	1,694	0	1,979	0	1,948	0	1,191	0	
Sales Channels	CODE																								
Advertising	AD																								
Direct Sales - Store Fronts	SF																								
Direct Mail Campaigns	DM			1,314					986						1,281					945					
Email	EM																								
Web	WB					57					57														
Phone - In	PI																								
Phone - Out	PO																								
Bill Insert Response	BI																								
Affinity	AF																								
Bangtail	BT	679																							
Door to Door	DD						624						597				597								
FPL Employee Signup	ZZ																								
Transfer of Service	ST																								
Re-Enrolling	RE																								
Online Movers/White Fnece	AC	120		120		120		120		120		120		120		120		120		120		120		110	
Energy Audit	EA																								
Refer A Friend	RF																								
Online New Service Connects	OC	120		120		120		120		120		120		120		120		120		120		120		113	
TOTALS		919	0	1,554	0	297	0	854	0	1,226	0	297	0	837	0	1,521	0	837	0	1,185	0	240	0	223	0

Drops

Source: Datawarehouse Monthly Report
Sunshine Energy Enrollments by Channel

410 23275
May 24713

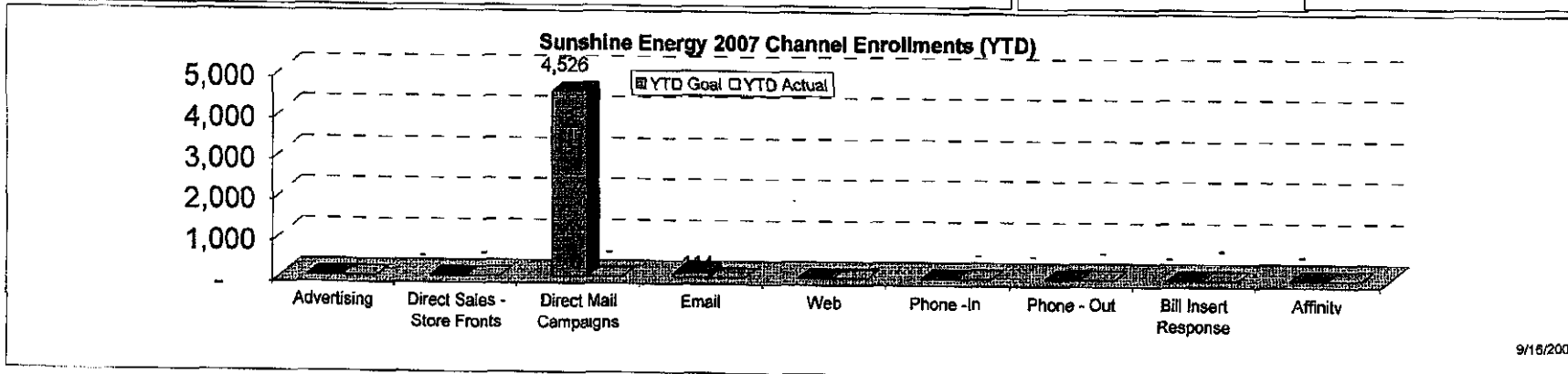
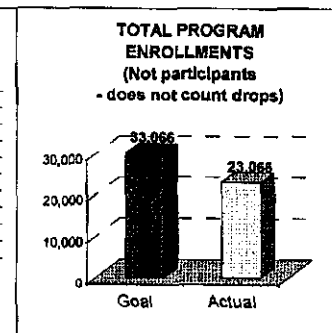
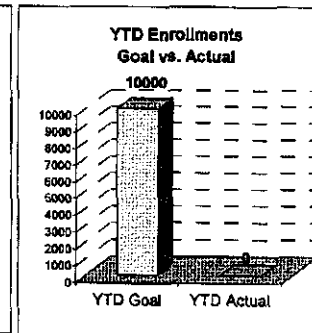
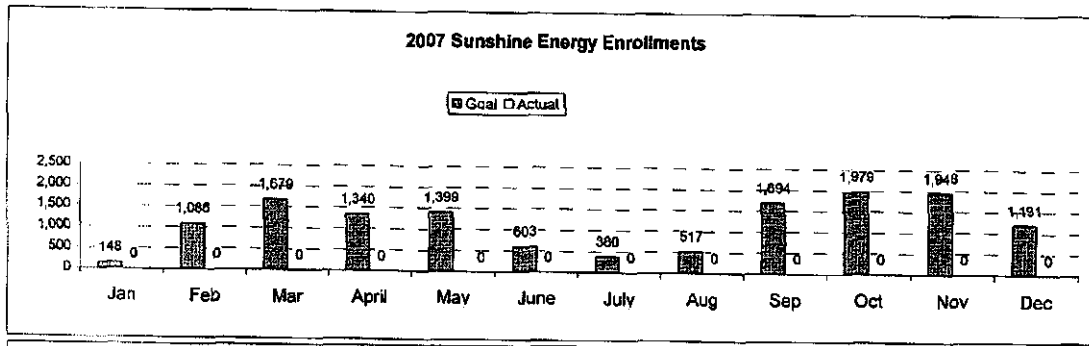

2008 Sunshine Energy Report

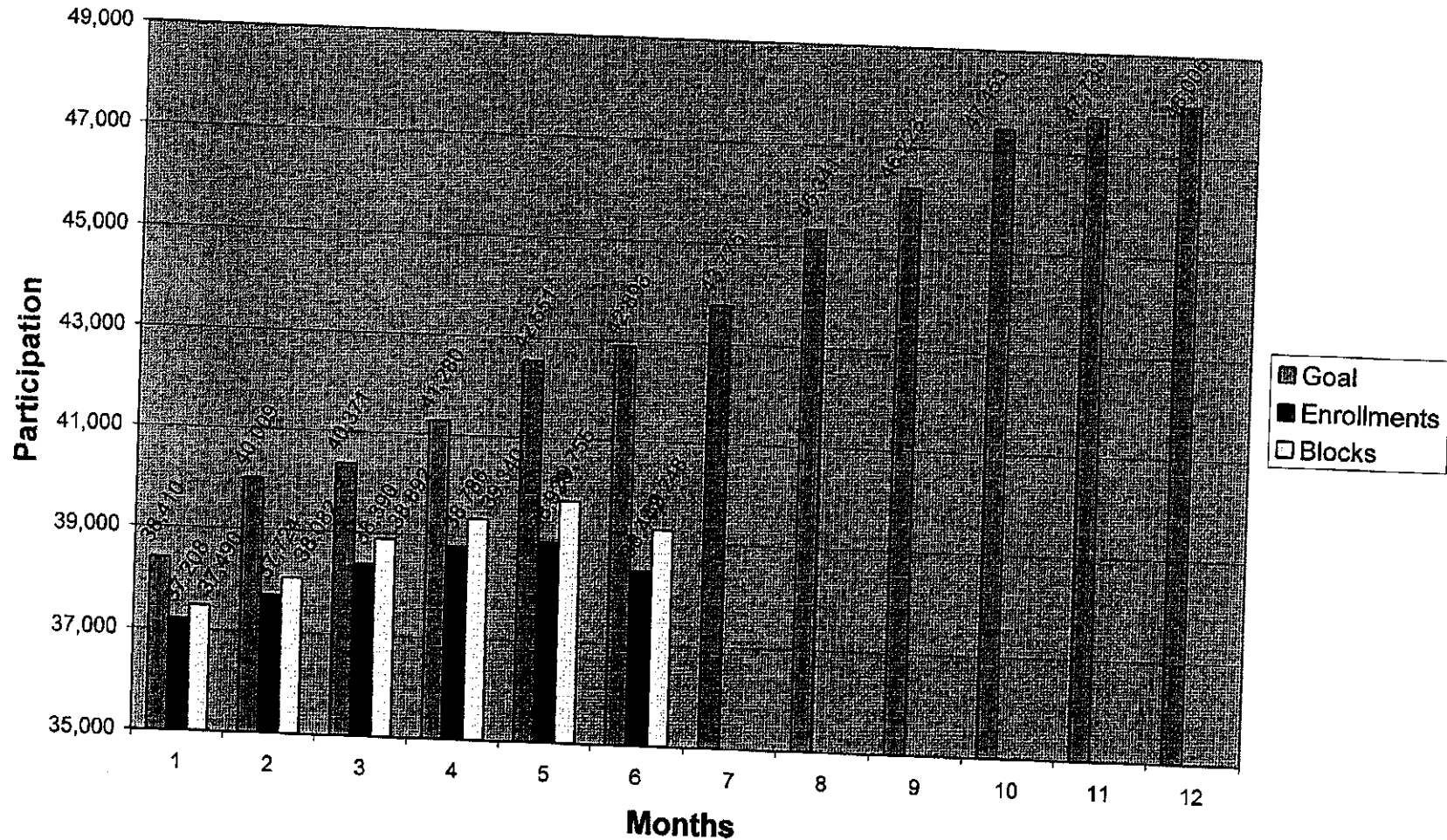

	Goal	Installs	Drops	
Jan	148	0	0	
Feb	1,086	0	0	
Mar	1,679	0	0	
Apr	1,340	0	0	
May	1,399	0	0	
Jun	603	0	0	
Jul	380	0	0	
Aug	517	0	0	
Sep	1,694	0	0	
Oct	1,979	0	0	
Nov	1,948	0	0	
Dec	1,191	0	0	107
Total	13,964	0	0	

Sunshine Energy Participants Program-To-Date				36987	3696	Combined		
	Goal	Enrollment	Blocks	Monthly Ct	Goal	Enrollment	Blocks	Goal
Jan	37,906	36,933	37,003		504	275	487	38,410
Feb	39,460	37,416	37,488	483	549	308	594	40,009
Mar	39,757	38,060	38,135	644	614	330	757	40,371
Apr	40,621	38,445	38,527	385	659	341	813	41,280
May	41,847	38,570	38,662	125	704	359	1,093	42,551
Jun	42,144	38,079	38,164	-491	749	363	1,084	42,893
Jul	42,981			-38,079	794			43,775
Aug	44,502			0	839			45,341
Sep	45,339			0	884			46,223
Oct	46,524			0	929			47,453
Nov	46,764			0	974			47,738
Dec	46,987			0	1019			48,006
							4155	

Dec-06
YE 28742

Enrollment Blocks

37,208	37,490
37,724	38,082
38,390	38,892
38,786	39,340
38,929	39,755
38,442	39,248
0	0
0	0
0	0
0	0
0	0
0	0

Adjusted

919	37906
1554	39460
297	39757
864	40621
1226	41847
297	42144
837	42981
1521	44502
837	45339
1185	46524
240	46764
223	46987

2008 Sunshine Energy Enrollments

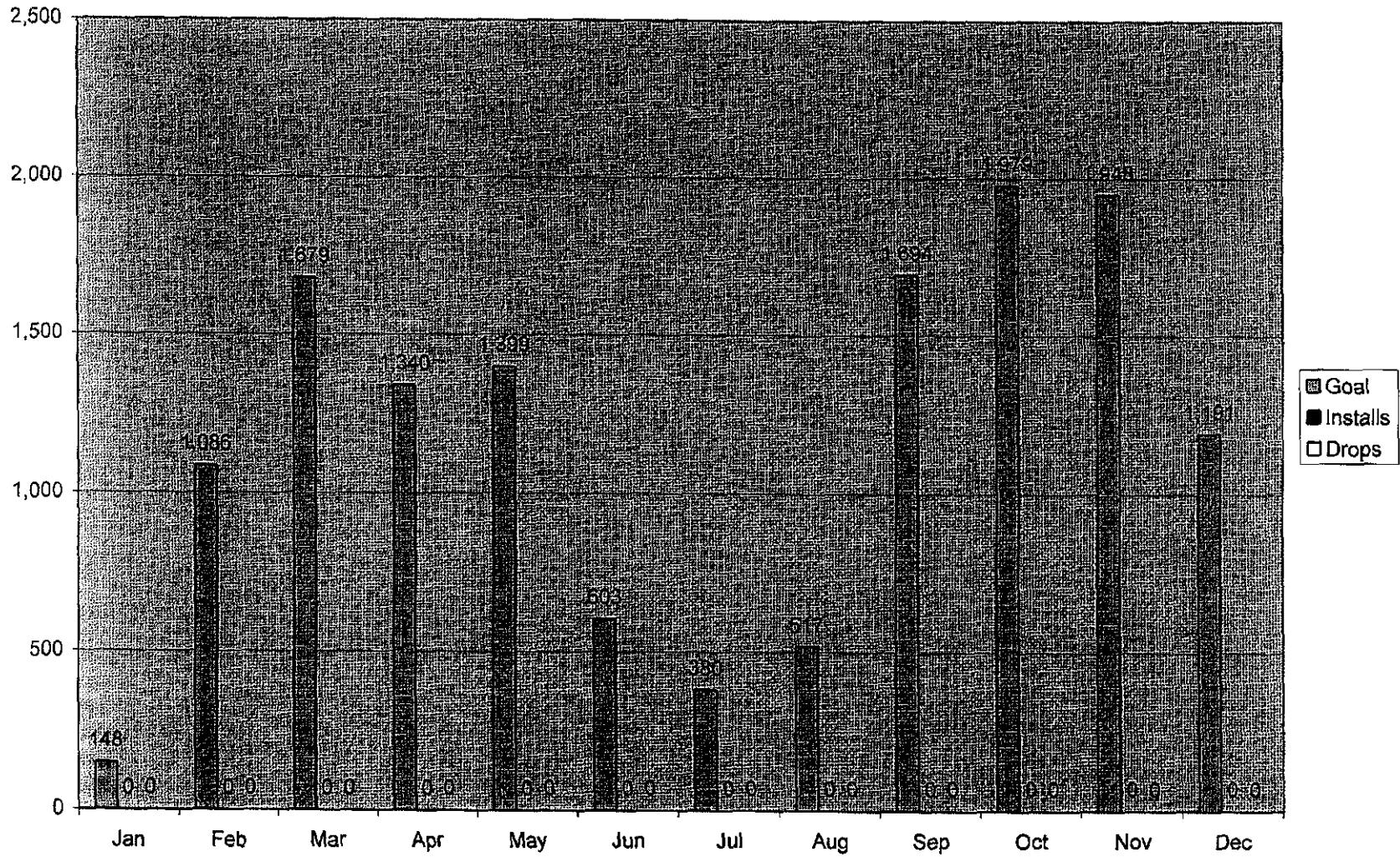

2007			
Month	Cash Received by FPL	Blocks Sold (MWh's)	Enrollments
Jan	\$264,428.90	27,120.91	0
Feb	\$282,470.94	28,971.38	0
Mar	\$302,385.71	31,013.92	0
Apr	\$310,398.30	31,835.72	0
May	\$351,103.52	36,010.62	0
Jun	\$288,286.10	29,567.81	0
Jul	\$0.00	0.00	0
Aug	\$0.00	0.00	0
Sep	\$0.00	0.00	0
Oct	\$0.00	0.00	0
Nov	\$0.00	0.00	0
Dec	\$0.00	0.00	0
YTD Actuals	\$1,799,073.47	184,520.36	0
Program to date	\$11,552,778.39	759,259.33	23,066

2004	\$4,611,880.78	47,372.39
2005	\$2,189,601.66	224,574.53
2006	\$2,952,222.48	302,792.05

7770

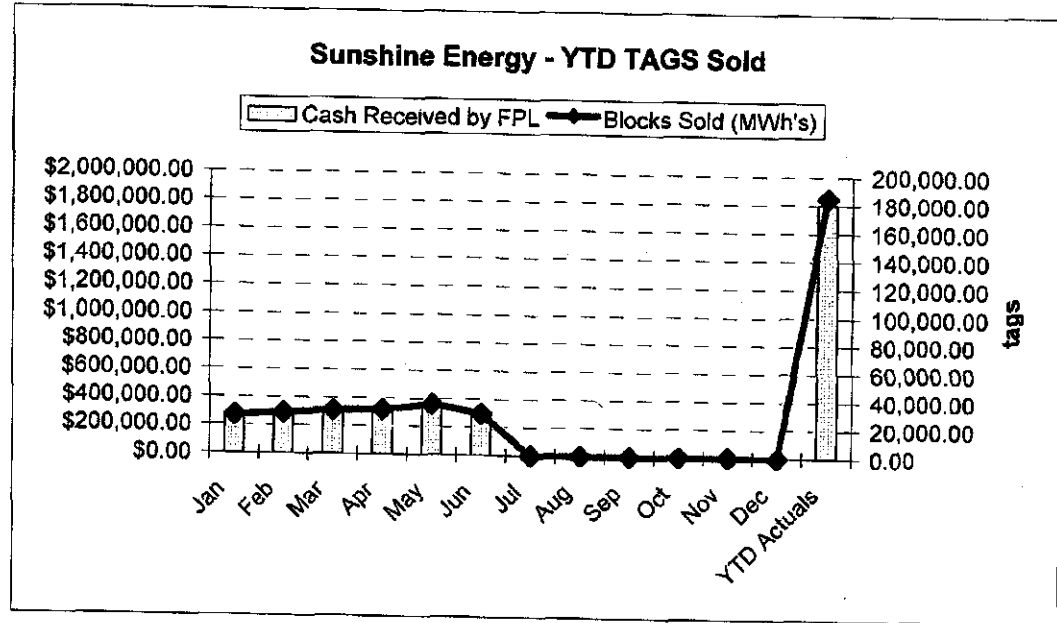

2007
YTD ENROLLMENTS
DECEMBER

2007 Sunshine Energy Participants Program-To-Date

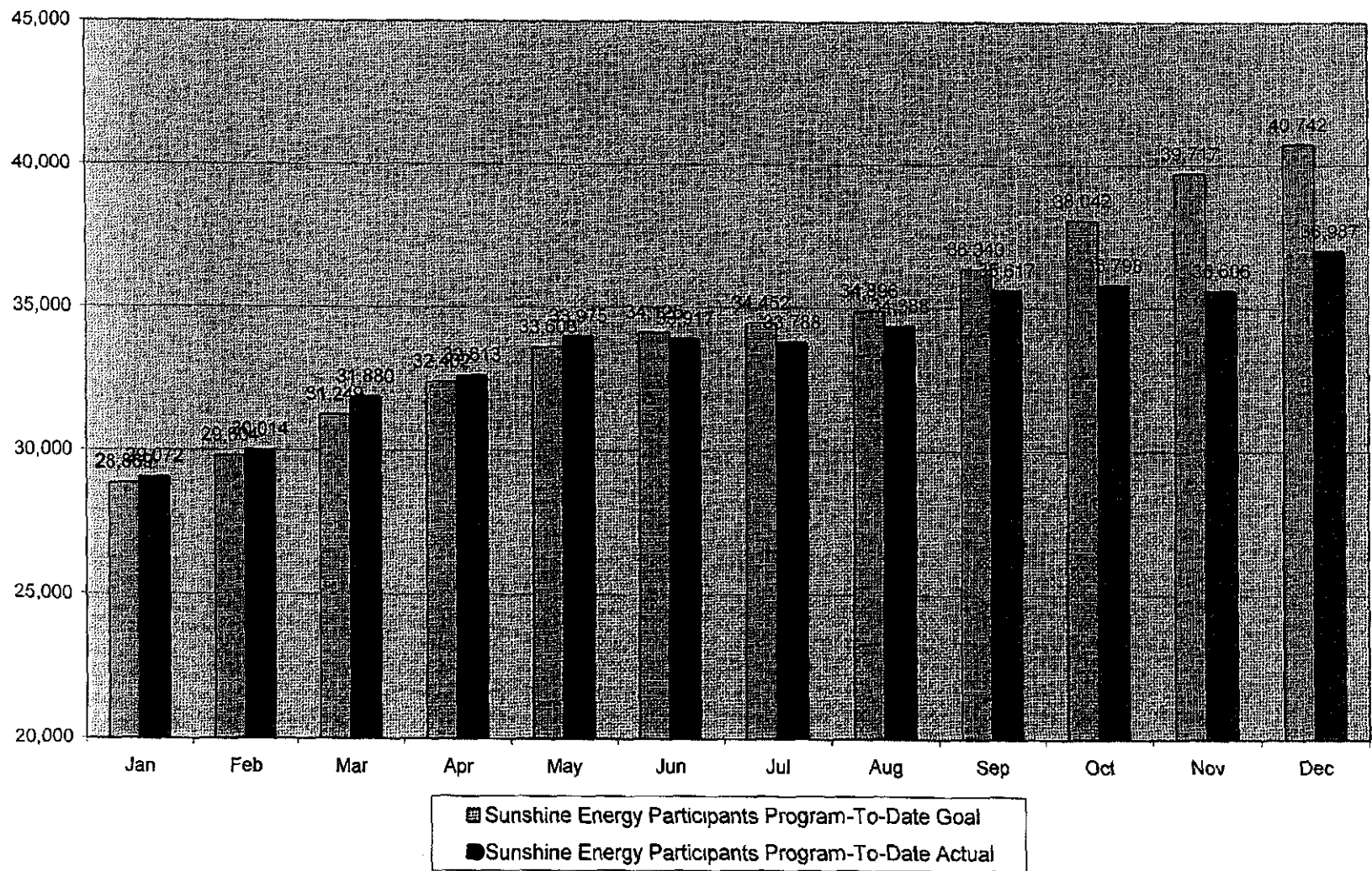

Sunshine Energy Enrollments - Program to Date / YTD / Channel

Original Marketing Plan Assumptions

Participants	New Enrollments per CIS	Jan.		Feb.		March		April		May		June		July		Aug		Sept		Oct		Nov		Dec	
		Goal	Actual	Goal	Actual	Goal	Actual	Goal	Actual	Goal	Actual	Goal	Actual	Goal	Actual	Goal	Actual	Goal	Actual	Goal	Actual	Goal	Actual	Goal	Actual
Sales Channels	CODE	148	590	1,086	1,167	1,679	1,852	1,340	1,300	1,399	1,762	603	301	380	110	517	0	1,694	0	1,979	0	1,948	0	1,191	0
Advertising	AD		46		117		80		58		113		55		19										
Direct Sales - Store Fronts	SF		0		1		1																		
Direct Mail Campaigns	DM		11	345	287	1,208	1,315	518	635	1,208	1,420	173	200												
Email	EM		2		0		4												285		1,192		1,192		
Web	WB		27		20		34	23	24		17		7		1										
Phone -In	PI		19		104		23				51		11		13										
Phone - Out	PO				6		223				115		8		8										
Bill Insert Response	BI																		223		115				
Affinity	AF		0		1		1																		
Bangtail	BT	148	481	741	625	236	392	684	575	91	156		100		100		100		175		250		350		250
Door to Door	DD														12	137		884		91		125		711	
FPL Employee Signup	ZZ																								
Transfer of Service	ST		4		6		2				3														
Re-Enrolling	RE																								
Apartment Condo Channel	AC																								
Energy Audit	EA						12			100		100		50		50		100		100		50		50	
Refer A Friend	RF													50		50		50		50		50		50	
Online New Service Connects	OC																								
TOTALS		148	590	1,086	1,167	1,679	1,852	1,340	1,300	1,399	1,762	603	301	380	110	517	0	1,694	0	1,979	0	1,948	0	1,191	0

Drops
Source: Datawarehouse Monthly Report
Sunshine Energy Enrollments by Channel

May 410 23275
24713

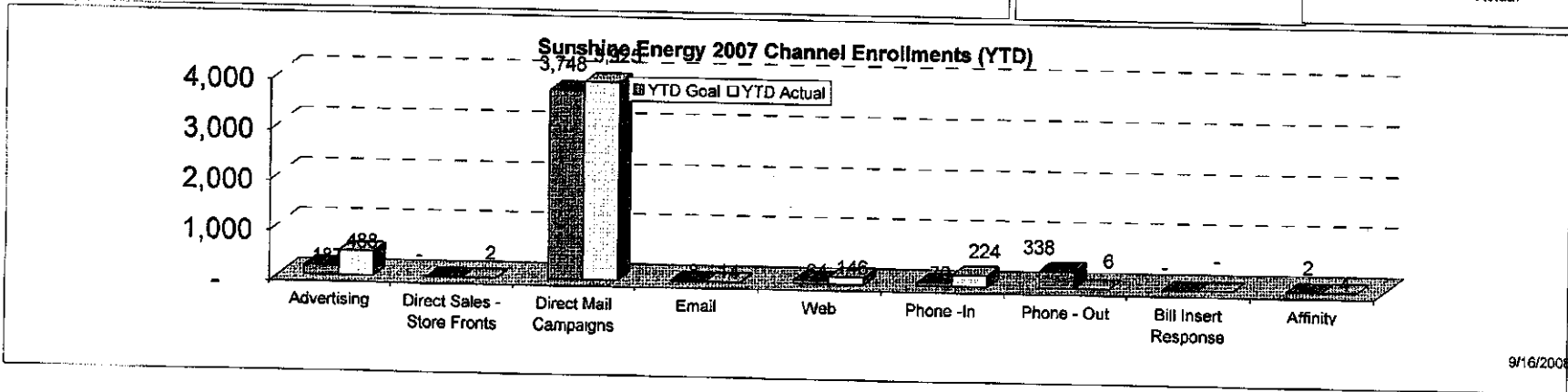
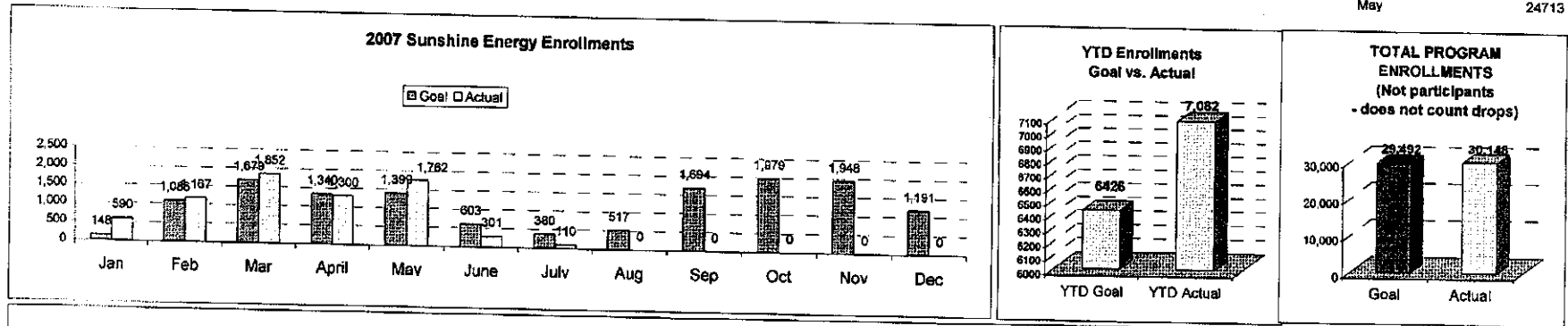

	Goal	Installs	Drops
Jan	148	590	0
Feb	1,086	1,167	0
Mar	1,679	1,852	0
Apr	1,340	1,300	0
May	1,399	1,762	0
Jun	603	301	0
Jul	380	110	0
Aug	517	0	0
Sep	1,694	0	0
Oct	1,979	0	0
Nov	1,948	0	0
Dec	1,191	0	0
Total	13,964	7,082	0

Sunshine Energy Participants Program-To-Date

	Goal	Actual	Monthly Change	Adjusted	0 860523	
Jan	28,869	29,072		148	127	28869
Feb	29,804	30,014	942	1086	935	29804
Mar	31,249	31,880	1,866	1679	1445	31249
Apr	32,402	32,613	733	1340	1153	32402
May	33,606	33,975	1,362	1399	1204	33606
Jun	34,125	33,917	-58	603	519	34125
Jul	34,452	33,788	-129	380	327	34452
Aug	34,896	34,388	600	517	445	34896
Sep	36,340	35,617	1,229	1677	1443	36340
Oct	38,042	35,798	181	1978	1702	38042
Nov	39,717	35,606	-192	1947	1675	39717
Dec	40,742	36,987	1,381	1191	1025	40742

Dec-06
YE 28742

2007 Sunshine Energy Enrollments

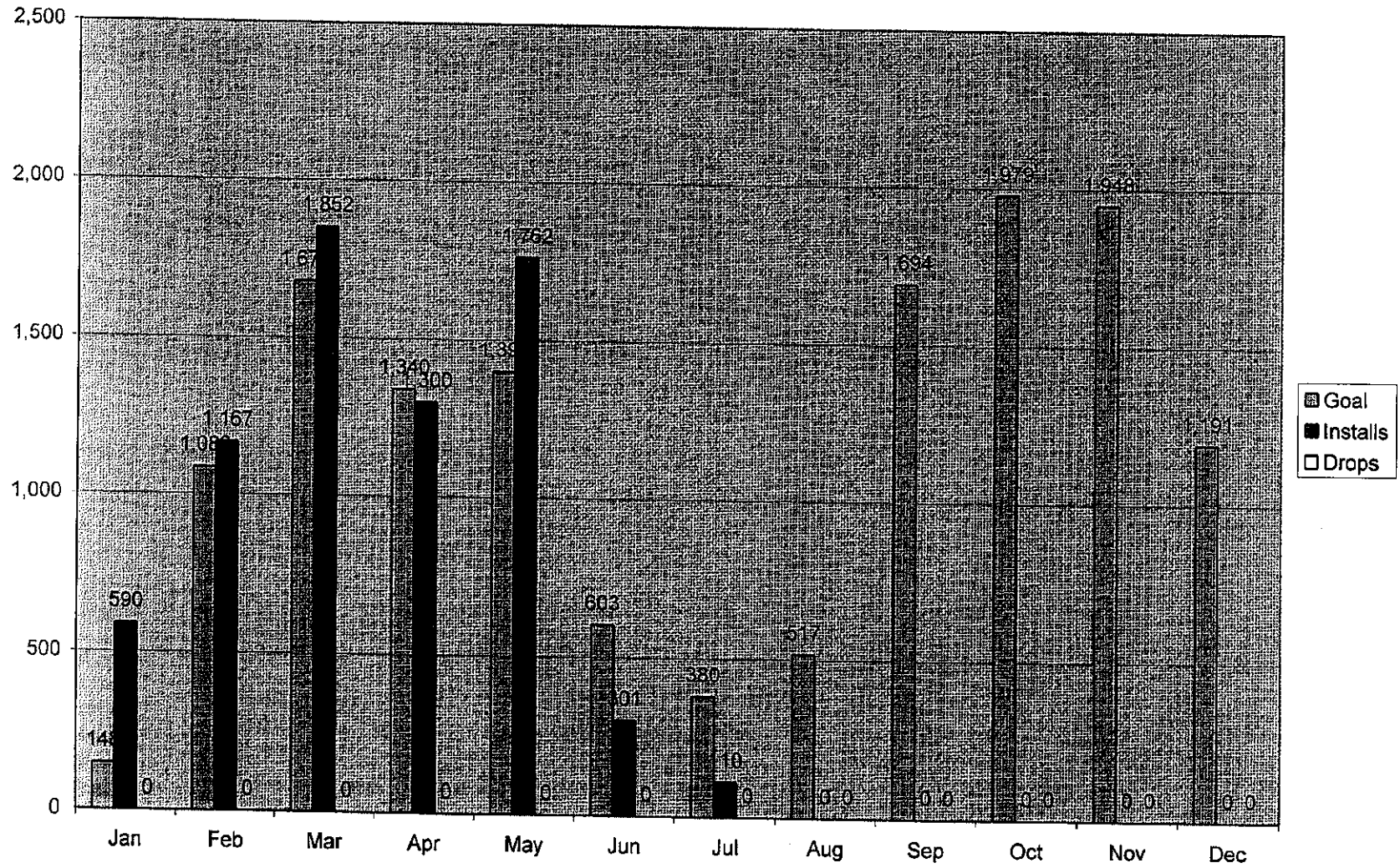

Green Power Project - 2007 Program Activity \$\$
"SUNSHINE ENERGY"

Account Description	Ferc Acct	TOTAL	Jan	Feb	Mar	Apr	May	Jun	Jul	Aug	Sep	Oct	Nov	Dec
Green Power Pricing-O&M Expenses	908.265	\$	\$0	\$0	\$0	\$0	\$0	\$0	\$0	\$0	\$0	\$0	\$0	\$0
Green Power Pricing-P&W Benefits	926.211	\$	\$0	\$0	\$0	\$0	\$0	\$0	\$0	\$0	\$0	\$0	\$0	\$404
GREEN PRICING PROGRAM		\$	\$0	\$0	\$0	\$0	\$0	\$0	\$0	\$0	\$0	\$0	\$0	\$404
REVENUE ACCOUNTS:														
Res. Sales	440.030	\$0	\$0	\$0	\$0	\$0	\$0	\$0	\$0	\$0	\$0	\$0	\$0	\$0
Res. Sales - Public Authority	440.080	\$0												
Commercial Sales	442.130	\$0												
Commercial Sales - Public Authority	442.180	\$0												
Industrial Sales	442.230	\$0												
Industrial Sales-Public Authority	442.280	\$0												
Other Sales to Pub Authority	445.030	\$0												
Public Authority-Railway Sales	446.080	\$0												
REVENUES		\$0	\$0	\$0	\$0	\$0	\$0	\$0	\$0	\$0	\$0	\$0	\$0	\$0
Program Expenses - (Net of Revenues)		\$404	\$0	\$0	\$0	\$0	\$0	\$0	\$0	\$0	\$0	\$0	\$0	\$404

2007			
Month	Cash Received by FPL	Blocks Sold (MWh's)	Enrollments
Jan	\$264,428.90	27,120.91	590
Feb	\$282,470.94	28,971.38	1,167
Mar	\$302,385.71	31,013.92	1,852
Apr	\$310,398.30	31,835.72	1,300
May	\$351,103.52	36,010.62	1,762
Jun	\$288,286.10	29,567.81	301
Jul	\$0.00	0.00	110
Aug	\$0.00	0.00	0
Sep	\$0.00	0.00	0
Oct	\$0.00	0.00	0
Nov	\$0.00	0.00	0
Dec	\$0.00	0.00	0
YTD Actuals	\$1,799,073.47	184,520.36	7,082
Program to date	\$11,552,778.39	759,259.33	30,148

2004	\$4,611,880.78	47,372.39	
2005	\$2,189,601.66	224,574.53	
2006	\$2,952,222.48	302,792.05	7770

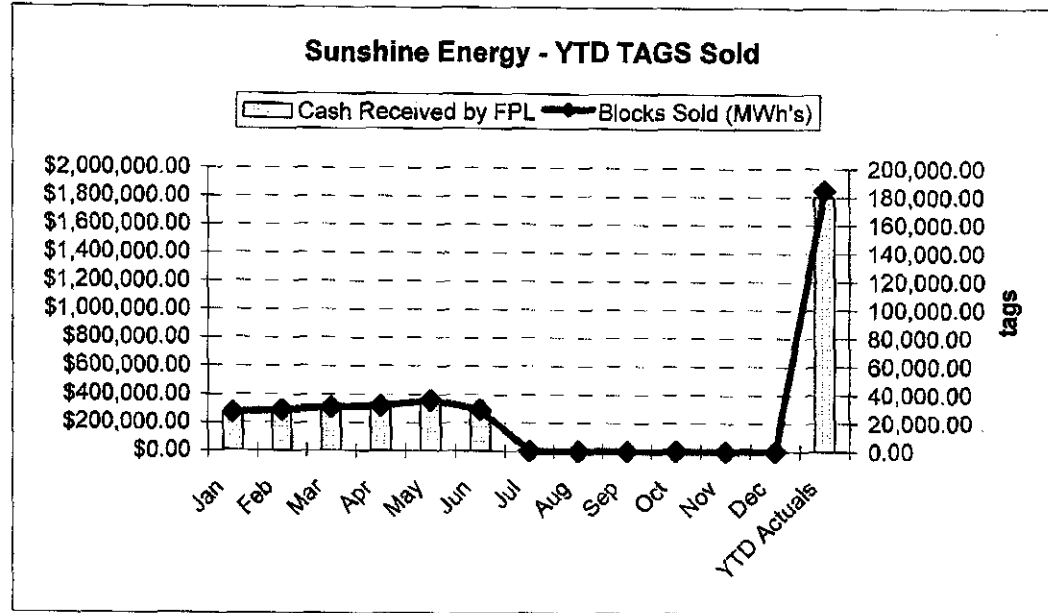

2005
YTD ENROLLMENTS
DECEMBER

As filed with the 2005 ECCR Projection Filing

2005 Revenues	Proj. January	Proj. February	Proj. March	Proj. April	Proj. May	Proj. June	Proj. July	Proj. August	Proj. September	Proj. October	Proj. November	Proj. December	TOTAL
16. BuildSmart Program	0	0	0	0	0	0	0	0	0	0	0	0	\$ 0
17. Green Power Pricing (Sunshine)	(88,725)	(94,575)	(100,425)	(106,275)	(112,125)	(117,975)	(123,825)	(129,675)	(135,525)	(141,375)	(147,225)	(153,075)	\$ (1,450,800)
Total Program Revenues	\$ (88,725)	\$ (94,575)	\$ (100,425)	\$ (106,275)	\$ (112,125)	\$ (117,975)	\$ (123,825)	\$ (129,675)	\$ (135,525)	\$ (141,375)	\$ (147,225)	\$ (153,075)	\$ (1,450,800)

DUE DATE: JUNE 22, 2005

--- ENT --- ENTER ESTIMATES FOR JULY - DECEMBER ---

TO BE FILED WITH THE 2005 ESTIMATED/ACTUAL

2005 Revenues	Actuals January	Actuals February	Actuals March	Actuals April	Actuals May	Sub-Total Jan-May	Estimate June	Estimate July	Estimate August	Estimate September	Estimate October	Estimate November	Estimate December	Sub-Total July-Dec	2005 Est/Act Total
16. BuildSmart Program	(23,650)	(15,525)	(7,450)	(23,550)	(24,000)	(84,175)								\$ (84,175)	\$ (84,175)
17. Green Power Pricing (Sunshine)	(109,952)	(130,878)	(156,538)	(174,243)	(182,765)	(753,387)	(201,042)	(221,146)	(243,280)	(267,586)	(280,966)	(287,890)	(295,189)	\$ (2,586,588)	\$ (2,751,608)
Total Program Revenues	\$ (133,612)	\$ (146,403)	\$ (162,988)	\$ (197,793)	\$ (206,765)	\$ (847,562)	\$ (201,042)	\$ (221,146)	\$ (243,280)	\$ (267,586)	\$ (280,966)	\$ (287,890)	\$ (295,189)	\$ (2,644,740)	\$ (2,845,781)

% Increase	
Total # of Customers	
Net from month to month	

June	July	Aug	Sept	Oct	Nov	Dec
110.00%	110.00%	110.00%	110.00%	105.00%	102.50%	102.50%
(20,620)	(22,682)	(24,950)	(27,445)	(28,817)	(29,537)	(30,276)
	(2,062)	(2,288)	(2,495)	(1,372)	(720)	(735)

Sunshine Energy Enrollments - Program to Date / YTD / Channel

Original Marketing Plan Assumptions

Participants		Jan.		Feb.		March		April		May		June		July		Aug.		Sept.		Oct.		Nov.		Dec.	
New Enrollments per CIS		Goal	Actual	Goal	Actual	Goal	Actual	Goal	Actual	Goal	Actual	Goal	Actual	Goal	Actual	Goal	Actual	Goal	Actual	Goal	Actual	Goal	Actual	Goal	Actual
Sales Channels																									
Advertising	AD				2		4		4		1		4		1		2		2						
Direct Sales - Store Fronts	SF	150	179	150	170	150	152	150	180	150	93	150	222	150	154	150	197	100	368	100	63	75	17	0	1
Direct Mail Campaigns	DM	250	95	409	1,196	250	271	220	55	100	788	0	554	132	75	250	41	200	4	170		185	1	200	1
Email	EM																								
Web	WB		1				1				1														
Phone - In	PI		12		87		26		20		29		21		6		13		4		3		8		2
Phone - Out	PO	350	501	350	728	350	1,024	350	551	350	470	350	584	350	364	350	220	350	312	350	113	350	0	350	2
Bill Insert Response	BI	20	647	80	27	80	218	200	818	500	33	100	60	0	378	250	299	500	133	100	108	200	778	200	15
Affinity	AF			50		50				80		68		100				100				100			
Banglail	BT																								
Door to Door	DD																								
FPL Employee Signup	ZZ																								
Transfer of Service	ST																								
Re-Enrolling	RE																								
TOTALS		770	1,435	1,009	2,210	880	1,696	970	1,628	1,180	1,415	669	1,445	732	978	1,100	743	1,270	826	820	293	910	807	850	19

Source: Datawarehouse Monthly Report
Sunshine Energy Enrollments by Channel

410 23275

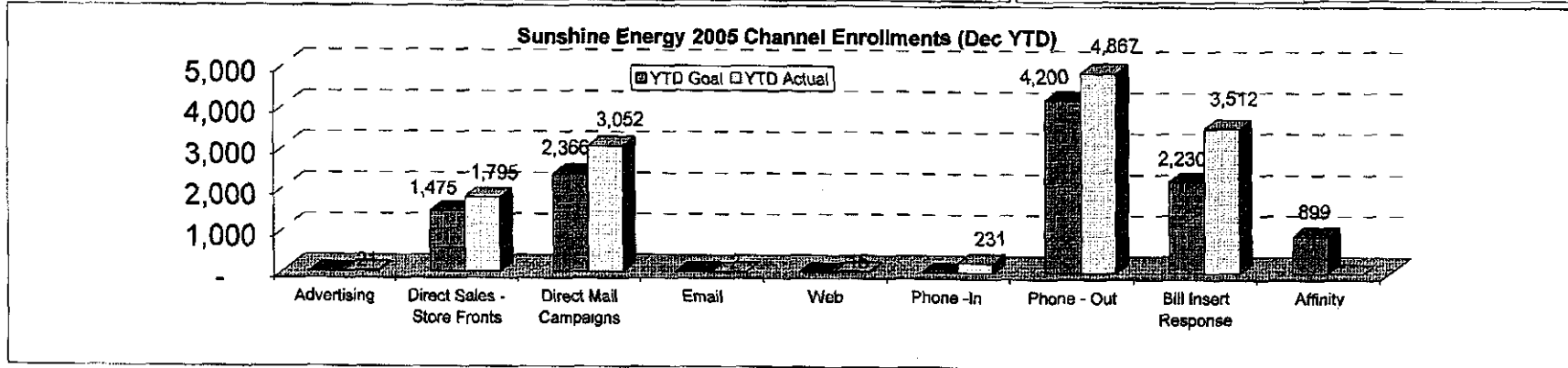
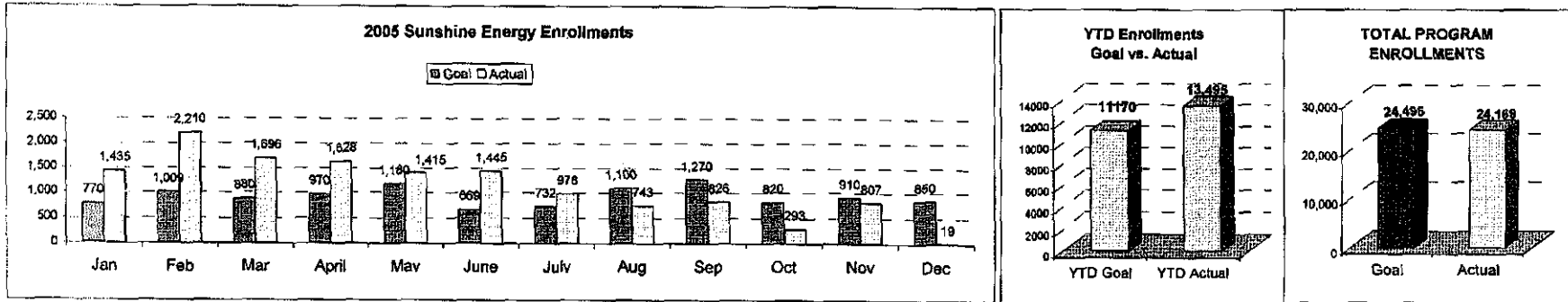

As filed with the 2005 ECCR Projection Filing

2005 Revenues	Proj. January	Proj. February	Proj. March	Proj. April	Proj. May	Proj. June	Proj. July	Proj. August	Proj. September	Proj. October	Proj. November	Proj. December	TOTAL
16. BuildSmart Program	0	0	0	0	0	0	0	0	0	0	0	0	\$ 0
17. Green Power Pricing (Sunshine)	(88,725)	(94,575)	(100,425)	(106,275)	(112,125)	(117,975)	(123,825)	(129,675)	(135,525)	(141,375)	(147,225)	(153,075)	\$ (1,450,800)
Total Program Revenues	\$ (88,725)	\$ (94,575)	\$ (100,425)	\$ (106,275)	\$ (112,125)	\$ (117,975)	\$ (123,825)	\$ (129,675)	\$ (135,525)	\$ (141,375)	\$ (147,225)	\$ (153,075)	\$ (1,450,800)

DUE DATE: JUNE 22, 2005

TO BE FILED WITH THE 2005 ESTIMATED/ACTUAL

2005 Revenues	Actuals January	Actuals February	Actuals March	Actuals April	Actuals May	Sub-Total Jan-May	ENTER ESTIMATES FOR JULY - DECEMBER							2005 Est/Act Total				
							Estimate June	Estimate July	Estimate August	Estimate September	Estimate October	Estimate November	Estimate December		Sub-Total July-Dec			
16. BuildSmart Program	(23,650)	(15,525)	(7,450)	(23,550)	(24,000)	(94,175)												
17. Green Power Pricing (Sunshine)	(109,962)	(130,878)	(155,538)	(174,243)	(182,785)	(753,387)	(201,042)	(221,145)	(243,260)	(267,586)	(280,956)	(287,990)	(295,189)	(94,175)	(2,550,565)	(2,751,505)		
Total Program Revenues	\$ (133,612)	\$ (146,403)	\$ (162,988)	\$ (197,793)	\$ (206,785)	\$ (847,562)	\$ (201,042)	\$ (221,145)	\$ (243,260)	\$ (267,586)	\$ (280,956)	\$ (287,990)	\$ (295,189)	\$ (1,593,137)	\$ (2,644,740)	\$ (2,845,781)		

% Increase	
Total # of Customers	
Net from month to month	

June	July	Aug	Sept	Oct	Nov	Dec
110.00%	110.00%	110.00%	110.00%	105.00%	102.50%	102.50%
(20,620)	(22,682)	(24,980)	(27,445)	(28,817)	(28,537)	(30,276)
	(2,062)	(2,288)	(2,495)	(1,372)	(720)	(738)

Green Power Project - 2005 Program Activity \$\$
"SUNSHINE ENERGY"

Account Description	Ferc Acct	TOTAL	Jan	Feb	Mar	Apr	May	Jun	Jul	Aug	Sep	Oct	Nov	Dec
Green Power Pricing-O&M Expenses	908.285	\$ 2,086,100	\$84,788	\$117,850	\$134,547	\$154,311	\$175,113	\$193,687	\$188,635	\$198,028	\$203,700	\$192,792	\$235,910	\$216,759
Green Power Pricing-P&W Benefits	926.211	\$ 5,346	\$369	\$421	\$414	\$415	\$428	\$633	\$889	\$422	\$403	\$289	\$465	\$217
GREEN PRICING PROGRAM		\$ 2,101,446	\$85,138	\$118,271	\$134,961	\$154,726	\$175,542	\$194,320	\$189,524	\$198,450	\$204,103	\$193,081	\$236,375	\$216,976
REVENUE ACCOUNTS:														
Res. Sales	440.030	(\$2,258,752)	(\$109,962)	(\$130,878)	(\$155,538)	(\$174,243)	(\$182,765)	(\$200,033)	(\$208,921)	(\$211,016)	(\$217,492)	(\$218,810)	(\$225,286)	(\$223,807)
Res. Sales - Public Authority	440.080	\$0												
Commercial Sales	442.130	\$0												
Commercial Sales - Public Authority	442.180	\$0												
Industrial Sales	442.230	\$0												
Industrial Sales-Public Authority	442.280	\$0												
Other Sales to Pub Authority	445.030	\$0												
Public Authority-Railway Sales	446.080	\$0												
REVENUES		(\$2,258,752)	(\$109,962)	(\$130,878)	(\$155,538)	(\$174,243)	(\$182,765)	(\$200,033)	(\$208,921)	(\$211,016)	(\$217,492)	(\$218,810)	(\$225,286)	(\$223,807)
Program Expenses - (Not of Revenues)		(\$167,306)	(\$24,824)	(\$12,808)	(\$20,577)	(\$19,518)	(\$7,224)	(\$5,714)	(\$19,397)	(\$12,566)	(\$13,389)	(\$25,749)	\$11,089	(\$6,831)

2005			
Month	Cash Received by FPL	Blocks Sold (MWh's)	Enrollments
Jan	\$97,626.31	10,012.95	1,435.00
Feb	\$113,097.26	11,599.72	2,210.00
Mar	\$140,465.42	14,406.71	1,696.00
Apr	\$160,762.53	16,488.46	1,628.00
May	\$184,494.57	18,922.52	1,415.00
Jun	\$187,624.48	19,243.54	1,445.00
Jul	\$197,813.30	20,288.54	978.00
Aug	\$209,250.55	21,461.59	743.00
Sep	\$215,618.09	22,114.68	826.00
Oct	\$202,796.00	20,799.59	293.00
Nov	\$250,990.59	25,742.62	807.00
Dec	\$229,062.56	23,493.60	19.00
YTD Actuals	\$2,189,601.66	224,574.53	13,495.00
Program to date	\$2,651,482.44	271,946.92	24,169.00

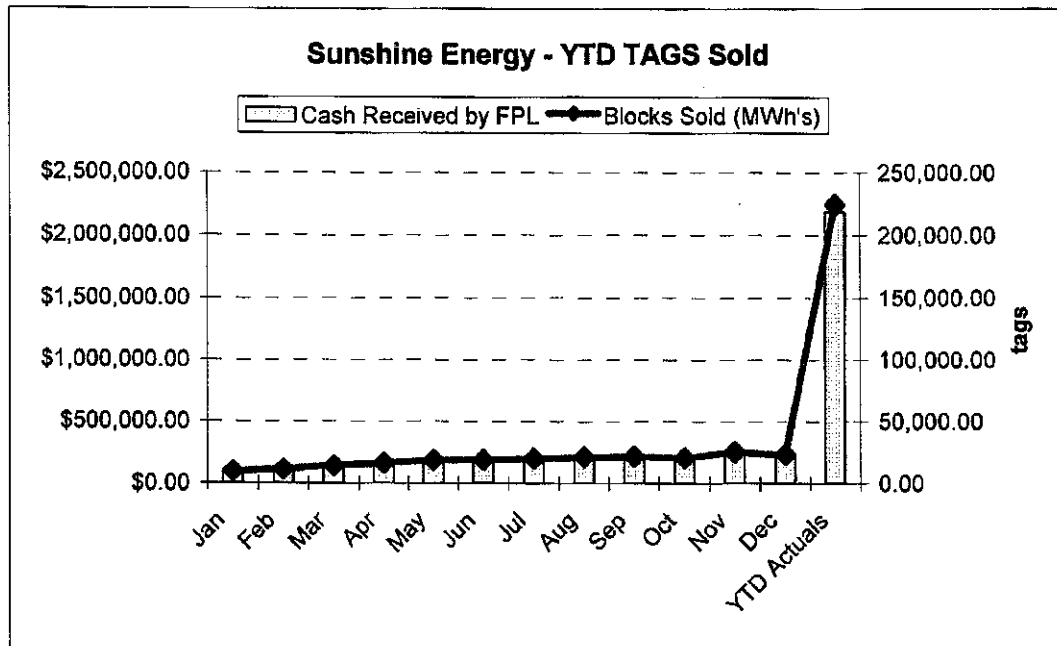

2004
YE SE MONTHLY
GOALS

Month	Cash Received by FPL	Blocks Sold
Jan	\$0.00	0.00
Feb	\$367.58	37.70
Mar	\$6,339.48	650.20
Apr	\$16,444.60	1,686.63
May	\$22,270.26	2,284.13
Jun	\$31,375.08	3,217.96
Jul	\$43,793.30	4,491.62
Aug	\$50,157.53	5,144.36
Sep	\$56,484.39	5,793.27
Oct	\$65,758.98	6,744.51
Nov	\$76,852.36	7,882.29
Dec	\$92,037.22	9,439.71
YTD TOTALS	\$461,880.78	47,372.39

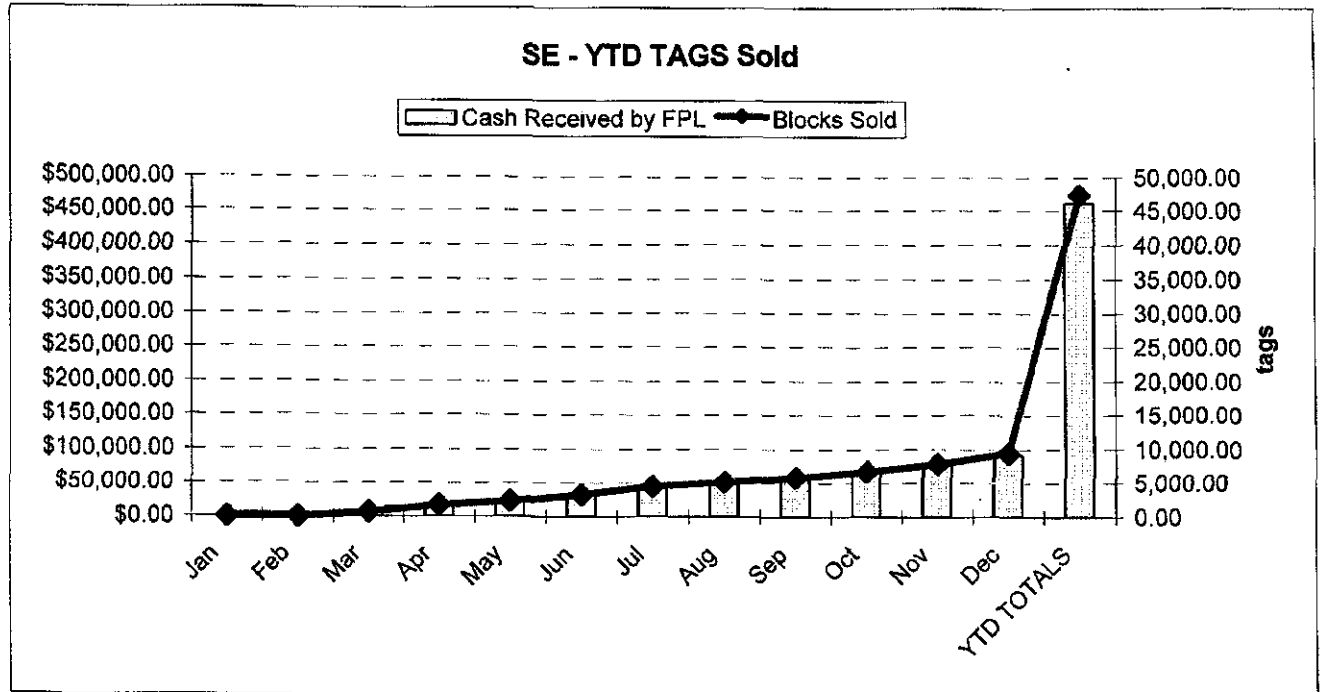

SE 2004 Target Sales by Month

Particulars		2004			2005			2006			2007			2008			2009			2010			2011			
New Enrollments per CIS		Jan	Feb	Mar	Apr	May	June	July	Aug	Sept	Oct	Nov	Dec	Jan	Feb	Mar	Apr	May	June	July	Aug	Sept	Oct	Nov	Dec	
Code	Actual	Actual	Goal	Actual	Goal	Actual	Goal	Actual	Goal	Actual	Goal	Actual	Goal	Actual	Goal	Actual	Goal	Actual	Goal	Actual	Goal	Actual	Goal	Actual	Goal	
Sales Channels																										
Advertising	AD	0	46	0	70			22																		
Direct Sales Events - State Firms	DF	0	77	0	434	349	399	462	536	410	302	900	693	833	273	4	12									
Direct Mail Campaigns	DM	0	177	0	440	298	176	0	57	0	235	1,000	756	252	74	1,294	45	340	106	1,063	320	1,000	583	1,203	504	
Email	EM	1	3	0																						
Web	WB	0	10	0	7	17	0	5		3																
Phone - Inbound*	IP	1			0	17	0	5		3																
Phone - Outbound	PO	0	0	173	5	68	300	2	271		100	3	100													
Bill Insert Response	BI	0	22	0	431	91	334	46		0	43		418	74	778	281	1,318	218	1,550	19	200	327	200	22	200	
Attorney	AT	0			0	118	688	0	280	0																
FPL Employee Status	ES	0			2																					
Transfer of Service	TZ	12	26	0	29	0	0	0		4																
Re-Enrolling	RE	0			2					32																
TOTALS		14	381	0	1,047	1,222	662	1,681	494	941	702	2,157	1,680	2,416	803	4,120	605	3,076	903	5,624	1,232	4,385	1,211	3,068	683	3,607
Channel Activity - # of Initiatives																										
Direct Sales Events		0	21		41					112		106														
Direct Mail Campaigns		0			0																					
Web		0	1		1																					
Phone - Inbound*		0			0																					
Phone - Outbound		0			1																					
Bill Insert Response		0			0																					
Indicators		0	23	0	43					112		107														

* May have been initiated by another channel

2004 SE Graphs

Month	YTD Actual	Goal Original	Goal Revised	Cumm Goal
Jan.	14	0	0	14
Feb.	381	1,047	1,047	1,047
March	1,232	852	952	1,699
April	543	941	561	2,840
May	757	2,157	891	4,997
June	1,680	2,116	1,650	7,113
July	803	4,120	1,639	11,233
Aug	494	3,078	1,024	14,311
Sept	893	5,524	2,159	19,836
Oct	1,212	4,365	1,686	24,200
Nov	1,206	7,098	3,120	31,298
Dec	884	3,607	1,462	34,905
YTD Totals	10,099	14,311	7,764	

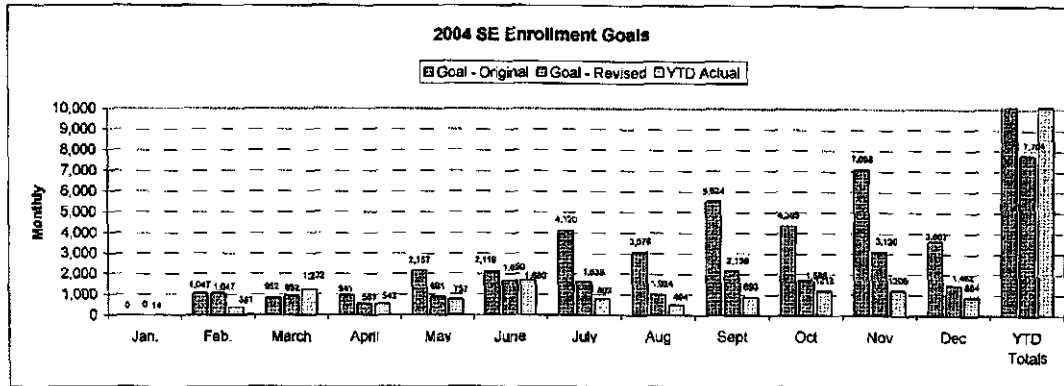

	Original Forecast	Reforecast	Actual
Jan	512	0	14
Feb	1,075	1,047	363
March	2,266	852	1198
April	2,363	941	466
May	3,819	2,157	679
June	3,709	2,116	1,631
July	4,919	4,120	771
Aug	4,326	3,078	494
Sept	2,939	5,524	893
Oct	4,849	4,365	1,212
Nov	3,469	7,098	1,206
Dec	1,688	3,607	884
Totals	35,911	34,906	9,810

	Jan.		Feb.		March		April		May		June		July		Aug		Sept		Oct		Nov		Dec	
Sales Channels	Actual	Goal	Actual	Goal	Actual	Goal	Actual	Goal	Actual	Goal	Actual	Goal	Actual	Goal	Actual	Goal	Actual	Goal	Actual	Goal	Actual	Goal	Actual	Goal
AD	0	0	46	0	78	0	22	0	31	0	18	0	4	0	12	0	5	0	6	0	2	0	5	0
SF(Direct Sales)	0	0	77	434	349	452	330	410	362	600	683	833	273	914	156	814	106	1,062	320	1,000	583	1,203	584	1,003
DM	0	0	177	440	298	0	51	0	235	1,000	756	252	74	1,324	45	360	716	2,283	438	601	318	3,000	49	900
Email	1	0	3	0	1	0	1	0	0	38	1	45	1	90	0	90	0	90	0	90	1	93	0	90
Vrsb	0	0	10	0	7	0	5	0	3	0	1	0	1	0	4	0	0	0	1	0	1	0	3	0
PI	1	0	0	173	5	300	2	271	1	100	3	100	1	100	10	100	8	200	327	200	92	200	8	200
PC	0	0	0	0	0	586	0	260	0	418	74	778	281	1,318	218	1,556	10	1,731	107	2,100	199	2,447	218	1,364
BI	0	0	22	0	431	324	46	0	43	0	82	108	136	324	49	108	48	108	12	324	10	108	17	0
Affinity	0	0	0	0	0	0	0	0	0	0	0	0	0	50	0	50	0	50	0	50	0	50	0	50
FPL	12	0	28	0	29	0	8	0	4	0	3	0	0	0	0	0	0	0	1	0	0	0	0	0
Transfer of Svc.	0	1	18	0	32	0	17	0	23	0	49	0	31	0	11	0	10	0	19	0	4	0	9	0
Re-Enrollments	0	2	0	0	2	0	2	0	0	0	0	0	1	0	0	0	0	0	1	0	1	0	0	0
Totals	14	0	383	1,047	1,198	1,681	465	841	679	2,167	1,631	2,116	771	4,120	494	3,078	893	5,624	1,212	4,365	1,206	7,098	884	3,607
			1st Qtr. Updates				2nd Qtr. Updates				3rd Qtr. Updates				4th Qtr. Updates									

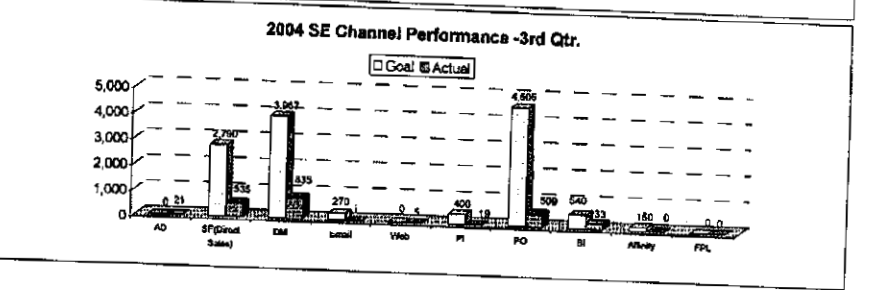
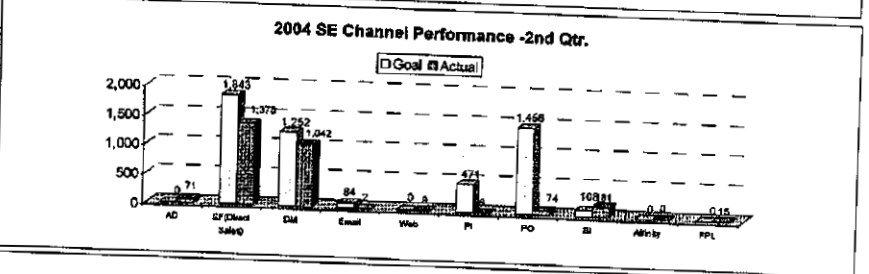
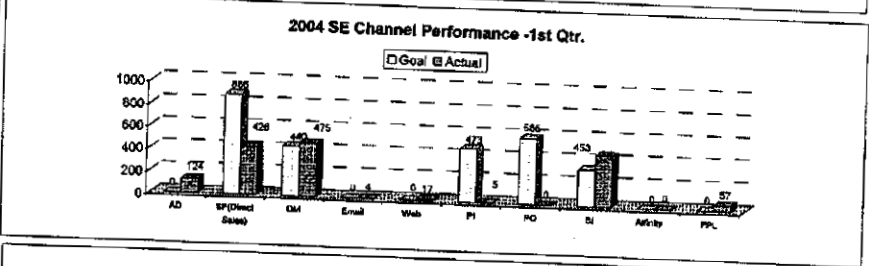
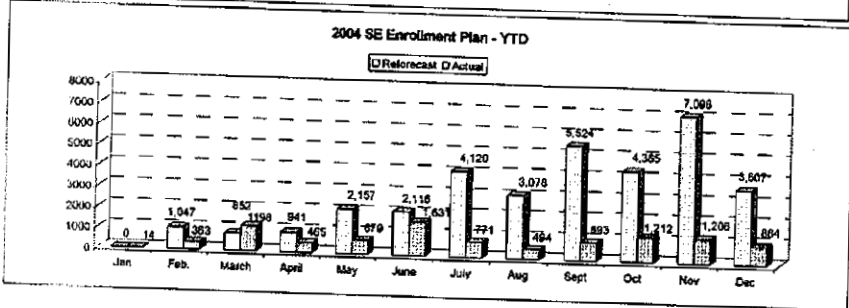
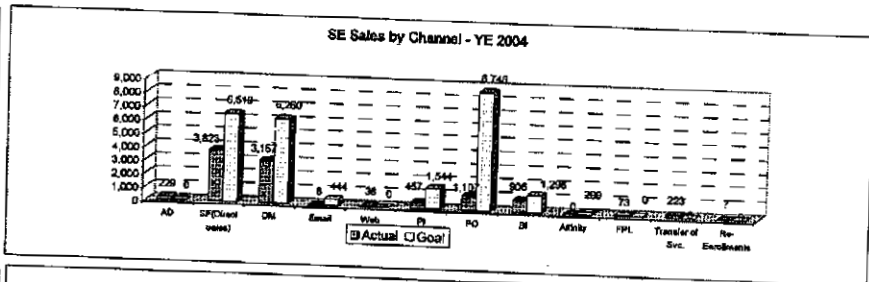
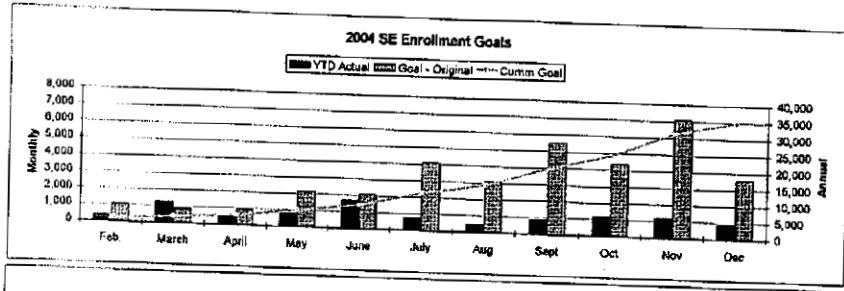

Cancels/Drops/Enrollments		Activity Type			
Year Month	Load Control Subcode	Cancels	Drops	Enrollments	Grand Total
2004-01	CM		3		3
	DO		5		5
	EM			1	1
	FB		1		1
	PI			1	1
	PR			1	1
	SO				12
2004-01 Total			10	14	24
2004-02	AD		1	46	47
	BI		1	22	23
	CM	1	30		31
	DM		1	177	178
	DO		7		7
	DT		23		23
	EC		1		1
	EM			3	3
	FB	1	30		31
	MV		2		2
	PR		13		13
	SF		4	77	81
	SO			25	25
	SP			3	3
	ST			18	18
	WB			10	10
2004-02 Total		2	113	381	496
2004-03	AD		1	78	79
	BI		2	431	433
	CM	1	57		58
	DM		2	298	300
	DO	2	16		18
	DT		42		42
	EC		3		3
	EF		4		4
	EM			1	1
	FB		76		76
	PI			5	5
	PR	1	17		18
	RE			2	2
	SF		10	349	359
	SO			19	19
	ST			32	32
WB			5	5	
ZZ			10	10	
2004-03 Total		4	230	1,230	1,464
2004-04	AD			22	22
	BI			46	46
	CM	3	35		38
	DM			51	51
	DO	2	12		14

2004-04	DT		21		21
	EC		4		4
	EF		3		3
	EM			1	1
	FB	1	36		37
	PI			2	2
	PR		25		25
	RE			2	2
	SF		6	330	336
	SO			4	4
	ST			17	17
	WB			5	5
	ZZ			4	4
2004-04 Total			6	142	484
2004-05	AD			31	31
	BI			43	43
	CM	2	42		44
	DM			235	235
	DO	1	17		18
	DT		26		26
	EC		5		5
	FB	1	46		47
	PI			1	1
	PR		17		17
	SF		29	362	391
	SO			3	3
	ST			23	23
	WB			3	3
	ZZ			1	1
2004-05 Total			4	182	702
2004-06	AD			18	18
	BI		1	92	93
	CM	1	76		77
	DM		5	756	761
	DO	1	14		15
	DT		52		52
	EC		6		6
	EF		3		3
	EM			1	1
	FB	2	72		74
	PI			3	3
	PO			74	74
	PR	1	18		19
	SF		68	683	751
	SO			3	3
	ST			49	49
	WB			1	1
2004-06 Total			5	315	1,680
2004-07	AD			4	4
	BI			136	136
	CM	2	46		48
	DM			74	74
	DO	1	15		16

2004-07	DT			36		36
	EC			3		3
	EF			1		1
	EM				1	1
	FB			34		34
	PI				1	1
	PO			2	281	283
	PR			10		10
	RE				1	1
	SF			11	271	282
	SO				2	2
	ST			1	31	32
	WB				1	1
2004-07 Total				3	159	803
2004-08	AD				12	12
	BI				49	49
	CM	4	35			39
	DM				45	45
	DO			9		9
	DT			12		12
	EC			1		1
	FB			12		12
	PI				10	10
	PO			3	218	221
	PR			5		5
	SF			2	151	153
	SO				5	5
	ST				11	11
	WB				4	4
2004-08 Total		4	79		505	588
2004-09	AD				5	5
	BI				48	48
	CM		14			14
	DM		3		716	719
	DO	1	6			7
	DT		10			10
	EC		1			1
	EF		2			2
	EM		1			1
	FB		19			19
	PI		1		8	9
	PO				10	10
	PR	1	1			2
	SF				102	102
	SO				4	4
	ST				10	10
2004-09 Total		2	58		903	963
2004-10	AD				6	6
	BI				12	12
	CM	8	24			32
	DM		1		438	439
	DO	4	8			12
	DT		17			17

2004-10	EC			6	6
	EF			4	4
	FB			20	20
	MV	1			1
	PI			5	327
	PO				107
	PR	1	8		9
	RE				1
	SF		7		317
	SO				3
	ST				19
	WB				2
	ZZ				1
2004-10 Total		14	100	1,233	1,347
2004-11	AD			2	2
	BI			10	10
	CM	13	48		61
	DM			318	318
	DO	4	6		10
	DT		5		5
	EC	2	2		4
	EF		4		4
	EM			1	1
	FB		10		10
	MV		1		1
	PI		3	92	95
	PO		1	199	200
	PR	3	1		4
	RE			1	1
	SF		3	580	583
	SO			3	3
ST			4	4	
WB			1	1	
2004-11 Total		22	84	1,211	1,317
2004-12	AD			4	4
	BI			257	257
	CM	9			9
	DM			49	49
	DO	1			1
	DT		1		1
	EC		2		2
	FB		2		2
	PI			5	5
	PO		1	167	168
	PR		1		1
	SF			404	404
	SO			11	11
	ST			1	1
WB			2	2	
2004-12 Total		10	7	900	917
Grand Total		76	1,479	10,046	11,601

Sales Source Description	Description
AD SALES SRC-ADVERTISING	Newspaper Article, brochure, radio tv, other
BI SALES SRC-BILL INSERT	Bill stuffer Energy News, Bill Message, or letter asking the customer to take action - included in cust Bill
CM DROP RSN-CUST CHGED MIND	
DM SALES SRC-DIRECT MAIL	Separate Letter mailed to customer with a "tear-away" application. Letter will also provide 1-888 and web information
DO DROP RSN-OTHER, ENTER RMKS	
DT DROP RSN-TRANSFER SERVICE	
EC DROP RSN-SIGNED IN ERR CUST	
EF DROP RSN-SIGNED IN ERR FPL	
EM SALES SRC-EMAIL	Email Campaign requesting customer to call in or go to web via link on email
FB DROP RSN-FINAL BILLED	
MV DROP RSN-CUSTOMER MOVING	
NP DROP RSN-NON-PAYMENT	
PI SALES SRC-PHONE INBOUND	Customer became aware of the program and is calling into Care Center for additional information and elects to signup
PO SALES SRC-PHONE OUTBOUND	Outbound GMEC telemarketing campaign
PR DROP RSN-PRICE	
RE SALES SRC-RE-ESTABLISH PROG	Customer who was removed from SE program and is re-enrolling Events with a SE booth that enrolls customers on the spot using enrollment forms Customer may take a brochure and enroll at a later date.
SF SALES SRC-STOREFRONT	Unknowns
SO SALES SRC-OTHER,ENTER RMKS	Unknowns
SP SALES SRC-SPECIAL EVENT	Community Events (Sunfest , Earthday)
ST SALES SRC-TRANSFER SERVICE	Program stays with Account if address changes in territory
WB SALES SRC-WEBSITE	www.fpl.com/sunshine
ZZ SALES SRC-FPL Employee	FPL Employee Signup Initiatives

**Exhibit B
Sunshine Energy YTD Revenues and Expenses**

Green Power Project - 2004 Program Activity \$\$ "SUNSHINE ENERGY"														
Account Description	Ferc Acct	TOTAL	Jan	Feb	Mar	Apr	May	Jun	Jul	Aug	Sep	Oct	Nov	Dec
Green Power Pricing-O&M Expenses	908.265	\$471,999.35	3,576.64	2,911.23	8,829.68	18,452.83	23,463.12	33,020.99	49,058.74	50,427.12	54,734.77	63,621.70	74,734.00	89,368.53
Green Power Pricing-P&W Benefits	928.211	\$ 4,590.26		658.88	439.81	455.20	455.20	(138.33)	340.00	1,073.38	371.00	170.03	255.00	510.09
GREEN PRICING PROGRAM		\$476,589.61	\$3,576.64	\$3,570.11	\$9,069.49	\$18,908.03	\$23,918.32	\$32,882.66	\$ 49,398.74	\$ 51,500.50	\$ 55,105.77	\$ 63,791.73	\$ 74,989.00	\$ 89,878.62
REVENUE ACCOUNTS:														
Res. Sales	440.030	(\$514,624.39)	(117.00)	(1,501.50)	(13,962.00)	(20,777.25)	(25,184.25)	(39,780.00)	(50,885.25)	(54,608.89)	(60,354.00)	(70,175.18)	(83,758.60)	(93,520.47)
Res. Sales - Public Authority	440.080	\$0.00	0.00	0.00	0.00	0.00	0.00	0.00	0.00	0.00	0.00	0.00	0.00	0.00
Commercial Sales	442.130	\$0.00	0.00	0.00	0.00	0.00	0.00	0.00	0.00	0.00	0.00	0.00	0.00	0.00
Commercial Sales - Public Authority	442.180	\$0.00	0.00	0.00	0.00	0.00	0.00	0.00	0.00	0.00	0.00	0.00	0.00	0.00
Industrial Sales	442.230	\$0.00	0.00	0.00	0.00	0.00	0.00	0.00	0.00	0.00	0.00	0.00	0.00	0.00
Industrial Sales-Public Authority	442.280	\$0.00	0.00	0.00	0.00	0.00	0.00	0.00	0.00	0.00	0.00	0.00	0.00	0.00
Other Sales to Pub Authority	445.030	\$0.00	0.00	0.00	0.00	0.00	0.00	0.00	0.00	0.00	0.00	0.00	0.00	0.00
Public Authority-Railway Sales	446.080	\$0.00	0.00	0.00	0.00	0.00	0.00	0.00	0.00	0.00	0.00	0.00	0.00	0.00
REVENUES		(\$514,624.39)	(117.00)	(1,501.50)	(13,962.00)	(20,777.25)	(25,184.25)	(39,780.00)	(50,885.25)	(54,608.89)	(60,354.00)	(70,175.18)	(83,758.60)	(93,520.47)
Program Expenses - (Not of Revenues)		(\$38,034.78)	\$3,459.64	\$2,068.61	(\$4,892.51)	(\$1,869.22)	(\$1,265.93)	(\$6,897.34)	(\$1,486.51)	(\$3,108.39)	(\$5,248.23)	(\$6,383.45)	(\$8,769.60)	(\$3,641.85)

Sales Channels - Detail Information

2004 YE SE Monthly Goals.xls

Initiative	Description	Areas Affected	# of Customers involved	# of drops	Sign Up Target		Date of Initiative	Comments
					Goal	Actual/TD		
Direct Sales	Edison Festival of Light	West					January 31-February 22	
Direct Sales	Collier County Fair	West					January 31-February 8	
Direct Sales	Collier-Seminole Pioneer Festival	West					February 21-22	
Direct Sales	Naples Home and Design Expo	West					February 24-25	
Direct Sales	Southwest Florida and Lee County Fair	West					February 27-March 7	
Direct Sales	Artfest Ft Meyers	West					February 28-29	
Direct Sales	Sarafolk Concert	West					February 28	
Direct Sales	Martin County Fair	Martin					Feb 13-22	
Direct Sales	Palm Beach Flower Show	Palm Beach					Feb 19-22	
Direct Sales	Street Painting Fest	Jupiter					March 28-29	
Direct Sales	Hatsume	Delray					Feb 28-29	
Direct Sales	Tropical Marathon	Miami						
Direct Sales	FL Renaissance Fest	Miami					All month	
Direct Sales	Coconut Grove Fest	Coconut Grove					Feb 14-17	
Bill Inserts	Bill insert to FPL customers	ALL	1.8 million	1	525	91	February 17-March 3	Believe this "actual" is incorrect. Awaiting reports.
Outbound	Telemarketing to FPL	ALL					March 5+	Starting slow, but picking up steam. Working on revisions to script (awaiting changes).
Direct Sales	Jupiter Green Market	Jupiter					6-Mar	
Direct Sales	River Fest	Jupiter					7-Mar	
Direct Sales	Palm Beach Green Market	Palm Beach					7-Mar	
Direct Sales	Stuart Green Market	Stuart					7-Mar	
Direct Sales	Irish Fest	West Palm Beach					March 12-14	
Direct Sales	Stuart Green Market	Stuart					14-Mar	
Direct Sales	Palm Beach Green Market	Palm Beach					14-Mar	
Direct Sales	Palm Beach Seafood Fest	West Palm Beach					March 19-21	
Direct Sales	Medeivele Faire	Boynton Beach					March 20-21	
Direct Sales	Stuart Green Market	Stuart					21-Mar	
Direct Sales	Marlins Spring Training	Jupiter					All month	
Direct Sales	Pride Fest	Lake Worth					March 27-28	
Direct Sales	WPB Home Show	West Palm Beach					March 25-28	
Direct Sales	Las Olas Art Fair	Ft. Lauderdale					March 6 & 7	
Direct Sales	Dania Tomato Fest	Dania Beach					March 13 & 14	
Direct Sales	Coconut Grove Grn Mark	Coconut Grove					13-Mar	
Direct Sales	Lauderdale Craft Show	Lauderdale					March 20 & 21	
Direct Sales	Coconut Grove Grn Mark	Coconut Grove					20-Mar	
Direct Sales	The Falls Mall	Kendall					20-Mar	
Direct Sales	The Falls Mall	Kendall					21-Mar	
Direct Sales	Coconut Grove Grn Mark	Coconut Grove					27-Mar	
Direct Sales	The Falls Mall	Kendall					27-Mar	
Direct Sales	Fiesta Ft. Lauderdale	Ft. Lauderdale					28-Mar	
Direct Sales	Miami Fitness Festival	Miami					March 25-28	

Q.

To the best of FPL's knowledge, has Green Mountain ever sought certification with Green-e Energy or any other standards organization?

A.

No. Green tag generators can seek green certifications such as "Green-e" for their products. For Sunshine Energy, Green Mountain was a green tag broker, not a generator. Green tag brokers do not seek certification of renewable products. Based on this information, we would not expect Green Mountain to seek Green-e or other similar certification from standards organization as it relates to Sunshine Energy.

FPL regularly received from Green Mountain "attestation statements" from the renewable energy producers that sold their RECs to Green Mountain. Each attestation statement provides details associated with the purchase, such as the fuel used to produce the renewable energy and the period of time during which the renewable energy was generated. In addition the attestation statements from the renewable energy producers included that under penalty of perjury, each producer attests therein that the energy attributes are sold once and only once.

Q.

To the best of FPL's knowledge, has Green Mountain ever been denied certification by any standards organization?

A.

We are not aware of Green Mountain ever being denied certification by any standards organization. For the purposes of the Sunshine Energy Program, we would not expect Green Mountain to seek Green-e certification.

**Florida Power & Light Company
Docket No. 070626-EI
Staff's Data Request 9-5-08
Interrogatory No. 4
Page 1 of 1**

Q.

Did FPL require Green Mountain to operate pursuant to a Code of Conduct? Please provide a copy of any code of conduct FPL may have required of the Green Mountain contract.

A.

Green Mountain was expected to abide by the provisions of the contract with FPL. Included within the contract is section 13.5 requiring Green Mountain to "Market the Branded Product in compliance with applicable federal, state and local laws, including any FPSC regulations requiring advertising materials to disclose product content information."

Florida Power & Light Company
Docket No. 070626-EI
Staff's Data Request 9-5-08
Interrogatory No. 5
Page 1 of 1

Q.
Did FPL require Green Mountain to abide by any customer disclosure requirements? Please provide a copy of any customer marketing disclosure requirements that were applied to the Green Mountain contract.

A.
Yes. Additionally, all customer disclosure language was jointly developed by Green Mountain and FPL. This language was reviewed and approved by the PSC staff on January 20, 2004 as evidenced in the attached e-mail as follows:

"Judy Harlow"
<JHarlow@PSC.STATE
.FL.US>

01/20/2004 02:54 PM

To: "Millie_Gonzalez@fpl.com" <Millie_Gonzalez@fpl.com>
cc: "Tom Ballinger" <TBalling@PSC STATE FL US>, "Lorena Holley"
<LHolley@PSC.STATE.FL.US>
Subject: FW: FPL Green Power Pricing Project - Docket 030752

Staff has reviewed the attached marketing materials as revised based on our Friday, January 16, 2004 conversation. We believe that, as required by Order No. PSC-03-1442-TRF-EI, the materials adequately indicate that the program is based primarily on renewable energy credits and these credits may be obtained from out-of-state generators. Therefore, the attached versions of the marketing materials for FPL's Sunshine Energy program (with the minimal revisions to the Spanish versions discussed today) are administratively approved.

Judy Harlow
Economic Analyst
Division of Economic Regulation
Florida Public Service Commission
(850) 413-6842

Please see the attachments

FPSC

DATA

REQUEST

NO. 5

***5* ATTACHMENTS**

From: Millie_Gonzalez@fpl.com [mailto:Millie_Gonzalez@fpl.com]
Sent: Friday, January 16, 2004 4:42 PM
To: JHARLOW@PSC.STATE.FL.US
Cc: Dennis_Brandt@fpl.com; charles.guyton@steelhector.com;
Joshua_Bass@fpl.com; tballing@PSC.STATE.FL.US
Subject: FPL Green Power Pricing Project - Docket 030752

Judy,

Attached are the revised marketing materials based on our conversation today. Please confirm your approval of these documents by responding to this e-mail. We thank you once again for your feedback in this matter.

(See attached file: FPL_bro_eng_116.pdf) (See attached file: FPL_bro_esp116.pdf) (See attached file: fpl_signup_spanish_116.pdf) (See attached file: fpl_signup_english_116.pdf)

Thanks,
Millie Gonzalez
Regulatory Affairs Coordinator



FPL_bro_eng_116.pdf FPL_bro_esp116.pdf fpl_signup_spanish_116.pdf fpl_signup_english_116.pdf

PLEASE SEE ATTACHED

DIVIDER

BLANK

PAGE

The choice is simple

Of all things you can do to help preserve the environment, choosing Sunshine Energy is one of the easiest. Just sign up for the Sunshine Energy program and each month it will be included on your electricity bill. And it costs less than you might think: only \$9.75 more per month – about the cost of a pizza.

Sign up today

Enrolling for Sunshine Energy is simple and takes just a few minutes. Just choose from three easy ways to sign up and make the choice for cleaner electricity today.

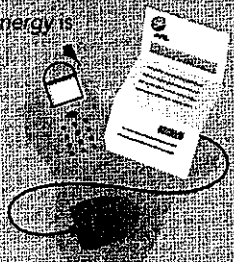

Three easy ways to enroll:

- ① **By phone:** 1-888-FPL-GREEN (1-888-375-4733)
- ② **On the web:** www.FPL.com/sunshine
- ③ **In person:** Look for a FPL Sunshine Energy sales representative at an event or storefront near you.

sunshinenergy

Frequently asked questions

How does it work? Regardless of your actual electricity usage each month, your Sunshine Energy purchase represents the environmental credits associated with 1000 kWh of electricity produced by cleaner electric generators serving Florida and other states nationwide. Your purchase supports the environmental benefits to the regions where the cleaner generators are located.

Will choosing Sunshine Energy affect the reliability of my electricity service?

No. Your service reliability is not affected by the particular generation resources you are supporting. Your electricity service will not change.

What is bioenergy? Bioenergy is cleaner energy than many typical forms of generation and includes energy from organic resources and energy crops or the natural decomposition of organic materials. Bioenergy is one of the most promising forms of renewable energy for Florida and the Southeast, where wind, hydro, and geothermal energy potential is limited by geography.



©2003 Sunshine Energy is a registered service mark of FPL Energy Services, Inc.



Choose sunshinenergy and help preserve the environment



Choose cleaner electricity with the future in mind

Choosing the Sunshine EnergySM program from Florida Power & Light is an easy way to help preserve the environment for future generations. *Sunshine Energy* promotes cleaner electricity generation that is less polluting than the fossil fuel sources most widely used across the United States.

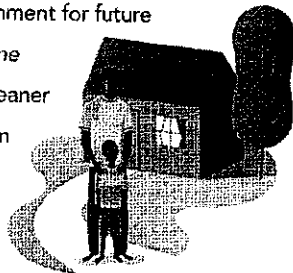

By choosing *Sunshine Energy*, you can:

- Reduce air pollution caused by generating electricity in Florida and nationwide.
- Support cleaner sources of energy generation.
- Make the development of new solar energy facilities in Florida a reality.

To enroll, just call **1-888-FPL-GREEN** (1-888-375-4733) or visit www.FPL.com/sunshine.

sunshinenergySM

Support cleaner ways of making electricity

The *Sunshine Energy* program features cleaner generation sources including bioenergy and wind, plus small amounts of solar. Supporting new renewable generation sources helps to reduce the demand for electricity generated from fossil fuels.

Help harness the Florida sunshine

Spurring the development of new renewable facilities in the state is one mission of this program. How will we do this? For every 10,000 customers who sign up for *Sunshine Energy*, we will build 150 kw of solar right here in Florida. This represents electricity generation of approximately twice the capacity of the solar facility at EPCOT – one of Florida's largest.

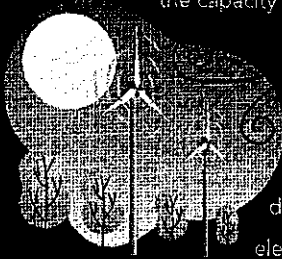

Additionally, as demand for cleaner electricity increases, more renewable facilities will likely be built to meet the demand.

Help preserve the environment

One of the most important things you can do to reduce air pollution is to choose *Sunshine Energy* from FPL. In just one year as a *Sunshine Energy* customer, you can prevent over 10,000 pounds of carbon dioxide (CO₂) emissions nationwide – as much as your car would produce in over 11,000 miles of driving.



Why does choosing Sunshine Energy help?

Nationally, fossil fuels are used in generating electricity to meet the energy demands of American businesses and residents, which causes billions of tons of carbon dioxide emissions. FPL has been a leader in developing programs and renewable sources of electricity to help reduce our nation's reliance on fossil fuels. The *Sunshine Energy* program enables FPL customers to join the effort by exercising their power as consumers.



DIVIDER

BLANK

PAGE



El escoger es fácil

De todas las cosas que puede hacer para ayudar a conservar el medio ambiente, escoger *Sunshine Energy* es una de las más fáciles. Simplemente seleccione el programa de *Sunshine Energy* y esta será incluida en su cuenta de electricidad cada mes. Y cuesta menos de lo que usted piensa, solamente \$9.75 más al mes – el valor de una pizza más o menos.

Inscríbase hoy mismo

Inscribirse en *Sunshine Energy* es fácil y toma solamente unos minutos. Seleccione entre estas fáciles maneras de inscribirse y escoga la opción de una electricidad más limpia hoy mismo.

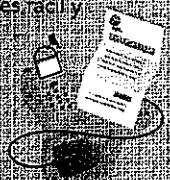

Tres maneras fáciles para inscribirse:

- ① **Por teléfono:**
1-888-FPL-GREEN (1-888-375-4733)
- ② **Por la Internet:**
www.FPL.com/sunshine
- ③ **En persona:** Busque a un representante de ventas de *FPL Sunshine Energy* en algún evento o en una tienda cerca de usted.

sunshinenergy

Preguntas frecuentes

¿Cómo funciona? Sin importar cual es su consumo actual de electricidad mensual, su compra de *Sunshine Energy* representa los créditos medioambiental asociado con 1,000 kWh de electricidad producida por generadores de energía más limpia sirviendo a la Florida y otros estados nacionalmente. Su compra apoya beneficios al medio ambiente en las regiones donde los generadores están localizados.

Si escojo *Sunshine Energy*, ¿se afectaría la confiabilidad de mi servicio de electricidad? No, La confiabilidad de su servicio no sería afectada por la fuente de generación en particular que usted está apoyando. Su servicio de electricidad no cambiaría.

¿Que es bio-energía? Bio-energía es una energía más limpia que las otras maneras típicas para generar e incluye energía de fuentes orgánicas y energía cosechada, o de la descomposición natural de materiales orgánicos. Bio-energía es una de las formas más prometedoras de energía renovable para la Florida y el Suroeste, donde la posibilidad de energías de viento, hidro y geotermales son geográficamente limitadas.

83626-0311

©2003 *Sunshine Energy* es una marca registrada de servicio de *FPL Energy Services, Inc.*



Escoja sunshinenergy y ayude a conservar el medio ambiente

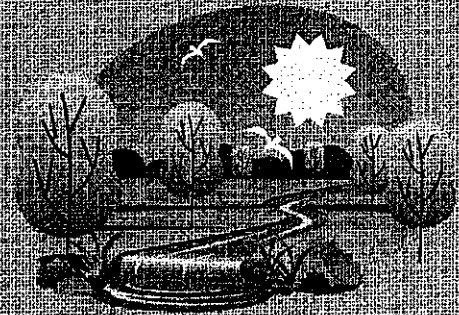

Seleccione la electricidad más limpia con el futuro en mente

Escoger el programa *Sunshine Energy*SM de Florida Power & Light es una manera fácil de ayudar a conservar el medio ambiente para las generaciones futuras.

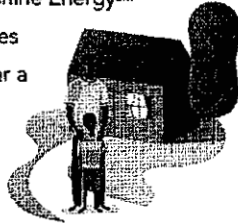

Sunshine Energy promueva una forma más limpia de generar electricidad, contaminando menos que las fuentes fósiles que normalmente se usan a través de los Estados Unidos.

Al escoger *Sunshine Energy*, usted puede:

- Disminuir la contaminación del aire ocasionada al generar electricidad en la Florida y toda la nación.
- Apoyar fuentes para generar electricidad más limpia.
- Hacer que el desarrollo de instalaciones nuevas para energía solar sean una realidad en la Florida.

Para inscribirse, llame al
1-888-FPL-GREEN (1-888-375-4733)
 o visítenos en www.FPL.com/sunshine

sunshinenergySM

Apoye maneras más limpias para producir electricidad

El programa *Sunshine Energy* presenta fuentes para generar electricidad más limpias, incluyendo la bio-energía y el viento, además de pequeñas cantidades solares. Apoyar fuentes nuevas renovables de generar electricidad ayuda a reducir la demanda de electricidad generada por combustibles fósiles.

Ayude a aprovechar el sol de la Florida

La misión de este programa es estimular el desarrollo de instalaciones nuevas renovables en el estado.



¿Cómo lo haremos? Por cada 10,000 clientes que se inscriban en *Sunshine*

Energy, construiremos 150 kw.

de energía solar aquí mismo en la Florida. Esto representa electricidad generada de aproximadamente dos veces la capacidad solar de la instalación en EPCOT – una de las instalaciones más grandes de la Florida. Además, conforme las demandas de una electricidad más limpia aumentan, seguramente se construirán más instalaciones renovables para cumplir con estas demandas.

Ayude a conservar el medio ambiente

Una de las cosas más importante que puede hacer para reducir la contaminación del aire es escoger el programa

Sunshine Energy de FPL.

En tan solo un año como cliente de

Sunshine Energy, usted

puede prevenir las emisiones

en todo el país de 10,000 libras

de dióxido de carbono (CO₂) – tantas como

las que su automóvil produciría al conducirlo 11,000 millas.

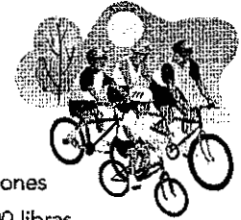

¿Cómo puede usted ayudar seleccionando *Sunshine Energy*?

Nacionalmente, los combustibles de fósiles son usados para generar electricidad y satisfacer las demandas de energía de los comerciantes y residentes del país. Esto ocasiona billones de toneladas de emisiones en dióxido de carbono. FPL ha sido un líder en desarrollar programas y fuentes de electricidad renovables para reducir nuestra dependencia nacional en combustibles de fósiles. *Sunshine Energy* ofrece la oportunidad a los clientes de FPL de unirse a este esfuerzo al ejercitar su poder como consumidores.



DIVIDER

BLANK

PAGE



Si, escojo Sunshine EnergySM de Florida Power & Light.

Quiero ayudar a preservar el medio ambiente para generaciones futuras y sé que ser un cliente de *Sunshine Energy* por un año, yo puedo evitar más de 10,000 libras de emisiones de CO₂ nacionalmente, las que produciría un automóvil al conducirlo más de 11,000 millas.

Por favor proporcione la información que sigue tal como aparece en su cuenta de FPL

Primero Nombre

Apellido

Dirección donde se recibe el Servicio

Número de apartamento

(la dirección actual donde se recibe el servicio de FPL)

Ciudad

Estado

Código Postal

Teléfono de la Casa

Teléfono del Trabajo

Otro Teléfono

Correo electrónico

Al firmar abajo, estoy de acuerdo en inscribirme en *Sunshine Energy* de Florida Power & Light. Tengo 18 años o más y estoy autorizado (a) a hacer cambios a esta cuenta de FPL. Entiendo que pagaré un cargo de \$9.75 al mes por los créditos medioambiental asociado con la generación de electricidad más limpias incluyendo bio energía, viento y solar.*

(Firma)

(Fecha)

*Sin importar cual sea su consumo de electricidad cada mes, *Sunshine Energy* asegura que 1,000 kWh de electricidad es producida por fuentes de generación más limpias sirviendo a la Florida y otros estados en la nación. Su compra representa beneficios al medio ambiente en las regiones donde están localizados los generadores más limpios

For FPL use only:

Source Code _____ LOC _____

Sales Rep _____ TL _____



© 2003 *Sunshine Energy* es una marca registrada de servicio de FPL Energy Services, Inc.

MSC-120s-0312

DIVIDER

BLANK

PAGE



Yes, I choose the Sunshine EnergySM program from Florida Power & Light.

I want to help preserve the environment for future generations and realize that in just one year as a Sunshine Energy customer, I can avoid over 10,000 pounds of CO₂ emissions nationwide – as much as a car would produce in over 11,000 miles of driving.

Please provide all the following information as it appears on your FPL bill.

First Name

[Grid for First Name]

Last Name

[Grid for Last Name]

Service Address (not a P.O. Box)

Apartment No

[Grid for Service Address and Apartment No]

(the actual address that receives service from FPL)

City

State

Zip

[Grid for City, State, and Zip]

Home Phone

Work Phone

[Grid for Home Phone]

[Grid for Work Phone]

Other Phone

[Grid for Other Phone]

Email Address

[Grid for Email Address]

By signing below, I agree to enroll for Sunshine Energy from Florida Power & Light. I am 18 years or older and am authorized to make a change to this FPL account. I understand I will pay a monthly surcharge of \$9.75 for the environmental credits associated with cleaner generation sources of electricity including bioenergy, wind and solar.

Signature

Date

For FPL use only:

Source Code _____ LOC _____

Sales Rep _____ TL _____



©2003 Sunshine Energy is a registered service mark of FPL Energy Services, Inc.

MSC-120-0312

Q.

During the life of the contract, what steps did FPL take to ensure that Green Mountain was making factually accurate and appropriate statements about their product?

A.

A message map was developed, including language that was approved by the PSC staff, to provide consistent communications to customers. FPL conducted reviews of all proposed changes to marketing material and approved final versions. FPL's review of marketing material was conducted to ensure that Green Mountain was making factually accurate and appropriate statements about the product.

Sunshine Energy kept every commitment to program participants. For a voluntary contribution of \$9.75 a month -- a highly competitive rate when compared with similar programs -- Sunshine Energy promised to purchase enough renewable energy credits to offset the carbon emissions generated by 1,000 kilowatt hours of electricity consumption. That promise was kept. For every 10,000 residential customers who signed up for the program, Sunshine Energy pledged that 150 kilowatts of solar power would be built within FPL's service territory. That commitment has also been kept.

Sunshine Energy was a successful program that prevented the release of 500,000 tons of carbon dioxide into the atmosphere, which is the equivalent of removing 83,000 cars from the road.

**Florida Power & Light Company
Docket No. 070626-EI
Staff's Data Request 9-5-08
Interrogatory No. 7
Page 1 of 1**

Q.

During the life of the contract what steps did FPL take to ensure that environmental marketing claims were factually based and could be verified to the extent feasible?

A.

Environmental marketing claims were reviewed periodically by the FPL Environmental Department for the purpose of ensuring that the claims were accurate. Green Mountain used data from the US Department of Energy to develop environmental marketing claims. The Sunshine Energy advisory board, which included various environmental groups, such as the Audubon Society, the Sierra Club, and the American Lung Association, also gave input for the program.

Florida Power & Light Company
Docket No. 070626-EI
Staff's Data Request 9-5-08
Interrogatory No. 8
Page 1 of 1

Q.

During the life of the contract, did FPL conduct any type of annual verification of product sales and purchases? Please provide a copy of the result of any annual verification performed.

A.

Yes. In addition to our response to data request 1, monthly participation reports were generated by FPL and used to provide payment to Green Mountain. Attestations were provided by Green Mountain which verified that the required RECs were purchased to satisfy the customer commitment.

Attached are the year-end reports that are updated on a monthly basis, for 2004, 2005, 2006, 2007 and year-to-date 2008.

FPSC

DATA

REQUEST

NO. 8

2

ATTACHMENTS

FPL
Green Power Program - Residential
2004

Month	Total Accounts Billed	Total Blocks Billed	Total KWH Billed	Total Green Power Paid
Jan-04				
Feb-04				
Mar-04				
Apr-04				
May-04				
Jun-04				
Jul-04	5,281.00	5,281.00	5,281,000.00	47,793.30
Aug-04	5,735.00	5,735.00	5,735,000.00	50,157.53
Sep-04	6,171.00	6,171.00	6,171,000.00	56,484.39
Oct-04	7,146.00	7,146.00	7,146,000.00	65,758.98
Nov-04	8,629.00	8,629.00	8,629,000.00	76,852.36
Dec-04	9,665.00	9,665.00	9,665,000.00	92,037.22
Total	42,627.00	42,627.00	42,627,000.00	\$ 389,083.78

What appears on the On Demand Report CIS2B1124501

**FPL
Green Power Program - Residential
2005**

Month	Total Accounts Billed	Total Blocks Billed	Total KWH Billed	Total Green Power Paid
Jan-05	10,743.00	10,743.00	10,743,000.00	97,626.31
Feb-05	13,485.00	13,485.00	13,485,000.00	113,097.26
Mar-05	15,995.00	15,995.00	15,995,000.00	140,465.42
Apr-05	17,905.00	17,905.00	17,905,000.00	160,762.53
May-05	18,825.00	18,825.00	18,825,000.00	184,494.57
Jun-05	20,555.00	20,555.00	20,555,000.00	187,624.48
Jul-05	21,495.00	21,495.00	21,495,000.00	197,813.30
Aug-05	21,724.00	21,724.00	21,724,000.00	209,250.55
Sep-05	22,371.00	22,371.00	22,371,000.00	215,618.09
Oct-05	22,567.00	22,567.00	22,567,000.00	202,796.00
Nov-05	23,184.00	23,184.00	23,184,000.00	250,990.59
Dec-05				
Total	208,849.00	208,849.00	208,849,000.00	\$ 1,960,539.10

What appears on the On Demand Report CIS2BH124501

DIVIDER

BLANK

PAGE

FPL
Green Power Program - Residential
2008

Month	Cash Receipts	Blocks	YTD Blocks	Vendor Payment
Jan	297,927.38	30,557.00	30,557.00	278,066.70
Feb	321,974.32	33,023.00	63,580.00	300,509.30
Mar	318,418.74	32,658.00	96,238.00	297,187.80
Apr	328,520.00	33,797.00	130,035.00	307,552.70
May	342,351.04	35,113.00	165,148.00	319,528.30
June	377,874.53	38,756.00	203,904.00	352,679.60
July - DO NOT MAKE PAYMENT	359,522.08	36,874.00	240,778.00	335,553.40
August				
September				
October				
November				
December				
Total	\$ 2,347,588.09	\$ 240,778.00	\$ 930,240.00	\$ 2,191,079.80

FPL
Green Power Program - Business
2008

Month	Cash Receipts	Blocks	YTD Blocks	Vendor Payment
Jan	4,784.57	489.00	489.00	1,467.00
Feb	4,936.39	506.00	995.00	1,518.00
Mar	4,963.50	509.00	1,504.00	1,527.00
Apr	6,224.81	638.00	2,142.00	1,914.00
May	8,173.18	838.00	2,980.00	2,514.00
June	11,191.86	1,148.00	4,128.00	3,444.00
July - DO NOT MAKE PAYMENT	10,552.64	1,082.00	5,210.00	3,246.00
August				
September				
October				
November				
December				
Total	\$ 50,806.95	\$ 5,210.00	\$ 17,448.00	\$ 15,630.00

FPL
Green Power Program - Residential
2007

Month	Cash Receipts	Blocks	YTD Blocks	Vendor Payment
Jan	264,428.90	27,121.00	27,121.00	246,801.10
Feb	282,470.94	28,971.00	56,092.00	263,636.10
Mar	302,385.71	31,014.00	87,106.00	282,227.40
Apr	310,398.30	31,836.00	118,942.00	289,707.60
May	351,103.52	36,011.00	154,953.00	327,700.10
June	288,286.10	29,588.00	184,521.00	269,068.80
July	296,268.98	30,387.00	214,908.00	276,521.70
August	292,514.64	30,012.00	244,920.00	273,109.20
September	292,997.24	30,051.00	274,971.00	273,484.10
October	306,756.22	31,462.00	306,433.00	286,304.20
November	315,333.04	32,342.00	338,775.00	294,312.20
December	324,557.88	33,286.00	372,063.00	302,920.80
Total	\$ 3,527,501.47	\$ 372,063.00	\$ 2,380,805.00	\$ 3,385,773.30

FPL
Green Power Program - Business
2007

Month	Cash Receipts	Blocks	YTD Blocks	Vendor Payment
Jan	-	-	-	-
Feb	-	-	-	-
Mar	-	-	-	-
Apr	571.05	59.00	59.00	177.00
May	654.41	67.00	126.00	201.00
June	1,834.41	188.00	314.00	564.00
July	1,889.34	194.00	508.00	582.00
August	2,739.63	281.00	789.00	843.00
September	2,925.78	300.00	1,089.00	900.00
October	3,186.78	327.00	1,416.00	981.00
November	3,423.34	351.00	1,767.00	1,053.00
December	3,798.37	390.00	2,157.00	1,170.00
Total	\$ 21,023.11	\$ 2,157.00	\$ 8,225.00	\$ 6,471.00

FPL
Green Power Program
2006

Month	Cash Receipts	Blocks	YTD Blocks	Vendor Payment
Jan	228,740.39	23,461.00	23,461.00	213,495.10
Feb	223,578.46	22,931.00	46,392.00	208,872.10
Mar	223,915.75	22,966.00	69,358.00	208,990.60
Apr	238,597.18	24,472.00	93,830.00	222,695.20
May	238,737.00	24,485.00	118,315.00	222,813.50
Jun	237,462.79	24,356.00	142,671.00	221,639.60
Jul	248,785.29	25,516.00	168,187.00	232,195.60
Aug	242,814.29	24,904.00	193,091.00	226,626.40
Sep	248,108.85	25,447.00	218,538.00	231,567.70
Oct	253,804.51	26,031.00	244,569.00	236,882.10
Nov	282,904.24	29,016.00	273,585.00	264,045.60
Dec	283,773.73	29,105.00	302,690.00	264,855.50
Total	\$ 2,931,222.48	\$ 302,690.00	\$ 1,894,687.00	\$ 2,754,479.00

Florida Power & Light Company
Docket No. 070626-EI
Staff's Data Request 9-5-08
Interrogatory No. 9
Page 1 of 1

Q.

During the life of the contract, did FPL conduct a review of the marketing materials used by Green Mountain? Please explain or provide a copy of the results of any marketing review FPL may have conducted on Green Mountain.

A.

Yes. FPL reviewed all marketing material provided by Green Mountain. A message map was developed, including language that was approved by the PSC staff, to provide consistent communications to customers. FPL provided the marketing materials to the PSC Staff as requested. Please review our response to data request 5. The review of all marketing material was done in the following manner. Draft marketing material was sent by Green Mountain to FPL's Marketing and Product Management Departments for review. FPL reviewed the draft language to ensure that it was consistent with the message map including disclosure requirements approved by the PSC Staff. Feedback was provided to Green Mountain by FPL to prepare a final version for FPL's approval.

**Florida Power & Light Company
Docket No. 070626-EI
Staff's Data Request 9-5-08
Interrogatory No. 10
Page 1 of 1**

Q.

Please provide any written criteria used by FPL to evaluate the marketing material of Green Mountain.

A.

FPL used the message map that was developed for the program to evaluate all the marketing materials submitted by Green Mountain. The message map included the PSC staff approved disclosure language is attached. In addition, FPL used the contract and program tariff to perform these evaluations.

FPSC

DATA

REQUEST

NO. 10

1 ATTACHMENT

Message Map
Florida Power & Light Sunshine Energy® Program

V1.7
January 2008

Table of Contents

Introduction	3
What is a Message Map?	
Why Do We Need One?	
What is Not Included?	
How to Use This Message Map	
Prospective Customer Messaging	4
Primary Messaging	
Secondary Messages/Reasons to Believe	
<i>Cleaner/Environmental Impact Messaging</i>	
<i>Leadership Messaging</i>	
<i>Easy/Convenient Messaging</i>	
<i>Pricing Messaging</i>	
Existing Customer Messaging will be developed closer to the launch of the program and will be based on the approved Prospective Customer Messaging	
Questions and Answers	7

Introduction

What is a Message Map?

A message map is a document that delineates a set of positioning statements associated with a brand, program, partnership, or product. Copywriters, sales managers, and marketing professionals of consumer brands commonly use message maps as tools to help build and maintain cohesive advertising, promotion, and selling.

Why Do We Need One?

Using a Message Map facilitates the following:

- **Consistency**: Message maps, while flexible, are also limiting. They set forth a core set of messages which should be used at every turn.
- **Efficiency**: Recorded, agreed upon, and legally reviewed messaging makes copy review procedures much faster.
- **Strength**: Message maps are based on research and in-market experience so that they contain the most compelling and effective selling and retention propositions.

What is Not Included in a Message Map?

Message maps primarily contain marketing messaging. While there is certainly overlap between marketing, public relations, and sales messaging, there is additional messaging for individual channels that exists outside of this document.

How to Use this Message Map

This map contains messages specifically for FPL's "green pricing" program. It should be used in conjunction with the *FPL Collateral Guidelines for Customer Communications*, which provide details on how to craft effective finished messages and materials that follow FPL brand standards. However, neither this message map nor the collateral guidelines replace existing copy review processes or supercede any applicable legal or environmental requirements.

This message map is separated into messages for prospective customers and messages for existing customers. Certain claims, marked with a (I), require additional explanation to complete the claim if they are to be used. The accompanying required concepts must appear immediately or in proximity in the copy any time these claims are made. It is important to strictly adhere to these requirements in order to comply with legal and environmental regulations. Throughout the message map, footnotes specify where qualification and clarification language is needed.

Messages for prospective and existing customers contain Limited Use Messaging, Primary Messaging, Secondary Messaging and Reasons to Believe.

Limited Use Messages: These messages have been identified as compelling marketing propositions, but may contain significant risk if not used correctly. These claims must be limited to headlines and calls to action, and should be followed or preceded by the required disclosure language.

Primary Messages: What to say to introduce the offering/s – "the view from 30,000 feet". This is the single most important message to communicate.

Secondary Messages: Ancillary messages with specific purposes. The benefits of the offerings are presented in order to answer the consumer's question – "Why should I care?" Think of each secondary message beginning with "You should care because..."

Reasons to Believe: While the benefits outlined in a secondary message may be compelling, these points support and validate them. Think of each reason to believe beginning with "It's true because..."

MESSAGING FOR PROSPECTIVE AND EXISTING CUSTOMERS

Limited Use Messages

Note: In accordance with legal and environmental guidelines, these messages should be used only in headlines or calls to action that are followed or preceded by the required disclosure language.

Make the choice for cleaner electricity. (I¹,)
Choose cleaner electricity. (I¹)

I¹: When comparative terms like "cleaner" are used, the comparison must be completed in the copy. Comparative claim can be written as: "Sunshine Energy features generation sources that are cleaner than most energy resources used in the U.S."

Primary Messages

Choose Sunshine Energy[®] and help preserve the environment for future generations. (I³,I⁴)

I³: When the claim "help preserve the environment" is used, the following language is required in proximity to qualify the claim: **In just one year as a Sunshine Energy customer, you can avoid over 10,800 pounds of CO₂ emissions – as much as a car would produce in over 12,000 miles of driving.**"

I⁴: In the first instance, and all bold instances of "Sunshine Energy[®]", the writer should use "The Sunshine Energy[®] program"

Required Message (how it works)

For each month that you participate in the Sunshine Energy program, FPL ensures that 1,000 kWh of cleaner electricity from sources like wind, bio-energy and solar is produced by generators in Florida and other states nationwide. Your participation in the program creates important environmental benefits in the areas where this cleaner, renewable electricity is generated. (I⁵, I⁶, I⁷)

I⁵: This text is required in all printed and online marketing materials, including storefront and sign-up materials.!

I⁶: This is not to be used in small type at the bottom of pieces, but rather in main copy.

I⁷: When possible, use words like "participate in" and "choose" Sunshine Energy as opposed to "purchase"

Secondary Messages/Reasons to Believe

Cleaner/Environmental Impact Messaging

Secondary Message	Reason to Believe
<p>As an FPL customer, you can help preserve the environment by Sunshine Energy and supporting cleaner electricity(I⁶).</p>	<p>One of the most important things you can do to reduce air pollution is to choose Sunshine Energy from FPL. In just one year as a Sunshine Energy customer, you can avoid over 10,800 pounds of CO₂ emissions – as much as a car would produce in over 12,000 miles of driving.</p>

You can help preserve natural resources by choosing <i>Sunshine Energy</i>.	Supporting new renewable generation sources helps to reduce the demand for electricity generated from limited fossil fuels.
<i>Sunshine Energy</i> promotes cleaner generation sources like bioenergy, wind, and solar.	These energy sources are less polluting than fossil fuel sources most widely used across the U.S.
<i>Sunshine Energy</i> customers are making a positive impact on the environment.	<p>Since the program's inception in 2004, FPL customers choosing the <i>Sunshine Energy</i> program have helped avoid over 756 million pounds of carbon dioxide, the primary greenhouse gas that contributes to global warming. To put this in perspective, that has the equivalent environmental impact of taking over 67,000 cars off the road for one year or planting over 45 million trees¹.</p> <p>¹This refers to the number of trees it would take to sequester that much carbon in one; this language MUST accompany this message in all communications.</p>

¹Bioenergy definition, if needed: Bioenergy is renewable energy generated from organic matter and the natural decomposition of organic matter, and includes energy generated from pulp and paper waste, landfill gas and energy crops.

¹⁵This message requires the bold text under Reason to Believe.
Leadership Messaging

<i>Secondary Message</i>	<i>Reason to Believe</i>
FPL is proud to be one of the nation's premier utilities committed to energy efficiency and cleaner energy technologies.	<p>FPL believes that greater conservation and use of cost-effective renewable resources is good for our nation, and that the ongoing development of cleaner energy technologies is a worthy pursuit.</p> <ul style="list-style-type: none"> • FPL supports individual customer lifestyle choices such as this cleaner electricity choice program. • FPL also actively pursues research and development programs that build new cleaner energy technologies and facilities designed to reduce our nation's reliance on fossil fuels.
FPL's interest in cleaner power extends beyond just this program.	FPL Energy, a subsidiary of FPL Group, is the largest owner and operator of wind power in the world and of the nation's largest solar facility (in California). FPL Group also uses smaller amounts of solar, geothermal, hydro and bioenergy to produce electricity.
FPL Group is a proud member of the U.S. Climate Action Partnership	In January of '07, FPL Group joined with other major U.S. businesses and leading environmental organizations in calling on the federal government to enact strong national legislation to significantly reduce greenhouse gas emissions.

Personal Impact

<i>Secondary Message</i>	<i>Reason to Believe</i>
--------------------------	--------------------------

<p><i>Building Solar/New Renewables</i></p> <p>When you choose FPL's <i>Sunshine Energy</i>, you are helping to make the construction of new solar projects in Florida a reality.</p>	<p>Because Florida's renewable resources are limited, some of the cleaner generation facilities <i>Sunshine Energy</i> supports are located in other states. Currently, more than half of the renewable energy is generated in Florida.</p> <p>Supporting the development of new renewable facilities in Florida is one of the missions of the program. As part of the <i>Sunshine Energy</i> program, FPL is committed to building solar projects right here in Florida!</p> <p>In fact, because of <i>Sunshine Energy</i> customers, Florida's largest solar facility (250 kW) was built at Rothenbach Park in Sarasota County. And there are an additional 200 kW in various stages of development. <i>Sunshine Energy</i> solar electric projects include 40 kW of rooftop solar being installed on new homes in Naples, financial incentives for up to 150 kW of new residential and commercial p.v. systems, a 2 kW system at the Miami Science Museum, two Publix Greenwise Supermarkets in West Palm Beach and Boca Raton and solar arrays at the following four SunSmart schools:</p> <p>MAST Academy, 7393 Rickenbacker Causeway, Miami, FI 33149</p> <p>South Miami Senior High, 6856 SW 53rd St., Miami, FL 33155</p> <p>Palm City Elementary School, 195 SW 34th St., Palm City, FL 34990</p> <p>Edgewood Jr./Sr, High School, 180 E. Merritt Ave., Merritt Island, FL 32952</p>
<p><i>Household Pollution</i></p> <p>One of the most impactful and easy things you can do to cut your household's share of greenhouse gas emissions is choosing <i>Sunshine Energy</i> from FPL.</p>	<p>According to the EPA, few people realize that the average home is responsible for more CO₂ emissions than the average car.</p>
<p><i>Climate Change</i></p> <p>As a <i>Sunshine Energy</i> customer, you can do your part to help fight climate change.</p>	<p>Traditional fossil-fuel electricity production is one of the largest sources of excess carbon dioxide (CO₂) emissions. CO₂ is a greenhouse gas that contributes to climate change. In just one year as a <i>Sunshine Energy</i> customer, you can avoid over 10,800 pounds of CO₂ emissions. This is a significant reduction in the average American household's share of CO₂ emissions.</p>

Easy/Convenient/Sign-Up Messaging

<p><i>Secondary Message</i></p>	<p><i>Reason to Believe</i></p>
---------------------------------	---------------------------------

<p>Choosing <i>Sunshine Energy</i> is one of the easiest things you can do to help preserve the environment for future generations.</p>	<p>In just one year as a <i>Sunshine Energy</i> customer, your household can prevent as much carbon dioxide (CO₂) from entering the air as a car makes in over 12,000 miles of driving. And all you have to do is sign up for the <i>Sunshine Energy</i> program and pay your FPL electric bill - like you already do each month.</p>
<p>Choosing <i>Sunshine Energy</i> is easy. It takes less than 10 minutes to enroll. (1⁶)</p>	<p>You can sign up for FPL's <i>Sunshine Energy</i> program by phone, by mail, or online. (1-888-FPLGREEN; www.fplsunshineenergy.com)</p> <p>-OR-</p> <p>Look for a Florida Power & Light (FPL) <i>Sunshine Energy</i> representative near you.</p>

⁶: The formal language around sign up must follow the following example: By signing below, I agree to enroll for *Sunshine Energy* from Florida Power & Light. I am 18 years or older and am authorized to make a change to this FPL account. I understand I will pay an additional amount of \$9.75 for the renewable energy associated with cleaner generation sources of electricity like bioenergy, wind and solar.

Pricing Messaging

<i>Secondary Message</i>	<i>Reason to Believe</i>
<p>Choosing <i>Sunshine Energy</i> is less expensive than you might think.</p>	<p>It costs less than \$10 more per month for the <i>Sunshine Energy</i> program.</p>
<p>The monthly cost of participating in the <i>Sunshine Energy</i> program is less expensive than buying a pizza.</p>	<p>For only \$9.75 more per month to you can support cleaner electricity generation, reduce your CO₂ emissions and help build new renewable sources of electricity.</p>

America's Reliance on Imported Energy Sources

<i>Secondary Message</i>	<i>Reason to Believe</i>
<p>Choosing renewable <i>Sunshine Energy</i> is one way you can have a positive impact on America's energy future.</p>	<p>According to the EPA, renewable energy is one way to improve the reliability and security of our energy system in the U.S.¹</p> <p>¹ http://www.epa.gov/cleanenergy/index.htm</p>

Environmental Impact Reference Table

The following summarizes the environmental impact that *Sunshine Energy* customers have had in each of years that the program has been in existence:

	CO ₂ avoided (lbs)	Carbon dioxide expressed as miles not driven	Carbon dioxide expressed as number of cars taken off the road	Trees needed to reduce equivalent CO ₂	Number of Aluminum Cans Recycled
2004 (actual)	38,200,443	42,444,937	3,396	2,294,321	

					47,016
2005 (Actual)	158,192,232	175,769,147	14,062	9,501,035	194,698
2006 (Actual)	223,770,090	248,633,434	19,890.67	13,439,645	275,409
2007 (Actual)	336,465,907	373,851,007	29,908.08	20,208,163	414,112
Total	756,628,673	840,698,525	67,256	45,443,164	931,235

Questions and Answers

Why should I care about choosing a cleaner electricity option?

Nationally, generating electricity to meet the energy demands of American businesses and residents uses limited fossil fuels and causes billions of tons of carbon dioxide emissions each year.

- FPL has voluntarily initiated this cleaner electricity choice program to help consumers do their part for a cleaner energy future.
- FPL also supports individual customer lifestyle choices such as energy conservation programs

Will choosing *Sunshine Energy* affect the reliability of my electricity service?

No. Your service reliability is not affected by the particular generation resources you are supporting. Your electricity service at your home will not change.

So, if cleaner electricity doesn't come directly to my home, what am I buying?

Regardless of your actual electricity usage each month, *Sunshine Energy* ensures that 1,000 kWh of cleaner electricity from sources such as bioenergy, wind and solar is produced by generators in Florida and other states nationwide. Your participation in the program creates important environmental benefits in the areas where this cleaner, renewable electricity is generated, including avoiding over 10,800 pounds of carbon dioxide emissions each year. Your purchase also helps keep cleaner generators operating and creates demand for new clean generation facilities to be built in the future.

What is bioenergy?

In addition the sun and wind, scientists and engineers have found ways to make electricity from a number of other renewable resources. Bioenergy, for example, is cleaner energy generated from organic resources and energy crops or the natural decomposition of organic materials. These resources are renewable since they are virtually infinite and/or replenish themselves in short periods of time. Bioenergy is one of the most promising forms of renewable energy for Florida and the Southeast, where wind, hydro, and geothermal energy potential is limited by geography.

Q.

Did FPL have any documented expectation or requirements regarding the expenditure allocation of the Sunshine Energy dollars provided to Green Mountain? For example, did FPL have any expectation as to the level of administrative and marketing expenses? If so, please provide.

A.

FPL did not provide Green Mountain with any documented expectations or requirements regarding the expenditure allocation of Sunshine Energy dollars. Based on FPL's internal analysis of the proposed program, FPL's initial estimates were that Green Mountain's marketing and administration would average approximately \$4.00 per participant per month over the life of the contract.

When FPL launched Sunshine Energy, the public awareness of 'green' was just beginning. This lack of awareness created marketing challenges. During the first two years of the program, Green Mountain invested over \$3.5 million in marketing activities made without any guarantee of future revenues or participation in the program. The marketing approaches used to educate FPL customers about the Sunshine Energy program and the benefits of being environmentally responsible included: direct mail, telemarketing, bill inserts, events, and web.

It is not unexpected to have high marketing costs in the beginning of a program with very few participants and a small revenue stream. As participation in Sunshine Energy grew, marketing costs declined. Green Mountain's experience was consistent with this concept as evidenced by the graphs below:

Marketing Costs

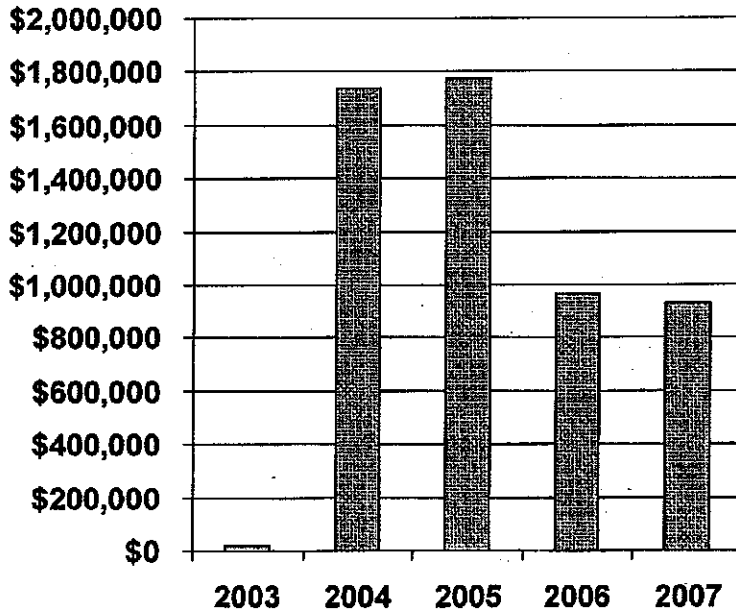

Marketing Cost

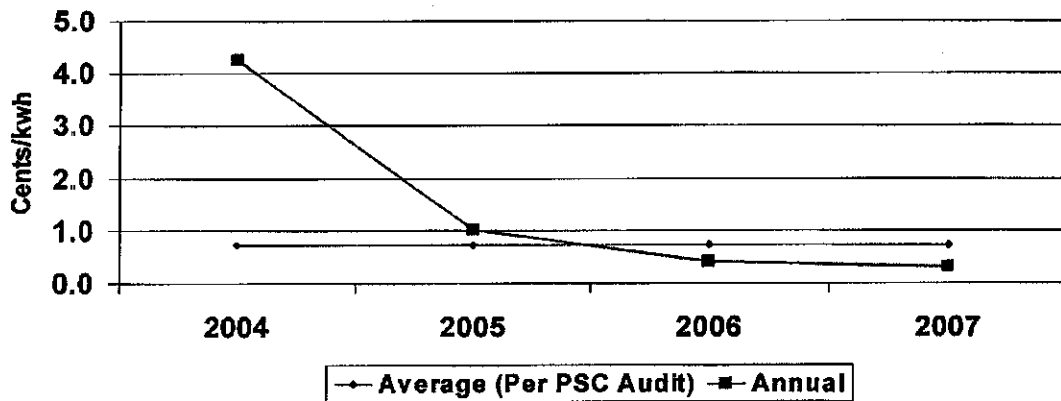

Based on information provided by Green Mountain, 52% of the revenue provided to them by FPL for Sunshine Energy was spent on sales and marketing. This translates to \$4.73 per customer per month. In addition, this estimate includes the marketing expense funded by Green Mountain in order to launch the program. Sunshine Energy has been able to grow

program participants at an average rate of 51% per year since 2004 while still offering one of the largest block sizes (1,000 kwh per month) of all green pricing programs.

Florida Power & Light Company
Docket No. 070626-EI
Staff's Data Request 9-5-08
Interrogatory No. 12
Page 1 of 1

Q.
What controls did FPL employ to ensure that these expenditure expectations or requirements were met?

A.
Please see our response to data request 11. As discussed in response to data request 11, there were no particular expenditure expectations. As a result of responses to the initial RFP, FPL elected to enter into a turn-key contract with Green Mountain, such that for \$9.10, Green Mountain was responsible for REC purchases, administration, marketing, solar construction and continued growth of the program. This was a comprehensive contract for all the required services. During the initial audit by the FPSC staff, it was found that FPL's bid process was sound, and that we selected the correct bidder.

Based on the response to the RFP and the subsequent program that was developed, FPL believes that it had a program that offered participants the lowest possible cost per kWh. Based on recent data from the National Renewable Energy Laboratory of the US Department of Energy, the price per kWh for Sunshine Energy at 0.975 cents per kWh is less than half the national average of 2.12 cents per kWh for other utility green pricing programs.

**Florida Power & Light Company
Docket No. 070626-EI
Staff's Data Request 9-5-08
Interrogatory No. 13
Page 1 of 1**

Q.

What benchmarks did FPL use to ensure an appropriate portion of the voluntary contributions went for either TRECs or solar projects?

A.

FPL developed the program based on the total cost to the customer, not the individual components. Under the contract, Green Mountain was required to ensure the purchase of RECs and the construction of solar projects. FPL monitored participation levels, the purchase of RECs and the status of the solar projects. See also the responses to data requests 11, 12 and 15.

Q.

What benchmarks did FPL use to determine the appropriate portion of the voluntary Contribution to be used for administrative expense?

A.

Please see FPL's response to data requests 11, 12 and 15. FPL developed the program based on the total cost to the customer, not the individual components. As a result of responses to the initial RFP, FPL elected to enter into a turn-key contract with Green Mountain, such that for \$9.10, per customer per month, Green Mountain was responsible for REC purchases, administration, marketing, solar construction, and continued growth of the program. This was a comprehensive contract for all the required services. At the time FPL awarded the contract, Green Mountain was recognized as one of the industry leaders in the operation and marketing of green pricing programs.

Based on the response to the RFP and the subsequent program that was developed, FPL believes that it had a program that offered participants the lowest possible cost per kWh. Based on recent data from the National Renewable Energy Laboratory of the US Department of Energy, the price per kWh for Sunshine Energy at 0.975 cents per kWh is less than half the national average of 2.12 cents per kWh for other utility green pricing programs.

Q.
What benchmarks did FPL use to determine the appropriate portion of the voluntary contribution to be used for marketing expenses?

A.
Based on Sunshine Energy's marketing costs in 2007, the program's marketing costs were favorable when benchmarked to other leading programs.

DOE Top Ten Ranking	Utility	Marketing Cost (cents/kWh)
#1	Austin Energy	Not Available
#2	Portland General Electric	0.408 ⁽³⁾
#3	PacifiCorp Blue Sky Program	1.17 ⁽⁴⁾
#4	FPL's Sunshine Energy	0.306 ⁽⁵⁾
#5	Northern States Power Company (Xcel)	0.400 ⁽⁶⁾

1) 2007 US Department of Energy National Renewable Energy Laboratory ranking of Green Pricing programs based on renewable energy sales

2) Marketing costs are based on a review of publicly available data and represent the latest information found for each utility.

3) 2004 through 2006 average for Portland General Electric

4) 2003 actual data for PacifiCorp. 2003 was the 3rd year of their program. FPL's 3rd year cost

was 0.399 cents/kwh

5) 2007 actual for FPL

6) Budget for Xcel

FPL developed the program based on the total cost to the customer, not the individual

components. Green Mountain's requirement included marketing, signing up new program participants and retaining existing participants. FPL monitored all these activities.

It is not unexpected to have high marketing costs in the beginning of a program with very few participants and a small revenue stream. As participation in Sunshine Energy grew, marketing costs have declined. Green Mountain's experience was consistent with this concept as evidenced by the graphs below:

Marketing Costs

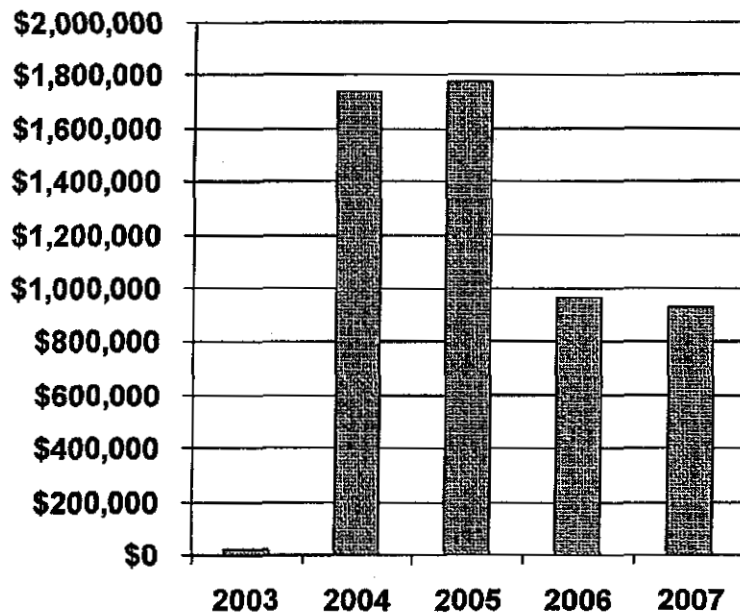

Marketing Cost

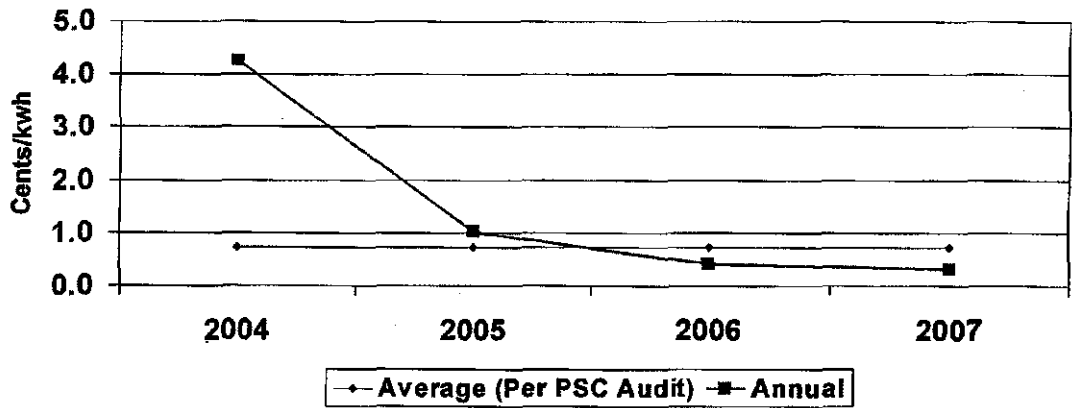

Based on information provided by Green Mountain, 52% of the revenue provided to them by FPL for Sunshine Energy was spent on sales and marketing. This translates to \$4.73 per customer per month. In addition, this estimate includes the marketing expense funded by Green Mountain in order to launch the program. Sunshine Energy has been able to grow program participants at an average rate of 51% per year since 2004 while still offering one of the largest block sizes (1,000 kwh per month) of all green pricing programs.

**Florida Power & Light Company
Docket No. 070626-EI
Staff's Data Request 9-5-08
Interrogatory No. 16
Page 1 of 1**

Q.

Please provide a copy of each script used by FPL employees for telemarketing regarding the Sunshine Energy Program. Please describe the promotional objective(s) associated with each script.

A.

FPL employees did not do telemarketing for the Sunshine Energy Program. Green Mountain was responsible for telemarketing. All scripts were reviewed and approved by FPL. The objective of telemarketing was to promote awareness of the Sunshine Energy program and the many benefits of the program, and to increase participation over time to maximize enrollment, resulting in the purchase of more RECs. Attached is an example of one of the telemarketing scripts.

FPSC

DATA

REQUEST

NO. 10

1 ATTACHMENT



Green Mountain Energy® Company FPL Outbound Script

Opening (REQUIRED)

INTRODUCTION Hello, This is (Agent first and last name) with Florida Power and Light calling to speak with (customers first and last name).

(OPENING OPTION 1)

Hello, this is (Sales reps first and last name) with FPL, How are you doing today? I am following up on some recent information you have been sent regarding our new Sunshine Energy Plan and would like to take some time to review this option with you.

(OPENING OPTION 2)

Mr/MS (Customers first and last name), as you are aware, Florida Power and Light now offers you a cleaner electricity option. FPL is proud to be one of the nation's premier utilities and is committed to energy efficiency and renewable energy technologies. We've created the Sunshine Energy option as a result of requests from customers like you

Products/Benefits (REQUIRED)

Sunshine Energy

When you sign up for FPL's Sunshine Energy, each month you support cleaner, renewable energy sources at the cost of less than 33 cents per day over 30 days.

Current rate + \$9.75 additional per month

- In signing up for *Sunshine Energy* 1,000 kwh of electricity is produced by cleaner generation facilities, such as bioenergy and wind, serving Florida and other states nationwide.
- *Sunshine Energy* is an easy way to help preserve the environment for future generations. In just one year as a *Sunshine Energy* customer, a Florida household could avoid over 10,000 pounds of carbon dioxide emissions nationwide – as much as your car would produce in over 11,000 miles of driving.
- **Spurring the development of new solar facilities in the state is one of our missions for this program. For every 10,000 customers we sign up for Sunshine Energy we will build 150 kw of solar right here in Florida.**
- *Sunshine Energy* costs only \$9.75 more per month to support cleaner electricity generation, reduce CO₂ emissions and help build new renewable sources of electricity. Buying *Sunshine Energy* each month is less expensive than buying a pizza.
- This is a set cost that does not automatically change with usage or season, so you will know how much the additional cost is.
- Choosing *Sunshine Energy* is easy. It takes less than 10 minutes to enroll.

Did you know that when you choose FPL's *Sunshine Energy*, your demand for cleaner electricity generation encourages the construction of new renewable power generation here in Florida and beyond. Because Florida's



renewable energy resources are limited, most of the cleaner generation facilities *Sunshine Energy* supports are located in other states. But part of your dollars also goes directly toward building solar facilities right here in the Sunshine State. And as customer demand continues to increase, it also encourages the development of other types of new renewable generation facilities here in Florida.

FPL Information

Customers are located in the following area codes and cities :

<u>Area Code</u>	<u>City</u>
386	Lake City, Daytona
904	St Augustine
407	Deland, Sanford
321	Melbourne, Cocoa
863	Okechobee
772	Vero Beach, St Lucie, Stuart
561	West Palm
954	Ft Lauderdale
754	Ft Lauderdale
305	Miami
786	Miami
941	Sarasota
239	Naples. Ft Myers

Closing (REQUIRED)

Choosing Sunshine Energy is easy; in fact if you change your mind, you can cancel without a penalty

Getting YOU signed up today is easy!!!! The additional cost will appear on your electric bill following your next meter reading.

QUESTIONS/ANSWERS

Why are you calling me?

We are calling to speak with you regarding our new Sunshine Energy Program and would like to speak with you about that program if you have a little time?

Why are you calling me, I am on the State /National DNC list?

We apologize for any inconvenience; we understand that you have subscribed to the State/National DNC list. As an FPL customer we need to be able to contact you regarding billing, line issues etc. , if you prefer not to be called about new marketing programs I would be happy to place you on our internal DNC list
If Yes-Dispo as DNC/State and National Subscription

My kWh rate changes seasonally.

I understand that your existing kWh rate may change with seasonality. The additional monthly cost of the Sunshine energy Program is a set additional cost of \$9.75 that will be applied to your bill for as long as you are in the program. If you have any questions about your electricity kWh rate please contact FPL Customer Care at (please provide #).



Will I get a tax break if I sign up for this program?

No. The program is not tax deductible.

The \$9.75 monthly charge goes towards the purchase of new renewable resources for the programs and administrative costs to operate the program.

Can you help me with my bill or another issue (topic outside of Sunshine Energy Program, i.e billing) question?

I am unable to assist with those questions as I calling regarding the Sunshine Energy Program and have information on only that program. You can contact our specialized Customer Care Department at (please supply number)

Why should I care about choosing a cleaner electricity option?

Nationally, generating electricity to meet the energy demands of American businesses and residents uses limited fossil fuels and causes billions of tons of carbon dioxide emissions. That's why FPL has been on the leading edge of developing innovative programs and new renewable sources of electricity to help reduce our nation's reliance on fossil fuels.

- FPL also supports individual customer lifestyle choices such as energy conservation programs and home-based solar installations.
- FPL actively pursues research and development projects that build new cleaner energy technologies and facilities, such as a "green energy" program in 1998 that resulted in development of a 10 kW solar facility that operates at our Martin plant site.

Will choosing Sunshine Energy affect the reliability of my electricity service?

No. Your service reliability is not affected by the particular generation resources you are supporting. Your electricity service at your home will not change.

So, if cleaner electricity doesn't come directly to my home, what am I buying?

Regardless of your actual electricity usage each month, *Sunshine Energy* ensures that 1,000 kwh of electricity is produced by cleaner generation facilities, such as bioenergy and wind, and solar serving Florida and other states nationwide. Your purchase represents the environmental benefits to the regions where the cleaner generation resources are located, including avoiding over 10,000 pounds of carbon dioxide emissions each year on average. Your purchase also helps keep cleaner generators operating and creates demand for new clean generation facilities to be built in the future.

What is bioenergy?

In addition to the sun and wind, scientists and engineers have found ways to make electricity from a number of other renewable resources. Bioenergy, for example, is cleaner energy generated from organic resources and energy crops or the natural decomposition of organic materials. These resources are renewable because they are virtually infinite and/or replenish themselves in short periods of time. Bioenergy is one of the most promising forms of renewable energy for Florida and the Southeast, where wind, hydro, and geothermal energy potential is limited by geography.

Do I have to sign up? No. Making this choice is strictly voluntary, taking advantage of customers demand for cleaner electricity is your choice.

What happens if I need to speak with FPL about my electric service or need to report an outage?



If you experience an outage, please call 1-800-4-OUTAGE (1-800-468-8243)

I'm not interested / I don't think so/Not at this Time: Thank you so much for your time, we apologize for any inconvenience. If you change your mind at any time please call our inbound center at 1-888-FPL-GREEN or visit our website at www.FPL.com/sunshine.

The price is higher than what I'm paying now: Yes it is, as I mentioned it is a fixed \$9.75 additional per month and for the cost of a pizza you can support cleaner electricity generation, reduce CO₂ emissions and help build new renewable sources of electricity.

I'm just not sure: I understand, you probably would like to do some more research. You can look at the website at www.FPL.com/sunshine and I can call you back (ask for preferred date and time from customer) to answer any additional questions you might have after you read the website.

If I sign up, will I really be helping the environment? Yes, One of the most important things you can do to reduce air pollution is to choose *Sunshine Energy* from FPL. In just one year as a *Sunshine Energy* customer, a Florida household could avoid over 10,000 pounds of CO₂ emissions nationwide – as much as your car would produce in over 11,000 miles of driving.

And did you know that when you choose *Sunshine Energy*, your demand for cleaner electricity generation encourages the construction of new renewable power generation here in Florida and **beyond**. Because Florida's renewable energy resources are limited, most of the cleaner generation facilities *Sunshine Energy* supports are located in other states. But part of your dollars also go directly toward building solar facilities right here in the Sunshine State. And as customer demand continues to increase, it also encourages the development of other types of new renewable generation facilities here in Florida.

Customer states that they need to speak with their husband, wife or partner first

Reply: Ma'am or Sir, I completely understand. Whenever a key decision needs to be made for my family, I feel it is important to discuss with other members, to get their input. Let me give you a few key points to discuss with your (husband or wife or partner) (Go to Product/Benefits)

Customer states that they already signed up for Sunshine Energy

Reply: Thank you so much for choosing *Sunshine Energy* ! We apologize for any inconvenience and will make sure that we update our files. Have a wonderful day.

Customer states that they would prefer to sign-up online as it is more secure.

Reply: Thank you so much for choosing FPL's *Sunshine Energy*. Our Website is www.FPL.com/sunshine. Have a sunny day!

PRODUCT/MIX INFORMATION (REQUIRED)

The electricity generation you purchase with FPL's *Sunshine Energy* mostly comes from wind power and bioenergy. As more FPL customers sign up for *Sunshine Energy*, it causes the construction of more solar facilities. So *Sunshine Energy* will even contain small amounts of solar power in the future.

What is bioenergy?

In addition the sun and wind, scientists and engineers have found ways to make electricity from a number of other renewable resources. Bioenergy, for example, is cleaner energy generated from organic resources and energy crops or the natural decomposition of organic materials. These resources are renewable since they are virtually infinite and/or replenish themselves in short periods of time. Bioenergy is one of the most promising forms of renewable energy for Florida and the Southeast, where wind, hydro, and geothermal energy potential is limited by geography.



IMPACT STATEMENTS (1 IMPACT STATEMENT IS REQUIRED)

When you choose FPL's Sunshine Energy, you are helping to make the construction of new solar facilities in Florida a reality. Because Florida's renewable energy resources are limited, most of the cleaner generation facilities Sunshine Energy supports are located in other states. But part of your dollars also go directly toward building solar facilities right here in the Sunshine State. In fact, for every 10,000 customers who sign up for Sunshine Energy, we'll develop 150 kW of solar capacity in Florida.

When you choose FPL's Sunshine Energy, your demand for cleaner electricity generation encourages the construction of new renewable power generation here in Florida and beyond. Since Florida's renewable energy resources are limited, most of the cleaner generation facilities Sunshine Energy supports are located in other states. But part of your dollars also go directly toward building solar facilities right here in the Sunshine State. And as customer demand continues to increase, it also encourages the development of other types of new renewable generation facilities here in Florida.

FPL is proud to be one of the nation's premier utilities and is committed to energy efficiency and cleaner energy technologies. FPL believes that greater conservation and use of cost-effective renewable resources is good for our nation and that the ongoing development of cleaner energy technologies is a worthy pursuit.

- FPL supports individual customer lifestyle choices such as this cleaner electricity choice program and home-based solar installations.

FPL also actively pursues research and development programs that build new cleaner energy technologies and facilities designed to reduce our nation's reliance on fossil fuels.

As an FPL customer, you can help preserve the environment by buying Sunshine Energy and supporting cleaner electricity. One of the most important things you can do to reduce air pollution is to choose Sunshine Energy from FPL. In just one year as a Sunshine Energy customer, a Florida household could avoid over 10,000 pounds of CO₂ emissions nationwide – as much as your car would produce in over 11,000 miles of driving.

SIGN UP AND VERIFY INFORMATION (REQUIRED)

Thank you for making the decision to sign up for Sunshine Energy I just need to verify a few pieces of information with you

- LAST NAME ON BILL
- FIRST NAME ON BILL
- ACCOUNT NUMBER ON BILL
- BILLING PHONE NUMBER
- ADDRESS,CITY, STATE, ZIP
- Email address



Prepare Customer for TPV (REQUIRED)

At this time we will need to complete the third party verification process FOR YOUR PROTECTION. This process takes only a few minutes. Thank you so much for your patience! I will be transferring you to an independent third-party verifier who will verify your choice to sign up for FPL's **Sunshine Energy** and will confirm your:

Billing Address

First, Last Name

You are an FPL customer and the resident of the service address

That you understand the additional block rate per month

And that you are giving permission to be signed up for Sunshine Energy

Please note that you will need to answer a few questions by answering yes or no to the questions (If you answer with ok or alright these responses are not acceptable)

(Continue with TPV procedures)

RECAP WHAT CUSTOMER CAN EXPECT (REQUIRED):

- You will see the charge appear on your next bill following your next meter read
- Rate information --An additional \$9.75 per month added to their monthly bill
- Additional \$9.75 will appear on monthly bill in the next 60-90 days

NO SALE CLOSING (REQUIRED):

I'm sorry we couldn't get you started today, if you would like to sign up for Sunshine Energy in the future please visit the website www.FPL.com/sunshine at or call us at 1-888-FPL-GREEN. Thank you so much for your time, have a wonderful day.

**DO NOT CALL OR DMA INFORMATION
(REQUIRED IF CUSTOMER ASKS TO BE PLACED ON DNC LIST)**

Florida maintains a "Do Not Call" list. If customer requests that we do not call them, please place in the calling list as DNC (dispo) and then offer the following information:

Florida State DNC Information

Florida Department of Agriculture and Consumer Services

No Sales Solicitation

P. O. Box 6700

Tallahassee, FL 32314-6700

1-800-HELP-FLA



**Green
Mountain
Energy™**

National DNC Information

1-888-382-1222 or via email at register@donotcall.gov or online at www.ftc.gov

National DMA Information

The DMA (Direct Marketing Assoc.) recently made some changes to how this process works, but here are the links you can refer callers to (below). Caller can pay \$5 and register online at the links below or they can mail in their request (no charge) at the address listed (one for mail list and one for phone list). Note: It takes several months after the customer sends his/her request to see a reduction in phone or mail solicitations.

<http://www.the-dma.org/cgi/offmailinglistdave>

MAIL PREFERENCE SERVICE
ATTN: PREFERENCE SERVICE MANAGER
DIRECT MARKETING ASSOCIATION
PO BOX 3079
GRAND CENTRAL STATION, NY 10163

**Florida Power & Light Company
Docket No. 070626-EI
Staff's Data Request 9-5-08
Interrogatory No. 17
Page 1 of 1**

Q.

Please provide a copy of each direct mail piece sent by FPL regarding the Sunshine Energy Program. Please describe the promotional objective(s) associated with each direct mail piece provided.

A.

FPL did not send out any direct mail pieces for the Sunshine Energy Program. All direct mail was the responsibility of Green Mountain. All direct mail pieces were reviewed and approved by FPL prior to mailing. The objective of the direct mail was to promote awareness of the Sunshine Energy program and the many benefits of the program, and to increase participation over time to maximize enrollment, resulting in the purchase of more RECs.

FPSC

DATA

REQUEST

NO. 17

4

ATTACHMENTS



FPL

[Redacted]

Dear [Redacted]

As Americans, we have always supported freedom and independence. And, today perhaps more than ever, we want to secure energy independence by utilizing innovative energy sources

By choosing Sunshine Energy®, a renewable energy program offered by Florida Power & Light Company, you can have a personal, positive impact on our energy future

Purchasing renewable electricity not only promotes a brighter energy future, it also helps clean the air we breathe. Sunshine Energy is American-made and generated from wind, bioenergy and the sun. Your participation in the program helps avoid more than 10,000 pounds of carbon dioxide (CO2) emissions from entering the air every year -- as much as a car would produce in over 11,000 miles of driving. Since the program began, almost 30,000 customers have enrolled -- and through 2005 have helped avoid over 98,000 tons of CO2, which is the equivalent of removing over 17,000 cars from the road in one year.

For each month you're enrolled in the Sunshine Energy program FPL ensures that 1,000 kWh of electricity from cleaner sources is produced by generators in Florida and other states nationwide. Your participation in the program creates important environmental benefits in the areas where this cleaner, renewable electricity is generated.

Less expensive than you might think

Sunshine Energy is surprisingly inexpensive: for only \$9.75 more a month, you can help reduce CO2 emissions and promote a more secure energy future

Sign up today

Choosing Sunshine Energy is a simple, affordable way to do your part for America's energy and environmental future. Simply complete and return the form below, sign up at www.FPLSunshineEnergy.com, or give us a call at 1 877 529 2610

Do your part today by choosing Sunshine Energy!

David Bates
Sunshine Energy Program Manager

P S Remember, choosing Sunshine Energy helps in two ways: by promoting energy independence and by preserving the environment. Sign up today with the enrollment form below, through www.FPLSunshineEnergy.com, or with a quick, toll-free call to 1 877.529.2610

Printed on recycled paper (30% post-consumer fiber, elemental chlorine free) with soy-based inks. Please recycle.

Yes, I choose to participate in the Sunshine Energy program from Florida Power & Light Company

By signing below, I agree to enroll in Sunshine Energy from Florida Power & Light Company. I am 18 years or older and am authorized to make a change to this FPL account. I understand I will pay a monthly surcharge of \$9.75 for the environmental credits associated with cleaner generation sources of electricity including bioenergy, wind and solar.

sunshinenergy®

FPL ID Number [Redacted]

First Name: [Redacted]

Last Name: [Redacted]

Address (not a PO Box): [Redacted]

Apartment No.: [Redacted]

City: [Redacted] State: [Redacted] Zip: [Redacted]

Home Phone: [Redacted] Work Phone: [Redacted]

Email Address: [Redacted]

Signature: X Date: [Redacted]



FPL. POWERING TODAY. EMPOWERING TOMORROW.™



FPL



Dear [Redacted]

As Americans, we have always supported freedom and independence. And today, perhaps more than ever, we want to secure energy independence by utilizing innovative energy sources.

By choosing Sunshine Energy®, a renewable energy program offered by Florida Power & Light Company, you can have a personal, positive impact on our energy future.

Purchasing renewable electricity not only promotes a brighter energy future, it also helps clean the air we breathe. Sunshine Energy is American-made and generated from wind, bioenergy and the sun. Your participation in the program helps avoid more than 10,000 pounds of carbon dioxide (CO2) emissions from entering the air every year — as much as a car would produce in over 11,000 miles of driving. Since the program began, almost 30,000 customers have enrolled — and through 2005 have helped avoid over 98,000 tons of CO2, which is the equivalent of removing over 17,000 cars from the road in one year.

For each month you're enrolled in the Sunshine Energy program, FPL ensures that 1,000 kWh of electricity from cleaner sources is produced by generators in Florida and other states nationwide. Your participation in the program creates important environmental benefits in the areas where this cleaner, renewable electricity is generated.

Less expensive than you might think

Sunshine Energy is surprisingly inexpensive: for only \$9.75 more a month, you can help reduce CO2 emissions and promote a more secure energy future.

Sign up today

Choosing Sunshine Energy is a simple, affordable way to do your part for America's energy and environmental future. Simply complete and return the form below, sign up at www.FPLSunshineEnergy.com, or give us a call at 1-877-529-2610.

Do your part today by choosing Sunshine Energy!

David Bates
Sunshine Energy Program Manager

P.S. Remember, choosing Sunshine Energy helps in two ways: by promoting energy independence and by preserving the environment. Sign up today with the enrollment form below, through www.FPLSunshineEnergy.com, or with a quick, toll-free call to 1-877-529-2610.

Printed on recycled paper (30% post-consumer fiber, elemental chlorine-free) with soy-based inks. Please recycle.

Yes, I choose to participate in the Sunshine Energy program from Florida Power & Light Company.

By signing below, I agree to enroll in Sunshine Energy from Florida Power & Light Company. I am 18 years or older and am authorized to make a change to this FPL account. I understand I will pay a monthly surcharge of \$9.75 for the environmental credits associated with cleaner generation sources of electricity including bioenergy, wind and solar.

sunshinenergy®

FPL ID Number [Redacted]

First Name: [Redacted]

Last Name: [Redacted]

Address (not a PO Box): [Redacted]

Apartment No.: [Redacted]

City: [Redacted]

State: [Redacted]

Zip: [Redacted]

Home Phone: [Redacted]

Work Phone: [Redacted]

Email Address: [Redacted]

Signature: X

Date: [Redacted]



FPL POWERING TODAY. EMPOWERING TOMORROW.™



FPL



Dear [Redacted]

As Americans, we have always supported freedom and independence. And today perhaps more than ever, we want to secure energy independence by utilizing innovative energy sources.

By choosing Sunshine Energy® a renewable energy program offered by Florida Power & Light Company, you can have a personal, positive impact on our energy future.

Purchasing renewable electricity not only promotes a brighter energy future, it also helps clean the air we breathe. Sunshine Energy is American-made and generated from wind, bioenergy and the sun. Your participation in the program helps avoid more than 10,000 pounds of carbon dioxide (CO2) emissions from entering the air every year — as much as a car would produce in over 11,000 miles of driving. Since the program began, almost 30,000 customers have enrolled — and through 2005 have helped avoid over 98,000 tons of CO2, which is the equivalent of removing over 17,000 cars from the road in one year.

For each month you're enrolled in the Sunshine Energy program, FPL ensures that 1,000 kWh of electricity from cleaner sources is produced by generators in Florida and other states nationwide. Your participation in the program creates important environmental benefits in the areas where this cleaner, renewable electricity is generated.

Less expensive than you might think

Sunshine Energy is surprisingly inexpensive: for only \$9.75 more a month, you can help reduce CO2 emissions and promote a more secure energy future.

Sign up today

Choosing Sunshine Energy is a simple, affordable way to do your part for America's energy and environmental future. Simply complete and return the form below, sign up at www.FPLSunshineEnergy.com, or give us a call at 1-877-529-2610.

Do your part today by choosing Sunshine Energy!

David Bates
Sunshine Energy Program Manager

P.S. Remember, choosing Sunshine Energy helps in two ways: by promoting energy independence and by preserving the environment. Sign up today with the enrollment form below, through www.FPLSunshineEnergy.com or with a quick, toll-free call to 1-877-529-2610.

Printed on recycled paper (30% post-consumer fiber, elemental chlorine-free) with soy-based inks. Please recycle.

Yes, I choose to participate in the Sunshine Energy program from Florida Power & Light Company.

By signing below, I agree to enroll in Sunshine Energy from Florida Power & Light Company. I am 18 years or older and am authorized to make a change to this FPL account. I understand I will pay a monthly surcharge of \$9.75 for the environmental credits associated with cleaner generation sources of electricity including bioenergy, wind and solar.

sunshinenergy®

FPL ID Number [Redacted]

First Name: [Redacted]

Last Name: [Redacted]

Address (not a PO Box): [Redacted]

Apartment No.: [Redacted]

City: [Redacted]

State: [Redacted]

Zip: [Redacted]

Home Phone: [Redacted]

Work Phone: [Redacted]

Email Address: [Redacted]

Signature: X

Date: [Redacted]



FPL. POWERING TODAY. EMPOWERING TOMORROW.™



FPL.

[Redacted]

Dear [Redacted]

As Americans, we have always supported freedom and independence. And, today, perhaps more than ever, we want to secure energy independence by utilizing innovative energy sources.

By choosing Sunshine Energy®, a renewable energy program offered by Florida Power & Light Company, you can have a personal, positive impact on our energy future.

Purchasing renewable electricity not only promotes a brighter energy future, it also helps clean the air we breathe. Sunshine Energy is American-made and generated from wind, bioenergy and the sun. Your participation in the program helps avoid more than 10,000 pounds of carbon dioxide (CO2) emissions from entering the air every year — as much as a car would produce in over 11,000 miles of driving. Since the program began, almost 30,000 customers have enrolled — and through 2005 have helped avoid over 98,000 tons of CO2, which is the equivalent of removing over 17,000 cars from the road in one year.

For each month you're enrolled in the Sunshine Energy program, FPL ensures that 1,000 kWh of electricity from cleaner sources is produced by generators in Florida and other states nationwide. Your participation in the program creates important environmental benefits in the areas where this cleaner, renewable electricity is generated.

Less expensive than you might think

Sunshine Energy is surprisingly inexpensive: for only \$9.75 more a month, you can help reduce CO2 emissions and promote a more secure energy future.

Sign up today

Choosing Sunshine Energy is a simple, affordable way to do your part for America's energy and environmental future. Simply complete and return the form below, sign up at www.FPLSunshineEnergy.com, or give us a call at 1 877 529 2610.

Do your part today by choosing Sunshine Energy!

David Bates
Sunshine Energy Program Manager

P.S. Remember, choosing Sunshine Energy helps in two ways: by promoting energy independence and by preserving the environment. Sign up today with the enrollment form below, through www.FPLSunshineEnergy.com, or with a quick, toll-free call to 1 877 529 2610.

Printed on recycled paper (30% post-consumer fiber, elemental chlorine free) with soy-based inks. Please recycle.

Yes, I choose to participate in the Sunshine Energy program from Florida Power & Light Company.

By signing below, I agree to enroll in Sunshine Energy from Florida Power & Light Company. I am 18 years or older and am authorized to make a change to this FPL account. I understand I will pay a monthly surcharge of \$9.75 for the environmental credits associated with cleaner generation sources of electricity including bioenergy, wind and solar.



FPL ID Number [Redacted]

First Name: [Redacted]

Last Name: [Redacted]

Address (not a PO Box): [Redacted]

Apartment No.: [Redacted]

City: [Redacted] State: [Redacted] Zip: [Redacted]

Home Phone: [Redacted] Work Phone: [Redacted]

Email Address: [Redacted]

Signature: X Date: [Redacted]



FPL. POWERING TODAY. EMPOWERING TOMORROW.™



FPL

[Redacted]

Dear [Redacted]

As Americans we have always supported freedom and independence. And, today, perhaps more than ever, we want to secure energy independence by utilizing innovative energy sources.

By choosing Sunshine Energy®, a renewable energy program offered by Florida Power & Light Company, you can have a personal, positive impact on our energy future.

Purchasing renewable electricity not only promotes a brighter energy future, it also helps clean the air we breathe. Sunshine Energy is American-made and generated from wind, bioenergy and the sun. Your participation in the program helps avoid more than 10,000 pounds of carbon dioxide (CO2) emissions from entering the air every year — as much as a car would produce in over 11,000 miles of driving. Since the program began, almost 30,000 customers have enrolled — and through 2005 have helped avoid over 98,000 tons of CO2, which is the equivalent of removing over 17,000 cars from the road in one year.

For each month you're enrolled in the Sunshine Energy program, FPL ensures that 1,000 kWh of electricity from cleaner sources is produced by generators in Florida and other states nationwide. Your participation in the program creates important environmental benefits in the areas where this cleaner, renewable electricity is generated.

Less expensive than you might think

Sunshine Energy is surprisingly inexpensive: for only \$9.75 more a month, you can help reduce CO2 emissions and promote a more secure energy future.

Sign up today

Choosing Sunshine Energy is a simple, affordable way to do your part for America's energy and environmental future. Simply complete and return the form below, sign up at www.FPLSunshineEnergy.com, or give us a call at 1.877.529.2610.

Do your part today by choosing Sunshine Energy!

David Bates
Sunshine Energy Program Manager

P.S. Remember, choosing Sunshine Energy helps in two ways: by promoting energy independence and by preserving the environment. Sign up today with the enrollment form below, through www.FPLSunshineEnergy.com, or with a quick, toll-free call to 1.877.529.2610.

Printed on recycled paper (30% post-consumer fiber, elemental chlorine-free) with soy-based inks. Please recycle.

Yes, I choose to participate in the Sunshine Energy program from Florida Power & Light Company

By signing below, I agree to enroll in Sunshine Energy from Florida Power & Light Company. I am 18 years or older and am authorized to make a change to this FPL account. I understand I will pay a monthly surcharge of \$9.75 for the environmental credits associated with cleaner generation sources of electricity including bioenergy, wind and solar.

sunshinenergy®

FPL ID Number [Redacted]

First Name: [Redacted]

Last Name: [Redacted]

Address (not a PO Box): [Redacted]

Apartment No.: [Redacted]

City: [Redacted]

State: US

Zip: [Redacted]

Home Phone: [Redacted]

Work Phone: [Redacted]

Email Address: [Redacted]

Signature: X

Date: [Redacted]



FPL POWERING TODAY. EMPOWERING TOMORROW.™



7000 Saultview Drive Bl. Cloud, MN 55003 (202) 251-7011
 FAX (202) 259-1378

Job No 47933 Date 1/24/07
 Quantity _____ Cell FLP
(to be placed there) Version September
 Dan Peterka Bradley Smoley
 CSR _____ Data Center _____
 Nahan File ID 47933 001

Notice: This proof indicates how the final personalized product will appear. Please check the copy (both static and variable) position and content. Complete this form with the requested information.

In order to maintain your schedule, return this proof to arrive at Nahan on: _____

PERSONALIZATION SIGN-OFF

1. Status indication, signature and date are required on all sign-offs.
2. Corrections are to be made on all sign-offs. In a color other than black preferably in red marker.
3. The signature below will indicate to Nahan Printing that everything is OK as is or OK with corrections marked on the sign-off. **The responsibility for errors not marked on the sign-off is with the customer.**
4. All customer alterations will be charged to the customer and may delay production dates depending on their complexity.

— PLEASE COMPLETE —
 THIS SIGN-OFF IS ...
 OK to run - no corrections
 OK to personalize with corrections marked
 Not OK - corrections marked - send revised sign-off

YOUR SIGNATURE IS REQUIRED
 Production delay may result if not signed
 Signed _____
 Date _____

Printed on recycled paper (30% post-consumer fiber elemental chlorine free) with soy-based inks. Please recycle.



sunshinenergy®



FPL POWERING TODAY. EMPOWERING TOMORROW.™

DIVIDER

BLANK

PAGE



[Redacted]

Dear [Redacted]

How much of a difference can one person really make?

Just ask one of the 30,000 customers who participate in the Sunshine Energy® program from Florida Power & Light Company. Thanks to them, new solar projects are happening throughout the state, including:

- The largest solar array in Florida - and one of the largest in the southeast - under development at Rothenbach Park in Sarasota.
- A new solar array exhibit at the Miami Science Museum
- Solar photovoltaic systems for four Florida schools under the SunSmart Schools Program

These new solar facilities are becoming a reality as a direct result of *Sunshine Energy* customers who choose to make a difference.

Choose *Sunshine Energy* now and help support cleaner electricity.

For each month that you participate in the *Sunshine Energy* program, FPL ensures that 1,000 kWh of electricity from cleaner sources like bioenergy, wind and solar is produced by generators in Florida and other states nationwide. Your participation creates important environmental benefits in the areas where this cleaner, renewable electricity is generated and - as you can see - supports the development of new solar energy sources in Florida.

Less expensive than you might think.

Choosing *Sunshine Energy* is an easy way to do your part for the environment. For only \$9.75 more a month - less than the cost of a pizza - you can help support cleaner electricity now and in the future.

Sign up today and help make a difference.

Choosing *Sunshine Energy* is easy. Simply complete and return the enrollment form below, sign up at www.FPLSunshineEnergy.com, or give us a call at 1.877.529.2610.

Thank you for choosing *Sunshine Energy* and helping support solar energy in Florida.

David Bates
Program Manager

P. S. So help make a difference and choose *Sunshine Energy* by supporting cleaner sources of electricity and the development of new solar energy sources. Just return the enrollment form below, visit www.FPLsunshineenergy.com, or with a quick, toll-free call to 1.877.529.2610.

Printed on recycled paper (20% post-consumer fiber) manufactured in a facility with recycled ink. Please recycle.

Yes, I choose to participate in the *Sunshine Energy* program from Florida Power & Light Company

By signing below, I agree to enroll in *Sunshine Energy* from Florida Power & Light Company. I am 18 years or older and am authorized to make a change to this FPL account. I understand I will pay a monthly surcharge of \$9.75 for the environmental credits associated with cleaner generation sources of electricity including bioenergy, wind and solar.

sunshineenergy[®]

FPL ID Number [Redacted]

First Name: [Redacted]

Last Name: [Redacted]

Address (not a PO Box): [Redacted]

Apartment No.: [Redacted]

City: [Redacted] State: [Redacted] Zip: [Redacted]

Home Phone: [Redacted] Work Phone: [Redacted]

Email Address: [Redacted]

Signature: X Date: [Redacted]



FPL. POWERING TODAY. EMPOWERING TOMORROW.™



FPL

[Redacted]

Dear [Redacted]

Now There's Something You CAN do about Global Climate Change

With more and more news about climate change, we wonder what we can do individually to have a positive impact. Choosing the Sunshine Energy® program from Florida Power & Light Company is one of the easiest ways to help preserve the environment.

In just one year as a *Sunshine Energy* customer, you can avoid over 10,000 pounds of CO2 emissions - a significant reduction in the average household's annual share of CO2 emissions. That's avoiding as much CO2 as a car would produce in over 11,000 miles of driving.

So how does it work?

For each month that you participate in the *Sunshine Energy* program, FPL ensures that 1,000 kWh of electricity from cleaner sources like bioenergy, wind and solar is produced by generators in Florida and other states. Your participation creates important environmental benefits in the areas where this cleaner, renewable electricity is generated, and supports the development of new solar energy sources in Florida.

Less expensive than you might think.

Choosing *Sunshine Energy* is an easy way to do your part to reduce your household's share of CO2 emissions and have a positive impact on global climate change. For only \$9.75 more a month - less than the cost of a pizza - you can support cleaner electricity *now and in the future*.

Sign up today and help make a difference.

Choosing *Sunshine Energy* is easy. Simply complete and return the enrollment form below, sign up at www.FPLSunshineEnergy.com, or give us a call at 1 877 529 2610.

Thank you for choosing *Sunshine Energy* and helping to do your part to stop global warming.

David Bates
Program Manager

P. S. Remember, choosing *Sunshine Energy* helps two ways: by reducing your household's share of CO2 emissions and supporting the development of new solar energy sources. Sign up today with the enrollment form below, through www.FPLsunshineenergy.com or with a quick, toll-free call to 1 877 529 2610.

Printed on recycled paper (30% post-consumer fiber). Made with FPL's 100% recycled paper with soy-based inks. Florida is cycle!

Yes, I choose to participate in the *Sunshine Energy* program from Florida Power & Light Company

By signing below, I agree to enroll in *Sunshine Energy* from Florida Power & Light Company. I am 18 years or older and am authorized to make a change to this FPL account. I understand I will pay a monthly surcharge of \$9.75 for the environmental credits associated with cleaner generation sources of electricity including bioenergy, wind and solar.

sunshinenergy®

FPL ID Number [Redacted]

First Name: [Redacted]

Last Name: [Redacted]

Address (not a PO Box): [Redacted]

Apartment No.: [Redacted]

City: [Redacted]

State: [Redacted]

Zip: [Redacted]

Home Phone: [Redacted]

Work Phone: [Redacted]

Email Address: [Redacted]

Signature: **X**

Date: [Redacted]



FPL. POWERING TODAY. EMPOWERING TOMORROW.™

DIVIDER

BLANK

PAGE



FPL.

[Redacted]

[Redacted]

Dear [Redacted]

Now There's Something You CAN do about Global Climate Change

With more and more news about climate change, we wonder what we can do individually to have a positive impact. Choosing the Sunshine Energy® program from Florida Power & Light Company is one of the easiest ways to help preserve the environment.

In just one year as a Sunshine Energy customer, you can avoid over 10,800 pounds of CO₂ emissions – a significant reduction in the average household's annual share of CO₂ emissions. That's avoiding as much CO₂ as a car would produce in over 12,000 miles of driving.

So how does it work?

For each month that you participate in the Sunshine Energy program, FPL ensures that 1,000 kWh of electricity from cleaner sources like bioenergy, wind and solar is produced by generators in Florida and other states. Your participation creates important environmental benefits in the areas where this cleaner, renewable electricity is generated, and supports the development of new solar energy sources in Florida.

Less expensive than you might think.

Choosing Sunshine Energy is an easy way to do your part to reduce your household's share of CO₂ emissions and have a positive impact on global climate change. For only \$9.75 more a month – less than the cost of a pizza – you can support cleaner electricity now and in the future.

Sign up today and help make a difference.

Choosing Sunshine Energy is easy. Simply complete and return the enrollment form below, or sign up online at www.fplsunshineenergy.com or give us a call today at 877-529-2610.

Thank you for choosing Sunshine Energy and helping to do your part to stop global warming!

David Bates
Program Manager

P.S. Remember, choosing Sunshine Energy helps in two ways: by reducing your household's share of CO₂ emissions and supporting the development of new solar energy sources. Sign up today with the enrollment form below, through www.FPLsunshineenergy.com or with a quick, toll-free call to 1-877-529-2610.

Printed on recycled paper. 31% post-consumer fiber, including 10% recycled, with soy-based ink. FPLsunshineenergy.com

Yes, I choose to participate in the Sunshine Energy program from Florida Power & Light

By signing below, I agree to enroll in Sunshine Energy from Florida Power & Light Company. I am 18 years or older and am authorized to make a change to this FPL account. I understand I will pay an additional amount of \$9.75 per month for renewable energy from cleaner generation sources of electricity like bioenergy, wind and solar.



FPL. POWERING TODAY. EMPOWERING TOMORROW.™

sunshinenergy®

FPL ID Number: [Redacted]

First Name: [Redacted]

Last Name: [Redacted]

Address (not a PO Box): [Redacted]

City: [Redacted] State: [Redacted]

Home Phone: [Redacted] Work Phone: [Redacted]

Email Address: [Redacted]

Signature: X Date: [Redacted]



FPL



Dear [Redacted]

Now There's Something You CAN do about Global Climate Change

With more and more news about climate change, we wonder what we can do individually to have a positive impact. Choosing the Sunshine Energy® program from Florida Power & Light Company is one of the easiest ways to help preserve the environment.

In just one year as a Sunshine Energy customer, you can avoid over 10,800 pounds of CO₂ emissions – a significant reduction in the average household's annual share of CO₂ emissions. That's avoiding as much CO₂ as a car would produce in over 12,000 miles of driving.

So how does it work?

For each month that you participate in the Sunshine Energy program, FPL ensures that 1,000 kWh of electricity from cleaner sources like bioenergy, wind and solar is produced by generators in Florida and other states. Your participation creates important environmental benefits in the areas where this cleaner renewable electricity is generated and supports the development of new solar energy sources in Florida.

Less expensive than you might think.

Choosing Sunshine Energy is an easy way to do your part to reduce your household's share of CO₂ emissions and have a positive impact on global climate change. For only \$9.75 more a month – less than the cost of a pizza – you can support cleaner electricity now and in the future.

Sign up today and help make a difference.

Choosing Sunshine Energy is easy. Simply complete and return the enrollment form below, or sign up online at www.fplsunshineenergy.com, or give us a call today at 877.529.2610.

Thank you for choosing Sunshine Energy and helping to do your part to stop global warming!

David Bates
Program Manager

P. S. Remember, choosing Sunshine Energy helps in two ways: by reducing your household's share of CO₂ emissions and supporting the development of new solar energy sources. Sign up today with the enrollment form below, through www.FPLsunshineenergy.com or with a quick, toll-free call to 1 877 529 2610.

Ⓢ 100% recycled paper. 100% post-consumer fiber. Environmentally friendly. 100% soy-based ink. Please recycle.

Yes, I choose to participate in the Sunshine Energy program from Florida Power & Light

By signing below, I agree to enroll in Sunshine Energy from Florida Power & Light Company. I am 18 years or older and am authorized to make a change to this FPL account. I understand I will pay an additional amount of \$9.75 per month for renewable energy from cleaner generation sources of electricity like bioenergy, wind and solar.

sunshinenergy®



FPL POWERING TODAY. EMPOWERING TOMORROW.™

FPL ID Number: [Redacted]

First Name: [Redacted]

Last Name: [Redacted]

Address (not a PO Box): [Redacted]

City: [Redacted] State: [Redacted] Zip: [Redacted]

Home Phone: [Redacted] Work Phone: [Redacted]

Email Address: [Redacted]

Signature: **X** Date: _____



[Redacted]

[Redacted]

Dear [Redacted]

Now There's Something You CAN do about Global Climate Change

With more and more news about climate change, we wonder what we can do individually to have a positive impact. Choosing the Sunshine Energy® program from Florida Power & Light Company is one of the easiest ways to help preserve the environment.

In just one year as a Sunshine Energy customer, you can avoid over 10,800 pounds of CO₂ emissions – a significant reduction in the average household's annual share of CO₂ emissions. That's avoiding as much CO₂ as a car would produce in over 12,000 miles of driving.

So how does it work?

For each month that you participate in the Sunshine Energy program, FPL ensures that 1,000 kWh of electricity from cleaner sources like bioenergy, wind and solar is produced by generators in Florida and other states. Your participation creates important environmental benefits in the areas where this cleaner, renewable electricity is generated, and supports the development of new solar energy sources in Florida.

Less expensive than you might think.

Choosing Sunshine Energy is an easy way to do your part to reduce your household's share of CO₂ emissions and have a positive impact on global climate change. For only \$9.75 more a month – less than the cost of a pizza – you can support cleaner electricity now and in the future.

Sign up today and help make a difference.

Choosing Sunshine Energy is easy. Simply complete and return the enrollment form below, or sign up online at www.fplsunshineenergy.com, or give us a call today at 877-529-2610.

Thank you for choosing Sunshine Energy and helping to do your part to stop global warming!

David Bates
Program Manager

P. S. Remember, choosing Sunshine Energy helps in two ways: by reducing your household's share of CO₂ emissions and supporting the development of new solar energy sources. Sign up today with the enrollment form below, through www.FPLsunshineenergy.com or with a quick, toll-free call to 1-877-529-2610.

Printed on recycled paper. 100% post-consumer fiber. Contains 10% recycled fiber. Recycled cycle.

Yes, I choose to participate in the Sunshine Energy program from Florida Power & Light

sunshinenergy®

By signing below, I agree to enroll in Sunshine Energy from Florida Power & Light Company. I am 18 years or older and am authorized to make a change to this FPL account. I understand I will pay an additional amount of \$9.75 per month for renewable energy from cleaner generation sources of electricity like bioenergy, wind and solar.

FPL ID Number: [Redacted]

First Name: [Redacted]

Last Name: [Redacted]

Address (not a PO Box): [Redacted]

City: [Redacted] State: [Redacted] Zip: [Redacted]

Home Phone: [Redacted] Work Phone: [Redacted]

Email Address: [Redacted]

Signature: **X** Date: _____



FPL POWERING TODAY. EMPOWERING TOMORROW.™



FPL

[Redacted]

[Redacted]

Dear [Redacted]

Now There's Something You CAN do about Global Climate Change

With more and more news about climate change, we wonder what we can do individually to have a positive impact. Choosing the Sunshine Energy® program from Florida Power & Light Company is one of the easiest ways to help preserve the environment.

In just one year as a Sunshine Energy customer, you can avoid over 10,800 pounds of CO₂ emissions – a significant reduction in the average household's annual share of CO₂ emissions. That's avoiding as much CO₂ as a car would produce in over 12,000 miles of driving.

So how does it work?

For each month that you participate in the Sunshine Energy program, FPL ensures that 1,000 kWh of electricity from cleaner sources like bioenergy, wind and solar is produced by generators in Florida and other states. Your participation creates important environmental benefits in the areas where this cleaner, renewable electricity is generated, and supports the development of new solar energy sources in Florida.

Less expensive than you might think.

Choosing Sunshine Energy is an easy way to do your part to reduce your household's share of CO₂ emissions and have a positive impact on global climate change. For only \$9.75 more a month – less than the cost of a pizza – you can support cleaner electricity now and in the future.

Sign up today and help make a difference.

Choosing Sunshine Energy is easy. Simply complete and return the enrollment form below, or sign up online at www.fpl sunshineenergy.com, or give us a call today at 877-529-2610.

Thank you for choosing Sunshine Energy and helping to do your part to stop global warming!

David Bates
Program Manager

P.S. Remember, choosing Sunshine Energy helps in two ways: by reducing your household's share of CO₂ emissions and supporting the development of new solar energy sources. Sign up today with the enrollment form below through www.fpl sunshineenergy.com, or with a quick, toll-free call to 1-877-529-2610.

♻️ Printed on recycled paper. 100% post-consumer fiber, chlorine-free. The line will say based on 2,000 cycles.

Yes, I choose to participate in the Sunshine Energy program from Florida Power & Light

sunshinenergy®

By signing below, I agree to enroll in Sunshine Energy from Florida Power & Light Company. I am 18 years or older and am authorized to make a change to this FPL account. I understand I will pay an additional amount of \$9.75 per month for renewable energy from cleaner generation sources of electricity like bioenergy, wind and solar.

[Redacted] FPL ID Number: [Redacted]

First Name: [Redacted]

Last Name: [Redacted]

Address (not a PO Box): [Redacted]

City: [Redacted] State: [Redacted] Zip: [Redacted]

Home Phone: [Redacted] Work Phone: [Redacted]

Email Address: [Redacted]

Signature: X Date: [Redacted]



FPL. POWERING TODAY. EMPOWERING TOMORROW.™



[Redacted]

[Redacted]

Dear [Redacted]

Now There's Something You CAN do about Global Climate Change

With more and more news about climate change, we wonder what we can do individually to have a positive impact. Choosing the Sunshine Energy® program from Florida Power & Light Company is one of the easiest ways to help preserve the environment.

In just one year as a Sunshine Energy customer, you can avoid over 10,800 pounds of CO₂ emissions – a significant reduction in the average household's annual share of CO₂ emissions. That's avoiding as much CO₂ as a car would produce in over 12,000 miles of driving.

So how does it work?

For each month that you participate in the Sunshine Energy program, FPL ensures that 1,000 kWh of electricity from cleaner sources like bioenergy, wind and solar is produced by generators in Florida and other states. Your participation creates important environmental benefits in the areas where this cleaner, renewable electricity is generated, and supports the development of new solar energy sources in Florida.

Less expensive than you might think.

Choosing Sunshine Energy is an easy way to do your part to reduce your household's share of CO₂ emissions and have a positive impact on global climate change. For only \$9.75 more a month – less than the cost of a pizza – you can support cleaner electricity now and in the future.

Sign up today and help make a difference.

Choosing Sunshine Energy is easy. Simply complete and return the enrollment form below, or sign up online at www.fplsunshineenergy.com, or give us a call today at 877.529.2610.

Thank you for choosing Sunshine Energy and helping to do your part to stop global warming!

David Bates
Program Manager

P. S. Remember, choosing Sunshine Energy helps in two ways: by reducing your household's share of CO₂ emissions and supporting the development of new solar energy sources. Sign up today with the enrollment form below, through www.FPLsunshineenergy.com or with a quick, toll-free call to 1.877.529.2610.

© 2006 FPL SunShine Energy. All rights reserved. FPL and Sunshine Energy are trademarks of Florida Power & Light Company. Please recycle.

Yes, I choose to participate in the Sunshine Energy program from Florida Power & Light



By signing below, I agree to enroll in Sunshine Energy from Florida Power & Light Company. I am 18 years or older and am authorized to make a change to this FPL account. I understand I will pay an additional amount of \$9.75 per month for renewable energy from cleaner generation sources of electricity like bioenergy, wind and solar.

FPL ID Number: [Redacted]

First Name: [Redacted]

Last Name: [Redacted]

Address (not a PO Box): [Redacted]

City: [Redacted] State: [Redacted]

Home Phone: [Redacted] Work Phone: [Redacted]

Email Address: [Redacted]

Signature: **X** Date: _____





[Redacted]

[Redacted]

Dear [Redacted]

As Americans, we have always supported freedom and independence. And, today, perhaps more than ever, we want to secure energy independence by utilizing innovative energy sources.

By choosing Sunshine Energy®, a renewable energy program offered by Florida Power & Light Company, you can have a positive impact on our energy future.

Purchasing renewable electricity not only promotes a brighter energy future, it also helps clean the air. Sunshine Energy is American-made and generated from renewable sources like wind, bioenergy and the sun. Your participation in the program helps avoid more than 10,800 pounds of carbon dioxide (CO₂) emissions from entering the air every year – as much as a car would produce in over 12,000 miles of driving. Since the program began, more than 35,000 customers have enrolled – and have together avoided over 249,000 tons of CO₂, which is the equivalent of removing over 44,300 cars from the road for one year.

For each month you're enrolled in the Sunshine Energy program, FPL ensures that 1,000 kWh of electricity from cleaner sources is produced by generators in Florida and other states. Your participation in the program creates important environmental benefits in the areas where this cleaner, renewable electricity is generated.

Less expensive than you might think

Sunshine Energy is surprisingly inexpensive: for only \$9.75 more a month, you can help reduce CO₂ emissions and promote a more secure energy future.

Sign up today

Choosing Sunshine Energy is a simple, affordable way to do your part for America's energy and environmental future. Simply complete and return the form below, sign up at www.FPLsunshineenergy.com, or give us a call at 1-877-529-2610.

Do your part today by choosing Sunshine Energy!

David Bates
Sunshine Energy Program Manager

P.S. Remember, choosing Sunshine Energy helps in two ways: by promoting energy independence and by preserving the environment. Sign up today with the enrollment form below, through www.FPLsunshineenergy.com, or with a quick toll-free call to 1-877-529-2610.

Printed on recycled paper. 100% post-consumer fiber. Recycled ink. Local with soy based ink. Please recycle.

Yes, I choose to participate in the Sunshine Energy program from Florida Power & Light

By signing below, I agree to enroll in Sunshine Energy from Florida Power & Light Company. I am 18 years or older and am authorized to make a change to this FPL account. I understand I will pay an additional amount of \$9.75 per month for renewable energy from cleaner generation sources of electricity like bioenergy, wind and solar.



POWERING TODAY. EMPOWERING TOMORROW.™

FPL ID Number: [Redacted]

First Name: [Redacted]

Last Name: [Redacted]

Address (not a PO Box): [Redacted]

City: [Redacted] State: [Redacted] Zip: [Redacted]

Home Phone: [Redacted] Work Phone: [Redacted]

Email Address: [Redacted]

Signature: X Date: [Redacted]



Dear [Redacted]

As Americans, we have always supported freedom and independence. And, today, perhaps more than ever, we want to secure energy independence by utilizing innovative energy sources.

By choosing Sunshine Energy®, a renewable energy program offered by Florida Power & Light Company, you can have a positive impact on our energy future.

Purchasing renewable electricity not only promotes a brighter energy future, it also helps clean the air. Sunshine Energy is American-made and generated from renewable sources like wind, bioenergy and the sun. Your participation in the program helps avoid more than 10,800 pounds of carbon dioxide (CO₂) emissions from entering the air every year – as much as a car would produce in over 12,000 miles of driving. Since the program began, more than 35,000 customers have enrolled – and have together avoided over 249,000 tons of CO₂, which is the equivalent of removing over 44,300 cars from the road for one year.

For each month you're enrolled in the Sunshine Energy program, FPL ensures that 1,000 kWh of electricity from cleaner sources is produced by generators in Florida and other states. Your participation in the program creates important environmental benefits in the areas where this cleaner, renewable electricity is generated.

Less expensive than you might think

Sunshine Energy is surprisingly inexpensive: for only \$9.75 more a month, you can help reduce CO₂ emissions and promote a more secure energy future.

Sign up today

Choosing Sunshine Energy is a simple, affordable way to do your part for America's energy and environmental future. Simply complete and return the form below, sign up at www.FPLsunshineenergy.com, or give us a call at 1 877 529 2610.

Do your part today by choosing Sunshine Energy!

David Bates
Sunshine Energy Program Manager

P. S. Remember, choosing Sunshine Energy helps in two ways: by promoting energy independence and by preserving the environment. Sign up today with the enrollment form below, through www.FPLsunshineenergy.com, or with a quick toll-free call to 1 877 529 2610.

♻️ Printed on recycled paper (35% post-consumer waste) and made with 100% recycled ink. Key board links. Please recycle.

Yes, I choose to participate in the Sunshine Energy program from Florida Power & Light

By signing below, I agree to enroll in Sunshine Energy from Florida Power & Light Company. I am 18 years or older and am authorized to make a change to this FPL account. I understand I will pay an additional amount of \$9.75 per month for renewable energy from cleaner generation sources of electricity like bioenergy, wind and solar.



FPL POWERING TODAY. EMPOWERING TOMORROW.™

sunshinenergy®

FPL ID Number: [Redacted]

First Name: [Redacted]

Last Name: [Redacted]

Address (not a PO Box): [Redacted]

City: [Redacted] State: [Redacted] Zip: [Redacted]

Home Phone: [Redacted] Work Phone: [Redacted]

Email Address: [Redacted]

Signature: **X** Date: _____



[Redacted]

[Redacted]

Dear [Redacted]

As Americans, we have always supported freedom and independence. And, today perhaps more than ever, we want to secure energy independence by utilizing innovative energy sources.

By choosing Sunshine Energy®, a renewable energy program offered by Florida Power & Light Company, you can have a positive impact on our energy future.

Purchasing renewable electricity not only promotes a brighter energy future, it also helps clean the air. Sunshine Energy is American-made and generated from renewable sources like wind, bioenergy and the sun. Your participation in the program helps avoid more than 10,800 pounds of carbon dioxide (CO₂) emissions from entering the air every year – as much as a car would produce in over 12,000 miles of driving. Since the program began, more than 35,000 customers have enrolled – and have together avoided over 249,000 tons of CO₂, which is the equivalent of removing over 44,300 cars from the road for one year.

For each month you're enrolled in the Sunshine Energy program, FPL ensures that 1,000 kWh of electricity from cleaner sources is produced by generators in Florida and other states. Your participation in the program creates important environmental benefits in the areas where this cleaner, renewable electricity is generated.

Less expensive than you might think
Sunshine Energy is surprisingly inexpensive: for only \$9.75 more a month, you can help reduce CO₂ emissions and promote a more secure energy future.

Sign up today
Choosing Sunshine Energy is a simple, affordable way to do your part for America's energy and environmental future. Simply complete and return the form below, sign up at www.FPLsunshineenergy.com or give us a call at 1-877-529-2610.

Do your part today by choosing Sunshine Energy!

David Bates
Sunshine Energy Program Manager

P.S. Remember, choosing Sunshine Energy helps in two ways: by promoting energy independence and by preserving the environment. Sign up today with the enrollment form below, through www.FPLsunshineenergy.com or with a quick toll-free call to 1-877-529-2610.

Printed on recycled paper (50% post-consumer fiber content) with soy-based inks. Please recycle.

Yes, I choose to participate in the Sunshine Energy program from Florida Power & Light.



By signing below, I agree to enroll in Sunshine Energy from Florida Power & Light Company. I am 18 years or older and am authorized to make a change to this FPL account. I understand I will pay an additional amount of \$9.75 per month for renewable energy from cleaner generation sources of electricity like bioenergy, wind and solar.

FPL ID Number: [Redacted]

First Name: [Redacted]

Last Name: [Redacted]

Address (not a PO Box): [Redacted]

City: [Redacted] State: [Redacted] Zip: [Redacted]

Home Phone: [Redacted] Work Phone: [Redacted]

Email Address: [Redacted]

Signature: X Date: [Redacted]



FPL POWERING TODAY. EMPOWERING TOMORROW.™



[Redacted]

[Redacted]

Dear [Redacted]

As Americans, we have always supported freedom and independence. And today, perhaps more than ever, we want to secure energy independence by utilizing innovative energy sources.

By choosing Sunshine Energy®, a renewable energy program offered by Florida Power & Light Company, you can have a positive impact on our energy future.

Purchasing renewable electricity not only promotes a brighter energy future, it also helps clean the air. Sunshine Energy is American-made and generated from renewable sources like wind, bioenergy and the sun. Your participation in the program helps avoid more than 10,800 pounds of carbon dioxide (CO₂) emissions from entering the air every year – as much as a car would produce in over 12,000 miles of driving. Since the program began, more than 35,000 customers have enrolled – and have together avoided over 249,000 tons of CO₂, which is the equivalent of removing over 44,300 cars from the road for one year.

For each month you re-enroll in the Sunshine Energy program, FPL ensures that 1,000 kWh of electricity from cleaner sources is produced by generators in Florida and other states. Your participation in the program creates important environmental benefits in the areas where this cleaner, renewable electricity is generated.

Less expensive than you might think

Sunshine Energy is surprisingly inexpensive: for only \$9.75 more a month, you can help reduce CO₂ emissions and promote a more secure energy future.

Sign up today

Choosing Sunshine Energy is a simple, affordable way to do your part for America's energy and environmental future. Simply complete and return the form below, sign up at www.FPLsunshineenergy.com, or give us a call at 1-877-529-2610.

Do your part today by choosing Sunshine Energy!

David Bates
Sunshine Energy Program Manager

P. S. Remember, choosing Sunshine Energy helps in two ways: by promoting energy independence and by preserving the environment. Sign up today with the enrollment form below, through www.FPLsunshineenergy.com, or with a quick toll-free call to 1-877-529-2610.

Printed on recycled paper (50% post-consumer waste) and is 100% recyclable. FPL is a proud member of the Florida Power & Light Company.

Yes, I choose to participate in the Sunshine Energy program from Florida Power & Light

By signing below, I agree to enroll in Sunshine Energy from Florida Power & Light Company. I am 18 years of age or older and am authorized to make a change to this FPL account. I understand I will pay an additional amount of \$9.75 per month for renewable energy from cleaner generation sources of electricity like bioenergy, wind and solar.



FPL POWERING TODAY. EMPOWERING TOMORROW.™

sunshinenergy®

[Redacted] FPL ID Number [Redacted]

First Name: [Redacted]

Last Name: [Redacted]

Address (not a PO Box): [Redacted]

City: [Redacted] State: [Redacted] Zip: [Redacted]

Home Phone: [Redacted] Work Phone: [Redacted]

E-mail Address: [Redacted]

Signature: **X** Date: [Redacted]



FPL

[Redacted]

[Redacted]

Dear [Redacted]

Now There's Something You CAN do about Global Climate Change

With more and more news about climate change, we wonder what we can do individually to have a positive impact. Choosing the Sunshine Energy® program from Florida Power & Light Company is one of the easiest ways to help preserve the environment.

In just one year as a Sunshine Energy customer, you can avoid over 10,800 pounds of CO₂ emissions – a significant reduction in the average household's annual share of CO₂ emissions. That's avoiding as much CO₂ as a car would produce in over 12,000 miles of driving.

So how does it work?

For each month that you participate in the Sunshine Energy program, FPL ensures that 1,000 kWh of electricity from cleaner sources like bioenergy, wind and solar is produced by generators in Florida and other states. Your participation creates important environmental benefits in the areas where this cleaner, renewable electricity is generated, and supports the development of new solar energy sources in Florida.

Less expensive than you might think.

Choosing Sunshine Energy is an easy way to do your part to reduce your household's share of CO₂ emissions and have a positive impact on global climate change. For only \$9.75 more a month – less than the cost of a pizza – you can support cleaner electricity now and in the future.

Sign up today and help make a difference.

Choosing Sunshine Energy is easy. Simply complete and return the enrollment form below, or sign up online at www.fpl.sunshineenergy.com, or give us a call today at 877.529.2610.

Thank you for choosing Sunshine Energy and helping to do your part to stop global warming!

David Bates
Program Manager

P.S. Remember, choosing Sunshine Energy helps in two ways: by reducing your household's share of CO₂ emissions and supporting the development of new solar energy sources. Sign up today with the enrollment form below, through www.FPLsunshineenergy.com, or with a quick, toll-free call to 1.877.529.2610.

♻️ Printed on recycled paper. 100% post-consumer, four elemental chlorine-free (EFCF) recycled fibers. Recycled, chlorine-free ink.

Yes, I choose to participate in the Sunshine Energy program from Florida Power & Light

By signing below, I agree to enroll in Sunshine Energy from Florida Power & Light Company. I am 18 years or older and am authorized to make a change to this FPL account. I understand I will pay an additional amount of \$9.75 per month for renewable energy from cleaner generation sources of electricity like bioenergy, wind and solar.



FPL POWERING TODAY. EMPOWERING TOMORROW.™

sunshineenergy®

[Redacted] FPL ID Number [Redacted]

First Name: [Redacted]

Last Name: [Redacted]

Address (not a PO Box): [Redacted]

City: [Redacted] State: [Redacted] Zip: [Redacted]

Home Phone: [Redacted] Work Phone: [Redacted]

Email Address: [Redacted]

Signature: X Date: [Redacted]



Dear [Redacted]

Now There's Something You CAN do about Global Climate Change

With more and more news about climate change, we wonder what we can do individually to have a positive impact. Choosing the Sunshine Energy® program from Florida Power & Light Company is one of the easiest ways to help preserve the environment.

In just one year as a Sunshine Energy customer, you can avoid over 10,800 pounds of CO₂ emissions – a significant reduction in the average household's annual share of CO₂ emissions. That's avoiding as much CO₂ as a car would produce in over 12,000 miles of driving.

So how does it work?

For each month that you participate in the Sunshine Energy program, FPL ensures that 1,000 kWh of electricity from cleaner sources like bioenergy, wind and solar is produced by generators in Florida and other states. Your participation creates important environmental benefits in the areas where this cleaner, renewable electricity is generated, and supports the development of new solar energy sources in Florida.

Less expensive than you might think.

Choosing Sunshine Energy is an easy way to do your part to reduce your household's share of CO₂ emissions and have a positive impact on global climate change. For only \$9.75 more a month – less than the cost of a pizza – you can support cleaner electricity now and in the future.

Sign up today and help make a difference.

Choosing Sunshine Energy is easy. Simply complete and return the enrollment form below, or sign up online at www.fplsunshineenergy.com, or give us a call today at 877-529-2610.

Thank you for choosing Sunshine Energy and helping to do your part to stop global warming!

David Bates
Program Manager

P.S. Remember, choosing Sunshine Energy helps in two ways: by reducing your household's share of CO₂ emissions and supporting the development of new solar energy sources. Sign up today with the enrollment form below, through www.FPLsunshineenergy.com, or with a quick, toll-free call to 1-877-529-2610.

Printed on recycled paper. 100% post-consumer fiber. Recycled in Florida. Recycled in Florida. Please recycle.

Yes, I choose to participate in the Sunshine Energy program from Florida Power & Light.

By signing below, I agree to enroll in Sunshine Energy from Florida Power & Light Company. I am 18 years or older and am authorized to make a change to this FPL account. I understand I will pay an additional amount of \$9.75 per month for renewable energy from cleaner generation sources of electricity like bioenergy, wind and solar.



FPL ID Number: [Redacted]

First Name: _____

Last Name: _____

Address (not a PO Box): [Redacted]

City: [Redacted] State: [Redacted] Zip: [Redacted]

Home Phone: _____ Work Phone: _____

Email Address: _____

Signature: **X** _____ Date: _____



FPL POWERING TODAY. EMPOWERING TOMORROW.™

DIVIDER

BLANK

PAGE



FPL

[Redacted]

Dear [Redacted]

As Americans, we have always supported freedom and independence. And, today, perhaps more than ever, we want to secure energy independence by utilizing innovative energy sources.

By choosing Sunshine Energy®, a renewable energy program offered by Florida Power & Light Company, you can have a positive impact on our energy future.

Purchasing renewable electricity not only promotes a brighter energy future, it also helps clean the air we breathe. Sunshine Energy is American-made and generated from renewable sources like wind, bioenergy and the sun. Your participation in the program helps avoid more than 10,800 pounds of carbon dioxide (CO₂) emissions from entering the air every year – as much as a car would produce in over 12,000 miles of driving. Since the program began, more than 35,000 customers have enrolled – and have together avoided over 311,000 tons of CO₂, which is the equivalent of removing over 55,000 cars from the road for one year.

For each month you're enrolled in the Sunshine Energy program, FPL ensures that 1,000 kWh of electricity from cleaner sources is produced by generators in Florida and other states. Your participation in the program creates important environmental benefits in the areas where this cleaner, renewable electricity is generated.

Less expensive than you might think

Sunshine Energy is surprisingly inexpensive: for only \$9.75 more a month, you can help reduce CO₂ emissions and promote a more secure energy future.

Sign up today

Choosing Sunshine Energy is a simple, affordable way to do your part for America's energy and environmental future. Simply complete and return the form below, sign up at www.FPLsunshineenergy.com, or give us a call at 1-877-529-2610.

Do your part today by choosing Sunshine Energy!

David Bates
Sunshine Energy Program Manager

P. S. Remember, choosing Sunshine Energy helps in two ways: by promoting energy independence and by preserving the environment. Sign up today with the enrollment form below, through www.FPLsunshineenergy.com, or with a quick, toll-free call to 1-877-529-2610.

© 2007 Florida Power & Light Company. All rights reserved. Sunshine Energy is a registered trademark of Florida Power & Light Company.

Yes, I choose to participate in the Sunshine Energy program from Florida Power & Light

By signing below, I agree to enroll in Sunshine Energy from Florida Power & Light Company. I am 18 years or older and am authorized to make a change to this FPL account. I understand I will pay an additional amount of \$9.75 per month for renewable energy from cleaner generation sources of electricity like bioenergy, wind and solar.

sunshinenergy®

FPL ID# [Redacted]

Name: [Redacted]

Address (not a PO Box): [Redacted]

City: Melbourne State: FL Zip: [Redacted]

Home Phone: [Redacted] Work Phone: [Redacted]

E-mail Address: [Redacted]

Signature: **X** Date: [Redacted]

FCB7CCEP2



FPL. POWERING TODAY. EMPOWERING TOMORROW™



[Redacted]

Dear [Redacted]

As Americans, we have always supported freedom and independence. And, today, perhaps more than ever, we want to secure energy independence by utilizing innovative energy sources.

By choosing Sunshine EnergySM, a renewable energy program offered by Florida Power & Light Company, you can have a positive impact on our energy future.

Purchasing renewable electricity not only promotes a brighter energy future, it also helps clean the air we breathe. Sunshine Energy is American-made and generated from renewable sources like wind, bioenergy and the sun. Your participation in the program helps avoid more than 10,800 pounds of carbon dioxide (CO₂) emissions from entering the air every year-- as much as a car would produce in over 12,000 miles of driving. Since the program began, more than 35,000 customers have enrolled - and have together avoided over 311,000 tons of CO₂ which is the equivalent of removing over 55,000 cars from the road for one year.

For each month you're enrolled in the Sunshine Energy program, FPL ensures that 1,000 kWh of electricity from cleaner sources is produced by generators in Florida and other states. Your participation in the program creates important environmental benefits in the areas where this cleaner, renewable electricity is generated.

Less expensive than you might think

Sunshine Energy is surprisingly inexpensive: for only \$9.75 more a month, you can help reduce CO₂ emissions and promote a more secure energy future.

Sign up today

Choosing Sunshine Energy is a simple, affordable way to do your part for America's energy and environmental future. Simply complete and return the form below, sign up at www.FPLsunshineenergy.com, or give us a call at 1-877-529-2610.

Do your part today by choosing Sunshine Energy!

David Bates
Sunshine Energy Program Manager

P. S. Remember, choosing Sunshine Energy helps in two ways: by promoting energy independence and by preserving the environment. Sign up today with the enrollment form below, through www.FPLsunshineenergy.com, or with a quick, toll-free call to 1-877-529-2610.

© 2007 Florida Power & Light Company. All rights reserved. FPL and Sunshine Energy are trademarks of Florida Power & Light Company. All other trademarks are the property of their respective owners.

Yes, I choose to participate in the Sunshine Energy program from Florida Power & Light

By signing below, I agree to enroll in Sunshine Energy from Florida Power & Light Company. I am 18 years or older and am authorized to make a change to this FPL account. I understand I will pay an additional amount of \$9.75 per month for renewable energy from cleaner generation sources of electricity like bioenergy, wind and solar.

sunshineenergySM

FPL ID# [Redacted]

Name: [Redacted]

Address (not a PO Box): [Redacted]

City: [Redacted] State: [Redacted] Zip: [Redacted]

Home Phone: [Redacted] Work Phone: [Redacted]

E-mail Address: [Redacted]

Signature: X Date: [Redacted]



FPL POWERING TODAY. EMPOWERING TOMORROW.SM

FC0700021



FPL

[Redacted]

Dear [Redacted]

As Americans, we have always supported freedom and independence. And, today, perhaps more than ever, we want to secure energy independence by utilizing innovative energy sources.

By choosing Sunshine Energy®, a renewable energy program offered by Florida Power & Light Company, you can have a positive impact on our energy future.

Purchasing renewable electricity not only promotes a brighter energy future, it also helps clean the air we breathe. Sunshine Energy is American-made and generated from renewable sources like wind, bioenergy and the sun. Your participation in the program helps avoid more than 10,800 pounds of carbon dioxide (CO2) emissions from entering the air every year – as much as a car would produce in over 12,000 miles of driving. Since the program began, more than 35,000 customers have enrolled – and have together avoided over 311,000 tons of CO2, which is the equivalent of removing over 55,000 cars from the road for one year.

For each month you're enrolled in the Sunshine Energy program, FPL ensures that 1,000 kWh of electricity from cleaner sources is produced by generators in Florida and other states. Your participation in the program creates important environmental benefits in the areas where this cleaner, renewable electricity is generated.

Less expensive than you might think

Sunshine Energy is surprisingly inexpensive: for only \$9.75 more a month, you can help reduce CO2 emissions and promote a more secure energy future.

Sign up today

Choosing Sunshine Energy is a simple, affordable way to do your part for America's energy and environmental future. Simply complete and return the form below, sign up at www.FPLsunshineenergy.com, or give us a call at 1-877-529-2610.

Do your part today by choosing Sunshine Energy!

David Bates
Sunshine Energy Program Manager

P. S. Remember, choosing Sunshine Energy helps in two ways: by promoting energy independence and by preserving the environment. Sign up today with the enrollment form below, through www.FPLsunshineenergy.com, or with a quick, toll-free call to 1-877-529-2610.

© 2007 Florida Power & Light Company. All rights reserved. FPL is a registered trademark of Florida Power & Light Company. Sunshine Energy is a registered trademark of Florida Power & Light Company.

Yes, I choose to participate in the Sunshine Energy program from Florida Power & Light

By signing below, I agree to enroll in Sunshine Energy from Florida Power & Light Company. I am 18 years or older and am authorized to make a change to this FPL account. I understand I will pay an additional amount of \$9.75 per month for renewable energy from cleaner generation sources of electricity like bioenergy, wind and solar.



FPL POWERING TODAY. EMPOWERING TOMORROW.

sunshinenergy®

FPL ID# [Redacted]

Name: [Redacted]

Address (not a PO Box): [Redacted]

City: [Redacted] State: [Redacted] Zip: [Redacted]

Home Phone: [Redacted] Work Phone: [Redacted]

Email Address: [Redacted]

Signature: **X** Date: _____

FC0700031



FPL



Dear [Redacted]

As Americans, we have always supported freedom and independence. And, today, perhaps more than ever, we want to secure energy independence by utilizing innovative energy sources.

By choosing Sunshine Energy®, a renewable energy program offered by Florida Power & Light Company, you can have a positive impact on our energy future.

Purchasing renewable electricity not only promotes a brighter energy future, it also helps clean the air we breathe. Sunshine Energy is American-made and generated from renewable sources like wind, bioenergy and the sun. Your participation in the program helps avoid more than 10,800 pounds of carbon dioxide (CO2) emissions from entering the air every year – as much as a car would produce in over 12,000 miles of driving. Since the program began, more than 35,000 customers have enrolled – and have together avoided over 311,000 tons of CO2 which is the equivalent of removing over 55,000 cars from the road for one year.

For each month you're enrolled in the Sunshine Energy program, FPL ensures that 1,000 kWh of electricity from cleaner sources is produced by generators in Florida and other states. Your participation in the program creates important environmental benefits in the areas where this cleaner, renewable electricity is generated.

Less expensive than you might think

Sunshine Energy is surprisingly inexpensive: for only \$9.75 more a month, you can help reduce CO2 emissions and promote a more secure energy future.

Sign up today

Choosing Sunshine Energy is a simple, affordable way to do your part for America's energy and environmental future. Simply complete and return the form below, sign up at www.FPLsunshineenergy.com, or give us a call at 1 877 529 2610.

Do your part today by choosing Sunshine Energy!

David Bates
Sunshine Energy Program Manager

P. S. Remember, choosing Sunshine Energy helps in two ways: by promoting energy independence and by preserving the environment. Sign up today with the enrollment form below, through www.FPLsunshineenergy.com or with a quick, toll-free call to 1 877 529 2610.

© 2007 Florida Power & Light Company. All rights reserved. FPL, Sunshine Energy and Sunshine Energy logo are trademarks of Florida Power & Light Company.

Yes, I choose to participate in the Sunshine Energy program from Florida Power & Light

By signing below, I agree to enroll in Sunshine Energy from Florida Power & Light Company. I am 18 years or older and am authorized to make a change to this FPL account. I understand I will pay an additional amount of \$9.75 per month for renewable energy from cleaner generation sources of electricity like bioenergy, wind and solar.

sunshineenergy®

FPL ID# [Redacted]

Name: [Redacted]

Address (not a PO Box): [Redacted]

City: [Redacted] State: [Redacted] Zip: [Redacted]

Home Phone: [Redacted] Work Phone: [Redacted]

Email Address: [Redacted]

Signature: **X** Date: [Redacted]



FPL POWERING TODAY. EMPOWERING TOMORROW.™

KCD7CCCK1



FPL

[Redacted]

Dear [Redacted]

As Americans, we have always supported freedom and independence. And, today, perhaps more than ever, we want to secure energy independence by utilizing innovative energy sources.

By choosing Sunshine Energy®, a renewable energy program offered by Florida Power & Light Company, you can have a positive impact on our energy future.

Purchasing renewable electricity not only promotes a brighter energy future, it also helps clean the air we breathe. Sunshine Energy is American-made and generated from renewable sources like wind, bioenergy and the sun. Your participation in the program helps avoid more than 10,800 pounds of carbon dioxide (CO₂) emissions from entering the air every year -- as much as a car would produce in over 12,000 miles of driving. Since the program began, more than 35,000 customers have enrolled -- and have together avoided over 311,000 tons of CO₂, which is the equivalent of removing over 55,000 cars from the road for one year.

For each month you're enrolled in the Sunshine Energy program, FPL ensures that 1,000 kWh of electricity from cleaner sources is produced by generators in Florida and other states. Your participation in the program creates important environmental benefits in the areas where this cleaner, renewable electricity is generated.

Less expensive than you might think

Sunshine Energy is surprisingly inexpensive: for only \$9.75 more a month, you can help reduce CO₂ emissions and promote a more secure energy future.

Sign up today

Choosing Sunshine Energy is a simple, affordable way to do your part for America's energy and environmental future. Simply complete and return the form below, sign up at www.FPLsunshineenergy.com, or give us a call at 1-877-529-2610.

Do your part today by choosing Sunshine Energy!

David Bates
Sunshine Energy Program Manager

P. S. Remember, choosing Sunshine Energy helps in two ways: by promoting energy independence and by preserving the environment. Sign up today with the enrollment form below, through www.FPLsunshineenergy.com, or with a quick, toll-free call to 1-877-529-2610.

© 2007 Florida Power & Light Company. FPL and Sunshine Energy are trademarks of Florida Power & Light Company. FPL and Sunshine Energy are registered trademarks of Florida Power & Light Company.

Yes, I choose to participate in the Sunshine Energy program from Florida Power & Light

By signing below, I agree to enroll in Sunshine Energy from Florida Power & Light Company. I am 18 years of age and am authorized to make a change to this FPL account. I understand I will pay an additional amount of \$9.75 per month for renewable energy from cleaner generation sources of electricity like bioenergy, wind and solar.

sunshineenergy®

FPL ID# [Redacted]

Name: [Redacted]

Address (not a PO Box): [Redacted]

City: [Redacted] State: [Redacted] Zip: [Redacted]

Home Phone: [Redacted] Work Phone: [Redacted]

Email Address: [Redacted]

Signature: **X** Date: [Redacted]



FPL. POWERING TODAY. EMPOWERING TOMORROW™

FC07CCRW2



[Redacted]

Dear [Redacted]

As Americans, we have always supported freedom and independence. And, today, perhaps more than ever, we want to secure energy independence by utilizing innovative energy sources.

By choosing Sunshine Energy®, a renewable energy program offered by Florida Power & Light Company, you can have a positive impact on our energy future.

Purchasing renewable electricity not only promotes a brighter energy future, it also helps clean the air we breathe. Sunshine Energy is American-made and generated from renewable sources like wind, bioenergy and the sun. Your participation in the program helps avoid more than 10,800 pounds of carbon dioxide (CO₂) emissions from entering the air every year – as much as a car would produce in over 12,000 miles of driving. Since the program began, more than 35,000 customers have enrolled... and have together avoided over 311,000 tons of CO₂, which is the equivalent of removing over 55,000 cars from the road for one year.

For each month you're enrolled in the Sunshine Energy program, FPL ensures that 1,000 kWh of electricity from cleaner sources is produced by generators in Florida and other states. Your participation in the program creates important environmental benefits in the areas where this cleaner, renewable electricity is generated.

Less expensive than you might think

Sunshine Energy is surprisingly inexpensive: for only \$9.75 more a month, you can help reduce CO₂ emissions and promote a more secure energy future.

Sign up today

Choosing Sunshine Energy is a simple, affordable way to do your part for America's energy and environmental future. Simply complete and return the form below, sign up at www.FPLsunshineenergy.com, or give us a call at 1.877.529.2610.

Do your part today by choosing Sunshine Energy!

David Bates
Sunshine Energy Program Manager

P. S. Remember, choosing Sunshine Energy helps in two ways: by promoting energy independence and by preserving the environment. Sign up today with the enrollment form below, through www.FPLsunshineenergy.com, or with a quick, toll-free call to 1.877.529.2610.

© 2007 Florida Power & Light Company. All rights reserved. FPL is a registered trademark of Florida Power & Light Company. Sunshine Energy is a service mark of Florida Power & Light Company.

Yes, I choose to participate in the Sunshine Energy program from Florida Power & Light

By signing below, I agree to enroll in Sunshine Energy from Florida Power & Light Company. I am 18 years of age and am authorized to make a change to this FPL account. I understand I will pay an additional amount of \$9.75 per month for renewable energy from cleaner generation sources of electricity like bioenergy, wind and solar.



FPL POWERING TODAY. EMPOWERING TOMORROW™

sunshinenergy™

FPL ID# [Redacted]

Name: [Redacted]

Address (not a PO Box): [Redacted]

City: [Redacted] State: [Redacted] Zip: [Redacted]

Home Phone: [Redacted] Work Phone: [Redacted]

Email Address: [Redacted]

Signature: X Date: [Redacted]

FC07CC02



[Redacted]

Dear [Redacted]

As Americans, we have always supported freedom and independence. And, today, perhaps more than ever, we want to secure energy independence by utilizing innovative energy sources.

By choosing Sunshine EnergySM, a renewable energy program offered by Florida Power & Light Company, you can have a positive impact on our energy future.

Purchasing renewable electricity not only promotes a brighter energy future, it also helps clean the air we breathe. Sunshine Energy is American-made and generated from renewable sources like wind, bioenergy and the sun. Your participation in the program helps avoid more than 10,800 pounds of carbon dioxide (CO₂) emissions from entering the air every year – as much as a car would produce in over 12,000 miles of driving. Since the program began, more than 35,000 customers have enrolled – and have together avoided over 311,000 tons of CO₂, which is the equivalent of removing over 55,000 cars from the road for one year.

For each month you're enrolled in the Sunshine Energy program, FPL ensures that 1,000 kWh of electricity from cleaner sources is produced by generators in Florida and other states. Your participation in the program creates important environmental benefits in the areas where this cleaner, renewable electricity is generated.

Less expensive than you might think

Sunshine Energy is surprisingly inexpensive: for only \$9.75 more a month, you can help reduce CO₂ emissions and promote a more secure energy future.

Sign up today

Choosing Sunshine Energy is a simple, affordable way to do your part for America's energy and environmental future. Simply complete and return the form below, sign up at www.FPLsunshineenergy.com, or give us a call at 1 877 529 2610.

Do your part today by choosing Sunshine Energy!

David Bates
Sunshine Energy Program Manager

P. S. Remember, choosing Sunshine Energy helps in two ways: by promoting energy independence and by preserving the environment. Sign up today with the enrollment form below, through www.FPLsunshineenergy.com, or with a quick, toll-free call to 1 877 529 2610.

© 2007 Florida Power & Light Company. All rights reserved. FPL, Sunshine Energy and the Sunshine Energy logo are trademarks of Florida Power & Light Company.

Yes, I choose to participate in the Sunshine Energy program from Florida Power & Light

By signing below, I agree to enroll in Sunshine Energy from Florida Power & Light Company. I am 18 years or older and am authorized to make a change to this FPL account. I understand I will pay an additional amount of \$9.75 per month for renewable energy from cleaner generation sources of electricity like bioenergy, wind and solar.

sunshineenergySM

FPL ID#

Name: [Redacted]

Address (not a PO Box): [Redacted]

City: [Redacted] State: [Redacted] Zip: [Redacted]

Home Phone: [Redacted] Work Phone: [Redacted]

Email Address: [Redacted]

Signature: **X** Date: [Redacted]



FPL POWERING TODAY. EMPOWERING TOMORROW.SM

FCGT0001



Dear [Redacted]

As Americans, we have always supported freedom and independence. And, today, perhaps more than ever, we want to secure energy independence by utilizing innovative energy sources.

By choosing Sunshine EnergySM, a renewable energy program offered by Florida Power & Light Company, you can have a positive impact on our energy future.

Purchasing renewable electricity not only promotes a brighter energy future, it also helps clean the air we breathe. Sunshine Energy is American-made and generated from renewable sources like wind, bioenergy and the sun. Your participation in the program helps avoid more than 10,800 pounds of carbon dioxide (CO₂) emissions from entering the air every year -- as much as a car would produce in over 12,000 miles of driving. Since the program began, more than 35,000 customers have enrolled, and have together avoided over 311,000 tons of CO₂, which is the equivalent of removing over 55,000 cars from the road for one year.

For each month you're enrolled in the Sunshine Energy program, FPL ensures that 1,000 kWh of electricity from cleaner sources is produced by generators in Florida and other states. Your participation in the program creates important environmental benefits in the areas where this cleaner, renewable electricity is generated.

Less expensive than you might think

Sunshine Energy is surprisingly inexpensive: for only \$9.75 more a month, you can help reduce CO₂ emissions and promote a more secure energy future.

Sign up today

Choosing Sunshine Energy is a simple, affordable way to do your part for America's energy and environmental future. Simply complete and return the form below, sign up at www.FPLsunshineenergy.com, or give us a call at 1-877-529-2610.

Do your part today by choosing Sunshine Energy!

David Bates
Sunshine Energy Program Manager

P. S. Remember, choosing Sunshine Energy helps in two ways: by promoting energy independence and by preserving the environment. Sign up today with the enrollment form below, through www.FPLsunshineenergy.com, or with a quick, toll-free call to 1-877-529-2610.

© 2007 FPL. All rights reserved. FPL and Sunshine Energy are trademarks of Florida Power & Light Company.

Yes, I choose to participate in the Sunshine Energy program from Florida Power & Light

By signing below, I agree to enroll in Sunshine Energy from Florida Power & Light Company. I am 18 years or older and am authorized to make a change to this FPL account. I understand I will pay an additional amount of \$9.75 per month for renewable energy from cleaner generation sources of electricity like bioenergy, wind and solar.

sunshineenergySM

FPL ID# [Redacted]

Name: [Redacted]

Address (not a PO Box): [Redacted]

City: [Redacted] State: [Redacted] Zip: [Redacted]

Home Phone: [Redacted] Work Phone: [Redacted]

Email Address: [Redacted]

Signature: X Date: [Redacted]



FPL POWERING TODAY. EMPOWERING TOMORROW.SM

FC07CC051



Dear Venkat Puskur:

As Americans, we have always supported freedom and independence. And, today, perhaps more than ever, we want to secure energy independence by utilizing innovative energy sources.

By choosing Sunshine Energy®, a renewable energy program offered by Florida Power & Light Company, you can have a positive impact on our energy future.

Purchasing renewable electricity not only promotes a brighter energy future, it also helps clean the air we breathe. Sunshine Energy is American-made and generated from renewable sources like wind, bioenergy and the sun. Your participation in the program helps avoid more than 10,800 pounds of carbon dioxide (CO2) emissions from entering the air every year – as much as a car would produce in over 12,000 miles of driving. Since the program began, more than 35,000 customers have enrolled – and have together avoided over 311,000 tons of CO2, which is the equivalent of removing over 55,000 cars from the road for one year.

For each month you're enrolled in the Sunshine Energy program, FPL ensures that 1,000 kWh of electricity from cleaner sources is produced by generators in Florida and other states. Your participation in the program creates important environmental benefits in the areas where this cleaner, renewable electricity is generated.

Less expensive than you might think

Sunshine Energy is surprisingly inexpensive: for only \$9.75 more a month, you can help reduce CO2 emissions and promote a more secure energy future.

Sign up today

Choosing Sunshine Energy is a simple, affordable way to do your part for America's energy and environmental future. Simply complete and return the form below, sign up at www.FPLsunshineenergy.com, or give us a call at 1-877-529-2610.

Do your part today by choosing Sunshine Energy!

David Bates
Sunshine Energy Program Manager

P. S. Remember, choosing Sunshine Energy helps in two ways: by promoting energy independence and by preserving the environment. Sign up today with the enrollment form below, through www.FPLsunshineenergy.com, or with a quick, toll-free call to 1-877-529-2610.

© 2003 FPL. All rights reserved. FPL and Sunshine Energy are registered trademarks of Florida Power & Light Company. All other trademarks are the property of their respective owners.

Yes, I choose to participate in the Sunshine Energy program from Florida Power & Light

By signing below, I agree to enroll in Sunshine Energy from Florida Power & Light Company. I am 18 years or older and am authorized to make a change to this FPL account. I understand I will pay an additional amount of \$9.75 per month for renewable energy from cleaner generation sources of electricity like bioenergy, wind and solar.

sunshineenergy®

FPL ID# [Redacted]

Name: [Redacted]

Address (not a PO Box): [Redacted]

City: [Redacted] State: [Redacted] Zip: [Redacted]

Home Phone: [Redacted] Work Phone: [Redacted]

Email Address: [Redacted]

Signature: **X** [Redacted] Date: [Redacted]



FPL POWERING TODAY. EMPOWERING TOMORROW.™

F070CEW1



[Redacted]

Dear [Redacted]

As Americans, we have always supported freedom and independence. And, today, perhaps more than ever, we want to secure energy independence by utilizing innovative energy sources.

By choosing Sunshine Energy®, a renewable energy program offered by Florida Power & Light Company, you can have a positive impact on our energy future.

Purchasing renewable electricity not only promotes a brighter energy future, it also helps clean the air we breathe. Sunshine Energy is American-made and generated from renewable sources like wind, bioenergy and the sun. Your participation in the program helps avoid more than 10,800 pounds of carbon dioxide (CO₂) emissions from entering the air every year – as much as a car would produce in over 12,000 miles of driving. Since the program began, more than 35,000 customers have enrolled – and have together avoided over 311,000 tons of CO₂, which is the equivalent of removing over 55,000 cars from the road for one year.

For each month you're enrolled in the Sunshine Energy program, FPL ensures that 1,000 kWh of electricity from cleaner sources is produced by generators in Florida and other states. Your participation in the program creates important environmental benefits in the areas where this cleaner, renewable electricity is generated.

Less expensive than you might think

Sunshine Energy is surprisingly inexpensive: for only \$9.75 more a month, you can help reduce CO₂ emissions and promote a more secure energy future.

Sign up today

Choosing Sunshine Energy is a simple, affordable way to do your part for America's energy and environmental future. Simply complete and return the form below, sign up at www.FPLsunshineenergy.com, or give us a call at 1-877-529-2610.

Do your part today by choosing Sunshine Energy!

David Bates
Sunshine Energy Program Manager

P. S. Remember, choosing Sunshine Energy helps in two ways: by promoting energy independence and by preserving the environment. Sign up today with the enrollment form below, through www.FPLsunshineenergy.com, or with a quick, toll-free call to 1-877-529-2610.

© 2010 Florida Power & Light Company. All rights reserved. Sunshine Energy is a registered trademark of Florida Power & Light Company.

Yes, I choose to participate in the Sunshine Energy program from Florida Power & Light

By signing below, I agree to enroll in Sunshine Energy from Florida Power & Light Company. I am 18 years of age and am authorized to make a change to this FPL account. I understand I will pay an additional amount of \$9.75 per month for renewable energy from cleaner generation sources of electricity like bioenergy, wind and solar.



FPL POWERING TODAY. EMPOWERING TOMORROW.™

sunshineenergy®

FPL ID# [Redacted]

Name: [Redacted]

Address (not a PO Box): [Redacted]

City: [Redacted] State: [Redacted] Zip: [Redacted]

Home Phone: [Redacted] Work Phone: [Redacted]

Email Address: [Redacted]

Signature: **X** Date: [Redacted]

FC07CCPG3



FPL

[Redacted]

Dear [Redacted]

As Americans, we have always supported freedom and independence. And, today, perhaps more than ever, we want to secure energy independence by utilizing innovative energy sources.

By choosing Sunshine Energy®, a renewable energy program offered by Florida Power & Light Company, you can have a positive impact on our energy future.

Purchasing renewable electricity not only promotes a brighter energy future, it also helps clean the air we breathe. Sunshine Energy is American-made and generated from renewable sources like wind, bioenergy and the sun. Your participation in the program helps avoid more than 10,800 pounds of carbon dioxide (CO₂) emissions from entering the air every year -- as much as a car would produce in over 12,000 miles of driving. Since the program began, more than 35,000 customers have enrolled -- and have together avoided over 311,000 tons of CO₂, which is the equivalent of removing over 55,000 cars from the road for one year.

For each month you're enrolled in the Sunshine Energy program, FPL ensures that 1,000 kWh of electricity from cleaner sources is produced by generators in Florida and other states. Your participation in the program creates important environmental benefits in the areas where this cleaner, renewable electricity is generated.

Less expensive than you might think

Sunshine Energy is surprisingly inexpensive: for only \$9.75 more a month, you can help reduce CO₂ emissions and promote a more secure energy future.

Sign up today

Choosing Sunshine Energy is a simple, affordable way to do your part for America's energy and environmental future. Simply complete and return the form below, sign up at www.FPLsunshineenergy.com, or give us a call at 1-877-529-2610.

Do your part today by choosing Sunshine Energy!

David Bates
Sunshine Energy Program Manager

P. S. Remember, choosing Sunshine Energy helps in two ways: by promoting energy independence and by preserving the environment. Sign up today with the enrollment form below, through www.FPLsunshineenergy.com, or with a quick, toll-free call to 1-877-529-2610.

© 2007 Florida Power & Light Company. All rights reserved. FPL and Sunshine Energy are registered trademarks of Florida Power & Light Company.

Yes, I choose to participate in the Sunshine Energy program from Florida Power & Light

By signing below, I agree to enroll in Sunshine Energy from Florida Power & Light Company. I am 18 years of age and am authorized to make a change to this FPL account. I understand I will pay an additional amount of \$9.75 per month for renewable energy from cleaner generation sources of electricity like bioenergy, wind and solar.



FPL POWERING TODAY. EMPOWERING TOMORROW™

sunshineenergy®

FPL ID# [Redacted]

Name: [Redacted]

Address (not a PO Box): [Redacted]

City: [Redacted] State: [Redacted] Zip: [Redacted]

Home Phone: [Redacted] Work Phone: [Redacted]

Email Address: [Redacted]

Signature: **X** Date: [Redacted]

FC07CCCF2

**Florida Power & Light Company
Docket No. 070626-EI
Staff's Data Request 9-5-08
Interrogatory No. 18
Page 1 of 1**

Q.

Please provide a copy of each bangtail sent regarding the Sunshine Energy Program. Please describe the promotional objective(s) associated with each bangtail provided.

A.

Attached are copies of bangtails for the following year: 2006, 2007, and 2008. The objective of the bangtails was to promote awareness of the Sunshine Energy program and the many benefits of the program, and to increase participation over time to maximize enrollment, resulting in the purchase of more RECs

FPSC

DATA

REQUEST

NO. 18

***15* ATTACHMENTS**

I'd like to sign up for cleaner electricity! FPL Account Number _____

Customer Name _____

Address (not a P.O. Box) _____

Apt. No. _____

City _____

State _____

Zip _____

Home Phone _____

Work Phone _____

Email Address _____

By signing below, I agree to enroll for the Sunshine Energy program from Florida Power & Light. I am 18 years or older and am authorized to make a change to this FPL account. I understand I will pay a monthly surcharge of \$9.75 for the environmental credits associated with cleaner generation sources of electricity like bioenergy, wind and solar.

Signature **X** _____

Date _____

Simply include this form with your monthly FPL payment, or mail separately to: FPL, P.O. Box 3070, Tequesta, FL 33469
For more information about Sunshine Energy call 1-877-529-2610 or visit www.FPLsunshineenergy.com

F0106



By choosing *Sunshine Energy*, you can:

- Avoid over 8,000 pounds of carbon dioxide (CO₂) emissions nationwide in just one year – as much as your car would produce in almost 9,000 miles of driving!
- Support renewable generation from cleaner sources like bioenergy, wind and solar.
- Reduce the demand for electricity generated from traditional fuel sources

Less Expensive Than You Might Think

Doing your part costs just a small amount. For only \$9.75 more per month, you'll support cleaner electricity generation, help reduce CO₂ emissions and support the development of new renewable sources of electricity.

Sign Up Today And Help Preserve Our Environment For The Future

Choosing *Sunshine Energy* makes it easy to do your part for the environment. Just return the form above with your payment or call 1-877-529-2610.

Doing Your Part for the Environment
Just Got Easier



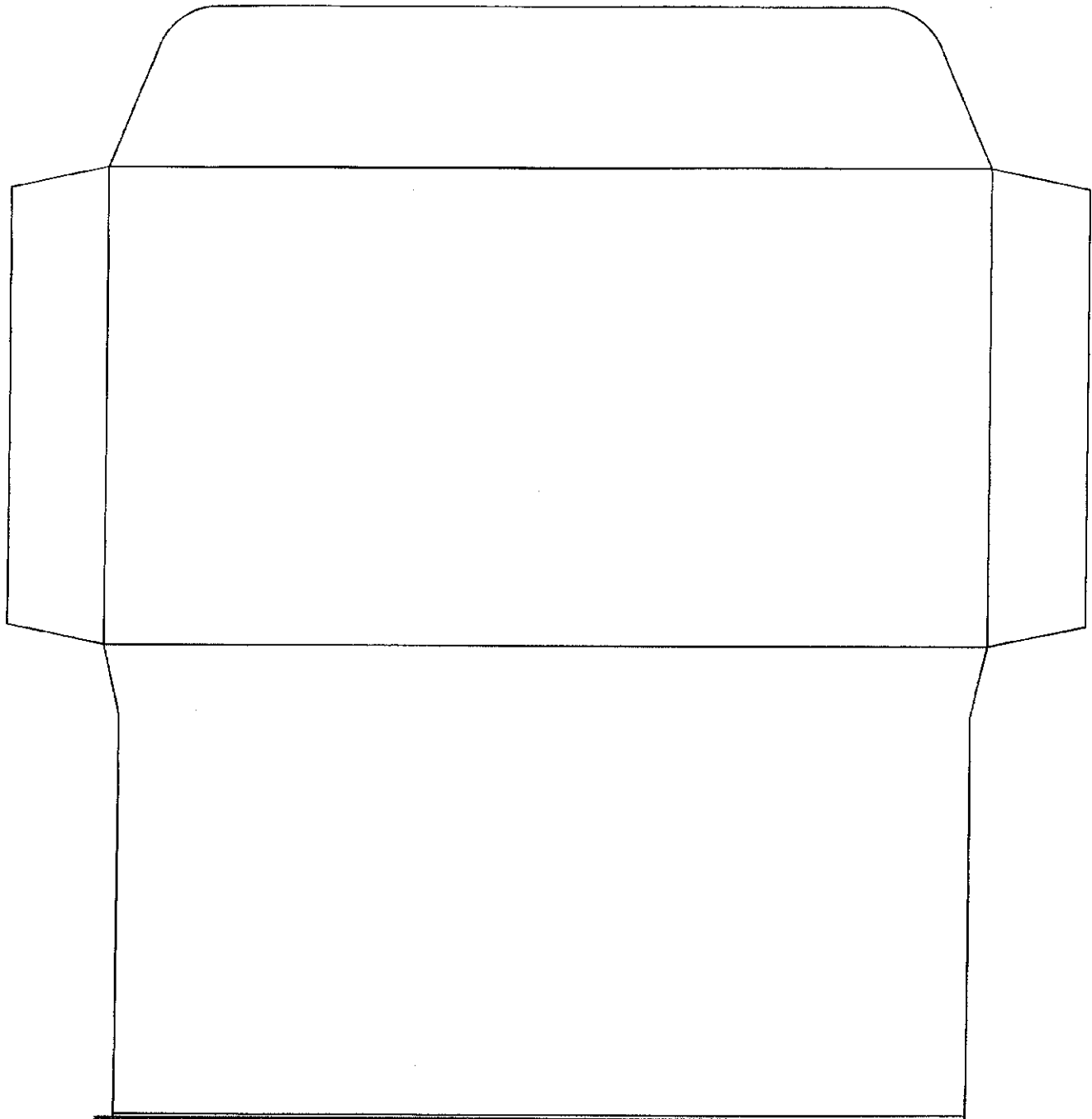

Choose sunshinenergy® Today And Help Preserve Our Environment For The Future.

Because it's sometimes difficult to find an easy way to do your part for the environment, FPL is pleased to offer you the Sunshine Energy® program. *Sunshine Energy* uses cleaner sources of energy that are less polluting than the traditional fuel sources most widely used to make electricity in the U.S.

For each month that you participate in the program, FPL ensures that 1,000 kWh of cleaner electricity from sources like wind, bioenergy and solar is generated and delivered to power systems serving Florida and other states nationwide. Your participation also creates important environmental benefits in the areas where this cleaner, renewable electricity is generated.

DIVIDER

BLANK

PAGE

I'd like to sign up for cleaner electricity! FPL Acct # _____

Customer Name _____

Address (not a P.O. Box) _____

Apt. No. _____

City _____

State _____

Zip _____

Home Phone _____

Work Phone _____

Email Address _____

By signing below, I agree to enroll for the Sunshine Energy program from Florida Power & Light Company. I am 18 years or older and am authorized to make a change to this FPL account. I understand I will pay a monthly surcharge of \$9.75 for the environmental credits associated with cleaner generation sources of electricity like bioenergy, wind and solar.

Signature **X** _____

Date _____

Simply include this form with your monthly FPL payment, or mail separately to: FPL, P.O. Box 3070, Tequesta, FL 33469
For more information about Sunshine Energy, call 1-877-529-2610 or visit www.FPLsunshineenergy.com



By choosing *Sunshine Energy*, you can:

- Support cleaner, American-made energy sources like bioenergy, wind and solar
- Help reduce the demand for electricity generated from traditional fuel sources
- Take a positive step toward a more secure energy future for America.

Less expensive than you might think

For only \$9.75 more per month, you'll support cleaner electricity generation now as well as development of new renewable sources.

Signing up is easy

Help brighten America's energy future by choosing *Sunshine Energy*. Simply return the form above with your payment, call 1-877-529-2610 or visit www.FPLsunshineenergy.com

Energy Independence – Your choice can
have a positive impact on our future.



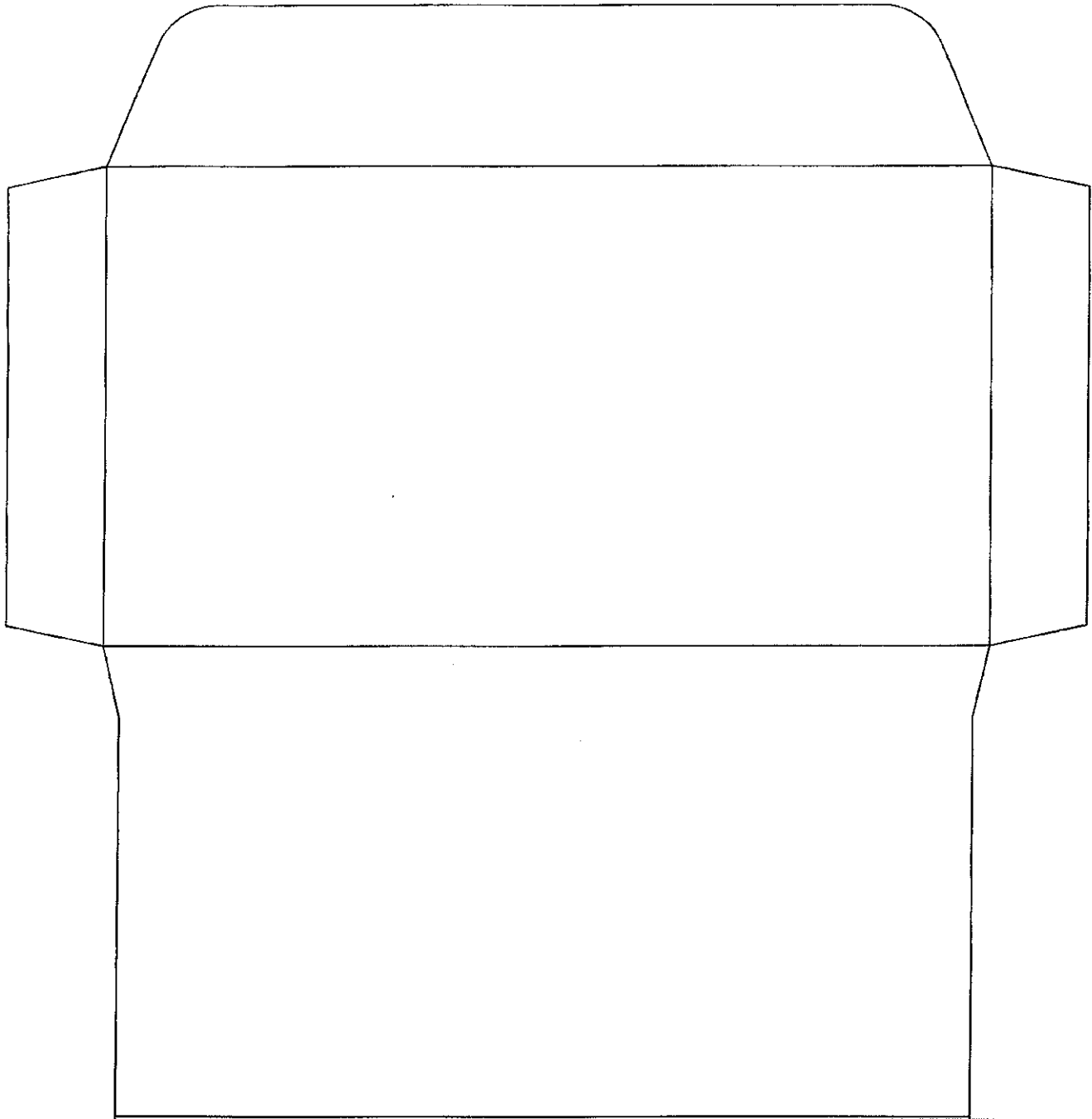

**Choose sunshinenergy[®] today to support
100% American-made sources of electricity**

As Americans, we have always supported freedom and independence. And today, perhaps more than ever, we want to secure energy independence by utilizing innovative energy sources. By participating in the Sunshine Energy[®] program from Florida Power & Light Company, you can have a positive impact on our energy future.

Each month you participate in the program, FPL ensures that 1,000 kWh of cleaner electricity – from sources like bioenergy, wind and solar – is generated and delivered to power systems serving Florida and other states nationwide. Your participation also creates important environmental benefits in the areas where this cleaner, renewable electricity is generated.

DIVIDER

BLANK

PAGE

I'd like to sign up for cleaner electricity! FPL Acct # _____

Customer Name _____

Address (not a P.O. Box) _____ Apt. No. _____

City _____ State _____ Zip _____

Home Phone _____ Work Phone _____

Email Address _____

By signing below, I agree to enroll for the Sunshine Energy® program from Florida Power & Light Company. I am 18 years or older and am authorized to make a change to this FPL account. I understand I will pay a monthly surcharge of \$9.75 for the environmental credits associated with cleaner generation sources of electricity like bioenergy, wind and solar.

Signature **X** _____ Date _____

Simply include this form with your monthly FPL payment, or mail separately to: FPL, P.O. Box 3070, Tequesta, FL 33469.
For more information about Sunshine Energy, call 1-877-529-2610 or visit www.FPLsunshineenergy.com



By choosing Sunshine Energy, you can:

- Support cleaner, American-made energy sources like bioenergy, wind and solar.
- Help reduce the demand for electricity generated from traditional fuel sources.
- Take a positive step toward a more secure energy future for America

Less expensive than you might think

For only \$9.75 more per month, you'll support cleaner electricity generation now as well as development of new renewable sources

Signing up is easy

Help brighten America's energy future by choosing *Sunshine Energy*. Simply return the form above with your payment, call 1-877-529-2610 or visit www.FPLsunshineenergy.com

Energy Independence – Your choice can have a positive impact on our future.



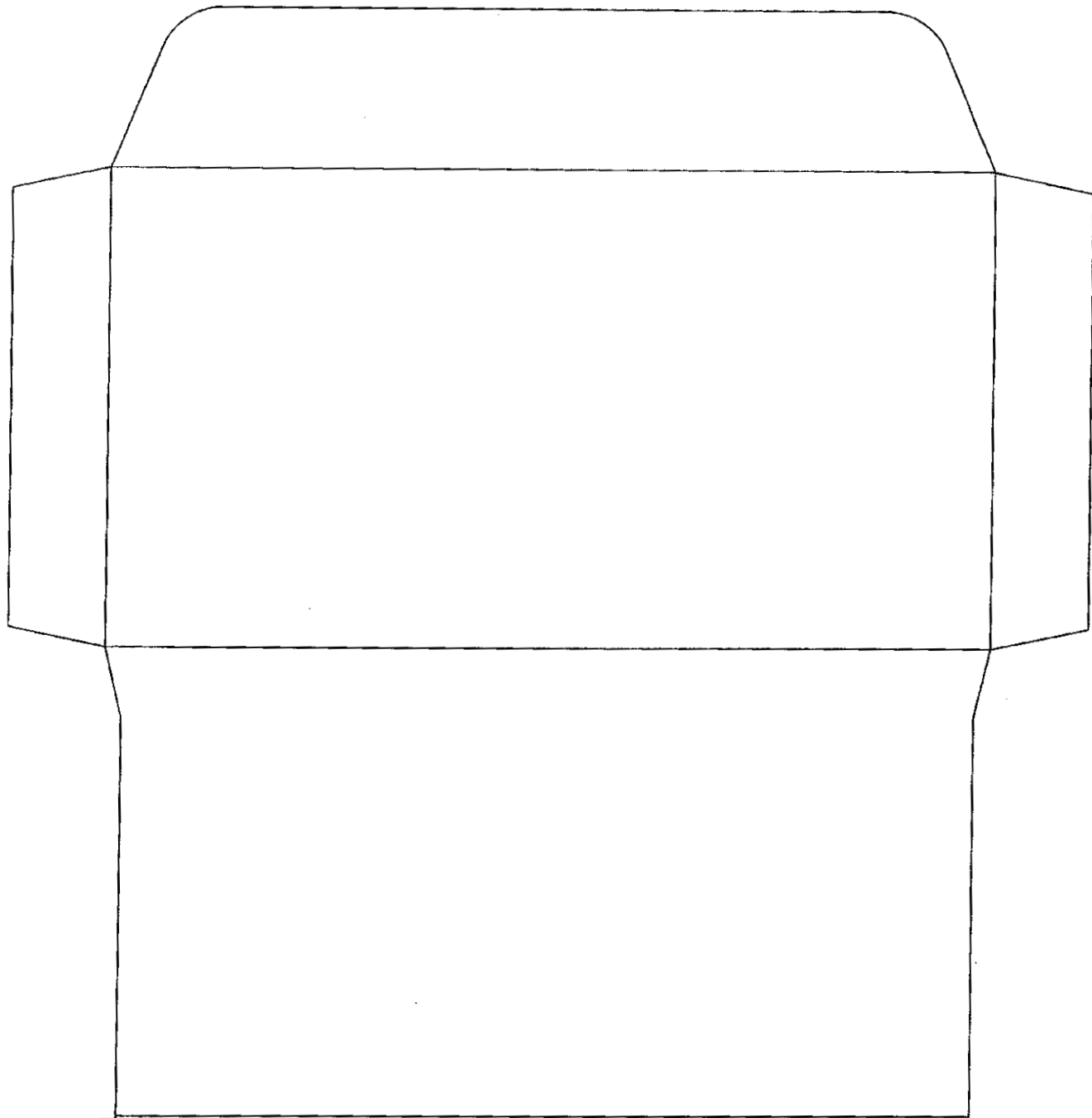

**Choose sunshinenergy® today to support
100% American-made sources of electricity**

As Americans, we have always supported freedom and independence. And today, perhaps more than ever, we want to secure energy independence by utilizing innovative energy sources. By participating in the Sunshine Energy[®] program from Florida Power & Light Company, you can have a positive impact on our energy future.

Each month you participate in the program, FPL ensures that 1,000 kWh of cleaner electricity – from sources like bioenergy, wind and solar – is generated and delivered to power systems serving Florida and other states nationwide. Your participation also creates important environmental benefits in the areas where this cleaner, renewable electricity is generated.

DIVIDER

BLANK

PAGE

I'd like to sign up for cleaner electricity! FPL Acct # _____

Customer Name _____

Address (not a P.O. Box) _____

Apt. No. _____

City _____

State _____

Zip _____

Home Phone _____

Work Phone _____

Email Address _____

By signing below, I agree to enroll for the Sunshine Energy® program from Florida Power & Light Company. I am 18 years or older and am authorized to make a change to this FPL account. I understand I will pay a monthly surcharge of \$9.75 for the environmental credits associated with cleaner generation sources of electricity like bioenergy, wind and solar.

Signature _____

Date _____

Simply include this form with your monthly FPL payment, or mail separately to: FPL, P.O. Box 3070 Tequesta FL 33469
For more information about Sunshine Energy, call 1-877-529-2610 or visit www.FPLsunshineenergy.com

F0306



Choose *Sunshine Energy* and help support renewable electricity

For each month you participate in the program, FPL ensures that 1,000 kWh of cleaner electricity — from sources like bioenergy, wind and solar — is generated and delivered to power systems serving Florida and other states nationwide. Your participation also creates important environmental benefits in the areas where this cleaner, renewable electricity is generated.

Less expensive than you might think

Sunshine Energy is only \$9.75 more per month, less than the cost of a pizza.

Sign up today and help make a difference

It's easy. Simply return the form above with your payment, call 1-877-529-2610 or visit www.FPLsunshineenergy.com.

How much of a difference can one person make?



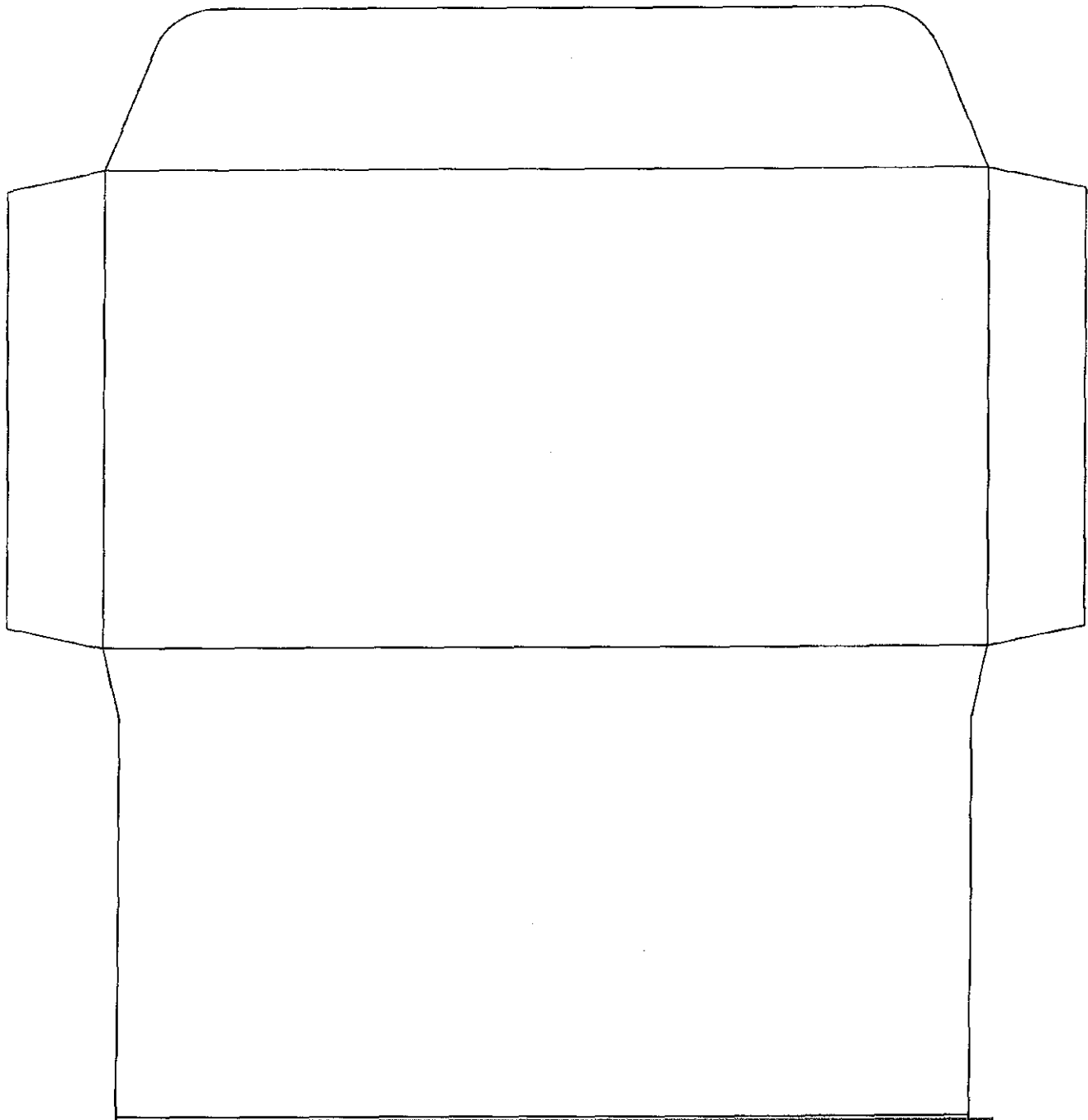

**Just ask one of the more than
25,000 sunshinenergy® program participants.**

Thanks to them, a **new solar facility** is being built at Rothenbach Park in Sarasota. This 250 kilowatt solar array will be the **largest in Florida**, and is expected to prevent more than 680,000 pounds of carbon dioxide (CO₂) emissions every year – that's the same as not driving 760,000 miles every year!

An estimated 96,000 *tons* of CO₂ emissions—enough to take over 17,000 cars off the road for one year – have *already* been avoided as a result of their participation!

And by choosing *Sunshine Energy*, you can make this impact even larger. Just one customer can support the development of new solar in Florida plus prevent over 8,000 pounds of CO₂ in one year.

DIVIDER

BLANK

PAGE

I'd like to sign up for cleaner electricity! FPL Acct. # _____

Customer Name _____

Address (not a P.O. Box) _____

Apt. No. _____

City _____

State _____

Zip _____

Home Phone _____

Work Phone _____

Email Address _____

By signing below, I agree to enroll for the Sunshine Energy® program from Florida Power & Light Company. I am 18 years or older and am authorized to make a change to this FPL account. I understand I will pay a monthly surcharge of \$9.75 for the environmental credits associated with cleaner generation sources of electricity like bioenergy, wind and solar.

Signature _____

Date _____

Simply include this form with your monthly FPL payment, or mail separately to: FPL, P.O. Box 3070 Taquesta FL 33469
For more information about Sunshine Energy, call 1-877-529-2610 or visit www.FPLsunshineenergy.com



Choose *Sunshine Energy* and help support renewable electricity

For each month you participate in the program, FPL ensures that 1,000 kWh of cleaner electricity — from sources like bioenergy, wind and solar — is generated and delivered to power systems serving Florida and other states nationwide. Your participation also creates important environmental benefits in the areas where this cleaner, renewable electricity is generated.

Less expensive than you might think

Sunshine Energy is only \$9.75 more per month, less than the cost of a pizza.

Sign up today and help make a difference

It's easy. Simply return the form above with your payment, call 1-877-529-2610 or visit www.FPLsunshineenergy.com

How much of a difference can one person make?



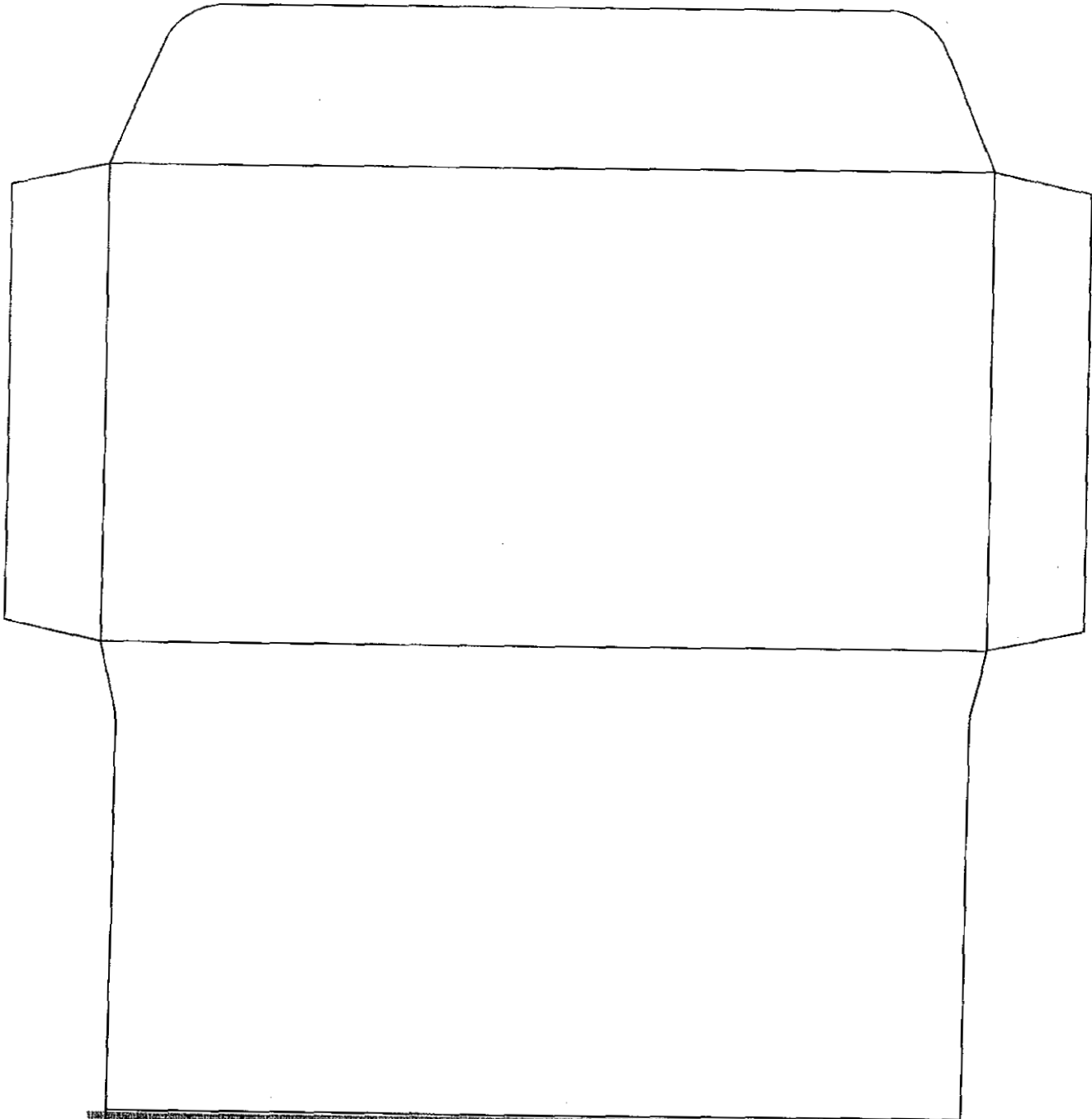

**Just ask one of the more than
25,000 sunshinenergy® program participants.**

Thanks to them, a **new solar facility** is being built at Rothenbach Park in Sarasota. This 250 kilowatt solar array will be the **largest in Florida**, and is expected to prevent more than 680,000 pounds of carbon dioxide (CO₂) emissions every year – that's the same as not driving 760,000 miles every year!

An estimated 96,000 tons of CO₂ emissions—enough to take over 17,000 cars off the road for one year – have *already* been avoided as a result of their participation!

And by choosing *Sunshine Energy*, you can make this impact even larger. Just one customer can support the development of new solar in Florida plus prevent over 8,000 pounds of CO₂ in one year.

DIVIDER

BLANK

PAGE



How much of a difference can one person make?

Sign up today and help make a difference
It's easy! Simply return the form above with your payment, call 1-877-529-2610 or visit www.FPLsunshineenergy.com.

Less expensive than you might think
Sunshine Energy is only \$9.75 more per month, less than the cost of a pizza.
For each month you participate in the program, FPL ensures that 1,000 kWh of cleaner electricity — from sources like bioenergy, wind and solar — is generated and delivered to power systems serving Florida and other states nationwide. Your participation also creates important environmental benefits in the areas where this cleaner, renewable electricity is generated.

Choose Sunshine Energy and help support renewable electricity



Simply include this form with your monthly FPL payment, or mail separately to: FPL, P.O. Box 3070, Tequesta, FL 33469 F0306
For more information about Sunshine Energy call 1-877-529-2610 or visit www.FPLsunshineenergy.com

I'd like to sign up for cleaner electricity! FPL Acct # _____
Customer Name _____
Address (not a P.O. Box) _____
Apt. No. _____
City _____
State _____ Zip _____
Home Phone _____
Work Phone _____
Email Address _____
By signing below, I agree to enroll for the Sunshine Energy program from Florida Power & Light Company. I am 18 years or older and am authorized to make a change to this FPL account. I understand I will pay a monthly surcharge of \$9.75 for the environmental credits associated with cleaner generation sources of electricity like bioenergy, wind and solar.
Signature _____ X
Date _____

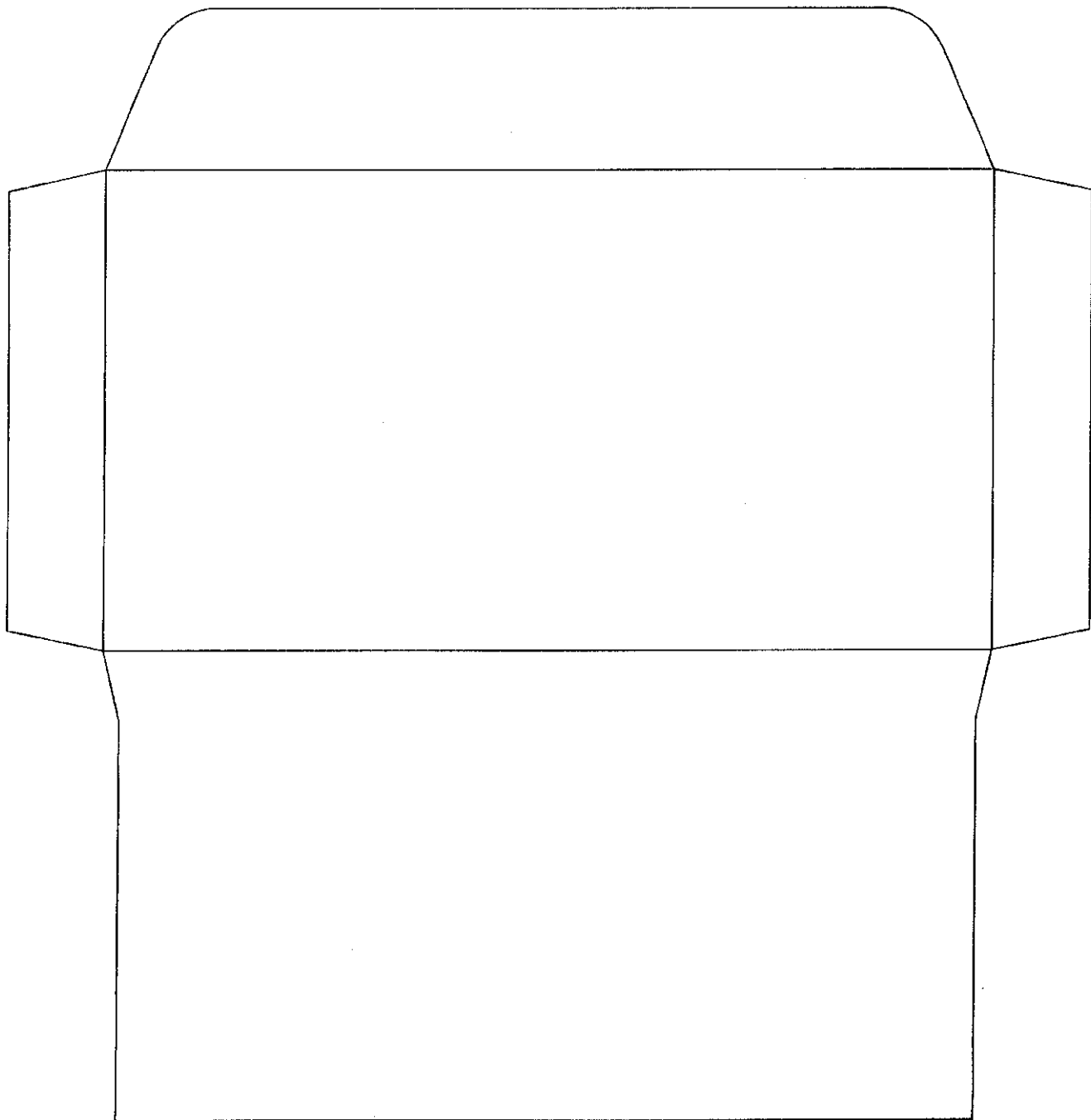

**Just ask one of the more than
25,000 sunshinenergy® program participants.**

Thanks to them, a **new solar facility** is being built at Rothenbach Park in Sarasota. This 250 kilowatt solar array will be the **largest in Florida**, and is expected to prevent more than 680,000 pounds of carbon dioxide (CO₂) emissions every year – that's the same as not driving 760,000 miles!

An estimated 96,000 tons of CO₂ emissions—enough to take over 17,000 cars off the road for one year – have *already* been avoided as a result of their participation!

And by choosing *Sunshine Energy* you can make this impact even larger. Just one customer can support the development of new solar in Florida plus prevent over 8,000 pounds of CO₂ in one year.

DIVIDER

BLANK

PAGE

I'd like to sign up for cleaner electricity! FPL Account Number _____

Customer Name _____

Address (not a P.O. Box) _____ Apt. No. _____

City _____ State _____ Zip _____

Home Phone _____ Work Phone _____

Email Address _____

By signing below, I agree to enroll for the Sunshine Energy program from Florida Power & Light. I am 18 years or older and am authorized to make a change to this FPL account. I understand I will pay a monthly surcharge of \$9.75 for the environmental credits associated with cleaner generation sources of electricity like bioenergy, wind and solar.

Signature _____ Date _____

Simply include this form with your monthly FPL payment, or mail separately to: FPL, P.O. Box 3070 Tequesta, FL 33469
For more information about Sunshine Energy, call 1-877-529-2610 or visit www.FPLsunshineenergy.com



By choosing Sunshine Energy, you can:

- Avoid over 8,000 pounds of carbon dioxide (CO₂) emissions nationwide in one year. In fact, since the program began, over 23,000 FPL customers have enrolled in the program avoiding over 82,000 tons of CO₂, - enough to take over 14,000 cars off the road for one year!
- Support renewable generation from cleaner sources like bioenergy, wind and solar.
- Reduce the demand for electricity generated from traditional fuel sources.

Less Expensive Than You Might Think

For only \$9.75 more per month, you'll support cleaner electricity generation as well as the development of new renewable sources of electricity.

Sign Up Today And Help Preserve Our Environment For The Future

Choosing Sunshine Energy makes it easy to do your part for the environment. Just return the form above with your payment or call 1-877-529-2610.



PLACE
STAMP
HERE
Postal Service
will not deliver
unless stamped



From _____
Mail Address _____
City _____ State _____ Zip Code _____

Now There's An Easy Way You Can Help
Brighten America's Energy Future.



DIVIDER

BLANK

PAGE

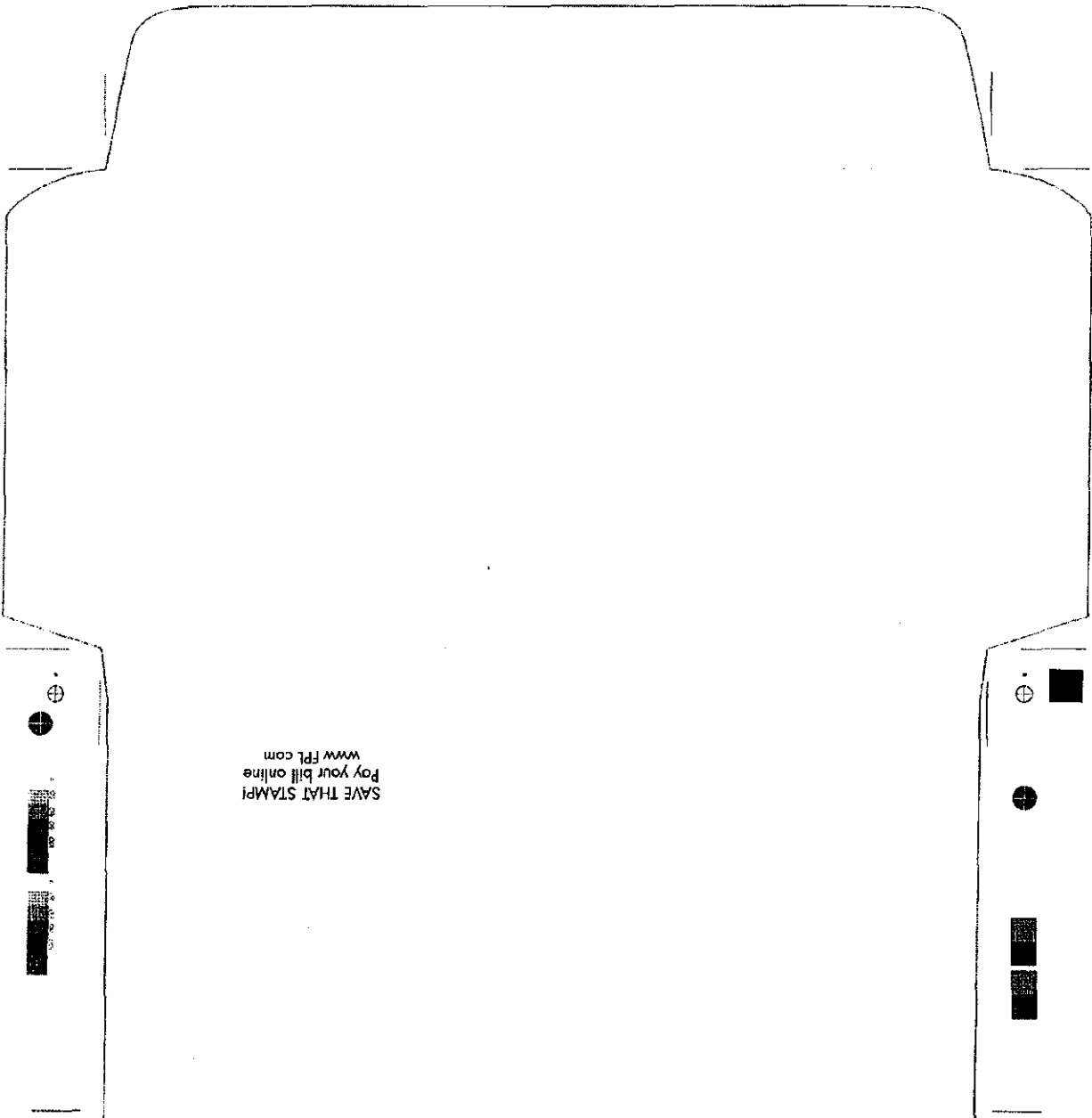

SAVE THAT STAMP!
Pay your bill online
www.FPL.com

Choose **sunshinenergy**® Today And Help Preserve Our Environment For The Future.

Because it's sometimes difficult to find an easy way to do your part for the environment, FPL offers you the Sunshine Energy® program. *Sunshine Energy* uses cleaner sources of energy that are less polluting than the traditional fuel sources most widely used to make electricity in the U.S.

For each month that you participate in the program, FPL ensures that 1,000 kWh of cleaner electricity - from sources like bioenergy, wind, and solar - is generated and delivered to power systems serving Florida and other states nationwide. Your participation also creates important environmental benefits in the areas where this cleaner renewable electricity is generated.

DIVIDER

BLANK

PAGE

I'd like to sign up for cleaner electricity! FPL Account Number _____

Customer Name _____

Address (not a P.O. Box) _____

Apt. No. _____

City _____

State _____

Zip _____

Home Phone _____

Work Phone _____

Email Address _____

By signing below, I agree to enroll for the Sunshine Energy program from Florida Power & Light. I am 18 years or older and am authorized to make a change to this FPL account. I understand I will pay a monthly surcharge of \$9.75 for the environmental credits associated with cleaner generation sources of electricity like bioenergy, wind and solar. For each month that you participate in the Sunshine Energy program, FPL ensures that 1,000 kWh of cleaner electricity from sources like wind, bioenergy and solar is generated and delivered to power systems serving Florida and other states nationwide. Your participation in the program creates important environmental benefits in the areas where this cleaner, renewable electricity is generated.

Signature _____

Date _____



Simply include this form with your monthly FPL payment, or mail separately to: FPL, P.O. Box 3070, Tequesta, FL 33469. For more information about Sunshine Energy, call 1-877-529-2610 or visit www.FPLsunshineenergy.com.

By choosing Sunshine Energy, you can:

- Avoid over 8,000 pounds of carbon dioxide (CO₂) emissions nationwide each year — as much as your car would produce in almost 7,000 miles of driving.
- Support renewable generation from cleaner sources like bioenergy, wind and solar.
- Reduce the demand for electricity generated from limited resources.

Less Expensive Than You Might Think

Did you know? It costs just a small amount, or only \$9.75 more per month, to support cleaner electricity generation, help reduce CO₂ emissions and support the development of new renewable sources of electricity.

Sign Up Today And Help Preserve Our Environment For The Future

Choosing Sunshine Energy makes it easy to do your part for the environment. Just return the form with your payment or call 1-877-529-2610.

Doing Your Part for the Environment
Just Got Easier



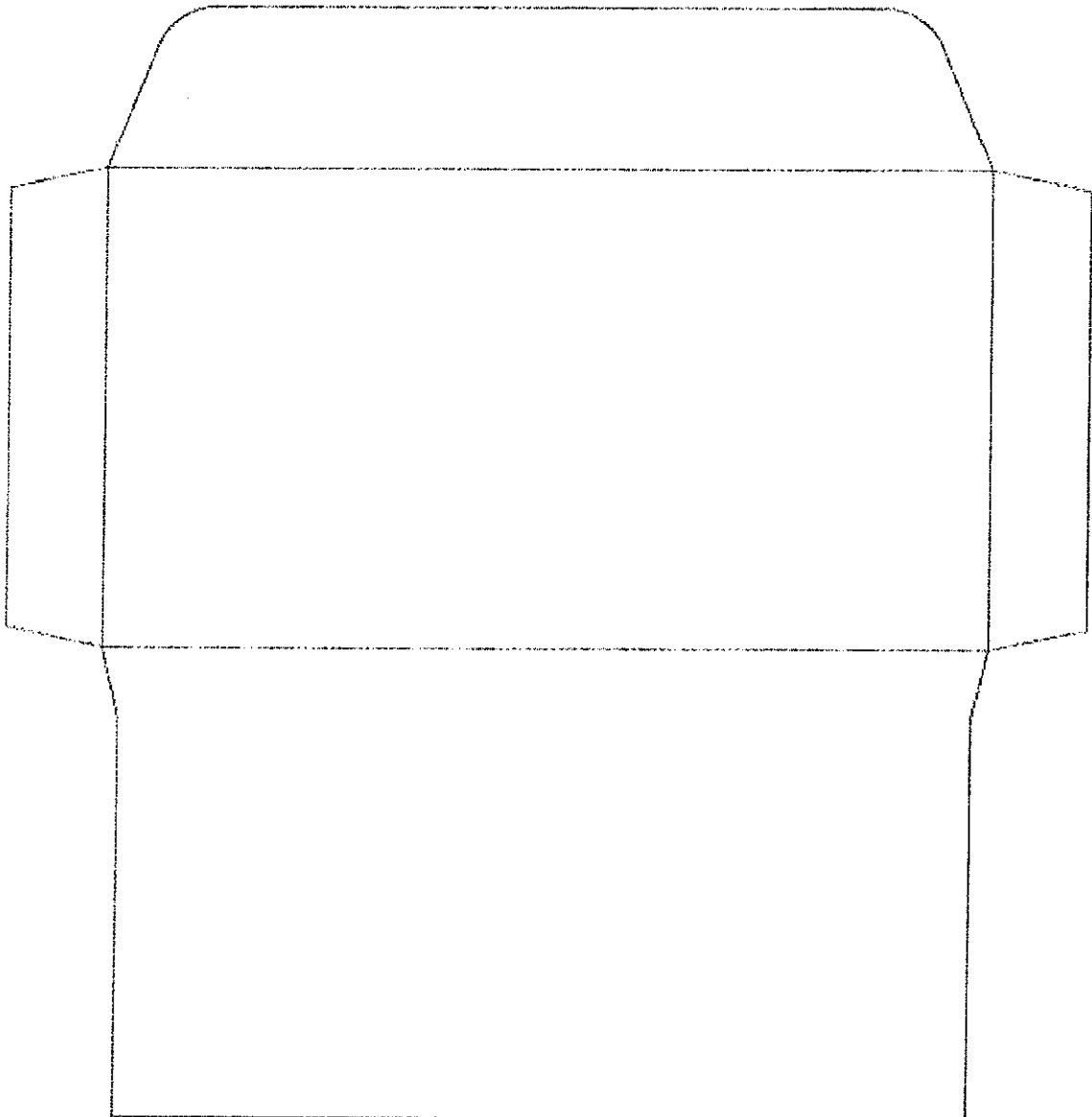

**Choose sunshine energy today And Help
Preserve Our Environment For The Future.**

It's sometimes difficult to find an easy way to do your part for the environment. The Sunshine Energy[®] program from FPL uses cleaner sources of energy that are less polluting than the fossil fuel sources most widely used to make electricity in the U.S.

DIVIDER

BLANK

PAGE

I'd like to sign up for cleaner electricity! FFL Acct # _____

Customer Name _____

Address (not a P.O. Box) _____ Apt. No. _____

City _____ State _____ Zip _____

Home Phone _____ Work Phone _____

Email Address _____

By signing below, I agree to enroll in the Sunshine Energy program from Florida Power & Light Company. I am 18 years or older and am authorized to make a change to this FPL account. I understand I will pay a monthly fee of \$9.75 for the environmental credits associated with cleaner generation sources of electricity like bioenergy wind and solar.

Signature **X** _____ Date _____

Simply include this form with your monthly FPL payment, or mail separately to:
 FPL Sunshine Energy Program, c/o Mailhouse 2201 Stirling Rd, Ft. Lauderdale, FL 33312-9988
 For more information about Sunshine Energy visit www.FPLsunshineenergy.com

FPD1088 

Your Impact As A Sunshine Energy Customer, By The Numbers:

- Prevent over 10 800 pounds of CO₂ emissions a year — as much as your car produces in over 12 000 miles of driving!
- Support additional solar projects — like the new 250 kW Solar Array at Sarasota's Rothenbach Park
- Help diminish demand for fossil fuel-generated energy

A Small Amount Helps Make A Difference.
 Choosing Sunshine Energy is less expensive than you might expect — for only \$9.75 more per month you can support renewable energy help cut CO₂ emissions and encourage energy independence

You Want To Be In This Number.
 Over 35 000 Sunshine Energy customers are making a difference — so join them today! Just complete and return the form above with your payment or call 1-877-529-2610

www.FPL.com/Payment

SAVE THAT STAMP
 Pay your bill online



From _____
 Mail Address _____
 City _____ State _____ ZIP Code _____

PLACE STAMP HERE
 Post Office
 Use the back
 of this stamp

Numbers Tell The Story — you Can Help Preserve The Environment



CUSTOMER APPROVAL

Please review this proof carefully.
 Leave blank for FPL representative only.
 Please mark in this field within 30 days of receipt of this form.

Approved by: _____
 Approved date: _____
 Approved by (w/initials): _____

Change information: _____

Your approval marks this National Envelope Corporation to proceed with this project as per your signed request, or as specified by the "Approved with Change" information furnished by you above.

Window: 5/8 x 2 1/4
 left: 1/8
 bottom: 5/8
 colors:
 PMS 631
 Black

Inside View

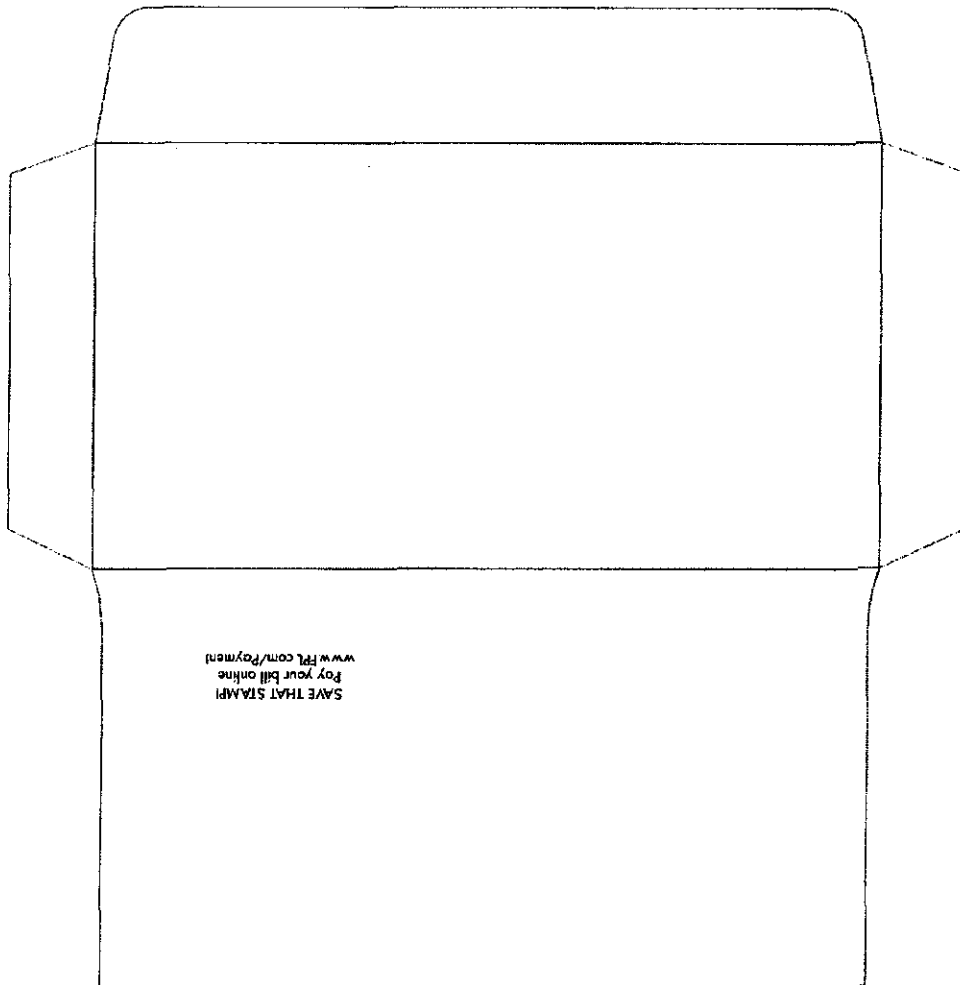

SAVE THAT STAMP!
Pay your bill online
www.fpl.com/Payment

Truth In Numbers – sunshinenergy® Customers Are Making A Positive Difference For The Environment.

Since 2004, FPL customers choosing the *Sunshine Energy* program have helped prevent over 311,000 tons of carbon dioxide (CO₂) emissions. That's like removing over 55,000 cars from the road for a year, or as much CO₂ as over 37 million trees would absorb in one year!

For each month that you participate in the program, FPL ensures that 1,000 kWh of cleaner electricity from sources like wind, bioenergy and solar is generated and delivered to power systems serving Florida and other states nationwide. Your participation also creates important environmental benefits in the areas where this cleaner, renewable electricity is generated.

DIVIDER

BLANK

PAGE

window: 5/8 x 2 1/4
 left: 4 1/8
 bottom: 5/8

colors:
 PMS 382
 Black

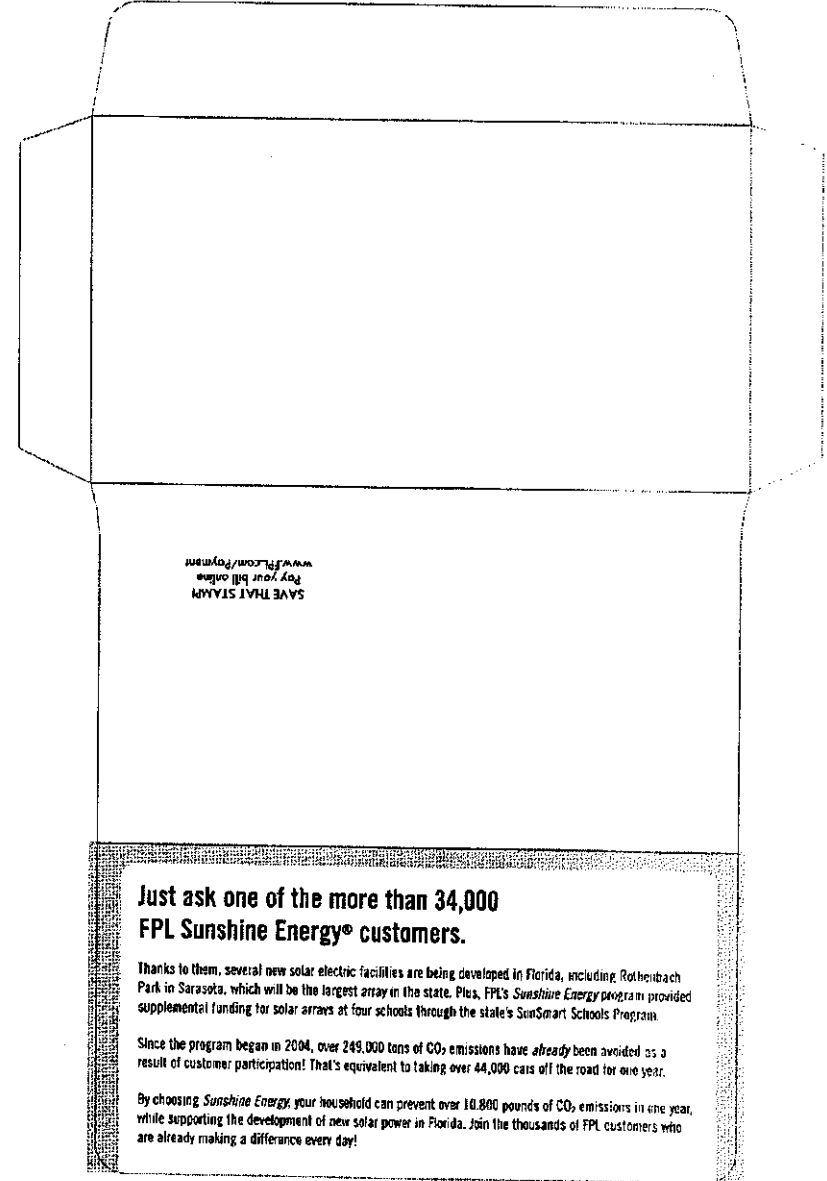
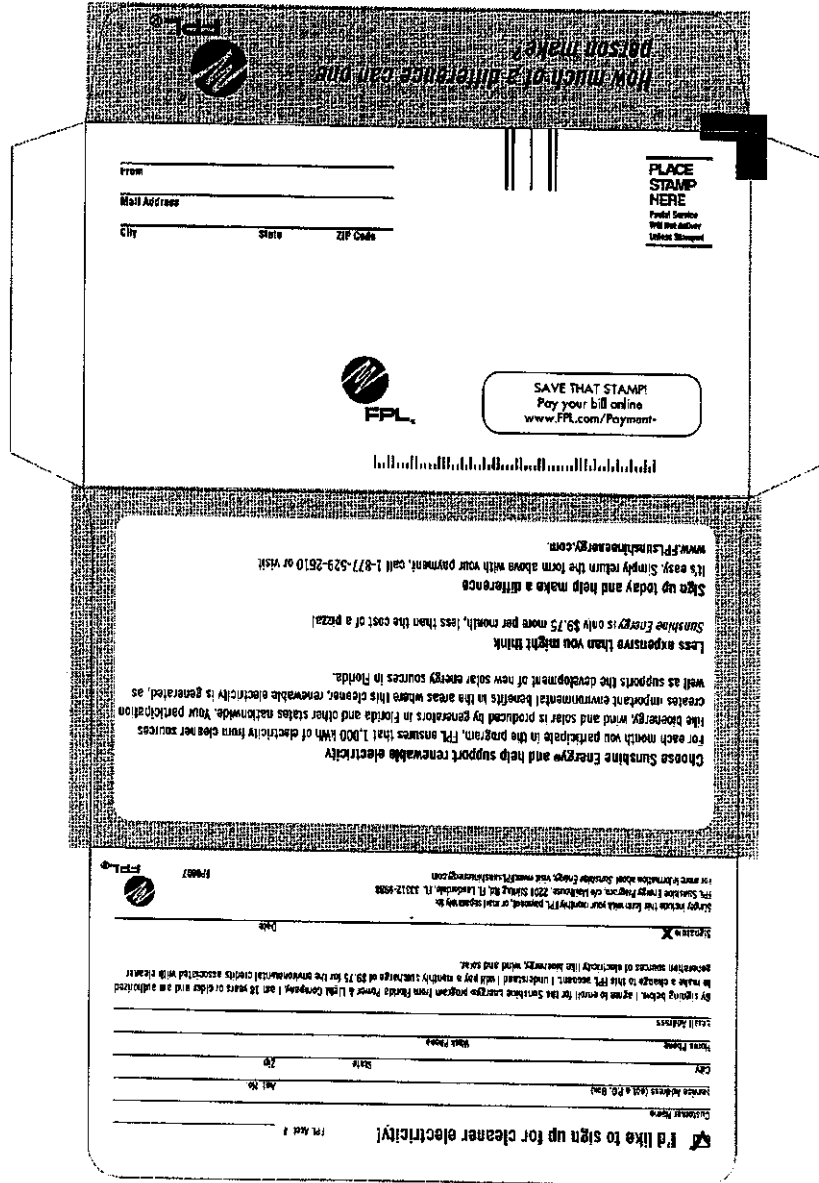

DIVIDER

BLANK

PAGE

DIVIDER

BLANK

PAGE

By choosing Sunlight's Energy, you're doing your part to help reduce greenhouse gas emissions. Sunlight's Energy is a clean, renewable energy source that's good for the planet and good for you.

Choose Sunlight's Energy and help progress our environment for the future.

I'd like to sign up for cleaner electricity! PPA Acc't # _____
Customer Name _____
Address Include P.O. Box _____ Appt. # _____
City _____ **State** _____ **Zip** _____
Home Phone _____ **Work Phone** _____
E-mail Address _____

By signing below, I agree to enroll for the Sunlight Energy program from Florida Power & Light Company. I am 18 years of age or older and am authorized to make a change to the PPA account. I understand I will pay a monthly surcharge of \$9.75 for the environmental credits associated with cleaner generation sources of electricity like bioenergy, wind and solar.

Signature _____ **Date** _____

Simply include this form with your monthly PPA payment, or mail separately to: PPA, Sunlight Energy Program, c/o Mail House, 2201 Spring Rd. Ft. Lauderdale, FL 33314-9922. For more information about Sunlight Energy, visit www.FPLand/orenergy.com



By choosing Sunlight's Energy, you're doing your part to help reduce greenhouse gas emissions. Sunlight's Energy is a clean, renewable energy source that's good for the planet and good for you.

Let's Environment. You're the Right Fit!

Sign Up Today! And Help Progress Our Environment for the Future.

www.fpl.com/energy

SAVE THAT STAMP!
 For how to use
 BOTTOM 3/8
 1/8 x 1/8
 5/8 x 2-1/4
 WINDOW

PLACE STAMP HERE

FORM _____
DATE _____
NO. OF COPIES _____

Doing Your Part for the Environment
 Now Easier than Ever



DIVIDER

BLANK

PAGE

I'd like to sign up for cleaner electricity! FPL Acct # _____

Customer Name _____

Address (not a P.O. Box) _____

Apt. No. _____

City _____

State _____

Zip _____

Home Phone _____

Work Phone _____

Email Address _____

By signing below, I agree to enroll in the Sunshine Energy® program from Florida Power & Light Company. I am 18 years or older and am authorized to make a change to this FPL account. I understand I will pay a monthly fee of \$9.75 for the environmental credits associated with cleaner generation sources of electricity like bioenergy, wind and solar.

Signature **X** _____

Date _____

Simply include this form with your monthly FPL payment, or mail separately to:
FPL Sunshine Energy Program c/o Mailhouse 2201 Stirling Rd, Ft. Lauderdale, FL 33312-9988
For more information about Sunshine Energy visit www.FPLsunshineenergy.com

FP0307



By choosing Sunshine Energy, you can:

- Avoid over 10,000 pounds of carbon dioxide (CO₂) emissions nationwide in just one year — as much as your car would produce in over 11,000 miles of driving.
- Support renewable generation from cleaner sources like bioenergy, wind and solar.
- Reduce the demand for electricity generated from traditional fuel sources.

Less Expensive Than You Might Think

Doing your part costs just a small amount. For only \$9.75 more per month, you'll support cleaner electricity generation, help reduce CO₂ emissions and support the development of new renewable sources of electricity.

Sign Up Today And Help Preserve Our Environment For The Future

Choosing Sunshine Energy makes it easy to do your part for the environment. Just return the form above with your payment or call 1-877-529-2610.

Doing Your Part for the Environment
Now Easier than Ever!



FPL
POWERING IDEAS. EMPOWERING TOGETHER.

DIVIDER

BLANK

PAGE

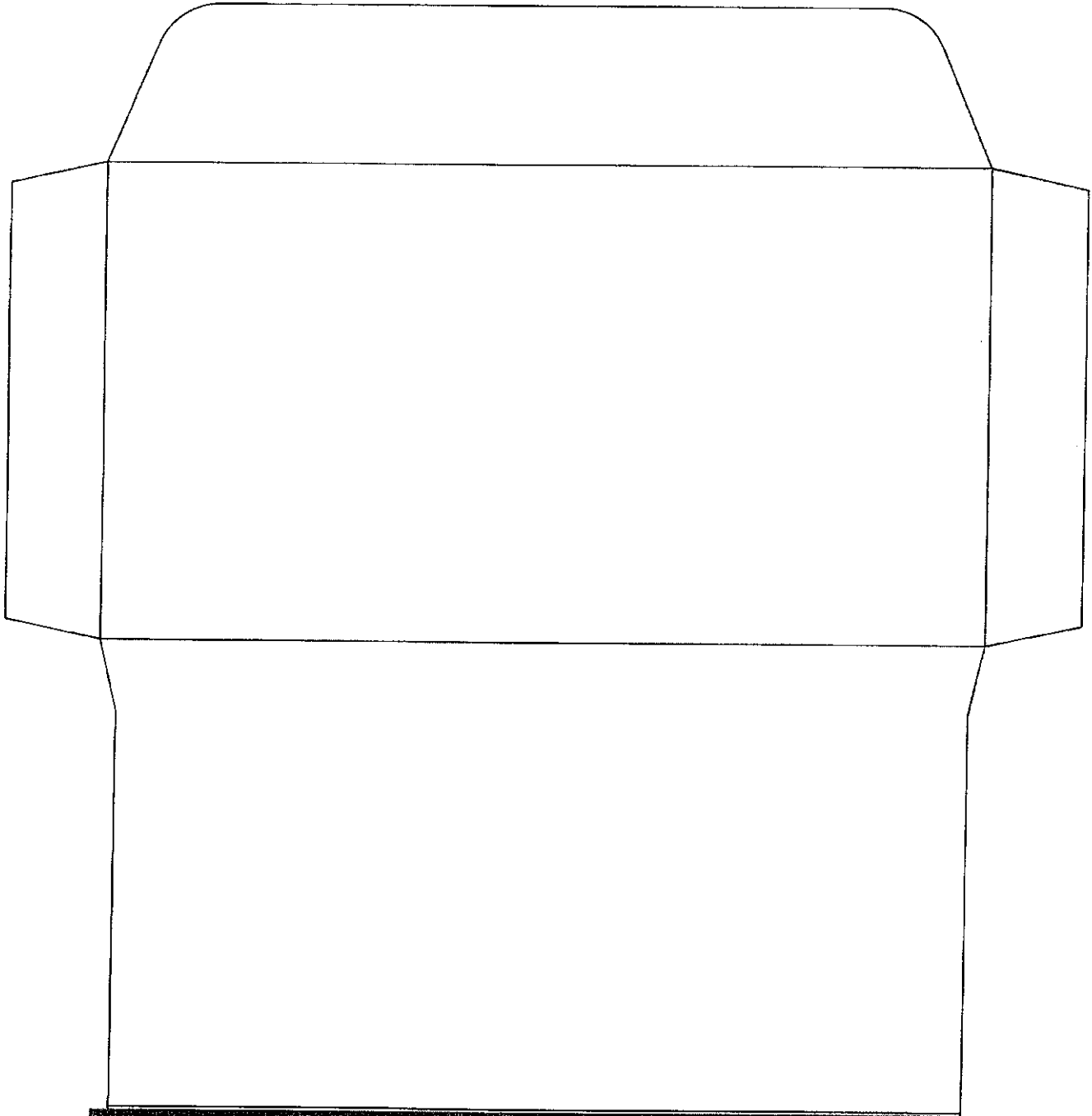

Choose sunshinenergy® Today And Help Preserve Our Environment For The Future.

Because it's sometimes difficult to find an easy way to do your part for the environment, FPL offers you the Sunshine Energy® program. Sunshine Energy supports sustainable, cleaner sources of energy that are less polluting than the traditional fuel sources most widely used to make electricity in the U.S.

For each month that you participate in the program, FPL ensures that 1,000 kWh of cleaner electricity from sources like wind, bioenergy and solar is generated and delivered to power systems serving Florida and other states nationwide. Your participation also creates important environmental benefits in the areas where this cleaner, renewable electricity is generated.

Q.

Please provide a copy of each bill insert sent regarding the Sunshine Energy Program. Please describe the promotional objective(s) associated with each bill insert provided.

A.

Attached are articles from the bill insert Energy Notes mentioning Sunshine Energy in the following months: April 2006, June, September and November 2007 and February 2008. The objective of the bill inserts was to promote awareness of the Sunshine Energy program and the many benefits of the program, and to increase participation over time to maximize enrollment, resulting in the purchase of more RECs.

FPSC

DATA

REQUEST

NO. 19

5 ATTACHMENTS



FPL

WORKING TODAY,
EMPOWERING TOMORROW

ENERGY NOTES

News Focused On Your Business

WWW.FPL.COM

FEBRUARY 2008



Focusing On Reliability Every Day

Your business values and counts on reliable and affordable electric service, and we at FPL are working hard every day to provide it. FPL is using cutting-edge technology to work smarter and deliver the reliability customers need. Here are just a few of the actions we're taking to improve service for you.

Applying Thermovision technology – We have invested in infrared inspection devices to detect potentially faulty power lines and other electrical equipment, so that we can repair or replace it before problems occur. Thermovision technology operates like an X-ray, uncovering issues that may not be visible to the eye. We inspect approximately 25% – or about 4,400 miles – of our main lines each year, preventing power interruptions on them.

Using automated feeder switches – This technology senses when a line goes dead, isolates the problem and then reroutes power to keep electricity flowing to your business. Before these switches were available, an FPL line specialist had to go to the problem location and manually reroute the power, which meant customers were without power until the specialist arrived. This newer technology minimizes the number of customers who experience the extended outage.

Preventative maintenance – FPL also continues to focus on an aggressive preventative maintenance plan that includes:

- **Hardening our system** around hospitals, ports and major highways to make it better able to withstand high winds caused by major storms.
- **Trimming trees** on more than 6,000 miles of power lines each year, ensuring they won't fall on lines and cause outages.
- **Inspecting poles** and making any necessary repairs to 500 poles every day.

If you're interested in learning about reliability improvements being made in your area, please sign up for our e-newsletter. On www.FPL.com, simply log in to your account, click on Change My Email Preferences, and select News Updates and Storm Safety. If you're not registered for online services, click on Email Preferences Create/Update from the homepage. Or, if you're enrolled in FPL E-Mail Bill® updates will be shown on your bill.

We know your business counts on FPL to provide reliable electric service. We're committed to taking actions every day to ensure that you receive the electric service you depend on. To learn more about our focus on reliability, visit www.FPL.com/reliability



Check payments, open, close, transfer or update your account and more.

www.FPL.com
customer service, just a click away.

FPL Rebate Lights The Way To Energy Savings

Lighting accounts for more than a quarter of energy consumption in most businesses. A number of newer, more efficient lighting technologies – paid for in part by an FPL incentive – can help you get better control over energy usage.

Ceramic metal halide lamps – Perfect for retailers, ceramic metal halides provide the same light output at a reduced wattage as incandescents. And they run cooler, putting less strain on your A/C system. Because ceramic metal halides last five times longer, retailers also save on labor charges related to lamp replacement. For museums and jewelry stores, ceramic metal halides give the same sparkle to display cases but are an efficient alternative to MR16 lamps.

Pulse start metal halide lamps – Perfect for big box retailers, gymnasiums, stadiums and parking lots, pulse start lamps save wattage (and energy) and produce the same light quality. In addition, light output degrades slower over time as compared to the standard metal halide lamps that are most commonly used.

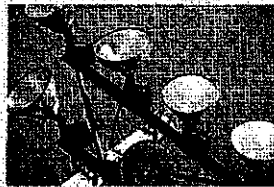

Programmed start electronic ballasts – Occupancy sensors and dimming ballasts reduce energy usage when feasible. However, intermittent usage of lights with standard ballasts can cut short the life of fluorescent lamps. Programmed start electronic ballasts help prolong lamp life.

When you upgrade to more efficient lighting, FPL pays \$1.50 to \$4 for ceramic metal halide lamps and \$3 to \$4 a lamp for pulse start metal halides. And it's another way your business can help the environment. Every kilowatt-hour you save reduces power plant emissions and contributes to a cleaner planet.

To learn more about our lighting and other energy-saving programs, call 1-800-FPL-5566 or visit www.FPL.com/business.

Managing Your Company

Want an easier and more convenient way to pay your company's electric bill? That's what you get when you enroll in both the FPL Budget Billing® and FPL Automatic Bill Pay® programs.



Business Works: A Case Study Of Success

Here's an example of how one FPL customer took advantage of a free way to control energy use and offset a portion of its carbon footprint.

Business: The Benjamin School

The trade-off: Through the Business On Call® program, the school receives monthly credits (April through October) for allowing FPL to cycle its A/C service for brief periods during peak demand on FPL's system. The school applies the credits to purchase blocks of Sunshine Energy®, which supports cleaner electric generation nationwide.

My's Electric Bill Is Easier Than Ever

With FPL Budget Billing, you'll never have to worry about a higher-than-expected electric bill again. Plus, Budget Billing will bring stability to your bill and your company's cash flow. While Budget Billing is not a savings program, it's a great way to manage your company's electric bill amount month to month. When you enroll, you:

- Pay a stabilized bill amount each month year-round.
- Avoid major fluctuations in your bills due to weather, seasonal peaks and valleys, or changes to technology and equipment.
- Know what to expect to pay each month, which makes it easier to manage your company's expenses.

With FPL Automatic Bill Pay, you'll spend less time thinking about your bill and more time focusing on your customers. That's because your electric bill is paid automatically on time, every month. All you do is pre-authorize automatic transfer of payment from your bank

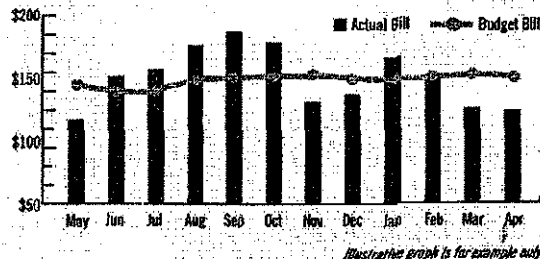

account to FPL each month when your bill is due. With FPL Automatic Bill Pay, you:

- Avoid late or missed payments.
- Know the exact date the payment will be withdrawn from your bank account.
- Still receive a monthly statement for review and record keeping.

And when you enroll in both programs, you enjoy the added feature of knowing in advance the approximate amount to be withdrawn from your bank account on the date you select*. Both programs are free, so why not enroll your business today at www.FPL.com/business/bill

*You set up the payment withdrawal date to be between 11-20 days after your electric bill is issued.

"When we considered all of our students being driven to school, we realized we can't ignore our carbon footprint. Our school has accepted the responsibility of making our students environmentally aware because they are and will continue to be citizens of this planet. With FPL as a partner, we've learned a lot about energy conservation and environmental stewardship."

— Jim Young, Interim Head, The Benjamin School

Annual savings from On Call: \$6,244

Blocks of Sunshine Energy purchased annually: 53 blocks each month at a charge of \$9.75 per block. One block equals 1,000 kilowatt-hours of 100% Green-e® certified renewable energy.

Carbon reduction: 450 tons of carbon dioxide emissions

With FPL's help, it's easy for your company to participate in clean and green initiatives. To learn more, call 1-888-FPL-GREEN (1-888-375-4733) or visit www.FPL.com/sunshinebusiness

sunshinenergy®

Help For Restaurants To Manage Energy Costs

Air conditioning and refrigeration account for more than half of a small- to medium-size restaurant's electricity usage. FPL offers tips to help you control energy usage:

Turn Things Off Or Down

- Install occupancy sensors and/or controllers in walk-in coolers and other storage areas to automatically turn lights off or down.
- Assign responsibility between shifts or at day's end for turning off equipment and lights.
- Set thermostat controls at minimum levels during operating hours and adjust temperature settings on your A/C before closing nightly.
- Keep your refrigeration units set at the proper temperature -- but no cooler than necessary. Also ensure doors are properly sealed.

Air Conditioning Maintenance

- Change filters monthly, and schedule maintenance at least twice a year to check the evaporator coils, economizer, thermostat and airflow.
- Check condenser coils quarterly to clear trash and other natural debris.
- Balance and clean your hood range to keep the input and output air in balance.
- Seal leaky ducts that waste energy.



Long-Term Solutions

- Switch to dimmable compact fluorescents and T-8s with electronic ballasts to save energy and maintenance costs.
- Install anti-sweat heater controls, hot gas reclaim or special glass doors on refrigerator and freezer cases to save 50% or more of the energy used by anti-sweat heaters. FPL's incentive will help you pay for the technology.
- Install more efficient cooking equipment, coolers and dishwashers to save 15-30% on your annual energy bills.
- Although commercial kitchens with automatic dishwashers must follow the health codes of 180°F (verify the code in your area), you may be able to benefit from chemical rinse equipment that permits a reduction to 125°.
- Reduce your idle cooking time and save money. FPL's Kitchen Demand Control Ventilation program helps save energy and money by increasing ventilation hood efficiencies and FPL may help pay for it.

For additional energy-saving tips, visit www.FPL.com/business.

Time-Of-Use Peak Hours Change in April

If your business is on FPL's Time-of-Use (TOU) rate, please remember that FPL's on-peak hours change on April 1. From April 1 to Oct. 31, on-peak hours are Monday through Friday noon to 9 p.m., excluding Memorial Day, Independence Day and Labor Day. To learn more about TOU or FPL's other rates, call our Business Care Center at 1-800-FPL-5566.



DIVIDER

BLANK

PAGE



FPL
POWER TO YOUR
PARTNERING TO SAVE ENERGY

ENERGY NOTES

News Focused On Your Business

WWW.FPL.COM

NOVEMBER 2007

A Clean Energy Future: We're All In It Together

We know that FPL customers value reliable and affordable power and that you also want us to manage our operations with sensitivity to Florida's precious environment

FPL has implemented clean energy programs for many years. Our rates of key power plant emissions are among the lowest in our industry, and that means cleaner air for Floridians.

Planning more solar power and making it easier to save energy

In September, we announced a major investment program that will provide important customer benefits and reduce carbon dioxide emissions that contribute to global warming. Our plan for the future includes:

- Building 300 megawatts of solar generating capacity in Florida using solar thermal technology. This new facility will supply enough renewable energy to power around 100,000 Florida homes while avoiding nearly 11 million tons of CO₂ emissions over a 20-year period.
- Installing a "smart" network over six years will allow FPL residential customers to view their energy consumption online whenever

they want. Real-time understanding of energy use means real-time opportunities to conserve. "Smart" meters can offer customers the chance to cut power bills and lower electricity demand, and do a little more to help the environment.

At the same time we at FPL are addressing climate change and clean energy in these and other ways, many customers are also asking: "What can WE do?"

Connecting our customers to more energy efficiency options

We want to help you take an active role in energy efficiency by connecting you to a wide range of energy-saving options. Our business programs include air conditioning and lighting rebates and more. Start today by asking for a free Business Energy Evaluation that will give you a customized, convenient and expert analysis of your business' energy use and ways you can save. Simply visit www.FPL.com for more information.

At FPL, we believe that all of us can contribute to maintaining and improving our environment. Let's work together!

Happy Thanksgiving from all of us at FPL



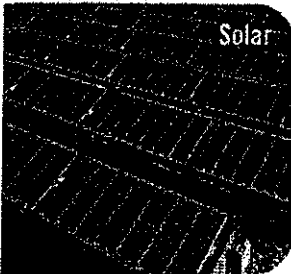
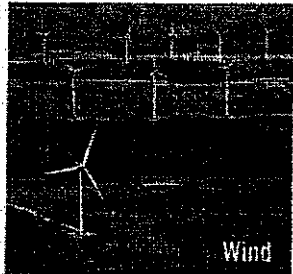
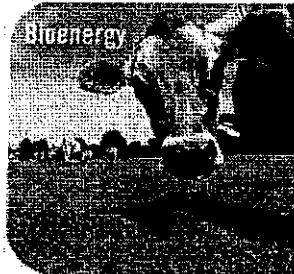

sunshinenergy®

Offset All Or Part Of Your Carbon Footprint

Your business can make a personal and positive impact on our energy future by purchasing 1,000 kilowatt-hours (kWh) of 100% Green-e® certified renewable energy. In fact, you can buy enough blocks of Sunshine Energy® to offset some or all of your carbon footprint. Once you enroll, the monthly charge of \$9.75 per block is conveniently added to your company's electric bill.

FPL's Business Sunshine Energy program offers you the opportunity to demonstrate your organization's commitment and support of energy diversity, independence and sustainability, as well as environmental stewardship by supporting clean, renewable electric generation.

And you can combine the benefits from other FPL programs to offset the cost of purchasing multiple blocks of Sunshine Energy. The Benjamin School in Palm Beach Gardens is the first FPL customer to reinvest savings on its energy bills this way.

The Benjamin School is using its savings from participating in FPL's Business On Call® program to purchase enough blocks of Sunshine Energy to offset a portion of its carbon footprint. Through On Call, The Benjamin School will save \$6,244 annually, which it has dedicated to Sunshine Energy participation.

"The Benjamin School is proud to be the first Florida business to participate in both the FPL On Call and Sunshine Energy programs. The gains we realized through the On Call program enable us to invest in the Sunshine Energy program and provide a valuable lesson in stewardship for our students. We are committed to environmental policies that promote renewable sources of energy and programs that promote sustainability throughout the state," said Jim Young, interim head, The Benjamin School.

Each block of 1,000 kWh of 100% Green-e certified renewable energy you purchase through Sunshine Energy plays an important role in:

- Preventing CO₂ emissions nationwide. (Purchasing one block every month each year prevents 17,000 pounds of CO₂ emissions nationwide.)
- Supporting renewable sources of energy, such as bioenergy and wind, across the country.
- Conserving non-renewable fossil fuels, such as oil, coal and natural gas.

To enroll in the Sunshine Energy program, visit www.FPL.com/sunshinebusiness or call 1-888-375-4733. For information about our energy conservation programs to help make Sunshine Energy participation more affordable, visit www.FPL.com.

CFLs Save Energy And Help The Environment

Compact fluorescent lamps (CFLs) are becoming more popular among consumers and businesses, but the fact that they contain mercury is raising concerns about improper disposal.

However, there is a net environmental benefit to CFLs. ENERGY STAR® qualified CFLs use up to 75% less energy while providing the same light output as incandescents, and they last up to 10 times longer.

Like all fluorescent lamps, CFLs contain some mercury, which is a hazardous substance. A typical CFL contains only about 5 milligrams (mg) of mercury, in contrast to the 25 mg found in a watch battery.

FPL and the U.S. Environmental Protection Agency (EPA) recommend that you recycle used CFLs to eliminate any risk associated with the small amount of mercury they contain. Florida

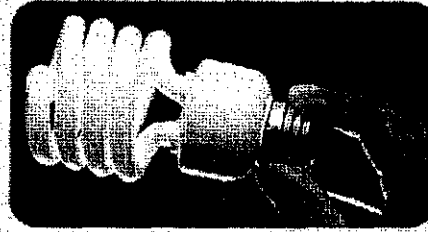

has hazardous waste programs that accept fluorescent bulbs in nearly every county. To find a recycling or disposal site near you, visit www.earth911.org or call 1-800-CLEANUP (1-800-253-2687) to use your zip code to learn about recycling options in your area.

For additional tips or to purchase CFLs and other energy efficient products, visit our Online Energy Store at www.FPL.com/store. All sales help fund programs for your neighbors in need.

Products earn the ENERGY STAR by meeting strict energy efficiency guidelines set up by the U.S. Environmental Protection Agency and the U.S. Department of Energy.

Help Save Trees With FPL E-Mail Bill®

Helping to save the environment is as easy as having an e-mail address. That's because the FPL E-Mail Bill® program allows your business to receive and review bills quickly and easily via e-mail. You'll help save trees while still getting the same bill detail you now get by mail. In fact, if we all received and paid all of our bills electronically, we'd save more than 13 million trees every year!



FPL E-Mail Bill offers other benefits, as well:

- Secure access to your company's account information 24 / 7.
- Fast access to your payment history and tracking. You can view and print up to six months of electronic bill statements and up to 24 months of historical bill amounts.
- E-mail notification of when payment is due.
- Option to pay your company's bill online. For added convenience and security, combine the FPL E-Mail Bill program with the FPL Automatic Bill Pay® or Pay Online programs.

We all have a stake in a cleaner tomorrow. Your business can help do its part by enrolling in the FPL E-Mail Bill program. To participate, go to www.FPL.com/ebillbiz. Remember to have your FPL account information handy.

Help For Food Stores To Take Control Over Energy Costs

Refrigeration, air conditioning and lighting typically account for about 85% of electricity usage in a small food store. Here are tips that will help you manage these costs:

Turn things off or down

- Turn off computers, cash registers, deli scales and cooking equipment when not in use. Smart power strips with built-in occupancy sensors are available to shut off these devices when no users are present.
- Lights should be off when not in use. Occupancy sensors can help, but training staff to flip the switch when lights aren't needed is less expensive.
- Make sure that cooling and heating settings in warehouses, stockrooms, offices and other special-use rooms are at minimum settings.

A/C cleaning and maintenance

- Have a licensed technician calibrate the controls, check, clean and lubricate the outside air damper linkage once a year.
- Change filters at least once a month, and clean condenser coils quarterly.



- Check cabinet panels quarterly to make sure panels are fully attached, with all screws in place, and that gaskets are intact.

Longer-term solutions

- Install anti-sweat heater controls, hot gas reclaim or special glass doors on refrigerator cases to reduce condensation and save energy. FPL offers incentives to help you pay for these technologies.
- With the help of an FPL rebate, replace T-12 fluorescent lamp fixtures with T-8s and electronic ballasts. If you have high ceilings, T-5s offer even better light quality.
- When your roof needs recoating or painting, consider a reflective roof measure – which an FPL incentive may help you pay to install.

For additional energy-saving tips, visit www.FPL.com/business.

Time-Of-Use Peak Hours Change in November

If your business is on the Time-of-Use (TOU) rate, please remember that FPL's on-peak hours change on Nov. 1. From Nov. 1 to March 31, on-peak hours are Monday through Friday from 6 a.m. to 10 a.m. and 6 p.m. to 10 p.m. Thanksgiving Day, Christmas Day and New Year's Day are excluded. To learn more about our less expensive TOU rate or FPL's other rate options, call our Business Care Center at 1-800-FPL-5566.



Florida Power & Light Company, FPL Properties
100 N. E. 1st Street, Fort Lauderdale, FL 33301

© 2008 Florida Power & Light Company. All rights reserved. FPL is a registered trademark of Florida Power & Light Company.



DIVIDER

BLANK

PAGE



FPL

www.FPL.com

Energy News

For Customers Of Florida Power & Light Company

APRIL 2006



Enhanced Line-Clearing Efforts A Key Element Of FPL's Storm Secure Plan Planting The Right Tree In The Right Place Will Help

Periodically this year, your Energy News will feature articles reviewing aspects of FPL's Storm Secure Plan, the five-point program we announced in January that's designed to strengthen our electrical system. This article is the first in the series.

Nobody can reduce the number of powerful hurricanes that hit Florida. But we can do everything in our power to reduce the damage those hurricanes inflict on FPL's electrical grid.

At FPL, our responsibility is to make the system as "storm secure" as possible before a hurricane hits and to restore outages quickly. We're committed to making improvements every day.

As many of you know, for years an important ingredient in our approach to maintaining electric reliability has included regular line clearing, more commonly known as tree trimming. This has always been based on consistent, planned clearing cycles

that may vary depending on tree species and growth rates. Our main lines, for example, are addressed every three years on average.

But since weather patterns in Florida are changing, we are, too. A major component of our Storm Secure Plan, for example, is to accelerate our annual line-clearing activity as follows:

- We're committed to completing 75% of each year's line-clearing plan along main or "feeder" lines before the peak hurricane season begins on Aug. 1.
- Further, by the start of hurricane season on June 1, we pledge to complete line clearing for circuits that serve top critical infrastructure facilities in each community. We're clearing power lines serving facilities your communities have identified as essential for public health and safety, such as police and fire departments, hospitals and the like.

Continued on page 3

The easy way
to update
your account



FPL.com
Customer Service
just a click away

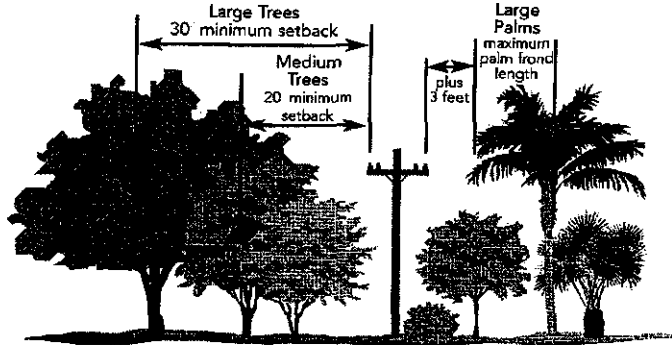

Trees shown at mature height

Planting The Right Tree In The Right Place Helps Prevent Power Outages

Trees and power lines don't mix. If not planted in the right place, today's tree could be tomorrow's backyard problem. They may seem small now, but when immature trees grow to mature heights, they can interfere with power lines, which can disrupt electric service to you and your neighbors.

- Taking the time to choose the right tree and planting it in the right place will help improve the reliability of your electric service.
- Know the type of tree and where it will be located in relation to overhead and underground utility lines. The mature tree must have an appropriate setback away from power lines and an area large enough to accommodate the root system, canopy and trunk diameter.

- Call before you dig to avoid buried wires. To locate underground wires, contact Sunshine State One Call (1-800-432-4770) at least two business days prior to work beginning. The service is free.

FPL has identified trees you can safely plant in your area of the state. For a list of suggested trees suitable for planting adjacent to overhead power lines and those to avoid, visit www.FPL.com. You'll also find contractors in your area trained to safely trim trees around power lines. Or, call our customer care center at the phone number on your electric bill and ask for our Right Tree, Right Place flyer.

Planting the right tree in the right place will help keep you safe and help us improve the reliability of your service.

Join Us This Earth Day In Our Commitment To The Environment

In January 2006, FPL was notified that once again we were ranked first out of 23 major electric utilities surveyed in the environmental and social responsibility assessment conducted by Innovest, an internationally recognized independent advisory group. This is the fourth time in a row that Innovest has ranked FPL first for environmental performance.

EARTH DAY
April 22, 2006

This Earth Day (April 22), please join us in our commitment to the environment by conserving energy. Energy conservation is earth-friendly and is a great way to manage your electric bills. For tips and advice to help you control your energy usage, visit the residential section of www.FPL.com.

Line Clearing: Key Element Of FPL's Storm Secure Plan

Continued from page 1

In addition, our Right Tree, Right Place program will educate you about which trees should be planted or removed in Florida, so that we may enjoy beautiful communities while we safely balance our natural environment with our need for a reliable electric system.

We'll also work with municipalities and the state legislature to enact sensible, practical vegetation management practices.

Work Is Under Way To Make Our System Storm Secure

Right now our crews are out in force making final repairs to 2005 storm damage, inspecting poles and clearing the power lines of trees that might drag them down in a storm.

As FPL works to strengthen the electrical grid, our accelerated

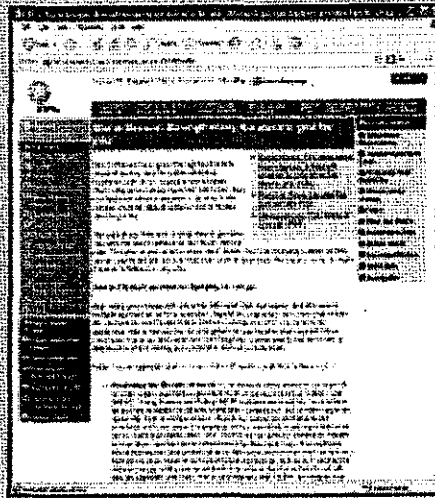

line-clearing program will help us minimize tree- or debris-related power outages across our system, including hurricane-related outages. We're making FPL's electrical grid Storm Secure.

You can check on our progress and get details about FPL's Storm Secure Plan online at www.FPL.com/StormSecure. You may also download our detailed Right Tree, Right Place flyers from that same site.

If You Or Someone You Know Need Special Assistance...

Medical Essential Service – This FPL program is specifically for you if you or another permanent resident of your home is dependent upon electric-powered equipment that must be operated continuously, or as circumstances require as specified by your physician, to avoid the loss of life or immediate hospitalization. Certification for this program requires a form, available from FPL upon request, to be completed by the customer and his/her physician. Annual re-certification by your physician is also necessary.

If you qualify, the Medical Essential Service program offers referrals to social service agencies that may provide

financial assistance, a limited extension of time to pay your bills and special notification prior to disconnection of service for non-payment, so you can secure funds or make necessary arrangements.

Evacuation Assistance – If you have special needs in case of an evacuation, call your local emergency management office. Your county government has a voluntary registration program for this purpose. Look under "county government" in your phone directory or call directory assistance. We encourage you to develop an emergency plan and call now before extreme weather or some other emergency threatens!

BuildSmart® And Save Money Year After Year

A new home is a big investment. The choices you make will affect your family – and your budget – for years to come. FPL's BuildSmart® program is one way to ensure value and comfort for as long as you own your new home.

A home with BuildSmart certification includes proven energy-saving upgrades above the standard Florida building code minimum requirements – upgrades that can save you hundreds of dollars a year in energy costs. BuildSmart benefits include:

Energy Savings – A BuildSmart home can reduce your family's energy usage by up to 30%.

Comfort – BuildSmart energy-saving features – such as energy-efficient cooling and heating, upgraded insulation and sealed air conditioning ducts – help make your home more comfortable.

Peace of Mind – Participating builders must comply with FPL's exacting inspections, so you can be sure your BuildSmart home meets a higher standard.

Satisfaction – As a BuildSmart homeowner, you'll know you're doing your part to help reduce energy consumption and conserve our natural resources for the future.

Added Value – After you move into your new BuildSmart home, you will receive a certification kit with valuable energy-saving tips – to save you even more money in the future.

If you're thinking about new construction, be sure to ask your builder about BuildSmart certification to ensure your new home is comfortable and energy-efficient! For more information about the FPL BuildSmart program, visit www.FPL.com.

FPL Helping Outlet

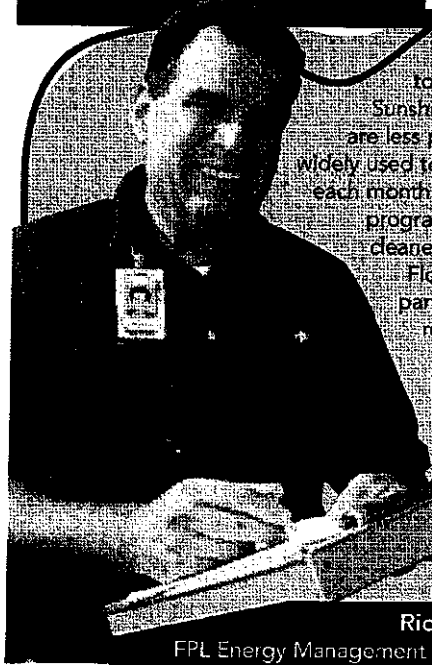

Rick Powery
FPL Energy Management Consultant

"Choosing Sunshine Energy® is an easy way to help preserve our environment for the future. Sunshine Energy uses cleaner sources of energy that are less polluting than the traditional fuel sources most widely used to generate electricity in the United States. For each month that one of our customers participates in the program, FPL ensures that 1,000 kilowatt-hours of cleaner electricity is produced by generators in Florida and other states nationwide. Your participation also creates important environmental benefits in the areas where this cleaner, renewable electricity is generated. By purchasing Sunshine Energy, your participation helps avoid more than 8,000 pounds of carbon dioxide (CO₂) emissions – as much as a car would produce in almost 9,000 miles of driving! To enroll or learn more, visit www.FPL.com/sunshine or call 1-877-529-2610."



FPL Energy News
Florida Power & Light Company
P.O. Box 14000
Juno Beach, FL 33408



DIVIDER

BLANK

PAGE



FPL

Energy News

For Customers Of Florida Power & Light Company

www.FPL.com

JUNE 2007



What You Can Do This Summer To Help Manage Your Electricity Use

It's summertime again in Florida, which unfortunately means you can start to expect higher seasonal electric bills. Did you know air conditioning accounts for more than half of most summer bills? As it gets hotter for longer periods each day, your air conditioner runs more and more, consuming more electricity and increasing your bill. Your usage may also increase if you have house guests or children home for the summer.

FPL offers practical tips and programs that can help you get more control over your electricity usage. They're hassle-free ways to save energy and money without sacrificing your comfort. Individually, these steps may not yield big savings, but they will make your home more efficient and keep summer electric bills more manageable.

To get started:

- Cool your home at 78° or warmer with the thermostat fan switch on "auto." For additional savings, raise the thermostat to 82° or warmer when you're away from home.
- Even better, install a programmable thermostat to adjust the temperature automatically.
- Have your A/C system checked if you feel it's not cooling as well as it has in the past.
- Clean or replace your A/C system filter every month.
- Turn off the ceiling fan when you leave the room. A fan that runs constantly can cost up to \$7 a month depending on size and age.

Continued on page 2

If You See A Downed Power Line

Call 1-800-410-7464 (1-800-463-8273) immediately!



Manage Your Electricity Use

Continued from page 1.

- Limit the time your pool pump runs to six hours a day.

And here are three FPL programs that can help:

FPL On Call® Program – This free program is one of the easiest ways to save more than \$100 a year. By going "On Call," you agree to allow FPL to cycle off select major appliances for short periods of time. This occurs only when absolutely necessary to help us conserve energy during times of very heavy usage. In exchange, we will credit your electric bill every month – even if we never activate the program. To learn more, visit www.FPL.com/oncall.

Online Home Energy Survey – Saving money on your electric bill is easy when you know how much energy your home is using and where you can reduce usage and trim costs. Just take our Online Home Energy

Survey today and get customized tips to make your home more energy efficient. To take our free survey, click on www.FPL.com/ohes.

FPL Budget Billing® Program – While this program does not save you money, it is a great way to manage your bill month to month. FPL Budget Billing evens out your annual energy costs over the year so you pay approximately the same amount each month. There may be months when your FPL Budget Bill is higher or lower than your actual energy costs, but ultimately it averages out to be about the same. To learn more about this free program or to enroll online, visit www.FPL.com/resbb.

For additional energy-saving tips, visit www.FPL.com/summertoolkit. While you may not see drastic reductions in your bills, every little bit counts.

FPL's Assist Program Helps Those In Need



Hardships such as loss of a job, illness or an accident can strike at any time and make it difficult or impossible to pay bills. Through FPL's ASSIST Program, we partner with a vast network of social service organizations located throughout our service territory to help in these situations.

In 2006, FPL partnered with more than 700 low-income/elderly service organizations to help more than 60,000 eligible customers receive more than \$18.3 million in funding to help pay their electric bills.

If you feel you qualify for energy assistance, call the customer service number located on the bottom of your FPL bill or visit www.FPL.com/assist. We'll provide you with the information and referral phone number to the appropriate local social service organization.

Such organizations could require you to undergo a qualification review to be considered for assistance funds. Typically, you must have an income that falls at or below 150% of federal poverty guidelines, but requirements may vary based on the locale and the funding source.

For more information, please visit www.FPL.com/assist.

An Easy Way To Stay In The Know

The Email Preferences button on www.FPL.com makes it easier for you to tell us what kind of information you want to receive from us via email.

You can choose monthly information on:

- How to be energy efficient
- Billing and payment programs
- Storm and safety preparedness
- News updates
- Special offers on programs and services
- Communications in Spanish

With this button you also can unsubscribe or manage your email preferences differently.

With summer and hurricane season here again, we encourage you to take advantage of free email communication from FPL. You'll receive monthly tips on ways to control your energy usage and make your home more energy efficient, as well as helpful information on staying safe during a storm.



To create an email profile or manage your preferences, go to www.FPL.com and click on Email Preferences Create/Update. If you're not registered for online services, you'll need to do that first. Please have your FPL account number and U.S. Social Security, Canadian Social Insurance or tax ID number on hand.

New Charge Part Of Ongoing Storm Planning Replaces Surcharge, Reduces Your Bill

You may have noticed a new line item on your electric bill. The Storm Charge became effective on May 23, 2007. It replaces the Storm Restoration Surcharge, which was previously included in the Non-fuel Energy Charge section of your bill.

The new Storm Charge means a \$0.08 cents per month reduction on a 1,000 kilowatt-hour (kWh) residential bill. This new charge originated in the Florida Legislature, which established a new financing method by which electric utilities can recover storm restoration costs and replenish storm-recovery reserves. This procedure, known as "securitization," allows electric utilities to access low-cost funds through "storm-recovery bonds" issued with oversight from the Florida Public Service Commission. In FPL's case, proceeds from the storm-recovery bonds will pay for the remaining 2004 and 2005 storm costs and



establish a reserve for future storms. A note with additional details is included on your electric bill. Like other matters impacting your bill, we want you to be fully informed of this change, which has reduced residential bills and is a part of our ongoing hurricane preparedness activities on behalf of our 4.4 million Florida customers.

Energy Theft Is A Crime — Please Report It



You use electricity honestly and pay your bill every month. Why should anyone who tampers with electric meters and steals electricity get away with it? Just as important, meter tampering also causes potentially life-threatening hazards for customers and FPL employees. To protect our honest, good-paying customers, we'd appreciate your assistance.

A slow-moving or stopped meter may indicate possible theft. If you suspect someone of stealing electricity or tampering with electric meters, report it to us in confidence by calling our tips hotline at 1-800-528-6621, press 1 for English or 2 for Spanish and then option 1 to report suspected theft. Under Florida law, electricity theft is a crime punishable by fine and/or prison time.

FPL Helping Outlet

"Today, perhaps more than ever, America is looking for ways to help secure its energy independence. When you enroll in FPL's Sunshine Energy® program, you can have a personal and positive impact on our energy future. For each month you're enrolled in the program, FPL ensures that 1,000 kilowatt-hours of electricity from cleaner sources is produced by generators in Florida and other states. Thanks to more than 30,000 customers already enrolled in Sunshine Energy, solar arrays at the Miami Science Museum and four SunSmart schools have been developed. These solar facilities are becoming a reality because of Sunshine Energy customers who choose to make a difference. Since the start of the program, Sunshine Energy customers have prevented more than 420 million pounds of carbon dioxide (CO₂) emissions from entering the air annually. That's the same as removing more than 47,000 cars off the road or planting more than 25 million trees! If you, too, would like to join this worthwhile effort, visit www.FPL.com/sunshine or call 1-888-375-4733."

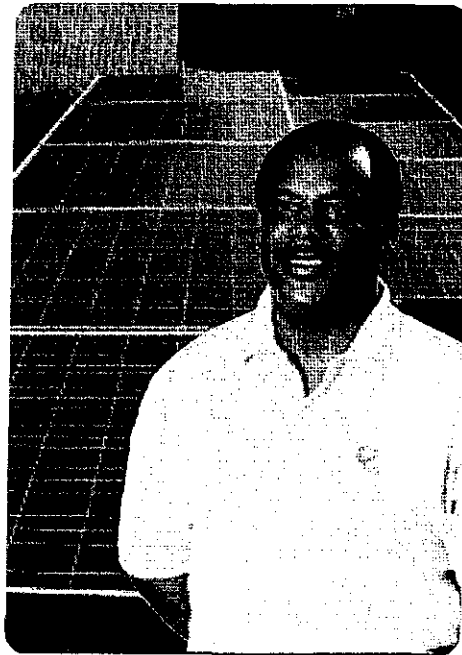

Stan Thornton
FPL Customer Manager



FPL Energy News
Florida Power & Light Company
P.O. Box 14000
Juno Beach, FL 33408

06/07



DIVIDER

BLANK

PAGE



FPL

ENERGY NEWS

For Customers Of Florida Power & Light Company

www.FPL.com

SEPTEMBER 2007



Join More Than 300,000 FPL Budget Billing® Customers Who Enjoy More Predictable Bills

There's an easy way to manage your electric bill without sacrificing the conveniences of everyday life. Simply join the more than 300,000 customers who already benefit year-round from the FPL Budget Billing program. While Budget Billing does not save money, it gives you the comfort of knowing what to expect to pay each month.

When you enroll, you:

- Pay a stabilized bill amount each month and year-round,
- Avoid major fluctuations in your bills, especially during peak energy usage during the summer months, and
- Know what to expect to pay each month, which makes it easier to manage your monthly expenses.

When you enroll in Budget Billing, your monthly bill statement will show you three amounts:

- 1) "Actual Bill" amount,
- 2) "Budget Billing" amount – which is the amount you will pay, and
- 3) "Deferred Balance" amount. The deferred balance amount is the difference between your actual energy costs and your monthly Budget Billing amount.

The deferred balance is what stabilizes the amount you pay year-round and makes your electric bills more predictable. Because the deferred balance adjusts every month, the payment due never gets too large, and makes budgeting easier.

To learn more about the program and how a Budget Bill is calculated, visit www.FPL.com/resbb and enroll today!

Fast + Safe + Easy = FPL Pay Online

Pay your bill online whenever or wherever you choose at www.FPL.com/payment



Ways To Manage Your Summer Bills

Historically, August and September are the hottest months of the summer, which is the single biggest reason your electric bills are higher this time of year. But there are other factors as well. Understanding the causes of bill fluctuations can help you better manage your energy consumption. Add some of our simple and practical solutions to this knowledge, and it can help make a difference in your monthly bills.

Common Causes Of Higher Bills

Weather – Weather is the primary cause of high bills. In hotter weather, cooling can account for more than half of your bill. That's because your air conditioner has to work longer to keep your home's temperature at the thermostat setting.

Fuel costs – FPL needs natural gas and oil to generate electricity. The cost of this fuel makes up more than half of the price you pay for electricity. To better understand the impact, click on our Fuel Comparison Calculator at www.FPL.com/fuelcal

Electronics – Did you know larger TVs, like plasma and HD TVs, use more electricity than your refrigerator? And, they produce heat, which makes your air conditioner run longer. If you have a digital video recorder (DVR) connected to your TV, it's running 24 hours a day. Many electronics use almost as much electricity when they are off as when they are on.

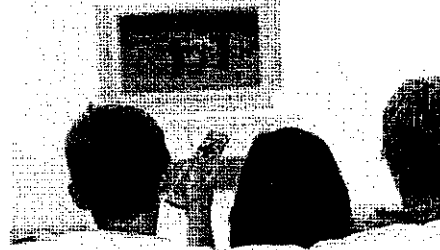

Household – The number of house guests and family members in your home impacts your electricity consumption.

Length of billing cycle – A billing cycle is the number of days in each bill. Some months are longer than others, which could lead to a higher bill because of energy use on additional days.

Hassle-Free Ways To Help Manage Your Usage – And Your Bill

- For the most savings, implement our top 10 tips at www.FPL.com/energyefficiency.
- Plug electronics into a device with an on/off switch or turn them off when not in use. Electronics that are turned off but plugged in still consume electricity.
- Use our Appliance Calculator at www.FPL.com/appliances to learn how adding a new appliance will affect your bill or how turning certain appliances off can control energy usage.

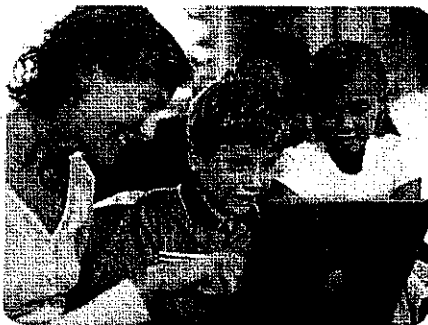

To learn more about the cause of higher bills and hassle-free steps you can take without sacrificing comfort, visit www.FPL.com/savingstoolkit. Becoming more energy efficient is something we can all share.

Why Isn't My Bill Lower After Vacation?

Even though you were on vacation, several factors could play into your usage. For instance, your air conditioner, pool pump, refrigerator and plugged-in electronics (although turned off) were still operating and consuming electricity. Your lights were off. But when you returned, you probably did more laundry than usual, which uses more electricity than lights.

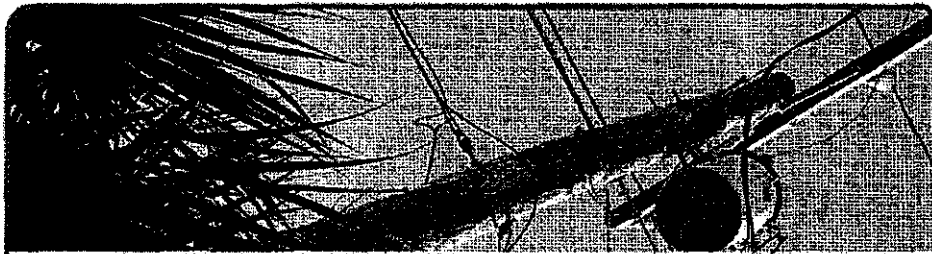

Be Aware Of Power Lines Before Trimming Trees

You look before crossing the street. You look before pulling into traffic. For your safety, be sure to look up for power lines and steer clear when you're trimming trees.

Typically, you don't have to worry about coming into contact with power lines since they're mounted on poles at safe distances away from normal activities or are buried underground. However, if you decide to trim the trees in your yard, be sure it's safe *before* you begin.

Assume all overhead wires and cables are energized and potentially dangerous. If you're setting up ladders or scaffolds, be sure you're far enough away so that you don't come near power lines, even with the tools you're using.

NEVER attempt to trim any vegetation growing near or on overhead power lines yourself. Only specially trained tree trimming professionals should do this

type of cutting. For a sample listing of these qualified tree trimmers in your area, visit www.FPL.com/trees. If you have additional questions or concerns, call the customer service number on the bottom of your bill.

FPL also urges you to be careful when it comes to underground power lines. Before you do any work that involves digging, contact Sunshine State One Call to determine if any utility lines are buried on your property. This free service will help ensure your path is clear. Before you dig, call 811, 1-800-432-4770 or visit www.callsunshine.com. Florida law requires that you call and wait the required time (two full business days) for buried utilities to be located and marked before you start digging.

Following these safety rules could save your life!

Need Help With A Power Problem? Get It Fast 24/7

When you're busy and it's hard to find time to call us, you can still get the help you need. Now it's easier for you to report and get answers about your power-related concerns at any time of day. Go to www.FPL.com/reporttrouble. Once online, you can select the type of trouble and log on to report it. These are the options you can report:

- Power outage,
- Street light outage,
- Power pole, that appears deteriorated or is leaning,
- Power quality issue, such as lights flickering or suddenly dimming,
- Electrical interference with your TV, phone or computer,
- Problem with your electric meter,
- Need for debris removal as a result of our work. or

- Desire to convert your residential service from overhead to underground service.

If we have any new information regarding your inquiry, we'll also communicate with you via www.FPL.com. Just come back to www.FPL.com and log on to check your message inbox for updates on:

- If we've been unable to reach you regarding your service inquiry,
- When your service request was completed, or
- Where we're doing preventative maintenance work in your area to help ensure reliable electric service.

Enjoy accessibility to your account information 24/7. If you're already registered for www.FPL.com online services, simply log on with your user ID and password. If you haven't registered as a www.FPL.com user, simply click on New User to register. You'll need to have your FPL account number and Social Security or tax ID number handy.

Florida's First Large-Scale Solar Array Will Be Completed And Operational Soon In Sarasota

The forecast is "sunny" in Sarasota as construction on FPL's Sunshine Energy® Solar Array at Rothenbach Park is expected to wrap up this fall. The 250-kilowatt (kw) solar installation – the largest in Florida – will provide enough electricity for 55 average-size homes. And this exciting step forward in bringing more renewable energy to Florida is possible because of our Sunshine Energy customers.

With Sunshine Energy, you can make a personal and positive impact on our energy future. For every 10,000 customers who enroll, an additional 150 kw of solar projects will be built in Florida. In addition, for each month that you participate in the program, 1,000 kilowatt-hours of cleaner electricity from sources like wind, bioenergy and solar are generated and delivered to Florida and other states.

Choosing Sunshine Energy is one of the most important things you can do to reduce air pollution. In just one year as a Sunshine Energy customer, you can avoid more than 10,800 pounds of carbon dioxide (CO₂) emissions – the equivalent of a car driving almost 12,000 miles, or recycling 26,625 aluminum cans.

Join the thousands of Sunshine Energy customers who have helped avoid more than 226,000 metric tons of CO₂ emissions. That's the same as removing more than 44,000 cars from the road, or planting more than 30 million trees!

For only \$9.75 a month, you can support the development of new renewable sources of energy in Florida. To enroll, visit www.FPL.com/sunshine or call 1-877-529-2610.

FPL Helping Outlet



Mayling Bravo
Field Operations Supervisor

"You can save more than \$100 a year at no cost to you! The FPL On Call® program is the easiest way to lower your electric bill. If you agree to participate, we will occasionally cycle off select major appliances for short periods of time, only when absolutely necessary during periods of peak energy demand. In exchange, you will receive a credit on your monthly bill for conserving energy, even if we never interrupt your appliances. Most likely you won't even notice when the On Call program is activated, but you'll definitely notice the savings. Only the appliances you choose will be enrolled in the program.

As the demand for energy increases, so does the need for additional power plants. Thanks to more than 750,000 On Call® participants and our customers' involvement in other energy efficiency and management programs, FPL has saved enough energy to avoid building 11 power plants. To learn more, visit www.FPL.com/oncall."



FPL Energy News
Florida Power & Light Company
P.O. Box 14800
Juno Beach, FL 33408

This newsletter was printed on a carbon recycled paper. Please recycle.



09/07

DIVIDER

BLANK

PAGE

Florida Power & Light Company
Docket No. 070626-EI
Staff's Data Request 9-5-08
Interrogatory No. 20
Page 1 of 1

Q.

Previously, FPL had on its website "Sunshine Energy FAQs." One of the questions was about costs and FPL stated that, "the charge goes toward the purchase of renewable resources for the program and nominal administrative costs to operate the program." Please explain the basis for describing administrative costs as nominal.

A.

The costs of the Sunshine Energy program are principally comprised of costs to procure RECs, costs of constructing solar facilities and costs to market the program. Administrative costs represent only a minor portion of the overall costs. In particular, FPL's administrative costs for the residential program were slightly less than \$0.65 per customer contribution.