

NovaCHARGE

Empowering The Future™



NovaCharger NC-5000 Series

Installation and Operation Manual

Thank you for selecting a NovaCharge Product. NovaCharge is a Green Business and we strive to reduce paper waste as much as possible. To that end, we offer electronic product registration and support documentation.

Instructions:

- 1 Go to www.support@novacharge.net
- 2 Click on the installation guide for your model
- 3 Register your product
- 4 Retain this card and receipt as proof of purchase

CONTENTS

LIMITED WARRANTY FOR Basic Charger	2
WARRANTY	2
EXCLUSIONS AND LIMITATIONS.....	2
IMPORTANT WARNING	3
Copyright, trademarks	3
Important Safety Notices.....	4
Package Contents	6
NC-5000 Charger.....	6
NC-5000 Holster	7
Recommended Tools.....	8
Installation	9
Hard wiring the power cable.....	9
Mounting the Wallbox.....	12
Mounting the Holster	14
Usage	17
LED Indication	19
Specifications	19

Date of Purchase: _____

Installation Location: _____

LIMITED WARRANTY FOR Basic Charger

(this "Warranty")

WARRANTY

It is acknowledged that you have read and agree to the terms of this Warranty by using and installing this charger (the "Product"). Subject to the terms and conditions set forth in this Warranty, including but not limited to the Exclusions and Limitations, Warranty obligations for this Product are limited.

NovaCharge warrants that this Product shall be free of defects in materials and workmanship under normal use for a period of three (3) years from the date of delivery (the "Warranty Period").

It is the requirement of the above remedy that you must contact NovaCharge and provide the model number, serial number and date of purchase during the Warranty Period.

Upon NovaCharge's notice, you must return the Product and include (i) a copy of your original purchase invoice or receipt to verify your warranty; (ii) your name, address, and telephone number; (iii) the Return Materials Authorization (RMA) number.

If any defect is found in the Product and a valid claim is received within the Warranty Period, your sole and exclusive remedy will be for NovaCharge, in its sole discretion and to the extent permitted by law, to (1) repair the defect in the Product at no charge, using new parts or refurbished parts, or (2) exchange the Product with new or refurbished hardware that is functionally equivalent to the original Product, or (3) if the Product is returned directly to NovaCharge and not to the original reseller, then NovaCharge reserves the right to replace the Product with an equivalent without any trademark/logo bearing. In addition, Warranty obligations do not apply to installation service of the Product.

EXCLUSIONS AND LIMITATIONS

This warranty applies only to the Product manufactured by NovaCharge and does not apply to any non-NovaCharge Product even if packaged or sold with the Product. Software distributed by NovaCharge with or without the NovaCharge brand name (including, but not limited to system software) is not covered under this warranty.

NovaCharge does not warrant that the operation of the Product will be uninterrupted or error-free. NovaCharge is not responsible for damage arising from failure to follow instructions relating to the Product's use.

This warranty does not apply to: (a) cosmetic damage; (b) removed or defaced serial numbers or warranty seal; (c) a product or part that has been modified to alter functionality or capability without the prior written permission; (d) damage caused by accident, abuse, misuse, fire, earthquake or any Force Majeure; (e) operating the Product not for the permitted or intended uses; (f) damage caused by use with non-NovaCharge products; (g) coatings unless failure has occurred due to a defect in materials or workmanship; or (h) damage caused by or via the network on which the Product is used including, but not limited to, any unauthorized online access.

IMPORTANT WARNING











Do not open, take apart or disassemble the Product in any way. Doing so may cause damage that is not covered by this warranty. Only NovaCharge or a NovaCharge authorized service provider should perform service on the Product.













TO THE EXTENT PERMITTED BY LAW, THIS WARRANTY AND THE REMEDIES SET FORTH ABOVE ARE EXCLUSIVE AND IN LIEU OF ALL OTHER WARRANTIES, REMEDIES AND CONDITIONS, WHETHER ORAL, WRITTEN, STATUTORY, EXPRESS OR IMPLIED. TO THE EXTENT PERMITTED BY APPLICABLE LAW, NOVACHARGE SPECIFICALLY DISCLAIMS ANY AND ALL STATUTORY OR IMPLIED WARRANTIES, INCLUDING, WITHOUT LIMITATION, WARRANTIES OF MERCHANTABILITY AND FITNESS FOR A PARTICULAR PURPOSE AND WARRANTIES AGAINST HIDDEN OR LATENT DEFECTS. NO ORAL OR WRITTEN INFORMATION OR ADVICE GIVEN BY NOVACHARGE OR A NOVACHARGE AUTHORIZED REPRESENTATIVE SHALL MODIFY OR EXTEND ANY WARRANTY, EXCEPT AS EXPRESSLY SET FORTH IN THIS WARRANTY, IN NO EVENT SHALL NOVACHARGE BE LIABLE FOR ANY CONSEQUENTIAL, INCIDENTAL, SPECIAL, PUNITIVE OR INDIRECT DAMAGES, OR FOR LOSS OF ACTUAL OR ANTICIPATED PROFITS, LOSS OF OPPORTUNITY, LOSS OF DATA, LOSS OF USE OF MONEY, LOSS OF INCOME OR REVENUE, BUSINESS INTERRUPTION ARISING OUT OF OR IN RELATION TO THIS AGREEMENT AND/OR THE PRODUCTS, WHETHER BASED ON PRINCIPLES OF CONTRACT, NEGLIGENCE, TORT OR OTHERWISE, EVEN IF IT HAS BEEN ADVISED OF THE POSSIBILITY OF SUCH LOSS OR DAMAGES. THE FOREGOING LIMITATION SHALL NOT APPLY TO DEATH OR PERSONAL INJURY CLAIMS, OR ANY STATUTORY. NOTWITHSTANDING THE FOREGOING, THE LIABILITY OF NOVACHARGE ARISING IN CONNECTION WITH THIS WARRANTY OR THE USE OR INABILITY TO USE THE PRODUCTS IN CONNECTION THEREWITH, HOWEVER CAUSED, AND ON ANY THEORY OF LIABILITY, INCLUDING CONTRACT, STRICT LIABILITY, NEGLIGENCE OR OTHER TORT, SHALL NOT EXCEED THREE TIMES THE AMOUNT OF THE PRODUCTS.

© NovaCharge 2015 - All Rights Reserved

No part of this manual may be reproduced, stored in a retrieval system or transmitted, in any form or by any means or otherwise, without the prior written permission of NovaCharge. NovaCharge is a registered trademark of NovaCharge, LLC.







IMPORTANT SAFETY NOTICES

	WARNING	In order to avoid damage to the NC-5000, locate it where it cannot make accidental contact with vehicle doors, bumpers, etc.
	WARNING	Grounding Instructions for a cord connected product: This product comes with a cord that contains an equipment grounding conductor and a grounding plug. The plug must not be modified in any way and must be plugged into a suitable properly-grounded outlet. Failure to follow this advice could result in electric shock or death. Check with a qualified electrician if you are unsure if the product is properly grounded.
	WARNING	Grounding Instructions for a permanently connected product: This product must be connected to a grounded, metal, permanent wiring system; or, an equipment-grounding conductor must be run with the circuit conductors and connected to the equipment grounding terminal on the product.
	WARNING	This NC-5000 must not be used outside of recommended operating parameters. Doing so could result in injury or death.
	Caution	Both housing and cable, including the connector, should be inspected before each use and if any damage is suspected, the charging station should not be used and customer support should be contacted for advice.
	Caution	Switch off the electrical supply to the charging station at the circuit breaker and contact customer support immediately if the charging station is ever suspected to be unsafe to use. Do not switch back on until the charging device has been confirmed as safe.
	Caution	To avoid damage to the NC-5000 or the vehicle's battery, this NC-5000 must be properly installed. Fairly to do so will void the warranty for the vehicle and the NC-5000.
	Caution	This NC-5000 must not be used outside of recommended temperatures (-40°F to +122°F (-40°C to +50°C)).
	NOTE	If any parts are missing, contact customer support for help.
	NOTE	Before cleaning the charging station, turn off the power to the charging station at the circuit breaker and disconnect switch (if applicable) before cleaning it. Wipe with a clean cloth dampened with water or a mild detergent solution suitable for use on automobile paint. Do not use chemicals or solvents. Do not submerge the charging station.

	WARNING	Chargers shipped prior to 2014/2/1 are designed for hard wiring unless specified. AC plug (not attached to the charger in the box) is provided when needed and allowed.
	WARNING	This device shall be mounted at a sufficient height from grade such that the height of the storage means for the coupling device is located between 600 mm (24 inches) and 1.2 m (4 feet) from grade.
	WARNING	This charging station should be installed by qualified personnel only, in accordance with manufacturer's instructions and in compliance with local and national codes (with local codes taking precedence over national codes).
	WARNING	The electric meter housing and power distribution service panel contain high voltages that can cause death or serious injury.
	WARNING	The charging station output cable should be positioned where it cannot be driven over, stepped on, tripped over, or otherwise damaged or stressed while in use. The output cable should always be stowed when not in use so as to avoid personal injury or damage to the dock.
	WARNING	For use by licensed drivers only. Not for use by minors.
	WARNING	Children should be supervised when in close proximity to the charging station.
	WARNING	For use with compatible vehicles only. Check vehicle's documentation to confirm compatibility.
	WARNING	This is a single phase charger. Do not connect all 3 phases to the charger. Only L1, L2 and ground are required.
	WARNING	Keep NC-5000 away from flammable, explosive, or combustible materials.
	WARNING	Personal injury or product damage can occur if the NC-5000 is incorrectly installed.
	WARNING	The NC-5000 safety device should not be used in place of standard electrical safety precautions.
	WARNING	In order to avoid tripping and shock hazards, the NC-5000 should be installed in a well-lit area away from pedestrian traffic or areas of child activity.

PACKAGE CONTENTS

NC-5000 Charger







1		NC-5000 Charger and charging gun	x1
2		Wall mount plate	x1
3		M3 Torx screw	x1
4		Screw for wall mount #12x2" (for wood wall)	x2
5		Screw for wall mount 1/4x2" (for cement wall)	x2
6		AC input cable	x1

NC-5000 Holster

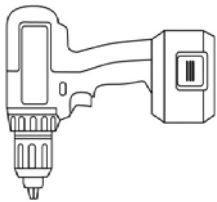
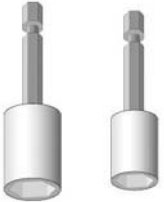
1		Front cover and plug holder	x1
2		Bottom housing	x1
3		Wall bracket	x2
4		Nut	x4
5		Screw for wall mount #12x2" (for wood wall)	x2
6		Screw for wall mount 1/4x2" (for cement wall)	x2
7		Socket head screw	x3

RECOMMENDED TOOLS

The following tools (not included) are recommended during installation:

1		3/16" wood drill bit (for wood wall) or 1/8" masonry drill bit (for concrete wall)
2		Drill
3		11/32" hex bit driver for electric drill (for wood wall) or 5/16" hex bit driver for electric drill (for concrete wall)
4		3/32" hex wrench
5		Phillips screwdriver
6		13/32" hex socket screwdriver
7		T10 screwdriver (for Torx screw)
8		Wire strippers

INSTALLATION

Hard wiring the power cable

⚠️ INSTALLED BY CERTIFIED ELECTRICIAN ONLY. ALWAYS READ THE MANUAL FIRST.

Releasing the AC power cable from terminal block, the pushing force on terminal block should not be greater than 30 lbf. After inserting the crimped ferrule into the terminal block, inspect visually that the wire ferrule has been inserted and pushed to the END of the ferrule. Try to pull the inserted wire to make sure that the wire is properly secured with the terminal block.

- Strip the AC power cable outer sleeve to 7.87 inches (for hard wiring only).

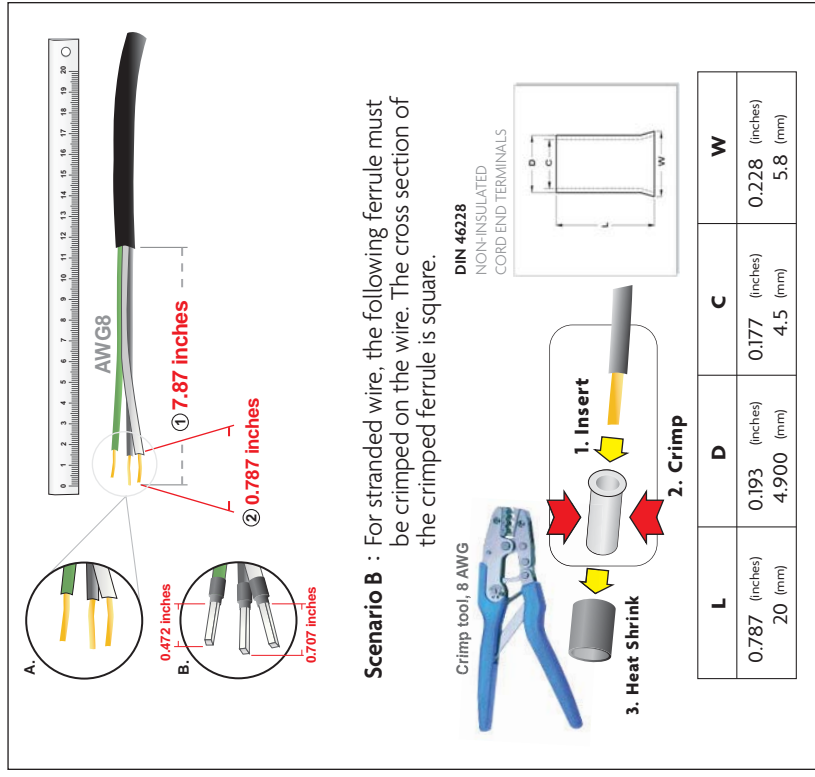

Scenario B : For stranded wire, the following ferrule must be crimped on the wire. The cross section of the crimped ferrule is square.

DIN 46228
NON-INSULATED
CORD END TERMINALS

Crimp tool, 8 AWG

1. Insert
2. Crimp
3. Heat Shrink

L	D	C	W
0.787 (inches)	0.193 (inches)	0.177 (inches)	0.228 (inches)
20 (mm)	4.900 (mm)	4.5 (mm)	5.8 (mm)

2. Feed the AC power cable through the left cable gland.

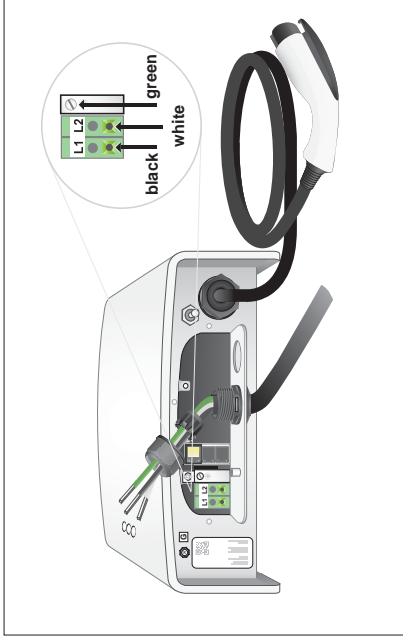

4. Replace the bottom cover and tighten the screws. Ensure toggle switch is set to the ON position.

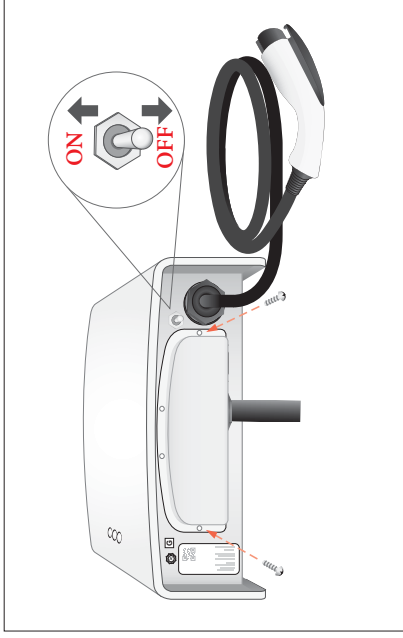

3. Make sure that each wire is secure and well-plugged into its corresponding terminal block.



5. Once correctly mounted, plug into a NEMA 6-50 outlet. For mounting instructions, see "Mounting the Wallbox" on page 12.

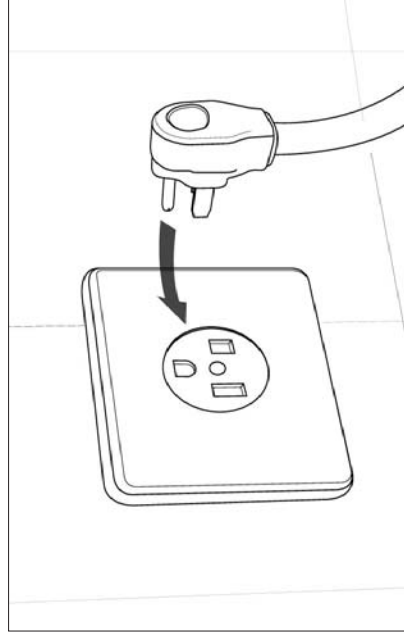

Mounting the Wallbox

1. Drill two holes in the wall, at a vertical distance of 5.50 inches from each other.
 - For wooden walls, use the 3/16" wood drill bit.
 - For concrete walls, use a 1/8" masonry drill bit.

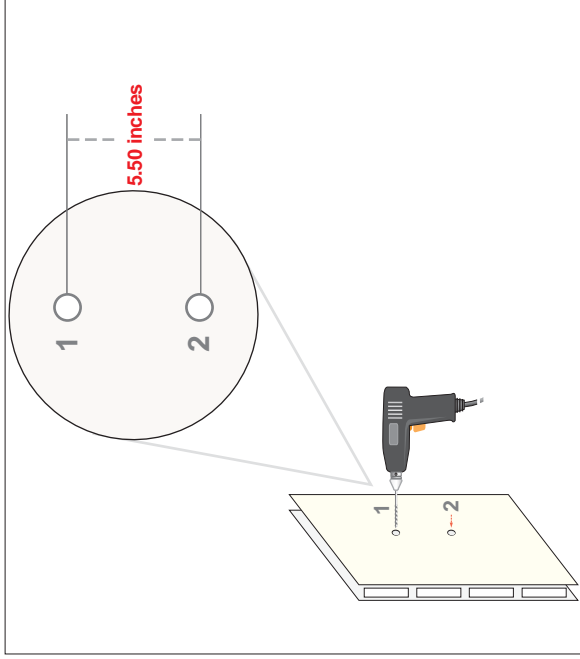

2. Secure the wall mount plate to the wall.
 - For wooden walls, screw in the two #12x2" screws with a 11/32" hex bit driver.
 - For concrete walls, screw in the two 1/4x2" screws with a 5/16" hex bit driver.

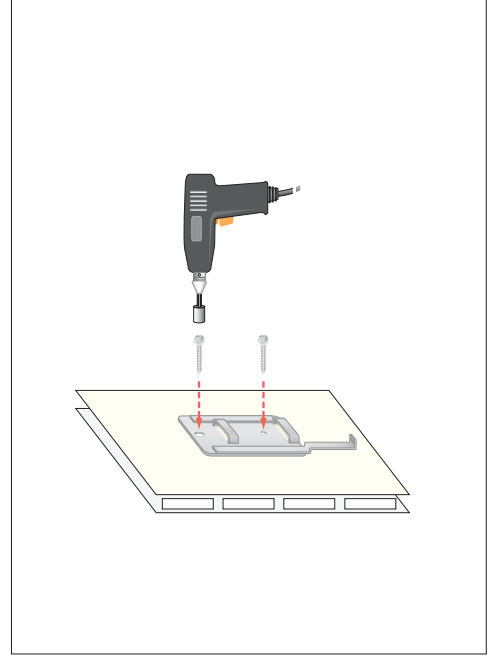

3. Pay attention to the location of the mounting brackets on the back of the NC-5000 Charger.

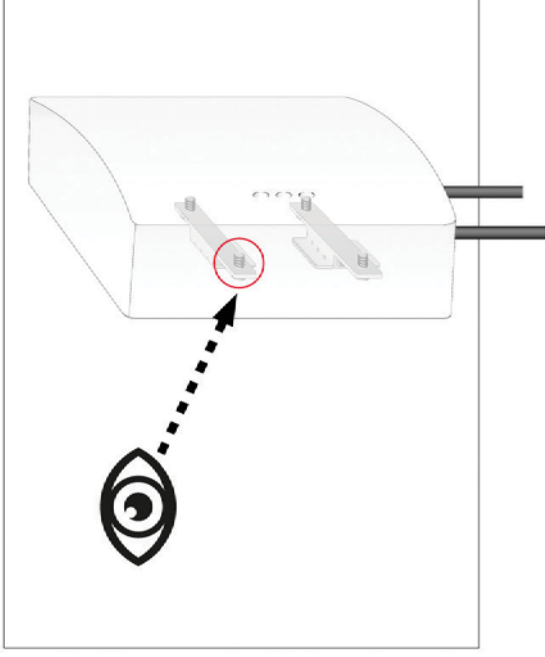

4. Secure the NC-5000 Charger to the mounting plate, as shown below (1) and screw in the M3 Torx screw using the T10 screwdriver to lock the charger in place (2) and help prevent theft or accidental dislodgement.

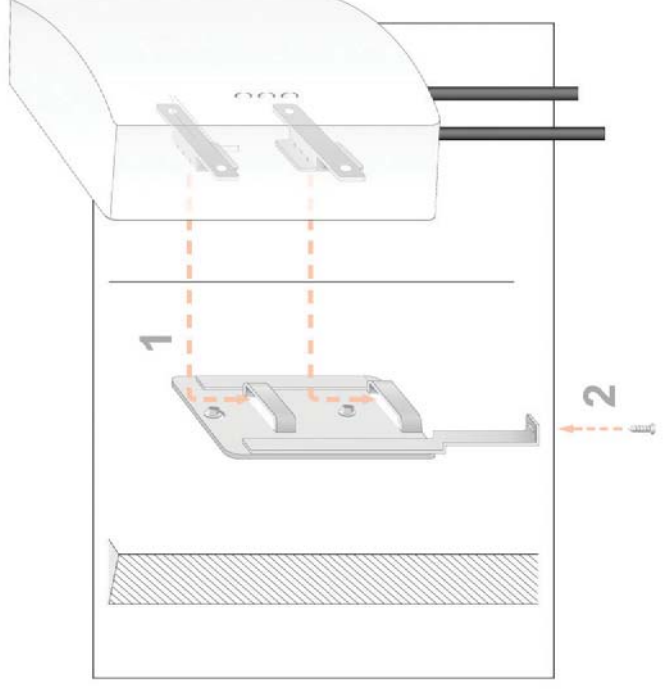

5. The NC-5000 Charger is now mounted.

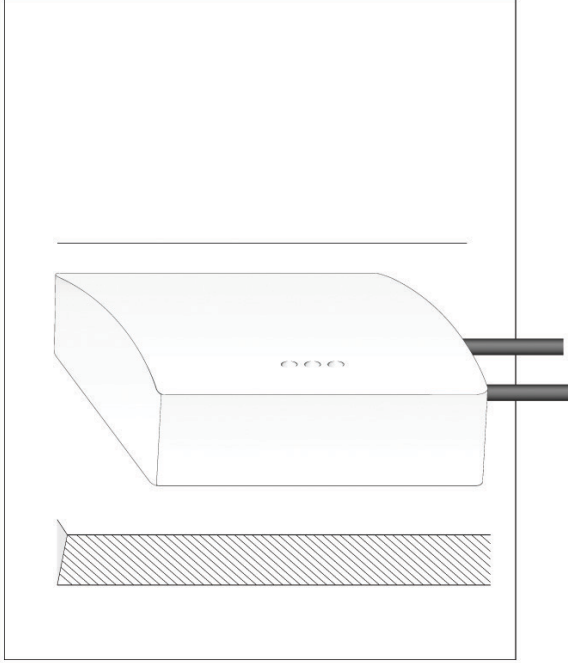

2. Secure the wall brackets to the wall.

- For wooden walls, screw in the two #2x2" screws with a 11/32" hex bit driver.
- For concrete walls, screw in the two 1/4x2" screws with a 5/16" hex bit driver.

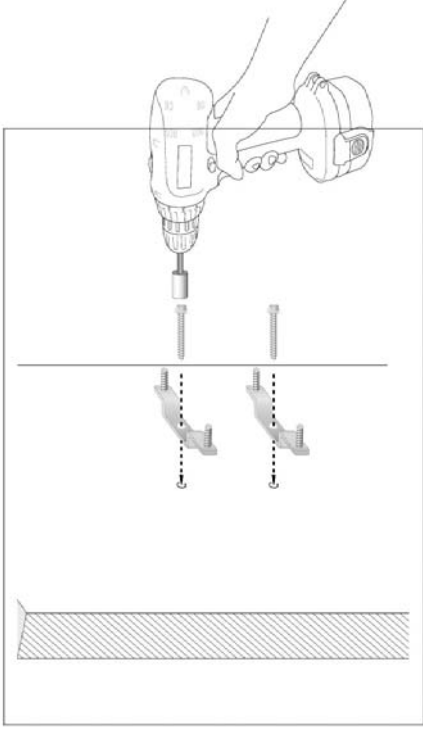

Mounting the Holster

3. Use the 13/32" hex socket screwdriver to secure the NC-5000 Holster bottom housing to the wall brackets with the four nuts. Ensure that the NC-5000 Holster bottom housing is mounted with one locking screw hole to the top and two locking screw holes to the bottom (see image below).

1. Drill two holes in the wall, at a vertical distance of 6.10 inches from each other.
 - For wooden walls, use the 3/16" wood drill bit.
 - For concrete walls, use a 1/8" masonry drill bit.

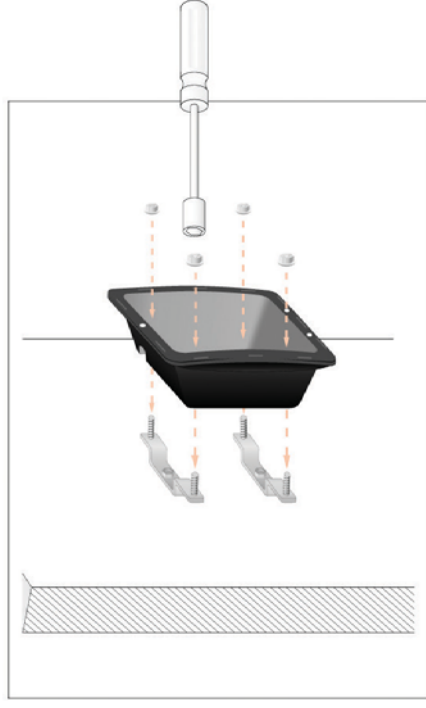
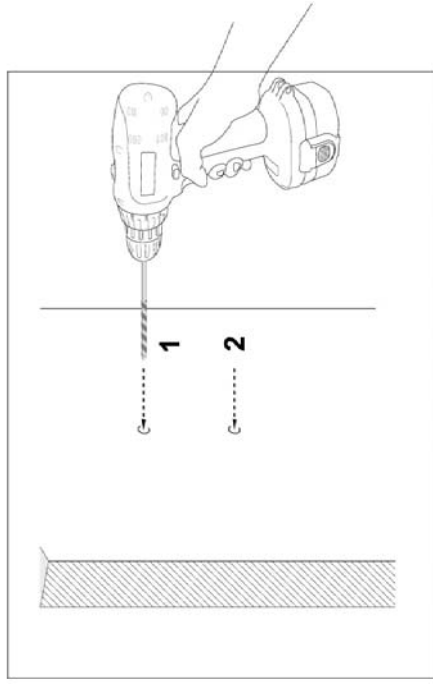

4. Insert the NC-5000 holster front cover into the bottom housing as shown below and secure it in place with the 3 socket head screws using a 3/32" hex wrench.

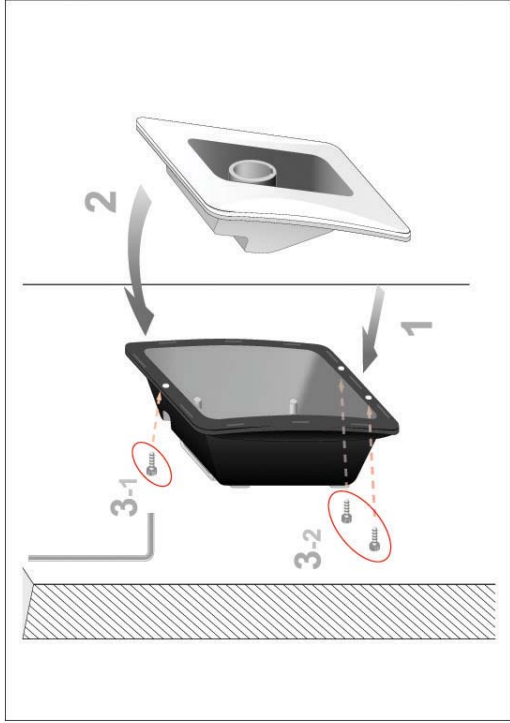

Usage

1. Remove the charging gun from the NC-5000 Holster.

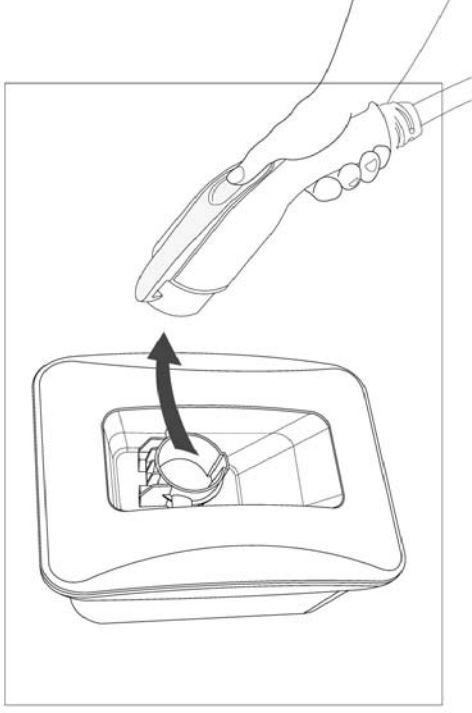

5. Installation is now complete.

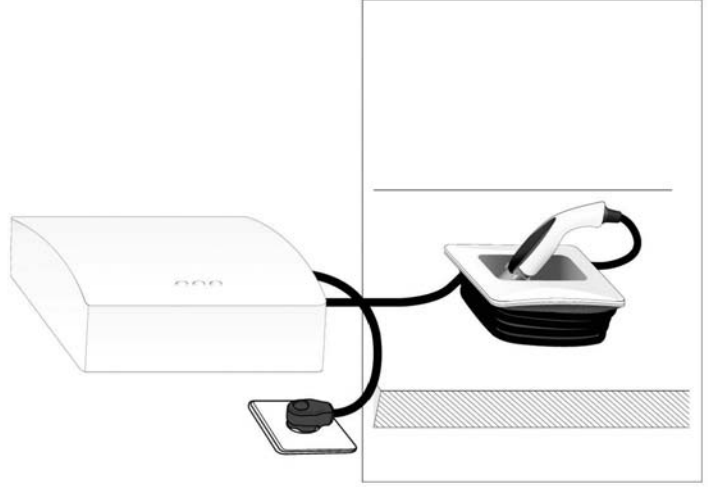

2. Plug the charging gun into the EV.

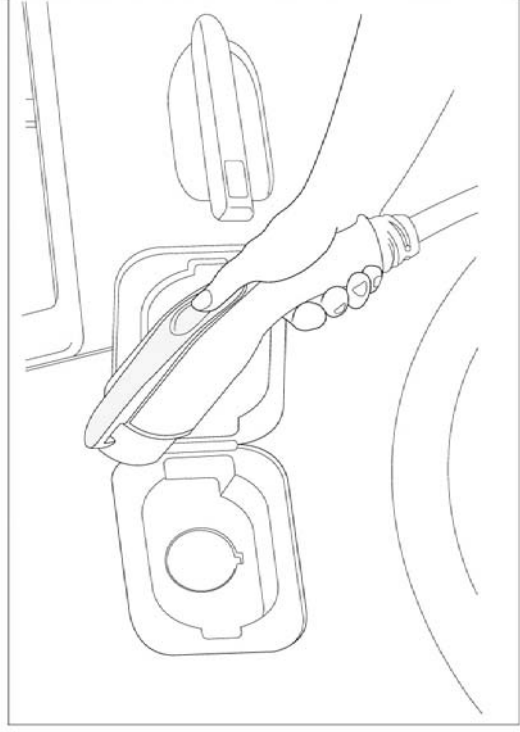

- Keep an eye on the middle (charging) LED. When it displays a steady blue light, charging is complete.

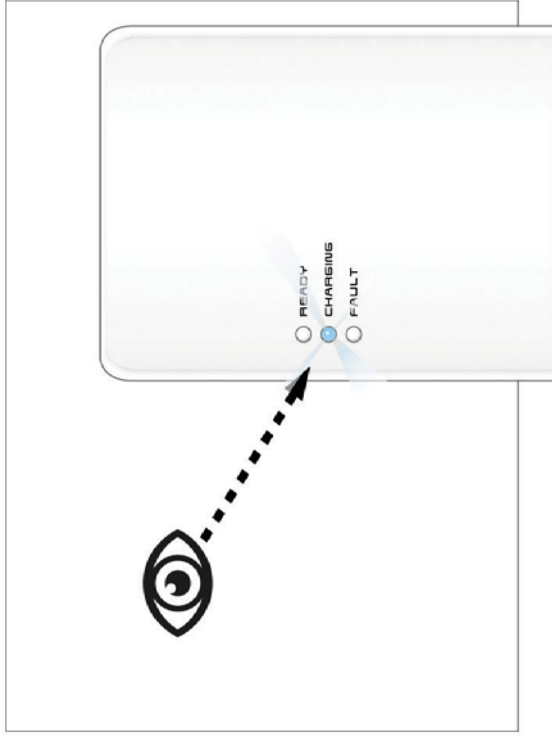

LED Indication

Green LED: Ready
 Blue LED: Charging
 Red LED: Fault



LED State Meaning

LED State	Meaning
Steady Green	Ready to charge
Slow Blinking Green	EV connected
Blinking Blue	Charging
Steady Blue	Charging Complete
Slow Blinking Red	Fault
Steady Red	Fatal error, please contact service personnel

PRODUCT SPECIFICATIONS

Charging Connector:	SAE J1772 coupler
Input Power:	208/240 VAC Single Phase 32A
Frequency:	60Hz
Output Power:	7.2KW
Dimensions:	15.0" L x 10.6" W x 4.7" D
Weight:	17.6 lb
Operating Temperature:	-22°F ~ 122°F (-30°C ~ 50°C)
Humidity:	95% RH non-condensing
Enclosure Rating:	Type 3R per UL 50E
Safety Compliance:	UL/cUL
Protection:	Overload & Ground Fault Detection
Cable Entry:	Back/Bottom

- Unplug the charging gun from the EV and replace in the NC-5000 holster.

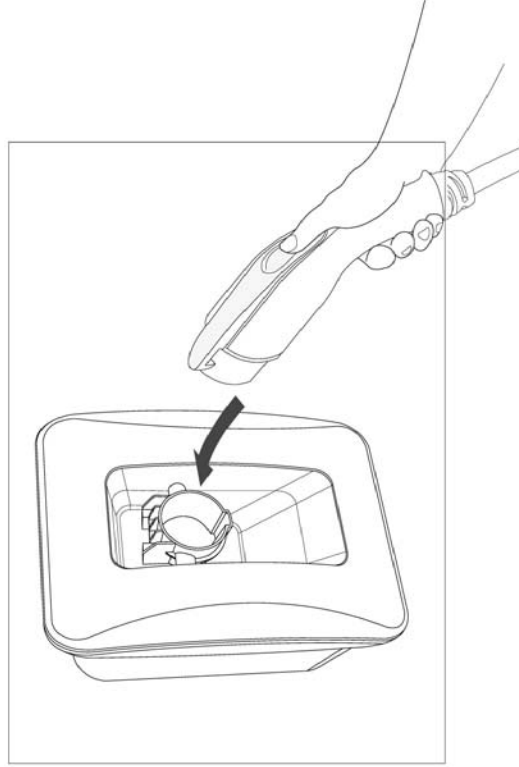



172A State Street E., Oldsmar FL 34677

US Toll Free: (866) 417-9995 • 1 (813) 333-1119 • Fax: (813) 569-0716

www.novacharge.net

© NovaCharge 2015 - All Rights Reserved