

BEFORE THE FLORIDA PUBLIC SERVICE COMMISSION

In re: Fuel and Purchased Power Cost Recovery
Clause with Generating Performance Incentive
Factor

Docket No. 20220001-EI

Filed: September 26, 2022

**FLORIDA POWER & LIGHT COMPANY'S
MOTION TO STRIKE PORTIONS OF TESTIMONY OF
OFFICE OF PUBLIC COUNSEL WITNESS RICHARD POLICH**

Florida Power & Light Company (“FPL” or “the Company”), pursuant to Rule 28-106.204, Florida Administrative Code, and Order No. PSC-2022-0052-PCO-EI, hereby moves to strike portions of Office of Public Counsel (“OPC”) witness Richard Polich’s testimony pertaining to (i) Mr. Polich’s recommendations that the Florida Public Service Commission (“the Commission”) initiate an investigation of, and open a spin-off docket for the purpose of investigating and evaluating, FPL’s nuclear operations, and all testimony in support of those recommendations; (ii) activities related to outage events for which no replacement power cost recovery is sought and therefore are not at issue and outside of the Commission’s jurisdiction; (iii) matters based solely on conjecture; and (iv) a proclaimed reservation of procedural rights (which must be requested by a separate motion) including the right to challenge in the future outage events and the resulting replacement power costs which FPL has addressed through prefiled testimony in this Docket in support of an affirmative prudence determination. Exhibit A to this Motion highlights the portions of witness Polich’s testimony that should be struck for the reasons stated herein.

Introduction

On January 3, 2022, the Commission established a new docket number, 20220001-EI, for purposes of evaluating the prudence and reasonableness of fuel and purchased power costs recovered through the Fuel and Purchased Power Cost Recovery Clause (“Fuel Docket”): a continuing docket in which the Commission retains jurisdiction from year to year. Unresolved issues from prior years shift to the new docket number.

From time to time, utilities experience unplanned outages or deratings of their generation facilities which lead to the need to procure replacement power. During calendar years 2020 and 2021, FPL experienced unplanned outages or deratings at its nuclear sites, Turkey Point and St. Lucie. Replacement power cost issues pertaining to outages that occurred in those prior years were deferred for resolution to this year's Fuel Docket pursuant to a stipulation by the parties (including OPC) in Docket No. 2021001-EI, which was approved by the Commission.

The Commission issued an Order Establishing Procedure on February 7, 2022. That Order authorized all parties to serve written discovery related to the issues in this Docket. On April 1, 2022, as part of FPL's Final True-Up filing, the Company submitted the testimony of Dean Curtland, its Vice President of Nuclear. Mr. Curtland's testimony addressed two unplanned outages that occurred in 2020 and three that occurred in 2021. On July 27, 2022, as part of its Actual/Estimated True-Up filing, Mr. Curtland filed testimony addressing two additional outages that occurred in 2021. On September 2, 2022, FPL's Projection filing included testimony by Mr. Curtland regarding one additional outage that occurred this year.

On September 14, 2022, OPC filed the testimony of Richard Polich, consisting of 42 pages of written testimony and 13 exhibits totaling 371 pages. Witness Polich challenges two of the outages at Turkey Point that were addressed in FPL witness Curtland's testimony: the July 5, 2020 outage and the March 1, 2021 outage (when referenced collectively, "the Disputed Outages"). Of the 42 pages of testimony, Mr. Polich devotes just shy of eight pages to discussing his assessment of the Disputed Outages and their impact on replacement power costs. (Polich at 35-42). FPL disagrees and will be rebutting his assessment of the Disputed Outages but acknowledges that those eight pages of discussion and the introductory section of his testimony that addresses witness

Polich's professional background and experience (pages 1-7) and the five associated exhibits (RAP-1, 2, 11, 12 and 13) are appropriate for the Commission to consider.

With few exceptions, the remainder of witness Polich's testimony should be excluded. The pages between the discussion of his work experience and the discussion of the Disputed Outages – pages 8 through 34 – describe miscellaneous staffing and performance data from prior years without offering proof of any causal connection to the Disputed Outages. Instead, he offers them to bolster a request for the Commission to initiate an investigation of FPL's nuclear operations for the purpose of satisfying his speculation about whether there might have been any impact on fuel costs in the past or whether there could be such an impact in the future. As described below, absent evidence that a particular act or decision was imprudent and resulted in costs for which FPL is seeking recovery, the matter is unrelated to cost recovery and therefore lies outside the Commission's jurisdiction and should not be considered. Moreover, OPC witness Polich is essentially asking the Commission to take on new responsibilities that fall within the province and expertise of the Nuclear Regulatory Commission ("NRC"). The Commission should defer to the NRC with respect to the general oversight of FPL's nuclear operations and exclude Mr. Polich's testimony that invites the PSC to invade the NRC's role, as well as all testimony included solely for the purpose of supporting his improper request for a Commission investigation of FPL's general nuclear operations.

Witness Polich's testimony also includes discussions regarding what even he admits is conjecture without a causal connection to the Disputed Outages. The Commission should strike such testimony as irrelevant and incompetent.

I.
THE COMMISSION SHOULD STRIKE OPC
WITNESS POLICH’S RECOMMENDATION FOR
A SPIN-OFF DOCKET AND FPSC INVESTIGATION
OF THE GENERAL OPERATIONS OF FPL’S NUCLEAR
PLANTS BECAUSE THE NUCLEAR REGULATORY COMMISSION
EXERCISES PRIMARY JURISDICTION OVER THE SAME MATTERS

OPC witness Polich asks the Commission to initiate “an investigation and independent assessment of FPL nuclear operations.” (Polich 34:20-22) He testifies that “an independent evaluation can assess personnel performance,” evaluate the impact of workforce reductions, and “can provide valuable insight into operations and personnel tweaks that could help avoid future problems.” (Polich at 34:22-35:5). Such an investigation, witness Polich posits, may lead to changes that might improve “moral[e], performance, personnel integrity and, ultimately, safety.” Mr. Polich goes on to recommend that the Commission establish a spin-off proceeding “to perform an in-depth evaluation of the FPL headcount reductions’ impact on nuclear operations and rate-payer borne fuel cost impacts since 2016 and into the future.” (Polich at 35:6-8).

These recommendations ignore, openly and brazenly, the fact that the NRC has the authority and responsibility to oversee and regulate the very matters he is asking the Commission to investigate, and that the NRC is currently exercising that authority at Turkey Point and St. Lucie with the benefit of decades of experience.¹ The Commission should defer to the NRC, the agency

¹ In support of this unprecedented request, witness Polich (i) describes the general performance of Turkey Point (nuclear) and St. Lucie in terms of availability and forced outage rates for 2017 through 2021 (Polich at 13-16); (ii) expresses generalized concerns about “industry cost trends” and “corporate culture issues” that could drive nuclear cost cuts (Polich at 16-17); (iii) describes FPL’s staffing numbers for 2017 through 2021 (Polich. at 17-19); and (iv) describes NRC investigations and actions taken with respect to outage and personnel activity at the Turkey Point and St. Lucie plants. (Polich at 19-31). Because witness Polich’s investigation recommendation must be struck, this testimony also must be excluded.

with primary jurisdiction to oversee FPL's nuclear operations, and strike Mr. Polich's testimony pertaining to the requests.

**Florida Law and this Commission have Recognized
it is Appropriate To Defer To Agencies with Expertise**

In this case, the Commission clearly has subject matter jurisdiction over requested cost recovery for replacement power costs arising from the operation of FPL's nuclear units. However, oversight of FPL's general nuclear operations lies with the NRC.

Florida courts and this Commission have recognized that agencies with primary jurisdiction over specified subject matters acquire expertise in the areas they are charged with regulating. Primary jurisdiction is a doctrine grounded in the principles of deference and restraint. *Flo-Sun, Inc. v. Kirk*, 783 So. 2d 1029, 1039 (Fla. 2001). Under the doctrine, a tribunal possessing subject matter jurisdiction to pass upon an asserted claim chooses to stay its hand and defer to the administrative agency in order to "bring specialized expertise to bear upon the disputed issues." *Id.* (quoting *Hill Top Developers v. Holiday Pines Serv. Corp.*, 478 So.2d 368, 370 (Fla. 2d DCA 1985)). Deference is particularly appropriate where there is a comprehensive legislative and regulatory framework established to deal with the complex technical issues which may arise in the matter before the tribunal. *Flo-Sun*, 783 So. 2d at 1040; *see also S. Lake Worth Inlet Dist. v. Town of Ocean Ridge*, 633 So. 2d 79, 90 (Fla. 4th DCA 1994) ("When the legislature decides in an enactment to infuse an executive department with primary jurisdiction to regulate a specific subject, that represents a decision by our lawmakers that special expertise is required to resolve questions embraced by the subject . . .").

The doctrine of primary jurisdiction typically is invoked in the context of courts deferring to administrative agencies. *Id.* at 1037 ("The doctrine of primary jurisdiction enables a court to have the benefit of an agency's experience and expertise in matters with which the court is not as

familiar [and] protects the integrity of the regulatory scheme administered by the agency.”).² But this Commission has recognized and applied primary jurisdiction as a basis for it to defer to a different agency with subject matter expertise. *See In Re: Application of Lannie Rowe Development Corporation to Amend Certificate No. 119-S in Bay County, Florida*, Docket No. 800201-S, Order No. 9770 (Issued Jan. 28, 1981) (regarding a wastewater utility’s non-compliance with the Department of Environmental Regulation requirements, the Commission was persuaded to postpone consideration of issues regarding environmental compliance because “the Department of Environmental Regulation, the office of primary jurisdiction of these matters, is apparently involved in solutions to the problems.”).

The NRC has Primary Jurisdiction To Oversee FPL’s Nuclear Operations

Through its enabling legislation, regulations and internal manuals, the NRC has long-standing primary jurisdiction to oversee FPL’s nuclear operations under a comprehensive scheme.

Enabling legislation. The NRC began operations on January 19, 1975, having been created by Congress through the Energy Reorganization Act of 1974 as the successor to Atomic Energy Commission. Congress entrusted the NRC with the responsibility to “establish standards and instructions to govern the possession and use of special nuclear material . . . as the Commission may deem necessary or desirable to . . . protect health or to minimize danger to life or property.” 42 U.S.C. § 2201.³ For nuclear reactors, the NRC is authorized to set forth requirements it deems “necessary in order to enable it to find that the utilization or production of special nuclear material

² *See also In Re: Joint Application of Caxambas Transp. Serv., Inc. & Everglades Transp. Serv., Inc. for the Transfer of Certificate No. 1129 from the Former to the Latter.*, 3 FPSC 882 (Aug. 18, 1978) (“The courts defer to the primary jurisdiction of administrative agencies when parties seek their determination of issues within the expertise of those agencies.”)

³ Atomic Energy Act Section 161.

will be in accord with the common defense and security and will provide adequate protection to the health and safety of the public.” 42 U.S.C. § 2232(a).⁴

Regulations. The NRC implements the Atomic Energy Act’s directives through Part 50 to Title 10 of the Code of Federal Regulations, which includes a comprehensive set of regulations governing the operation of nuclear power plants. Specifically, 10 C.F.R. § 50.70 authorizes NRC oversight and intrusive inspections of nuclear reactors. Pursuant to the regulations, nuclear operators, such as FPL, must “provide rent-free office space for the exclusive use of the Commission inspection personnel.” 10 C.F.R. § 50.70(b)(1). The inspection personnel who occupy space at the nuclear site are known as “resident inspectors.” NRC resident inspectors must be granted “immediate” and “unfettered” access to the site in order to perform their independent inspections. In other words, the NRC does not merely peer into the nuclear site’s operations from time to time, or simply in response to certain events. The NRC fulfills its oversight responsibilities by deploying fulltime inspectors who work directly on site at all times.

Internal manuals. The NRC carries out its statutory and regulatory functions through its Reactor Oversight Process (or “ROP). NRC Management Directive 8.13⁵ sets forth the manner in which the NRC implements inspections, assessments, and enforcement for regulated nuclear reactors. In carrying out the Reactor Oversight Process, the NRC relies upon its Inspection Manual,⁶ which provides an exhaustive set of inspection procedures for all facets of plant operation.

Enforcement powers. The NRC’s authority reaches beyond investigation and reporting; it also has broad and comprehensive enforcement powers designed to strictly ensure nuclear

⁴ Atomic Energy Act Section 182.a.

⁵ <https://www.nrc.gov/docs/ML1734/ML17347B670.pdf>

⁶ <http://www.nrc.gov/reading-rm/doc-collections/insp-manual/manual-chapter/>

operators are performing adequately. The NRC's quarterly reviews of plant performance, which consider both performance indicators and inspection findings, determine what additional actions, if any, the NRC will take if there are signs of declining performance. The enforcement process uses five levels of regulatory response with NRC regulatory review increasing as plant performance declines. If the quarterly reviews indicate significant performance degradation, the NRC's enforcement powers include responses up to and including operating license modification, suspension and even revocation.

The NRC's Oversight Process Addresses the Matters Witness Polich Asks the PSC To Investigate

The Reactor Oversight Process addresses the very issues witness Polich asks the PSC to investigate. In particular, the ROP inspection procedures deal directly with, among other things, NRC oversight of staffing, problem identification and resolution, and safety culture issues. These inspection procedures are set forth in Inspection Manual Chapter (IMC)-310,⁷ which provides that aspects to be monitored by the NRC include the following:

Human performance – Leaders ensure that **personnel, equipment, procedures, and other resources are available and adequate** to support nuclear safety. (emphasis added)

The NRC also monitors the ability to identify, evaluate and resolve issues:

P.1 Identification: The organization implements a corrective action program with a low threshold for identifying issues. Individuals identify issues completely, accurately, and in a timely manner in accordance with the program.

P.2 Evaluation: The organization thoroughly evaluates issues to ensure that resolutions address causes and extent of conditions commensurate with their safety significance.

⁷ <https://www.nrc.gov/docs/ML1901/ML19011A360.pdf>

P.3 Resolution: The organization takes effective corrective actions to address issues in a timely manner commensurate with their safety significance.

And, the NRC uses IMC-310 to monitor cultural aspects of licensee performance:

S.1 Safety Conscious Work Environment (SCWE) Policy: The organization effectively implements a policy that supports individuals' rights and responsibilities to raise safety concerns, and does not tolerate harassment, intimidation, retaliation, or discrimination for doing so.

S.2 Alternate Process for Raising Concerns: The organization effectively implements a process for raising and resolving concerns that is independent of line management influence. Safety issues may be raised in confidence and are resolved in a timely and effective manner.

S.3 Free Flow of Information: Individuals communicate openly and candidly, both up, down, and across the organization and with oversight, audit, and regulatory organizations.

The NRC Implements the Reactor Oversight Process at Turkey Point and St. Lucie

The NRC's authority to oversee nuclear operators is not theoretical. Its authority is thoroughly exercised. Two resident inspectors have offices at Turkey Point and St. Lucie, and each has unfettered access at the sites. The resident inspectors will review the performance of FPL's sites as measured by the performance indicators and by inspection findings on a quarterly basis, with the final quarterly (i.e., the annual report) review involving a more detailed assessment of plant performance. The annual reports prepared by the Turkey Point and St. Lucie resident inspectors are made publicly available.

The Commission Should Defer to The NRC's Primary Jurisdiction and Strike Mr. Polich's "Investigation" and "Spin-Off" Recommendations

OPC witness Polich's recommendation that the Commission initiate a general investigation to assess FPL nuclear operations (Polich 34:20-22) strays far afield from the fundamental purpose of this docket – a prudence review designed to ensure that customers' fuel charge includes recovery of only those costs that were prudently incurred. As demonstrated above, the NRC has a

comprehensive, detailed, proven and audited process through which it assesses the performance of nuclear operators. The Commission should decline OPC witness Polich's invitation to invade the NRC's well-established province.

Curiously, Mr. Polich relies heavily on NRC investigative reports, findings and performance indicators to bolster his recommendation for an investigation. The fact that the NRC's reports serve as a significant source of information categorically demonstrates that the NRC is fulfilling its statutory responsibility. Indeed, witness Polich never asserts that the NRC has failed to perform appropriate investigations or neglected its statutory duties in any way.

In the absence of a specific prudence question related to a cost FPL seeks to recover from customers, the doctrine of primary jurisdiction counsels that the Commission should instead defer to the NRC's expertise and primary jurisdiction. Doing so also will also protect against the possibility of having two regulators reach inconsistent results; that is, two different sets of directives regarding the same conduct or activity, which could leave FPL unable to comply with the orders issued by one of its regulators. *See Flo-Sun*, 783 So. 2d at 1037 (Fla. 2001) (recognizing an agency's primary jurisdiction "promotes consistency and uniformity in areas of public policy"). The Commission should strike Mr. Polich's recommendation for an FPSC-initiated investigation and spin-off docket, and should exclude all associated testimony.⁸

⁸ Several pages of witness Polich's testimony describe the Turkey Point and St. Lucie equivalent availability factor ("EAF") and equivalent forced outage rate ("EFOR") statistics for 2017 through 2021. EAF and EFOR are appropriate subject matters for discussion in this docket as part of the Generation Performance Incentive Factor rewards and targets reviewed and approved by the Commission. However, the EFOR and EAF underlying FPL's rewards and targets for 2017 through 2020 already have been examined and decided. OPC could have raised relevant points in prior years (or sought deferral), but it did not. Exploring those topics this year is improper.

II.
**OUTAGE EVENTS FOR WHICH FPL DOES NOT SEEK
COST RECOVERY ARE NOT SUBJECT TO COMMISSION REVIEW**

FPL experienced outages at Turkey Point Unit 3 in August of 2020. In the Company’s April 1, 2022 Final True-Up filing it confirmed that “FPL will not pursue recovery of the replacement power costs associated with outages at Turkey Point Nuclear Unit 3 in August of 2020, which were a subject of Issue 2K in Order No. PSC-2021-0403-PHO-EI, and will refund with interest any associated costs collected from customers when its fuel factor is next reset.” On September 2, 2022, the Company filed the calculation of its 2023 Fuel Cost Recovery Factors. That calculation included the refund, with interest, of the August 2020 replacement power costs. Those costs, therefore, are not at issue in this proceeding. Nor will FPL seek recovery of those costs through base rates. In other words, customers will not be financially impacted by the cost to replace the power associated with the August 2020 outages.

The Public Service Commission has jurisdiction to regulate and supervise each public utility with respect to its rates. § 366.04, F.S. Decisions regarding costs it will not include in customer rates are non-jurisdictional. Accordingly, Mr. Polich’s testimony related to the August 2020 events and any other non-jurisdictional cost or decision should be struck.

Witness Polich implicitly acknowledges the extraordinary nature of his insistence on discussing these non-jurisdictional costs in the face of FPL’s refund of those costs. *See, e.g.*, Polich at 23, posing the following question: “If FPL is not seeking recovery of replacement power costs, they why do you need to see the information?”⁹ Yet he devotes more than five pages of his

⁹ Mr. Polich falsely and repeatedly claims that he was “blocked access” to information regarding the August 2020 outages. In this Docket, FPL preserved its relevance objection once it affirmed the decision to refund the associated replacement power costs. But OPC was not “blocked access” to requested information. First, in the predecessor docket – No. 20210001-EI – FPL produced 2,148 pages containing detailed information regarding FPL’s investigation of each of the August

testimony addressing these outages, attempting to manufacture relevance where none exists by arguing that customers and the Commission are entitled to know why FPL chose to refund the replacement power costs. (e.g., Polich at 23:2-4).¹⁰ FPL is unaware of any authority requiring FPL to explain why it voluntarily excluded certain costs from customer bills. Mr. Polich cites none. Whether a decision to *exclude* the costs was charitable, due to resource constraints, or was arbitrary, the underlying rationale is not subject to exploration because the costs do not impact customer rates. Mr. Polich effectively implores the Commission to scrutinize how FPL utilizes unregulated funds. Those decisions fall outside the Commission's purview. Any testimony offered by Mr. Polich in this regard must be struck.

III.
**THE COMMISSION SHOULD STRIKE WITNESS POLICH'S
SPECULATION REGARDING WHAT AN INVESTIGATION OR
SPIN-OFF DOCKET MIGHT SHOW REGARDING FUEL COSTS**

Much of witness Polich's testimony is purely speculative or spurious, and therefore has no probative value. By his own admissions, a significant portion of Mr. Polich's testimony does not

outages and responded to associated interrogatories. Second, the objection reserved in this docket did not result in the withholding of any information that was not otherwise available to OPC or Mr. Polich (as evidenced by his detailed descriptions of the events). Third, Mr. Polich states that the Commission sustained FPL's objection to OPC posing questions about the outages during the 2020 Fuel Docket hearing, but recognizes that "the Commission allowed some very limited explanation of related matters." Review of the applicable transcript pages reveals that OPC's counsel was permitted to proffer his questions and stated on the record that he exhausted his questions.

¹⁰ Witness Polich also claims the Commission should understand "whether FPL is properly and prudently pursuing recovery from third parties in all instances where vendors or an insurance company may be obligated to compensate FPL." His reasoning is flawed. First, that logic would be true in instances where FPL seeks cost recovery from customers that should be borne by third parties. But here, customers are not being charged, so it is of no moment whether FPL is being reimbursed by third parties. Second, OPC had the opportunity to propound discovery about relevant insurance coverage or third party reimbursement. It did not do so. Third, had OPC asked the question in discovery, it would have learned that no such third party funds were applicable or available.

prove or disprove whether FPL prudently incurred the replacement power costs for which FPL seeks recovery. Rather, it consists of speculation of what might, if given the opportunity to conduct an intrusive investigation, be hypothetical problems that could at some point in time have impacted FPL’s fuel costs. Or, Mr. Polich posits, potentially impact *future* fuel costs.

The table below sets forth many of the instances of Mr. Polich’s rampant conjecture, all of which should be struck for two reasons. First, as Mr. Polich admits, this speculative testimony is not proof that the two Disputed Outages were caused by imprudence. The testimony is used only to buttress the improper request for an FPSC-initiated investigation into FPL’s nuclear operations generally and a putative spin-off docket. Because that investigation is improper and unnecessary for the reasons explained in Section I above, all of Mr. Polich’s speculative statements purporting to support the improper request also must be excluded.

Second, this speculative ideation does not meet even the relaxed standard under the Administrative Procedure Act that evidence be “of a type commonly relied upon by reasonably prudent persons in the conduct of their affairs.” § 120.569, F.S. In contrast to disputes involving factual disagreements regarding causation, here, Mr. Polich *admits* the anecdotes and musings he recites and upon which he relies do not demonstrate a causal link. Because these portions of his testimony lack the element of “causation” necessary to determine prudence, they should be struck.

OPC Witness Polich Testimony	Page/Line
Reductions in personnel alone are not necessarily a red flag in the assessment of nuclear plant operations.	8:5-6
. . . there have been a series of instances at St. Lucie and Turkey Point over recent years which are indicative of potential problems and which call into question whether force reductions during times of frozen base rates are in the best interests of customers who pay for replacement power in the event of outages.	8:6-9
The NRC determined that the deliberate actions of the now former FPL Regional VP - Operations caused FPL to be in violation of 10 C.F.R. § 50.7, which is significant because of the potential that individuals might not raise safety issues for fear of retaliation.	8:17-21

OPC Witness Polich Testimony	Page/Line
These events, coupled with decreased headcount and increased outage and derate hours, are a potential indication of a deficient nuclear operations culture at St. Lucie and Turkey Point facilities.	9:12-14
FPL’s overall effort at reducing operational costs through personnel reductions has the potential to cause stress to be placed on personnel to do more with less.	9:14-15
My review of the cause of plant outages indicates that lower head count may be contributing to lower plant performance.	9:17-18
In my testimony I have also taken a more holistic look at the circumstances that may be impacting the ongoing costs of fuel needed to replace the output of the four FPL nuclear units when they are unavailable. This effort indicates that FPL customers may be paying excessive costs of replacement power in 2022 and 2023.	9:21 – 10:2
This wider view of FPL’s nuclear operations involved an evaluation of factors and operational conditions as mentioned above and discussed below that may be having an ongoing impact on the replacement power costs of FPL that are at issue in the current docket and in the ongoing recovery of fuel costs to be recovered in the future.	10:2-6
As I was evaluating the outages and reviewing the documentation provided by FPL (and available from the NRC), I became concerned that industry cost trends, market forces and other corporate culture issues could be driving the company to cut costs in its nuclear operations in a way that could impact customer fuel rates.	16:17-17:1
The sequence of reactor unplanned scrams in August of 2020 appears to be an indication of deficient training, inadequate staffing, and potential lack of experience among plant personnel.	31:22-32:1
The past evidence of falsification of maintenance records and of FPL managers taking punitive actions against a contractor, although assumedly addressed, raise concerns that they could be indicators of potential cultural issues emanating from cost pressures in a way that can impact plant operations and performance.	32:1-4
Any one of these items in isolation may not necessarily constitute an indication of bigger issues. However, when aggregated and evaluated against the backdrop of a significant reduction in headcount at both plants, as well as recent NRC findings, agreed-violations and a downgrade from “green” to “white” for a period of time, these factors may point toward employees’ workload increases resulting in lower performance and more errors.	32:4-9
A situation of overworked personnel in a nuclear plant environment has the potential to contribute to more frequent plant forced outages, derates, and extension of maintenance outages due to personnel errors, failure to notice equipment problems, lack of observance in performing tasks, insufficient time to assess plant operations and tasks, insufficient planning, inopportune unavailability of staff to perform critical tasks and other issues.	34:6-10

Furthermore, OPC's request in this regard is so speculative and unfocused in nature that it begs the question of what relief the Commission should afford OPC even if it did engage in an unwarranted fishing expedition into what the future may hold.¹¹ For this additional reason, the Commission should strike the portions of Mr. Polich's testimony that are speculative or unrelated to the Disputed Outages.

IV.
WITNESS POLICH'S ATTEMPTS TO INVOKE
PROCEDURAL CHANGES VIOLATES COMMISSION RULES

Multiple times in his testimony, witness Polich improperly strays beyond the role of a witness and into the role of legal counsel. Each of his attempts to do so should be struck on the basis that it seeks legal, procedural relief from the Commission typically reserved for requests by legal counsel through formal written motion. Specifically, Mr. Polich:

1. asks the Commission to “establish a ‘spin-off’ docket for the purpose of investigating and fully evaluating FPL’s nuclear operations.” (Polich at 10:7-8).
2. “reserve[s] the right to provide supplemental testimony that addresses any relevant issues related to [the August 2020 Outages, for which, as previously noted, FPL does not seek cost recovery]” and asks the Commission to “allow the record to reopened in a future proceeding.” (Polich at 24:5-11).
3. asks the Commission “to establish a spin-off proceeding to perform an in-depth evaluation of the FPL head count reductions’ impact of nuclear operations” (Polich at 35:6-7).

¹¹ For example, even if the Commission found that morale was low at a given plant or that a certain nuclear culture aspect was lacking, the Commission could not take any action without a direct causal link to an actual event that impacts issues within the Commission's jurisdiction.

4. reserves the right to amend his testimony regarding the calculation of the replacement power costs at issue in this Docket. (Polich at 39 n.8, 41 n.9).
5. implicitly asks the Commission to defer consideration of issues presented in FPL's testimony regarding other outage or derate events.¹² (Polich 42:1-10).

These are not matters of opinion or testimony regarding policy issues. Requesting the initiation of a spin-off docket, the expansion of testimony deadlines set forth in the Commission's Order Establishing Procedure, and the deferral of issues properly before the Commission all constitute requests for legal relief.

Witness Polich's request violates two rules governing administrative procedure. First, pursuant to Rule 28-106.204(1), "all requests for relief *shall* be by motion." Mr. Polich's testimony is not a motion and does not include the requisite content that motions must include.¹³ Second, under Rule 28-106.106(1) "any party who appears in any agency proceeding has the right, at his or her own expense, to be represented by counsel or by a qualified representative." OPC has

¹² Mr. Polich states "I have made an effort to review all of the available material related all outage events, it was not possible for me to discern in every event whether I had all information or that FPL had met its burden to demonstrate that it was reasonable and prudent in all of its actions. My silence on any particular outage does not mean that I have formed an opinion that customers should pay the associated replacement power costs related to those outages. As I have testified above, however, I do believe that the Commission should open a spin-off investigation and review patterns of events that may be inducing customers to pay more in replacement power costs in the fuel factor." It is worth noting that, as described above, OPC had a full and fair opportunity to request information regarding the outages described in FPL witness Curtland's testimony. Aside from Mr. Polich's irrelevant and untrue claims that OPC was "blocked access" to information regarding the August 2020 outages, he makes no (and cannot make any) assertion that FPL failed to respond to propounded discovery. FPL has offered testimony regarding eight outages the Company has placed at issue for an affirmative prudence determination. Witness Polich exacerbates regulatory uncertainty by suggesting that this Commission's prudence review should occur at some undetermined point in time.

¹³ For example, all motions must contain a statement of conferral with the parties.

qualified counsel of record in this proceeding. Mr. Polich is neither OPC's counsel nor its qualified representative.

In short, Rules 28-106.204 and 28-106.106 dictate that, if OPC wants relief from this Commission's procedural orders or other forms of legal relief, its legal (or otherwise qualified representatives) must file the necessary motion. It cannot make the request through Mr. Polich's testimony. On that basis, the testimony associated with Mr. Polich's six legal and procedural requests should be struck.

Conclusion

For all of the reasons explained, the Commission should strike the portions of OPC witness Richard Polich's testimony pertaining to (i) his recommendation for the Commission to initiate an investigation of FPL's nuclear plants and establish a spin-off docket, along with all testimony in support of that recommendation, (ii) the August 2020 outages, for which FPL does not seek cost recovery, (iii) matters that lack causal connection to the Disputed Outages or are based solely on conjecture; and (iv) his attempt to change or reserve procedural rights which must be made by separate motion through counsel. The testimony falling into these four categories is reflected in the highlighted portions of Exhibit A attached to this Motion To Strike.

Conferral

Pursuant to Rule 28-106.204(3), F.A.C., FPL has conferred with counsel for the parties and represents that Duke Energy Florida, Florida Public Utilities Company, Tampa Electric Company, the Florida Industrial Power Users Group, Nucor Steel Florida, Inc. and PCS Phosphate-White Springs take no position. OPC opposes the motion. As of the time this motion is being filed, FPL has not received responses from any other parties to this Docket regarding their position on the relief sought.

WHEREFORE, Florida Power & Light Company respectfully requests that the Commission strike the above-described portions of OPC witness Polich's testimony, which are highlighted in Exhibit A.

Respectfully submitted,

Maria Jose Moncada
Managing Attorney
maria.moncada@fpl.com
David M. Lee
Senior Attorney
david.lee@fpl.com
Florida Power & Light Company
700 Universe Boulevard
Juno Beach, Florida 33408-0420
Telephone: (561) 304-5795
Fax: (561) 691-7135

By: s/ Maria Jose Moncada
Maria Jose Moncada
Florida Bar No. 0773301

CERTIFICATE OF SERVICE
Docket No. 20220001-EI

I **HEREBY CERTIFY** that a true and correct copy of the foregoing has been furnished
by electronic service on this 26th day of September 2022 to the following:

Suzanne Brownless
Ryan Sandy
Division of Legal Services
Florida Public Service Commission
2540 Shumard Oak Blvd.
Tallahassee, Florida 32399-0850
sbrownle@psc.state.fl.us
rsandy@psc.state.fl.us

Paula K. Brown, Manager
Tampa Electric Company
Regulatory Coordinator
Post Office Box 111
Tampa, Florida 33601-0111
regdept@tecoenergy.com

J. Jeffrey Wahlen
Malcolm N. Means
Virginia Ponder
Ausley & McMullen
P.O. Box 391
Tallahassee, Florida 32302
jwahlen@ausley.com
mmeans@ausley.com
vponder@ausley.com
Attorneys for Tampa Electric Company

Michelle D. Napier
Director, Regulatory Affairs Distribution
Florida Public Utilities Company
1635 Meathe Drive
West Palm Beach, FL33411
mnapier@fpuc.com

Richard Gentry
Patricia A. Christensen
Charles J. Rehwinkel
Stephanie Morse
Mary Wessling
Office of Public Counsel
c/o The Florida Legislature
111 West Madison St., Room 812
Tallahassee, FL 32399-1400
gentry.richard@leg.state.fl.us
christensen.patty@leg.state.fl.us
rehwinkel.charles@leg.state.fl.us
morse.stephanie@leg.state.fl.us
wessling.mary@leg.state.fl.us

Robert L. Pickels
Duke Energy Florida
106 East College Avenue, Suite 800
Tallahassee, Florida 32301
robert.pickels@duke-energy.com
FLRegulatoryLegal@duke-energy.com

Dianne M. Triplett
299 First Avenue North
St. Petersburg, Florida 33701
dianne.triplett@duke-energy.com

Matthew R. Bernier
Stephanie A. Cuello
Duke Energy Florida
106 East College Avenue, Suite 800
Tallahassee, Florida 32301
matthew.bernier@duke-energy.com
stephanie.cuello@duke-energy.com
Attorneys for Duke Energy Florida

Mike Cassel
Vice President/Government and
Regulatory Affairs
Florida Public Utilities Company
208 Wildlight Ave.
Yulee, Florida 32097
mcassel@fpuc.com

Beth Keating
Gunster Law Firm
215 South Monroe St., Suite 601
Tallahassee, Florida 32301-1804
bkeating@gunster.com
**Attorneys for Florida Public Utilities
Company**

Jon C. Moyle, Jr.
Moyle Law Firm, P.A.
118 North Gadsden Street
Tallahassee, FL 32301
jmoyle@moylelaw.com
mqualls@moylelaw.com
**Attorneys for Florida Industrial Power
Users Group**

Peter J. Mattheis
Michael K. Lavanga
Joseph R. Briscar
Stone Mattheis Xenopoulos & Brew, PC
1025 Thomas Jefferson Street, NW
Eighth Floor, West Tower
Washington, DC 20007-5201
pjm@smxblaw.com
mkl@smxblaw.com
jrb@smxblaw.com
Attorneys for Nucor Steel Florida, Inc.

James W. Brew
Laura Wynn Baker
Stone Mattheis Xenopoulos & Brew, P.C.
1025 Thomas Jefferson Street, NW
Eighth Floor, West Tower
Washington, DC 20007
jbrew@smxblaw.com
lwb@smxblaw.com
**Attorneys for PCS Phosphate-White
Springs**

Robert Scheffel Wright
John T. LaVia, III
Gardner, Bist, Bowden, Dee
LaVia, Wright, Perry & Harper, P.A.
1300 Thomaswood Drive
Tallahassee, FL 32308
schef@gbwlegal.com
jlavia@gbwlegal.com
**Attorneys for The Florida Retail
Federation**

By: s/ Maria Jose Moncada
Maria Jose Moncada
Florida Bar No. 0773301

EXHIBIT A

BEFORE THE FLORIDA PUBLIC SERVICE COMMISSION

In re: Fuel and purchased power cost recovery
clause with generating performance incentive
factor.

DOCKET NO. 20220001-EI

FILED: September 14, 2022

DIRECT TESTIMONY

OF

RICHARD A. POLICH, P.E. (STATE OF MICHIGAN)

ON BEHALF OF THE CITIZENS OF THE PUBLIC COUNSEL

Richard Gentry
Public Counsel

Charles Rehwinkel
Deputy Public Counsel
Florida Bar No. 527599
Rehwinkel.Charles@leg.state.fl.us

Stephanie Morse
Associate Public Counsel
Florida Bar No. 0068713
Morse.Stephanie@leg.state.fl.us

Office of Public Counsel
c/o The Florida Legislature
111 West Madison Street, Room 812
(850) 488-9330

Attorneys for the Citizens
of the State of Florida

TABLE OF CONTENTS

I. INTRODUCTION	1
II. TESTIMONY SUMMARY.....	7
III. DESCRIPTION OF FPL NUCLEAR POWER PLANTS	10
IV. ST. LUCIE OPERATING HISTORY FOR 2019, 2020 AND 2021.....	13
V. TURKEY POINT OPERATING HISTORY FOR 2019, 2020 AND 2021	15
VI. ST. LUCIE AND TURKEY POINT PERSONNEL REDUCTIONS.....	17
VII. NRC INVESTIGATIONS.....	19
VIII ASSESSMENT OF ST. LUCIE AND TURKEY POINT OPERATIONS.....	31
IX ASSESSMENT OF OUTAGES AND DERATES IMPACT ON REPLACEMENT POWER COSTS.....	35

EXHIBITS

RESUME OF RICHARD A. POLICH, P.E.	RAP-1
LIST OF RICHARD A. POLICH TESTIMONY	RAP-2
COMPOSITE - FPL'S AUGUST 3, 2022 OBJECTIONS TO OPC'S DISCOVERY; FPL'S RESPONSES AND OBJECTIONS TO INT. 16 AND POD 20; AND EXCERPT OF FPL'S APRIL 1, 2022 PETITION	RAP-3
SEPTEMBER 12, 2019 NRC NOTICE OF VIOLATION	RAP-4
APRIL 6, 2021 NRC NOTICE OF VIOLATION	RAP-5
SEPTEMBER 30, 2021 NRC SUPPLEMENTAL INSPECTION REPORT	RAP-6
FPL'S RESPONSE TO OPC INTERROGATORY NOS. 37 - 40	RAP-7
APRIL 15, 2019 NRC INSPECTION REPORT	RAP-8
FEBRUARY 11, 2021 NRC INSPECTION REPORT	RAP-9

PERFORMANCE DATA FOR 2010-2021

RAP-10

TURKEY POINT UNIT 4 ROOT CAUSE EVALUATION RE:

GENERATOR LOCKOUT FROM LOSS OF EXCITER

RAP-11

FPL'S RESPONSE TO STAFF'S INTERROGATORY NO. 4

RAP-12

TURKEY POINT UNIT 4 ROOT CAUSE EVALUATION RE. REACTOR

TRIP DURING RESTORATION FROM RPS TESTING

RAP-13

1 **I. INTRODUCTION**

2 **Q. PLEASE STATE YOUR NAME, TITLE AND BUSINESS ADDRESS.**

3 A. My name is Richard A. Polich. I am a Managing Director at GDS Associates, Inc.
4 (“GDS”). My business address is 1850 Parkway Place, Suite 800, Marietta, Georgia,
5 30067.

6 **Q. WHAT ARE YOUR DUTIES AND RESPONSIBILITIES AT GDS ASSOCIATES?**

7 A. My primary duties are within GDS’s Power Supply Planning Department. While employed
8 by GDS, I have provided consulting services for areas such as:

- 9 • Generation Asset Management,
- 10 • Engineering analysis of generation projects,
- 11 • Engineering evaluation of waste to energy projects,
- 12 • Energy management consulting services,
- 13 • Nuclear decommissioning cost evaluation,
- 14 • Modular nuclear project cost evaluation,
- 15 • Renewable energy project cost assessment and economic evaluation,
- 16 • Testimony on rate of return, cost of service, regulatory disallowances, determination of
- 17 prudence, revenue requirements and plant in service, and
- 18 • Review of generation project design and construction.

19 **Q. MR. POLICH, PLEASE SUMMARIZE YOUR FORMAL EDUCATION.**

20 A. I graduated from the University of Michigan - Ann Arbor in August 1979 with a Bachelor
21 of Science Engineering Degree in Nuclear Engineering and a Bachelor of Science
22 Engineering Degree in Mechanical Engineering.

1 **Q. PLEASE BRIEFLY DESCRIBE YOUR PROFESSIONAL EXPERIENCE.**

2 I have over 40 years of work experience in the energy sector, performing duties and
3 services for a myriad of companies and organizations, and representing the interests of
4 private and public constituencies throughout the country.

5 In May 1978, I joined Commonwealth Associates, Inc., located in Jackson,
6 Michigan, as a Graduate Engineer and worked on several plant modification and new plant
7 construction projects.

8 In May 1979, I joined Consumers Power Inc., (now called Consumers Energy),
9 located in Jackson, Michigan, as an Associate Engineer in the Plant Engineering Services
10 Department.

11 In April 1980, I transferred to the Midland Nuclear Project and progressed through
12 various job classifications to Senior Engineer. I was also part of a small team that evaluated
13 the potential to repower the nuclear steam turbine with combustion turbines. One of my
14 responsibilities was to provide the initial thermal design for the combined cycle project,
15 utilizing one of the two existing nuclear steam turbines while still providing process steam
16 for Dow Chemical Company. This project is now known as the Midland Cogeneration
17 Venture, a 12-combustion turbine and steam turbine project capable of providing 1,633
18 MW of capacity.

19 In July 1987, I transferred to the Market Services Department as a Senior Engineer
20 and reached the level of Senior Market Representative. While in this department, I
21 analyzed the economic and engineering feasibility of customer cogeneration projects.

22 In July 1992, I transferred to the Rates and Regulatory Affairs Department of
23 Consumers Energy as a Principal Rate Analyst. In that capacity, I performed studies

1 relating to all facets of development and design of Consumers Energy's gas, retail, electric
2 and electric wholesale rates. During this period, I was heavily involved in the development
3 of Consumers Energy's Direct Access program and in the development of Consumers
4 Energy's Retail Open Access program. I also participated in the development of
5 Consumers Energy's revenue forecast.

6 In March 1998, I joined Nordic Energy, LLC ("Nordic"), located in Ann Arbor,
7 Michigan, as Vice President in charge of marketing and sales. My responsibilities included
8 all aspects of obtaining new customers and enabling Nordic to supply electricity to those
9 customers. In May 2000, my responsibilities shifted to Operations and Regulatory Affairs
10 and my responsibilities included management of supply purchases, transmission services,
11 and development of new power projects. My Regulatory Affairs responsibilities also
12 included overseeing regulatory and legislative issues for the company.

13 In March 2003, I formed Energy Options & Solutions, based in Ann Arbor,
14 Michigan, as a consulting concern focusing on providing engineering services and
15 regulatory support. Through my work with Energy Options & Solutions, I gained extensive
16 experience consulting in the areas of project development and economic analysis with
17 renewable energy companies across the country, including: Noble Environmental Power
18 located in Centerbrook, Connecticut; Third Planet Windpower, LLC located in Palm Beach
19 Gardens, Florida; TradeWind Energy, LLC located in Lenexa, Kansas; Windlab
20 Developments USA located in Canberra, Australian Capital Territory, Australia; and
21 Matinee Energy Inc. located in Tucson, Arizona, among others.

22 Other examples of my consulting work include evaluation of the Arkansas
23 Weatherization Assistance Program for the Arkansas Energy Office and providing the

1 West Michigan Business Alliance with an evaluation of the business opportunities for
2 Western Michigan businesses in the renewable energy business sector.

3 In 2007, I served as primary author of a report on the economic impacts of
4 renewable portfolio standards and energy efficiency programs for the Department of
5 Environmental Quality – State of Michigan.

6 In 2011, I joined KEMA, Inc. (“KEMA”) located in Burlington, Massachusetts, as
7 a Service Line Leader responsible for developing its renewable energy consulting business.
8 While at KEMA, I performed multiple renewable energy studies for the Electric Power
9 Research Institute, including a renewable energy options study for the country of Sint
10 Maarten (a constituent country of the Kingdom of the Netherlands). I also assisted Lake
11 Erie Energy Development Corporation in its successful application to the U.S. Department
12 of Energy for a multi-million dollar grant to develop an offshore wind project in Lake Erie.

13 In 2013, I joined CLEAResult, located in Little Rock, Arkansas, as Director of
14 Operations. My primary responsibility involved supporting program operations in
15 assisting the company’s Arkansas unit to successfully meet a 400% increase in energy
16 efficiency program goals that it managed for Entergy. I was also responsible for managing
17 the CLEAResult’s natural gas energy efficiency programs in the State of Oklahoma.

18 In 2015, I joined the Georgia office of GDS Associates, Inc., a consulting group
19 focusing on utility engineering and consulting services, as Managing Director.

20 I have been a registered Professional Engineer since 1983 and I am licensed in the
21 State of Michigan.

22 My resume is included as Exhibit No. ___(RAP-1).

1 **Q. HAVE YOU TESTIFIED IN OTHER REGULATORY PROCEEDINGS?**

2 A. Yes, Exhibit No. ___(RAP-2) contains a list of regulatory proceedings in which I have
3 provided testimony.

4 **Q. WHAT IS THE NATURE OF YOUR BUSINESS?**

5 A. GDS is an engineering and consulting firm with offices in Marietta, Georgia; Austin,
6 Texas; Auburn, Alabama; Orlando, Florida; Manchester, New Hampshire; Kirkland,
7 Washington; Portland, Oregon; and Madison, Wisconsin. GDS has over 170 employees
8 with backgrounds in engineering, accounting, management, economics, finance, and
9 statistics. GDS provides rate and regulatory consulting services in the electric, natural gas,
10 water, and telephone utility industries. GDS also provides a variety of other services in the
11 electric utility industry including power supply planning, generation support services,
12 financial analysis, load forecasting, and statistical services. Our clients are primarily
13 publicly owned utilities, municipalities, customers of privately owned utilities, groups or
14 associations of customers, and government agencies.

15 **Q. WHOM DO YOU REPRESENT IN THIS PROCEEDING?**

16 A. I am representing the Florida Office of Public Counsel (“OPC”).

17 **Q. WHAT WAS YOUR ASSIGNMENT IN THIS PROCEEDING?**

18 A. I was asked by the OPC to conduct a review of, and to evaluate Florida Power & Light
19 Company’s (“FPL”) operation of the St Lucie Nuclear Plant (“St Lucie”) and Turkey Point
20 Nuclear Power Plant (“Turkey Point) for the period of 2019 through 2021 and beyond, to
21 evaluate other factors that might be impacting the cost of fuel in the ongoing fuel cost
22 recovery clause dockets. The review and evaluation included assessment of the plant
23 operations which led to several outages and derates (or reductions in the plant’s operating

1 capacity while it remains in operation). My testimony also includes an assessment of
2 replacement power costs impacts for 2019, 2020 and 2021 in which the units at St Lucie
3 and Turkey Point were not available to provide full capacity, and the cost of the
4 replacement power that FPL is seeking to recover from its ratepayers in this proceeding. I
5 was also asked to review the FPL nuclear operations to determine if there were any
6 circumstances and factors that impact the current estimated and projected fuel costs and
7 ongoing fuel costs that are at issue in the current docket.

8 **Q. DID OTHER GDS PERSONNEL ASSIST YOU IN THE ANALYSIS AND**
9 **DEVELOPMENT OF YOUR TESTIMONY IN THIS MATTER?**

10 A. Yes, Megan Morello assisted me with review of documents. Megan Morello is employed
11 by GDS as a Project Manager in the Power Supply department. She has a bachelor's degree
12 in mechanical engineering from Georgia Institute of Technology and is a Registered
13 Professional Engineer in Georgia.

14 **Q. ARE YOU SPONSORING ANY EXHIBITS?**

15 A. Yes, I am sponsoring the following exhibits:

16 1. Exhibit No. ___(RAP-1) Resume of Richard A. Polich, P.E.

17 2. Exhibit No. ___(RAP-2) List of Richard A. Polich Testimony

18 3. Exhibit No. ___(RAP-3) Composite - FPL's August 3, 2022 Objections to OPC's
19 Discovery; FPL's Responses And Objections to INT. 16 and POD 20; and Excerpt
20 of FPL's April 1, 2022 Petition

21 4. Exhibit No. ___(RAP-4) September 12, 2019 NRC Notice Of Violation

22 5. Exhibit No. ___(RAP-5) April 6 2021 NRC Notice of Violation

23 6. Exhibit No. ___(RAP-6) September 30, 2021 NRC Supplemental Inspection
24 Report

25 7. Exhibit No. ___(RAP-7) FPL's Response to OPC Interrogatory Nos. 37 – 40

- 1 8. Exhibit No. ___ (RAP-8) April 15, 2019 NRC Inspection Report
- 2 9. Exhibit No. ___ (RAP-9) February 11, 2021 NRC Inspection Report
- 3 10. Exhibit No. ___ (RAP-10) Performance Data For 2010-2021
- 4 11. Exhibit No. ___ (RAP-11) Turkey Point Unit 4 Root Cause Evaluation Re:
- 5 Generator Lockout from Loss of Exciter
- 6 12. Exhibit No. ___ (RAP-12) FPL’s Response To Staff’s Interrogatory No. 4
- 7 13. Exhibit No. ___ (RAP-13) Turkey Point Unit 4 Root Cause Evaluation Re. Reactor
- 8 Trip During Restoration From Rps Testing

9 **II. TESTIMONY SUMMARY**

10 **Q. PLEASE SUMMARIZE YOUR TESTIMONY.**

11 A. I have identified concerns with the staffing, culture and operations at the four nuclear units
12 of FPL that need to be investigated by the Florida Public Service Commission
13 (“Commission”) as these issues affect past, current and future fuel costs paid by FPL
14 customers. Market forces over the last decade have placed significant cost reduction
15 pressure on regulated and merchant nuclear plant owners alike because of the need to be
16 competitive with combined cycle power generation using cheap natural gas fuel. Although
17 this phenomenon has abated somewhat in the last two years with the recent large price
18 increases in the natural gas market, the impact on nuclear plant operations is already in
19 place. Nuclear power generation is a valuable carbon-free power generation resource that
20 is critical to achieving carbon emission reduction goals for many utilities. It is critical that
21 utilities operating nuclear power facilities maintain sufficient operational resources to
22 safely and properly operate these facilities.

23 Review of operations at FPL’s St Lucie and Turkey Point facilities over the last
24 three years indicates that there has been an increased frequency of outage and derate hours

1 that have resulted in avoidable (and potentially avoidable) replacement power costs. Since
2 2017 FPL has reduced budgeted personnel headcount at St. Lucie by 24.7% and Turkey
3 Point by 25.2%. Actual head count at the plant sites has been reduced by 28.0% at St. Lucie
4 and 22.3% at Turkey Point.

5 Reductions in personnel alone are not necessarily a red flag in the assessment of
6 nuclear plant operations. However, there have been a series of instances at St. Lucie and
7 Turkey Point over recent years which are indicative of potential problems and which call
8 into question whether force reductions during times of frozen base rates are in the best
9 interests of customers who pay for replacement power in the event of outages.

10 The events that I believe have a bearing on the outages in this case have occurred
11 of the past 5 years and indicate a set of circumstances that may be continuing to impact
12 FPL's operations and ongoing fuel costs when viewed in connection with the workforce
13 trends. Several events will be discussed. In one instance, for example, the United States
14 Nuclear Regulatory Commission ("NRC") determined that FPL's Regional Vice President
15 (VP) – Operations, deliberately caused a contract employee's assignment to be cancelled
16 the week of March 13, 2017 because the employee raised a nuclear safety concern via the
17 submission of a condition report. The NRC determined that the deliberate actions of the
18 now former FPL Regional VP - Operations caused FPL to be in violation of 10 C.F.R. §
19 50.7, which is significant because of the potential that individuals might not raise safety
20 issues for fear of retaliation; the NRC also assessed a civil penalty of \$232,000 for a
21 Severity Level II violation.

22 In another instance, at Turkey Point, three FPL employees (mechanics) falsified
23 information on work orders in January 2019 (see Exhibit No. ____ (RAP-4)). In July 2019,

1 two FPL Instrumentation and Control (I&C) technicians at Turkey Point deliberately
2 provided incomplete or inaccurate information in maintenance records and the FPL I&C
3 technicians, an FPL I&C Supervisor, and the FPL I&C Department Head deliberately
4 failed to immediately notify the main control room of a mispositioned plant component, as
5 required by plant procedures. The NRC investigation into these three apparent violations
6 resulted in a Notice of Violation and a proposed civil penalty of \$150,000 (see Exhibit No.
7 ____ (RAP-5)).

8 The NRC also determined that in the first quarter of 2021, review of Turkey Point
9 performance indicated that unplanned reactor scrams¹ exceed the Unplanned Scrams per
10 7000 Critical Hours performance indicator, resulting in a performance rating downgrade
11 from green to white (see Exhibit No. ____ (RAP-4)).

12 These events, coupled with decreased headcount and increased outage and derate
13 hours, are a potential indication of a deficient nuclear operations culture at St. Lucie and
14 Turkey Point facilities. FPL's overall effort at reducing operational costs through personnel
15 reductions has the potential to cause stress to be placed on personnel to do more with less.
16 In turn, mistakes can result and lead to avoidable outages and increased, imprudent fuel
17 costs for customers. My review of the cause of plant outages indicates that lower head
18 count may be contributing to lower plant performance. I recommend the Commission
19 disallow fuel cost recovery associated with several derates and outages, in the amount of
20 at least \$2, 660,713.

21 In my testimony I have also taken a more holistic look at the circumstances that
22 may be impacting the ongoing costs of fuel needed to replace the output of the four FPL

¹ As defined and described in Section VII of my testimony.

1 nuclear units when they are unavailable. This effort indicates that FPL customers may be
2 paying excessive costs of replacement power in 2022 and 2023. This wider view of FPL's
3 nuclear operations involved an evaluation of factors and operational conditions as
4 mentioned above and discussed below that may be having an ongoing impact on the
5 replacement power costs of FPL that are at issue in the current docket and in the ongoing
6 recovery of fuel costs to be recovered in the future. Because of the continuum of past,
7 current, and future fuels costs, I am recommending that the Commission establish a "spin-
8 off" docket for the purpose of investigating and fully evaluating FPL's nuclear operations
9 as it is impacting fuel costs in general, in addition to making certain disallowances for
10 imprudence on FPL's part in operating their nuclear units. This spin-off docket should
11 review FPL's nuclear operations and at least consider whether they are negatively
12 impacting customers' fuel rates.

13
14 **III. DESCRIPTION OF FPL NUCLEAR POWER PLANTS**

15 **Q. PLEASE PROVIDE A GENERAL DESCRIPTION OF THE PLANT ST. LUCIE**
16 **NUCLEAR GENERATING STATION.**

17 A. Plant St. Lucie Nuclear Plant ("St. Lucie") has two separate pressurized water reactor
18 ("PWR") nuclear units, capable of a net electrical output of about 981 MW for Unit 1 and
19 987 MW for Unit 2². The nuclear steam supply system was designed by Combustion
20 Engineering and provide steam to Westinghouse steam turbine-generators. Unit 1 entered
21 commercial operation in December 1976 and Unit 2 entered commercial operation in

² This capacity is based on FPL capacity contained in FPL GPIF reports.

1 August 1983. The current Nuclear Operating License for Unit 1 expires in March 2036 and
2 Unit 2's license expires in April 2043.

3 **Q. PLEASE PROVIDE A GENERAL DESCRIPTION OF THE TURKEY POINT**
4 **NUCLEAR UNITS.**

5 A. Turkey Point has two separate PWR nuclear units, capable of a net electrical output of at
6 least 837 MW for Unit 3 and 821 MW for Unit 4.³ The nuclear steam supply system was
7 designed by Westinghouse and provides steam to Westinghouse steam turbine-generators.
8 Unit 3 entered commercial operation in December 1972 and Unit 4 entered commercial
9 operation in September 1973. The NRC had initially approved Turkey Point's Nuclear
10 Operating License extension in 2019, but on February 24, 2022 the NRC reversed the
11 extension for further environmental impact review. The current Nuclear Operating
12 Licenses expire in 2032 for Unit 3 and 2033 for Unit 4.

13 **Q. WHAT PLANT OPERATING FACTORS ARE AN INDICATION OF A PLANTS**
14 **RELIABILITY PERFORMANCE?**

15 A. There are five factors contained in the GPIF reports that FPL files with the Commission
16 that contains indicators of overall plant reliability performance:

- 17 1. Equivalent Availability Factor (EAF): The fraction of a given operating period in
18 which a generating unit is available without any outages or equipment deratings.

19
$$EAF = \frac{\text{Period Hours} - \text{Sum of (FOH, PFOH, POH, PPOH)}}{\text{Period Hours}}$$

- 20 2. Forced Outage Hours (FOH): Hours in which a plant is in a forced outage.

- 21 3. Partial Forced Outage Hours (PFOH): Calculation of equivalent forced outage
22 hours when a plant is forced to derate.

³ *Ibid.*

1
2
3
4
5
6
7
8
9
10
11
12
13
14
15
16

$$PFOH = \frac{\text{Forced Derate Hours} \times \text{Derate MW}}{\text{Maximum MW Capacity}}$$

- 4. Effective Forced Outage Rate: Percent of yearly hours plant is in forced outage or forced derate.
- 5. Planned Outage Hours (POH): This is the number of hours a plant is in a planned outage. Planned outages are usually scheduled well in advance of the outage.
- 6. Partial Planned Outage Hours (PPOH): Calculation of equivalent planned outage hours when a plant is in a planned derate.

$$PFOH = \frac{\text{Planned Derate Hours} \times \text{Derate MW}}{\text{Maximum MW Capacity}}$$

- 7. Capacity Factor (CF): The ratio, for the period of time considered, of (a) the electrical energy produced by a generating unit to (b) the electrical energy that could have been produced at continuous full power operation during the same period.

The Generation Performance Incentive Factor (“GPIF”) report that FPL files monthly and annually with the Commission combines FOH and PFOH into a single reported metric, as it does for the POH and PPOH. EAF should be calculated using the sum of FOH, PFOH, POH, and PPOH hours.

1 **Q. PLEASE DESCRIBE THE BASIS FOR COLOR CODING OF THE**
 2 **PERFORMANCE FACTORS IN Tables 1-5 and Exhibit 10.**

3 **A.** I color coded the plant performance factor to illustrate periods of concern as follows:

EAF Performance Factor		EFOR Performance Factor	
>95%		<3.0%	
90% - 95%		3.0% - 5.0%	
85% - 90%		>5.0%	
80% - 85%			
<80%			

8 **IV. ST. LUCIE OPERATING HISTORY FOR 2019, 2020 AND 2021**

9 **Q. HAVE YOU REVIEWED THE OPERATING HISTORY FOR ST. LUCIE, AS IT**
 10 **RELATES TO THE FIVE GPIF PERFORMANCE FACTORS?**

11 **A.** Yes, I have reviewed the GPIF reports produced by FPL since 2010 relating to St. Lucie.

12 **Q. PLEASE DESCRIBE THE OPERATING HISTORY OF THE ST. LUCIE UNIT 1**
 13 **OVER THE 2017 – 2021 PERIOD.**

14 **A.** Table 1 presents the GPIF Report five performance factors for St. Lucie Unit 1 for the
 15 period of 2017 – 2021. The data in the table indicates St. Lucie Unit 1's 2019 plant

LINE	St. Lucie 1	2017	2018	2019	2020	2021
1	EAF	97.4%	90.8%	70.1%	99.8%	88.6%
2	FOH + PFOH	246.7	74.5	1,810.1	12.8	153.7
3	EFOR %	2.8%	0.9%	20.7%	0.1%	1.8%
4	POH + PPOH	8.6	809.4	888.2	6.3	840.8
5	Capacity Factor	99.1%	92.2%	71.3%	101.3%	89.8%

Table 1 - St. Lucie Unit 1 Performance Factors

16 performance was poor, and below average in 2021. The poor performance in 2019 was due
 17 to a generator ground fault in April 2019 which resulted in 1,360 forced outage hours and
 18 a reactor coolant pump ground fault in September 2019 which resulted in 351 forced outage

1 hours. The below average performance in 2021 was due to a spring refueling outage which
 2 lasted 816 hours, 93.5 hours more than originally planned.

3 **Q. HOW DOES ST. LUCIE UNIT 2'S PERFORMANCE COMPARE TO THAT OF**
 4 **UNIT 1 OVER THE 2017 – 2021 PERIOD?**

5 **A.** Table 2 presents the GPIF report five performance factors for St Lucie Unit 2 on the same
 6 basis for the period of 2017 - 2019. St Lucie Unit 2 had below average performance in

LINE	St. Lucie 2	2017	2018	2019	2020	2021
1	EAF	89.7%	87.8%	100.0%	91.1%	89.5%
2	FOH + PFOH	110.2	252.2	-	60.0	90.6
3	EFOR %	1.3%	2.9%	0.0%	0.7%	1.0%
4	POH + PPOH	884.5	873.5	0.7	721.3	827.2
5	Capacity Factor	91.7%	88.6%	102.7%	93.2%	91.5%

Table 2 - St Lucie Unit 2 Performance Factors

7 2017 due to planned maintenance and a turbine control system fault. The below average
 8 performance in 2018 was due to an extended planned refueling maintenance outage which
 9 totaled about 930 hours between the planned and forced portions of the outage and a forced
 10 outage due to a 6.9 kV bus fault which lasted approximately 140 hours. The below average
 11 performance in 2021 was due to an 830 hour refueling maintenance outage that was
 12 extended at derated load for 46.1 hours more than originally planned. As compared to Unit
 13 1, Unit 2's overall performance was better than Unit 1's for that same period.

1 **V. TURKEY POINT OPERATING HISTORY FOR 2019, 2020 AND 2021**

2 **Q. HAVE YOU REVIEWED THE OPERATING HISTORY FOR TURKEY POINT'S**
3 **NUCLEAR UNITS, AS IT RELATES TO THE FIVE GPIF PERFORMANCE**
4 **FACTORS?**

5 **A.** Yes, I have reviewed the GPIF reports produced by FPL since 2010 related to the nuclear
6 units at Turkey Point.

7 **Q. PLEASE DESCRIBE THE OPERATING HISTORY OF THE TURKEY POINT**
8 **UNIT 3 OVER THE 2017 – 2021 PERIOD.**

9 **A.** Table 3 presents the GPIF report five performance factors for Turkey Point Unit 3 for the
10 period of 2017 - 2019. Turkey Point Unit 3's performance factors were below average in

LINE	Turkey Point 3	2017	2018	2019	2020	2021
1	EAF	85.2%	88.6%	99.1%	85.3%	84.0%
2	FOH + PFOH	407.6	1.6	84.5	535.2	658.3
3	EFOR %	4.7%	0.0%	1.0%	6.1%	7.5%
4	POH + PPOH	906.2	1,001.0	-	681.8	743.9
5	Capacity Factor	86.9%	90.6%	102.8%	89.3%	86.3%

Table 3 -- Turkey Point Unit 3 Performance Factors

11 2017 and 2018 based on EAF, and poor in 2020 and 2021 due to the high forced outage
12 rate. In 2017, Turkey Point had three forced outages near or over 100 hours (totaling almost
13 400 hours), two of which were caused by reactor coolant pump problems and one was
14 associated with a 4 kV buss failure. In 2018, a longer than normal refueling outage of 949
15 hours caused the lower EAF. In 2020, the Unit experienced three forced outages and eight
16 (8) significant separate plant derates which caused an excessive forced outage rate and
17 535.2 equivalent forced outage hours. In 2021, Turkey Point Unit 3 had two forced outages,
18 including the over 300-plus hour refueling outage extension, that was 328.4 hours beyond

1 the planned outage duration and six (6) plant derates, which caused an excessive forced
2 outage rate.

3 **Q. HOW DOES TURKEY POINT UNIT 4'S PERFORMANCE COMPARE TO THAT**
4 **OF UNIT 3 OVER THE 2017 – 2021 PERIOD, AS IT RELATES TO THE FIVE**
5 **GPIF PERFORMANCE FACTORS?**

6 **A.** Table 4 presents the GPIF five performance factors for St Lucie Unit 2 on the same basis
7 for the period of 2017 - 2019. Turkey Point Unit 4's performance factors were below

LINE	Turkey Point 4	2017	2018	2019	2020	2021
1	EAF	89.5%	99.6%	90.6%	83.0%	99.5%
2	FOH + PFOH	213.4	3.1	10.0	494.2	49.2
3	EFOR %	2.4%	0.0%	0.1%	5.6%	0.6%
4	POH + PPOH	705.7	28.1	815.5	1,001.2	-
5	Capacity Factor	91.2%	101.4%	91.9%	84.3%	102.7%

Table 4 - Turkey Point Unit 4 Performance Factors

8 average in 2017 and poor in 2020. In 2017, a 141-hour forced outage due to flow control
9 valve failure, a planned maintenance outage and several derates contributed to the low
10 EAF. In 2020, a 365 equivalent hour forced outage due the exciter failure, a 130 hour forced
11 outage due to extension of a maintenance outage, and four plant derates contributed to
12 below average EAF and an excessive outage rate.

13 **Q. YOU HAVE MENTIONED HEAD COUNT REDUCTIONS AT THE ST. LUCIE**
14 **AND TURKEY POINT NUCLEAR PLANT SITES. CAN YOU GIVE A BRIEF**
15 **EXPLANATION WHY YOU ARE PROVIDING TESTIMONY ON THIS ASPECT**
16 **OF THE FPL OPERATIONS?**

17 **A.** Yes. As I was evaluating the outages and reviewing the documentation provided by FPL
18 (and available from the NRC), I became concerned that industry cost trends, market forces
19 and other corporate culture issues could be driving the company to cut costs in its nuclear

1 operations in a way that could impact customer fuel rates. For this reason, I sought to
2 understand whether staffing levels had changed, and I asked the OPC to serve discovery in
3 this area.

4 **VI. ST. LUCIE AND TURKEY POINT PERSONNEL REDUCTIONS**

5 **Q. WHAT HAVE YOU LEARNED ABOUT CHANGES FPL HAS MADE IN**
6 **PERSONNEL HEAD COUNT SINCE 2017 AT ST. LUCIE?**

7 **A.** In January 2017, the St. Lucie station's (encompassing Units 1 & 2) actual head count for
8 that month was 636, and its budgeted head count was 649. Based on data provided by FPL
9 in response to OPC's Interrogatory Nos. 39 and 40, Attachment 1 (Exhibit No. ____ (RAP
10 7)), St. Lucie's head count had fallen to 458 by the end of 2021 and the budgeted head
11 count had fallen to 489. This represents a 28.9% reduction in actual head count and a 24.7%
12 reduction in budgeted head count. St. Lucie has experienced a reduction of 178 people

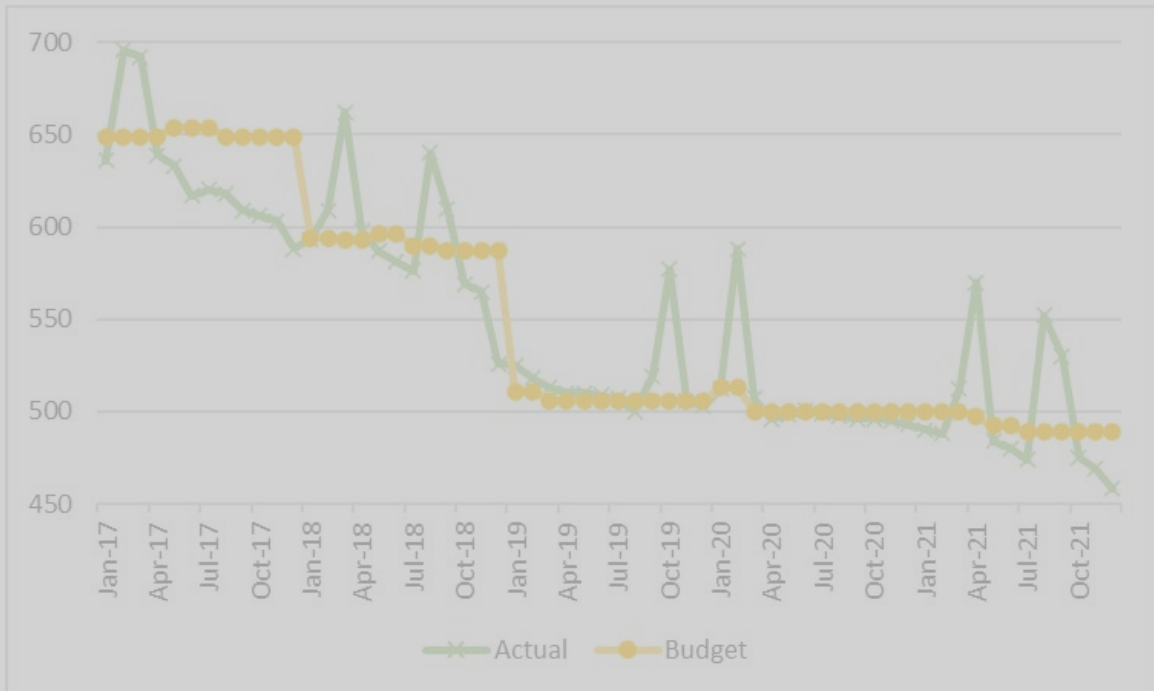

Figure 1- St. Lucie Head Count

1 since 2017 and FPL has dropped the budgeted headcount by 160 people. Considering this
 2 is a two-unit plant, there are currently only an average of 229 people per unit on site or
 3 available to the unit. Figure 1 presents a graph of the monthly changes in St. Lucie' actual
 4 and budgeted headcount since 2017.

5 **Q. WHAT HAVE YOU LEARNED ABOUT CHANGES FPL HAS MADE IN**
 6 **PERSONNEL HEAD COUNT SINCE 2017 AT TURKEY POINT?**

7 **A.** In January 2017, the Turkey Point nuclear plant (encompassing both Units (3 &4), actual
 8 head count for that month was 613, and its budgeted head count was 644. Based on data
 9 provided by FPL in response to OPC's Interrogatory Nos. 37 and 38, Attachment 1 (Exhibit
 10 No. ___(RAP 7)), Turkey Point's head count had fallen to 476 by the end of 2021 and the
 11 budgeted head count had fallen to 485. This represents a 22.3% reduction in actual head

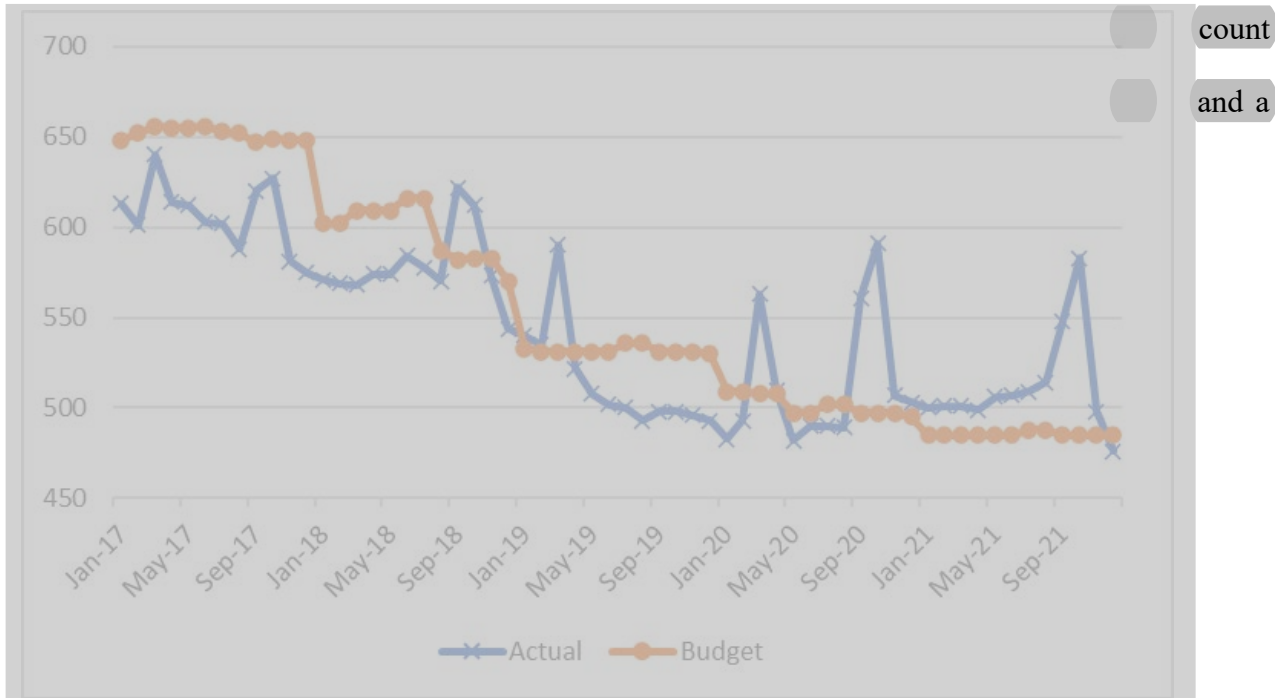

Figure 2- Turkey Point Head Count

14 25.2% reduction in budgeted head count. Turkey Point has experienced a reduction of 137
 15 people since January 2017 and FPL has dropped the budgeted headcount by 163 people.

1 Considering this is a two-unit plant, there are currently only an average of 238 people per
2 unit on site or available to the unit. Figure 2 presents a graph of the monthly changes in
3 Turkey Point's actual and budgeted headcount since 2017.

4 **VII. NRC INVESTIGATIONS**

5 **Q. YOU HAVE MENTIONED INSTANCES OF NRC INVESTIGATIONS AND CIVIL**
6 **PENALTIES RELATED TO THE FPL OPERATIONS AT ST. LUCIE AND**
7 **TURKEY POINT. CAN YOU BRIEFLY EXPLAIN WHY YOU HAVE PROVIDED**
8 **TESTIMONY ON THIS ASPECT OF FPL'S NUCLEAR OPERATIONS?**

9 A. Yes. As a part of my inquiry in this case, I looked at the evidence of outages over recent
10 years and also evaluated staffing levels as indicated above. I believe that, in addition to
11 these aspects of the operations, an important indicator of the prudence of the operations of
12 the organization is how the company is viewed by the safety regulator who has special
13 insight into the operations based on its access to the nuclear plants and its role in protecting
14 the safety of Americans, its presence on-site, and its access to all aspects of FPL's nuclear
15 operations. For this reason, I reviewed the recent history of NRC inspections and violation
16 findings at the four plant sites. I present a summary of this review below as it bears on the
17 recent past, the present and the future of fuel costs borne by FPL customers.

18

1 **Q. PLEASE DESCRIBE THE MARCH 13, 2017 INCIDENT THAT LED TO THE NRC**
2 **ISSUING THE SEPTEMBER 12, 2019 NOTICE OF VIOLATION AND**
3 **IMPOSITION OF A \$232,000 CIVIL PENALTY (EXHIBIT NO. ___ (RAP-4)).**

4 **A.** On March 13, 2017, an employee of FPL contractor Framatome (formerly known as
5 AREVA) submitted a condition report to FPL management, documenting concerns with
6 the requirement for Framatome personnel to wear multiple dosimeters while performing
7 refueling work. Framatome was a contractor to FPL for refueling work at both the St. Lucie
8 and Turkey Point. The contract employee was a lead supervisor for Framatome's refueling
9 team at St. Lucie, and had been pre-scheduled by Framatome and FPL to transfer to Turkey
10 Point for the same role. On March 16, 2017, the contract employee's re-assignment to
11 Turkey Point was canceled due to actions by FPL's Regional Vice President (VP) –
12 Operations. The NRC determined that the cancellation of the contract employee's work
13 assignment for raising a nuclear safety concern via the submission of a condition report
14 was a violation of 10 C.F.R. § 50.7 (See Exhibit No. ___ (RAP-4), page 2, first paragraph).

15 The U.S. Nuclear Regulatory Commission (NRC) Office of Investigations (OI)
16 documented that FPL's Regional VP - Operations sent an e-mail to the Framatome VP of
17 Outage Services on March 14, 2017, and in subsequent discussions, requested cancellation
18 of the employee's Turkey Point assignment. The NRC investigation found the FPL
19 Regional Vice President - Operations deliberately discriminated against a Framatome
20 contract employee for engaging in a protected activity in March of 2017. In addition,
21 evidence was found that a former FPL Corporate Support Vice President, whose previous
22 position was FPL Regional VP-Operations (discussed above), deliberately provided

1 incomplete and inaccurate information to FPL that was subsequently submitted by FPL to
2 the NRC.

3 The NRC determined this was a Severity Level II violation of 10 C.F.R. §.50.7 and
4 imposed the \$232,000 civil penalty on FPL. As a result of this instance, FPL agreed to
5 perform the following corrective actions:

6 1. Establish an Employee Concerns Program (ECP) investigation and
7 Safety Conscious Work Environment (“SCWE”) surveys in St.
8 Lucie and Turkey Point radiation protection departments, and
9 training of senior nuclear managers.

10 2. Conduct a nuclear fleet-wide communication that reinforced the
11 SCWE policy.

12 3. Conduct personnel training, ECP third-party audits, and create a
13 personnel action review board to review certain employment actions
14 involving contractor personnel brought to FPL’s attention.

15 **Q. ARE YOU AWARE OF THE TURKEY POINT UNIT 3 OUTAGES THAT**
16 **OCCURRED IN AUGUST 2020 FOR WHICH FPL IS NOT SEEKING COST**
17 **RECOVERY?**

18 **A.** Yes. I am aware of this situation, but FPL has blocked me from reviewing their records
19 containing details of these events and from understanding the basis for their decision to
20 exclude the replacement power costs from recovery in the Fuel Clause docket.⁴ I have
21 included in my testimony information related to these events from the publicly available

⁴ See, FPL’s April 2, 2022 *Petition for Approval of Fuel Cost Recovery and Capacity Cost Recovery Net Final True-Ups for the Period Ending December 2021 and 2021 Asset Optimization Incentive Mechanism Results*, Docket No. 2022001-EI.

1 files of the NRC, but I have not been able to determine the reasons why FPL is not asking
2 the Commission to include these costs for recovery. I would note that the Company
3 included a brief description of certain of the events in the September 3, 2020 testimony of
4 Robert Coffey, Vice President, Nuclear in the FPL Nuclear Business Unit in Docket
5 20200001-EI. In conjunction with his testimony supporting the recovery of all 2020 fuel
6 costs, Mr. Coffey testified at TR 409 this way:

7 In March 2020, St. Lucie Unit 2 experienced a delay in return to
8 service following the refueling outage associated with the planned
9 replacement of a 6900 volt electrical switchgear required for plant
10 operation; in July 2020, Turkey Point Unit 4 shut down due to a
11 main generator lock out from a loss of exciter and in August 2020,
12 Turkey Point Unit 3 shut down in response to rising steam generator
13 levels. ***FPL's response to each unplanned outage was appropriate
14 and efficient, and the units were returned to service safely.***

15 (Emphasis added.) In the 2020 Fuel Clause hearing, FPL lumped several outages together
16 in this testimony and described to the Commission under oath that their response to the
17 outages were appropriate and efficient. After FPL tried to block OPC counsel from
18 inquiring about the outages (TR 506, lines 12-15), the Commission allowed some very
19 limited explanation of related matters. TR 507-520; 526-527. These outage prudence
20 determinations were deferred from the 2021 fuel cycle hearings into this current round.
21 The exciter-related outage described above is contested in this case, while FPL has
22 indicated that it wants to refund the replacement power costs it was allowed to collect while
23 avoiding oversight of the reasons for the proposed refund.
24

1 **Q. IF FPL IS NOT SEEKING RECOVERY OF REPLACEMENT POWER COSTS,**
2 **THEN WHY DO YOU NEED TO SEE THE INFORMATION?**

3 **A.** The customers and the Commission should have an understanding about FPL's decision-
4 making with regard to what fuel costs they submit for recovery as being prudent. One
5 would assume that, given its duty to its shareholders, FPL has an obligation to recover in
6 the ratemaking process all costs that are reasonably and prudently incurred. FPL originally
7 took steps to recover these costs in 2020 and now appears to be trying to evade regulatory
8 oversight by refunding the money. The company refuses to state why it no longer seeks
9 recovery for these replacement power costs; whether because they were incurred due to
10 some imprudent action or decision-making by the company or because the company
11 received cost reimbursement from a vendor or an insurance company (Exhibit No.
12 ____ (RAP-3)). The customers and the Commission should be allowed to inquire as to the
13 circumstances of any imprudence in FPL's actions or decision-making for any one of
14 several reasons. If actions occurred associated with these events are indicative of a pattern
15 of activity within the FPL nuclear organization that is related to staffing levels or to the
16 corporate culture that has been at issue in recent NRC violation notices, those facts are also
17 relevant to this case. Likewise, if the actions related to these events are similar to other
18 events at issue and discussed in my testimony, then it begs the question as to why the
19 related replacement costs for any one event are to not be recovered while all other
20 replacement power costs related to the outages I have discussed continue to be sought in
21 the Fuel Clause. Said a different way, what if the facts that prompted FPL *not* to seek
22 recovery are the same or similar to factual scenarios under which FPL is seeking recovery
23 for other incidents? Additionally, if there is third party cost reimbursement, the customers

1 and Commission are entitled to know the circumstances so that the parties can understand
2 whether FPL is properly and prudently pursuing recovery from third parties in all instances
3 where vendors or an insurance company may be obligated to compensate FPL; and if not,
4 why not?

5 **Q. WHAT DO YOU RECOMMEND WITH REGARD TO THESE EVENTS?**

6 A. Given that I have not seen the information, I reserve the right to provide supplemental
7 testimony that addresses any relevant issues related to these events. Furthermore, to the
8 extent that discovery of information related to these events has a bearing on any aspect of
9 my testimony – including any contrasts with contested claims of prudent replacement
10 power cost – the Commission should allow the record to be reopened in a future
11 proceeding, including but not limited to any spin-off investigation docket.

12 **Q. PLEASE DESCRIBE THE INCIDENTS THAT LED TO THE NRC ISSUING THE**
13 **APRIL 6, 2021 NOTICE OF VIOLATION AND IMPOSITION OF A \$150,000**
14 **CIVIL PENALTY (EXHIBIT NO. ___ (RAP-5)).**

15 A. On April 6, 2021 the NRC issued a Notice of Violation and Civil Penalty related to three
16 instances where FPL employees at Turkey Point falsified information, and/or provided
17 inaccurate or incomplete information in maintenance records. The first incident occurred
18 on July 10, 2019 when FPL mechanics falsified maintenance records on a work order,
19 falsely stating maintenance activities associated with a *safety-related* check valve had been
20 completed. They also recorded inaccurate information on the status of tools that were
21 required (but not used) for conducting the maintenance work (that was not actually
22 performed). The FPL employees also recorded inaccurate measurements using falsified
23 values, copied from a prior actual performance of the work.

1 A second and third incident occurred on November 10, 2021, in which FPL I&C
2 technicians, an FPL I&C Supervisor, and the FPL I&C Department Head deliberately
3 failed to immediately notify the main control room of a mispositioned plant component, as
4 required by plant procedures. These two incidents involved failure to comply with plant
5 procedures to notify the control room of a mispositioned component and failure to maintain
6 accurate and complete maintenance records. The NRC determined that all three incidents
7 involved deliberate misconduct by FPL employees, which was a Severity Level III
8 violation and assessed a \$150,000 civil penalty on FPL.

9 **Q. PLEASE DESCRIBE THE REASONS FOR THE NRC TO DOWNGRADE**
10 **TURKEY POINT UNIT 3's PERFORMANCE INDICATOR FROM GREEN TO**
11 **WHITE IN MAY 2021 (SEE EXHIBIT NO. __ (RAP-6)).**

12 **A.** As part of the NRC's Reactor Oversight Process, the agency monitors the number of
13 unplanned scrams per 7,000 hours of operation. An unplanned scram is an emergency
14 shutdown of the nuclear reactor by rapid insertion of the control rods that will initiate
15 termination of the fission process in the reactor. It is also known as a reactor trip. An
16 unplanned reactor scram puts the reactor safety systems under additional stress because of
17 the rapid change in plant stability and the various systems that need to respond to plant
18 transients. The NRC uses the categories shown in Table 5 to define plant performance level
19 associated with the unplanned scrams per 7,000 hours:

Performance Indicator	Unplanned Scrams per 7,000 Hours
Green	≤ 3 Scrams
White	4-6 Scrams
Yellow	7-25 Scrams
Red	>25 Scrams

20 *Table 5 - NRC Unplanned Scrams Performance Indicators*

1 The NRC downgraded Turkey point Unit 3's Unplanned scrams in a 7,000 Critical Hours
2 performance indicator to white due to four unplanned scrams between August 2020 and
3 March 2021.

4 **Q. WHAT IS THE SIGNIFICANCE OF THIS DOWNGRADE?**

5 A. The NRC uses the measurement of the number of Unplanned Scrams in a 7,000 Critical
6 Hours performance indicator to flag nuclear plants which may be having operational
7 problems. An unplanned reactor scram results in very rapid changes in the nuclear plant
8 operating conditions and forces the plant nuclear safety systems to respond to those
9 operating condition changes in a short period. In addition to the extra cost of replacement
10 power during the outage triggered by the event, the more frequently a nuclear plant
11 unplanned scram occurs, the higher the potential for a safety component or system to fail,
12 causing additional problems, including exposing customers to higher fuel costs in the
13 future. An example of problems that can occur during an unplanned scram occurred at the
14 Browns Ferry Nuclear plant in 1980 when 40% of the control rods failed to fully insert into
15 the reactor core. In that situation, two additional scrams were required to fully insert the
16 control rods.⁵

17 **Q. PLEASE DESCRIBE THE FIRST OF THE FOUR UNPLANNED REACTOR**
18 **SCRAM EVENTS THAT OCCURRED BETWEEN AUGUST 2020 AND MARCH**
19 **2021.**

20 A. The first event occurred on August 17, 2020, and was a manual trip by plant operators due
21 to rising steam generator levels that were approaching the automatic turbine trip setpoint.
22 The cause was an inadvertent opening of a low-pressure heater bypass valve in response to

⁵ AEOD/C001, "Report on the Browns Ferry 3 Partial Failure to Scram Event on June 28, 1980," Office for Analysis and Evaluation of Operational Data, U.S. Nuclear Regulatory Commission, July 30, 1980. [8008140575]

1 low-pressure at the suction of the steam generator feedwater pump (SGFP). Investigation
2 by FPL found a design modification in 2012 had not included this scenario in the turbine
3 control system design analysis. Because I have been blocked from accessing and
4 independently reviewing the FPL internal documents related to this event, I am unable to
5 determine the nature of any human element (FPL employee or contractor) related to the
6 prudence of this event as it relates to or affects the recovery of fuel costs.

7 **Q. PLEASE DESCRIBE THE SECOND OF THE FOUR UNPLANNED REACTOR**
8 **SCRAM EVENTS THAT OCCURRED BETWEEN AUGUST 2020 AND MARCH**
9 **2021.**

10 A. The second event occurred on August 19, 2020 (two days after the first event), and was an
11 automatic trip by the plant's reactor protection system during startup, caused by high
12 neutron flux condition in the reactor. According to the NRC, *FPL's own root cause*
13 *evaluation determined this was operator error committed by an FPL employee.* The FPL
14 unit supervisor and FPL reactor plant operators were determined to have had knowledge
15 gaps in conducting reactor startup operations. As a result of the discovery of knowledge
16 gaps among its employees, FPL had to make procedural and training material changes for
17 plant operators and supervisors. Because I have been blocked from accessing and
18 independently reviewing the FPL internal documents related to this event, I am unable to
19 fully formulate an opinion about this event as it relates to the prudence of FPL's culture,
20 workforce staffing or other aspects of prudence as it relates to or affects the recovery of
21 fuel costs.

1 **Q. PLEASE DESCRIBE THE THIRD OF THE FOUR UNPLANNED REACTOR**
2 **SCRAM EVENTS THAT OCCURRED BETWEEN AUGUST 2020 AND MARCH**
3 **2021.**

4 **A.** The third event that occurred on August 20, 2020, the day after the second event occurred,
5 was caused by improper valve alignment of the pump suction flow control valve and failure
6 to place the recirculation to condenser control valves in automatic. According to the NRC,
7 *FPL's own root cause evaluation determined this was operator error committed by an FPL*
8 *employee.* FPL operators had not properly moved the master controller for the Turkey Point
9 Unit 3 SGFP recirculation valve(s) to the appropriate position for the plant conditions. FPL
10 operators attempted to adjust these recirculation valves after discovering the error, causing
11 low suction pressure on the SGFP. The RCA investigation determined that the FPL
12 operators had failed to properly review valve alignment and status of all components
13 following an unplanned reactor scram. As a result of the discovery of the FPL employee
14 errors, FPL had to implement procedural and training changes to prevent this event from
15 recurring. Because I have been blocked from accessing and independently reviewing the
16 FPL internal documents related to this event, I am unable to fully formulate and opinion
17 about this event as it relates to the prudence of FPL's culture, workforce staffing or other
18 aspects of prudence as it relates to or affects the recovery of fuel costs.

19 **Q. PLEASE DESCRIBE THE FOURTH OF THE FOUR UNPLANNED REACTOR**
20 **SCRAM EVENTS THAT OCCURRED BETWEEN AUGUST 2020 AND MARCH**
21 **2021.**

22 **A.** The fourth event occurred on March 1, 2021, following testing of the Reactor Protection
23 System. The restoration included reactor operators closing the reactor trip breaker and

1 opening the bypass breaker. Apparently, the reactor breaker was actually opened but the
2 switch indicated it was closed. This event is described in FPL Witness Dean Curtland's
3 testimony, starting on page 8, line 10. FPL found graphite grease had hardened and may
4 have prevented the switch from properly indicating the proper position of the reactor trip
5 breaker.

6 **Q. PLEASE DESCRIBE THE NRC'S FINDINGS FROM THE MARCH 1, 2019**
7 **PROBLEM IDENTIFICATION AND RESOLUTION INSPECTION AT**
8 **TURKEY POINT UNITS 3 AND 4 (Exhibit No. ___ (RAP-8)).**

9 **A. The NRC identified two findings associated with safety related valve testing in**
10 **which FPL plant personnel were not performing testing in accordance with proper**
11 **procedure and had not complied with American Society of Mechanical Engineers**
12 **(ASME)" Operation and Maintenance of Nuclear Power Plants" (OM) Code⁶ and**
13 **FPL's in-service test (IST) program.⁷ The first NRC finding involved surveillance**
14 **testing in which safety-related check valves were preconditioned by FPL plant**
15 **personnel following the valves failing the initial test and prior to the retest. The**
16 **plant's IST 0-ADM 502 Section 5.1.1, item 11, states in part: "Preconditioning**
17 **pumps and valves in the IST program shall be avoided. Preconditioning is the**
18 **alteration, manipulation, or adjustment of the physical condition of an SSC before**
19 **In-Service Testing for the expressed purpose of returning acceptable test results and**
20 **masking action As Found conditions." The purpose of in-service testing of safety**
21 **valves is to determine how the valves would perform during normal operation.**

⁶ ASME OM Code, "Operation and Maintenance of Nuclear Power Plants,"2020. Establishes the requirements for preservice and in-service testing and examination of certain components to assess their operational readiness in light-water reactor power plants.

⁷ FPL IST Program, 0-ADM-502.

1 Preconditioning should not be done prior to the first performance test or immediately
2 repeated retests.

3 The preconditioning that was prohibited in this case involved a procedure in
4 which plant personnel would manipulate the valve in some manner to prepare it for
5 the test procedure that could have the effect – whether intended or not – of “helping”
6 the valve pass the test. In the October 14, 2018 incident, two check valves failed their
7 leak test. The plant personnel preconditioned the valve for the follow-up test by
8 applying additional force by rapping the valve with a brass hammer. This application
9 of force invalidated the test because the valve was no longer in “as found condition
10 or normal operating condition.” The operators should have retested the valve without
11 preconditioning and if the valve still did not pass the leak rate test, they should have
12 identified the problem in the testing report and identified the need for further action
13 to inspect, perform maintenance, and/or repair the valve. This preconditioning by
14 FPL employee(s) was a violation of ASME ON Code and FPL IST procedure.

15 The second NRC finding was that the FPL plant personnel failed to declare
16 the check valves “inoperable” after failure of the IST tests. The NRC also found FPL
17 plant personnel had, dating back to 2010, been involved in other instances of these
18 procedures violations and of notifications not being followed.

19 **Q. PLEASE DESCRIBE THE NRC’S FINDINGS FROM THE FEBRUARY 11,**
20 **2021 INTEGRATED INSPECTION REPORT AT TURKEY POINT UNITS 3**
21 **AND 4 (Exhibit No. ___(RAP-9)).**

22 **A.** The NRC identified an incident on September 26, 2020 in which FPL personnel
23 failed to follow FPL procedure MA-AA-100-1002, “*Scaffold Installation*,

1 *Modification, and Removal Requests,”* by erecting scaffolding that could interfere
2 with operation of plant components. During the testing of a motor operated valve for
3 the containment sump isolation valve, the valve stem position indicator impacted
4 the scaffolding, causing damage to the valve and making the valve inoperable. This
5 made the residual heat removal system (RHR) inoperable and caused Unit 4 control
6 room operators to enter a 72-hour shutdown action statement (notice of potential
7 shutdown) because the RHR is a safety-related system used for removing heat from
8 containment in the event of an accident and because the RHR valve is a pressure
9 boundary valve for containment. Upon investigation, FPL found that maintenance
10 personnel had not properly walked down the location of scaffolding to verify that
11 the scaffolding, upon completion of assembly, would not interfere with equipment
12 operation. In addition, the scaffolding installation team had not discussed with
13 operations personnel the potential for interaction of the scaffolding with plant
14 equipment.

15
16 **VIII ASSESSMENT OF ST. LUCIE AND TURKEY POINT OPERATIONS**

17 **Q. WHAT ARE YOUR CONCERNS WITH THE INFORMATION YOU HAVE THUS**
18 **FAR PRESENTED IN YOUR TESTIMONY?**

19 **A.** Review of the various plant performance parameters, headcount history, NRC findings,
20 and outages present areas of concern regarding FPL’s plant operations. The St. Lucie units
21 have been in operation for over 39 years and Turkey Point units have been in operation for
22 over 49 years. The sequence of reactor unplanned scrams in August of 2020 appears to be
23 an indication of deficient training, inadequate staffing, and potential lack of experience

1 among plant personnel. The past evidence of falsification of maintenance records and of
2 FPL managers taking punitive actions against a contractor, although assumedly addressed,
3 raise concerns that they could be indicators of potential cultural issues emanating from cost
4 pressures in a way that can impact plant operations and performance. Any one of these
5 items in isolation may not necessarily constitute an indication of bigger issues. However,
6 when aggregated and evaluated against the backdrop of a significant reduction in
7 headcount at both plants, as well as recent NRC findings, agreed-violations and a
8 downgrade from “green” to “white” for a period of time, these factors may point toward
9 employees’ workload increases resulting in lower performance and more errors. Reduction
10 in plant headcount of more than 20% without corresponding reduction in workload, raises
11 concerns with how the work is being accomplished.

1 **Q. WHAT EVIDENCE CAN YOU PROVIDE TO SUPPORT YOUR CONCERNS?**

2 **A.** In addition to the NRC reports cited earlier, review of St. Lucie and Turkey Point GPIF
3 reports contains some indication that in recent years, plant performance has degraded.
4 Exhibit No. ___ (RAP-10), provides the five performance indicators discussed earlier, for
5 St. Lucie and Turkey Point for the 11-year period of 2010 – 2021. The data shows that
6 between 2010 and 2016, overall on average plant EAF and EFOR indicated some
7 improvement. Figure 3 provides a graph of the average EAF and EFOR for all four of
8 FPL’s nuclear units. The data shows that starting in 2016, average EAF and EFOR

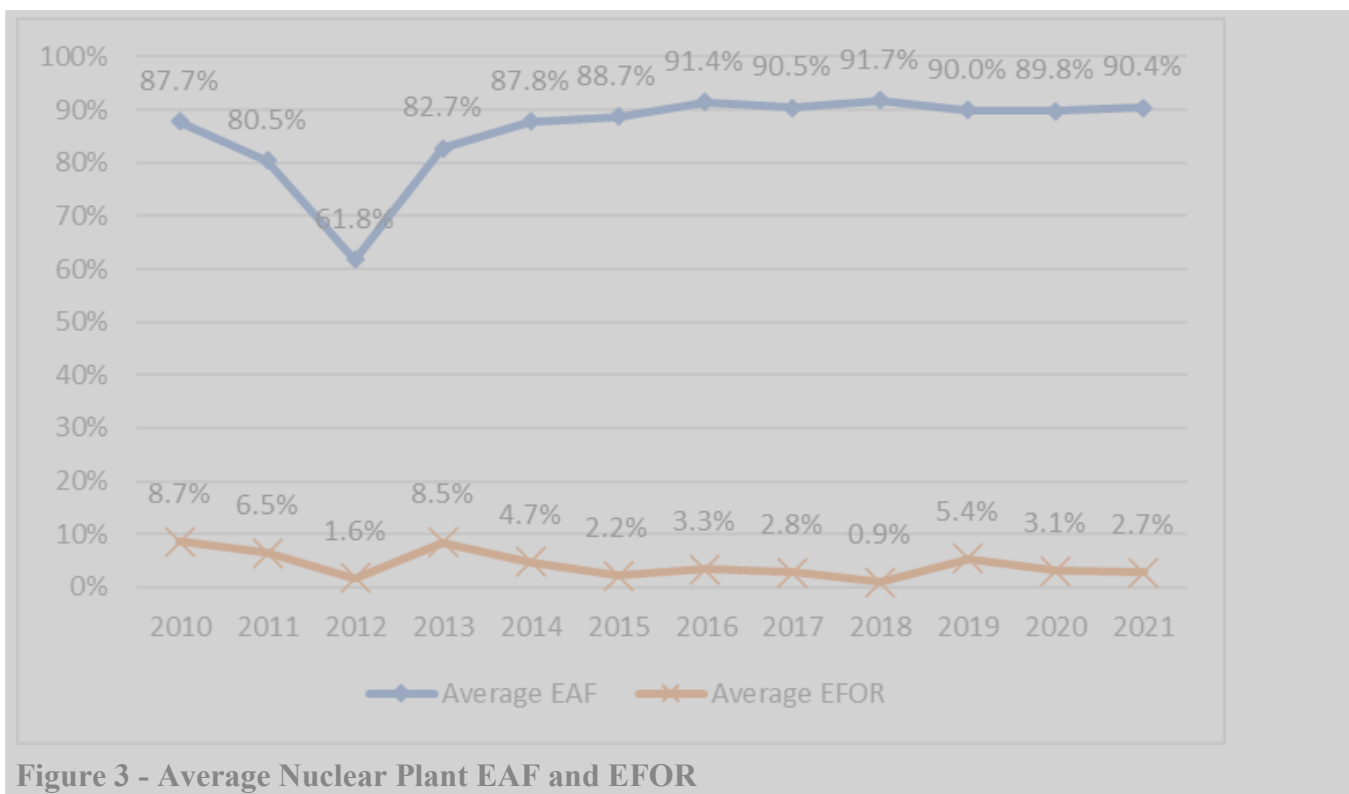

Figure 3 - Average Nuclear Plant EAF and EFOR

9 improved significantly, peaking in 2018. Since 2018, average EAF and EFOR have
10 declined. This degradation generally corresponds with FPL’s headcount reduction shown
11 in Figures 1 and 2, assuming some lagging effect as the reductions were implemented. The
12 data in Exhibit No. ___ (RAP-10) shows that Turkey Point Unit 3 EAF and EFOR for 2020

1 and 2021 were the worst since about 2014, which again generally corresponds with FPL's
2 headcount reduction.

3 **Q. WHAT COULD BE THE IMPACT ON PLANT OPERATIONS PERSONNEL**
4 **BEING REQUIRED TO PERFORM THEIR TASKS WITH LESS OVERALL**
5 **STAFFING RESOURCES?**

6 A. A situation of overworked personnel in a nuclear plant environment has the potential to
7 contribute to more frequent plant forced outages, derates, and extension of maintenance
8 outages due to personnel errors, failure to notice equipment problems, lack of observance
9 in performing tasks, insufficient time to assess plant operations and tasks, insufficient
10 planning, inopportune unavailability of staff to perform critical tasks and other issues.
11 Increased outages and derates have the potential to create large scale forced outage
12 durations, multiple smaller forced outage durations or a combination of both types of
13 outages. These circumstances can result in noticeable and readily identifiable instances of
14 higher replacement power costs or smaller and less noticeable or material replacement
15 power costs that can nevertheless have a cumulative effect on the fuel costs borne by
16 customers. All of these can impact the fuel costs that customers incur in the rates to be set
17 in this hearing.

18 **Q. WHAT RECOMMENDATION DO YOU HAVE FOR THE COMMISSION TO**
19 **ADDRESS THIS ISSUE?**

20 A. First, an investigation and independent assessment of FPL nuclear operations may be a
21 valuable option if FPL has not had an independent assessment recently. I recommend that
22 the Commission initiate such an investigation. An independent evaluation can assess
23 personnel performance and determine if personnel cuts have resulted in workforce

1 performance degradation due to stresses and overwork. Performing an independent
2 assessment can provide valuable insight into operations and personnel tweaks that could
3 help avoid future problems. I have been involved in similar assessments which resulted in
4 identifying important changes which improved moral, performance, and personnel
5 integrity, and, ultimately, safety.

6 A second recommendation is for the Commission to establish a spin-off proceeding
7 to perform an in-depth evaluation of the FPL headcount reductions' impact on nuclear
8 operations and ratepayer-borne fuel cost impacts since 2016 and into the future.

9 **IX ASSESSMENT OF OUTAGES AND DERATES IMPACT ON REPLACEMENT**
10 **POWER COSTS**

11 **Q. PLEASE DESCRIBE THE EVENTS OF JULY 5, 2020 AT TURKEY POINT UNIT**
12 **4 THAT LED TO THE AUTOMATIC SHUTDOWN DUE TO MAIN GENERATOR**
13 **LOCKOUT AND TURBINE TRIP.**

14 A. During heavy thunderstorm, several alarms occurred involving the generator and exciter
15 monitoring systems. The generator reactive load was observed to be oscillating between
16 115 MVAR and 200 MVAR, and the exciter field voltage was also found to be oscillating.
17 The reactor then tripped due to a main generator lockout. The Main Generator Lockout was
18 caused by the actuation of the Voltage Regulator Lockout relay due to loss of the Voltage
19 Regulator Power Supplies #1 & #2 (and thus loss of excitation). FPL then initiated a failure
20 investigation process and developed actions to identify, inspect and test any component
21 that could have been affected by the failure of the PMG stator. The investigation team

1 determined the unit trip was caused by failure of the generator exciter permanent magnet
2 generator (PMG).

3 **Q. PLEASE DESCRIBE A GENERATOR EXCITER, ITS FUNCTION IN POWER**
4 **PRODUCTION, AND THE PURPOSE OF THE PMG.**

5 A. The generator exciter creates a DC current by rotating the PMG inside of exciter windings
6 (wire coil). This DC current is fed to the rotor of the synchronous generator to create a
7 magnetic field which is rotated inside the generator to create electricity. The exciter is
8 connected to the generator shaft. The exciter PMG is what initiates the process of
9 energizing the generator for production of electricity. Without the exciter, the generator is
10 a rotating mass and cannot produce power because there is no magnetic field.

11 **Q. DID FPL CONDUCT A ROOT CAUSE EVALUATION (RCE) FOR THIS**

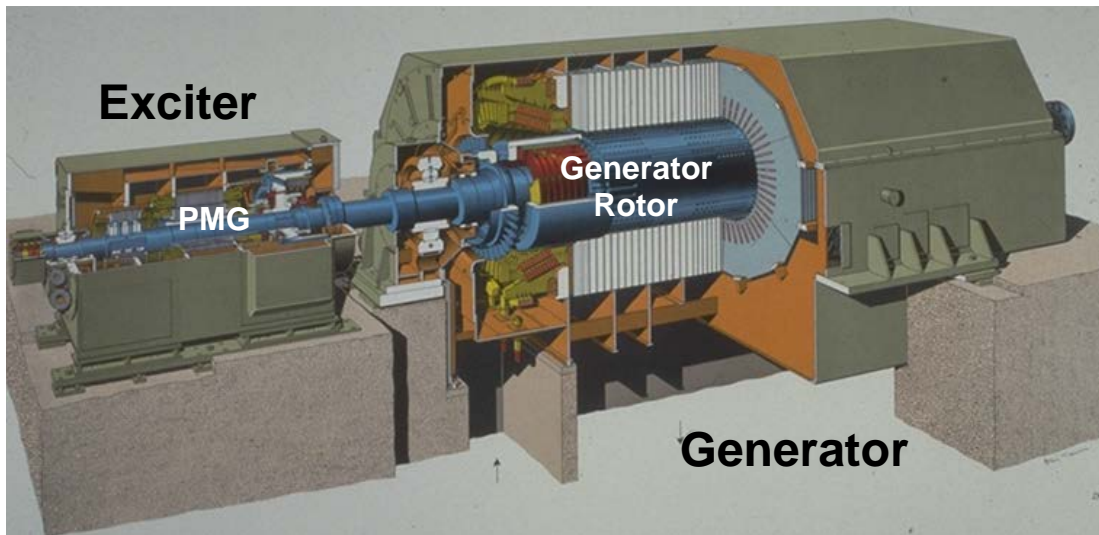

Figure 4 - Generator Exciter Configuration

12 **EVENT?**

13 A. Yes. Exhibit No. ___ (RAP-11) is a copy of the Turkey Point Nuclear Unit 4 Reactor Trip
14 Due to Gen Lockout from Loss of Exciter Root Cause Evaluation (RCE).

1 **Q. WHAT DID FPL’s INVESTIGATION TEAM DETERMINE TO BE THE CAUSE**
2 **OF THE EXCITER FAILURE?**

3 A. Upon disassembly of the exciter, the investigation revealed water intrusion and found that
4 the PMG was damaged. The root cause team found the failure of the PMG was likely due
5 to a culmination of age-related breakdown of the PMG stator winding insulation, along
6 with water intrusion due to inadequate sealing of the Exciter housing. The RCE claims the
7 overall root casue to be weakness in the Exciter PM program resulted from a failure to fully
8 assess risk of PMG stator winding age, thus making it more susceptible to failure when
9 exposed to water/moisture. Contibuting factors to the failure were found by FPL to inlcude:

10 1. SCC #1) Weakness in Exciter PM Program based on existing
11 Original Equipment Manufacturer (“OEM”) and Industry
12 recommendations which were CONDITION BASED, and did not
13 require TIME-BASED PMG stator rewind, thereby increasing
14 susceptibility to failure from other stressors.

15 2. SCC #2) OEM procedure 3.2.2.1 did not include site specific
16 weather sealing requirements based on OEM specifications.

17 **Q. WHAT WAS DETERMINED TO BE THE CAUSE OF THE WATER INTRUSION**
18 **INTO THE EXCITER?**

19 A. The first occurrence of water intrusion into the Exciter occurred in 2001 which led to a
20 ground fault in the exciter. This event resulted in FPL installing additional weather seals
21 on the exciter. While FPL did modify the Maintenance Support Package for the exciter to
22 incorporate the new seals and inspection, it failed to incorporate the seals requirement into
23 the OEM procedures. During event investigation, it was found that water had accumulated

1 inside the PMG and pedestal bolt holes. The following degradation of seals were also
2 discovered:

- 3 1. The partition seal between the AC Exciter compartment and PMG
4 compartment.
- 5 2. Housing floor gaskets which were found dislodged in sections
6 around the perimeter of the PMG compartment.
- 7 3. The site-specific vertical foam weather seal designed under MSP
8 02-055 and required in site procedure 0-GMM-090.1 was not
9 installed.

10 As a result, the investigation team determined the most probable path of water ingress was
11 through the missing vertical foam seal and the degraded and dislodged floor gaskets. **The**
12 **RCE concluded that the failure of the PMG stator was due to insulation degradation**
13 **coupled with additional stressors; water intrusion being the likely cause.**

14 **Q. DID ANY FPL ACTIVITIES CONTRIBUTE TO THE EXCITER FAILURE OR**
15 **COULD THE EXCITER PROBLEM BEEN FOUND PRIOR TO FAILURE?**

16 A. Yes. FPL was aware of the potential for water intrusion into the Exciter based on the 2001
17 event. FPL personnel had not properly installed seals which contributed to water intrusion.
18 In addition, FPL failed to inspect the seals during periodic exciter inspections to ensure
19 they performed their intended function to keep water out. The Turkey Point steam turbines,
20 generators and exciters are located outdoors and exposed to the ambient weather
21 conditions. Prudent utility maintenance requires that seals required to maintain equipment
22 and prevent water intrusion need to be inspected on a regular basis. FPL did not adhere to
23 this standard.

1 **Q. WHAT WAS THE AMOUNT OF REPLACEMENT POWER COSTS FOR THE**
2 **OUTAGE?**

3 A. According FPL response to Staff Interrogatory No. 4 (Exhibit No. ___(RAP-12)), the
4 replacement power cost for the outage from the July 2020 of Turkey Point Unit No. 4 was
5 \$1,453,970.⁸ I am accepting these calculations for the purposes of my testimony at this
6 time even though I do not agree they are necessarily calculated correctly. At this point, it
7 is my opinion that the calculation of the replacement power costs related to specific outages
8 caused by imprudent action or decision-making of FPL should be based on the incremental
9 or “but for” costs of generation, fuel or purchases. FPL should be required to calculate
10 replacement power costs on this basis and the refunds or credits to customers should be
11 ordered by the Commission accordingly.

12 **Q. WHAT IS YOUR RECOMMENDATION ON FPL RECOVERY OF THOSE**
13 **REPLACEMENT POWER COSTS?**

14 A. It is my recommendation that the Commission disallow recovery of the \$1,453,970 in
15 replacement power costs associated with the outage caused by the exciter failure because
16 the event was preventable.

17 **Q. PLEASE DESCRIBE THE EVENTS OF MARCH 1, 2021 AT TURKEY POINT**
18 **UNIT 3 WHICH RESULTED IN AN UNPLANNED AUTOMATIC REACTOR**
19 **TRIP.**

20 A. Turkey Point Unit 3 experienced an unplanned scram of the reactor due to during
21 restoration from Reactor Protection System Testing. The reactor safely shutdown and there
22 was not any damage to equipment.

⁸ FPL used average values versus actual hourly incremental in computing the replacement power costs. I reserve the right to adjust these figures if deemed necessary, based on new, corrected information.

1 **Q. DID FPL CONDUCT A ROOT CAUSE INVESTIGATION FOR THIS EVENT?**

2 A. Yes, Exhibit No. ___ (RAP-13) is a copy of the Turkey Point Nuclear Unit 3 Trip During
3 Restoration from RPS Testing RCE.

4 **Q. WHAT WAS DETERMINED TO BE THE CAUSE OF THIS SCRAM?**

5 A. The reactor trip was caused by improper operation of the reactor trip breaker (“RTB”). The
6 cause of the RTB to malfunction was not directly determined but multiple contributing
7 causes were found. One of the main culprits was hardened grease on the cell switches. The
8 breaker was a Westinghouse breaker and Westinghouse performed an extensive
9 investigation to determine the cause of the problem. In their investigation, Westinghouse
10 found that FPL had not properly maintained the cell switches in the breaker and that the
11 hardened lubrication could cause the stationary contacts to become dislodged. The
12 Maintenance Program Manual (“MPM”) for Westinghouse Safety Related Type DB
13 Circuit Breakers and Associated Switchgear, Revision 1, July 2011 defines that the DB cell
14 switch as a Category B item and the interval for conducting the procedure provided should
15 not exceed 5 Years. In addition, Westinghouse MPM recommended a service life of 100
16 cycles for cell switches, which was not included in FPL preventative maintenance and only
17 requires inspection every 18 months. FPL incorrectly planned or conducted maintenance
18 of the switch on a conditional or “as found” basis instead of the method required or
19 prescribed by Westinghouse. *The RCE determined the root cause was cleaning and*
20 *lubricating cell switch contacts is conditional based, rather than prescriptive.*

1 **Q. DID ANY FPL ACTIVITIES CONTRIBUTE TO THE RTB FAILURE OR COULD**
2 **THE RTB PROBLEM HAVE BEEN FOUND PRIOR TO FAILURE?**

3 A. Yes, FPL failed to follow the Westinghouse prescribed MPM which resulted in a lack of
4 proper cleaning of the cell switch and relies on skill of the craft and judgement of the
5 journeyman performing the inspection.

6 **Q. WHAT WAS THE AMOUNT OF REPLACEMENT POWER COSTS FOR THE**
7 **OUTAGE?**

8 A. According FPL response to Staff Interrogatory No.4 (Exhibit No. ___(RAP-12)), the
9 replacement power cost for the outage from the March 2021 outage of Turkey Point Unit
10 No. 3 was \$1,206,743.⁹ I am accepting these calculations for the purposes of my testimony
11 at this time even though I do not agree they are necessarily calculated correctly. At this
12 point, it is my opinion that the calculation of the replacement power costs related to specific
13 outages caused by imprudent action or decision-making of FPL should be based on the
14 incremental or “but for” costs of generation, fuel or purchases. FPL should be required to
15 calculate replacement power costs on this basis and the refunds or credits to customers
16 should be ordered by the Commission accordingly.

17 **Q. WHAT IS YOUR RECOMMENDATION ON FPL RECOVERY OF THOSE**
18 **REPLACEMENT POWER COSTS?**

19 A. It is my recommendation that the Commission disallow recovery of the \$1,206,743 in
20 replacement power costs associated with the outage caused by the RTB failure because the
21 event was preventable.

⁹ FPL used average values versus actual hourly incremental in computing the replacement power costs. I reserve the right to adjust these figures if deemed necessary, based on new, corrected information.

1 **Q. DOES THAT FACT THAT YOU ARE NOT RECOMENDING DISALLOWANCES**
2 **OR MAKING A RECOMMENDATION ON ALL OF THE FORCED OUTAGES**
3 **OR DERATES DURING THE PERIOD OF 2019 - 2021 INDICATE THAT YOU**
4 **HAVE DETERMINED THAT FPL WAS PRUDENT IN ALL ASPECTS OF THOSE**
5 **EVENTS AND THE NEED FOR AND AMOUNT OF REPLACEMENT POWER**
6 **ASSOCIATED WITH THEM?**

7 **A.** No. Although I have made an effort to review all of the available material related all outage
8 events, it was not possible for me to discern in every event whether I had all information
9 or that FPL had met its burden to demonstrate that it was reasonable and prudent in all of
10 its actions. My silence on any particular outage does not mean that I have formed an
11 opinion that customers should pay the associated replacement power costs related to those
12 outages. **As I have testified above, however, I do believe that the Commission should**
13 **open a spin-off investigation and review patterns of events that may be inducing**
14 **customers to pay more in replacement power costs in the fuel factor.**

15 **Q. DOES THAT CONCLUDE YOUR TESTIMONY?**

16 **A.** Yes, it does.



Richard A. Polich, P.E.
Managing Director – Power Supply Services

EDUCATION

Master of Business Administration, University of Michigan, 1990
Bachelor of Science, Mechanical Engineering, University of Michigan, 1979
Bachelor of Science, Nuclear Engineering, University of Michigan, 1979

ENGINEERING REGISTRATION

Professional Engineer in the State of Michigan

PROFESSIONAL MEMBERSHIP

National Society of Professional Engineers
American Nuclear Society
American Society of Mechanical Engineers

PROFESSIONAL EXPERIENCE

Mr. Polich has more than 40 years' experience as an energy industry engineer, manager, and leader, combining his business and technical expertise in the management of governmental, industrial and utility projects. He has worked extensively in nuclear, coal, IGCC, natural gas, green/renewable generation. Mr. Polich has developed generation projects in wind, solar, and biomass in Australia, Canada, Caribbean, South American and United States. His generation experience includes engineering of systems and providing engineering support of plant operations. Notable projects include the Midland Nuclear Project and its conversion to natural gas combined cycle, start-up testing support for Consumers' coal-fired Campbell 3, Palisades nuclear steam generator replacement support, Covert Generating Station feasibility evaluation, and a Lake Erie offshore wind project. He also has extensive experience in utility rates and regulation, having managed Consumers Energy's rates group for a number of years. In that function his responsibilities included load and revenue forecasting, overseeing the design of gas and electric rates and testifying in regulatory proceedings. Mr. Polich has testified in over thirty regulatory and legislative proceedings.

Mr. Polich has been involved in the nuclear industry since 1978. While at GDS, Mr. Polich has provided Utah Associated Municipal Power System project cost analysis for a small modular nuclear power project. Last year, he provided advisory services to the Vermont Public Utility Commission on the ownership transfer, nuclear decommissioning trust fund adequacy and decommissioning methodology of Vermont Yankee. Mr. Polich has supported GDS oversight efforts of the construction of the Vogel Nuclear Plant units 2&3 for the Georgia Public Service Commission. He has also provided decommissioning assessment analysis on St. Lucie Nuclear, and Grand Gulf Nuclear projects. Mr. Polich was part of the design engineering team for the Erie Nuclear Plant by the design engineering firm, Gilbert Commonwealth. Key responsibilities were the design of systems and component specifications associated with the nuclear steam supply systems (NSSS) and steam turbine thermal cycle. Worked directly with Babcock and Wilcox on NSSS design and ancillary system specifications. Mr. Polich was also senior engineer on the Midland Nuclear project, responsible for oversight of Bechtel design engineering and interfacing with NSSS vendor Babcock & Wilcox on ancillary systems. His responsibilities also included negotiation with the Nuclear Regulatory Commission on new regulation requirements. Mr. Polich's role evolved into onsite engineering during construction of the Midland Nuclear Plant and as a project trouble shooter at the Palisades Nuclear Plant.



Richard A. Polich, P.E.
Managing Director – Power Supply Services

SPECIFIC PROJECT EXPERIENCE

NUCLEAR PROJECT EXPERIENCE

Utah Association of Municipal Utilities – Provided assessment of project costs and economics during contract negotiation phase of project. Included review of Small Modular Reactor design concepts, identification of critical issues, project schedule, risk analysis and estimated cost provided by NuScale and EPC contractors. Provide technical support for UAMPS team on as needed basis.

Vermont Yankee – Provided the Vermont Public Utility Commission advisory services on the asset transfer of Vermont Yankee from Entergy Nuclear Operations, Inc. to NorthStar Group Holdings, LLC. This effort has included assessment of financial strength of new company, adequacy of Nuclear Decommissioning Trust Fund to fund decommissioning efforts, evaluation of decommissioning methodology and State of Vermont Risk.

Vogel Nuclear Plant Units 3 & 4 – Mr. Polich has provided advisory services to the team performing the oversight of the construction of the Vogel Plant Units 3 & 4 as part of GDS project oversight responsibilities for the Georgia Public Service Commission.

St. Lucie Nuclear Plant – Provided a risk assessment, decommissioning funding study and ownership evaluation for City of Vero Beach. This included review of project maintenance history, steam generator replacement project, analysis of decommissioning needs and funding and assessing current value of Vero Beach's ownership share.

Grand Gulf Nuclear Project – Assessed the adequacy of decommissioning funding and funding level for the grand Gulf Nuclear plant for Cooperative Energy. Project purpose was to assess changes in decommissioning funding rates and to determine if sufficient funds would be available for plant decommissioning.

Consumers Energy Midland Nuclear Plant – Responsible for overseeing EPC contractor design and construction of primary and secondary nuclear systems. Included review of systems for compliance with Nuclear Regulatory Commission regulations. Key projects included:

- Leading team to analyze plant and determine best methods for compliance with new CFR Appendix R Fire Protection rules
- Design of primary cooling system pump oil collection and disposal systems.
- Oversight of redesign of component cooling water systems.
- Analysis of diesel generator capability to meet emergency shutdown power requirements.
- Primary interface with Dow Chemical for steam supply contract.

Ohio Edison Company Erie Nuclear Project – Design engineer responsible for the design, equipment specifications, bid evaluations and regulatory licensing for nuclear steam supply system and ancillary systems. Key projects included:

- Project Thermal Analysis
- Development of NSS valve specifications
- Major equipment bid Proposal Evaluation and recommendations

Interface with Babcock & Wilcox on NSSS Design

RATES & REGULATORY

GDS associates, Inc. – Managing Director

North Dakota Public Service Commission Staff – Case No. PU-16-666 MDU Generatl Rate Case

Provided testimony on behalf of the North Dakota Public Service Commission Staff regarding return on equity, cost of capital, revenue requirement, and generation resource costs.



Richard A. Polich, P.E.
Managing Director – Power Supply Services

North Dakota Public Service Commission Staff – Case No. PU-15-96 NSP Determination of Prudence

Provided testimony on behalf of the North Dakota Public Service Commission Staff regarding analysis and recommendation concerning Northern States Power’s (“NSP”) need for additional generation resources.

Consumers Energy - Supervisor of Pricing and Forecasting

Managed the group responsible for setting and obtaining regulatory approval for the company’s electric and gas rates. Developed new approaches to electric and natural gas competitive pricing, redesigned electric rates to simplify rates and eliminate losses and defined new strategies for customer energy pricing. Negotiated new electric supply contracts with key industrial electric customers resulting in over \$800M in annual revenue. Testified in multiple regulatory proceedings.

EOS Energy Options & Solutions – Consulting Company

Provided testimony for multiple clients in both Detroit Edison and Consumers Energy in over 30 regulatory proceedings. Testimony topics included rates, public policy and deregulation. Also testified in several legislative proceedings in both Michigan and Ohio, addressing energy policy. Provided expert witness testimony in Massachusetts regarding wind energy projects.

NATURAL GAS COMBINED CYCLE EXPERIENCE

Consumers Energy – 1,560 MW Midland Cogeneration Venture

Member of a small team selected to investigate the feasibility of converting the mothballed Midland Nuclear Plant into a fossil fueled power plant. Established new plant configuration that repowered the existing nuclear steam turbine with natural gas fired combustion turbines and heat recovery steam generators. Developed the new thermal cycle and heat rate, determined how to supply steam to Dow chemical for cogeneration, developed models for projecting plant performance, defined which portions of the nuclear plant were useful in the new combined cycle plant and forecasted project economics.

Nordic Energy – Vice President

Project Manager for the development of two 1,150 MW IGCC projects proposed to Georgia Power and Xcel Energy in response to RFPs. Responsibilities included establishing thermal cycles, equipment selection, site selection, supervising engineering, developing project proforma and proposals.

Project Manager for 230 MW power barge to be located on the Columbia River near Portland Oregon. Lead the project development team responsible for securing equipment, designing the power plant, design of barges, assessing site feasibility, developing project economics and interconnection applications.

RENEWABLE ENERGY EXPERIENCE

Matinee Energy – Utility Scale Solar Developer

Engineering design and project development consultant for utility scale solar photovoltaic projects. Development activities include site selection, equipment specifications, financial analysis and preparation of proposals. Also responsible for engineering and securing electrical interconnection.

Windlab Developments USA – Wind Power Developer

Responsible for greenfield development of the US platform for wind energy projects east of the Mississippi. Developed the company’s engineering protocol for wind project design and construction, responsible for managing engineering design and construction of projects, and established six wind power projects (750 MW). Responsible for negotiation of Power Purchase Agreements, electrical interconnection studies, interface with Midwest ISO and submitting Generation Interconnection Application.

TradeWind Energy - Wind Power Project Developer

Project developer for 800 MW of wind power projects in Michigan and Indiana. Introduced new project



Richard A. Polich, P.E.
Managing Director – Power Supply Services

management methods to the development process which resulted in savings of over \$200,000 annually on each project.

Third Planet Windpower – Wind Power Project Developer

Engineering and project management consultant to support the startup of new wind power company. Established engineering standards used for selection of wind project equipment and project construction, analysis tools for evaluating projecting wind project power production, and performed project economic modeling.

Noble Environmental Power – Wind Power Project Developer

Electric transmission system consultant on the development of several wind power projects. Supported Noble's decisions on transmission grid interconnect and negotiate interconnection agreements.

ENERGY EFFICIENCY EXPERIENCE

Arkansas Energy Office – Weatherization Assistance Program Evaluation

Evaluated the performance and operations of Arkansas's Weatherization Assistance Program. This included review of program effectiveness, program operations, energy efficiencies attained, adequacy of energy efficiency measures and subcontractor performance.

CLEAResult – Arkansas Energy Efficiency Programs

Energy efficiency operations and program support for 400% increase in Arkansas energy efficiency programs. Developed processes for data collection, field staff deployment and job assignments.

ECONOMIC IMPACT ASSESSMENT

Michigan Department of Environmental Quality - Economic Impacts of a Renewable Portfolio Standard and Energy Efficiency Program for Michigan

Project Manager for this report which focused on the economic impact of renewable portfolio standard and energy efficiency programs on the State of Michigan. The evaluation used in this report encompassed using integrated resource planning models, econometric modeling and electric pricing models for the entire State of Michigan.

West Michigan Business Alliance - Alternative and Renewable Energy Cluster Analysis

Prepared the report provided a road map for Western Michigan businesses to establish new business in the renewable energy industry.

POWER PROJECT EXPERIENCE:

Detroit Edison St Clair Power Station – Performed coal combustion analysis associated with conversion Powder River Basin coal. Work included pulverizer mill performance testing, boiler combustion analysis on new coal, and unit performance analysis.

Consumers Energy Campbell 3 - Supported start-up efforts of this 800 MW pulverized coal power plant. Part of team that performed analysis of boiler data and determined the cause of superheater failure. Also part of team to analyze performance test data for warranty evaluation.

Consumers Energy Weadock Plant – Design oversight and specified various plant upgrades during major maintenance outage. Included replacement of high-pressure superheater, design of new steam supply pipes, valve specifications and supported plant restart.



Richard A. Polich, P.E.
Managing Director – Power Supply Services

PAPERS & PUBLICATIONS

Engineering and Economic Evaluation of Offshore Wind Plant Performance and Cost Data, 2011, Produced for the Electric Power Research Institute, KEMA, Inc.

FERC's 15% Fast Track Screening Criterion, 2012, Paper reviewing the FERC 15% screening criteria for electrical interconnection, KEMA, Inc.

Island of Saint Maarten Sustainable Energy Study, 2012, Produced for the Cabinet of Ministry VROMI, KEMA Inc.

A Study of Economic Impacts from the Implementation of a Renewable Portfolio Standard and an Energy Efficiency Program in Michigan, 2007, Produced for the Michigan Department of Environmental Quality

Alternative and Renewable Energy Cluster Analysis, 2007, Produced for the West Michigan Strategic Alliance and The Right Place

COURSES & SEMINARS

Association of Energy Engineers – Certified Energy Manager
Green Building Council – Associated LEED Certification Training
CLEAResult Leadership Academy

COMMUNITY SERVICE AND ACTIVITIES

Bicycling, hiking and cross-country skiing
Instrument-Rated Private Pilot
Habitat for Humanity
Scoutmaster
Soccer coach and referee
Volunteer work for disaster relief and building homes in Mexico

PREVIOUS TESTIMONY OF RICHARD A. POLICH

COMMISSION	CASE	ON BEHALF	TITLE
FERC	ER21-2186-001	Joint Customers	Fern Solar, LLC
FERC	ER21-2364-001	Joint Customers	Albemarle Beach Solar, LLC
FERC	ER20-2576-001	Joint Customers	Holloman Lessee, LLC
FERC	ER21-2091-001	Joint Customers	Mechanicsville Solar
Michigan	U-21090	Biomass Plants	Request for Approval of Consumers Energy Integrated Resource Plan
Minnesota	G-002/CI-21-610	Minnesota Dept of Commerce	Investigation into the cause of outages at Xcel Energy's gas peaking facilities.
FERC	ER21-864	Glidepath	Revenue Requirement for Reactive Power Production Capability of Meyersdale Storage, LLC.
Minnesota	E999/AA-20-171	Minnesota Dept of Commerce	Investigation into the cause of outages at Minnesota Power's Clay Boswell coal plant and impact on replacement power costs.
Florida	2019140-EI	Florida Office of Public Council	Crystal River 3 Accelerated Decommissioning
Florida	2019001-EI	Florida Office of Public Council	Fuel Adjustment Clause – Bartow Steam Turbine Failure Power Supply Cost Recovery Disallowance
FERC	ER17-1821-002	Joint Customers	Revenue Requirement for Reactive Power Production Capability of the Panda Stonewall Generating Facility
North Carolina	E-2 Sub1142	Duke Energy Progress	Duke Energy Progress General Rate Case
Indiana	38707 FAC111-S1	Nucor Steel	Duke Energy Indiana, LLC for Fuel Cost Adjustment Clause
North Dakota	PU-16-166	ND PSC Staff	Montana-Dakota Utilities 2016 Electric Rate Increase Application
Hawaii	2015-0022	Sun Edison	Regarding the Hawaiian Electric Company, Inc. and NextEra Merger
North Dakota	PU-15-96	ND PSC Staff	Northern States Power Determination of Prudence
Michigan	U-10143	Consumers Energy	Consumers Energy Approval of an Experimental Retail Wheeling Case
Michigan	U-10335	Consumers Energy	General Rate Case
Michigan	U-10625	Consumers Energy	Proposal for Market-Based Rates Under Rate-K
Michigan	U-10685	Consumers Energy	1996 General Rate Case
Michigan	U-11915	Energy Michigan	Supplier Licensing
Michigan	U-11955	Energy Michigan	Consumers Energy Stranded & Implementation Cost Recovery
Michigan	U-11956	Energy Michigan	Detroit Edison Stranded & Implementation Cost Recovery
Michigan	U-12478	Energy Michigan	Detroit Edison Asset Securitization Case
Michigan	U-12488	Energy Michigan	Consumers Energy Retail Open Access Tariff
Michigan	U-12489	Energy Michigan	Detroit Edison Retail Open Access Tariffs
Michigan	U-12505	Energy Michigan	Consumers Energy Asset Securitization Cases
Michigan	U-12639	Energy Michigan	Stranded Cost Methodology Case
Michigan	U-13380	Energy Michigan	Consumers Energy 2000, 2001 & 2002 Stranded Cost Case
Michigan	U-13350	Energy Michigan	Detroit Edison 2000 & 2001 Stranded Cost Case

PREVIOUS TESTIMONY OF RICHARD A. POLICH

COMMISSION	CASE	ON BEHALF	TITLE
Michigan	U-13715	Energy Michigan	Consumers Energy Securitization of Qualified Costs
Michigan	U-13720	Energy Michigan	Consumers Energy 2002 Stranded Costs
Michigan	U-13808	Energy Michigan	Detroit Edison General Rate Case
Michigan	U-13808-R	Energy Michigan	Detroit Edison 2004 Stranded Cost &
Michigan	U-14474	Energy Michigan	Detroit Edison 2004 PSCR Reconciliation Case
Michigan	U-13933	Energy Michigan	Detroit Edison Low-Income Energy Assistance Credit for Residential Electric Customers
Michigan	U-13917-R	Energy Michigan	Consumers Energy 2004 PSCR Reconciliation Case
Michigan	U-13989	Energy Michigan	Consumers Energy Request for Special Contract Approval
Michigan	U-14098	Energy Michigan	Consumers Energy 2003 Stranded Costs
Michigan	U-14148	Energy Michigan	Consumers Energy MCL 460.10d(4) Case
Michigan	U-14347	Energy Michigan	Consumers Energy General Rate Case
Michigan	U-14274-R	Energy Michigan	Consumers Energy 2005 PSCR Reconciliation Case
Michigan	U-14275-R	Energy Michigan	Detroit Edison Company 2005 PSCR Reconciliation Case
Michigan	U-14399	Energy Michigan	Detroit Edison Company Application for Unbundling of Rate
Michigan	U-14992	Energy Michigan	Power Purchase Agreement and for Other Relief in Connection with the sale of the Palisades Nuclear Power Plant and Other Assets

BEFORE THE FLORIDA PUBLIC SERVICE COMMISSION

In re: Fuel and purchased power cost recovery clause
with generating performance incentive factor.

Docket No.: 20220001-EI

Filed: August 3, 2022

**FLORIDA POWER & LIGHT COMPANY'S OBJECTIONS TO THE OFFICE
OF PUBLIC COUNSEL'S SECOND SET OF INTERROGATORIES (Nos. 14-35)
AND SECOND REQUEST FOR PRODUCTION OF DOCUMENTS (Nos. 20-25)**

Florida Power & Light Company ("FPL"), pursuant to Rules 1.340 and 1.350, Florida Rules of Civil Procedure and Rule 28-106.206, Florida Administrative Code, submits the following objections to the Office of Public Counsel's ("OPC") Second Set of Interrogatories (Nos. 14-35) and Second Request for Production of Documents (Nos. 20-25).

I. General Objections

FPL objects to each and every request for information or documents that call for information protected by the attorney-client privilege, the work product doctrine, the accountant-client privilege, the trade secret privilege, or any other applicable privilege or protection afforded by law, whether such privilege or protection appears at the time response is first made or is later determined to be applicable for any reason. FPL in no way intends to waive such privilege or protection. The nature of the privileged or protected document(s), if any, will be described in a privilege log prepared by FPL.

In certain circumstances, FPL may determine, upon investigation and analysis, that information or documents responsive to certain discovery requests to which objections are not otherwise asserted is confidential and proprietary and should be produced only with provisions in place to protect the confidentiality of the information. By agreeing to provide such information or documents in response to such request, FPL is not waiving its right to insist upon appropriate protection of confidentiality by means of a protective order, a request for confidential classification, a Notice of Intent, and any other process as provided for by Florida Statutes and

Commission Rules, or other action to protect the confidential information or documents requested. FPL asserts its right to require such protection of any and all information and documents that may qualify for protection under the Florida Rules of Civil Procedure, Florida Statutes, and other applicable statutes, rules and legal principles.

FPL objects to each request to the extent that it seeks information that is duplicative, not relevant to the subject matter of this docket, and is not reasonably calculated to lead to the discovery of admissible evidence.

FPL objects to each and every discovery request to the extent it is vague, ambiguous, overly broad, imprecise, or utilizes terms that are subject to multiple interpretations but are not properly defined or explained for purposes of such discovery requests. Any responses provided by FPL will be provided subject to, and without waiver of, the foregoing objection.

FPL also objects to each and every discovery request to the extent it calls for FPL to prepare information in a particular format or perform calculations or analyses not previously prepared or performed as unduly burdensome and as purporting to expand FPL's obligations under applicable law.

FPL objects to providing information to the extent that such information is already in the public record before the Florida Public Service Commission or other public agency and available to OPC through normal procedures or is readily accessible through legal search engines.

FPL objects to each and every discovery request that calls for the production of documents and/or disclosure of information from NextEra Energy, Inc. and any subsidiaries and/or affiliates of NextEra Energy, Inc. that do not deal with transactions or cost allocations between FPL and either NextEra Energy, Inc. or any subsidiaries and/or affiliates. Such documents and/or information do not affect FPL's rates or cost of service to FPL's customers. Therefore, those documents and/or information are irrelevant, immaterial, and not reasonably

calculated to lead to the discovery of admissible evidence. Furthermore, FPL is the party appearing before the Florida Public Service Commission in this docket. To require any non-regulated entities to participate in irrelevant discovery is by its very nature unduly burdensome and overbroad. Subject to, and without waiving any other objections, FPL will respond to the extent the discovery pertains to FPL and FPL's rates or cost of service charged to FPL's customers. To the extent any responsive documents contain irrelevant parent and/or affiliate information as well as information related to FPL and FPL's rates or cost of service charged to its customers, FPL may redact the irrelevant parent and affiliate information from the responsive document(s).

Where any discovery request calls for production of documents, FPL objects to any production location other than the location established by FPL, at FPL's Tallahassee Office located at 134 W. Jefferson Street, Tallahassee, Florida, unless otherwise agreed by the parties.

FPL objects to each and every discovery request and any instructions that purport to expand FPL's obligations under applicable law.

In addition, FPL reserves its right to count discovery requests and their sub-parts, as permitted under the applicable rules of procedure and the Order Establishing Procedure that will presumably be issued following the filing of the Petition in this docket, in determining whether it is obligated to respond to additional discovery requests served by any party.

FPL expressly reserves and does not waive any and all objections it may have to the admissibility, authenticity or relevancy of the information provided in its responses.

II. Specific Objections

A. Interrogatories

Interrogatory No. 16: FPL objects to OPC's Interrogatory No. 16 on the ground that it is overbroad and not reasonably calculated to lead to the discovery of admissible evidence. Interrogatory No. 16 requests information regarding "every outage" occurring since January 1, 2020. This issues in this docket concern cost recovery through the Fuel (and Purchased Power) Cost Recovery ("FCR") Clause. Outages for which FPL does not seek cost recovery through the FCR Clause are outside the scope of this docket. Subject to this objection, FPL will respond with relevant information within the scope of this docket.

B. Requests for Production

Request for Production No. 20. OPC's Request for Production No. 20 seeks documents identified in Interrogatory No. 16. Accordingly, FPL incorporates herein its objection to Interrogatory No. 16.

Respectfully submitted this 3rd day of August 2022.

Respectfully submitted,

By: s/ Maria Jose Moncada

Maria Jose Moncada
Managing Attorney
maria.moncada@fpl.com
Fla. Bar No. 0773301
David M. Lee
Senior Attorney
david.lee@fpl.com
Fla. Bar No. 103152
Florida Power & Light Company
700 Universe Boulevard
Juno Beach, Florida 33408-0420
Telephone: (561) 304-5795
Facsimile: (561) 691-7135

CERTIFICATE OF SERVICE
Docket 20220001-EI

I HEREBY CERTIFY that a true and correct copy of the foregoing has been furnished by electronic delivery on this 3rd day of August 2022 to the following:

Suzanne Brownless
Ryan Sandy
Division of Legal Services
Florida Public Service Commission
2540 Shumard Oak Blvd.
Tallahassee, Florida 32399-0850
sbrownle@psc.state.fl.us
rsandy@psc.state.fl.us

Paula K. Brown, Manager
Tampa Electric Company
Regulatory Coordinator
Post Office Box 111
Tampa, Florida 33601-0111
regdept@tecoenergy.com

J. Jeffrey Wahlen
Malcolm N. Means
Virginia Ponder
Ausley & McMullen
P.O. Box 391
Tallahassee, Florida 32302
jwahlen@ausley.com
mmeans@ausley.com
vponder@ausley.com
Attorneys for Tampa Electric Company

Michelle D. Napier
Director, Regulatory Affairs Distribution
Florida Public Utilities Company
1635 Meathe Drive
West Palm Beach, FL33411
mnapier@fpuc.com

Mike Cassel
Vice President/Government and
Regulatory Affairs
Florida Public Utilities Company
208 Wildlight Ave.
Yulee, Florida 32097
mcassel@fpuc.com

Richard Gentry
Patricia A. Christensen
Charles J. Rehwinkel
Stephanie Morse
Mary Wessling
Office of Public Counsel
c/o The Florida Legislature
111 West Madison St., Room 812
Tallahassee, FL 32399-1400
gentry.richard@leg.state.fl.us
christensen.patty@leg.state.fl.us
rehwinkel.charles@leg.state.fl.us
morse.stephanie@leg.state.fl.us
wessling.mary@leg.state.fl.us

Robert L. Pickels
Duke Energy Florida
106 East College Avenue, Suite 800
Tallahassee, Florida 32301
robert.pickels@duke-energy.com
FLRegulatoryLegal@duke-energy.com

Dianne M. Triplett
299 First Avenue North
St. Petersburg, Florida 33701
dianne.triplett@duke-energy.com

Matthew R. Bernier
Stephanie A. Cuello
Duke Energy Florida
106 East College Avenue, Suite 800
Tallahassee, Florida 32301
robert.pickels@duke-energy.com
matthew.bernier@duke-energy.com
stephanie.cuello@duke-energy.com
FLRegulatoryLegal@duke-energy.com
Attorneys for Duke Energy Florida

Beth Keating
Gunster Law Firm
215 South Monroe St., Suite 601
Tallahassee, Florida 32301-1804
bkeating@gunster.com
**Attorneys for Florida Public Utilities
Company**

Jon C. Moyle, Jr.
Moyle Law Firm, P.A.
118 North Gadsden Street
Tallahassee, FL 32301
jmoyle@moylelaw.com
mqualls@moylelaw.com
**Attorneys for Florida Industrial Power
Users Group**

Peter J. Mattheis
Michael K. Lavanga
Joseph R. Briscar
Stone Mattheis Xenopoulos & Brew, PC
1025 Thomas Jefferson Street, NW
Eighth Floor, West Tower
Washington, DC 20007-5201
pjm@smxblaw.com
mkl@smxblaw.com
jrb@smxblaw.com
Attorneys for Nucor Steel Florida, Inc.

James W. Brew
Laura Wynn Baker
Stone Mattheis Xenopoulos & Brew, P.C.
1025 Thomas Jefferson Street, NW
Eighth Floor, West Tower
Washington, DC 20007
jbrew@smxblaw.com
lwb@smxblaw.com
**Attorneys for PCS Phosphate-White
Springs**

Robert Scheffel Wright
John T. LaVia, III
Gardner, Bist, Bowden, Dee
LaVia, Wright, Perry & Harper, P.A.
1300 Thomaswood Drive
Tallahassee, FL 32308
schef@gbwlegal.com
jlavia@gbwlegal.com
**Attorneys for The Florida Retail
Federation**

By: s/ Maria Jose Moncada
Maria Jose Moncada
Florida Bar No. 073301

**Florida Power & Light Company
Docket No. 20220001-EI
OPC's 2nd Set of Interrogatories
Interrogatory No. 16
Page 1 of 1**

QUESTION:

Gain/Loss Form. Please identify each outage occurring since January 1, 2020 (including any that were on going in which a Gain/Loss Form substantially similar to the document beginning at Bates No. FCR22-002142 was utilized) and identify the documents containing the Gain/Loss form utilized for each outage.

RESPONSE:

See FPL's Objections filed August 3, 2022. Subject to those objections:
Turkey Point Unit 3 Cycle 31 Refueling Outage – Gain loss Walk T3R31
Turkey Point Unit 3 Cycle 32 Refueling Outage – Gain loss Walk T3R32
Turkey Point Unit 4 Cycle 31 Refueling Outage – Gain loss Walk T4R31
Turkey Point Unit 4 Cycle 32 Refueling Outage – Gain loss Walk T4R32
Turkey Point Unit 4 Cycle 33 Refueling Outage – Gain loss Walk T4R33
Turkey Point Unit 4 – PTN Volt Reg forced outage
St. Lucie Unit1 Cycle 30 Refueling Outage – PSL Gain loss Walk L1R30
St. Lucie Unit 2 Cycle 25 Refueling Outage – PSL Gain loss Walk L2R25
St. Lucie Unit 2 Cycle 26 Refueling Outage – PSL Gain loss Walk L2R26
St. Lucie Unit 2 - CEA 2022 unplanned outage

STRIKE ENTIRE PAGE

Florida Power & Light Company
Docket No. 20220001-EI
OPC's Second Request for Production of Documents
Request No. 20
Page 1 of 1

QUESTION:

Gain/Loss Form. Please produce each document identified in Interrogatory No. 16.

RESPONSE:

See FPL's Objections filed August 3, 2022. Subject to those objections, documents responsive to this request are provided as Bates FCR-22-002433 – FCR-22-003132.

BEFORE THE FLORIDA PUBLIC SERVICE COMMISSION

In re: Fuel and Purchased Power Cost Recovery
Clause with Generating Performance Incentive Factor

Docket No: 20220001-EI

Filed: April 1, 2022

**PETITION FOR APPROVAL OF FUEL COST
RECOVERY AND CAPACITY COST RECOVERY NET
FINAL TRUE-UPS FOR THE PERIOD ENDING DECEMBER 2021
AND 2021 ASSET OPTIMIZATION INCENTIVE MECHANISM RESULTS**

Florida Power & Light Company (“FPL”) hereby petitions this Commission for approval of (1) pre-consolidated FPL’s Fuel and Purchased Power Cost Recovery (“FCR”) final net true-up under-recovery of \$11,681,957 for the period ending December 2021, (2) pre-consolidated FPL’s Capacity Cost Recovery (“CCR”) final net true-up over-recovery of \$3,634,686 for the period ending December 2021, (3) pre-consolidated Gulf Power Company’s (“Gulf”) FCR final net true-up over-recovery of \$21,938,913 for the period ending December 2021, (4) Gulf’s CCR final net true-up under-recovery of \$3,937,996 for the period ending December 2021, and (5) retention and recovery of \$13,855,504 of the \$63,092,506 total 2021 Asset Optimization Program gains, representing 60% of the gains above \$40 million threshold established in Order Nos. PSC-13-0023-S-EI and PSC-16-0560-AS-EI. The FPL and Gulf FCR final true-ups result in a combined over-recovery of \$10,256,956, and CCR final true-ups result in a combined under-recovery of \$303,310. FPL incorporates the prepared testimony and exhibits of FPL witnesses Renae B. Deaton, Gerard J. Yupp and Dean Curtland.

1. Although Gulf was legally merged with and into FPL effective January 1, 2021, Gulf and FPL remained separate ratemaking entities and, as such, each filed its 2021 FCR and CCR costs and factors separately in Docket No. 20210001. Therefore, FPL is providing and seeking approval of final true-ups of the 2021 FCR and CCR costs for both pre-consolidated FPL

and pre-consolidated Gulf. The combined 2021 net final true-ups will be included in the calculation of FPL's 2023 FCR and CCR factors, which will be filed later this year.¹

2. The calculations and supporting documentation for FPL's and Gulf's FCR and CCR final net true-up amounts for the period ending December 2021 are contained in the prepared testimony and exhibits of witness Deaton.

3. By Order No. 2021-0460-PCO-EI dated December 15, 2021, the Commission approved FPL's 2022 mid-course correction petition, which included revised 2021 actual/estimated true-ups for FPL and Gulf. FPL's revised 2021 FCR actual/estimated true-up was an under-recovery of \$585,866,364. FPL's actual final true-up, including interest, for the period January 2021 through December 2021 is an under-recovery of \$597,548,321. The \$597,548,321 actual under-recovery, less the revised actual/estimated under-recovery of \$585,866,364, results in an FCR final net true-up under-recovery of \$11,681,957 for FPL.²

4. Gulf's revised 2021 FCR actual/estimated true-up approved on December 15, 2021 was an under-recovery of \$103,719,775. Gulf's actual final true-up, including interest, for the period January 2021 through December 2021 is an under-recovery of \$81,780,862. The \$81,780,862 actual under-recovery, less Gulf's revised actual/estimated under-recovery of \$103,719,775 results in a FCR final net true-up over-recovery of \$21,938,913 for Gulf.

¹ Effective January 1, 2022, the rates and tariffs of Gulf and FPL were consolidated and unified, all former Gulf customers became FPL customers, and Gulf ceased to exist as a separate ratemaking entity. *See* Order Nos. PSC-2021-0446-S-EI and PSC-2021-04464A-S-EI issued in Docket No. 20210015. Accordingly, the FCR and CCR factors for FPL and Gulf were consolidated effective January 1, 2022. *See* Order Nos. PSC-2021-0460-PCO-EI and PSC-2021-0442-FOF-EI issued in Docket No. 20210001.

² FPL will not pursue recovery of the replacement power costs associated with outages at the Turkey Point Nuclear Unit 3 in August of 2020, which were a subject of Issue 2K in Order No. PSC-2021-0403-PHO-EI, and will refund with interest any associated costs collected from customers when its fuel factor is next reset.



**UNITED STATES
NUCLEAR REGULATORY COMMISSION
WASHINGTON, D.C. 20555-0001**

September 12, 2019

EA-18-066
EA-19-045

Mr. Mano Nazar, President
and Chief Nuclear Officer
Nuclear Division
Florida Power & Light Company
Mail Stop: EX/JB
700 Universe Blvd.
Juno Beach, FL 33408

**SUBJECT: ST. LUCIE PLANT – NOTICE OF VIOLATION AND PROPOSED
IMPOSITION OF CIVIL PENALTY - \$232,000 (NRC INVESTIGATION
REPORT NUMBERS 2-2017-024 AND 2-2019-009)**

Dear Mr. Nazar:

This letter refers to two investigations conducted by the U.S. Nuclear Regulatory Commission (NRC) Office of Investigations (OI) related to Florida Power and Light's (FPL) St. Lucie Nuclear Plant. The purposes of the investigations were to determine whether a contract employee at St. Lucie Nuclear Plant was the subject of employment discrimination in violation of Title 10 of the *Code of Federal Regulations* (10 CFR) 50.7, "Employee protection" (OI Report No. 2-2017-024); and to determine whether a FPL senior licensee executive, or potentially others, deliberately provided the NRC with incomplete and inaccurate information in violation of 10 CFR 50.9, "Completeness and accuracy of information" (OI Report No. 2-2019-009).

For OI investigation 2-2017-024 (dated May 21, 2018), NRC determined that the FPL Regional Vice President (VP) – Operations, deliberately caused a contract employee's assignment to be cancelled the week of March 13, 2017. The cancellation occurred, in part, because the contract employee entered a concern into St. Lucie's corrective action program on March 13, 2017. In summary, a Framatome (formerly known as Areva) part-time employee asserted that his work re-assignment was cancelled in March 2017, after submitting a condition report at FPL's St. Lucie nuclear plant. The contract employee, as the lead supervisor for Framatome's refueling team at St. Lucie, had been pre-scheduled by Framatome and FPL to transfer to Turkey Point nuclear plant for the same role. On March 13, 2017, the contract employee submitted a condition report that documented concerns with the St. Lucie's requirement for Framatome personnel to wear multiple dosimeters while performing refueling work. On March 16, 2017, the contract employee's re-assignment to Turkey Point was cancelled.

The NRC determined that the contract employee's work assignment was cancelled, at least in part, for raising a nuclear safety concern via the submission of a condition report. The cancellation of the contract employee's work assignment is a violation of 10 CFR 50.7.

M. Nazar

2

Additionally, the NRC determined that the deliberate actions of the former FPL Regional VP - Operations caused FPL to be in violation of 10 CFR 50.7. Our determinations were based on information developed during the investigation and information that you provided during the predecisional enforcement conference (PEC) process.

Ol's investigation documented that FPL's Regional VP - Operations sent an e-mail to the Framatome VP of Outage Services on March 14, 2017. The body of the FPL VP's e-mail included the text of the condition report that was submitted by the contract employee on March 13, 2017, and a related question regarding the condition report. The evidence documented that both VPs acknowledged the sending, and the receipt, of the March 14th e-mail. Additionally, the evidence indicated that the FP&L Regional VP initiated a subsequent phone discussion on March 14th with the Framatome VP of Outage Services which included discussing the contract employee's reassignment to Turkey Point. Ol's evidence documented that on March 14th the Framatome VP (Outage Services), contacted the Framatome Manager, PWR/Reactor Services and directed him to inform the contract employee that his re-assignment was cancelled. On March 16th, the Framatome Manager (PWR/Reactor Services), informed the employee that his re-assignment to Turkey Point was cancelled. The temporal proximity of the concerned individual's (CI) submission of the condition report and the initiation of the adverse action by an FPL executive and the subsequent implementation of the adverse action within a few days by Framatome management was deemed a discriminatory act. The NRC determined that neither FPL or Framatome presented sufficient evidence to support their assertions that the adverse employment action was justified for business reasons.

During the PECs, FPL and Framatome denied that a violation of 10 CFR 50.7 occurred. Generally, FPL and Framatome asserted that (1) the protected activity was not a contributing factor to any adverse personnel action and that the NRC's only basis was "temporal proximity," (2) that Framatome's reassignment of the contractor was justified by legitimate safety (business) reasons; (3) and that the contractor did not suffer an adverse personnel action, but instead was reassigned. The NRC's determination that a violation occurred was based on factors such as: the CI's subordinates, coworkers, and superiors, both at Framatome and FPL, almost universally spoke very highly of him; neither FPL or Framatome produced sufficient evidence to indicate that the performance of the CI, or the performance of his reactor services team, was a significant concern during the refueling outage; and, the staff noted that the former FPL Regional VP - Operation's testimony differed significantly from the testimony of other witnesses and included inconsistencies that undercut his credibility and specifically discredited his assertions that the CI's removal from the Turkey Point outage was unrelated to his protected activities. The NRC determined that FPL's and Framatome's assertion that the contractor's reassignment was justified by legitimate safety (business) reasons was not reasonable because of evidence which indicated that the 2017 spring refueling outage was the shortest outage for St. Lucie in many years and that the reactor services portion of the outage, managed by the contract employee, incurred only minimal scheduling delays. Lastly, the NRC determined that the contractor did suffer an adverse action when he was removed from the Turkey Point outage. When the contractor was directed not to go to Turkey Point, it was not clear if Framatome would provide an alternative work assignment. The individual is a part-time Framatome employee and is only paid when he works. A reasonable person would view the cancellation of the workers pre-scheduled transfer as a materially adverse action and one that could potentially chill others who raise nuclear safety concerns.

The NRC considers violations of 10 CFR 50.7 significant because of the potential that individuals might not raise safety issues for fear of retaliation. Based on the deliberate action

M. Nazar

3

and the level of manager involved in the adverse action, this violation has been categorized in accordance with the “NRC Enforcement Policy,” at Severity Level II. See NRC Enforcement Policy, Violation Example 6.10.b.1.

In accordance with the NRC Enforcement Policy, a base civil penalty in the amount of \$232,000 is considered for the Severity Level II violation of 10 CFR 50.7, “Employee Protection.” The NRC considered both the Identification and Corrective Action factors with respect to this willful violation in accordance with the civil penalty assessment process in Section 2.3.4 of the NRC Enforcement Policy. Credit for Identification is not appropriate, since the violation was identified by the NRC via the Agency’s allegation program. The NRC determined *Corrective Action* credit was warranted due to corrective actions initiated by FPL. Completed corrective actions include an Employee Concerns Program (ECP) investigation, safety conscious work environment (SCWE) surveys in St. Lucie and Turkey Point radiation protection departments, and training of senior nuclear managers. Planned corrective actions include items such as a fleet-wide communication that reinforces the SCWE policy, ECP personnel training, ECP third-party audits, and the creation of a personnel action review board process to review certain employment actions involving contractor personnel brought to FPL’s attention. Therefore, to emphasize the importance of prompt identification and correction of violations, the NRC has determined, as provided for in Section 2.3.4 of the NRC Enforcement Policy, to issue the enclosed Notice of Violation (Notice) and Proposed Imposition of Civil Penalty of \$232,000, which is the base civil penalty amount for the Severity Level II violation.

If you disagree with this enforcement sanction, you may deny the violation, as described in the enclosed Notice, or you may request alternative dispute resolution (ADR) with the NRC in an attempt to resolve this issue. ADR is a general term encompassing various techniques for resolving conflicts using a neutral third party. The technique that the NRC has decided to employ is mediation. Mediation is a voluntary, informal process in which a trained neutral (the “mediator”) works with parties to help them reach resolution. If the parties agree to use ADR, they select a mutually agreeable neutral mediator who has no stake in the outcome and no power to make decisions. Mediation gives parties an opportunity to discuss issues, clear up misunderstandings, be creative, find areas of agreement, and reach a final resolution of the issues. Additional information concerning the NRC’s ADR program can be found at <http://www.nrc.gov/about-nrc/regulatory/enforcement/adr.html>.

The Institute on Conflict Resolution (ICR) at Cornell University has agreed to facilitate the NRC’s program as a neutral third party. If you are interested in pursuing this issue through the ADR program, please contact: (1) the ICR at (877) 733-9415; and (2) David Jones at (301) 287-9525 within 10 days of the date of this letter. You may also contact both ICR and Mr. Jones for additional information. If you decide to participate in ADR, your submitted signed agreement to mediate using the NRC ADR program will stay the 30-day time period for payment of the civil penalty until the ADR process is completed.

You are required to respond to this letter and should follow the instructions specified in the enclosed Notice when preparing your response. If you have additional information that you believe the NRC should consider, you may provide it in your response to the Notice. The NRC will use your response, in part, to determine whether further enforcement action is necessary to ensure compliance with regulatory requirements.

M. Nazar

4

In accordance with 10 CFR 2.390 of the NRC's "Rules of Practice," a copy of this letter, its enclosures, and your response, if you choose to provide one, will be made available electronically for public inspection in the NRC Public Document Room and from ADAMS, accessible from the NRC Web site at <http://www.nrc.gov/reading-rm/adams.html>. The NRC will also make available, within ADAMS, the letter describing the apparent violation, dated October 19, 2018, and the NRC presentation from the PEC held on February 4, 2019. To the extent possible, your response, if provided, should not include any personal privacy or proprietary information so that it can be made available to the public without redaction. The NRC also includes significant enforcement actions on its Web site at <http://www.nrc.gov/reading-rm/doc-collections/enforcement/actions/>.

Concerning OI Report No. 2-2019-009 (dated April 23, 2019), the NRC determined that a former FPL Corporate Support Vice President, whose previous position was FPL Regional VP-Operations (discussed above), deliberately provided incomplete and inaccurate information to FPL that was subsequently submitted by FPL to the NRC. Had the inaccurate information not been detected it would have adversely impacted NRC's deliberations for OI investigation 2-2017-024. In a letter dated December 10, 2018, Agencywide Documents Access and Management System (ADAMS) Accession No. ML18346A182, FPL submitted to the NRC a photocopied journal that had been maintained by the then FPL Regional Vice President (VP) - Operations. The letter stated that the journal contained material that was highly relevant to the facts in OI investigation 2-2017-024. Subsequently, in a letter dated January 17, 2019 (ADAMS No. ML#19024A085), FPL stated that they had developed cause to question the authenticity of the outage journal. The evidence developed during OI's investigation (2-2019-009) revealed that the FPL Regional VP - Operations deliberately submitted a journal to FPL which contained incomplete and inaccurate information. Had the inaccurate information not been detected it would have adversely impacted NRC's deliberations for the St. Lucie discrimination case (OI investigation 2-2017-024).

Section 2.3.11, "Inaccurate and Incomplete Information," of the Enforcement Policy, states that "*Generally, if the matter was promptly identified and corrected by the licensee or applicant before the NRC relies on the information, or before the NRC raises a question about the information, no enforcement action will be taken for the initial inaccurate or incomplete information.*" Therefore, the NRC determined that pursuant to Section 2.3.11 of the Enforcement Policy, no further action should be taken with respect to FPL for OI Report 2-2019-009) because FPL (1) proactively identified the concern and promptly informed the NRC, (2) withdrew the journal prior to it adversely impacting the NRC's enforcement proceedings for the discrimination case (OI Report 2-2017-024), (3) conducted a detailed investigation which included the hiring of a forensics analyst, and (4) took appropriate personnel actions. For NRC enforcement actions involving the FPL VP, see (ADAMS No. ML19234A334).

M. Nazar

5

If you have any questions concerning either of these matters, please contact David Jones of my staff at (301) 287-9525.

Sincerely,

/RA/

George A. Wilson, Director
Office of Enforcement

Docket No. 50-335 and 50-389
License No. DPR-67 and NPF-16

Enclosures:

1. Notice of Violation and Proposed Imposition of Civil Penalty
2. NUREG/BR-0254 Payment Methods
3. NUREG/BR-0317 Rev. 2, Enforcement Alternative Dispute Resolution Program

M. Nazar

6

SUBJECT: ST. LUCIE PLANT – NOTICE OF VIOLATION AND PROPOSED
IMPOSITION OF CIVIL PENALTY - \$232,000 (NRC INVESTIGATION
REPORT NUMBERS 2-2017-024 AND 2-2019-009)
DATE: September 12, 2019

DISTRIBUTION: WITHOUT ENCLOSURES

P. Moulding, OGC	S. Kirkwood, OGC	M. Kowal, RII
S. Sparks, RII	B. Hughes, NRR	D. Aird, NRR
D. Willis, OE	OE R/F	

Publicly Available

ADAMS Accession No.: ML19234A332

OFFICE	OE/EB	OE/CRB	OGC	OE/D
NAME	DJones	DSolorio	SKirkwood	GWilson
DATE	8/30/19	9/9/19	8/22/19	9/12/19

OFFICIAL RECORD COPY

NOTICE OF VIOLATION
AND
PROPOSED IMPOSITION OF CIVIL PENALTY

St. Lucie Plant
Juno Beach, FL

Docket No. 050-335/389
License No. DPR-67/NPF-16
EA-18-066

During an NRC investigation completed on May 21, 2018, a violation of an NRC requirement was identified. In accordance with the NRC Enforcement Policy, the NRC proposes to impose a civil penalty pursuant to Section 234 of the Atomic Energy Act of 1954, as amended (Act), 42 U.S.C. 2282, and 10 CFR 2.205. The particular violation and associated civil penalty is set forth below:

A. 10 CFR 50.7(a), states, in part, that "Discrimination by a Commission licensee, an applicant for a Commission license, or a contractor or subcontractor of a Commission licensee or applicant against an employee for engaging in certain protected activities is prohibited. Discrimination includes discharge and other actions that relate to compensation, terms, conditions, or privileges of employment." The protected activities are established in section 211 of the Energy Reorganization Act of 1974, as amended, and in general are related to the administration or enforcement of a requirement imposed under the Atomic Energy Act or the Energy Reorganization Act.

10 CFR 50.7(a)(1)(i), states, in part, that the protected activities include but are not limited to providing the Commission or his or her employer information about alleged violations of either of the statutes named in paragraph (a) introductory text of this section or possible violations of requirements imposed under either of those statutes.

A Florida Power and Light Regional Vice President - Operations deliberately discriminated against a Framatome (formerly known as Areva) contract employee for engaging in a protected activity in March of 2017. Specifically, a contract employee who raised safety concerns during the St. Lucie refueling outage had a work assignment to Turkey Point Nuclear Plant cancelled shortly after submitting a condition report. The actions of FPL management were, in part, based on the contractor's engagement in a protected activity.

This is a Severity Level II violation (Enforcement Policy Sections 2.2.1.d, 6.10).
Civil Penalty - \$232,000.

Pursuant to the provisions of 10 CFR 2.201, Florida Power & Light is hereby required to submit a written statement or explanation to the Director, Office of Enforcement, U.S. Nuclear Regulatory Commission, with a copy to the Document Control Desk, Washington, DC 20555-0001, within 30 days of the date of this Notice of Violation and Proposed Imposition of Civil Penalty. This reply should be clearly marked as a "Reply to a Notice of Violation (EA-18-066)" and should include for the violation: (1) the reason for the violation, or, if contested, the basis for disputing the violation or severity level; (2) the corrective steps that have been taken and the results achieved; (3) the corrective steps that will be taken to avoid further violations; (4) your plan and schedule for completing short and long term corrective actions and (5) the date when full compliance will be achieved.

Enclosure 1

Your response may reference or include previous docketed correspondence, if the correspondence adequately addresses the required response. If an adequate reply is not received within the time specified in this Notice, the NRC may issue an order or a Demand for Information requiring you to explain why your license should not be modified, suspended, or revoked or why the NRC should not take other action as may be proper. Consideration may be given to extending the response time for good cause shown.

Florida Power & Light may pay the civil penalty in accordance with NUREG/BR-0254 and by submitting to the Director, Office of Enforcement, U.S. Nuclear Regulatory Commission, a statement indicating when and by what method payment was made, or may protest imposition of the civil penalty in whole or in part, by a written answer within 30 days of the date of this Notice addressed to the Director, Office of Enforcement, U.S. Nuclear Regulatory Commission. Should the Licensee fail to answer within 30 days of the date of this Notice, the NRC will issue an order imposing the civil penalty. Should the Licensee elect to file an answer in accordance with 10 CFR 2.205 protesting the civil penalty, in whole or in part, such answer should be clearly marked as an "Answer to a Notice of Violation (EA-18-066)" and may: (1) deny the violation listed in this Notice, in whole or in part; (2) demonstrate extenuating circumstances; (3) show error in this Notice; or (4) show other reasons why the penalty should not be imposed. In addition to protesting the civil penalty in whole or in part, such answer may request remission or mitigation of the penalty.

In requesting mitigation of the proposed penalty, the response should address the factors addressed in Section 2.3.4 of the Enforcement Policy. Any written answer addressing these factors pursuant to 10 CFR 2.205 should be set forth separately from the statement or explanation provided pursuant to 10 CFR 2.201, but may incorporate parts of the 10 CFR 2.201 reply by specific reference (e.g., citing page and paragraph numbers) to avoid repetition. The attention of the Licensee is directed to the other provisions of 10 CFR 2.205 regarding the procedure for imposing (a) civil penalty.

Upon failure to pay any civil penalty which subsequently has been determined in accordance with the applicable provisions of 10 CFR 2.205 to be due, this matter may be referred to the Attorney General, and the penalty, unless compromised, remitted, or mitigated, may be collected by civil action pursuant to Section 234c of the Act, 42 U.S.C. 2282c.

The responses noted above, i.e., Reply to Notice of Violation, Statement as to payment of civil penalty(ies), and Answer to a Notice of Violation, should be addressed to: Director, Office of Enforcement, U.S. Nuclear Regulatory Commission, One White Flint North, 11555 Rockville, MD 20852-2738, with a copy to the Regional Administrator, U.S., Nuclear Regulatory Commission, Region II, 245 Peachtree Center Ave. N.E., Suite 1200, Atlanta, GA 30303, and the U.S. Nuclear Regulatory Commission, ATTN: Document Control Desk, Washington, DC 20555-0001, and a copy to the NRC Resident Inspector at the facility that is the subject of this Notice."

Your response will be made available electronically for public inspection in the NRC Public Document Room or in the NRC's Agencywide Documents Access and Management System (ADAMS), accessible from the NRC Web site at <http://www.nrc.gov/reading-rm/adams.html>. To the extent possible, your response should not include any personal privacy or proprietary information. If personal privacy or proprietary information is necessary to provide an acceptable

response, then please provide a bracketed copy of your response that identifies the information that should be protected and a redacted copy of your response that deletes such information. If you request that such material is withheld from public disclosure, you must specifically identify the portions of your response that you seek to have withheld and provide in detail the bases for your claim (e.g., explain why the disclosure of information will create an unwarranted invasion of personal privacy or provide the information required by 10 CFR 2.390(b) to support a request for withholding confidential commercial or financial information). If safeguards information is necessary to provide an acceptable response, please provide the level of protection described in 10 CFR 73.21.

In accordance with 10 CFR 19.11, you may be required to post this Notice within two working days of receipt.

Dated this 12th day of September, 2019

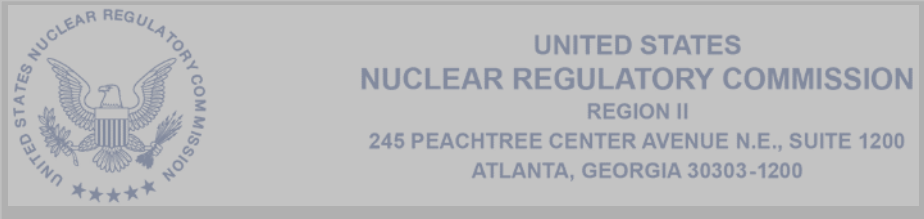

April 6, 2021

EA-20-043
EA-20-150

Mr. Don Moul, Executive Vice President
Nuclear Division and Chief Nuclear Officer
Florida Power & Light Company
Mail Stop: EX/JB
700 Universe Blvd.
Juno Beach, FL 33408

SUBJECT: TURKEY POINT NUCLEAR GENERATING STATION - NOTICE OF VIOLATION AND PROPOSED IMPOSITION OF CIVIL PENALTY – \$150,000, NRC INSPECTION REPORT NOS. 05000250/2021090 AND 05000251/2021090; INVESTIGATION REPORT NOS. 2-2019-011 AND 2-2019-025; EXERCISE OF ENFORCEMENT DISCRETION

Dear Mr. Moul:

This letter is in reference to three apparent violations (AVs) identified as a result of two separate investigations completed by the Nuclear Regulatory Commission's (NRC) Office of Investigations (OI) concerning activities at Florida Power and Light Company's (FPL) Turkey Point Nuclear Generating Station (Turkey Point).

The first AV was related to an OI investigation completed on March 10, 2020. The investigation was conducted to determine if three mechanics at Turkey Point Unit 3 deliberately falsified information in a work order package associated with the January 23, 2019, inspection and maintenance of a safety-related check valve. The details of the AV and investigation are documented in NRC Inspection Report 05000250/2020011 and 05000251/2020011, issued on July 23, 2020 (Agencywide Documents Access and Management System (ADAMS) Accession No. ML20205L316). The AV involved the recording of inaccurate/incomplete information associated with maintenance and inspection of a safety-related auxiliary feedwater check valve, contrary to the requirements of 10 CFR 50.9(a), "Completeness and Accuracy of Information."

On March 3, 2021, a pre-decisional enforcement conference (PEC) was conducted via teleconference at FPL's request, with members of your staff to discuss the AV. The conference was closed to public observation because the subject matter was related to an OI report, the details of which have not been publicly released. At the conference, FPL accepted the violation as described in the inspection report including the willful aspects, provided its assessment of the significance of the violation, discussed the root and contributing causes, provided additional circumstances regarding identification of the violation, and discussed several corrective actions taken in response to the incident.

D. Moul

2

The second and third AVs were related to an OI investigation completed on November 10, 2020. The investigation was conducted to determine whether two instrumentation and control (I&C) technicians at Turkey Point deliberately provided incomplete or inaccurate information in maintenance records, and whether the I&C technicians, an I&C Supervisor, and the I&C Department Head deliberately failed to immediately notify the main control room of a mispositioned plant component, as required by plant procedures. The mispositioned plant component incident occurred on July 10, 2019, when I&C technicians mistakenly began maintenance on a pressure switch associated with the Unit 3C charging pump instead of the 4C charging pump. The details of the second and third AV and the OI investigation are documented in NRC Inspection Report 05000250/2021011 and 05000251/2021011, issued on February 4, 2021 (ADAMS Accession No. ML21036A158). The two AVs involved: (1) the failure to comply with plant procedure OP-AA-100-1002, "Plant Status Control Management," as required by 10 CFR Part 50, Appendix B, Criterion V, "Instructions, Procedures, and Drawings," when the I&C Supervisor and Department Head failed to notify the main control room of a mispositioned plant component; and (2) the failure of two I&C technicians to maintain a complete and accurate record of maintenance performed on the 4C charging pump, contrary to the requirements of 10 CFR 50.9(a), "Completeness and Accuracy of Information."

In response to the second and third AVs, FPL provided a written response by letter dated March 5, 2021. FPL agreed that both violations occurred as documented in the inspection report and agreed with the willful aspects. FPL provided additional details regarding the seriousness of the incident, its assessment of the significance, root causes, circumstances regarding identification of the violation and corrective actions. FPL's letter also suggested that the NRC exercise its discretion to reduce the severity level and civil penalty, if any, to acknowledge FPL's initial identification of the issues and its corrective actions stemming from the previous event of January 23, 2019. FPL noted that these corrective actions helped to identify the events associated with the second OI report and pointed out the very low safety significance of those events and FPL's prompt and comprehensive additional corrective actions.

Based on the information developed during the investigations, the information that FPL provided during the PEC, and the information provided by FPL in its written response of March 5, 2021, the NRC has determined that three violations of NRC requirements occurred. The violations are cited in the enclosed Notice of Violation and Proposed Imposition of Civil Penalty (Notice) and the circumstances surrounding these violations are described in detail in the above referenced inspection reports.

The first violation documented in the Notice occurred on January 23, 2019, when mechanics assigned to work on auxiliary feedwater check valve AFWU-3-017 recorded inaccurate information in work order 40542353. The NRC concluded that the actions of FPL staff were deliberate and caused FPL to be in violation of 10 CFR 50.9(a), "Completeness and Accuracy of Information."

The second and third violations documented in the Notice occurred on July 10, 2019, after I&C technicians mistakenly began maintenance on the wrong charging pump. Upon being notified by the I&C technicians, the I&C Supervisor and the I&C Department Head deliberately failed to immediately notify the Operations Shift Manager that I&C technicians assigned to work on the 4C charging pump inadvertently manipulated a pressure switch on the 3C charging pump. These actions were in violation of 10 CFR 50, Appendix B, Criterion V, "Instructions, Procedures, and Drawings," and FPL plant procedure OP-AA-100-1002, "Plant Status Control Management." The third violation involved two FPL I&C employees who deliberately maintained information recorded in the PS-4-201C Work Order Task Description (WOTD) and

D. Moul

3

Breaker/Switch/Valve Manipulation Form (Form 747) associated with Work Order (WO) Package 40632818-01 that was not complete and accurate in all material respects, as required by 10 CFR 50.9(a), "Completeness and Accuracy of Information." Specifically, information recorded on both documents was inaccurate because it reflected work performed on the Unit 4C charging pump pressure switch (PS-4-201C), when in fact no work was performed on PS-4-201C.

The violations did not cause any actual consequences to the plant. Regarding the violation occurring on January 23, 2019, FPL confirmed that the safety related auxiliary feedwater check valve was not degraded, had not negatively impacted plant operation, and FPL promptly completed the WO after the incident without any impact to the plant. Regarding the two violations occurring on July 10, 2019, FPL's Unit 3 licensed main control room operators responded promptly and in accordance with plant procedures to the charging pump trip by placing another charging pump in service. The two violations did not result in a plant transient and caused only minimal impact to plant operation.

However, the potential consequences of the three violations, when viewed individually and together, are significant and concerning to the NRC. All three violations involved deliberate misconduct on the part of multiple individuals. One violation (Violation No. 2 of the Notice) was directly attributable to individuals in a supervisory and/or management role. As discussed in the NRC Enforcement Policy, willful violations are of particular concern because the NRC's regulatory program is based on licensees and their contractors, employees, and agents acting with integrity and communicating with candor. In light of the above and because the violations are interrelated to a common cause involving integrity issues among multiple FPL staff and inadequate management oversight, these violations have been categorized as a Severity Level III problem in accordance with the NRC Enforcement Policy.

In accordance with the Enforcement Policy, a base civil penalty in the amount of \$150,000 is considered for a Severity Level III violation or problem. Because the violations were willful, the NRC considered whether credit was warranted for *Identification* and *Corrective Action* in accordance with the civil penalty assessment process in Section 2.3.4 of the Enforcement Policy.

At the PEC of March 3, 2021, FPL highlighted that the violation of January 23, 2019, associated with inaccurate information in work order 40542353 would have remained undetected but for FPL's efforts to thoroughly investigate the issue to ensure that all work steps were completed in all respects. FPL also noted that its investigation expanded well beyond the original concern brought forth by NRC, resulting in FPL's identification of the falsified maintenance record. In reviewing the information presented by FPL at the PEC, and related investigation and inspection information, the NRC agrees with FPL that credit should be granted for the civil penalty assessment factor of *Identification*. Regarding the two violations associated with the second OI report, identification credit is warranted to reflect FPL's efforts to identify both violations occurring on July 10, 2019, within hours of the occurrence of the incident. Based on the above, the NRC concluded that credit is warranted for the civil penalty assessment factor of *Identification* for the Severity Level III problem documented in the Notice.

Regarding the civil penalty assessment factor of *Corrective Action*, at the PEC of March 3, 2021, FPL identified a number of site-specific corrective actions taken in response to Violation No. 1 of the Notice, including but not limited to: (1) FPL performed an immediate investigation into the incident; (2) FPL reviewed safety-related work completed by the Turkey Point Maintenance department for the three months prior to the January 2019 incident, and reviewed

D. Moul

4

safety-related work completed by the three mechanics involved; (3) Turkey Point managers held department meetings with all employees in 2019, including contractors, to address the importance of integrity and trust; (4) FPL completed training with all Turkey Point employees covering 10 CFR 50.5 and 10 CFR 50.9 and the consequences of violating those requirements in 2019; (5) Turkey Point leadership completed a case study on the incident of January 23, 2019; and (6) FPL denied site access and issued disciplinary actions for the individuals involved. The NRC concluded that these actions reflect an appropriate, graduated approach to address causes known by FPL to exist at that time, and were commensurate with the significance of the January 23, 2019, incident. As such, credit is warranted for the civil penalty assessment factor of *Corrective Action* for this violation.

In response to the incident of July 10, 2019, and as documented in its written response of March 5, 2021, FPL conducted several layers of inquiry upon becoming aware of the incident, including but not limited to: (1) denying the individuals' unescorted site access, terminating their employment, and immediately having the former Site Vice President share the incident in small sessions with station personnel; (2) performing a Common Cause Evaluation (CCE) of the incident, including an assessment of the extent of condition by reviewing randomly selected work activities for Turkey Point's Security, Radiation Protection, Operations, and Chemistry departments; (3) updating fleet procedure AD-AA-103, "Nuclear Safety Culture Program," to include the Security and Emergency Preparedness Departments which is in addition to the already performed semi-annual verifications of randomly selected work activities across the NextEra fleet for the Maintenance, Operations, Radiation Protection and Chemistry Departments; (4) revising the Turkey Point Department Plan of the Day agendas to include integrity discussions; (5) developing and implementing leadership training for all supervisors, managers, General Maintenance Leaders and Nuclear Watch Engineers on identification of potential integrity events and the actions to take in response to potential integrity events; (6) issuing a fleet-wide communication from the Chief Nuclear Officer (CNO) regarding expectations for accurately performing and documenting work activities, focusing on the message, "Your Signature Is Your Word," followed by a series of communications from the CNO focused on Nuclear Safety Culture (NSC) topics, including the importance of integrity and the meaning of signatures on signed documents; (7) implementing an annual training requirement for all nuclear fleet employees regarding the "Value of Your Signature," which includes the importance of providing complete and accurate information to the NRC (10 CFR 50.9), deliberate misconduct (10 CFR 50.5), the potential consequences for violations of 10 CFR 50.5 and 10 CFR 50.9, the need to report errors to the control room and/or management, what it means to sign a quality record, and understanding electronic signatures; (8) revising the nuclear fleet's corrective action program condition report screening procedure, PI-AA-104-1000, to require causal analysis for substantiated NSC events; and (9) revising the NSC program procedure, AD-AA-103, to require the NSC Monitoring Panel to review of internal evaluations of substantiated integrity events and all NRC violations related to NSC. Based on the above, the NRC concluded that credit is warranted for the civil penalty assessment factor of *Corrective Action* for Violations No. 2 and 3 of the Notice, and for the Severity Level III problem.

The NRC normally would not propose a civil penalty for this Severity Level III problem, because credit is warranted for the civil penalty assessment factors of *Identification* and *Corrective Action*. However, the circumstances of the three violations are very concerning to the NRC for several reasons. In this case, a total of seven FPL employees engaged in deliberate misconduct involving two separate incidents, within approximately a six-month time period, which is indicative of a much wider NSC concern. As also mentioned above, willful violations are of particular concern because the NRC's regulatory program is based on licensees and their contractors, employees, and agents acting with integrity and communicating with candor. The

D. Moul

5

NRC also notes that FPL's supervisory oversight was not sufficient to instill an appropriate NSC at that time, and in fact supervisors also engaged in deliberate misconduct in the second and third violations. Finally, the NRC considers the deliberate behavior of an I&C supervisor and an I&C Department Head, who initially attempted to hide the incident and influenced others within the I&C department to participate in the concealment of the maintenance error of July 10, 2019, to be particularly concerning.

Consistent with Enforcement Policy Section 3.6, Use of Discretion in Determining the Amount of a Civil Penalty, the NRC has the flexibility to exercise enforcement discretion to propose a base civil penalty where application of the civil penalty assessment factors would otherwise result in zero penalty. In this case, the circumstances of the three violations reflect particularly poor licensee performance in multiple areas, including but not limited to the lack of integrity of multiple FPL employees, the absence of effective management oversight and appropriate work controls within the Maintenance department, the deliberate concealment of the violation by two FPL supervisors/managers, and a less than adequate NSC at that time. Additionally, one of the violations that occurred on July 19, 2019 (i.e., the 10 CFR 50.9 violation), is a repeat of the same type of violation that occurred on January 23, 2019, when multiple FPL employees also deliberately falsified plant records, and all three violations are related to a common root cause. As such, the NRC has concluded that the exercise of enforcement discretion is warranted to propose a base civil penalty in the amount of \$150,000.

Therefore, I have been authorized, after consultation with the Director, Office of Enforcement, to issue the enclosed Notice of Violation and Proposed Imposition of Civil Penalty (Notice) in the base amount of \$150,000 for the SL III problem.

If you disagree with this enforcement sanction, you may deny the violation, as described in the Notice, or you may request alternative dispute resolution (ADR) with the NRC in an attempt to resolve this issue. ADR is a general term encompassing various techniques for resolving conflicts using a neutral third party. The technique that the NRC has decided to employ is mediation. Mediation is a voluntary, informal process in which a trained neutral (the "mediator") works with parties to help them reach resolution. If the parties agree to use ADR, they select a mutually agreeable neutral mediator who has no stake in the outcome and no power to make decisions. Mediation gives parties an opportunity to discuss issues, clear up misunderstandings, be creative, find areas of agreement, and reach a final resolution of the issues. Additional information concerning the NRC's ADR program can be found at <http://www.nrc.gov/about-nrc/regulatory/enforcement/adr.html>.

The Institute on Conflict Resolution (ICR) at Cornell University has agreed to facilitate the NRC's program as a neutral third party. If you are interested in pursuing this issue through the ADR program, please contact: (1) the ICR at (877) 733-9415; and (2) Mr. David Dumbacher at (404) 997-4628 within 10 days of the date of this letter. You may also contact both ICR and Mr. Dumbacher for additional information. Your submitted signed agreement to mediate using the NRC ADR program will stay the 30-day time period for payment of the civil penalty and the required written response, as identified in the enclosed notice, until the ADR process is completed.

The NRC has concluded that information regarding (1) the reason for the violations; (2) the corrective steps that have been taken and the results achieved; (3) the corrective steps that will be taken; and (4) the date when full compliance was achieved was adequately addressed at the

D. Moul

6

pre-decisional enforcement conference and in FPL's letter of March 5, 2021. Therefore, you are not required to respond to this letter unless the description therein does not accurately reflect your corrective actions or your position. In that case, or if you choose to provide additional information, you should follow the instructions specified in the enclosed Notice.

For administrative purposes, this letter is issued as NRC IR 05000250/2021090 and 05000251/2021090. AV 05000250/2020011-01 has been re-designated as Notice of Violation (NOV) 05000250/2020011-01. AV 05000250,05000251/2021011-01 has been re-designated as NOV 05000250,05000251/2021011-01. AV 05000250,05000251/2021011-02 has been re-designated as NOV 05000250,05000251/2021011-02.

In accordance with 10 CFR 2.390 of the NRC's "Agency Rules of Practice and Procedure," a copy of this letter, its enclosures, and your response, if you choose to provide one, will be made available electronically for public inspection in the NRC Public Document Room and from the NRC's Agencywide Documents Access and Management System (ADAMS), accessible from the NRC Web site at <http://www.nrc.gov/reading-rm/adams.html>. To the extent possible, your response should not include any personal privacy, proprietary, or safeguards information so that it can be made available to the Public without redaction. The NRC also includes significant enforcement actions on its Web site at <http://www.nrc.gov/reading-rm/doc-collections/enforcement/actions/>.

If you have any questions concerning this matter, please contact Mr. David Dumbacher of my staff at (404) 997-4628.

Sincerely,

/RA/

Laura A. Dudes
Regional Administrator

Docket Nos.: 05000250, 05000251
License Nos.: DPR-31, DPR-41

Enclosures:

1. Notice of Violation and Proposed Imposition of Civil Penalty
2. NUREG/BR-0254 Payment Methods

cc: Distribution via ListServ

D. Moul

5

SUBJECT: TURKEY POINT NUCLEAR GENERATING STATION - NOTICE OF VIOLATION AND PROPOSED IMPOSITION OF CIVIL PENALTY – \$150,000, NRC INSPECTION REPORT NOS. 05000250/2021090 AND 05000251/2021090; INVESTIGATION REPORT NOS. 2-2019-011 AND 2-2019-025; EXERCISE OF ENFORCEMENT DISCRETION Dated April 6, 2021

DISTRIBUTION:

M. Doane, OEDO
Region II Regional Coordinator, OEDO
A. Veil, NRR
P. Moulding, OGC
M. Lemoncelli, OGC
D. Roberts, OEDO
R. Laufer, SECY
D. Decker, OCA
A. Moreno, OCA
All Regions Enforcement Coordinators
H. Harrington, OPA
T. Higgs, HQ:OI
A. Echavarria, HQ:OI
R. Feitel, OIG
B. Hughes, NRR
M. Simon, OGC
A. Vogel, OE
P. Snyder, OE
D. Jones, OE

L. Dudes, RII
J. Munday, RII
M. Miller, RII
M. Franke, RII
B. Venkataraman, RII
D. Dumbacher, RII
D. Orr, RII
R. Hannah, RII
D. Gasperson, RII
J. Pelchat, RII
S. Sparks, RII
S. Price, RII
M. Kowal, RII
L. Gibson, RII
S. Luina, RII OI
OEMAIL Resource
RidsNrrDirs Enforcement Resource
PUBLIC

ADAMS Accession No. ML21096A096

OFFICE	RII/DRP	RII/DRP	RII/DRP	RII/EICS	RII/ORA	OE
NAME	B.Venkataraman	T.Inverso	M.Miller	M.Kowal	S.Price	J. Peralta
DATE	3/24/2021	3/23/2021	3/23/2021	3/23/2021	3/25/2021	3/31/2021
OFFICE	OGC	NRR	RII/ORA			
NAME	M. Simon	R. Felts	L. Dudes			
DATE	3/31/2021	3/29/2021	4/6/2021			

OFFICIAL RECORD COPY

NOTICE OF VIOLATION
AND
PROPOSED IMPOSITION OF CIVIL PENALTY

Florida Power and Light Company
Turkey Point Nuclear Generating Station
Units 3 and 4

Docket Nos.: 50-250, 50-251
License Nos.: DPR-31, DRP-41
EA-20-043, EA-20-150

During an NRC investigation completed on March 10, 2020, and an NRC investigation completed on November 10, 2020, violations of NRC requirements were identified. In accordance with the NRC Enforcement Policy, the NRC proposes to impose a civil penalty of \$150,000 pursuant to Section 234 of the Atomic Energy Act of 1954, as amended (Act), 42 U.S.C. 2282, and 10 CFR 2.205. The particular violations and associated civil penalty are set forth below:

1. 10 CFR 50.9(a), "Complete and Accuracy of Information" states, in part, that information required by the Commission's regulations, orders, or license conditions to be maintained by the licensee shall be complete and accurate in all material respects.

Contrary to the above, on January 23, 2019, the licensee maintained information recorded in steps 4.6 and 4.11 of Work Order (WO) 40542353 that was not complete and accurate in all material respects. Specifically, step 4.6 of the WO was marked complete, yet the work was not performed using the Check Valve Data Sheet (CVDS). Additionally, for step 4.11, inaccurate information was recorded regarding the tools used in the Journeyman Work Report and inaccurate measurement values were recorded in the CVDS. Documents associated with WO 40542353 are records that the licensee is required to maintain pursuant to 10 CFR Part 50, Appendix B, Criterion XVII, "Quality Assurance Records." Records of inspections of safety-related equipment are material to the NRC because they indicate whether the licensee is performing quality-related and safety-related activities in accordance with its operating procedures and NRC regulations.

2. 10 CFR Part 50 Appendix B, Criterion V, "Instructions, Procedures, and Drawings" states that activities affecting quality shall be prescribed by documented instructions, procedures, or drawings, of a type appropriate to the circumstances and shall be accomplished in accordance with these instructions, procedures, or drawings.

Procedure OP-AA-100-1002, "Plant Status Control Management" (an FPL implemented safety-related procedure), Step 3.6.7, states, in part, that site personnel are to immediately notify the Operations Shift Manager of any inadvertent bumping or mispositioning of plant components.

Contrary to the above, on July 10, 2019, the reporting of a mispositioned plant component, an activity affecting quality, was not accomplished in accordance with procedure OP-AA-100-1002. Specifically, site personnel failed to immediately notify the Operations Shift Manager that Instrumentation and Controls (I&C) technicians assigned to work on the 4C charging pump inadvertently manipulated a pressure switch on the Unit 3C charging pump. The I&C technicians, I&C Supervisor and I&C Department Head had several opportunities to report the human performance error to the control room and failed to do so.

3. 10 CFR 50.9(a), "Complete and Accuracy of Information" states, in part, that information required by the Commission's regulations, orders, or license conditions to be maintained by the licensee shall be complete and accurate in all material respects.

Contrary to the above, on July 10, 2019, the licensee maintained information recorded in the in the Pressure Switch (PS) PS-4-201C Work Order Task Description (WOTD) and Breaker/Switch/Valve Manipulation Form (Form 747) associated with WO Package 40632818-01 that was not complete and accurate in all material respects. Specifically, information recorded on both documents was inaccurate because it reflected work performed on the Unit 4C charging pump pressure switch (PS-4-201C), when in fact no work was performed on PS-4-201C. Additionally, the WO contained no documentation or notes explaining that the steps were completed on the wrong component. Documents associated with WO Package 40632818-01 for the safety-related Unit 4C charging pump are records that the licensee is required to maintain pursuant to 10 CFR Part 50, Appendix B, Criterion XVII, "Quality Assurance Records." Records of maintenance of safety-related equipment are material to the NRC because they indicate whether the licensee is performing quality-related and safety-related activities in accordance with its operating procedures and NRC regulations.

This is a Severity Level III problem (Enforcement Policy Sections 2.2.1.d, 6.1, 6.9).
Civil Penalty - \$150,000.

The NRC has concluded that information regarding the reason for the violations, the corrective actions taken and planned to correct the violations and prevent recurrence and the date when full compliance was achieved was adequately addressed at the March 3, 2021, predecisional enforcement conference and in FPL's written response dated March 5, 2021. However, if the description therein does not accurately reflect your position or your corrective actions, you are required to submit a written statement or explanation pursuant to 10 CFR 2.201 within 30 days of the date of the letter transmitting this Notice of Violation. In that case, or if you choose to respond, clearly mark your response as a 'Reply to a Notice of Violation – EA-20-043, EA-20-150', and send it to the Director, Office of Enforcement, U.S. Nuclear Regulatory Commission, One White Flint North, 11555 Rockville, MD 20852-2738, with a copy to the Regional Administrator, U.S., Nuclear Regulatory Commission, Region II, 245 Peachtree Center Avenue, N. E., Suite 1200, Atlanta, GA, 30303, and the NRC Resident Inspector at the facility that is the subject of this Notice, and the Document Control Desk, Washington, DC 20555-0001.

FPL may pay the civil penalty proposed above in accordance with NUREG/BR-0254 and by submitting to the Director, Office of Enforcement, U.S. Nuclear Regulatory Commission, a statement indicating when and by what method payment was made, or may protest imposition of the civil penalty in whole or in part, by a written answer addressed to the Director, Office of Enforcement, U.S. Nuclear Regulatory Commission, within 30 days of the date of this Notice. Should FPL fail to answer within 30 days of the date of this Notice, the NRC will issue an order imposing the civil penalty. Should FPL elect to file an answer in accordance with 10 CFR 2.205 protesting the civil penalty, in whole or in part, such answer should be clearly marked as an "Answer to a Notice of Violation" and may: (1) deny the violations listed in this Notice, in whole or in part; (2) demonstrate extenuating circumstances; (3) show error in this Notice; or (4) show other reasons why the penalty should not be imposed. In addition to protesting the civil penalty in whole or in part, such answer may request remission or mitigation of the penalty.

In requesting mitigation of the proposed penalty, the response should address the factors discussed in Section 2.3.4 of the Enforcement Policy. Any written answer addressing these

factors pursuant to 10 CFR 2.205 should be set forth separately from the statement or explanation provided pursuant to 10 CFR 2.201, but may incorporate parts of the 10 CFR 2.201 reply by specific reference (e.g., citing page and paragraph numbers) to avoid repetition. The attention of FPL is directed to the other provisions of 10 CFR 2.205 regarding the procedure for imposing a civil penalty.

Upon failure to pay any civil penalty which subsequently has been determined in accordance with the applicable provisions of 10 CFR 2.205 to be due, this matter may be referred to the Attorney General, and the penalty, unless compromised, remitted, or mitigated, may be collected by civil action pursuant to Section 234c of the Act, 42 U.S.C. 2282c.

The responses noted above, i.e., Reply to Notice of Violation, Statement as to Payment of Civil Penalty, and Answer to a Notice of Violation, should be addressed to: Anton Vogel, Director, Office of Enforcement, U.S. Nuclear Regulatory Commission, One White Flint North, 11555 Rockville Pike, Rockville, MD 20852-2738, with a copy to the Regional Administrator, U.S. Nuclear Regulatory Commission, Region II, 245 Peachtree Center Avenue, N. E., Suite 1200, Atlanta, GA, 30303, and the NRC Resident Inspector at the facility that is subject to this Notice, and the Document Control Center, Washington, DC 20555-0001.

If you choose to respond, your response will be made available electronically for public inspection in the NRC Public Document Room or in the NRC's Agencywide Documents Access and Management System (ADAMS), accessible from the NRC Web site at <http://www.nrc.gov/reading-rm/adams.html>. To the extent possible, your response should not include any personal privacy or proprietary information so that it can be made available to the public without redaction. If personal privacy or proprietary information is necessary to provide an acceptable response, then please provide a bracketed copy of your response that identifies the information that should be protected and a redacted copy of your response that deletes such information. If you request that such material is withheld from public disclosure, you must specifically identify the portions of your response that you seek to have withheld and provide in detail the bases for your claim (e.g., explain why the disclosure of information will create an unwarranted invasion of personal privacy or provide the information required by 10 CFR 2.390(b) to support a request for withholding confidential commercial or financial information). If safeguards information is necessary to provide an acceptable response, please provide the level of protection described in 10 CFR 73.21.

In accordance with 10 CFR 19.11, you may be required to post this Notice within two working days of receipt.

Dated this 6th day of April 2021.

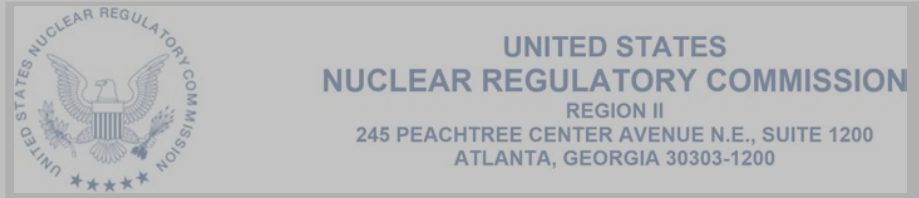

May 7, 2021

Mr. Don Moul
Executive Vice President, Nuclear Division and Chief Nuclear Officer
Florida Power & Light Company
Mail Stop: EX/JB
700 Universe Blvd.
Juno Beach, FL 33408

SUBJECT: TURKEY POINT UNITS 3 & 4 – INTEGRATED INSPECTION REPORT
05000250/2021001 AND 05000251/2021001 AND ASSESSMENT FOLLOW-UP
LETTER

Dear Mr. Moul:

On March 31, 2021, the U.S. Nuclear Regulatory Commission (NRC) completed an inspection at Turkey Point Units 3 & 4 and discussed the results of this inspection with Mr. Michael Pearce and other members of your staff. The results of this inspection are documented in the enclosed report.

One finding of very low safety significance (Green) is documented in this report. This finding involved a violation of NRC requirements. One Severity Level IV violation without an associated finding is documented in this report. We are treating these violations as non-cited violations (NCVs) consistent with Section 2.3.2 of the Enforcement Policy.

If you contest the violations or the significance or severity of the violations documented in this inspection report, you should provide a response within 30 days of the date of this inspection report, with the basis for your denial, to the U.S. Nuclear Regulatory Commission, ATTN: Document Control Desk, Washington, DC 20555-0001; with copies to the Regional Administrator, Region II; the Director, Office of Enforcement; and the NRC Resident Inspector at Turkey Point Units 3 & 4 .

If you disagree with a cross-cutting aspect assignment in this report, you should provide a response within 30 days of the date of this inspection report, with the basis for your disagreement, to the U.S. Nuclear Regulatory Commission, ATTN: Document Control Desk, Washington, DC 20555-0001; with copies to the Regional Administrator, Region II; and the NRC Resident Inspector at Turkey Point Units 3 & 4 .

As a result of its quarterly review of plant performance, which was completed on March 31, 2021, the NRC updated its assessment of Turkey Point Nuclear Plant Unit 3. The NRC's evaluation consisted of a review of performance indicators and inspection results. This letter informs you of the NRC's assessment of your facility. This letter supplements, but does not supersede, the annual assessment letter issued on March 3, 2021.

D. Moul

2

The NRC's review of Turkey Point Nuclear Plant Unit 3 identified that the Unplanned Scrams per 7000 Critical Hours performance indicator has crossed the green-to-white threshold. This was due to four unplanned scrams that occurred on August 17, 2020, August 19, 2020, August 20, 2020, and March 1, 2021. The NRC will be in contact to discuss specific planning and scheduling activities regarding this performance indicator and the anticipated 95001 inspection.

This letter, its enclosure, and your response (if any) will be made available for public inspection and copying at <http://www.nrc.gov/reading-rm/adams.html> and at the NRC Public Document Room in accordance with Title 10 of the *Code of Federal Regulations* 2.390, "Public Inspections, Exemptions, Requests for Withholding."

Please contact Mr. David Dumbacher at 404-997-4628 with any questions you have regarding this letter.

Sincerely,

/RA/

Mark S. Miller, Director,
Division of Reactor Projects

Docket Nos. 05000250 and 05000251
License Nos. DPR-31 and DPR-41

Enclosure:
As stated

cc w/ encl: Distribution via LISTSERV®

D. Moul

3

SUBJECT: TURKEY POINT UNITS 3 & 4 – INTEGRATED INSPECTION REPORT
05000250/2021001 AND 05000251/2021001 AND ASSESSMENT FOLLOW-UP
LETTER dated May 7, 2021

DISTRIBUTION:

M. Kowal, RII
S. Price, RII
L. Gibson, RII
RidsNrrPMTurkeyPoint Resource
RidsNrrDro Resource
PUBLIC

ADAMS ACCESSION NUMBER: **ML21127A186**

<input checked="" type="checkbox"/> SUNSI Review		<input checked="" type="checkbox"/> Non-Sensitive <input type="checkbox"/> Sensitive		<input checked="" type="checkbox"/> Publicly Available <input type="checkbox"/> Non-Publicly Available	
OFFICE	RII/DRP	RII/DRP	RII/DRP	RII/DRP	RII/DRP
NAME	R. Reyes	D. Orr	D. Dumbacher	J. Hamman	M. Miller
DATE	05/05/2021	05/05/2021	05/05/2021	05/05/2021	05/07/2021

OFFICIAL RECORD COPY

**U.S. NUCLEAR REGULATORY COMMISSION
Inspection Report**

Docket Numbers: 05000250 and 05000251

License Numbers: DPR-31 and DPR-41

Report Numbers: 05000250/2021001 and 05000251/2021001

Enterprise Identifier: I-2021-001-0081

Licensee: Florida Power & Light Company

Facility: Turkey Point Units 3 & 4

Location: Homestead, FL 33035

Inspection Dates: January 01, 2021 to March 31, 2021

Inspectors: C. Fontana, Emergency Preparedness Inspector
D. Orr, Senior Resident Inspector
R. Reyes, Resident Inspector
S. Sanchez, Senior Emergency Preparedness Inspector
J. Walker, Emergency Response Inspector

Approved By: David E. Dumbacher, Chief
Reactor Projects Branch 3
Division of Reactor Projects

Enclosure

SUMMARY

The U.S. Nuclear Regulatory Commission (NRC) continued monitoring the licensee’s performance by conducting an integrated inspection at Turkey Point Units 3 & 4 , in accordance with the Reactor Oversight Process. The Reactor Oversight Process is the NRC’s program for overseeing the safe operation of commercial nuclear power reactors. Refer to <https://www.nrc.gov/reactors/operating/oversight.html> for more information.

List of Findings and Violations

Failure to Maintain the Effectiveness of the Emergency Plan			
Cornerstone	Severity	Cross-Cutting Aspect	Report Section
Not Applicable	Severity Level IV NCV 05000250,05000251/2021001-01 Open	Not Applicable	71114.04
The inspectors identified a Severity Level IV (SL-IV) non-cited violation (NCV) of Title 10 of the Code of Federal Regulations (CFR), Part 50.54(q)(2), for failure to maintain the effectiveness of the Turkey Point Nuclear Station (TPN) Emergency Plan (E-Plan). Specifically, the licensee had not revised the E-Plan for a change to the number of Alert and Notification System (ANS) sirens.			

Failure to Correctly Verify the Component as Instructed in Work Order			
Cornerstone	Significance	Cross-Cutting Aspect	Report Section
Mitigating Systems	Green NCV 05000250,05000251/2021001-02 Open/Closed	[H.12] - Avoid Complacency	71152
A self-revealed Green Non-Cited Violation (NCV) of 10 CFR, Part 50, Appendix B, Criterion V, "Instructions, Procedures, and Drawings," was identified for the failure to correctly verify a component specified in a work order (WO). Specifically, instrument and control (I&C) technicians did not follow the proper verification steps in WO 40632818 and incorrectly conducted work on the 3C charging pump.			

Additional Tracking Items

Type	Issue Number	Title	Report Section	Status
URI	05000250/2021001-03	Unit 3 Automatic Reactor Trip due to Reactor Trip Breaker Cell Switch Malfunction	71153	Open
URI	05000250/2021001-04	Inadvertent Opening of 3A Steam Generator Feedwater Pump Recirculation Valves Causes a Rapid Decrease in Unit 3 Steam Generator Water Levels	71153	Open
LER	05000250/2020-002-00	LER 2020-002-00 for Turkey Point Unit 3 Manual Reactor Trip in Response to High	71153	Closed

		Steam Generator Level following Inadvertent Opening of Feedwater Heater Bypass Valve		
LER	05000250/2020-002-01	LER 2020-002-01 for Turkey Point, Unit 3, Manual Reactor Trip in Response to High Steam Generator Level following Inadvertent Opening of Feedwater Heater Bypass Valve (Rev 1)	71153	Closed
LER	05000250/2020-005-00	LER 2020-005-00 for Turkey Point Unit 3, Technical Specification Action Not Taken for Unrecognized Inoperable Source Range Channel	71153	Closed
LER	05000250/2020-005-01	LER 2020-005-01 for Turkey Point, Unit 3, Technical Specification Action Not Taken for Unrecognized Inoperable Source Range Channel (Rev 1)	71153	Closed

PLANT STATUS

Unit 3 began the inspection period at 55% of rated thermal power to facilitate main condenser water box tube repairs. Unit 3 was returned to rated thermal power on January 3, but was down-powered to 52% on February 2, due to high sodium concentrations recurring in all three steam generators. Unit 3 was returned to rated thermal power on February 9, after the licensee completed additional main condenser tube inspections and plugging to eliminate the source of sodium contamination in the condensate system. On March 1, Unit 3 experienced an automatic reactor trip at the conclusion of a routine test of the reactor protection system (RPS). The licensee determined a malfunction of the B-train reactor trip breaker cubicle cell switch during the RPS test restoration caused the reactor trip. The cell switch was replaced and Unit 3 returned to rated thermal power on March 5. On March 24, Unit 3 was down-powered to 85% when the 3A steam generator feedwater pump recirculation valves to the main condenser failed open in response to feedwater flow instruments being isolated to repair a steam leak. Unit 3 was returned to rated thermal power on March 25, and remained at, or near, rated thermal power for the remainder of the inspection period.

Unit 4 began the inspection period at rated thermal power. Unit 4 was down-powered to 82% on March 16, and to 72% on March 17, to replace the 4A condensate pump motor. Unit 4 was returned to rated thermal power on March 24, and remained at or near rated thermal power for the remainder of the inspection period.

INSPECTION SCOPES

Inspections were conducted using the appropriate portions of the inspection procedures (IPs) in effect at the beginning of the inspection unless otherwise noted. Currently approved IPs with their attached revision histories are located on the public website at <http://www.nrc.gov/reading-rm/doc-collections/insp-manual/inspection-procedure/index.html>. Samples were declared complete when the IP requirements most appropriate to the inspection activity were met consistent with Inspection Manual Chapter (IMC) 2515, "Light-Water Reactor Inspection Program - Operations Phase." The inspectors performed plant status activities described in IMC 2515, Appendix D, "Plant Status," and conducted routine reviews using IP 71152, "Problem Identification and Resolution." The inspectors reviewed selected procedures and records, observed activities, and interviewed personnel to assess licensee performance and compliance with Commission rules and regulations, license conditions, site procedures, and standards.

Starting on March 20, 2020, in response to the National Emergency declared by the President of the United States on the public health risks of the Coronavirus Disease 2019 (COVID-19), resident inspectors were directed to begin telework and to remotely access licensee information using available technology. During this time, the resident inspectors performed periodic site visits each week; conducted plant status activities as described in IMC 2515, Appendix D, "Plant Status"; observed risk-significant activities; and completed on-site portions of IPs. In addition, resident and regional baseline inspections were evaluated to determine if all or portions of the objectives and requirements stated in the IP could be performed remotely. If the inspections could be performed remotely, they were conducted per the applicable IP. In some cases, portions of an IP were completed remotely and on-site. The inspections documented below met the objectives and requirements for completion of the IP.

REACTOR SAFETY71111.04 - Equipment AlignmentPartial Walkdown Sample (IP Section 03.01) (4 Samples)

The inspectors evaluated system configurations during partial walkdowns of the following systems/trains:

- (1) 3B emergency diesel generator (EDG), and the 3A and 3B fuel oil transfer system alignment after fuel oil transfer operations and returning the 3B EDG back to an operable condition on January 11, 2021
- (2) Unit 3 and Unit 4 auxiliary feedwater (AFW) systems, after testing train 1 and restoring systems back to an operable status with the A AFW pump aligned to train 1 and the B and C AFW pumps aligned to train 2 on January 19, 2021
- (3) Unit 3 residual heat removal (RHR) system after 3-759A, 3A RHR heat exchanger outlet manual isolation valve, was cycled for 3-OSP-050.11, RHR/SI Manual Valve Operability Test, on February 16, 2021
- (4) 3B intake cooling water (ICW) and component cooling water (CCW) headers while the 3A ICW and CCW headers were out of service for maintenance on February 25, 2021

71111.05 - Fire ProtectionFire Area Walkdown and Inspection Sample (IP Section 03.01) (7 Samples)

The inspectors evaluated the implementation of the fire protection program by conducting a walkdown and performing a review to verify program compliance, equipment functionality, material condition, and operational readiness of the following fire areas:

- (1) Unit 3 and Unit 4 EDG buildings, (fire zones (FZs) 072, 073, 133 and 138) on January 05, 2021
- (2) 3B, 4A and 4B RHR pump rooms (FZs 013, 015 and 016) on January 11, 2021
- (3) Unit 3 and Unit 4 refueling water storage tank areas (FZ 123) on January 19, 2021
- (4) 3A RHR pump room, Unit 3 10' access to RHR pits and RHR heat exchanger pit (FZs 011, 012, and 013) on January 26 and February 16, 2021
- (5) Safety-related 3A, 3B, 4A, and 4B 125Vdc station batteries (FZs 103,110, 109,102); D-52 safety-related spare station battery (FZ 025A); Unit 3 and Unit 4 cable spreading room (FZ 098); and, the Unit 3 and Unit 4 reactor protection system motor generator set rooms (FZs 104 and 101) on February 04, 2021
- (6) Unit 3 and Unit 4 high head safety injection pump rooms, (FZs 052 and 053) on February 25, 2021
- (7) Unit 3 and Unit 4 charging pump (FZs 045 and 055) and containment spray pump rooms (FZs 031 and 038) on March 01, 2021

Fire Brigade Drill Performance Sample (IP Section 03.02) (1 Sample)

- (1) The inspectors evaluated the onsite fire brigade training and performance during an announced fire drill in the Unit 4 hydrogen seal oil system area, FZ 081, on March 01, 2021

71111.06 - Flood Protection Measures

Cable Degradation (IP Section 03.02) (1 Sample)

The inspectors evaluated cable submergence protection in:

- (1) Manholes 303, 304, 405, and 423 while the licensee implemented engineering change 294356, flood protection improvements, on February 02, 2021

71111.07A - Heat Sink Performance

Annual Review (IP Section 03.01) (1 Sample)

The inspectors evaluated readiness and performance of:

- (1) The Unit 4 CCW heat exchangers on February 1, 2021, and the Unit 3 CCW heat exchangers on February 19, 2021

71111.11Q - Licensed Operator Requalification Program and Licensed Operator Performance

Licensed Operator Performance in the Actual Plant/Main Control Room (IP Section 03.01) (1 Sample)

- (1) The inspectors observed and evaluated licensed operator performance in the Control Room during:
 - 3-GOP-100, Fast Load Reduction, and 3-ONOP-071.1, Secondary Chemistry Deviation from Limits, for a sodium intrusion originating in the 3AS main condenser hotwell on February 2, 2021
 - 3-EOP-E-0, Reactor Trip or Safety Injection, 3-EOP-ES-0.1, Reactor Trip Response, and 3-GOP-103 Power Operation to Hot Standby, for an automatic reactor trip on March 1, 2021
 - A reactor startup using 3-GOP-301, Hot Standby to Power Operation, on March 4, 2021
 - Main control room turnover and Unit 4 down power to 83% for the 4A condensate pump motor replacement using 4-GOP-103, Power Operation to Hot Standby, on March 16, 2021

Licensed Operator Requalification Training/Examinations (IP Section 03.02) (1 Sample)

- (1) The inspectors observed and evaluated a requalification training simulator scenario administered to an operating crew on February 15, 2021

71111.12 - Maintenance Effectiveness

Maintenance Effectiveness (IP Section 03.01) (1 Sample)

The inspectors evaluated the effectiveness of maintenance to ensure the following structures, systems, and components (SSCs) remain capable of performing their intended function:

- (1) Action Request (AR) 2379162, Main Condenser Maintenance Rule (a)(1)
Evaluation on March 30, 2021

Quality Control (IP Section 03.02) (1 Sample)

The inspectors evaluated the effectiveness of maintenance and quality control activities to ensure the following SSC remained capable of performing its intended function:

- (1) WO 40713743-08, install watertight seals at manhole 301, observed appropriate level of qualification of materials in use, and at the jobsite, to effect flood protection improvements on March 25, 2021

71111.13 - Maintenance Risk Assessments and Emergent Work Control

Risk Assessment and Management Sample (IP Section 03.01) (7 Samples)

The inspectors evaluated the accuracy and completeness of risk assessments for the following planned and emergent work activities to ensure configuration changes and appropriate work controls were addressed:

- (1) Unit 3 and Unit 4 on-line risk monitor (OLRM) with 3A ICW pump, 4CM motor-driven instrument air compressor, 4S231A 4A EDG control panel room air conditioner, and MOV-4-1403, AFW turbine steam supply from the A steam generator, out of service (OOS) on January 5, 2021
- (2) Unit 3 and Unit 4 OLRM with 4B emergency containment cooler, 3B CCW heat exchanger, and PCV-4-456, pressurizer power operated relief valve OOS on January 21, 2021
- (3) Unit 3 and Unit 4 OLRM with Unit 3 train 2 AFW feedwater flow control valves, 4C CCW heat exchanger, 4A EDG control panel room air conditioner unit 4S231A, and PCV-4-456, pressurizer power operated relief valve, OOS on January 27, 2021
- (4) Unit 3 and Unit 4 OLRM with 3CM, motor-driven instrument air compressor, E233 water chiller unit for electrical equipment room AHU-78, and PCV-4-456, pressurizer power operated relief valve OOS on February 19, 2021
- (5) Unit 3 and Unit 4 OLRM during the 3B CCW pump motor high risk heavy load lift over safety-related systems on February 18, 2021
- (6) Unit 3 and Unit 4 OLRM with 3A ICW and CCW headers, 3C motor-driven instrument air compressor, E233 water chiller unit for electrical equipment room AHU-78, 4A charging pump, and PCV-4-456, pressurizer power operated relief valve OOS on February 26, 2021
- (7) Unit 3 and Unit 4 OLRM with 3B ICW pump, 4B charging pump, Unit 4 train 1 AFW flow control valves, E233 water chiller unit for electrical equipment room AHU-V78, and PCV-4-456, pressurizer power operated relief valve OOS on March 10, 2021

71111.15 - Operability Determinations and Functionality Assessments

Operability Determination or Functionality Assessment (IP Section 03.01) (6 Samples)

The inspectors evaluated the licensee's justifications and actions associated with the following operability determinations and functionality assessments:

- (1) AR 2380722, 2327425, and 1864215 Steam Leak from Upstream Side of Check Valve 3-10-398 During AFW Pump Testing on January 14, 2021
- (2) AR 2377269, 3B ICW Pump Low Discharge Flow Rate on February 03, 2021
- (3) AR 2382650, Unit 3 TC-432C1, Overtemperature Trip, and TC-432C2, Overtemperature Rod Stop, Setpoint and Reset Minimum Unsatisfactory on February 12, 2021
- (4) AR 2382952, 3A CCW Pump Inboard Bearing Water Shield Found Backwards on February 18, 2021
- (5) AR 2380012, Turkey Point Cooling Canal Silt Deposits on February 19, 2021
- (6) AR 2386577, 3B ICW Pump Sole Plate Inspection Identified Degradation on March 24, 2021

71111.18 - Plant Modifications

Temporary Modifications and/or Permanent Modifications (IP Section 03.01 and/or 03.02) (1 Sample)

- (1) Engineering Change 295954, Install Permanent Unit 3 Reactor Trip and Bypass Breakers Contacts Test Points to Support RPS Testing, reviewed on March 4, 2021

71111.19 - Post-Maintenance Testing

Post-Maintenance Test Sample (IP Section 03.01) (6 Samples)

The inspectors evaluated the following post-maintenance test activities to verify system operability and functionality:

- (1) Work Order (WO) 40673626, 40806 Reverse Starter Maintenance for AFW Pump Steam Supply from 4B Steam Generator, MOV-4-1404, post-maintenance test (PMT) performed within WO standard and reviewed on February 04, 2021
- (2) WO 40746281, Replace PCV-4-1705, Nitrogen (N2) Backup Pressure Control Valve to Train 2 Unit 4 AFW Flow Control Valve, PMT performed using section 4.3 of 4-OSP-075.7, Auxiliary Feedwater Train 2 Backup Nitrogen Test and reviewed on March 15, 2021
- (3) WO 40755945, 3B ICW Pump Replacement, PMT performed using 3-OSP-019.1, Intake Cooling Water Inservice Test and reviewed on March 16, 2021
- (4) WO 40679187, MOV-3-1405, AFW Pump Steam Supply from 3C Steam Generator, Stem Lubrication and Actuator Gearbox Grease Inspection, PMT performed within WO standard and reviewed on March 22, 2021
- (5) WO 40698263, Replace PT-4-484, 4B Main Steam Line Pressure Transmitter, PMT performed using 4-SMI-072.01, P-4-468, P-4-474, P-4-484 and P-4-494 Steam Pressures Channel Calibration, Protection Channel II and reviewed on March 22, 2021
- (6) WOs 40766915 and 40686024, Unit 3 B Reactor Trip Breaker and Cell Switch Replacements, PMT performed using 3-SMI-049.01B, Train B Reactor Protection System Logic Test and reviewed on March 24, 2021

71111.22 - Surveillance Testing

The inspectors evaluated the following surveillance tests:

Surveillance Tests (other) (IP Section 03.01) (3 Samples)

- (1) 3-OSP-023.1, Diesel Generator Operability Test (3A EDG Normal Start Test) on January 15, 2021
- (2) 4-OSP-075.2, Auxiliary Feedwater Train 2 Operability Verification and 4-OSP-075.9, C AFW Overspeed Test on January 20, 2021
- (3) 4-OSP-068.2, Containment Spray Gas Accumulation Management Program; 0-OSP-202.3, Safety Injection Pump and Piping Venting; and, 4-OSP-202.2, RHR Pump and Piping Venting on January 22, 2021

Inservice Testing (IP Section 03.01) (2 Samples)

- (1) 3-OSP-019.1, Intake Cooling Water Inservice Test (Sections 7.2 ICW Pump 3B and Discharge Check Valve Test) quarterly tests that were performed on June 04, 2020, August 08, 2020, and December 03, 2020. Review completed on February 02, 2021.
- (2) 3-OSP-068.5B, 3B Containment Spray Pump Inservice Test on February 04, 2021

71114.01 - Exercise Evaluation

Inspection Review (IP Section 02.01-02.11) (1 Sample)

- (1) The inspectors evaluated the biennial emergency plan exercise during the week of February 8, 2021. The simulated scenario began with an explosion and fire that caused damage to the 3B intake cooling water pump motor. This met the conditions for declaring an Alert. Subsequently, a reactor coolant system (RCS) leak slowly increased until charging pumps were unable to maintain RCS inventory, thus meeting the conditions for manually shutting down the reactor & initiating safety injection. With four control rods stuck out of the reactor core and radiation monitors increasing (indicative of fuel clad damage), the conditions for declaring a Site Area Emergency were met. When a containment purge exhaust valve seal deteriorated and began to leak by, conditions for a General Emergency were met, and the Offsite Response Organizations were able to demonstrate their ability to implement emergency actions.

71114.04 - Emergency Action Level and Emergency Plan Changes

Inspection Review (IP Section 02.01-02.03) (1 Sample)

- (1) The inspectors reviewed and evaluated Emergency Action Level, Emergency Plan, and Emergency Plan Implementing Procedure changes during the week of February 8, 2021. This evaluation does not constitute NRC approval.

71114.06 - Drill Evaluation

Drill/Training Evolution Observation (IP Section 03.02) (1 Sample)

The inspectors evaluated:

- (1) Emergency classification and notification to local counties and Florida State during licensed operator continuing training in the control room simulator on February 15, 2021

71114.08 - Exercise Evaluation Scenario Review

Inspection Review (IP Section 02.01 - 02.04) (1 Sample)

- (1) The inspectors reviewed and evaluated in-office, the proposed scenario for the biennial emergency plan exercise at least 30 days prior to the day of the exercise.

OTHER ACTIVITIES – BASELINE

71151 - Performance Indicator Verification

The inspectors verified licensee performance indicators submittals listed below:

EP01: Drill/Exercise Performance (IP Section 03.12) (1 Sample)

- (1) Unit 3 January 1, 2020, through December 31, 2020
Unit 4 January 1, 2020, through December 31, 2020

IE01: Unplanned Scrams per 7000 Critical Hours Sample (IP Section 03.01) (2 Samples)

- (1) Unit 3 January 1, 2020 through December 31, 2020
- (2) Unit 4 January 1, 2020 through December 31, 2020

EP02: ERO Drill Participation (IP Section 03.13) (1 Sample)

- (1) Unit 3 January 1, 2020, through December 31, 2020
Unit 4 January 1, 2020, through December 31, 2020

IE03: Unplanned Power Changes per 7000 Critical Hours Sample (IP Section 03.02) (2 Samples)

- (1) Unit 3 January 1, 2020 through December 31, 2020
- (2) Unit 4 January 1, 2020 through December 31, 2020

EP03: Alert & Notification System Reliability (IP Section 03.14) (1 Sample)

- (1) Unit 3 January 1, 2020, through December 31, 2020
Unit 4 January 1, 2020, through December 31, 2020

IE04: Unplanned Scrams with Complications Sample (IP Section 03.03) (2 Samples)

- (1) Unit 3 January 1, 2020 through December 31, 2020
- (2) Unit 4 January 1, 2020 through December 31, 2020

71153 - Follow-up of Events and Notices of Enforcement Discretion

Event Follow-up (IP Section 03.01) (2 Samples)

- (1) The inspectors responded to the main control room and evaluated a Unit 3 automatic reactor trip from an automatic turbine trip that occurred during restoration from a routine test of the reactor protection system on March 1, 2021.
- (2) The inspectors evaluated a Unit 3 manual turbine runback to 85% in response to unexpected and rapid steam generator water level decrease in all three steam generators which was caused by a rapid reduction in steam generator feedwater flow due to the unanticipated opening of the 3A steam generator feedwater pump recirculation to condenser flow control valves, CV-3-1415 and CV-3-1416, on March 24, 2021. CV-3-1415 and CV-3-1416, which were earlier placed in manual operation to facilitate isolating feedwater flow instruments FT-3-1416A/B/and C, transferred to automatic control and fully opened when FT-3-1416A/B/and C indicated zero feedwater flow.

Event Report (IP Section 03.02) (2 Samples)

The inspectors evaluated the following licensee event reports (LERs):

- (1) LER 05000250/2020-002-00 and -01, Manual Reactor Trip in Response to High Steam Generator Level following Inadvertent Opening of Feedwater Heater Bypass Valve, (ADAMS Accession Nos. ML20267A235 and ML21064A212). The inspection conclusions associated with Revision 00 and 01 of this LER are documented in Inspection Report 05000250/2020050 and 05000251/2020050 (ADAMS Accession No. ML20344A126).
- (2) LER 05000250/2020-005-00 and -01, Technical Specification Action Not Taken for Unrecognized Inoperable Source Range Channel, (ADAMS Accession Nos. ML20289A294 and ML21064A218). The inspection conclusions associated with Revision 00 and 01 of this LER are documented in Inspection Report 05000250/2020050 and 05000251/2020050 (ADAMS Accession No. ML20344A126).

INSPECTION RESULTS

Failure to Maintain the Effectiveness of the Emergency Plan			
Cornerstone	Severity	Cross-Cutting Aspect	Report Section
Not Applicable	Severity Level IV NCV 05000250,05000251/2021001-01 Open/Closed	Not Applicable	71114.04
The inspectors identified a Severity Level IV (SL-IV) non-cited violation (NCV) of Title 10 of the Code of Federal Regulations (CFR), Part 50.54(q)(2), for failure to maintain the effectiveness of the Turkey Point Nuclear Station Emergency Plan (E-Plan). Specifically, the licensee had not revised the E-Plan for a change to the number of Alert and Notification System (ANS) sirens.			
<u>Description:</u> While performing a detailed review of a corrective action program document (AR 02344404) generated from the last emergency preparedness inspection, the inspectors identified that the licensee had not updated their E-Plan to correctly reflect the number of ANS sirens in-place at TPN. The inspectors determined that Section 5.2.8 of the E-Plan states the ANS network consists of 45 pole mounted sirens and two indoor sirens. After reviewing siren performance indicator data, the inspectors noted that there are a total of 48			

sirens. The inspectors also determined that an additional pole mounted siren (siren 50) was added in December 2015, but the licensee failed to update the E-Plan ANS network description to reflect the most current information. From December 2015 to present, there were several opportunities for the licensee to identify and revise the E-Plan with the updated ANS information. Although maintenance and testing of the sirens continued, and proper functionality of the ANS was maintained, the inspectors determined that this issue was a violation for failure to maintain the effectiveness of the TPN E-Plan.

Corrective Actions: The licensee entered the issue into the corrective action program on February 11, 2020.

Corrective Action References: AR 02384000

Performance Assessment: The licensee’s failure to maintain the effectiveness of the TPN E-Plan was determined to impede the NRC’s ability to perform its regulatory function and is dispositioned using the Traditional Enforcement process.

Enforcement: This finding is a violation of NRC requirements, and because it has the potential for impacting the NRC’s ability to perform its regulatory function, traditional enforcement is applicable in accordance with Inspection Manual Chapter 0611 and 0612, Appendix B, Figure 2. This finding is determined to be a SL-IV violation in accordance with Section 6.6.d.1 of the Enforcement Policy because it involves the licensee’s ability to meet or implement a regulatory requirement not related to assessment or notification such that the effectiveness of the emergency plan is reduced.

Violation: Title 10 of the CFRs, Part 50.54(q)(2) states, in part, that a licensee shall follow and maintain the effectiveness of an E-Plan that meets the requirements in Appendix E to this part. Contrary to the above, the licensee failed to maintain the E-Plan, which is a higher tier document that must be maintained up-to-date and accurate at all times. Specifically, from December 2015 until February 2021, the TPN E-Plan had not been revised after a change was made to the number of ANS sirens.

Enforcement Action: This violation is being treated as a non-cited violation, consistent with Section 2.3.2 of the Enforcement Policy.

Failure to Correctly Verify the Component as Instructed in Work Order

Cornerstone	Significance	Cross-Cutting Aspect	Report Section
Mitigating Systems	Green NCV 05000250,05000251/2021001-02 Open/Closed	[H.12] - Avoid Complacency	71152
A self-revealed Green Non-Cited Violation (NCV) of 10 CFR, Part 50, Appendix B, Criterion V, "Instructions, Procedures, and Drawings," was identified for the failure to correctly verify a component specified in a work order (WO). Specifically, Instrument and Control (I&C) technicians did not follow the proper verification steps in WO 40632818 and incorrectly conducted work on the 3C charging pump.			
<u>Description:</u> On July 10, 2019, Unit 4 plant conditions were established to facilitate maintenance on the 4C charging pump. I&C technicians were authorized to complete WO 40632818 and calibrate pressure switch PS-4-201C, which provides a low oil pressure trip signal to the 4C charging pump. The I&C technicians did not follow the proper verification			

steps and incorrectly conducted work on the 3C charging pump. The Unit 3 chemical volume and control system was in a normal alignment with only the 3C charging pump, operating to maintain programmed reactor coolant system (RCS) pressurizer level and reactor coolant pump (RCP) seal injection.

The I&C technicians conducted a pre-job brief prior to performing the work order and discussed the work that was intended to be completed on the Unit 4C charging pump. The I&C technicians proceeded to the work area with the correct WO that described the work to be performed on Unit 4. However, the I&C technicians informed radiation protection (RP) of their intention to perform work on Unit 3. Despite being advised by RP that the charging pump maintenance outage was being performed on Unit 4, the I&C technicians still proceeded to the 3C charging pump.

Step 4.1 of WO 40632818 is listed as a critical step and instructs the performer to verify the intended component before starting the work. However, the I&C technicians did not recognize the appropriate Unit color identifiers, or the absence of a clearance boundary, did not properly match component identification numbers with the number listed in the WO, and did not recognize that the 3C charging pump was running. As a result, the I&C technicians manipulated an isolation valve for pressure switch PS-3-201C and loosened the test cap causing oil to flow out on the 3C charging pump. This result caused the I&C technicians to review the WO and to recognize that they were working on Unit 3 and not Unit 4.

The 3C charging pump trip on low oil pressure at about 10:09 a.m. was a silent trip. There are no local or control room alarms or annunciators associated with the low oil pressure condition. The reactor operator attempted to restart the 3C charging pump within twenty seconds, but it tripped again on low oil pressure because PS-3-201C was still vented. Within a minute, the reactor operator started the 3B charging pump restoring RCS makeup and RCP seal injection. An equipment operator reported to the Unit 3 charging pump room and it was recorded that the 3C charging pump did not appear to have anything obviously wrong with it. The I&C technicians had already left the area prior to the arrival of the equipment operator.

At 11:08 a.m., control room operators initiated an action request, AR 2320506, to investigate and correct, the anomalous 3C charging pump trip. At about 11:30 a.m., the I&C department head informed the maintenance director and site director that the 3C charging pump trip was the result of a human performance error. At 2:08 p.m., the control room operators returned the 3C charging pump to an operable condition.

Corrective Actions: FPL promptly initiated a human performance incident investigation and AR 2320534.

Corrective Action References: AR 2320534 and AR 2320506

Performance Assessment:

Performance Deficiency: The I&C technicians' failure to verify the correct component to be worked on before starting work, as instructed in Step 4.1 of WO 40632818, was a performance deficiency.

Screening: The inspectors determined the performance deficiency was more than minor because it was associated with the Human Performance attribute of the Mitigating Systems cornerstone and adversely affected the cornerstone objective to ensure the availability, reliability, and capability of systems that respond to initiating events to prevent undesirable

consequences. Specifically, I&C technicians failed to use the appropriate human performance tools to prevent working on the wrong component. The human performance error caused an unplanned unavailability of the Unit 3C charging pump.

Significance: The inspectors assessed the significance of the finding using Appendix A, “The Significance Determination Process (SDP) for Findings At-Power.” The inspectors screened this finding using IMC 0609, Attachment 4, “Initial Characterization of Findings,” for Mitigating Systems, and IMC 0609, Appendix A, “The Significance Determination Process (SDP) for Findings At-Power,” and determined the finding to be of very low safety significance (Green) because the finding did not represent a loss of the PRA function of one or more non-TS trains of equipment designated as risk-significant in accordance with the licensee’s maintenance rule program for greater than 3 days.

Cross-Cutting Aspect: H.12 - Avoid Complacency: Individuals recognize and plan for the possibility of mistakes, latent issues, and inherent risk, even while expecting successful outcomes. Individuals implement appropriate error reduction tools. The inspectors reviewed this performance deficiency for cross-cutting aspects as required by IMC 0310, “Aspects Within the Cross-Cutting Areas.” The I&C technicians did not implement the appropriate error reduction tools, despite multiple barriers and opportunities to prevent work on the wrong component.

Enforcement:

Violation: 10 CFR 50 Appendix B, Criterion V, states that activities affecting quality shall be prescribed by documented instructions, procedures, or drawings, of a type appropriate to the circumstances and shall be accomplished in accordance with these instructions, procedures, or drawings.

The maintenance being performed on the safety-related charging pump was being directed by WO 40632818. Step 4.1 of WO 40632818 instructed the worker to “Verify the component to be worked has been properly identified: PS-4-201C; Charging Pump 4P201C Interlock Control Pressure Switch in Charging Pump Room.”

Contrary to the above, on July 10, 2019, the licensee failed to accomplish Step 4.1 of WO 40632818, when the correct component was not properly identified. The I&C technicians failed to verify work was being accomplished on pressure switch PS-4-201C, causing a trip of the 3C charging pump when work was performed on pressure switch PS-3-201C.

Enforcement Action: This violation is being treated as a non-cited violation, consistent with Section 2.3.2 of the Enforcement Policy.

Unresolved Item (Open)	Unit 3 Automatic Reactor Trip due to Reactor Trip Breaker Cell Switch Malfunction URI 05000250/2021001-03	71153
------------------------	--	-------

Description: On March 1, 2021, at 1108 hours, Unit 3 experienced an unplanned reactor trip from 100% power. Restoration from a routine test of the reactor protection system (RPS) was in progress when the reactor trip occurred. All equipment required for the immediate reactor trip response functioned normally. The licensee determined a malfunction of the B-train reactor trip breaker cubicle cell switch during the RPS test restoration caused the reactor trip. An unresolved item (URI) is opened for additional review to determine if the cubicle cell switch malfunction and subsequent reactor trip was reasonably foreseeable and preventable

and to also determine if appropriate regulatory requirements or self-imposed standards were followed for maintenance of the reactor trip breakers and associated cell switches (i.e. to determine if a performance deficiency exists).

Planned Closure Actions: The NRC inspectors intend to review the licensee and vendor failure analysis of the B-train reactor trip breaker and associated cell switches. Additionally, the NRC inspectors intend to review the licensee's root cause analysis and other associated investigation documents and interview plant personnel.

Licensee Actions: Prior to reactor startup, the licensee replaced the B-train reactor trip breaker and cubicle cell switches. The A-train reactor trip breaker and A and B-train bypass breaker cubicles and cell switches were inspected, cleaned, and tested for proper operation. A modification to detect for a standing trip signal from cell switch contacts was installed in the Unit 3 reactor trip and bypass breakers. A similar modification to detect for a standing trip signal is intended for the Unit 4 breakers during the next Unit 4 refueling outage. The licensee contracted with the reactor trip breaker vendor to perform a failure analysis of the previously installed B-train reactor trip breaker and associated cubicle cell switches.

Corrective Action References: AR 2385529

Unresolved Item (Open)	Inadvertent Opening of 3A Steam Generator Feedwater Pump Recirculation Valves Causes a Rapid Decrease in Unit 3 Steam Generator Water Levels URI 05000250/2021001-04	71153
------------------------	---	-------

Description: On March 24, 2021, main control room operators performed a manual turbine runback on Unit 3 from 100% power to 85% in response to a rapid decrease in steam generator water levels. The unexpected and rapid water level decrease was caused by an equally unexpected and rapid reduction in steam generator feedwater flow due to the unanticipated opening of the 3A steam generator feedwater pump recirculation to condenser flow control valves, CV-3-1415 and CV-3-1416. CV-3-1415 and CV-3-1416 were placed in manual operation to facilitate isolating flow instruments, FT-3-1416A/B/and C. Plant operators recently identified a steam leak at a common process connection to all three flow transmitters. Plant engineers and operators assumed CV-3-1415 and CV-3-1416 would remain in manual operation but the distributed control system (DCS) logic by design overrode and fully opened CV-3-1415 and CV-3-1416. A URI is opened for additional review to determine if the DCS override function for CV-3-1415 and CV-3-1416 was reasonably foreseeable and the transient preventable, and to also determine if appropriate regulatory requirements or self-imposed standards were followed for isolating FT-3-1416A/B/and C (i.e. to determine if a performance deficiency exists).

Planned Closure Actions: The NRC inspectors intend to review the licensee human performance learning opportunity reviews and interview plant personnel. The inspectors also intend to review the DCS logic diagrams to understand the plant information available to engineers involved in the decision to isolate FT-3-1416A/B/and C.

Licensee Actions: The licensee completed a human performance investigation to understand the learning opportunities with those involved and the quality of the reviews that occurred prior to the isolating FT-3-1416A/B/and C. The licensee also completed an extent of condition review for other DCS controllers that can be overridden by process control logic to

automatic control from manual control and verified the logic was appropriate and operating procedures were adequate.

Corrective Action References: AR 2387840

EXIT MEETINGS AND DEBRIEFS

The inspectors verified no proprietary information was retained or documented in this report.

- On February 12, 2021, the inspectors presented the Emergency Preparedness Exercise Inspection results to Michael Pearce, Site Vice President and other members of the licensee staff.
- On April 13, 2021, the inspectors presented the Resident Inspector Quarterly Exit inspection results to Michael Pearce, Site Vice President and other members of the licensee staff.
- On April 22, 2021, the inspectors presented the Resident Inspector Quarterly Re-exit to Include Finding Related to 2019 Charging Pump Trip Issue inspection results to Michael Pearce, Site Vice President.

DOCUMENTS REVIEWED

Inspection Procedure	Type	Designation	Description or Title	Revision or Date
71114.04	Corrective Action Documents	AR 02344324,	NRC EP inspection identified potential violation	
	Corrective Action Documents Resulting from Inspection	AR 02384000	NRC identified potential SL-IV NCV	
	Procedures		Turkey Point Radiological Emergency Plan	66
		EP-AA-100-1007	Evaluation of Changes to the Emergency Plan, Supporting Documents, & Equipment (10 CFR 50.54(q))	Rev. 9

**Florida Power & Light Company
Docket No. 20220001-EI
OPC's Third Set of Interrogatories
Interrogatory No. 37
Page 1 of 1**

QUESTION:

Please provide the following staffing information for Turkey Point Unit 3:

- a. Provide the authorized number of staff included in the annual plant budget for the last five years.**
- b. Staffing levels on a monthly basis for the last five years.**
- c. Identify the personnel changes in each month over the last five years by staff assignment and reason for individual leaving a position.**

RESPONSE:

See FPL's Objections filed on August 8, 2022. Subject to those objections, see Attachment 1 to this Interrogatory for answers to subparts (a) and (b). FPL does not budget staff by unit, information provided is by site. FPL assumes the last five years to be 2017-2021.

**Florida Power & Light Company
Docket No. 20220001-EI
OPC's Third Set of Interrogatories
Interrogatory No. 38
Page 1 of 1**

QUESTION:

Please provide the following staffing information for Turkey Point Unit 4:

- a. Provide the authorized number of staff included in the annual plant budget for the last five years.**
- b. Staffing levels on a monthly basis for the last five years.**
- c. Identify the personnel changes in each month over the last five years by staff assignment and reason for individual leaving a position.**

RESPONSE:

See FPL's Objections filed on August 8, 2022. Subject to those objections, see FPL's response to OPC's Third Set of Interrogatories No. 37, including Attachment 1, for answers to subparts (a) and (b).

**Florida Power & Light Company
Docket No. 20220001-EI
OPC's Third Set of Interrogatories
Interrogatory No. 39
Page 1 of 1**

QUESTION:

Please provide the following staffing information for St Lucie Unit 1:

- a. Provide the authorized number of staff included in the annual plant budget for the last five years.**
- b. Staffing levels on a monthly basis for the last five years.**
- c. Identify the personnel changes in each month over the last five years by staff assignment and reason for individual leaving a position.**

RESPONSE:

See FPL's Objections filed on August 8, 2022. Subject to those objections, see FPL's response to OPC's Third Set of Interrogatories No. 37, including Attachment 1, for answers to subparts (a) and (b).

.

**Florida Power & Light Company
Docket No. 20220001-EI
OPC's Third Set of Interrogatories
Interrogatory No. 40
Page 1 of 1**

QUESTION:

Please provide the following staffing information for St. Lucie Unit 2:

- a. Provide the authorized number of staff included in the annual plant budget for the last five years.**
- b. Staffing levels on a monthly basis for the last five years.**
- c. Identify the personnel changes in each month over the last five years by staff assignment and reason for individual leaving a position**

RESPONSE:

See FPL's Objections filed on August 8, 2022. Subject to those objections, see FPL's response to OPC's Third Set of Interrogatories No. 37, including Attachment 1, for answers to subparts (a) and (b).

**Florida Power & Light Company
 Docket No. 20220001-EI
 OPC's Third Set of Interrogatories
 Interrogatory No. 37
 Attachment 1 of 1
 Page 1 of 3**

	*Time	Headcount Actual (A)	Headcount 2017 Approved Budget (B)	Headcount 2018 Approved Budget (C)	Headcount 2019 Approved Budget (D)
St. Lucie	Jan 2017	636.0	649.0		
	Feb 2017	696.0	649.0		
	Mar 2017	692.0	649.0		
	Apr 2017	639.0	649.0		
	May 2017	633.0	654.0		
	Jun 2017	617.0	654.0		
	Jul 2017	620.0	654.0		
	Aug 2017	618.0	649.0		
	Sep 2017	609.0	649.0		
	Oct 2017	606.0	649.0		
	Nov 2017	603.0	649.0		
	Dec 2017	588.0	649.0		
	Jan 2018	593.0		594.0	
	Feb 2018	609.0		594.0	
	Mar 2018	662.0		593.0	
	Apr 2018	598.0		593.0	
	May 2018	587.0		596.0	
	Jun 2018	581.0		596.0	
	Jul 2018	576.0		590.0	
	Aug 2018	640.0		590.0	
	Sep 2018	610.0		587.0	
	Oct 2018	569.0		587.0	
	Nov 2018	565.0		587.0	
	Dec 2018	526.0		587.0	
	Jan 2019	525.0			511.0
	Feb 2019	518.0			511.0
	Mar 2019	513.0			506.0
	Apr 2019	510.0			506.0
	May 2019	510.0			506.0
	Jun 2019	509.0			506.0
	Jul 2019	507.0			506.0
	Aug 2019	500.0			506.0
	Sep 2019	519.0			506.0
	Oct 2019	577.0			506.0
	Nov 2019	506.0			506.0
	Dec 2019	503.0			506.0

**Florida Power & Light Company
 Docket No. 20220001-EI
 OPC's Third Set of Interrogatories
 Interrogatory No. 37
 Attachment 1 of 1
 Page 2 of 3**

	*Time	Headcount Actual (A)	Headcount 2017 Approved Budget (B)	Headcount 2018 Approved Budget (C)	Headcount 2019 Approved Budget (D)
Turkey Point	Jan 2017	613.0	648.0		
	Feb 2017	601.0	652.0		
	Mar 2017	640.0	656.0		
	Apr 2017	614.0	655.0		
	May 2017	612.0	655.0		
	Jun 2017	603.0	656.0		
	Jul 2017	602.0	653.0		
	Aug 2017	588.0	652.0		
	Sep 2017	620.0	647.0		
	Oct 2017	627.0	649.0		
	Nov 2017	581.0	648.0		
	Dec 2017	575.0	648.0		
	Jan 2018	571.0		602.0	
	Feb 2018	569.0		602.0	
	Mar 2018	568.0		609.0	
	Apr 2018	574.0		609.0	
	May 2018	574.0		609.0	
	Jun 2018	584.0		616.0	
	Jul 2018	578.0		616.0	
	Aug 2018	570.0		587.0	
	Sep 2018	622.0		582.0	
	Oct 2018	612.0		583.0	
	Nov 2018	573.0		583.0	
	Dec 2018	544.0		570.0	
	Jan 2019	540.0			533.0
	Feb 2019	535.0			531.0
	Mar 2019	590.0			531.0
	Apr 2019	522.0			531.0
	May 2019	508.0			531.0
	Jun 2019	502.0			531.0
	Jul 2019	500.0			536.0
	Aug 2019	493.0			536.0
	Sep 2019	498.0			531.0
	Oct 2019	498.0			531.0
	Nov 2019	496.0			531.0
	Dec 2019	493.0			530.0

**Florida Power & Light Company
 Docket No. 20220001-EI
 OPC's Third Set of Interrogatories
 Interrogatory No. 37
 Attachment 1 of 1
 Page 3 of 3**

	*Time	Headcount Actual (A)	Headcount 2020 Approved Budget (B)	Headcount 2021 Approved Budget (C)
St. Lucie	Jan 2020	512.0	513.0	
	Feb 2020	588.0	513.0	
	Mar 2020	507.0	500.0	
	Apr 2020	496.0	500.0	
	May 2020	498.0	500.0	
	Jun 2020	501.0	500.0	
	Jul 2020	499.0	500.0	
	Aug 2020	497.0	500.0	
	Sep 2020	496.0	500.0	
	Oct 2020	496.0	500.0	
	Nov 2020	495.0	500.0	
	Dec 2020	493.0	500.0	
	Jan 2021	490.0		500.0
	Feb 2021	488.0		500.0
	Mar 2021	512.0		500.0
	Apr 2021	570.0		497.0
	May 2021	484.0		492.0
	Jun 2021	480.0		492.0
	Jul 2021	474.0		489.0
	Aug 2021	552.0		489.0
	Sep 2021	530.0		489.0
	Oct 2021	475.0		489.0
	Nov 2021	469.0		489.0
	Dec 2021	458.0		489.0
Turkey Point	Jan 2020	483.0	509.0	
	Feb 2020	493.0	509.0	
	Mar 2020	563.0	508.0	
	Apr 2020	510.0	508.0	
	May 2020	482.0	497.0	
	Jun 2020	490.0	497.0	
	Jul 2020	490.0	502.0	
	Aug 2020	489.0	502.0	
	Sep 2020	561.0	497.0	
	Oct 2020	591.0	497.0	
	Nov 2020	507.0	497.0	
	Dec 2020	503.0	495.0	
	Jan 2021	500.0		485.0
	Feb 2021	501.0		485.0
	Mar 2021	501.0		485.0
	Apr 2021	499.0		485.0
	May 2021	506.0		485.0
	Jun 2021	507.0		485.0
	Jul 2021	509.0		488.0
	Aug 2021	514.0		488.0
	Sep 2021	548.0		485.0
	Oct 2021	583.0		485.0
	Nov 2021	498.0		485.0
	Dec 2021	476.0		485.0



April 15, 2019

Mr. Mano Nazar
President and Chief Nuclear Officer
Nuclear Division
Florida Power & Light Co.
Mail Stop: EX/JB
700 Universe Blvd.
Juno Beach, FL 33408

SUBJECT: TURKEY POINT NUCLEAR GENERATING STATION – NUCLEAR REGULATORY COMMISSION PROBLEM IDENTIFICATION AND RESOLUTION INSPECTION REPORT 05000250/2019010 AND 05000251/2019010

Dear Mr. Nazar:

On March 1, 2019, the U.S. Nuclear Regulatory Commission (NRC) completed a problem identification and resolution inspection at your Turkey Point Units 3, 4 and discussed the results of this inspection with Mr. Robert Coffey, Southern Regional Vice President, and other members of your staff. The results of this inspection are documented in the enclosed report.

The NRC inspection team reviewed the station's corrective action program and the station's implementation of the program to evaluate its effectiveness in identifying, prioritizing, evaluating, and correcting problems, and to confirm that the station was complying with NRC regulations and licensee standards for corrective action programs. Based on the samples reviewed, the team determined that your staff's performance in each of these areas adequately supported nuclear safety.

The team also evaluated the station's processes for use of industry and NRC operating experience information and the effectiveness of the station's audits and self-assessments. Based on the samples reviewed, the team determined that your staff's performance in each of these areas adequately supported nuclear safety.

Finally, the team reviewed the station's programs to establish and maintain a safety-conscious work environment, and interviewed station personnel to evaluate the effectiveness of these programs. Based on the team's observations and the results of these interviews the team found no evidence of challenges to your organization's safety-conscious work environment. Your employees appeared willing to raise nuclear safety concerns through at least one of the several means available.

NRC inspectors documented three findings of very low safety significance (Green) in this report. These findings involved violations of NRC requirements.

If you contest the violations or significance or severity of the violations documented in this inspection report, you should provide a response within 30 days of the date of this inspection report, with the basis for your denial, to the U.S. Nuclear Regulatory Commission, ATTN:

M. Nazar

2

Document Control Desk, Washington, DC 20555-0001; with copies to the Regional Administrator, Region II; the Director, Office of Enforcement; and the NRC resident inspector at Turkey Point.

If you disagree with a cross-cutting aspect assignment in this report, you should provide a response within 30 days of the date of this inspection report, with the basis for your disagreement, to the U.S. Nuclear Regulatory Commission, ATTN: Document Control Desk, Washington, DC 20555-0001; with copies to the Regional Administrator, Region II; and the NRC resident inspector at Turkey Point.

This letter, its enclosure, and your response (if any) will be made available for public inspection and copying at <http://www.nrc.gov/reading-rm/adams.html> and at the NRC Public Document Room in accordance with 10 CFR 2.390, "Public Inspections, Exemptions, Requests for Withholding."

Sincerely,

/RA/

Randall A. Musser, Chief
Reactor Projects Branch 3
Division of Reactor Projects

Docket Nos.: 50-250, 50-251
License Nos.: DPR-31, DPR-41

Enclosure:
Inspection Report 05000250/2019010 and 05000251/2019010

cc Distribution via ListServ

M. Nazar

3

SUBJECT: TURKEY POINT NUCLEAR GENERATING STATION – NUCLEAR
REGULATORY COMMISSION PROBLEM IDENTIFICATION AND
RESOLUTION INSPECTION REPORT 05000250/2019010 AND
05000251/2019010 April 15, 2019

DISTRIBUTION:

S. Price, RII
M. Kowal, RII
K. Sloan, RII
OE Mail
RIDSNRDIRS
PUBLIC
RidsNrrPMTurkeyPoint Resource

ADAMS ACCESSION NUMBER: ML19105B281

OFFICE	RII/DRP	RII/DRP	RII/DRS	RII/DRP	RII/DRP	RII/DRP	RII/DRP
NAME	WDeschaine	DDumbacher	JDymek	RReyes	AWilson	RTaylor	RMusser
DATE	4/12/2019	4/12/2019	4/11/2019	4/12/2019	4/11/2019	4/12/2019	

OFFICIAL RECORD COPY

U.S. NUCLEAR REGULATORY COMMISSION

REGION II

Docket Number(s): 05000250 and 05000251

License Number(s): DPR-31 and DPR-41

Report Number(s): 05000250/2019010 and 05000251/2019010

Enterprise Identifier: I-2019-010-0018

Licensee: Florida Power & Light Company (FPL)

Facility: Turkey Point Nuclear Generating Station, Units 3 and 4

Location: 9760 SW 344th Street
Homestead, FL 33035

Inspection Dates: February 11, 2019 through March 1, 2019

Inspectors: Wesley Deschaine, Project Engineer (Team Leader)
John Dymek, Reactor Inspector
Dave Dumbacher, Senior Operations Engineer
Roger Reyes, Resident Inspector

Approved By: Randall A. Musser, Chief
Reactor Projects Branch 3
Division of Reactor Projects

Enclosure

SUMMARY

The U.S. Nuclear Regulatory Commission (NRC) continued monitoring the licensee’s performance by conducting a problem identification and resolution inspection at Turkey Point Units 3 and 4 in accordance with the Reactor Oversight Process. The Reactor Oversight Process is the NRC’s program for overseeing the safe operation of commercial nuclear power reactors. Refer to <https://www.nrc.gov/reactors/operating/oversight.html> for more information. Findings and violations being considered in the NRC’s assessment are summarized in the table below.

List of Findings and Violations

Preconditioning of safety-related check valves prior to retesting			
Cornerstone	Significance	Cross-cutting Aspect	Report Section
Mitigating Systems	Green NCV 05000250/2019010-02 Open/Closed	[H.9] - Training	71152B
The NRC identified a green, non-cited violation (NCV) of 10 CFR 50, Appendix B, Criterion V, in that the licensee failed to comply with procedure 0-ADM-502, In-Service Testing Program, when preconditioning of safety related check valves was conducted prior to retesting.			

Failure to comply with the ASME OM code during safety-related check valve testing			
Cornerstone	Significance	Cross-cutting Aspect	Report Section
Mitigating Systems	Green NCV 05000250/2019010-03 Open/Closed	[P.1] - Identification	71152B
The NRC identified a green, NCV of 10 CFR 50.55a(f)(4), when the licensee failed to declare safety-related valves inoperable and failed to take corrective action after a failed in-service test (IST) as required by the ASME OM code.			

Inadequate Maintenance Procedures to Ensure Flood Protection for the 4A and 4B RHR trains			
Cornerstone	Significance	Cross-cutting Aspect	Report Section
Mitigating Systems	Green NCV 05000251/2019010-01 Open/Closed	[H.11] - Challenge the Unknown	71152B
The NRC identified a green, NCV of Technical Specification 6.8.1, for the licensee’s failure to establish, implement and maintain written procedures to prevent foreign material from potentially degrading the residual heat removal (RHR) pump room sump pumps.			

Additional Tracking Items

None

INSPECTION SCOPES

Inspections were conducted using the appropriate portions of the inspection procedures (IPs) in effect at the beginning of the inspection unless otherwise noted. Currently approved IPs with their attached revision histories are located on the public website at <http://www.nrc.gov/reading-rm/doc-collections/insp-manual/inspection-procedure/index.html>. Samples were declared complete when the IP requirements most appropriate to the inspection activity were met consistent with Inspection Manual Chapter (IMC) 2515, “Light-Water Reactor Inspection Program - Operations Phase.” The inspectors reviewed selected procedures and records, observed activities, and interviewed personnel to assess licensee performance and compliance with Commission rules and regulations, license conditions, site procedures, and standards.

OTHER ACTIVITIES – BASELINE

71152B - Problem Identification and Resolution

02.04 Biennial Team Inspection (1 Sample)

The inspectors performed a biennial assessment of the licensee’s corrective action program, use of operating experience, self-assessments and audits, and safety conscious work environment.

- Corrective Action Program Effectiveness – The inspectors assessed the corrective action program’s effectiveness in identifying, prioritizing, evaluating, and correcting problems.
- Operating Experience, Self-Assessments and Audits – The inspectors assessed the effectiveness of the station’s processes for use of operating experience, audits and self-assessments.
- Safety Conscious Work Environment – The inspectors assessed the effectiveness of the station’s programs to establish and maintain a safety-conscious work environment.

INSPECTION RESULTS

Assessment	71152B
<p>Corrective Action Program Effectiveness</p> <p>Based on the samples reviewed, the team determined that the licensee’s corrective action program (CAP) complied with regulatory requirements and self-imposed standards. The licensee’s implementation of the CAP adequately supported nuclear safety.</p> <p>Effectiveness of Problem Identification: The inspectors determined that the licensee was effective in identifying problems and entering them into the CAP and there was a low threshold for entering issues into the CAP. This conclusion was based on a review of the requirements for initiating Action Requests (ARs) as described in licensee procedure PI-AA-</p>	

104-1000, "Condition Reporting," and management's expectation that employees were encouraged to initiate ARs for any reason. Additionally, site management was actively involved in the CAP and focused appropriate attention on significant plant issues. Based on reviews and walkdowns of accessible portions of selected systems, the inspectors determined that deficiencies were being identified and placed in the CAP.

Effectiveness of Prioritization and Evaluation of Issues: Based on the review of ARs sampled by the inspection team during the onsite period, the inspectors concluded that problems were generally prioritized and evaluated in accordance with the AR significance determination guidance in procedure PI-AA-104-1000. The inspectors determined that in general, adequate consideration was given to system or component operability and associated plant risk. The inspectors determined that plant personnel had conducted root cause and apparent cause analyses in compliance with the licensee's CAP procedures and cause determinations were appropriate, and considered the significance of the issues being evaluated. A variety of formal causal-analysis techniques were used to evaluate ARs depending on the type and complexity of the issue consistent with the applicable cause evaluation procedures.

Effectiveness of Corrective Actions: Based on a review of corrective action documents, interviews with licensee staff, and verification of completed corrective actions, the inspectors determined that overall, corrective actions were timely, commensurate with the safety significance of the issues, and effective, in that conditions adverse to quality were corrected. For significant conditions adverse to quality, the corrective actions directly addressed the cause and effectively prevented recurrence. The team reviewed performance indicators, ARs, and effectiveness reviews, as applicable, to verify that the significant conditions adverse to quality had not recurred. Effectiveness reviews for corrective actions to prevent recurrence (CAPRs) were sufficient to ensure corrective actions were properly implemented and were effective.

Assessment	71152B
<p data-bbox="191 1268 964 1304">Use of Operating Experience, Self-Assessments and Audits</p> <p data-bbox="191 1337 1375 1633">The inspectors examined the licensee's program for obtaining and using industry operating experience. This included review of procedure PI-AA-102-1002, "Internal Operating Experience", selected corrective program action requests, and the licensee's operating experience (OE) database to assess the effectiveness of how external and internal OE data was handled at the plant. Additionally, the inspectors selected OE documents such as NRC generic communications, licensee event reports, vendor notifications, and plant internal OE items which had been issued since January 2016 to verify whether the licensee had appropriately evaluated each notification for applicability to the Turkey Point Nuclear plant, and whether issues identified through these reviews were entered into the CAP.</p> <p data-bbox="191 1667 1396 1900">The team determined that station's processes for the use of industry and NRC operating experience information and for the performance of audits and self-assessments were effective and complied with all regulatory requirements and licensee standards. The implementation of these programs adequately supported nuclear safety. The team concluded that operating experience was adequately evaluated for applicability and that appropriate actions were implemented to address lessons learned as needed. The inspectors determined that the licensee was effective at performing self-assessments and audits to identify issues at</p>	

a low level, properly evaluated those issues, and resolved them commensurate with their safety significance.

Assessment	71152B
<p>Safety Conscious Work Environment</p> <p>Based on a sample size of approximately 20 people interviewed from a cross-section of plant employees, the team found no evidence of challenges to a safety-conscious work environment. Employees interviewed appeared willing to raise nuclear safety concerns through at least one of the several means available.</p>	

Preconditioning of safety-related check valves prior to retesting			
Cornerstone	Significance	Cross-cutting Aspect	Report Section
Mitigating Systems	Green NCV 05000250/2019010-02 Open/Closed	[H.9] - Training	71152B
<p>The NRC identified a green, NCV of 10 CFR 50, Appendix B, Criterion V, in that the licensee failed to comply with procedure 0-ADM-502, In-Service Testing Program, when preconditioning of safety related check valves was conducted prior to retesting.</p>			
<p><u>Description:</u></p> <p>The inspectors reviewed ARs associated with the most recent surveillance testing on Unit 3 chemical and volume control system (CVCS) valves 312A, 312B and 312C. These 3-inch check valves are classified as safety-related Class 1 and provide a reactor coolant pressure boundary function. The valves are tested per the ASME OM code and the licensee’s in-service test (IST) program as described in 0-ADM-502, In-Service Testing Program every 36 months during refueling outages. On October 12, 2018, valve 312C failed its IST with a leak rate of 220,000 standard cubic centimeters per minute (sccm). AR 2285407 described the acceptance criteria as no greater than 17,600 sccm. The licensee exited the test procedure, decided to back flush and seat the check valve and then performed a satisfactory IST retest. On October 14, 2018, valves 312A and 312B, failed their IST. Both valves had back flow leakage greater than the 12 gallons per minute (GPM) acceptance criteria. The licensee exited the test procedure and mechanically agitated the valve bodies with a brass hammer. A subsequent retest was satisfactory on both valves. The final disposition in associated AR 2285745 concluded that it was acceptable to apply additional forces to the valves to get them to re-seat. The inspectors noted that mechanically agitating valves 312A and 312B, and back flushing 312C were used to influence the performance of the “follow-up” test due to the unacceptable results of the IST “initial” tests. The licensee’s IST program document 0-ADM-502, Section 5.1.1, item 11, states in part: “Preconditioning pumps and valves in the IST program shall be avoided. Preconditioning is the alteration, manipulation, or adjustment of the physical condition of an SSC before In-Service Testing for the expressed purpose of returning acceptable test results and masking action As Found conditions.” The inspectors determined that during the Unit 3 refueling outage (PT3-30) valves 312A, 312B, and 312C were</p>			

preconditioned prior to “follow-up” tests.

The inspector’s review of the two previous ISTs on valves 312A and 312B identified additional examples of preconditioning. On October 16, 2010, valve 312A failed an initial IST. At that time the plan of record IST was a radiograph to verify the check was seated. AR 0587621 stated that “the use of mechanical agitation to ensure the disc was loose and not stuck in place is acceptable for this evolution.” The valve was mechanically agitated (hit with a brass hammer) and a new test method using a backflow leakage test criteria was performed to satisfy the IST. The retest obtained satisfactory IST results. The inspectors concluded this was an example of preconditioning. AR 2075864 described that on September 23, 2015, just before the 2015 Unit 3 refueling outage (PT3-28), the licensee identified that in dispositioning the 2010 issue they did not comply with the ASME OM code after the initial failure of 312A. The AR also discussed potential preconditioning, however no follow-up actions regarding preconditioning were taken. On October 7, 2015 a prompt operability determination was completed and valve 312A was determined to be operable but non-conforming. On October 31, 2015, during PT3-28 valves 312A and 312B failed the backflow IST. The test procedure was then revised to include an Air Operated Double Diaphragm (AODD) pump installed on the upstream side of the valve in an attempt to seat the check prior to re-performing the backflow tests. The inspectors concluded that the AODD pump preconditioned the valves. On November 1, 2015, valve 312B passed but valve 312A failed the retest. Radiography on November 1, 2015, confirmed that 312A was not fully seated. The radiograph performed on November 1, 2015, was similar to the October 16, 2010, radiograph results. Valve 312A disassembly revealed internal valve component critical clearances being exceeded due to vibration/oscillation induced wear of the disk post, disc arm post hole and hinge pin hole/bushings, and hinge pin. The sum total of the increased clearances allowed the outer diameter edge of the upper disc seat surface to lodge below the inner diameter edge of the upper body seat surface. In all the inspectors identified six examples of preconditioning which is prohibited by licensee’s IST program document.

Corrective Actions:

The licensee acknowledged the unacceptable preconditioning issues and entered them into the CAP. As corrective actions the licensee is planning to address acceptable and unacceptable preconditioning by implementing revisions to Operations, Maintenance, and Work Order Planning procedures and training for the Operations, Maintenance and Engineering departments.

Corrective Action References: ARs 2300895, 2303966, 2301832

Performance Assessment:

Performance Deficiency: Preconditioning safety-related valves 3-312A, 3-312B and 3-312C, after the initial IST failures and prior to the IST retest to obtain satisfactory test results, was a performance deficiency that was within the licensee’s ability to foresee, correct, and prevent.

Screening: The inspectors determined the performance deficiency was more than minor because if left uncorrected, it would have the potential to lead to a more significant safety concern. Specifically, preconditioning the check valves could mask conditions indicative of degradation occurring in each valve. These conditions, if left uncorrected, could result in the failure of the valve to perform its safety function during plant operation.

Significance: The inspectors assessed the significance of the finding using IMC 0609 Appendix A, "Significance Determination of Reactor Inspection Findings for At - Power Situations". Using IMC 0609, Appendix A, Exhibit 2, the inspectors determined the issue was of very low safety significance (Green) because it did not represent a loss of system or train function. The licensee conducted a past operability review and determined that each valve was currently operable but non-conforming.

Cross-cutting Aspect: H.9 - Training: The organization provides training and ensures knowledge transfer to maintain a knowledgeable, technically competent workforce and instill nuclear safety values. Specifically, the licensee did not provide adequate training to ensure a knowledgeable organization on the subject of preconditioning.

Enforcement:

Violation: 10 CFR Part 50, Appendix B, Criterion V, requires in part, that activities affecting quality shall be prescribed by documented instructions, procedures, or drawings, of a type appropriate to the circumstances and shall be accomplished in accordance with these instructions, procedures, or drawings.

IST program requirements and restrictions applicable to safety-related check valves 3-312A, 312B and 312C are provided in procedure 0-ADM-502, In-Service Testing Program. 0-ADM-502, Step 5.1.1, item 11, states that preconditioning pumps and valves in the IST program shall be avoided. Preconditioning is the alteration, variation, manipulation, or adjustment of the physical condition of a system, structure, or component (SSC), before in-service testing for the expressed purpose of returning acceptable test results and masking actual As Found conditions.

Contrary to the above, six examples of preconditioning were identified on the CVCS:

- On October 16, 2010, after the initial IST failure and prior to the IST retest, check valve 312A was preconditioned by mechanical agitation (hit with a brass hammer) to seat the check.
- On October 31, 2015, after the initial IST failures and prior to the IST retest, check valves 312A and 312B were preconditioned by installing a sandpiper pump to seat the check on each.
- On October 12, 2018, after the initial IST failure and prior to the IST retest check valve 312C was preconditioned by back flushing the valve to seat the check
- On October 14, 2018 after initial IST failures and prior to the IST retests, check valves 312A and 312B were preconditioned by mechanical agitation (hit with a brass hammer) to seat the check.

Enforcement Action: This violation is being treated as a Non-Cited Violation, consistent with Section 2.3.2 of the Enforcement Policy.

Failure to comply with the ASME OM code during safety-related check valve testing			
Cornerstone	Significance	Cross-cutting Aspect	Report Section

Mitigating Systems	Green NCV 05000250/2019010-03 Open/Closed	[P.1] - Identification	71152B
<p>The NRC identified a green, Non-cited Violation (NCV) of 10 CFR 50.55a(f)(4), when the licensee failed to declare safety-related valves inoperable and failed to take corrective action after a failed IST as required by the ASME OM code.</p>			
<p><u>Description:</u> The inspectors reviewed ARs associated with the most recent surveillance testing on Unit 3 CVCS valves 312A, 312B and 312C. These 3-inch check valves are classified as safety-related Class 1 and provide a reactor coolant pressure boundary function. The valves are tested per the ASME OM code and the licensee’s IST program as described in 0-ADM-502, In-Service Testing Program every 36 months during refueling outages.</p> <p>On October 12, 2018, valve 312C failed its IST with a leak rate of 220,000 standard cubic centimeters per minute (sccm). AR 2285407 described the acceptance criteria as no greater than 17,600 sccm. The licensee exited the test procedure, decided to back flush and seat the check valve and then performed a satisfactory IST retest.</p> <p>On October 14, 2018, valves 312A and 312B, failed their IST. Both valves had back flow leakage significantly greater than the 12 gallons per minute (GPM) acceptance criteria. The licensee exited the test procedure and decided to mechanically agitate the valve bodies with a brass hammer. A subsequent retest was satisfactorily on both valves.</p> <p>The inspectors determined that after the initial test failures for all three valves the licensee did not comply with the ASME OM code requiring the valves to be declared inoperable and for corrective actions to be implemented prior to retest.</p> <p>The inspector’s review of the two previous ISTs on valves 312A and 312B identified additional examples of non-compliance with the ASME OM code.</p> <p>AR 0587621 described that on October 16, 2010, valve 312A failed an initial IST. The valve was mechanically agitated (hit with a brass hammer) and a new test method using a backflow leakage test criterion was performed to satisfy the IST. The retest obtained satisfactory IST results.</p> <p>On October 31, 2015, during PT3-28 valves 312A and 312B failed the initial backflow IST. The test procedure was then revised to include an AODD pump installed on the upstream side of the valve in an attempt to seat the check prior to re-performing the backflow tests. The valves were not declared inoperable prior to this re-test. On November 1, 2015, valve 312B passed but valve 312A failed the retest. Radiography on November 1, 2015, confirmed that 312A was not fully seated. The radiograph performed on November 1, 2015, was similar to the October 16, 2010, radiograph results. Valve 312A disassembly revealed internal valve component critical clearances being exceeded due to vibration/oscillation induced wear of the disk post, disc arm post hole and hinge pin hole/bushings, and hinge pin. The sum total of the increased clearances allowed the outer diameter edge of the upper disc seat surface to lodge below the inner diameter edge of the upper body seat surface. A past operability review was completed on 312A for the period of concern from October 16, 2010 to November 7, 2015 and concluded that the valve was operable but degraded.</p>			

The inspectors determined that after the initial test failures for 312A in 2010, and 312A and 312B in 2015 the licensee did not comply with the ASME OM code requiring the valves to be declared inoperable and for corrective actions to be implemented prior to retest.

Corrective Actions:

The licensee acknowledged that they failed to follow the ASME OM code requiring IST valves that fail their initial IST to be declared inoperable and for corrective actions to be implemented prior to retest and entered them into the CAP.

Corrective Action References: ARs 2300895, 2303963

Performance Assessment:

Performance Deficiency: The licensee’s repeated failures to declare safety-related valves 312A, 312B and 312C inoperable after a failed IST and failure to complete corrective actions prior to retest, as required by the ASME OM code, was a performance deficiency.

Screening: The inspectors determined the performance deficiency was more than minor because if left uncorrected, it would have the potential to lead to a more significant safety concern. Specifically, failing to declare safety-related valves inoperable after a failed IST and completing corrective actions prior to retest, as required by the ASME OM code could mask conditions indicative of degradation occurring in each valve. These conditions, if left uncorrected, could result in the failure of the valve to perform its safety function during plant operation.

Significance: The inspectors assessed the significance of the finding using IMC 0609 Appendix A, “Significance Determination of Reactor Inspection Findings for At - Power Situations”. Using IMC 0609, Appendix A, Exhibit 2, the inspectors determined the issue was of very low safety significance (Green) because it did not represent a loss of system or train function. The licensee conducted a past operability review and determined that each valve was currently operable but non-conforming because the safety related function of the valve to open and provide a boration flow path to the RCS was maintained.

Cross-cutting Aspect: P.1 - Identification: The organization implements a corrective action program with a low threshold for identifying issues. Individuals identify issues completely, accurately, and in a timely manner in accordance with the program. The finding was determined to be reflective of present licensee performance from the period of October 2010 through October 2018, in that the license failed to identify issues completely, accurately, and in a timely manner in accordance with the IST program requirements. Specifically, multiple ARs were entered into the CAP after each failed IST but the licensee repeatedly failed to identify additional compliance requirements with the ASME OM code after each test failure.

Enforcement:

Violation: 10 CFR 50.55a(f)(4) requires, in part, that throughout the service life of a boiling or pressurized water-cooled nuclear power facility, pumps and valves that were classified as ASME Code Class 1, Class 2 and Class 3 must meet the in-service test requirements set forth in the ASME OM Code. The ASME OM Code of record for Turkey Point Unit 3 was 2004 Edition through the 2006 Addenda. Subsection ISTC-5224, Corrective Action, described the required actions to be taken as a result of a test failure and states in part “If a check valve fails to exhibit the required change of obturator position, it shall be declared inoperable. A

retest showing acceptable performance shall be run following any required corrective action before the valve is returned to service.”

Contrary to the above, six examples of non-compliance with the ASME OM code subsection ISTC-5224 were identified on the CVCS system where after initial failure of the IST the licensee did not declare the valves inoperable and did not take corrective actions as required by the code. The specific dates were:

- On October 16, 2010 after the IST failure of valve 312A.
- On October 31, 2015, after the IST failures of valves 312A and 312B.
- On October 12, 2018, after the LLRT failure of valve 312C.
- On October 14, 2018, after the IST failures of valves 312A and 312B.

Enforcement Action: This violation is being treated as a Non-Cited Violation, consistent with Section 2.3.2 of the Enforcement Policy.

Inadequate Maintenance Procedures to Ensure Flood Protection for the 4A and 4B RHR trains

Cornerstone	Significance	Cross-cutting Aspect	Report Section
Mitigating Systems	Green NCV 05000251/2019010-01 Open/Closed	[H.11] - Challenge the Unknown	71152B

The NRC identified a green, NCV of Technical Specification 6.8.1, for the licensee’s failure to establish, implement and maintain written procedures to prevent foreign material from potentially degrading the RHR pump room sump pumps.

Description:

Previously in 2016, the NRC had issued NCV 05000251/2016003-01, Failure to provide adequate flood protection, for the 4A RHR train due to debris that could potentially degrade the room’s sump pumps. On February 15, 2019, NRC inspectors discovered debris in both the Unit 4 RHR pump rooms. Insulation material in open, unsecured, clear plastic bags was staged on the floor of both pump rooms near the sumps per Work Order 40570457. The licensee performed an immediate operability evaluation as part of AR 02302239 which concluded the RHR pumps remained operable because the sump pumps have an alarm and that the open bags containing the insulation material would have been prevented or slowed from migrating to the sump pumps. The NRC inspectors reviewed the AR 02302239 and concluded that any degradation caused by the loose insulation or the bags would occur slowly enough that the alarm function would allow operator action to preserve the safety function of the RHR pumps in the rooms. Also the likelihood of a flood initiating in both rooms simultaneously was very low, thus it was not deemed credible to have a total loss of the RHR function. Turkey Point documented design and licensing basis requirements in RHR DBD 5610-050-DB-001 and Licensing commitment N0056 credited measures to mitigate flooding in the RHR pump rooms. The flood protection device referred to was the two sump pumps in each room.

Corrective Actions: The licensee took immediate corrective actions to secure the bagged insulation in the 4A and 4B RHR pump rooms and initiated a past-operability review.

Corrective Action Reference: AR 02302239

Performance Assessment:

Performance Deficiency: The failure to have adequate maintenance procedures to control foreign material from potentially affecting the performance of the RHR pump rooms' flood mitigating equipment is a performance deficiency.

Screening: The inspectors determined the performance deficiency was more than minor because if left uncorrected, it would have the potential to lead to a more significant safety concern. Specifically, the licensee's failure to maintain written procedures or documented instructions required by Regulatory Guide 1.33 that address maintenance activities in the RHR pump rooms led to an unnecessary potential flood mitigation challenge to both the 4A and 4B RHR pumps.

Significance: The inspectors assessed the significance of the finding using IMC 0609 Appendix A, "Significance Determination of Reactor Inspection Findings for At - Power Situations". Using IMC 0609, Appendix A, Exhibit 4, the inspectors determined the issue was of very low safety significance (Green) because the finding was related to RHR pumps and did not result in an associated total loss of any safety function.

Cross-cutting Aspect: H.11 - Challenge the Unknown: Individuals stop when faced with uncertain conditions. Risks are evaluated and managed before proceeding. This finding was assigned a cross-cutting aspect in the human performance area because the licensee staff failed to stop when the WO required the insulation to be removed but it didn't direct were to store the material and risks, such as flooding, were not evaluated and managed before proceeding.

Enforcement:

Violation: Technical Specification 6.8.1 requires written procedures specified by the Quality Assurance Topical Report (QATR) to be established, implemented, and maintained. The QATR requires procedures for maintenance listed in section 9a of Appendix A of NRC Regulatory Guide 1.33, Quality Assurance Program Requirements, Revision 2, dated February 1978. Regulatory Guide 1.33 requires, in part, that maintenance activities that can affect the performance of safety-related equipment be performed in accordance with written procedures, documented instructions, or drawings appropriate to the circumstances. Contrary to the above, from February 15, 2019 to present, the licensee did not have guidance that was established, implemented, and maintained to preclude maintenance activities from introducing materials that could affect the function of the Unit 4A and 4B RHR pumps in a flooding event. Specifically work order 40570457 titled "Remove insulation in 4A RHR pump room" did not reference a governing procedure or provide specific instructions to ensure that removed insulation was properly stored so that it would not clog the sump pumps used to mitigate flooding concerns. The licensee took immediate corrective actions to secure the bagged insulation in the 4A and 4B RHR pump rooms and initiated a past-operability review.

Enforcement Action: This violation is being treated as a Non-Cited Violation, consistent with Section 2.3.2 of the Enforcement Policy.

EXIT MEETINGS AND DEBRIEFS

The inspectors verified no proprietary information was retained or documented in this report.

- On March 1, 2019, the inspector presented the inspection results to Mr. Robert Coffey, Regional Vice President – Southern Region and other members of the licensee staff.

LIST OF DOCUMENTS REVIEWED

Procedures

0-ADM-225 Online Risk Assessments
0-ADM-532, ASME Section XI Repair / Replacement Program, Revision 1
3-NOP-040.02, Refueling Core Shuffle, Revision 21
3-NOP-040.03, Fuel Handling and Insert Shuffle in the Spent Fuel Pit, Revision 18
3-OSP-055.1, Emergency Containment Cooler Operability Test
AD-AA-103, Nuclear Safety Culture Program
EN-AA-203-1001, Operability Determinations / Functionality Assessments, Revision 32
MA-AA-100-1008, Station Housekeeping and Material Control, Revision 13 dated 09/08/2016
MA-AA-100-1008, Station Housekeeping and Material Control, Revision 20 dated 02/08/2019
MA-AA-100-1022, Insulation Removal, Installation for Maintenance Activities
OP-AA-108-1000, Operator Challenges Program Management
OP-AA-108-1000-F01, Revision 2, Operator Challenge Assessment Sheet
PI-AA-100-1005, Root Cause Analysis
PI-AA-100-1005-F04, Effectiveness Review Form
PI-AA-102, Operating Experience Program, Revision 16
PI-AA-102-1001, Operating Experience Program Screening and Responding to Incoming Operating Experience
PI-AA-102-1002, Internal Operating Experience, Revision 10
PI-AA-104-1000, Condition Reporting
AD-AA-103, Nuclear Safety Culture Program, Revision 12
ER-AA-100-2002-10000, Maintenance Rule Activity Guidance, Revision 2
ER-AA-100-2002, Maintenance Rule Program Administration, Revision 7
ER-AA-101, Equipment Reliability, Revision 9
ER-AA-201-2001, System and Program Health Reporting, Revision 14
ER-AA-201-2002, System Performance Monitoring, Revision 6
ER-AA-201, Detection Process for Equipment Performance, Revision 5
NA-AA-200-1000, Employee Concerns Program, Revision 2
PI-AA-01, Corrective Action Program and Condition Reporting, Revision 4
PI-AA-02, Self-Assessment, Revision 0
PI-AA-03, Operating Experience, Revision 1
PI-AA-04, Human Performance, Revision 0
PI-AA-05, Change Management, Revision 2
PI-AA-100, Condition Assessment and Response, Revision 11
PI-AA-100-105, Condition Assessment and Response, Revision 18
PI-AA-100-106, Common Cause Evaluation, Revision 16

PI-AA-100-107, Issue Investigation, Revision 21
PI-AA-100-108, Condition Evaluation, Revision 09
PI-AA-101, Assessment and Improvement Program, Revision 26
PI-AA-104-1000, Condition Reporting, Revision 20
PI-AA-203, Action Tracking Management, Revision 12

0-ADM-016.4, Fire Watch Program, Revision 11A
0-NCAP-027, Calibration and Operation of the Benchtop pH/Conductivity/TDS Meter, Revision 1
OGMP-102.21, Installation and Maintenance of Thermo-lag Fire Barrier Systems, Revision 2
EN-AA-213-1000-F01, Engineering Product Risk and Consequences Assessment, Revision 4
MM-AA-100, Conduct of Maintenance, Revision 8
MM-AA-100-1008, Housekeeping and Material Control, Revision 19
MM-AA-101-1000, Foreign Material Exclusion, Revision 22
0-ADM-502, In-service Testing (IST) Program
0-ADM-531, Containment Leakage Rate Testing Program
0-ADM-539, In-service Testing – Condition Monitoring of Check Valves
3-OSP-047.1D, Charging Line Isolation and Check Valve Test
3-OSP-047.2, 3-312A and 3-312B In-service Test
3-OSP-051.5, Local Leak Rate Tests
4-OSP-051.5, Local Leak Rate Tests
ER-AA-100-2002, Maintenance Rule Program Administration
ER-AA-113-1000, In-service Testing Procedure
MA-AA-203-1000, Maintenance Testing
MA-AA-203-1001, Work Order Planning
TP-15-006, 3-312A and 3-312B Closure Test

ARs Reviewed

2146943, 2180657, 2220785, 2235484, 2239149, 2241062, 2246906, 2248895, 2262955,
2264188, 2301504, 2302239, 2216800, 2155629, 2123851, 2129632, 2155318, 2239149,
2042744, 2056905, 2147487, 2155881, 2170347, 2181184, 2181350, 2187711, 2188672,
2192198, 2194260, 2194720, 2206181, 2212152, 2214729, 2222270, 2224143, 2224218,
2249535, 2261216, 2261941, 2264782, 0587621, 1728305, 2075864, 2087510, 2088888,
2095982, 2152029, 2155621, 2180643, 2180974, 2187392, 2212379, 2212385, 2213443,
2218834, 2220993, 2283013, 2285407, 2285537, 2285745, 2287548, 2287883, 2288068,
2228814, 2285407, 2285745, 2296174, 2300895

Assessments:

SSC Preconditioning Issues in the NextEra Energy Fleet 2301832
EP Readiness for January 2018 NRC Program Inspection 2239789
PTN 4A Intake Cooling Water Pump CMM 2255778
Pre-NRC 71111.11 Licensed Operator Continuing Training 2191963
PT4-30 Rad Worker Practices 2231158
Risk Management 2291826
Boric Acid Corrosion Control 2218853
PTN Outage S/D Risk Strategy 2195583
Professionalism at PTN 2207311
PTN Review of Maintenance Five Focus Areas 2240755
PTN On-line Work Management 2235702
PT3-29 Foreign Material Exclusion Control 2195558
PT3-29 Plant Readiness for Operations 2202133

PTN-Operational Decision Making 2211949

Other Documents

Quality Assurance Topical Report, (FPL-1), Revision 21
Turkey Point Unit 3 – Key PRA Results, Revision 11
OWA, Burdens, CRD, Compensatory Actions, NSO Top Ten challenge and Temp modifications lists, current 2/11/19
Drawing 5614-M-3064, Safety Injection Accumulator System inside Containment
TR-AA-230-1000 Training Analysis Worksheet for ASME Section XI potential knowledge gaps
RHR DBD 5610-050-DB-001, Revision 11 dated 11/30/2007
Licensing commitment N0056, dated September 4, 1979
AT-01.01 AR Report (All Security Related AR's 1/1/2017 to 12/31/2018)
Control Room Report-Fire Protection Impairment List, 2/19/2019
Mentoring Guide Fire Protection Program Owner, Revision 2
Root Cause Evaluation for AR 2192198 High Energy Arc Fault Event of 3/18/2017
Notifier Fire Detection System Manual VTM V001049
Work Package 40559449, Unit 4 SG Main Feed-water Flow Control Valve Trouble Shooting
CN-2.29 Specification for Electrical Conduit and Cable Tray Supports PTN Unit 3 & 4, Revision 2
Licensee Event Report (LER) 2017-001-00, Phase to Ground Flashover from Thermo-Lag

Work orders

40570457, 40538300, 40538199, 40550272, 40407132, 40546401, 40578200, 406244

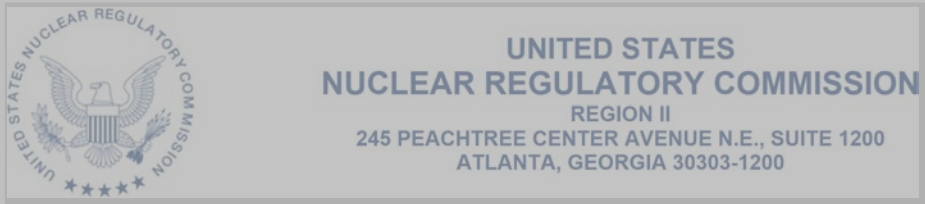

February 11, 2021

Mr. Don Moul
Executive Vice President, Nuclear Division and Chief Nuclear Officer
Florida Power & Light Company
Mail Stop: EX/JB
700 Universe Blvd
Juno Beach , FL 33408

SUBJECT: TURKEY POINT UNITS 3 & 4 – INTEGRATED INSPECTION REPORT
05000250/2020004 AND 05000251/2020004 AND INDEPENDENT SPENT
FUEL STORAGE INSTALLATION INSPECTION (ISFSI) 07200062/2020002

Dear Mr. Moul:

On December 31, 2020, the U.S. Nuclear Regulatory Commission (NRC) completed an inspection at Turkey Point Units 3 & 4. On January 14, 2021, the NRC inspectors discussed the results of this inspection with Mr. Michael Pearce, Site Vice President, and other members of your staff. The results of this inspection are documented in the enclosed report.

One finding of very low safety significance (Green) is documented in this report. This finding involved a violation of NRC requirements. We are treating this violation as a non-cited violation (NCV) consistent with Section 2.3.2 of the Enforcement Policy.

If you contest the violation or the significance or severity of the violation documented in this inspection report, you should provide a response within 30 days of the date of this inspection report, with the basis for your denial, to the U.S. Nuclear Regulatory Commission, ATTN: Document Control Desk, Washington, DC 20555-0001; with copies to the Regional Administrator, Region II; the Director, Office of Enforcement; and the NRC Resident Inspector at Turkey Point Units 3 & 4.

If you disagree with a cross-cutting aspect assignment in this report, you should provide a response within 30 days of the date of this inspection report, with the basis for your disagreement, to the U.S. Nuclear Regulatory Commission, ATTN: Document Control Desk, Washington, DC 20555-0001; with copies to the Regional Administrator, Region II; and the NRC Resident Inspector at Turkey Point Units 3 & 4.

D. Moul

2

This letter, its enclosure, and your response (if any) will be made available for public inspection and copying at <http://www.nrc.gov/reading-rm/adams.html> and at the NRC Public Document Room in accordance with Title 10 of the *Code of Federal Regulations* 2.390, "Public Inspections, Exemptions, Requests for Withholding."

Sincerely,

/RA/

Booma Venkataraman, Acting Chief
Reactor Projects Branch 3
Division of Reactor Projects

Docket Nos. 05000250, 05000251 and 07200062
License Nos. DPR-31 and DPR-41

Enclosure:
As stated

cc w/ encl: Distribution via LISTSERV®

D. Moul

3

SUBJECT: TURKEY POINT UNITS 3 & 4 – INTEGRATED INSPECTION REPORT
05000250/2020004 AND 05000251/2020004 dated February 11, 2021

DISTRIBUTION:

M. Kowal
S. Price
L. Gibson
RidsNrrPMTurkeyPoint Resource
Public
RidsNrrDro Resource

ADAMS ACCESSION NUMBER: ML21042A078

<input checked="" type="checkbox"/> SUNSI Review		<input checked="" type="checkbox"/> Non-Sensitive <input type="checkbox"/> Sensitive		<input checked="" type="checkbox"/> Publicly Available <input type="checkbox"/> Non-Publicly Available	
OFFICE	Rii/DRP	Rii/DRP	Rii/DRP	Rii/DRP	
NAME	R. Reyes	D. Orr	J. Hamman	B. Venkataraman	
DATE	02/10/2021	02/10/2021	02/10/2021	02/11/2021	

OFFICIAL RECORD COPY

**U.S. NUCLEAR REGULATORY COMMISSION
Inspection Report**

Docket Numbers: 05000250, 05000251 and 07200062

License Numbers: DPR-31 and DPR-41

Report Numbers: 05000250/2020004, 05000251/2020004, and 07200062/2020002

Enterprise Identifier: I-2020-004-0039 and I-2020-002-007

Licensee: Florida Power & Light Company

Facility: Turkey Point Units 3 & 4

Location: Homestead, FL 33035

Inspection Dates: October 01, 2020 to December 31, 2020

Inspectors: P. Cooper, Senior Reactor Inspector
C. Dykes, Senior Health Physicist
M. Magyar, Reactor Inspector
D. Orr, Senior Resident Inspector
R. Reyes, Resident Inspector
J. Rivera, Health Physicist

Approved By: Booma Venkataraman, Acting Chief
Reactor Projects Branch 3
Division of Reactor Projects

SUMMARY

The U.S. Nuclear Regulatory Commission (NRC) continued monitoring the licensee’s performance by conducting an integrated inspection at Turkey Point Units 3 & 4, in accordance with the Reactor Oversight Process. The Reactor Oversight Process is the NRC’s program for overseeing the safe operation of commercial nuclear power reactors. Refer to <https://www.nrc.gov/reactors/operating/oversight.html> for more information.

List of Findings and Violations

Inadequate procedural compliances during erecting of scaffold caused damage to safety-related motor operated valve during operation			
Cornerstone	Significance	Cross-Cutting Aspect	Report Section
Mitigating Systems	Green NCV 05000251/2020004-01 Open/Closed	[H.8] - Procedure Adherence	71111.15
A self-revealed, Green finding and associated, non-cited violation (NCV) of Technical Specification 6.8.1 was identified when the licensee failed to follow procedure MA-AA-100-1002, Scaffold Installation, Modification, and Removal Requests, when the licensee erected a scaffold that interfered with operation of plant equipment. During testing of motor-operated valve, MOV-4-861B, containment south recirculation sump isolation valve, the valve stem local position indicator impacted a scaffold in the B residual heat removal (RHR) pump room and caused damage to the position indicator requiring MOV-4-861B to be taken out of service for corrective maintenance.			

Additional Tracking Items

Type	Issue Number	Title	Report Section	Status
LER	05000250/2020-004-00	LER 2020-004-00 for Turkey Point Unit 3 re Manual Reactor Trip in Response to Automatic Trip of the 3B Steam Generator Feedwater Pump	71153	Closed
LER	05000250/2020-003-00	LER 2020-003-00 for Turkey Point, Unit 3, Automatic Reactor Trip due to High Source Range Flux during Reactor Startup	71153	Closed

PLANT STATUS

Unit 3 began the inspection period at near rated thermal power. Unit 3 experienced an automatic turbine runback to 83% power on November 7, 2020, in response to several feedwater system control valves failing and causing the heater drain pumps to trip. Unit 3 was down-powered to 25% on November 21, 2020, to facilitate repairs to the Distributed Control System which was the cause for several feedwater system control valves failing on November 7, 2020. Unit 3 was returned to rated thermal power on November 23, 2020. Unit 3 was down-powered to 42% rated thermal power on December 2, 2020, to facilitate an emergent repair to a protective relay associated with the 3C transformer. The 3C transformer supplies electrical power to the 3C condensate and 3B steam generator feedwater pumps. Unit 3 was returned to rated thermal power on December 5, 2020. Unit 3 was down-powered to 50% power on December 16, 2020, when operators entered an off-normal procedure for high sodium concentrations in all three steam generators. Unit 3 power was increased to 55% on December 24 and remained at that power level for the remainder of the inspection period to facilitate main condenser tube inspections and plugging to eliminate the source of sodium contamination in the condensate system.

Unit 4 began the inspection period in end-of-cycle coastdown at 95% rated thermal power and was shutdown on October 3, 2020, to begin refueling outage T4R32. Unit 4 was restarted on November 14, 2020, and returned to rated thermal power on November 22, 2020, and remained at or near rated thermal power for the remainder of the inspection period.

INSPECTION SCOPES

Inspections were conducted using the appropriate portions of the inspection procedures (IPs) in effect at the beginning of the inspection unless otherwise noted. Currently approved IPs with their attached revision histories are located on the public website at <http://www.nrc.gov/reading-rm/doc-collections/insp-manual/inspection-procedure/index.html>. Samples were declared complete when the IP requirements most appropriate to the inspection activity were met consistent with Inspection Manual Chapter (IMC) 2515, "Light-Water Reactor Inspection Program - Operations Phase." The inspectors performed plant status activities described in IMC 2515, Appendix D, "Plant Status," and conducted routine reviews using IP 71152, "Problem Identification and Resolution." The inspectors reviewed selected procedures and records, observed activities, and interviewed personnel to assess licensee performance and compliance with Commission rules and regulations, license conditions, site procedures, and standards.

Starting on March 20, 2020, in response to the National Emergency declared by the President of the United States on the public health risks of the Coronavirus Disease 2019 (COVID-19), resident inspectors were directed to begin telework and to remotely access licensee information using available technology. During this time, the resident inspectors performed periodic site visits each week; conducted plant status activities as described in IMC 2515, Appendix D, "Plant Status"; observed risk-significant activities; and completed on-site portions of IPs. In addition, resident and regional baseline inspections were evaluated to determine if all or portions of the objectives and requirements stated in the IP could be performed remotely. If the inspections could be performed remotely, they were conducted per the applicable IP. In some cases, portions of an IP were completed remotely and on-site. The inspections documented below met the objectives and requirements for completion of the IP.

REACTOR SAFETY

71111.04 - Equipment Alignment

Partial Walkdown Sample (IP Section 03.01) (1 Sample)

The inspectors evaluated system configurations during partial walkdowns of the following systems/trains:

- (1) 3A, 3B, and 4B high head safety injection pumps; Unit 3 refueling water storage tank; and, the 3A, 3B, and 4B safety-related 4 kilo-Volt (kV) switchgears while the 4A safety-related 4kV switchgear was out of service (OOS) on October 15, 2020

Complete Walkdown Sample (IP Section 03.02) (1 Sample)

- (1) Unit 3 and Unit 4 Auxiliary Feedwater Systems on November 4, 2020

71111.05 - Fire Protection

Fire Area Walkdown and Inspection Sample (IP Section 03.01) (1 Sample)

The inspectors evaluated the implementation of the fire protection program by conducting a walkdown and performing a review to verify program compliance, equipment functionality, material condition, and operational readiness of the following fire areas:

- (1) Unit 3A, 3B, 4A and 4B Safety-related 4Kv Switchgears, Fire zones 71, 70, 68 and 67 respectively. Unit 3A, 3B, 3C, 3D, 4A, 4B, 4C, and 4D safety-related 480-Volt Load Centers, Fire zones 095, 096, 093 and 094 respectively, on November 9, 2020

71111.08P - Inservice Inspection Activities (PWR)

PWR Inservice Inspection Activities Sample (IP Section 03.01) (1 Sample)

- (1) The inspectors verified that the reactor coolant system boundary, steam generator tubes, reactor vessel internals, risk-significant piping system boundaries, and containment boundary are appropriately monitored for degradation and that repairs and replacements were appropriately fabricated, examined and accepted by reviewing the following activities from October 12 - 16, 2019:

03.01.a - Nondestructive Examination and Welding Activities.

- Ultrasonic Testing (UT)
 - 12"-RC-1401-9, Pressurizer safe end to nozzle weld, ASME Class 1, Report # 5.39-001
 - 3"-CH-1401-37, Elbow to Branch Connection, AUG/MRP-146, ASME Class 1, WO#40679281
- Liquid Penetrant (PT)
 - 4-312A, Replacement of Charging to Reactor Coolant Loop "A" Check Valve, ASME Class 1, WO#40656497
 - 12"-RC-1401-9, Pressurizer safe end to nozzle weld, AUG/LR, ASME Class 1, WO#40678614
- Radiographic Inspection Technique (RT)
 - 4-312A, Replacement of Charging to Reactor Coolant Loop "A" Check Valve, ASME Class 1, WO#40656497

03.01.c – Pressurized-Water Reactor Boric Acid Corrosion Control Activities.

- 4-298J, RCP C Seal Water Injection Isolation Valve, AR02370233
- CV-4-310A, Charging to RC loop A Control Valve, AR02370232

71111.11A - Licensed Operator Requalification Program and Licensed Operator PerformanceRequalification Examination Results (IP Section 03.03) (1 Sample)

The licensee completed the annual requalification operating examinations required to be administered to all licensed operators in accordance with Title 10 of the *Code of Federal Regulations* 55.59(a)(2), "Requalification Requirements," of the NRC's "Operator's Licenses." During the week of December 28, 2020, the inspector performed an in-office review of the overall pass/fail results of the individual operating examinations, the crew simulator operating examinations, and the biennial written examinations in accordance with Inspection Procedure (IP) 71111.11, "Licensed Operator Requalification Program." These results were compared to the thresholds established in Section 3.02, "Requalification Examination Results," of IP 71111.11.

- (1) The inspectors reviewed and evaluated the licensed operator examination failure rates for the requalification annual operating exam administered on December 2, 2020.

71111.11Q - Licensed Operator Requalification Program and Licensed Operator PerformanceLicensed Operator Performance in the Actual Plant/Main Control Room (IP Section 03.01) (1 Sample)

- (1) The inspectors observed and evaluated licensed operator performance in the control room during:
 - 4-GOP-305, Hot Standby to Cold Shutdown; 4-ONOP-046.4, Malfunction of Boron Concentration Control System; and, 4-OSP-059.6, Source Range High Flux at Shutdown Setpoint Calibration on October 3, 2020
 - 4-NOP-041.07, Draining the Reactor Coolant System on October 6 - 7, 2020
 - Through wall leak on the Unit 4 emergency boration line and Technical Specification 3.0.3 entry and exit on December 14, 2020

Licensed Operator Requalification Training/Examinations (IP Section 03.02) (1 Sample)

- (1) The inspectors observed and evaluated an operating crew's response to a requalification training simulator scenario in the control room simulator on November 19, 2020.

71111.12 - Maintenance EffectivenessMaintenance Effectiveness (IP Section 03.01) (1 Sample)

The inspectors evaluated the effectiveness of maintenance to ensure the following structures, systems, and components (SSCs) remain capable of performing their intended function:

- (1) AR 2092653, Unit 3 startup transformer lockout (event date on November 18, 2015) and a(1) action plan on December 22, 2020

Quality Control (IP Section 03.02) (1 Sample)

The inspectors evaluated the effectiveness of maintenance and quality control activities to ensure several safety-related SSCs remained capable of performing their intended function by reviewing multiple work orders and ensuring quality control verifications were properly specified in accordance with the Quality Assurance Program and implemented in:

- (1) Work orders 40569949, 40631128, 40669279, 40631121, 40657784, 40670685, 40735938, 40656497, 40669087, 40633489, 40669176, 40668808, 40668806, 40668859, 40744785, 40668907, and 40668875 on December 8, 2020 and December 9, 2020

71111.13 - Maintenance Risk Assessments and Emergent Work Control

Risk Assessment and Management Sample (IP Section 03.01) (1 Sample)

The inspectors evaluated the accuracy and completeness of risk assessments for the following planned and emergent work activities to ensure configuration changes and appropriate work controls were addressed:

- (1) Unit 3 online and Unit 4 shutdown risk assessment while the 4A safety-related 4kV switchgear and associated loads were OOS on October 13 and 16, 2020

71111.15 - Operability Determinations and Functionality Assessments

Operability Determination or Functionality Assessment (IP Section 03.01) (5 Samples)

The inspectors evaluated the licensee's justifications and actions associated with the following operability determinations and functionality assessments:

- (1) Action Requests (ARs) 2372250 and 2372386, 4A sequencer relays model RXMB1 found with cracks on case on October 21, 2020
- (2) AR 2370173, Source range nuclear instrument, N-4-31, OOS for drifting indication on October 26, 2020
- (3) AR 2374494, Auxiliary building concrete discovered unexpected level of degradation on November 16, 2020
- (4) AR 2374542, Charging to reactor coolant loop A check valve, 4-312A, failed post-maintenance back leakage acceptance criteria on November 23, 2020
- (5) AR 2369425, Containment south recirculation sump isolation valve, 4-861B MOV, did not travel open on October 1, 2020

71111.18 - Plant Modifications

Temporary Modifications and/or Permanent Modifications (IP Section 03.01 and/or 03.02) (1 Sample)

The inspectors evaluated the following temporary or permanent modifications:

- (1) Engineering change (EC) 295393, Replacement of charging to reactor coolant loop A check valve, 4-312A, on October 29, 2020

71111.19 - Post-Maintenance Testing

Post-Maintenance Test Sample (IP Section 03.01) (6 Samples)

The inspectors evaluated the following post-maintenance test activities to verify system operability and functionality:

- (1) Work order (WO) 40631121-27, 4A Containment Spray Pump 480 V Breaker Replacement and Modification to MasterPac Style. Post-maintenance test (PMT) performed within work order task and reviewed on October 16, 2020.
- (2) WO 40669087, Letdown Relief Valve, RV-4-203, Replacement and WO 40746020, Letdown Flow Control Valve, CV-4-200C, Overhaul. PMT performed using 4-OSP-051.5, Local Leak Rate Test (Section 7.14 Containment Penetration 14, Letdown) and reviewed on October 30, 2020.
- (3) WO 40400199, Positioner Replacement for FCV-4-489, 4B Feedwater Bypass Flow Control Valve per EC 293060. PMT performed using 4-OSP-074.5, FW Control Valve and Bypass Valve Inservice Test and reviewed on November 11, 2020
- (4) WO 40656497, Charging to Reactor Coolant Loop A Check Valve, 4-312A, Replacement. PMT performed using 4-OSP-047.1D, Charging Line Isolation and Check Valve Test and reviewed on November 20, 2020.
- (5) WO 40747435, 4B Reactor Coolant Pump Power Cable Electrical Penetration Repair. PMT performed using 4-OSP-051.5, Local Leak Rate Test (Section 7.48 4kV RCP Electrical Penetration) and reviewed on November 23, 2020.
- (6) WO 40744940, 4B Main Steam Line Dump to Atmosphere Control Valve, CV-4-1607, Overhaul. PMT performed using 4-OSP-206.1, Inservice Valve Testing - Cold Shutdown (Section 7.1 Main Steam Valve Test) and reviewed on November 23, 2020.

71111.20 - Refueling and Other Outage Activities

Refueling/Other Outage Sample (IP Section 03.01) (1 Sample)

- (1) The inspectors evaluated Unit 4 refueling outage PT4-32 activities from October 3 to November 17, 2020

71111.22 - Surveillance Testing

The inspectors evaluated the following surveillance tests:

Surveillance Tests (other) (IP Section 03.01) (2 Samples)

- (1) 4-OSP-072.6, Main Steam Safety Valve Set Point Surveillance Using Team Trevitest Mark VIII Equipment (for relief valves RV-4-1400, 1403, 1407 and 1412) on October 16, 2020
- (2) 4-OSP-203.1, Train A Engineered Safeguards Integrated Test on November 17, 2020

Containment Isolation Valve Testing (IP Section 03.01) (1 Sample)

- (1) 4-OSP-051.5, Local Leak Rate Tests, section 7.14, Containment Penetration 14 - Letdown, on October 13, 2020

71114.06 - Drill Evaluation

Select Emergency Preparedness Drills and/or Training for Observation (IP Section 03.01) (1 Sample)

- (1) The inspectors evaluated virtual table-top scenarios for the technical support center and emergency operations facility responders on December 16 and 17, 2020

RADIATION SAFETY

71124.01 - Radiological Hazard Assessment and Exposure Controls

Radiological Hazard Assessment (IP Section 03.01) (1 Sample)

- (1) The inspectors evaluated how the licensee identifies the magnitude and extent of radiation levels and the concentrations and quantities of radioactive materials and how the licensee assesses radiological hazards.

Instructions to Workers (IP Section 03.02) (1 Sample)

- (1) The inspectors evaluated radiological protection-related instructions to plant workers.

Contamination and Radioactive Material Control (IP Section 03.03) (2 Samples)

The inspectors evaluated licensee processes for monitoring and controlling contamination and radioactive material.

- (1) Observed licensee perform surveys of potentially contaminated material leaving Unit 4 Containment and the Radiological Control Area (RCA).
- (2) Observed workers exiting Unit 4 Containment and the RCA during Unit 4 refueling outage.

Radiological Hazards Control and Work Coverage (IP Section 03.04) (3 Samples)

The inspectors evaluated in-plant radiological conditions during facility walkdowns and observation of radiological work activities.

- (1) RWP 20-4100 Task 15 Unit 4 Reactor Head Lift, Rev 00
- (2) RWP 20-4014 Job Specific, Unit 4 Reactor Sump Entry, Rev 00
- (3) RWP 20-4100 Task 1, Unit 4 Upper Internals Lift, Rev 00

High Radiation Area and Very High Radiation Area Controls (IP Section 03.05) (3 Samples)

During facility walkdowns, the inspectors reviewed several postings and physical controls for High Radiation Areas (HRAs), Locked High Radiation Areas (LHRAs), and Very High Radiation Areas (VHRAs) located in the following areas:

- (1) Unit 4 Auxiliary Building
- (2) Unit 4 Containment
- (3) Unit 4 Radwaste Building

Radiation Worker Performance and Radiation Protection Technician Proficiency (IP Section 03.06) (1 Sample)

- (1) The inspectors evaluated radiation worker and radiation protection technician performance as it pertains to radiation protection requirements.

71124.08 - Radioactive Solid Waste Processing & Radioactive Material Handling, Storage, & Transportation

Radioactive Material Storage (IP Section 03.01) (1 Sample)

- (1) Inspectors evaluated the licensee's performance in controlling, labelling and securing radioactive materials.

Radioactive Waste System Walkdown (IP Section 03.02) (1 Sample)

- (1) Inspectors walked down accessible portions of the solid radioactive waste systems and evaluated system configuration and functionality.

Waste Characterization and Classification (IP Section 03.03) (2 Samples)

The inspectors evaluated the licensee's characterization and classification of radioactive waste.

- (1) 10 CFR 61 Analysis 2018 DAW
- (2) 10 CFR 61 Analysis 2018 RAM

Shipment Preparation (IP Section 03.04) (1 Sample)

- (1) The inspectors observed shipment no. PTN-M-20-057 containing LSA-II used laundry, for review against requirements.

Shipping Records (IP Section 03.05) (4 Samples)

- (1) W-18-014, UN3321, Radioactive Material, Low specific activity (LSA-II), 7, Depleted Resin in HIC, 10/24/2018
- (2) W-18-011, UN3221, Radioactive Material, Low specific activity (LSA-II), 7, DAW, 10/04/2018
- (3) W-19-006, UN3221, Radioactive Material, Low specific activity (LSA-II), 7 fissile excepted, DAW, 06/14/2019

- (4) W-20-003, UN3221, Radioactive Material, Low specific activity (LSA-II), 7, fissile excepted, 2018 DAW, 03/17/2020

OTHER ACTIVITIES – BASELINE

71151 - Performance Indicator Verification

The inspectors verified licensee performance indicators submittals listed below:

MS06: Emergency AC Power Systems (IP Section 02.05) (2 Samples)

- (1) Unit 3 October 2019 through September 2020
- (2) Unit 4 October 2019 through September 2020

MS07: High Pressure Injection Systems (IP Section 02.06) (2 Samples)

- (1) Unit 3 October 2019 through September 2020
- (2) Unit 4 October 2019 through September 2020

MS08: Heat Removal Systems (IP Section 02.07) (2 Samples)

- (1) Unit 3 October 2019 through September 2020
- (2) Unit 4 October 2019 through September 2020

MS09: Residual Heat Removal Systems (IP Section 02.08) (2 Samples)

- (1) Unit 3 October 2019 through September 2020
- (2) Unit 4 October 2019 through September 2020

MS10: Cooling Water Support Systems (IP Section 02.09) (2 Samples)

- (1) Unit 3 October 2019 through September 2020
- (2) Unit 4 October 2019 through September 2020

OR01: Occupational Exposure Control Effectiveness Sample (IP Section 02.15) (1 Sample)

- (1) May 1, 2019 to September 30, 2020

71152 - Problem Identification and Resolution

Semiannual Trend Review (IP Section 02.02) (1 Sample)

- (1) The inspectors reviewed the licensee's corrective action program for potential adverse trends in local leak rate testing failures during the recent Unit 4 refuel outage, PT4-32, that might be indicative of a more significant safety issue. This issue was documented in AR 2372183, System 051, (Containment Isolation), Exceeded Monitoring Criteria, and was evaluated by the licensee using common cause analysis methods. The inspectors review concluded there was no adverse trend.

Annual Follow-up of Selected Issues (IP Section 02.03) (2 Samples)

The inspectors reviewed the licensee’s implementation of its corrective action program related to the following issues:

- (1) AR 2366359, apply multiplication factor trends to nuclear instrument detector monitoring. This issue was selected for follow-up to verify the licensee’s corrective actions were appropriate to address a failure to develop and establish a preventive maintenance schedule to perform source range nuclear instrument detector baseline and trending tests as described in Turkey Points Units 3 and 4 - Special Inspection Report 05000250/2020050 and 05000251/2020050 dated December 9, 2020 (ADAMS Accession No. ML20344A126).
- (2) NCV 05000250/251-2019-001-02, Failure to Perform Structures Monitoring Program Inspections IAW License Renewal Commitments, and ARs 2305563, 2306492, and 2304913. The NCV was described in Turkey Point Nuclear Generating Station Inspection Report 05000250/2019001 and 05000251/2019001 dated May 14, 2019 (ADAMS Accession No. ML19134A371). This issue was selected for follow-up to verify the licensee’s corrective actions were appropriate to address the performance deficiency and failure to inspect several safety-related structures in accordance with license renewal commitments.

71153 - Followup of Events and Notices of Enforcement Discretion

Event Report (IP Section 03.02) (2 Samples)

The inspectors evaluated the following licensee event reports (LERs):

- (1) LER 05000250/2020-003-00, Automatic Reactor Trip due to Source Range High Flux During Reactor Startup, (ADAMS Accession No. ML20274A206). The inspection conclusions associated with this LER are documented in Inspection Report 05000250/2020050 and 05000251/2020050 (ADAMS Accession No. ML20344A126).
- (2) LER 05000250/2020-004-00, Manual Reactor Trip in Response to Automatic Trip of the 3B Steam Generator Feedwater Pump, (ADAMS Accession No. ML20281A330). The inspection conclusions associated with this LER are documented in Inspection Report 05000250/2020050 and 05000251/2020050 (ADAMS Accession No. ML20344A126).

OTHER ACTIVITIES – TEMPORARY INSTRUCTIONS, INFREQUENT AND ABNORMAL

60855.1 - Operation of an Independent Spent Fuel Storage Installation at Operating Plants

Operation of an Independent Spent Fuel Storage Installation at Operating Plants (1 Sample)

- (1) The inspectors evaluated the licensee’s activities related to long-term operation and monitoring of their independent spent fuel storage installation on December 22, 2020

INSPECTION RESULTS

Inadequate procedural compliances during erecting of scaffold caused damage to safety-related motor operated valve during operation			
Cornerstone	Significance	Cross-Cutting Aspect	Report Section

Mitigating Systems	Green NCV 05000251/2020004-01 Open/Closed	[H.8] - Procedure Adherence	71111.15
<p>A self-revealed, Green finding and associated, non-cited violation (NCV) of Technical Specification 6.8.1 was identified when the licensee failed to follow procedure MA-AA-100-1002, Scaffold Installation, Modification, and Removal Requests, when the licensee erected a scaffold that interfered with operation of plant equipment. During testing of motor-operated valve, MOV-4-861B, containment south recirculation sump isolation valve, the valve stem local position indicator impacted a scaffold in the B residual heat removal (RHR) pump room and caused damage to the position indicator requiring MOV-4-861B to be taken out of service for corrective maintenance.</p>			
<p><u>Description:</u> On September 26, 2020, at 0412 hours, normally closed MOV-4-861B failed its surveillance test to stroke full open. Control room operators declared MOV-4-861B inoperable and Unit 4 entered a 72-hour shutdown action statement for an inoperable RHR suction flow path from the south containment sump. MOV-4-861B is a containment south recirculation sump suction isolation valve for the RHR system located in the B RHR pump room. The safety-related functions of MOV-4-861B are to: 1) open during the loss of coolant accident (LOCA) recirculation phase to allow the RHR pumps to take suction from the containment south recirculation sump; 2) remain closed during the LOCA injection phase to provide containment isolation and isolate the RHR pumps from the containment south recirculation sump; and 3) as a normally closed RHR system boundary valve, it passively maintains the RHR system pressure boundary integrity.</p>			
<p>After MOV-4-861B failed to fully open, plant operators identified that the local stem position indicator impacted a scaffold beam. The local position indicator is a metal rod welded on the end of the valve stem. The valve stem is in a protective shroud and the metal rod travels outside the protective shroud to provide local indication. The as-found valve condition identified the metal rod, used for position indication, was bent as a result of interference with a recently erected scaffold. During the open stroke the metal rod contacted the scaffold, causing the rod to bend which then prevented the valve from fully opening. A torque switch actuating in the open direction stopped MOV-4-861B. The licensee completed a past operability review (POR) and determined the valve stem traveled 86 percent open prior to the actuator tripping on the high torque setting. The POR concluded that MOV-4-861B was sufficiently open to perform its safety-related function of opening and supplying adequate flow during the LOCA recirculation phase. A component load path review was additionally completed by the licensee for the stem nut, valve stem and motor actuator. The licensee determined the MOV components were not overstressed due to the motor actuator tripping on the torque setting thus preventing excessive forces on the actuator and valve components. To retest and fully close MOV-4-861B, interim corrective actions were completed and included cutting off the bent portion of the metal rod from the valve stem. On September 26, 2020 at 1706 hours, the post-maintenance tests were satisfactorily completed and MOV-4-861B was returned to service.</p>			
<p>The procedure for installation of scaffolding, including areas near safety-related systems, structures and components (SSC), is MA-AA-100-1002, Scaffold Installation, Modification and Removal Requests. Attachment 2 of the procedure, Scaffolding Pre-erection Walkdown and Evaluation, requires performing a scaffold pre-erection walkdown and addressing seventeen questions for the scaffold being built. The licensee found that maintenance personnel had not adequately complied with specific portions of the scaffolding procedure, in that there was no scaffold walkdown and questions 1 and 4 were not adequately completed. Specifically,</p>			

Question 1, "Are special requirements for scaffolding construction necessary to reduce the potential adverse impact on adjacent Critical Plant Equipment?" was not correctly answered. Seven items are required to be evaluated under this question. Item 3 specifies "Physical interference with active components such as pumps, motors, and valves, dampers, etc." The inspectors determined this item was not completed. The scaffold erector did not discuss the potential for interaction with plant equipment with operations personnel and a scaffold pre-erection walkdown with operations personnel was not performed. Question 4 of Attachment 2 states "Will scaffold construction be in proximity to valves or exposed rotating equipment?" Four items are required to be evaluated under this question. Item 2 specifies "Scaffold or scaffold components which could impede the stem travel of air or motor operated valves." The inspectors determined that this step was performed incorrectly. The scaffold erection lead assumed that the scaffold was erected with sufficient clearance such that the local position indicator rod would not impact the scaffold if the valve opened. Maintenance personnel failed to validate this assumption and did not request that operations personnel perform a walkdown.

Corrective Actions: The licensee promptly removed the bent portion of the local position indicator rod and retested MOV-4-861B. Engineers evaluated the condition and determined that the MOV components were not overstressed. The licensee plans to require refresher training for all scaffold builders who approve final installations.

Corrective Action References: Action Request 2369425

Performance Assessment:

Performance Deficiency: The failure to adequately comply with procedural instructions and erect a scaffold located near MOV-4-861B that did not interfere with its operation and ability to fully open is a performance deficiency.

Screening: The inspectors determined the performance deficiency was more than minor because it was associated with the Equipment Performance attribute of the Mitigating Systems cornerstone and adversely affected the cornerstone objective to ensure the availability, reliability, and capability of systems that respond to initiating events to prevent undesirable consequences. The inspectors determined the performance deficiency was more than minor because it was associated with the Equipment Performance attribute of the Mitigating Systems cornerstone objective to ensure the availability, reliability and capability of systems that respond to initiating events to prevent undesirable consequences (i.e., core damage). Specifically, the inadequately erected scaffold resulted in damage to MOV-4-861B during surveillance testing, requiring the RHR suction flow path from the containment south recirculation sump to be taken out of service to repair and test the MOV-4-861B.

Significance: The inspectors assessed the significance of the finding using Appendix A, "The Significance Determination Process (SDP) for Findings At-Power." The inspectors screened this finding as very low safety significance (Green) using Exhibit 2, Mitigating Systems Screening Questions and answered No to question A.6, Does the degraded condition represent a loss of the PRA function of one or more non-TS trains of equipment designated as risk-significant in accordance with the licensee's maintenance rule program for greater than 3 days. Specifically, with the stem position at 86 percent full open, MOV-4-861B was determined to be operable and capable of performing its specified safety function.

Cross-Cutting Aspect: H.8 - Procedure Adherence: Individuals follow processes, procedures, and work instructions. The inspectors reviewed this performance deficiency for cross-cutting

aspects as required by IMC 0310, "Aspects Within the Cross-Cutting Areas," and concluded that maintenance personnel failed to follow procedure instructions and erected a scaffold that interfered with the operation of MOV-4-861B.

Enforcement:

Violation: Technical Specification 6.8.1 requires written procedures specified by the Quality Assurance Topical Report (QATR) to be established, implemented, and maintained. The QATR requires procedures for maintenance listed in Section 9.a., Procedures for Performing Maintenance, of Appendix A of NRC Regulatory Guide 1.33, Quality Assurance Program Requirements, Revision 2, dated February 1978. Section 9.a. requires, in part, that maintenance activities that can affect the performance of safety-related equipment be performed in accordance with written procedures, documented instructions, or drawings appropriate to the circumstances. Procedure MA-AA-100-1002, Scaffold Installation, Modification, and Removal Requests, Rev. 12, specifies the procedural process to be used to build temporary scaffolding in areas that can affect the performance of safety-related systems, structures and components, and provides the requirements for control of scaffolds erected. Attachment 2, Scaffold Pre-Erection Walkdown and Evaluation, requires a walkdown of all scaffolding and evaluation of seventeen questions to be completed on the scaffold being built. Question 1 includes a requirement to evaluate for potential physical interferences with active components such as pumps, motors, valves and dampers. Question 4 includes a requirement to evaluate for potential scaffold components which could impede the stem travel of air or motor operated valves. Contrary to the above, in the construction and approval of the scaffold erected and located adjacent to MOV-4-861, from August 31, 2020, to September 26, 2020, a scaffold walkdown was not completed and Question 1 and Question 4 of Attachment 2 were not evaluated for valve stem interference during MOV operation.

Enforcement Action: This violation is being treated as a non-cited violation, consistent with Section 2.3.2 of the Enforcement Policy.

EXIT MEETINGS AND DEBRIEFS

The inspectors verified no proprietary information was retained or documented in this report.

- On January 14, 2021, the inspectors presented the integrated inspection results to Mr. Michael Pearce, Site Vice President, and other members of the licensee staff.
- On October 14, 2020, the inspectors presented the RP inspection exit meeting inspection results to Michael Pearce, Site Vice President and other members of the licensee staff.
- On October 15, 2020, the inspectors presented the Inservice Inspection Exit inspection results to Michael Pearce, Site Vice President and other members of the licensee staff.

DOCUMENTS REVIEWED

Inspection Procedure	Type	Designation	Description or Title	Revision or Date
71124.01	Radiation Surveys	PTN-M-20200922-10	ISFSI Semi Annual	09/22/2020

Florida Power & Light

ST. LUCIE AND TURKEY POINT GPIF DATA

PERFORMANCE DATA FOR 2010-2021

LINE	St. Lucie 1	2010	2011	2012	2013	2014	2015	2016	2017	2018	2019	2020	2021
1	EAF	72.6%	84.0%	59.5%	80.2%	99.9%	89.9%	79.4%	97.4%	90.8%	70.1%	99.8%	88.6%
2	FOH + PFOH	1,810.7	895.5	216.5	593.0	25.5	102.2	834.9	246.7	74.5	1,810.1	12.8	153.7
3	EFOR %	20.7%	10.2%	2.5%	6.8%	0.3%	1.2%	9.5%	2.8%	0.9%	20.7%	0.1%	1.8%
4	POH + PPOH	1,806.6	2,046.8	4,149.3	1,073.9	22.9	933.7	1,199.0	8.6	809.4	888.2	6.3	840.8
5	Capacity Factor	72.1%	85.0%	57.3%	81.1%	101.5%	91.2%	80.5%	99.1%	92.2%	71.3%	101.3%	89.8%
LINE	St. Lucie 2	2010	2011	2012	2013	2014	2015	2016	2017	2018	2019	2020	2021
6	EAF	97.5%	63.1%	67.1%	97.7%	80.7%	82.2%	97.8%	89.7%	87.8%	100.0%	91.1%	89.5%
7	FOH + PFOH	428.2	882.5	325.9	287.9	374.5	456.4	-	110.2	252.2	-	60.0	90.6
8	EFOR %	4.9%	10.1%	3.7%	3.3%	4.3%	5.2%	0.0%	1.3%	2.9%	0.0%	0.7%	1.0%
9	POH + PPOH	21.0	2,610.4	2,913.8	30.0	1,321.4	1,339.5	232.5	884.5	873.5	0.7	721.3	827.2
10	Capacity Factor	99.9%	66.6%	67.6%	99.6%	82.3%	83.9%	100.1%	91.7%	88.6%	102.7%	93.2%	91.5%
LINE	Turkey Point 3	2010	2011	2012	2013	2014	2015	2016	2017	2018	2019	2020	2021
11	EAF	85.8%	93.4%	36.4%	87.7%	84.0%	84.5%	98.7%	85.2%	88.6%	99.1%	85.3%	84.0%
12	FOH + PFOH	356.9	234.0	34.9	1,814.3	792.7	74.2	195.5	407.6	1.6	84.5	535.2	658.3
13	EFOR %	4.1%	2.7%	0.4%	20.7%	9.0%	0.8%	2.2%	4.7%	0.0%	1.0%	6.1%	7.5%
14	POH + PPOH	1,088.2	-	6,167.1	101.2	1,235.7	1,517.7	-	906.2	1,001.0	-	681.8	743.9
15	Capacity Factor	85.4%	96.0%	40.8%	88.0%	74.6%	84.6%	100.7%	86.9%	90.6%	102.8%	89.3%	86.3%
LINE	Turkey Point 4	2010	2011	2012	2013	2014	2015	2016	2017	2018	2019	2020	2021
16	EAF	95.0%	81.5%	84.0%	65.1%	86.7%	98.1%	89.8%	89.5%	99.6%	90.6%	83.0%	99.5%
17	FOH + PFOH	442.6	261.9	-	293.8	469.0	126.5	143.2	213.4	3.1	10.0	494.2	49.2
18	EFOR %	5.1%	3.0%	0.0%	3.4%	5.4%	1.4%	1.6%	2.4%	0.0%	0.1%	5.6%	0.6%
19	POH + PPOH	137.5	1,441.2	1,440.4	3,331.0	1,288.0	162.6	953.2	705.7	28.1	815.5	1,001.2	-
20	Capacity Factor	94.9%	84.0%	86.0%	65.1%	85.7%	98.0%	91.1%	91.2%	101.4%	91.9%	84.3%	102.7%



TURKEY POINT NUCLEAR

UNIT 4 REACTOR TRIP DUE TO GEN LOCKOUT FROM LOSS OF EXCITER

EVENT DATE: 7/05/2020

AR NUMBER: 02361794

Root Cause Team	Name	Dept/Group
Management Sponsor	Dianne Strand	Engineering
Team Leader	Mike Coen	Operations
RC Evaluator	Charles Zyne	Engineering
Team Member	Randall Kerkes	Site/PGD Engineering
Team Member	Doug Vogt	Turbine PGD
Team Member	Orlando Carol	System Engineering
Team Member	Clyde Meredith	Maintenance
Team Member	Brian Bakke	Training
Team Member	Clea Duffy	Perf. Improvement

Root Cause Evaluator: _____ **Date:** _____
Print/Sign

Management Sponsor: _____ **Date:** _____
Print/Sign

MRC Chair: _____ **Date:** _____
Print/Sign

***Electronic Signature may be obtained by assigning actions in NAMS.
 Refer to PI-AA-104-1000 for details.***



Table of Contents

• Executive Summary	3
• Event Description – Narrative	7
• Problem Statement	7
• Analysis (FIP S/R, Timeline, RC S/R, Barrier Analysis, Why Staircase)	7
• Causal Factor Categorization	14
• Evaluation Attributes	15
• Previous Occurrences	
• Extent of Condition	
• Extent of Cause	
• Nuclear Safety Culture Evaluation	
• Risk / Consequence	
• Operating Experience	30
• Lessons Learned	35
• Proof Statement	35
• Corrective Actions	37
• Deferral Justification	40
• Effectiveness Review Plan	40
• Attachments	41
1. Root Cause Charter	42
2. Photos	43
3. Exciter Ground Detection System	55
4. Exciter PM Description and Status	64
5. FIP Team Support/Refute Matrix	67
6. Root Cause Support/Refute Matrix	92
7. Barrier Analysis	137
8. Timeline	147
9. Potential Paths of Water Ingress	154



1. Executive Summary

On July 5th, 2020 at approximately 1844, during a heavy thunderstorm, the Control Room received an annunciator showing a Unit 4 “Generator Field Brush Failure/Ground”.

A Turbine Operator was dispatched to attempt to clear the alarm. The alarm momentarily cleared, then immediately re-alarmed. Two additional alarms then came in indicating “Generator Voltage Regulator Loss of Backup” and “Generator Voltage Regulator Transfer to Manual”. The first of these two alarms cleared as soon as it was acknowledged, however, the initial alarm for the “Generator Field Brush Failure/Ground” and the “Generator Voltage Regulator Transfer to Manual” alarms remained locked-in. Operations noted one additional alarm at the local Voltage Regulator panel, showing a “Loss of Field Current Transducer (XDCR) #1” which then caused the Voltage Regulator to swap from Automatic AC regulator to Manual DC regulator.

As the event progressed, the annunciators indicating “Generator Voltage Regulator Loss of Backup” and “Generator Voltage Regulator Trouble” were received multiple times during the event. Operations also observed reactive load on the Unit 4 Main Generator increase from 115 MVAR to 200 MVAR during a 5-minute period and that the Exciter field volts were oscillating. The Unit 4 Reactor then tripped due to a Main Generator (4K2) Lockout followed by a Turbine Trip at approximately 2107. The Main Generator Lockout was caused by the actuation of the Voltage Regulator Lockout relay due to loss of the Voltage Regulator Power Supplies #1 & #2 (and thus loss of excitation).

In response to the event, the Outage Control Center (OCC) was manned and a Failure Investigation Process (FIP) Team was assembled to perform the initial investigation and to identify the cause which led to the alarms and subsequent unit trip. The FIP Team determined that the unit trip was initiated by a failure of the Exciter Permanent Magnet Generator (PMG) stator. The investigation focused on many potential contributors including age, vibration, water intrusion, foreign material, assembly error and other potential contributors.

The FIP Team developed actions to identify, inspect and test any component that could have been affected by the failure of the PMG stator.

After disassembly and further inspections of the failed equipment the station replaced the failed PMG stator and the Exciter rotor. The rotating assembly was replaced due to collateral magnet damage in the PMG Pole Support caused by stator failure debris and thermally induced cracking. Inspections also revealed water inside both the PMG and Exciter housing compartments. Exciter housing door seals, partition seals, and floor seals were found in degraded conditions and were subsequently replaced. Rubber gaskets at the base of the Exciter housing did not meet site specific requirements and were found dislodged and drawn into the PMG compartment. Additionally, site specific vertical weather seals were missing. Further reviews revealed site procedure 0-GMM-090.1 ‘Exciter Removal, Inspection and Installation’ includes the site-specific gasket and vertical weather seal, however, OEM procedure 3.2.2.1 which installs the Exciter housing does not. The specific source of water intrusion inside the PMG compartment cannot be determined, however, water was most likely drawn into the PMG compartment through the missing vertical weather seal and dislodged rubber gaskets (ref. Attachment 9 for potential paths of water ingress).



Extensive testing was completed on the voltage regulator, cabling, and all major components within the Exciter that were potentially affected by the failed PMG stator. Areas where water intrusion was noted were also addressed and corrected (seals that were found degraded and dislodged were replaced).

The failed Unit 4 PMG stator had been in service since 1986 (34 years in service) without rewind. A review of EPRI report 'Tools to Optimize Maintenance of Generator Excitation System, Voltage Regulator and Field Ground Detection' dated 2002, discusses the detrimental impacts of aging on the reliability of winding insulation for Generator and Exciter components. Similar EPRI report 'Plant Support Engineering: Main Generator End-of-Life and Planning Considerations' dated 2007 states the life expectancy of winding insulation to be between 10-30 years. Although these reports identify aging as a failure mechanism, they do not explicitly recommend rewinds as a corrective action. Preventive Maintenance (PM) activities recommended and performed by the OEM also lacked rewind activities.

Furthermore, the EPRI reports note that aging of winding insulation alone does not likely cause equipment failures. The presence of one or more additional stressors such as temperature, vibration, and water, is required for a failure to occur. This conclusion was validated through review of industry operating experience (OE). No examples of failures of winding insulation attributed to age alone were identified. With regards to the failed Unit 4 PMG stator winding, water is the additional stressor which lead to a fault.

Maintenance work on the Exciter, including weather sealing, was performed by the OEM in accordance with OEM procedures. However, as evidence showed, not all weather sealing was installed by the OEM during the last housing installation. FPL verification of work performed by the OEM focuses on review of documentation that evidences that the work performed is in accordance with OEM procedures. Communication of site-specific OE to the OEM (and to the industry) happened at the time of discovery of initial water intrusion in the 2002 timeframe. FPL review of OEM procedures typically focuses on performing high level review of work scope and screens for nuclear safety requirements in accordance with FPL procedures. Furthermore, FPL relies on the OEM due to their vast industry and site-specific experience regarding Exciter related work. Accordingly, the FPL review of OEM procedure to remove, inspect and install the Exciter housing did not identify the absence of the site-specific sealing requirements.

In summary, failure of the Unit 4 PMG stator occurred due to an aged winding in combination with water intrusion. Neither an aged winding nor water intrusion occurring by themselves would have resulted in failure of the stator. FPL incorporates OEM and industry OE (including site specific OE) into our maintenance program. However, there was no requirement by the OEM or industry documents to perform a rewind on a specified frequency. The Exciter housing vertical weather seals were missing, and gaskets were dislodged. These water intrusion components were not installed in accordance with site procedure guidance. 0-GMM-090.1 'Exciter Removal, Inspection and Installation' contains the site-specific gasket and vertical weather seal guidance, however, OEM procedure 3.2.2.1 which installs the Exciter housing does not.

The root cause investigation was initiated to determine the cause and contributing causes.



Problem Statement: On July 5th, 2020 at approximately 2107, during a heavy rainstorm Unit 4 tripped automatically from 100% power due to a Generator Lockout.

The Root Cause Team identified the following Significant Contributing Causes (SCC) to the event:

Significant Contributing Causes:

SCC #1) Weakness in Exciter PM Program based on existing OEM and Industry recommendations which were CONDITION BASED, and did not require TIME-BASED PMG stator rewind, thereby increasing susceptibility to failure from other stressors.

SCC #2) OEM procedure 3.2.2.1 did not include site specific weather sealing requirements based on OE.

Root Cause:

A weakness in the Exciter PM program resulted from a failure to fully assess risk of PMG stator winding age making it more susceptible to failure when exposed to water/moisture.

The Corrective Action(s) to Prevent Recurrence (CAPR) for the Root Cause is:

The root cause of the event is composed of two significant contributors, which individually will not result in a PMG stator winding fault, however, when combined caused the event. As such, two Corrective Actions to Prevent Recurrence were identified:

- Initiate a TIME-BASED PMG stator rewind PM
- Revise Siemens procedure 3.2.2.1, *Exciter Enclosure Removal and Reinstallation*, to require site specific weather seals for Exciter housing.

Contributing Cause

CC#1: Instructions in PTN procedure 0-GMM-090.1, "Exciter Removal, Inspection and Installation," in providing discretionary guidance in lieu of a mandated requirement on Exciter housing application of site specific weather seals for prevention of water intrusion.

The Corrective actions to address the contributors, extent of condition, and enhancements are:

- Issue PCR against 0-GMM-090.1, "*Exciter Removal, Inspection and Installation*" to eliminate discretionary wording regarding application of weather seals
- Action for each site to scope replacement of Exciter components (PMG Stator, AC Exciter Field, and AC Exciter Armature) with rewound spares into the following outages:
 - SL1-30 Spring 2021
 - PTN3-32 Fall 2021
 - PTN4-33 Spring 2022
 - SL2-27 Spring 2023



- Issue PCR against 0-GME-090.02, “Generator Voltage Regulator & Excitation Switchgear - Inspection and Maintenance” to require clarification that if the procedure is being performed as part of a routine PM activity, the Voltage Regulator Roof shall be coated for water intrusion, all existing door gaskets and seals replaced, and supplementary seals be reapplied.
- System Engineering to review Large/Small motors and large Transformer single point vulnerabilities (SPVs), and associated PM philosophy / Life Cycle Management Plans (LCMPs) for adequate continued reliability and assess whether an age-based Exciter rewind activity is required.
- System Engineer for Emergency Diesel Generators to review existing PM program and assess whether an age-based Exciter rewind activity is required.
- Create LTAM to install a ground detection system to detect grounds on the Exciter and PGM windings and downstream circuits.
- Create LTAM to install leak detection system to identify online water intrusion inside the Exciter housing.



2. Root Cause Report

2.1 Event Description

On July 5th, 2020 at approximately 1844, during a heavy thunderstorm, the Control Room received Annunciator AN-E-8/3 (GEN CONTACT FIELD BRUSH CONTACT FAIL/GROUND) on Unit 4. At approximately 1900, the Turbine Operator depressed the RESET pushbutton above the generator field breaker IAW Procedure 4-ARP-097.CR.E. Annunciator AN-E-8/3 momentarily reset then re-alarmed. Annunciators AN-E-9/3 (GEN VOLT REG LOSS OF BACKUP) and AN-E-7/6 (GEN VOLT REG TRANSFER TO MANUAL) subsequently alarmed. Annunciator AN-E-9/3 cleared as soon as it was acknowledged. However, Annunciators AN-E-8/3 and AN-E-7/6 remained locked-in. At this time, the Voltage Regulator (VR) swapped from Automatic AC regulator to Manual DC regulator.

At approximately 2045, Operations noted one alarm on the local VR panel, "Loss of XDCR No. 1". Shortly thereafter, at approximately 2050, Annunciators, AN-E-9/3 (GEN VOLT REG LOSS OF BACKUP) and AN-E-8/6 (GEN VOLT REG TROUBLE) were received multiple times. Operations also observed reactive load on the Unit 4 Main Generator increase from 115 MVAR to 200 MVAR during a 5-minute period. At approximately 2100, Operations reported that the Exciter field volts were oscillating. Then, at 2107 the Unit 4 Reactor tripped due to a Main Generator (4K2) Lockout followed by a Turbine Trip. The Main Generator Lockout was caused by the actuation of the VR Lockout relay due to loss of VR Power Supplies #1 & #2. After the trip, the following Generator Exciter Switchgear control cabinet alarms remained locked in: Power Supply #1, Power Supply #2, Firing Circuit #2, and Loss of XDCR #1.

2.2 Problem Statement

On July 5th, 2020 at approximately 2107, during a heavy rainstorm Unit 4 Tripped Automatically from 100% power due to a Generator Lockout.

Object: Unit 4 Exciter PMG

Defect: Failure of PMG Stator winding insulation leading to an electrical fault.

Consequence: Reactor and Turbine Trip

3. Analysis

A. Analysis Methodology

The Root Cause Team used the investigative information and the Direct Cause provided by the FIP Team to determine the Root Cause and the Contributing Causes that led to this event. The Root Cause Team verified the FIP Team's findings and proceeded to gain a deeper understanding of the event and the Root Cause.

The Root Cause Team used the following assessment tools in the evaluation:

- Timeline was developed and reviewed-refer to TIMELINE attachment



- Interviews were conducted to gain additional information on Programmatic/Organizational (O&P) barriers being used prior to the event and to gain additional insight beyond the FIP Team findings
- Reviewed all evidence gathered by the FIP Team and then the Root Cause Team verified assumptions and conclusions as appropriate

Causal Analysis was performed by using:

- FIP Team Support/Refute Matrix - Used by the FIP team to organize their investigation and document their findings that support the conclusion of the Direct Cause. The Root Cause Team development of a ROOT CAUSE Support/Refute Matrix.
- Barrier Analysis - Gathered and organized the Root Cause Team's investigative data and determined which organizational and programmatic (O&P) barriers failed or were missing to prevent the final consequential event.
- Performed analysis of the O&P factors and drivers.
- Why Analysis charting - Used to organize the Root Cause Team's conclusions and to verify and document the linkage between event and cause.

The Root Cause Team used the above-mentioned information gathering and analysis techniques to arrive at the following causes.

Unit 4 Exciter PMG Failure - (Direct Cause)

A FIP Team was formed immediately after Unit 4 Tripped Automatically from 100% power due to a Generator Lockout. The FIP Team was comprised of experienced Engineers from PTN, senior level Engineers from NextEra fleet along with Operations and Maintenance personnel. The purpose of the FIP Team was to determine via a Support/Refute matrix all possible causes of the event and to systematically collect evidence to either support or refute each cause until the most likely cause is determined. From the Support/Refute matrix it was determined that the Direct Cause was the failure of the PMG. The Root Cause Team concurred with the FIP Team conclusion of the Direct Cause.

Initially, this evaluation concluded that the most likely cause of the PMG stator failure was the presence of an external stressor (e.g. water, foreign material, vibrations, lightning, etc.) on an aged PMG stator winding with reduced margins that led to a fault internal to the PMG, resulted in power loss to the voltage regulator, and caused the subsequent unit trip. Further analysis by the Root Cause Team determined that the failure of the PMG was likely due to a culmination of age-related breakdown of the PMG stator winding insulation along with water intrusion due to inadequate sealing of the Exciter housing. Other stressors evaluated including vibration, lightning strikes, and an identified loose shim stock were discounted/refuted as a potential contributor to the event.

Discussion on Age Related Degradation and Impact of Moisture on Winding Insulation:

A review of EPRI document titled 'Tools to Optimize Maintenance of Generator Excitation System, Voltage Regulator and Field Ground Detection' dated 2002, as well as review of industry OE, revealed that component age in and of itself usually does not lead to failure of winding insulation. However, it does make the insulation more susceptible to other failure



factors. As the insulation ages, chemical changes occur in the insulation. Varnish, employed in older systems to bind insulation together, becomes dry and brittle. Other binding materials also may weaken. It is usually the binding material, the varnish or epoxy, that degrades with age; not the actual insulation material. Factors such as temperature and vibration tend to prematurely age insulation.

Moisture reduces the resistance of the insulation. Moisture, creating a conductive film on windings, allows tracking of current, leading to insulation degradation. Furthermore, a ground path can develop from tiny cracks in the insulation through moisture. As dust and other particles can attract moisture, moisture too can cause particles to adhere to surfaces. During operation, the warm winding will typically evaporate out the moisture; thereby moisture tends to be more of a problem during start-up. However, moisture that has been absorbed into the insulation will take a significant amount of time to be driven out of the insulation. Furthermore, an excessive amount of moisture can create grounds during operation. For example, a water leak can thoroughly wet a section of the winding, weakening the insulation, and develop a fault.

Discussion on Exciter housing weather seals:

In 2001 the Unit 3 Exciter housing experienced water intrusion which led to a ground on the Main Generator Exciter (CR 01-1813) but did not lead to a Main Turbine / Generator trip that caused an automatic Reactor trip. As a result of that event, Maintenance Support Package MSP 02-055 was issued which required a vertical foam weather seal to be installed between the Exciter housing vertical lip and the Turbine Deck curb. This weather seal was incorporated into PTN procedure 0-GMM-090.1 "*Exciter Removal, Inspection and Installation*" to be installed on both Units' Exciter housing. However, OEM procedures were not revised accordingly. Additionally, in 2008 the PTN subject matter expert for the Generator/Exciter equipment developed a weather sealing detail for the Exciter housing that replaced the standard ¼" thick inner rubber gasket with a ½" thick foam gasket to ensure proper compression between the housing and Turbine Deck curb. This site-specific seal was developed due to previous water intrusion events that demonstrated the standard ¼" thick inner rubber gasket did not provide a sufficient seal between the Exciter housing and Turbine Deck curb. The inner foam gasket was incorporated into procedure 0-GMM-090.1 "*Exciter Removal, Inspection and Installation*" but was not included in OEM procedures. Further, 0-GMM-090.1 was revised to require installation of the ½" inner foam gasket but did not require vertical foam weather seals (discretionary) each time the Exciter housing is removed and reinstalled.

Discussion on Potential Water Ingress into PMG compartment

During troubleshooting and investigation following the event, water was found inside the PMG compartment accumulated inside the PMG and pedestal bolt holes. The Exciter housing is designed to be sealed from the outside environment and prevent water intrusion inside these compartments, However, during Exciter housing disassembly the housing door seals were found with normal wear and degradation. The partition seal between the AC Exciter compartment (positive pressure area) and PMG compartment (negative pressure area) was also found degraded. Of particular concern was the housing floor gaskets which were found dislodged in sections around the perimeter of the PMG compartment. These floor gaskets did not meet the site-specific design which uses an inner ½" thick foam seal. Instead,



the standard ¼” thick rubber inner gasket was applied. Additionally, the site-specific vertical foam weather seal designed under MSP 02-055 and required in site procedure 0-GMM-090.1 was not installed. Although the source of water intrusion into the PMG compartment could not be ultimately determined following the event, the most probable path of water ingress was through the missing vertical foam seal and degraded and dislodged floor gaskets. Attachment 9 provides a visual aid showing the potential paths of water ingress into the PMG compartment.

Reference Support Refute Matrix attachments for additional details.

Conclusion: The analysis tools concluded that the failure of the PMG stator was due to insulation degradation coupled with additional stressors; water intrusion being the likely cause. The PM strategy historically used on this component was to perform periodic testing and inspection, but only rewind if required (CONDITION-BASED PM, test and maintain strategy versus a TIME-BASED rewind frequency). The analysis tools also confirm that additional stressors (water) had been introduced in the past with limited consequences. During this event when water was introduced to this aging component, it caused winding shorts leading to stator failure.

Barrier Analysis Chart

Refer to Attachment Barrier Analysis Chart

Weak barriers were identified involving project oversight that are derived from OEM control of work packages and use of OEM procedures. The use of OEM proprietary work packages makes oversight difficult and can limit historical knowledge and OE available to site personnel. The seal inspection and suitability, and the decision whether to reseal the Exciter housing, are provided by contract personnel without requiring specific site concurrence.

(Additional Weak Barriers were:)

- 1) PTN procedures on Exciter housing sealing process were found to be a weak barrier. The PTN procedure 0-GMM-090.1 *‘Exciter Remove, Inspection and Installation’* had been updated to add the use of site specific inner foam gasket and site specific vertical foam weather seal to mitigate water intrusion based on previous site OE. As replacement of the vertical foam weather seal was a discretionary step in the PTN procedure, this barrier would have also been weak even had this step been incorporated into the OEM procedure. No barrier was found to address equipment degradation due to age. A PM to rewind the PMG stator had been created in 2019 but not yet implemented. There was no possible judicious approach available to implement the new PM prior to this failure. It was also determined that there is no method available to trend ambient operating condition of the PMG inside the Exciter housing to determine the level of potential stressors (e.g. humidity) that would have a cumulative and adverse effect on an aging PMG.



Why Staircase Analyses

With a combination of factors leading to the failure of the PMG, two Why Staircases were used to address the individual factors.

Defect 1: Unit 4 Failure of Turbine Exciter PMG insulation

Q: Why did the turbine exciter function fail?

A: The turbine exciter function failed because the PMG stator winding insulation failed leading to shorting of the stator windings. **Direct Cause (Equipment)**

Q: Why did the PMG stator winding insulation fail?

A: PMG stator windings insulation failed as it was in operation for over 30 years without rewind.

Q: Why was the PMG stator winding insulation in operation for this extended period without a rewind activity?

A: There was no specific plan to perform a rewind activity, either one-time or through an interval period process.

Q: Why was there no specific plan to perform this one-time or interval rewind on a time-based or condition-based component?

A: Site PM philosophy (CONDITION BASED) historically relied on routine test and inspection results to validate fitness for continued service. A PM for rewind was created late in component life but was not implemented prior to failure. This new PM was considered an enhancement to the existing PM strategy.

Q: Why was the rewind PM not implemented prior to failure?

A: The Rewind PM was planned to align with next major inspection (outage) and was not considered an immediate need to address equipment reliability.

Q: Why was the Rewind PM not considered an immediate need to address equipment reliability.

A: The preventive maintenance (PM) program was based on existing Exciter OEM and Industry recommendations that do not require periodic rewind of the PMG stator.

**Weakness in Exciter PM Program based on existing OEM and Industry recommendations which were CONDITION BASED, and did not require TIME-BASED PMG stator rewind, thereby increasing susceptibility to failure from other stressors.
Significant Contributing Cause #1 (Weakness in Exciter PM Program)**



Defect 2: Unit 4 Failure of Turbine Exciter Function due to water intrusion

Q: Why did the Turbine Exciter function fail?

A: Because PMG stator windings shorted. **Direct Cause (Equipment)**

Q: Why did the PMG stator windings short?

A: The PMG stator windings shorted as there was substantive evidence that water intrusion occurred at the PMG compartment during a heavy rainstorm.

Q: Why did water intrusion occur at the PMG compartment?

A: Exciter housing weather seals were ineffective.

Q: Why were Exciter housing weather seals ineffective?

A: Exciter housing weather seals were not installed per site specific requirements.

- Inner gasket was ¼” thick rubber vs site required ½” foam
- Vertical foam weather seal was not installed (discretionary)

Q: Why were Exciter housing weather seals not installed per site specific requirements?

A: Exciter housing was reassembled by OEM using their procedure 3.2.2.1 that did not address site specific weather sealing requirements.

Q: Why did the OEM procedure 3.2.2.1 not require site specific seal requirements?

A: Site specific weather sealing steps, including those based on OE, were not incorporated as required steps into OEM procedure 3.2.2.1 – Latent Error.

Significant Contributing Cause #2 - OEM procedure 3.2.2.1 did not include site specific weather sealing requirements based on OE. – **Latent Error.**

Conclusions:

The two independent Why Staircase conclusions were reached utilizing other investigative tools including internal and external OE, interviews, Ops logs, field inspections, FIP Team reports, etc. The results of the Why Staircase Analyses have substantiated the other analysis tools' conclusions. It is important to note that from the timeline it is evident that the Exciter housing has had water intrusion at times in the past. These past water intrusion events resulted in generator ground indications only; as such, it must be concluded that this



water intrusion event has a different characteristic, and that characteristic is attributed to age related degradation of the insulation. While the stator winding most likely would not have failed due to this age-related degradation alone, the addition of water as a stressor resulted in failure. Therefore, the conclusions of the Why Staircases have identified two strong contributing causes which, when combined, result in one Root Cause; **A weakness in Exciter PM program resulted from the failure to fully assess the risk of PMG stator winding age making it susceptible to failure when exposed to water/moisture.**



4. Causal Factor Categorization Analysis

Causal Factor Characterization (Each causal factor identified is listed and classified in the appropriate People, Programmatic, Organizational and Equipment categories.)		
Cause Type	Cause Statement	Category
Root Cause	A weakness in Exciter PM program resulted from a failure to fully assess risk of PMG stator winding age making it more susceptible to failure when exposed to water/moisture.	Programmatic
Significant Contributing Cause (SCC1)	Weakness in Exciter PM Program based on existing OEM and Industry recommendations which were CONDITION BASED, and did not require TIME-BASED PMG stator rewind, thereby increasing susceptibility to failure from other stressors.	Programmatic
Significant Contributing Cause (SCC2)	OEM procedure 3.2.2.1 did not include site specific weather sealing requirements based on OE. – latent error.	Organizational
Contributing Cause (CC1)	Instructions in PTN procedure 0-GMM-090.1, “Exciter Removal, Inspection and Installation,” in providing discretionary guidance in lieu of a mandated requirement on Exciter housing application of site specific weather seals for prevention of water intrusion.	Organizational
None		People
None		Equipment



5. Evaluation Attributes

A. PTN Previous Occurrences

Per PI-AA-204-1000, “Condition Reporting”, Section 2.2, Step 43, a *Repeat Event* is defined as: Two or more independent occurrences of the same or similar event resulting from the same fundamental problem from the same fundamental cause for which previous root or apparent cause analysis has occurred and corrective action failed. Similar means common or comparable characteristics, which may include one or more of the following: plant conditions, organizations, processes, programs or procedures. Identification of a repeat event is a judgment call and should take into consideration the specifics of the condition. The length of time for repeat event identification should be significance based, typically including events occurring within at least a three-year period for programmatic issues, four years for training issues, and at least a five-year period for equipment issues, but dependent on the opportunity for recurrence and the risk significance of the event. Significant events may warrant a life of the plant review (examples – critical component failures, plant trip, significant injury, etc.). Since the event is an organizational control issue affecting a programmatic issue and significance resulting in a plant trip, an extensive historical review was conducted was performed in NAMS for the PTN site concentrating on the following keywords in the description and subject of ARs: “Exciter Winding Program”, “Exciter Water Moisture” and “Exciter Water Intrusion”. No similar events under a previous root or apparent cause evaluation was found, therefore, this RCE is not considered a Repeat Event.

This review, however, did determine that there were instances where compliance to FPL standards was not met regarding prevention of water intrusion inside the Exciter housing. This will be reviewed in the Extent of Condition/Cause with associated actions.

- 1) 9/29/2001PTN U3 Water Intrusion caused a forced power reduction due to severe weather and continuous heavy rains. A large pressure differential was created in the Exciter housing by the oversized blower, drawing water into the housing and blowing water on to exciter electrical components throughout the housing. This was caused by a failure of gaskets and removal of pipe plugs which produced a leak path from the external environmental conditions to the internal Exciter components.
- 2) 6/17/2002-7/10/2002 During this time frame another water intrusion event occurred on the U3 Exciter housing, which prompted engineering to issue an MSP 02-055 to provide direction on sealing the Exciter housing. The work order was



awaiting engineering on 6/18/2002. On 7/10/2002 the work order was again taken to approved status, but no repairs to the gasket area was performed.

- 3) 12/8/2004 Manual reactor scram on U3 had to be initiated due to water leak inside the Exciter housing. The cause was due to improper gasket material and improper assembly of Exciter cooler by an outside vendor resulting in a (~90 gpm) leak on the Turbine Plant Cooling Water (TPCW) piping inside the housing. While this 2004 event is not due to inclement weather it is important to note that water intrusion, an unacceptable condition, does not appear to be enough to cause shorting of the windings of the equipment when insulation is in good condition. In the subject 7/5/2020 event, the cumulative impact of aged insulation and water intrusion inside the PMG compartment resulted in the stator winding fault.

B. PTN Extent of Condition

Same Object – Same Defect:

Object: Unit 4 Exciter PMG Stator.

Defect: Failure of PMG Stator winding insulation leading to an electrical fault.

Same object and same defect apply to the Unit 3 Exciter PMG Stator windings which was installed in 1972. The Unit 3 PMG Stator is just as susceptible to the same failure mechanism given the age of the stator and potential for water intrusion to occur inside of the Unit 3 Exciter housing.

- *Rewind PMG Stator for PTN and PSL.*
- *Immediate temporary seal for PTN.*
- *Immediate investigation for PSL Exciter Housing sealing integrity*
- *Seal Exciter Housing for PTN*
- *Seal Exciter Housing for PSL (if needed)*



Same Object – Similar Defect:

Object: Unit 4 Exciter PMG Stator.

Defect: Failure of PMG Stator field cables to the Voltage Regulator housing, or jumper cables internal to the Exciter housing.

Same object and Similar Defect apply to the Unit 3 and Unit 4 Exciter PMG Stator field cables and jumper cables. These components may fault and cause a similar event to the failure of the PMG stator winding. However, there was no evidence of failure of these components during investigations. Field cables and jumper cables were tested satisfactory under FAR #5. No actions necessary.

Similar Object – Similar Defect:

Object: Unit 3 and 4 Exciter Rotor and A/C Stator.

Defect: Failure of Exciter Rotor or A/C Stator windings leading to an electrical fault.

Similar Object and Similar defect apply to the Exciter Rotor and Stator for Units 3 and 4. They are of similar construction to the PMG stator (i.e. insulating windings wrapped around an iron core). PM's for these components may not be adequate to ensure continued reliability.

- *Rewind Exciter Rotor and Exciter Stator for PTN*
- *Rewinds Exciter Rotor and Exciter Stator for PSL*

Similar Object – Similar Defect:

Object: Unit 3 and 4 Voltage Regulator – field breaker and Power Drawer.

Defect: Failure of Power Drawer or field breaker in voltage regulator leading to an electrical fault.

Similar Object and Similar defect apply to the voltage regulator field breaker and power drawer for Units 3 and 4. These components are directly connected to PMG with no ground fault monitoring. Small amount of water intrusion in Voltage Regulator housing observed by operator prior to event. These components may fault and cause a similar event to the failure of the PMG stator winding. However, there was no evidence of failure of these components during investigations. Voltage Regulator has been tested under FAR # 3. Voltage Regulator housing inspected and repaired for water leak under FAR#10. No actions necessary.



Summary: The Extent of Condition applies to the Exciter PMG Stator, Stator field and jumper cables, and the Exciter Stator and Rotor for both Units. They may be susceptible to a similar failure experienced by the Unit 4 PMG stator windings. With regards to the PMG stator field and jumper cables, no degradation was identified during investigations. The Exciter Rotor and A/C Stator are vulnerable to a similar failure given their similarities in construction to the PMG stator and the fact that they are installed outdoors covered by the Exciter housing. Corrective actions and interim actions in this report will address the extent of condition.

C. Extent of Cause

The RCE has determined two Significant Contributing Causes SCCs of the event where individually, neither will cause the event, but when combined would lead to our event. Therefore, the Extent of Cause will evaluate each SCC individually along with both causes collectively occurring.

SIGNIFICANT CONTRIBUTING CAUSE 1 – Weakness in Exciter PM Program based on existing OEM and Industry recommendations which were CONDITION BASED, and did not require TIME-BASED PMG stator rewind, thereby increasing susceptibility to failure from other stressors.

SIGNIFICANT CONTRIBUTING CAUSE 2 – OEM procedure 3.2.2.1 did not include site specific weather sealing requirements based on OE – Latent Error.

Same Object – Same Cause SCC#1:

Object: Unit 4 Exciter PMG Stator.

Cause: PM Program did not require time-based PMG Stator Rewind

Same object and same defect apply to the Unit 3 Exciter PMG Stator with no PM Program for Interval Rewind of the PMG Stator.

- *Initiate new PM for PMG Stator rewind (CAPR#1)*



Same Object – Similar Cause SCC#1:

Object: Unit 4 Exciter PMG Stator.

Cause: Lack of other age-related PMs regarding other PMG Stator Failure mechanisms.

The same object with similar cause applies to both the PTN Unit 3 and 4 Generator PMG Stators with a lack of age-related PMs to ensure reliable service. New rewind PM (CAPR#1) will address all probable age related failure mechanisms of the PMG Stator. No additional actions necessary.

Similar Object – Similar Cause SCC#1:

Object: Single Point Vulnerable (SPV) Wound equipment (U3/U4 Generator Exciter Rotor and A/C Stator, motors, transformers, etc.)

Cause: PM Program did not include age related PMs.

The SPV wound equipment are of similar construction to the PMG stator (i.e. insulated windings). PMs for these components may not be adequate to ensure continued reliability.

- *System Engineering to review Large/Small motors, and large Transformer SPVs and associated PM philosophy / Life Cycle Management Plans (LCMPs) for adequate continued reliability. (CA#4)*

Similar Object – Similar Cause SCC#1:

Object: Units 3 & 4 Emergency Diesel Generator (EDG) Exciters

Cause: Lack of age-related PMs regarding Exciter System mechanisms.

The electrical aspects of the PM program established for the Emergency Diesel Generators are performed in accordance with procedure 3/4-PME-023.2, "Emergency Diesel Generator Electrical Maintenance". Currently, the PM program includes several electrical checks of the Exciter system but does not include an age-based Exciter rewind activity. It is important to note that LTAM PTN-11-0033 to replace both the Unit 3 and 4 EDG Voltage Regulator systems (i.e. exciter components) is currently scheduled for 2021. The project is anticipated to be implemented during PT3-33/34 for the Unit 3 A and B EDGs, and PT4-33/34 for Unit 4 A and B EDGs.



- *System Engineer for Emergency Diesel Generators to review existing PM program and assess whether an age-based Exciter rewind activity is required. (CA#5)*

Summary (SCC#1): The Extent of Cause applies to the PMG Stator for both Units and their associated PM strategies. It also applies to the Exciter Rotor and Stator for each Unit given their similarities in construction. Additionally, SPV wound equipment (Steam Generator Feed Pump Motors, Reactor Coolant Pump Motors, Main and Auxiliary Transformers) apply to the extent of cause, as well as the EDG Exciters. Actions have been created to address the Extent of Cause with this significant contributor.



SIGNIFICANT CONTRIBUTING CAUSE 2 – OEM procedure 3.2.2.1 did not include site specific weather sealing requirements based on OE – latent error.

Same Object – Same Cause SCC#2:

Object: PTN and PSL Exciter PMG Stator.

Cause: OEM procedure 3.2.2.1 which reinstalls the Exciter Housing does not include site specific seals.

Same object and same cause apply to PTN and PSL Exciter PMG Stators, and their enclosures given OEM procedure 3.2.2.1 applies to both units.

- *Revise Siemens procedure 3.2.2.1 Exciter Enclosure Removal and Reinstallation to require site specific weather seals for Exciter Housing (CAPR#2)*
- *Review Siemens procedure for PSL Exciter Enclosure Removal and Reinstallation and revise as required. (CA#3)*

Same Object – Similar Cause SCC#2:

Object: PTN and PSL Exciter PMG Stator.

Cause: OEM procedures did not incorporate site OE.

- *Review PTN OEM procedures for Exciter equipment to ensure all relevant site OE is incorporated (CA#4).*
- *Review PSL OEM procedures for Exciter equipment to ensure all relevant site OE is incorporated (CA#5).*

Similar Object – Similar Cause SCC#2:

Object: SPV Wound equipment (U3/U4 Generator Exciter Rotor and A/C Stator, motors, transformers, etc.)

Cause: OEM procedures did not incorporate site OE.

- *Review SPV Wound equipment OEM procedures to ensure all relevant site OE is incorporated. (CA#6)*



Similar Object – Similar Cause SCC#2:

Object: Units 3 and 4 Emergency Diesel Generator Exciters

Cause: OEM procedures did not incorporate site OE.

- *EDG Equipment Vendor procedures may not have all relevant site OE incorporated (CA#7).*

Summary (SCC#2): The Extent of Cause for Significant Contributing Cause 2 applies to OEM procedure 3.2.2.1 and the lack of incorporation of site OE regarding site specific weather seals. It also applies to other vendor procedures for similar equipment which may not have all applicable site OE incorporated. Actions have been created to address the Extent of Cause for this Significant Contributor.

Extent of Cause Assessment w/Two Causes from SCC#1 and SCC#2

As this RCE has revealed two distinctive significant contributors caused the event, the following Extent of Cause assessment and subsequent actions provides credible substance in potentially preventing a similar event from occurring. **The Extent of Cause for Similar Object (Single Point Vulnerable Wound Equipment) – Similar Defect (Two Known Defects)** revealed potential concerns where opportunities in corrective measures are provided herein.

As stated in PI-AA-100-1005, “Root Cause Analysis” procedure, “There must be an element of judgment applied when determining the extent of condition/cause. The assessment must be of sufficient depth to mitigate a repeat event, but not so broad as to create corrective actions directed towards low probability events. This judgment shall be based on a review of the risk and consequences of reducing the extent of condition/cause from the broad-based evaluation. A Similar Object and Similar Defect assessment provides the greatest value in viable corrective actions, which is basis for the below assessment.

Similar Object – Similar Cause



Insulation aging is the aggregate effect of stresses imposed on an insulation system. As example, the stator winding insulation system provides a barrier between the copper conductors and ground. Stressors gradually degrade the insulation over time increasing failure potential. Stressors consist of electrical, environmental, mechanical, and thermal.

Object: Stator/Rotor Windings on Critical Single Point Vulnerable (SPV) Wound Equipment

Cause#1: Lack of a PM program on critical motor subcomponents (new or aged)

Cause#2: Lack of site OE incorporated into OEM procedures.

- a. Electrical: Connections, dielectric aging, tracking, corona, transients
- b. Environmental: Moisture, chemical, abrasion, ventilation
- c. Mechanical: vibration (coil movement), rotor impact, foreign material
- d. Thermal: ambient temperature, lack of ventilation, load, cycling

These stressors apply generically to all rotating electrical apparatus. While some of these stressors are present as a part of normal operation, others are external influences that accelerate degradation and reduce insulation life. In the case of the PTN4 PMG Stator failure, normal aging coupled with moisture intrusion over time led to an online failure.

Extent of cause applies to motors, large transformers, and generators operating in a similar environment, with age being a factor in failure potential. As a result, actions as part of this RCE have been initiated to evaluate the existing PM program for Critical / SPV motors, large transformers, and EDGs, and initiate PMCs in EStrategy for any gaps identified in respect to life cycle management rewinds.



D. Safety Culture Evaluation

During the Safety Culture Impact Review minor issues were found, none indicating a weakness in the stations Safety Conscious Work Environment. Missing Barriers were identified but all pertained to a weak or broken barrier and were organizational or programmatic in nature, not personnel issues.

The Nuclear Safety Culture Evaluation Form was filled out based on information obtained through the FIP, reviews of Operator, OCC and FIP Team logs, research, interviews and the RCE process. Furthermore, feedback from the Employees Concerns Program did not identify any concerns that were brought up dealing specifically with the PMG Exciter failure, the FIP process, the RCE, or interviews conducted during the investigation. The PTN team has and continues to consistently display a strong Safety Conscious Work Environment.

INTRODUCTION

The safety culture evaluation is performed for each CAQ RCE. The nuclear safety culture evaluation is also performed for issue investigations when addressing an NRC finding. When addressing an NRC finding or violation, the investigation should determine the cause of the condition leading to the finding/violation, and Cross-Cutting aspect if applicable.

The purpose of a nuclear safety culture evaluation is to determine if the organization has a healthy bias towards nuclear plant safety and demonstrates their commitment to nuclear safety culture as an overriding priority across the Reactor Oversight Program cornerstones of safety. The intent of the evaluation is to ensure the analysis assesses the root cause(s) to the Nuclear Safety Cross-Cutting Aspects and the corresponding corrective actions are aligned to mitigate repetitive events.

This Safety Culture Evaluation is part of the Regulatory Margin Corrective Action Strategy defined in LI-AA-200. The focus of this program is to initiate action prior to an NRC performance threshold being crossed.

Each identified cause is categorized against the most relevant aspects in the categories of Human Performance (H), Problem Identification & Resolution (P) and Safety Conscious Work Environment (S).

Note

Per NRC Inspection Manual Chapter 0310, the supplemental cross-cutting aspects (X) are to be considered only when performing or reviewing safety culture assessments during the conduct of the supplemental inspections (95001, 95002 and 95003).



The following definitions are provided as an aide to understanding and performing the safety culture evaluation.

Nuclear Safety Culture: The core values and behaviors resulting from a collective commitment by leaders and individuals to emphasize safety over competing goals to ensure protection of people and the environment.

Cross-Cutting Area: Fundamental performance characteristics that extend across all the Reactor Oversight Program cornerstones of safety. These areas are human performance (HU), problem identification and resolution (PI&R), and safety conscious work environment (SCWE).

Cross-Cutting Aspect: A performance characteristic that is the most significant contributor to a performance deficiency.



Nuclear Safety Culture Evaluation Table

06.01 Human Performance (H)

#	Criteria	Comment
H.1	Resources: Leaders ensure that personnel, equipment, procedures, and other resources are available and adequate to support nuclear safety (LA.1).	<u>Significant Contributing Cause / CAPR #2</u> OEM procedure 3.2.2.1 did not include site specific weather sealing requirements based on OE– Latent Error.
H.2	Field Presence: Leaders are commonly seen in the work areas of the plant observing, coaching, and reinforcing standards and expectations. Deviations from standards and expectations are corrected promptly. Senior managers ensure supervisory and management oversight of work activities, including contractors and supplemental personnel (LA.2).	Not Applicable
H.3	Change Management: Leaders use a systematic process for evaluating and implementing change so that nuclear safety remains the overriding priority (LA.5).	Not Applicable
H.4	Teamwork: Individuals and work groups communicate and coordinate their activities within and across organizational boundaries to ensure nuclear safety is maintained (PA.3).	Not Applicable
H.5	Work Management: The organization implements a process of planning, controlling, and executing work activities such that nuclear safety is the overriding priority. The work process includes the identification and management of risk commensurate to the work and the need for coordination with different groups or job activities (WP.1).	<u>Significant Contributing Cause / CAPR #2</u> OEM procedure 3.2.2.1 did not include site specific weather sealing requirements based on OE – Latent Error.
H.6	Design Margins: The organization operates and maintains equipment within design margins. Margins are carefully guarded and changed only through a systematic and rigorous process. Special attention is placed on maintaining fission product barriers, defense-in-depth, and safety related equipment (WP.2).	Not Applicable
H.7	Documentation: The organization creates and maintains complete, accurate and, up-to-date documentation (WP.3).	Not Applicable
H.8	Procedure Adherence: Individuals follow processes, procedures, and work instructions (WP.4).	Not Applicable
H.9	Training: The organization provides training and ensures knowledge transfer to maintain a knowledgeable, technically	Not Applicable



	competent workforce and instill nuclear safety values (CL.4).	
H.10	Bases for Decisions: Leaders ensure that the bases for operational and organizational decisions are communicated in a timely manner (CO.2).	Not Applicable
H.11	Challenge the Unknown: Individuals stop when faced with uncertain conditions. Risks are evaluated and managed before proceeding (QA.2).	Not Applicable
H.12	Avoid Complacency: Individuals recognize and plan for the possibility of mistakes, latent issues, and inherent risk, even while expecting successful outcomes. Individuals implement appropriate error reduction tools (QA.4).	Not Applicable
H.13	Consistent Process: Individuals use a consistent, systematic approach to make decisions. Risk insights are incorporated as appropriate (DM.1).	Not Applicable
H.14	Conservative Bias: Individuals use decision making practices that emphasize prudent choices over those that are simply allowable. A proposed action is determined to be safe in order to proceed, rather than unsafe in order to stop (DM.2).	Not Applicable

06.02 Problem Identification and Resolution (P)

#	Criteria	Comment
P.1	Identification: The organization implements a corrective action program with a low threshold for identifying issues. Individuals identify issues completely, accurately, and in a timely manner in accordance with the program (PI.1).	Not Applicable
P.2	Evaluation: The organization thoroughly evaluates issues to ensure that resolutions address causes and extent of conditions commensurate with their safety significance (PI.2).	Not Applicable
P.3	Resolution: The organization takes effective corrective actions to address issues in a timely manner commensurate with their safety significance (PI.3).	Not Applicable
P.4	Trending: The organization periodically analyzes information from the corrective action program and other assessments in the aggregate to identify programmatic and common cause issues (PI.4).	<u>(Significant Contrib Cause / CAPR #1)</u> Weakness in Exciter Program based on ex OEM and Industry recommendations which were CONDITION BASED, and did not TIME-BASED PMG rewind, thereby increase susceptibility to fail under other stressors. (AR 00406541)



		2010-10671- INPO A (ER.2-1) – Critical Components are Fail
P.5	Operating Experience: The organization systematically and effectively collects, evaluates, and implements relevant internal and external operating experience in a timely manner (CL.1).	<u>Significant Contribu Cause / CAPR #2)</u> OEM procedure 3.2.2 not include site speci weather sealing requirements based o Latent Error.
P.6	Self-Assessment: The organization routinely conducts self-critical and objective assessments of its programs and practices (CL.2).	Not Applicable

06.03 Safety Conscious Work Environment (S)

#	Criteria	Comment
S.1	SCWE Policy: The organization effectively implements a policy that supports individuals’ rights and responsibilities to raise safety concerns, and does not tolerate harassment, intimidation, retaliation, or discrimination for doing so (RC.1).	Not Applicable
S.2	Alternate Process for Raising Concerns: The organization effectively implements a process for raising and resolving concerns that is independent of line management influence. Safety issues may be raised in confidence and are resolved in a timely and effective manner (RC.2).	Not Applicable
S.3	Free Flow of Information: Individuals communicate openly and candidly, both up, down, and across the organization and with oversight, audit, and regulatory organizations (CO.3).	Not Applicable

06.04 Supplemental Cross-Cutting Aspects (X)

#	Criteria	Comment
X.1	Incentives, Sanctions, and Rewards: Leaders ensure incentives, sanctions, and rewards are aligned with nuclear safety policies and reinforce behaviors and outcomes that reflect safety as the overriding priority (LA.3).	Not Applicable
X.2	Strategic Commitment to Safety: Leaders ensure plant priorities are aligned to reflect nuclear safety as the overriding priority (LA.4).	Not Applicable
X.3	Roles, Responsibilities, and Authorities: Leaders clearly define roles, responsibilities, and authorities to ensure nuclear safety	Not Applicable



	(LA.6).	
X.4	Constant Examination: Leaders ensure that nuclear safety is constantly scrutinized through a variety of monitoring techniques, including assessments of nuclear safety culture (LA.7).	Not Applicable
X.5	Leader Behaviors: Leaders exhibit behaviors that set the standard for safety (LA.8).	Not Applicable
X.6	Standards: Individuals understand the importance of adherence to nuclear standards. All levels of the organization exercise accountability for shortfalls in meeting standards (PA.1).	Not Applicable
X.7	Job Ownership: Individuals understand and demonstrate personal responsibility for the behaviors and work practices that support nuclear safety (PA.2).	Not Applicable
X.8	Benchmarking: The organization learns from other organizations to continuously improve knowledge, skills, and safety performance (CL.3).	Not Applicable
X.9	Work Process Communications: Individuals incorporate safety communications in work activities (CO.1).	Not Applicable
X.10	Expectations: Leaders frequently communicate and reinforce the expectation that nuclear safety is the organization's overriding priority (CO.4).	Not Applicable
X.11	Challenge Assumptions: Individuals challenge assumptions and offer opposing views when they think something is not correct (QA.3).	Not Applicable
X.12	Accountability for Decisions: Single-point accountability is maintained for nuclear safety decisions (DM.3).	Not Applicable

5.E Risk/Consequence

Personnel safety

There were no risks to Personnel Safety

Environmental safety

There were no risks to Environmental Safety

Actual nuclear safety significance

This event resulted in an automatic Reactor trip due to Turbine Trip / Generator Lockout. Reactor power was at 100% at the time of the trip. There was no challenge to the integrity of the primary or secondary plant. The plant response during this event is bounded by an event assuming a loss of load analyzed in Turkey Point's Updated Final Safety Analysis Report. This event is not a safety significant event and had no adverse effect on the health and safety of the public.



Note: This trip negatively impacted the NRC performance indicator for "Unplanned Scrams per 7000 critical hours." There is adequate margin to white for the NRC PI, and no additional actions are required for this indicator.

6. Operating Experience

An OE search was conducted on the INPO industry websites, IRIS Experience report and the NextEra Energy fleet Corrective Action Program (CAP) to determine if prior OE was available related to Turbine Exciter PMG failures and/or Turbine trip from a Main Generator lockout or other potentially related issues. The first focus was on HB Robinson due to it being most like PTN regarding its Turbine Generator then the review was expanded to the entire industry and then to PTN.

HB Robinson OE Review:

Robinson U2 - (2/27/1985) – IRIS # 276795

HB Robinson U2 experienced a Turbine trip due to failed Min Transformer lightning arrester on "C" Transformer causing a generator-to-Main Transformer differential Generator lockout giving a Turbine trip.

Robinson U2 - (5/2/1988) IRIS Report #286116

HB Robinson U2 experienced a Turbine trip with reactor power greater than 10 percent Turbine Governor valve position limiter failed to zero position which signals the four governor valves to shut. The Turbine tripped from a Main Generator lockout which resulted in a reactor trip. The Generator lockout occurred due to a reverse power condition caused by closure of the Turbine Governor valves.

Robinson U2 - (11/17/2006) – IRIS # 223907

HB Robinson U2 experienced a Main Generator voltage regulator alarm. The cause for the Main Generator voltage regulator alarm was due to an apparent faulty Overexcitation Protection module but that no failure of the voltage regulator had occurred and even with the alarm locked in none of the voltage regulator's capacity was lost.

Robinson U2 - (8/11/2019) – IRIS # 461198

HB Robinson U2 experienced a Plant trip and subsequent outage due to Main Generator exciter failure

On 8/11/2019 at 08:41, an automatic plant trip occurred on Main Generator Lockout. The first out annunciator received was a Turbine trip. At the same time the control board indicator for the exciter field breaker amps began to fail with excessive voltage to ground resulting in the meter smoking and emitting some arcing. This was followed by the loss of field (40) relay actuating, causing a Main Generator Lockout and exciter field breaker trip, resulting in a turbine trip and subsequent reactor trip. Alarms APP-009-A1 (loss of generator excitation), APP-009-A2 (generator excitation low/trip), APP-009-B1 (regulator field forcing), and APP-009-D1 (exciter power loss/trip or generator field



ground detection) were received. Upon investigation, strong acrid odor was noted on the turbine deck. The exciter was found with significant damage including metal slag on the floor of the exciter house.

It was later determined that an arc fault had occurred inside the exciter armature (rotor) causing substantial damage to the rotating and stationary windings of the exciter as well as the inboard diode wheels. Due to excessive damage to the rotating components of the exciter, the exact cause could not be determined. The cause was most likely a latent failure of the exciter armature due to either coil or core failure, although as stated the precise cause was indeterminate.

Robinson Corrective Action Summary:

- Replace the exciter with a refurbished exciter.
- Test all related circuits (voltage regulator, main generator field and stator) to ensure fault did not damage them.
- Replace the control board meter and removed the unintended ground path(s) and Megger cables to ensure no additional low resistance paths existed. Fuses to its circuit to help prevent excessive overcurrent were added.

Review of Industry OE:

Braidwood U2 (Exelon) - (11/30/1993) IRIS # 141879

Braidwood U2 found age related degraded component

Nomex components (winding components) located under the phase leads were found to have migrated from their original position. **The apparent cause was the exciter retaining band lost its tension preload due to age related degradation.** Migrating components under the banding is a known occurrence that could possibly occur within “advanced age” exciters. However, Siemens never notified Exelon of this migration possibility before their A2R18 outage. After the condition was noticed during A2R18, Exelon decided that the exciter needed replacement instead of returning to operation.

Waterford 3 (Entergy)

Waterford U3 experienced a Main Generator trip due to a loss of excitation.

An automatic main generator/turbine trip occurred due to the main generator losing excitation. Upon inspection, two outboard diodes were found to have arced and shorted within the rotating rectifier circuit. Excessive dirt and other debris were built up in the interior of the rotating rectifier. The debris formed an electrical path between diodes and subsequently caused the arcing. **The main causal factors were an unclear preventative maintenance scope and not completing work order steps without justification.**

Indian Point Unit 2 (Entergy)

Indian Point U2 experienced a Min Generator trip due to a loss of excitation.

Alarms for “Exciter Cubicle Trouble” were received by the Control Room but before operators could investigate, the main generator tripped due to loss of excitation. A diode stack had failed, and **the root cause was that the power diode test method proved**



unable to detect component degradation. A corrective action implemented a preventative maintenance strategy to guarantee proper monitoring and testing of the power diodes.

Hope Creek U1 (11/30/1993) IRIS # 141879

Hope Creek forced normal Rx shutdown due to failure of Main Generator Exciter

Operator on normal rounds reported arcing on the Main Generator /Alterex inboard excite #2 brush. These brushes can be changed out on-line and that was attempted but during that process the other two brushes (brush 1 and 3) began arcing at which time it was decided to take the unit off-line for repairs. The cause was degraded brush to collector ring contact causing overheating and deterioration of the collector ring surface.

This was an age-related component failure.

INPO'S Encyclopedia of OE:

SER 60-82

An electrical fault within the main generator exciter was accompanied by arcing. This led to a reactor trip, extensive exciter damage (needing three weeks of repair), and an indefinite cause. It is suspected that either loose bolting between exciter bus bars and brush support or a failed connection located at the 90-degree bend of a bus bar led to the arcing. In response to this issue, Westinghouse disseminated a letter to turbo generator owners reminding them that they should verify the tightness of exciter connections and check the exciter bus bars bolt torque before each plant startup.

O&MR 256-85

A loss of main generator excitation caused a turbine generator trip resulting in a subsequent reactor trip. The cause of exciter failure was a brush failure. The brush became lodged between its guide and spring arm and thus caused arcing. The brush had excessive wear and the incident could have been prevented had the brush inspection criteria been more stringent. The resultant solution was increasing brush inspection to every 14 days, adding brush replacement criteria to the inspection, and presenting preventative maintenance training to the electrical maintenance personnel.

Utility Generator Predictive Maintenance conference (12/3/1998):

Under the section in the report regarding Moisture, the following was stated:

The presence of contaminated water, condensation, or any type of moisture can also cause failure of diode wheel components. Electrical "tracking", as described earlier, can occur with moisture in the same way as it does with dirt or fly ash. Moisture can also lower the insulation resistance of the diode wheel components and the windings.

Outdoor generating units in high humidity areas are prone to having moisture form in the exciter house through condensation on the cooling coils. Condensation was so much of a problem at Florida Power & Lights (FPL) Martin, Manatee and Sanford stations that the cooling water would often be shut off when the units cycled off at night.

Moisture can also be a problem on outdoor units, if the seal between the exciter house and the sole plate is not adequate. One of the units in southern Florida (PTN's Unit 3)



was found to be drawing water off the turbine deck and into the exciter house in the area of the PMG. The problem was found when the rotor ground detector indicated a problem. The unit was shut down and the exciter house was swabbed and then vacuumed. The base was temporarily sealed with a bead of RTV. A more permanent fix was enacted during the next refueling outage. Better seals and their correct installation solve the problem.

Of course, cooler leaks, inside the Exciter housing, can also be a source of moisture. Cooler leaks should be repaired immediately.

Both issues mentioned in this section of the “Utility Generator Predictive Maintenance conference report” (internal and external water intrusion) have reoccurred at PTN subsequent to this report dated 12/3/1998. These issues and are documented OE contained in the IRIS Experience Report and are listed below.

Turkey Point specific OE Review:

Turkey Point U3 - (IRIS # 194413) / Date: 9/29/2001

Turkey Point U3 experienced a Forced power reduction due to failure of gasket / seal / o-ring(s) in the Main Turbine Generator.

On 9/29/2001 at 10:30 AM Turkey Point U3 received a Main Generator ground indication in the Control room. Following efforts to clear the ground the station decided to take the unit off-line. The unit went into a forced power reduction due to **water intrusion into the U3 Exciter housing. During the event it was noted that the station had been under a severe weather condition with continuous rainfall.** The cause of the water intrusion was ineffective sealing of the exciter bolt channels. With a large pressure differential created in the Exciter housing by the oversized blower it contributed to the volume of water that was drawn into the housing. The investigation also stated that the removal of pipe plugs for an upcoming outage combined with the heavy rains in the area were the contributing causes which led to the event. Extent of condition inspections were conducted to ensure PTN U4 did not have existing leak paths or other relative areas of concern. U4 Exciter housing was found to be sealed properly and dry.

Turkey Point U3 - (IRIS # 213642) / Date: 12/28/2004

Turkey Point U3 experienced a manual scram due to failure of housing assembly in Main Generator Exciter.

On December 28, 2004 at 22:46 hours a manual Reactor trip was initiated due to a large (~90gpm) turbine plant cooling **water leak within the Unit 3 Main Generator Exciter housing.** The discovery of the leak resulted in a fast load reduction from 100% power operation to 70% power at 2235 hours. Once the Operating crew determined the potential impact from the turbine plant cooling water leak, in the Exciter housing and that the leak was non-isolatable, the reactor was manually tripped at 2246 hours.

OE SUMMARY:

Whereas Robinson has experienced numerous issues with their U2 Turbine Generator resulting in Turbine lockouts, Turbine trips and Reactor trips, their 2017 event, where an



arc-fault occurred in the exciter components and the evidence (debris, smell, visual damage) found during the investigation process, is very similar in nature to what occurred and was subsequently found at PTN during the July 2020 - U4 Turbine Exciter event. A search of OE across the industry show stations experiencing Turbine Exciter issues, most attributed with age related degradation and/or preventive maintenance and monitoring practices. While relatively little to no OE was found directly related to the PMG portion of the Exciter system, the failures noted were primarily due to stator-rotor contact due to bearing failures. There was one paper written by EPRI in Dec 1998 that referenced several FPL plants that were experiencing condensation problems in the Exciter house and even one that speaks of a South Florida plant (PTN Unit 3) where the fan created such a pressure difference that coupled with poor housing base gaskets resulted in water being drawn off the turbine deck into the PMG compartment.

Except for the Robinson event and the events referred to in the EPRI Report mentioned above no other similar issues as what occurred at PTN could be found for comparison.

A review of external and internal OE for PTN identified two issues both related to water intrusion. From the dates shown on the documents it shows that these issues have reoccurred at various times. One issue was water intrusion (leaking gaskets) from an internal source and the other was water intrusion from an external source. The discussion in the OE regarding the external water intrusion highlights three factors. First being the environmental conditions at the time (heavy rains), which can have an adverse effect on outdoor Turbine structures such as what we have here at PTN. Secondly the inadequate sealing of the bolt channels and removal of pipe plugs allowing a leak path into the housing to exist. Third the dynamics and ability of the fan inside the Exciter housing when at full power, that can draw up migrating water and disperse it throughout the housing, potentially affecting the electrical components contained therein and resulting in faults to the electrical components.

While very little OE exists relating directly to the PMG, there is industry wide experience with cable aging effects. Some insulation types such as XLPE is expected to last 60-70 years; however, most insulation materials used is expected to have a shorter life expectancy under normal conditions (20-30 years). When insulation is exposed to more extreme conditions the life expectancy is expected to be less. Once the insulation is compromised, water or contamination can lead to shorts which in turn lead to further failure.

The overall assessment of OE leads to two potential contributing causes for failure. One being age related degradation of Turbine Exciter components and second being water intrusion and saturation of exciter electrical components. It is important to note that the review of internal and external OE did not reveal any failures that were solely attributed to aging of a PMG or Exciter stator/rotor winding. Additionally, vendor and industry documentation for Exciter maintenance does not require Exciter/PMG rewind activities. EPRI documents titled 'Tools to Optimize Maintenance of Generator Excitation System, Voltage Regulator and Field Ground Detection' dated 2002, and 'Plant Support Engineering: Main Generator End-of-Life and Planning Considerations' dated 2007, make no mention of a requirement for Exciter/PMG winding rewinds. Overhaul activities are recommended which include thorough cleaning, inspection, and testing of these components.



EPRI and other industry reports recommend condition-based PM philosophy (test and maintain) for brushless exciters are referenced from 1998 to 2002. At that time brushless exciter with PMG design were 15 years old and age-related risk did not contribute in any failure analysis. The industry had not experienced winding failures due to age at that time.

INPO IER Level 2-11-2 “2009 – 2010 Scram Analysis” vs. PTN Response vs. LCM

A review of the PTN response to INPO IER L2-11-2 in respect to Life Cycle Management found the conclusion failed to recognize weakness in the PM program. The Rotating Exciter and Voltage Regulator interim conclusion states:

“No replacement or LCMPs are needed for this component type at this time. However, this conclusion should be revisited after the EPU mods.”

The most recent LCM review in 2014 following EPU provided no update to that previous conclusion. Some of the issues specifically outlined in the IER that are directly applicable to the current RCE are as follows:

- Over reliance on skill of craft.
- Discretionary use of blanket statements allowing individual decisions on work steps.
- Ensure planners have requisite knowledge & skill.

An action will be created to provide an update to the IER and to update the Life Cycle Management Plan.

7. Lessons Learned

Vendor recommendations and current industry practices alone with regards to equipment maintenance may not be sufficient to support equipment reliability. The PM philosophy at PTN developed for maintaining the Exciter and Generator components relied upon the recommendations of the OEM and the Industry (CONDITION-BASED) and are considered robust. However, they lacked a requirement to perform a TIME-BASED rewind of the Exciter components. This lack of a rewind requirement allowed the equipment to age which increased susceptibility to failure from other external stressors. Single Point Vulnerability SPV components which are similar in design (i.e. insulating windings around an iron core, e.g. motors and transformers) should be reviewed for appropriate Life Cycle Management (LCM) activities which specifically address age.

8. Proof Statement

(Problem Statement)

On July 5th, 2020 at approximately 2107, during a heavy rainstorm, Unit 4 Tripped Automatically from 100% power due to a Generator Lockout. Object: Unit 4 Exciter PMG.



Defect: Winding Failure. Consequence: Loss of Generator Field Excitation and subsequent tripping of the Reactor and Turbine.

Is caused by
(Root Cause)

A weakness in Exciter PM program resulted from a failure to fully assess risk of PMG stator winding age making it more susceptible to failure when exposed to water/moisture.

And is corrected by

(CAPR) This event will be prevented from re-occurrence by:

- Initiate a TIME-BASED PMG stator rewind PM

Revise OEM procedure 3.2.2.1 to include installation of site-specific weather seals during Exciter housing installation.

9. **Corrective Actions**

Area	Category	Corrective Action/Assignment	Responsible	Assignment Type	Due Date
Direct Cause (s)					
Direct Cause PMG Failure	Equipment	<ul style="list-style-type: none"> Replace failed PMG Stator and damaged Exciter Rotor. COMPLETE Apply temporary sealant on Unit 4 Exciter Housing. COMPLETE 			
Root Cause (s)					
Root Cause A weakness in the Exciter PM program resulted from a failure to fully assess risk of PMG stator winding age making it more susceptible to failure when exposed to water/moisture	Programmatic	Addressed by CAPR #1 and CAPR #2 below			
Significant Contributing Cause (s)					
Significant Contributing Cause #1 Weakness in Exciter PM Program based on existing OEM and Industry recommendations which were CONDITION BASED, and did not require TIME-BASED PMG stator rewind, thereby increasing susceptibility to failure from other stressors.	Programmatic	CAPR #1: Initiate a TIME-BASED PMG stator rewind PM for Unit 4	PGD Tech. Services	CAPR Assignment 21	11/19/2020
Significant Contributing Cause #2 OEM procedure 3.2.2.1 did not include site specific weather sealing requirements based on OE – latent error.	Organizational	CAPR #2: Revise Siemens procedure 3.2.2.1 <i>Exciter Enclosure Removal and Reinstallation</i> to require site specific weather seals for Exciter Housing	PTN Nuc. Construction	CAPR Assignment 22	Complete
Contributing Cause (s)					
CC #1: Instructions in PTN procedure 0-GMM-090.1, “Exciter Removal, Inspection and Installation,” in providing discretionary guidance in lieu of a mandated requirement on Exciter housing application of site specific weather seals for prevention of water intrusion.	Organizational	CA #1: Revise site procedure 0-GMM-090.1 to require base seal with each assembly.	PTN Nuc. Construction	CA Assignment 23	Complete
Extent of Condition Action					

Area	Category	Corrective Action/Assignment	Responsible	Assignment Type	Due Date
New Exciter Rewind PMs for PTN and PSL scheduled beyond service life of components.	Programmatic	LTCA #1-4: Scope replacement of PMG Stator, AC Exciter Field, and AC Exciter Armature with rewind spares during the following outages: <ul style="list-style-type: none"> ▪ LTCA #1: SL1-30 Spring 2021 (Assignments 24 & 41) ▪ LTCA #2: PTN3-32 Fall 2021 (Assignments 25 & 42) ▪ LTCA #3: PTN4-33 Spring 2022 (Assignments 26 & 43) ▪ LTCA #4: SL2-27 Spring 2023 (Assignments 27 & 44) 	PGD Tech. Services	LTCA	8/31/2021
Units 3 & 4 Exciter Housing requires immediate sealing	Equipment	Apply temporary sealant on both Units 3 & 4 Exciter Housing. COMPLETE.	N/A	N/A	N/A
Unit 3 Exciter Housing lacks site specific seals.	Equipment	LTCA #5: Seal Unit 3 Exciter Housing IAW 0-GMM-90.1 or Siemens procedure 3.2.2.1 during next refueling outage.	PTN Nuc. Construction	LTCA Assignment 45	2/26/2021
Unit 4 Exciter Housing lacks site specific seals.	Equipment	LTCA #6: Seal Unit 4 Exciter Housing IAW 0-GMM-90.1 or Siemens procedure 3.2.2.1 during next refueling outage.	PTN Nuc. Construction	LTCA Assignment 46	8/31/2021
PSL Exciter Housing may lack site specific seals.	Equipment	LTCA #7: Assess if site specific sealing is required for PSL Units 1 and 2 Exciter Housing and address as necessary.	PGD Tech. Services	LTCA Assignment 47	2/26/2021
Extent of Cause Actions					
PSL vendor procedure for Exciter Housing Removal and Reinstallation may lack site specific seals.	Programmatic	CA#2: Review Siemens procedure for PSL Exciter Enclosure Removal and Reinstallation and revise as required.	PSL Project Mgr.	CA Assignment 28	12/18/2020
PTN Vendor procedures related to Exciter compartments may not have all relevant site OE incorporated.	Programmatic	CA#3: Review PTN vendor procedures for Exciter equipment to ensure all relevant site OE is incorporated.	PTN Nuc. Construction	CA Assignment 29	12/18/2020
PSL Vendor procedures related to Exciter compartments may not have all relevant site OE incorporated.	Programmatic	CA#4: Review PSL vendor procedures for Exciter equipment to ensure all relevant site OE is incorporated.	PSL Project Mgr.	CA Assignment 30	12/18/2020
SPV Wound Equipment Vendor procedures may not have all relevant site OE incorporated.	Programmatic	CA#5: Review SPV Wound equipment vendor procedures to ensure all relevant site OE is incorporated	PTN System Engr.	CA Assignment 31	12/18/2020
EDG Equipment Vendor procedures may not have all relevant site OE incorporated.	Programmatic	CA#6: Review PTN EDG Equipment Vendor procedures to ensure all relevant site OE incorporated	PTN System Engr.	CA Assignment 32	12/18/2020



Area	Category	Corrective Action/Assignment	Responsible	Assignment Type	Due Date
Single Point Vulnerable (SPV) equipment (SGFPs, RCPs, large Transformers) may not have adequate PMs to address aging of insulation. The PMs for these components may not be adequate to ensure continued reliability.	Programmatic	<p>CA #7: System Engineering to review Large/Small motors, and large Transformer SPVs and associated PM philosophy / Life Cycle Management Plans (LCMPs) for adequate age-related tasks. As part of this review, identify and evaluate time-based rewind PM coincident with probable stressors at location and provide remedial sub-actions. Sub-actions to include the activation of a rewind PM and practical remedies to eliminate or reduce the effects of external stressors such as:</p> <ul style="list-style-type: none"> • Electrical: Connections, dielectric aging, tracking, corona, transients • Environmental: Moisture, chemical, abrasion, ventilation • Mechanical: vibration (coil movement), rotor impact, foreign material • Thermal: ambient temperature, lack of ventilation, load, cycling 	PTN System Engr. Supv.	CA Assignment 33	11/19/2020
Exciter Systems for Emergency Diesel Generators (EDGs) may not have adequate PMs to perform age related rewind activities.	Programmatic	CA #8: System Engineer for Emergency Diesel Generators to review existing PM program and assess whether an age-based Exciter rewind activity is required.	PTN System Engr.	CA Assignment 34	11/19/2020
Current weather seal applied to both Unit 3 and 4 Exciter Housing is a temporary measure. Need a Bridging strategy to ensure temporary seals remain intact until site specific foam gasket and vertical foam seal are installed.	Programmatic	CA #9: Site staff to perform monthly inspection of Unit 3 and 4 Exciter Housing temporary weather seals. Due date associates with establishing an inspection program.	PTN Nuc. Construction	CA Assignment 35	11/19/2020
PM 50551-42 includes task to performs Exciter Housing Door Seal and Hardware inspection every 36M. Seal replacements are discretionary.	Programmatic	CA #10: Revise PM 50551-42 to require replacement of all Exciter housing door seals. Consider creating a new standalone 18M PM task for door seal replacements.	PGD Tech. Services	PMCA Assignment 36	2/26/2021
Other (Enhancements)					
Lack of Ground Detection System on PMG Stator Windings	Equipment	A #1: Create LTAM to install a ground detection system to detect grounds on the PMG stator windings and downstream circuits. Consider also Exciter stator monitoring.	PGD Engr.	MA Assignment 37	2/26/2021
Inability to monitor exciter interior online for water intrusion.	Equipment	A #2: Create LTAM to install leak detection system to identify online water intrusion inside Exciter housing.	PGD Engr.	MA Assignment 38	2/26/2021
0-GME-090.02 for Voltage Regulator Switchgear Maintenance relies on discretionary repairs to mitigate water intrusion into the Voltage Regulator housing.	Programmatic	A #3: PCR against 0-GME-090.02 to require clarification that if the procedure is being performed as part of a routine PM activity, the Voltage Regulator Roof shall be coated for water intrusion, all existing door gaskets and seals replaced, and supplementary seals be reapplied.	PTN System Engr.	PCRA Assignment 39	11/19/2020



10. **Deferral Justification**

All associated actions including the CAPR are justifiably provided with a completion due date commensurate with ensuring the least probable risk for equipment failure. The applied dates on the contributor's respective actions will not impact or affect any/all safety systems presently operating. The FIP activities that followed the event date provided immediate interim actions as applicable per the program requirements. Any/all equipment actions or assignments identified from the FIP and RCE conclusions will be performed during subsequent refueling outages. Both PSL and PTN will be provided with interim corrective actions to ensure sufficient temporary sealant is applied at the susceptible locations around the Exciter housing. There are no FIP actions impacted as a result of the actions and associated dates applied. O&P weaknesses have been identified and associated actions are being assigned. These identified O&P weaknesses are not considered to require immediate attention. Appropriate assignment due dates will be applied to ensure appropriate oversight to same-same, same-similar and similar-similar equipment during subsequent refueling cycles and identified equipment respective PMs.

11. **Effectiveness Review Plan**

The following attributes are required when performing the effectiveness review.

a. Methodology

Perform assessment to document the following:

1. Review of all CAPR actions and CA actions taken and dates completed from this CR.
2. Search for similar condition reports.
3. Search for any condition reports that may have resulted from the corrective actions from this root cause.

b. Attributes

1. Verify that the actions have been implemented as written.
2. Verify that no similar issues have been reported since the corrective actions were implemented.
3. Verify that no new unwanted/unexpected conditions have occurred due to the corrective actions implemented for this event.
4. Verify that the O&P changes are comprehensive enough to ensure that designers, planners and implementers are adequately informed to minimize water intrusion events for same/similar objects.



c. Success Criteria

1. All the actions have been implemented as prescribed in the root cause report.
 2. No Turbine Exciter equipment failures/trips or perturbations due to water intrusion or condensate buildup within the housing since the Extent of Condition and Cause actions and other field related corrective actions having been implemented.
 3. No new unwanted/unexpected conditions have occurred due to the corrective actions implemented for this event.
- d. Timeframe – Complete the effectiveness review within 18 months of the completion date of the final CAPR.

12. **Attachments**

- Attachment 1 - Root Cause Charter
- Attachment 2 - Photographs
- Attachment 3 - Exciter Ground Detection System
- Attachment 4 – Exciter PM Description and Status
- Attachment 5 – FIP Team Support/Refute Matrix
- Attachment 6 – Root Cause Support/Refute Matrix
- Attachment 7 - Barrier Analysis
- Attachment 8 – Timeline
- Attachment 9 – Potential Paths of Water Ingress



Attachment 1: Root Cause Charter

ROOT CAUSE CHARTER

Facility/CR Number:

Turkey Point Nuclear / AR 02361794

Manager Sponsor:

Dianne Strand, Engineering Director

Brief Event Description:

The Unit 4 Reactor tripped due to a Main Generator (4K2) Lockout followed by a Turbine Trip. The Main Generator Lockout was caused by actuation of the Voltage Regulator (VR) Lockout relay due to loss of VR Power Supplies #1 & #2.

Detailed Event Description:

On July 5th, 2020 at approximately 1844, during a heavy thunderstorm, the Control Room received Annunciator AN-E-8/3 (GEN CONTACT FIELD BRUSH CONTACT FAIL/GROUND) on Unit 4. At approximately 1900, the Turbine Operator depressed the RESET pushbutton above the generator field breaker IAW Procedure 4-ARP-097.CR.E. Annunciator AN-E-8/3 momentarily reset then re-alarmed. Annunciators AN-E-9/3 (GEN VOLT REG LOSS OF BACKUP) and AN-E-7/6 (GEN VOLT REG TRANSFER TO MANUAL) subsequently alarmed. Annunciator AN-E-9/3 cleared as soon as it was acknowledged. However, Annunciators AN-E-8/3 and AN-E-7/6 remained locked-in. At this time the VR swapped from Automatic AC regulator to Manual DC regulator.

At approximately 2045, Operations noted one alarm on the local VR panel, "Loss of XDCR No. 1". Shortly thereafter, at approximately 2050, Annunciators, AN-E-9/3 (GEN VOLT REG LOSS OF BACKUP) & AN-E-8/6 (GEN VOLT REG TROUBLE) were received multiple times. Operations also observed reactive load on the Unit 4 Main Generator increase from 115 MVAR to 200 MVAR during a 5-minute period.

At approximately 2100, Operations reported that the Exciter field volts were oscillating. Then, at 2107 the Unit 4 Reactor tripped due to a Main Generator (4K2) Lockout followed by a Turbine Trip. The Main Generator Lockout was caused by the actuation of the VR Lockout relay due to loss of VR Power Supplies #1 & #2. After the trip, the following Generator Exciter Switchgear control cabinet alarms remained locked in: Power Supply #1, Power Supply #2, Firing Circuit #2, and Loss of XDCR #1.

Problem Statement:

The Unit 4 Reactor tripped due to a Main Generator (4K2) Lockout followed by a Turbine Trip. The Main Generator Lockout was caused by actuation of the Voltage Regulator (VR) Lockout relay due to loss of VR Power Supplies #1 & #2.



Attachment 2: Photographs



Fig. 1 U4 Exciter Housing

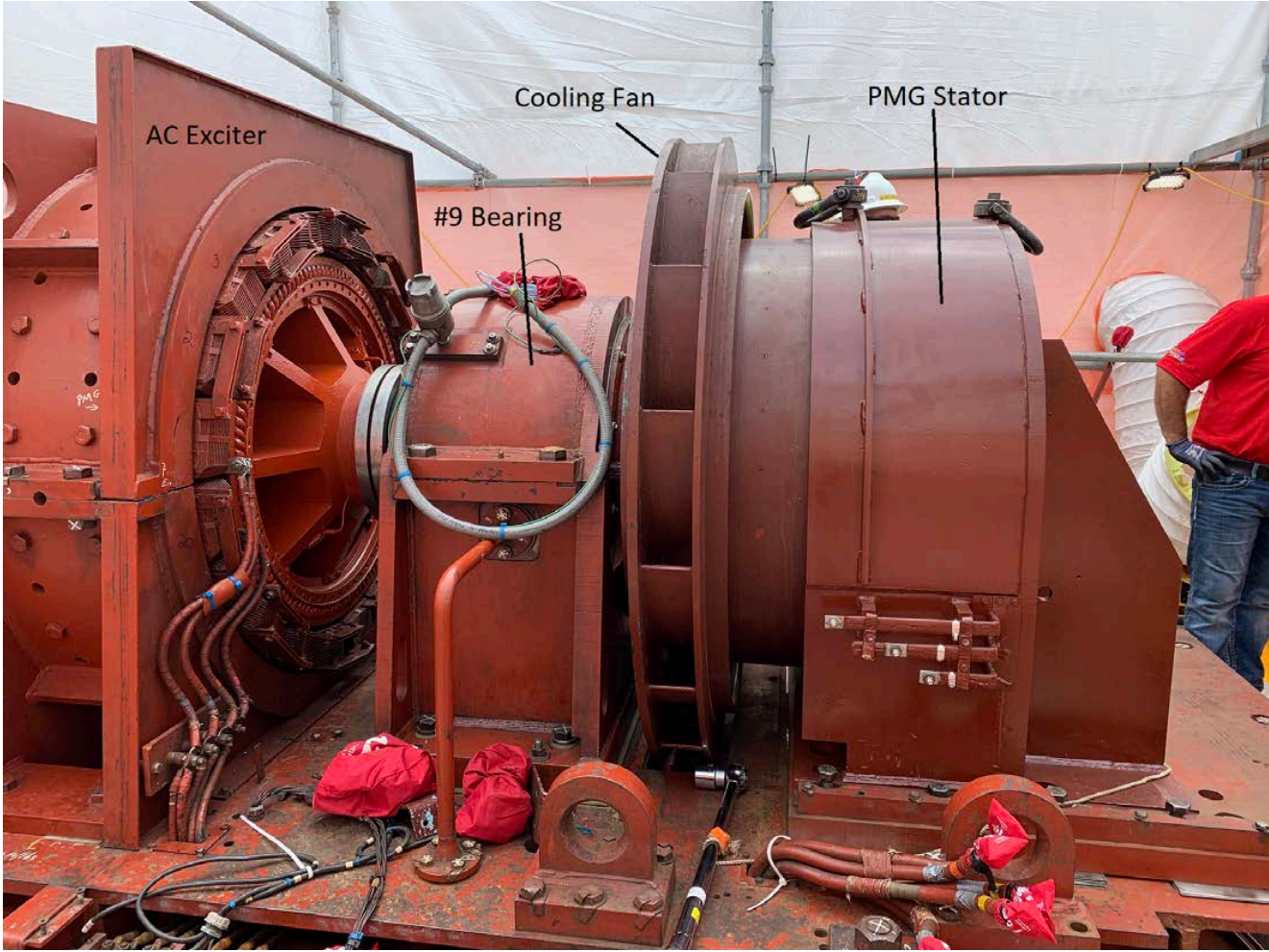

Fig. 2 U4 Exciter with PMG Stator Installed

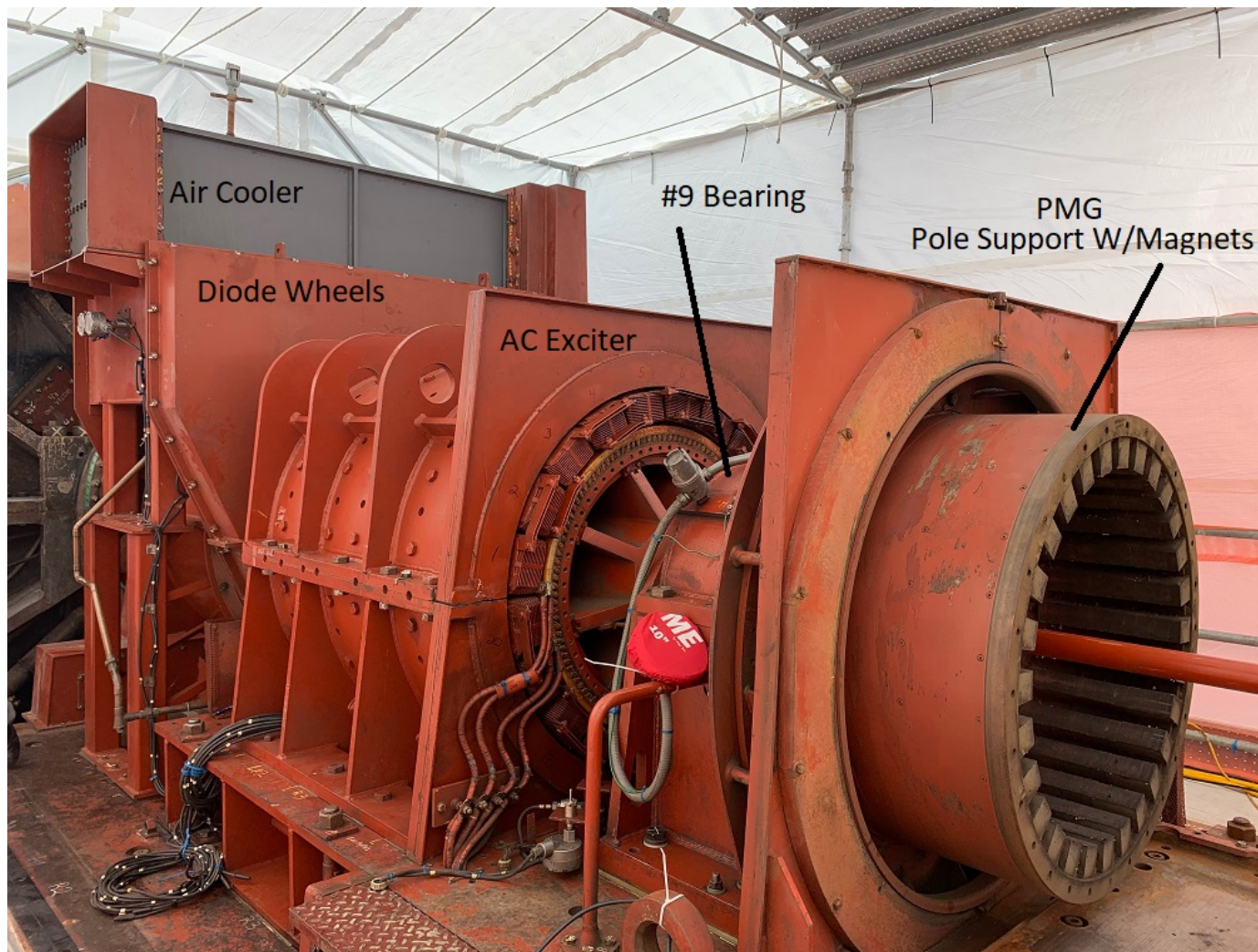

Fig. 3 U4 Exciter with Housing and PMG Stator Removed

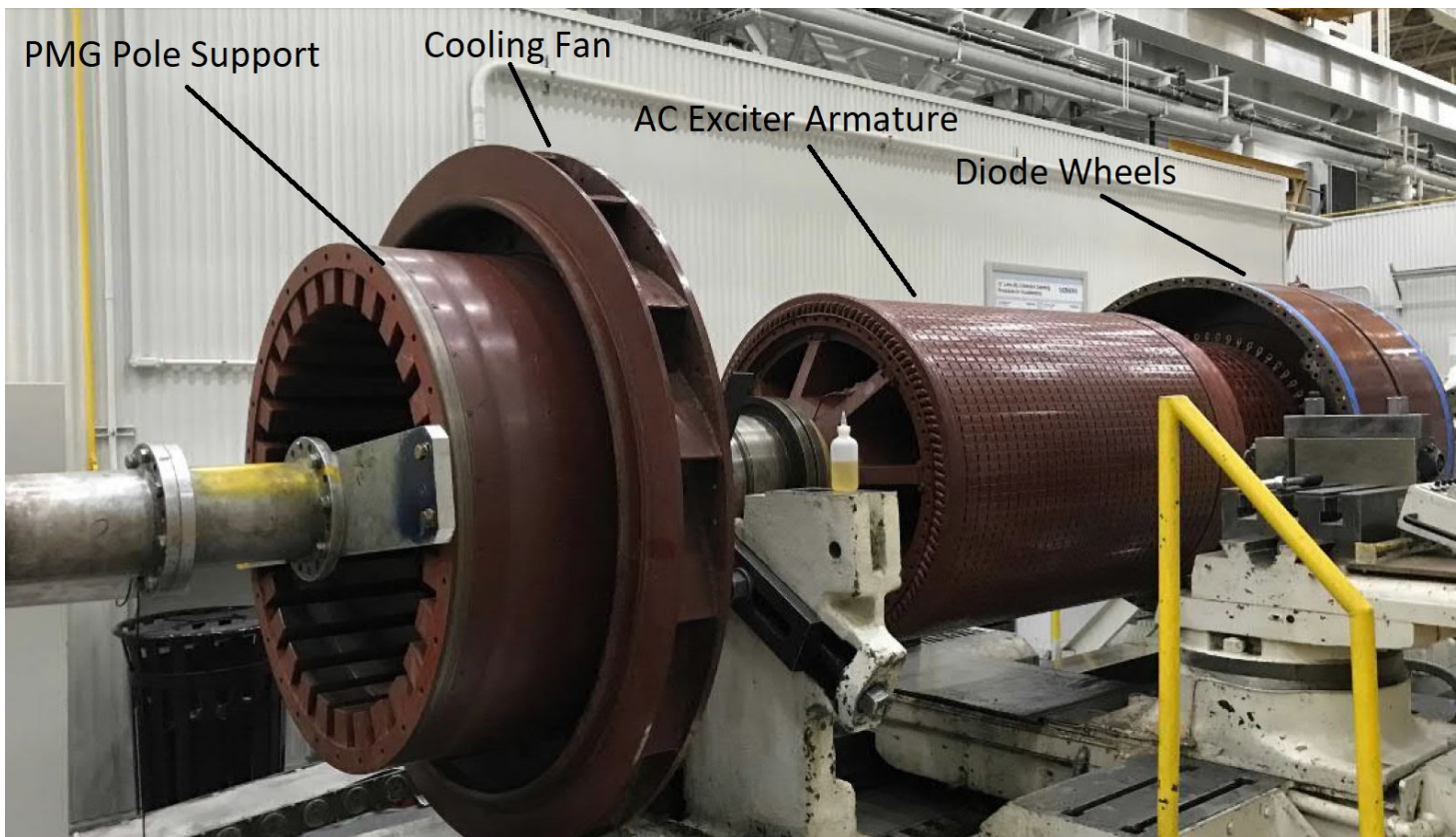

Fig 4 Exciter Rotating Element Removed



Fig. 5 U4 PMG Stator Removed



Fig. 6 PMG Stator Core – Coil Melt in Slots



Fig. 7 PMG Stator Coil Connection Ring Failures



Fig. 8 PMG Pole Support w/ Magnets



Fig. 9 PMG Magnet Rub



Fig. 10 PMG Magnet Cracking



Fig. 11 Foreign Material (Shims) Found in AC Exciter Section



Fig. 12 Liberated Shim Stock Found in AC Exciter Section



Fig. 13 Exciter Base to Housing Seal / Gasket Arrangement



Attachment 3: Generator and Exciter Ground Detection System Discussion

The Turkey Point Units 3 and 4 brushless excitation systems are ungrounded. The Generator Field Ground Detection System monitors ground for Generator Rotor, Exciter Rotor (exciter armature), and Rectifier Diode Wheels. The exciter is equipped with a set of auxiliary slip rings that permit intermittent ground checks through the operation of a set of solenoid actuated brushes (two brushes for each slip ring for redundancy) and an external monitoring circuit. One slip ring is connected to the midpoint of the star-connected exciter armature and the other is connected to the shaft (ground). The automated Ground Detector Panel is located inside the Excitation Switchgear right cubicle above Field Breaker panel. It consists of the circuitry which applies a DC voltage across the two slip rings and measures the resultant current flow.



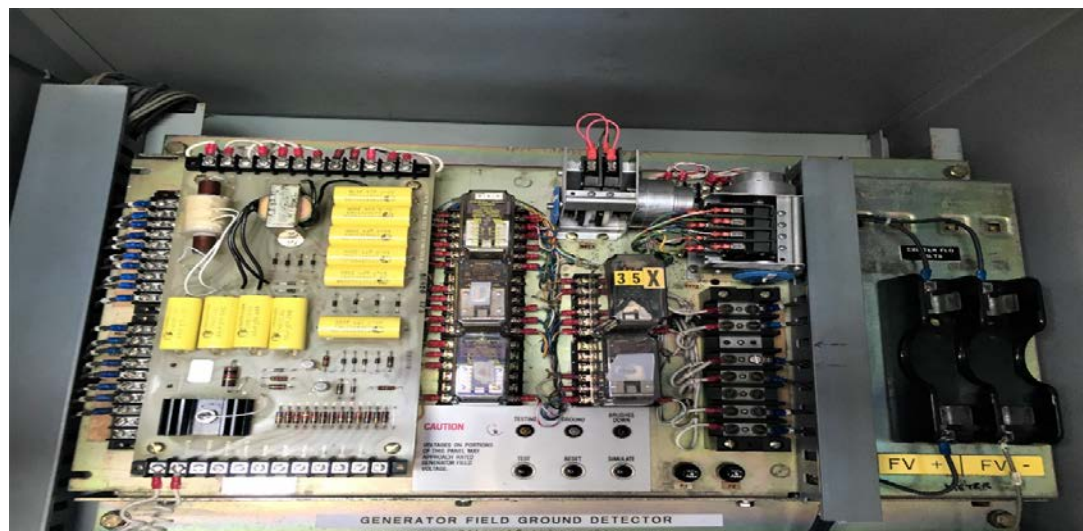

The ground detector panel provides an automatic ground check on the Generator rotor and exciter rotor once every 24-hours. Three push buttons switch are located on ground detector module for TEST- RESET – SIMULATE function with status indication lights. Operation of the test switch allows a ground check to be performed manually at any time.

During the period of time that the ground detector panel is not performing a ground check, brushes are disconnected from the machine slip rings and ground sensing is inactive. Brushes only contact the slip rings for one minute every 24 hours during an automated test cycle. If a ground is detected during the one min test cycle, then an alarm will latch in until manually reset from the ground detection panel.

Event cause and analysis:

Control Room received Annunciator AN-E-8/3 (GEN CONTACT FIELD BRUSH CONTACT FAIL/GROUND) on Unit 4 at 1844 with heavy rainstorm. This is the first alarm received from voltage regulator prior to trip event. At approximately 1900, the Turbine Operator depressed the RESET pushbutton above the generator field breaker IAW Procedure 4-ARP-097.CR.E. Annunciator AN-E-8/3 momentarily reset then re-alarmed.

Automated ground detection cycle is only 1 minute, and brushes should have been pull back after 1-minute cycle assuming no mechanical locking or solenoid miss operation. Brushes no longer connected to slip ring after 1 minute from receiving alarm.



Alarm stay locked in after manual reset which means there was still ground current path between brushes or Exciter housing cable terminals. This is likely from excessive moisture around brush area which result in small amount of ground current to flow between brushes and alarm stay locked in assuming ground detection panel is healthy and working properly.

FAR # 7 confirmed no issue on Ground Detector sensing panel. Ground brushes solenoid actuation system PM performed, and no issue found in solenoid actuation arrangement.

Cause Analysis: Moisture contributes to keep ground alarm stay locked in during heavy rain.



Barrier Analysis and Alternatives – PMG Winding Failure:

Simplified diagram of Turkey Point Units 3 and 4 WTA-300 voltage regulator with brushless exciter and main generator:

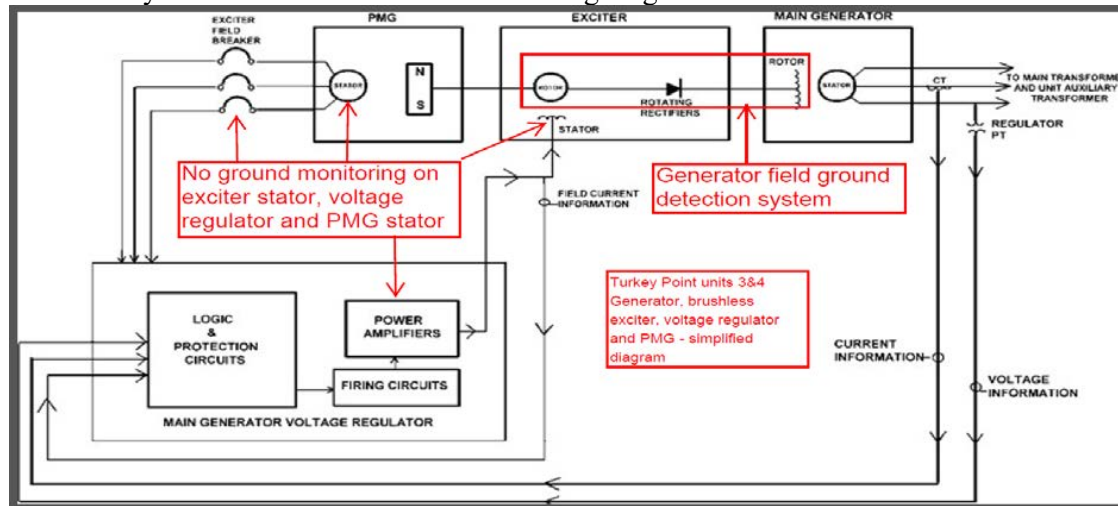

- Turkey Point units 3 and 4 have Generator field ground monitoring system and do not have exciter field ground monitoring. Generator field ground system monitors ground on Generator rotor, rectifier diode wheel and exciter rotor (armature). Exciter field ground monitors continuous ground on exciter stator (field), Voltage Regulator, cables and PMG stator.
- Point Beach WTA-300B installed in 2000 have exciter field ground monitoring addition to the generator field ground monitor system. PB voltage regulator drawing no: 97-MK365SAA. 64B is Generator field ground detector and 64F is exciter field ground detector.

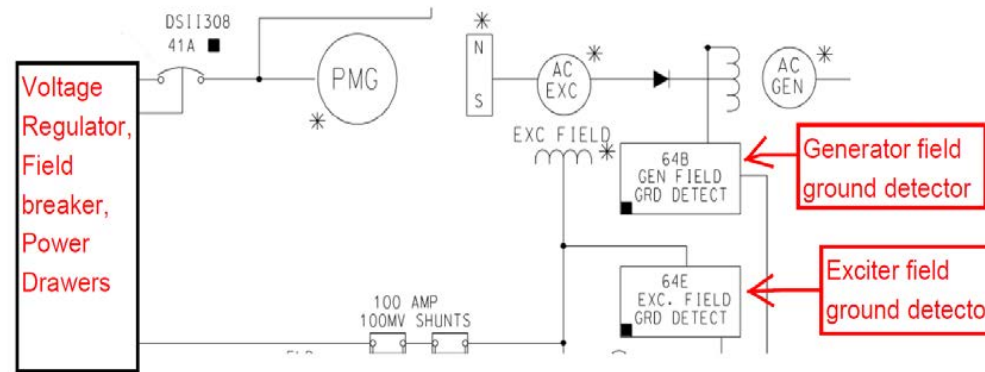

Simplified Drawing of AVR, PMG, and AC Exciter Circuits

- Exciter Field Ground identify small ground which can accelerate over time if undetected and result in catastrophic event like PMG winding fail or exciter stator winding fail. Field Ground provides early detection of degradation of winding insulation in some fault scenario however Exciter Field Ground will not help to identify catastrophic fault on PMG or exciter field winding which do not give enough time for operator action for troubleshoot and analysis.
- Exciter field ground module connects to exciter field terminal of voltage regulator output with ground and provides continuous ground monitoring.

Proposed addition/modification of exciter field ground detector in Turkey Point WTA-300 voltage regulator:

- Exciter field ground module 64F installed at Point Beach is obsolete and Basler (OEM of voltage regulator) no longer manufacture that style module.
- Two vendor options suitable to add in Turkey Point WTA-300 voltage regulator for continuous monitoring of ground on Exciter field winding, voltage regulator power drawer, field breaker and PMG stator winding. Bender module ISO-685-D and Basler relay BE1-64F.
- Digital ground monitor module / relay has two levels of adjustable alarm setting for ground resistance. First level of ground used for alarm. Second level of ground can be used for operator action to initiates control shutdown.



- Bender module ISO-685D has digital display of ground resistance with two level alarm settings. Bender module also have analog output to use for plant DCS / PI to give ground resistance trend. Bander module ISO-685 is installed in couple of FPL fossil units and going to be installed on all Toshiba steam units.
- Basler (voltage regulator OEM) has BE1-64F ground relay with two adjustable alarm setting. Basler relay do not have digital indication and analog output for ground resistance measurement.
- Power supply for exciter field ground is 120Vac which can be connected to existing generator field ground detector power supply. Alarm contact can be parallel to Generator field ground annunciator. Trip level alarm can be group in to “Voltage Regulator Trouble” for immediate operator action – control shutdown.



Bender ISO 685-D ground detector module

Bender module exciter field connection, power supply and alarm contacts diagram:

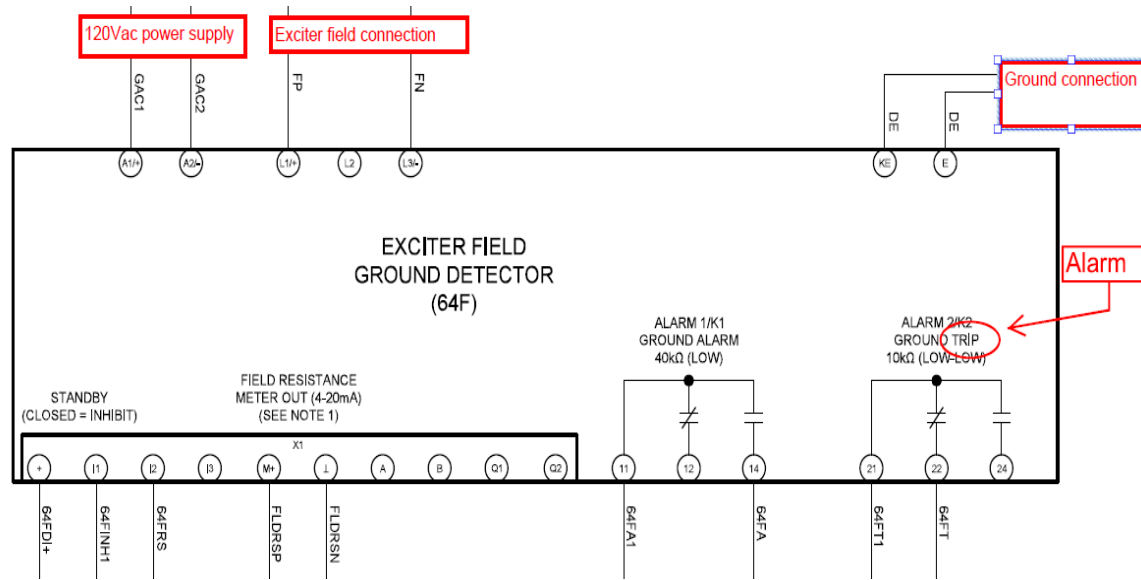

Exciter Field Ground Detector Module

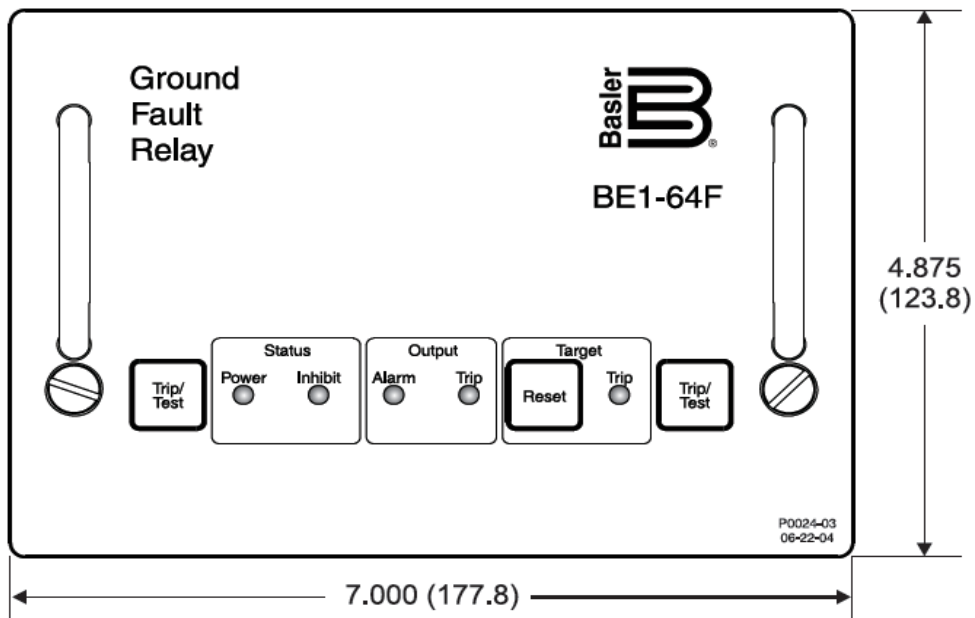

Basler field ground fault relay BE1-64F

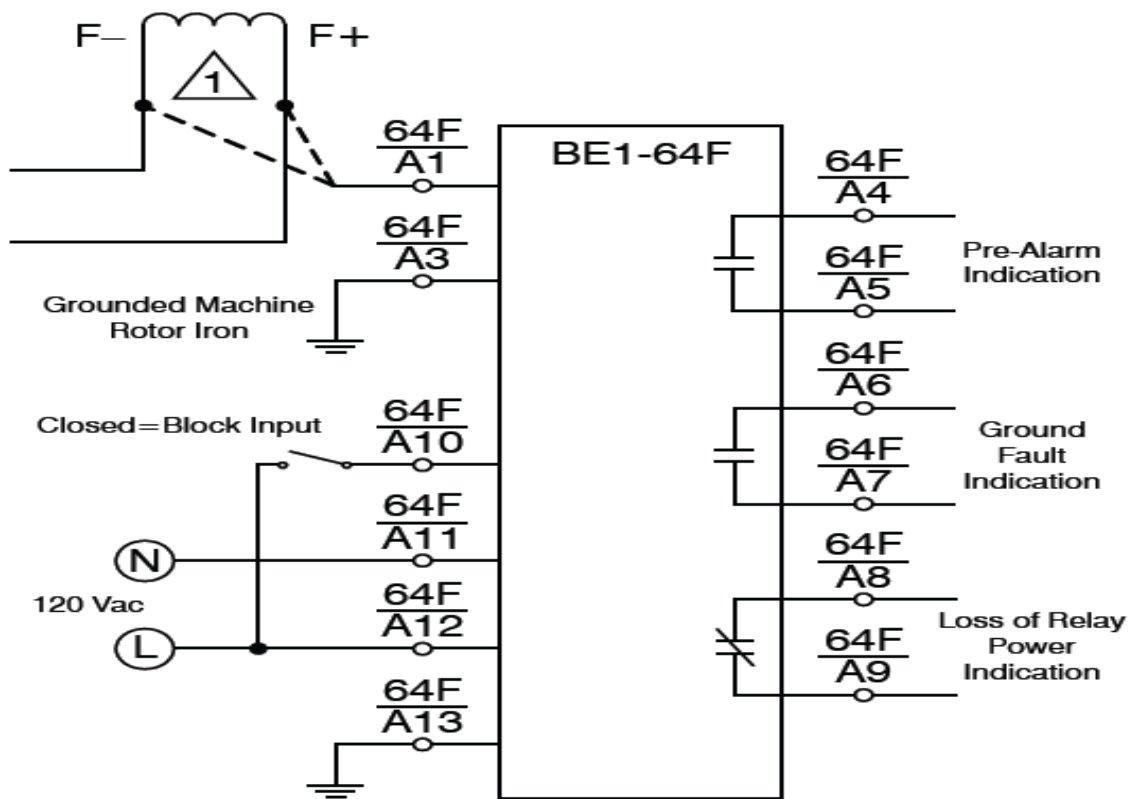

1 Connect terminal A1 to F- for models 9367200103 and 9367200104.
Connect terminal A1 to F+ for models 9367200201 and 9367200203.

Figure 1 - BE1-64F Connection Diagram for a Typical Application

Basler BE1-64F connection diagram



Attachment 4: Exciter PM Description and Status

There are five Westinghouse Frame A201C Exciters shared between PTN and PSL. Four are permanently installed (two at each site) with one spare shared between the sites. However, the spare Exciter base is not interchangeable and as a result only the individual parts (PMG, rotating element, AC Exciter Stator) are considered viable spares. The Brushless Exciters have never been fully refurbished. Maintenance strategy currently consists of the following:

- i. Minor Inspection - Each Exciter is inspected and tested in place every 18 months (each refueling outage)
 - a. PMG Stator
 - i. Insulation resistance
 - ii. Resistance measurement
 - iii. Visual inspection
 - b. AC Exciter Field
 - i. Insulation resistance
 - ii. Pole balance and impedance calculation of Field Winding
 - iii. Resistance measurement
 - c. AC Exciter Armature (including Diode Wheels)
 - i. Diode Fuse resistance measurements
 - ii. Pole balance and impedance calculation of Field Winding
 - iii. Insulation resistance
 - iv. Resistance measurement
 - v. Visual inspection
- ii. Major Inspection – At 7.5 years (5 refueling outages) each Exciter is disassembled. Inspections and tests are as with the Minor inspection with the following additions:
 - a. PMG Stator
 - i. Stator removed from base, inspected
 - b. AC Exciter Stator
 - i. Disassembled (horizontally split for rotor removal) and inspected
 - c. AC Exciter Armature (including Diode Wheels and PMG Pole Support)
 - i. Insulation resistance with rotor install -Diode Wheels to Shaft
 - ii. Insulation resistance with rotor install - Diode Wheel to Diode Wheel



- iii. Replacement of complete rotating element with an overhauled spare
- iii. Each rotating element (including the spare) is fully refurbished at 7.5 years (Siemens Shop Overhaul). Work occurs between outages.
 - a. PMG Magnets requalified or replaced
 - b. AC Armature cleaned, inspected, tested
 - c. Diode wheels disassembled and overhauled
 - i. Fuses
 - ii. Heat sinks with diodes installed
 - iii. Supports and insulation
 - iv. Forward resistance and reverse leakage current check of diodes
 - v. Fuse resistance checks
 - vi. Charge capacitors, capacitance check
 - vii. Replace heat sink insulation
 - viii. Test heat sink hardness
 - d. NDE
 - e. High speed balance
- iv. FPL Exciter rewind status
 - a. Rotating Elements: Two of the five rotating elements (AC Armatures) have been rewound for cause
 - i. Spare: Rewound in 2010. Removed from PTN4 after 2020 PMG failure and currently at Siemens for refurbishment
 - ii. PSL1: Not Rewound (~40 years old)
 - iii. PSL2: Rewound 2015
 - iv. PTN3: Not Rewound (~40 years old)
 - v. PTN4: Not Rewound (~40 years old)
 - b. Stationary Components: There is no record available of rewind of any of the stationary components (PMG Stator or AC Exciter Stator). However, PTN and PSL exciters and PMGs are current for minor and major maintenance.
 - c. Status of PTN4 Exciter prior to 2020 PMG failure:
 - i. Major overhaul Spring 2019



1. Major inspection performed on PMG and AC field
 2. Spare rotating element was installed; rotating element was rewound in 2010 and overhauled in 2018 prior to installation
- v. The proposed schedule for implementation of the rewind schedule for PMG Stator, AC Exciter Field, and AC Exciter Armature is as follows
- a. SL1-30 April 2021
 - b. PTN3-32 Fall 2021
 - c. PTN4-33 Spring 2022
 - d. SL2-27 Spring 2023

Attachment 5: FIP TEAM SUPPORT / REFUTE MATRIX

<u>FIP TEAM SUPPORT / REFUTE MATRIX</u>					
Support/Refute Matrix – AR 02361794, Generator Exciter Switchgear Control Cabinet Alarms					
Failure Modes/Cause	Discussion	Supporting Evidence	Refuting Evidence	Actions	Status
Equipment: Generator Exciter					
1. Generator Ground	A single generator ground alone will not cause a trip given the system is ungrounded. A ground would actuate the 64 and 64X relays which provide interlocks to the ground brush solenoids and cause annunciator E-8/3 to come in.		This does not result in a Generator lockout / Turbine trip. However, the ground detection system is still indicating a ground while not connected to the Rotor. A SAT megger was performed on the Rotor Shaft (106 MΩs) via FAR 5 per WO 40731687-17.	Visually and electrically check the Exciter, Diode Wheel, Slip Rings and Ground Brushes. FAR 5 performed a megger of the rotor shaft with SAT results (106MOhms) FAR 7 was issued to troubleshoot the ground detection circuit. Wires GD4 and GD5 were replaced due to bad insulation. PMT is pending.	Refuted

FIP TEAM SUPPORT / REFUTE MATRIX

Support/Refute Matrix – AR 02361794, Generator Exciter Switchgear Control Cabinet Alarms

Failure Modes/Cause	Discussion	Supporting Evidence	Refuting Evidence	Actions	Status
2. Field Brushes not making good contact with aux slip rings	Does not cause a trip but caused an annunciator to come in (E-8/3).		This does not result in a Generator lockout / Turbine trip.	<p>Perform a visual inspection & continuity check.</p> <p>Perform a TEST from VR Panel and confirm no brush contact fail alarm.</p> <p>FAR 7 was issued to troubleshoot the ground detection circuit. Wires GD4 and GD5 were replaced due to bad insulation. PMT is pending.</p>	Refuted
3. Ground Detection Instrument Failure	Does not cause a trip but caused an annunciator to come in (E-8/3).		This does not result in a Generator lockout / Turbine trip.	<p>Perform TEST from VR Panel and confirm “no brush contact fail alarm”.</p> <p>Check Ground detector panel lights working with TEST.</p> <p>FAR 7 was issued to</p>	Refuted

<u>FIP TEAM SUPPORT / REFUTE MATRIX</u>					
Support/Refute Matrix – AR 02361794, Generator Exciter Switchgear Control Cabinet Alarms					
Failure Modes/Cause	Discussion	Supporting Evidence	Refuting Evidence	Actions	Status
				troubleshoot the ground detection circuit. Wires GD4 and GD5 were replaced due to bad insulation. PMT is pending.	
4. Over Excitation	An over excitation condition will cause a generator lockout.		Refuted by lack of receipt of Annunciator E-8/2 Generator Field Forcing/Volt Regulating Limit alarm. Voltage Regulator has Over Excitation Protection modules that would prevent the type of damage that was observed. Additionally, FAR 3 performed 0-GME-090.01 section 4.17 which confirmed the Forcing Alarm Module setpoints were set correctly. This module drives the E-8/2 annunciator.	None	Refuted



FIP TEAM SUPPORT / REFUTE MATRIX

Support/Refute Matrix – AR 02361794, Generator Exciter Switchgear Control Cabinet Alarms

Failure Modes/Cause	Discussion	Supporting Evidence	Refuting Evidence	Actions	Status
5. Generator Voltage Imbalance	Does not cause a trip but caused an annunciator to come in (E-7/6).		<p>Refuted by lack of receipt of Annunciator E-8/5.</p> <p>The 260/A voltage balance relay which drives the E-8/5 annunciator monitors the generator output voltage, not the PMG and Exciter voltage. Damage was isolated to PMG/Exciter equipment.</p>	None	Refuted
6. Loss of sensing module	Does not cause a trip but caused an annunciator to come in (E-7/6).		<p>This does not result in a Generator lockout / Turbine trip. It would explain the transfer of the voltage regulator from AC to DC control. The PMG provides the source voltage which the failing of would result in the loss of sensing.</p>	<p>Perform Procedure 0-GME-090.01 Section 4.6.</p> <p>Check Regulator PT secondary fuses.</p> <p>Check metering PT secondary fuses.</p> <p>FAR 3 tested the Loss of Sensing Module with SAT results.</p>	Refuted

<u>FIP TEAM SUPPORT / REFUTE MATRIX</u>					
Support/Refute Matrix – AR 02361794, Generator Exciter Switchgear Control Cabinet Alarms					
Failure Modes/Cause	Discussion	Supporting Evidence	Refuting Evidence	Actions	Status
7. Loss of transducer/s	Does not cause a trip but caused an annunciator to come in (E-7/6).		This does not result in a Generator lockout / Turbine trip. It would explain the transfer of the voltage regulator from AC to DC control. The PMG provides the source voltage which the failing of would result in the loss of XDCRs.	Perform Procedure 0-GME-090.01 Section 4.9. FAR 3 tested the Loss of Transducer Module with SAT results.	Refuted
8. Fan Failure	Does not cause a trip but caused an annunciator to come in (E-9/3).		This does not result in a Generator lockout / Turbine trip. Temperature was reported to be 68 degrees which would not challenge equipment threshold of 100 degrees F.	None	Refuted
9. Enclosure Over Temperature	High temperatures in the VR Enclosure can cause component malfunctions and subsequent generator trip. Annunciator E-9/3 did come in and can be triggered by enclosure		Refuted by Operations investigation. Temperature was reported to be 68 degrees F. Alarm trip point is 100F or greater.	None	Refuted

<u>FIP TEAM SUPPORT / REFUTE MATRIX</u>					
Support/Refute Matrix – AR 02361794, Generator Exciter Switchgear Control Cabinet Alarms					
Failure Modes/Cause	Discussion	Supporting Evidence	Refuting Evidence	Actions	Status
	overtemperature.				
10. Power Amp Blown Fuses	Does not cause a trip but caused an annunciator to come in (E-9/3).		Fuses checked SAT per WO 40731687-01	Check fuse continuity.	Refuted
11. Loss of pulse to firing circuits	Does not cause a trip but caused an annunciator to come in (E-9/3).		This does not result in a Generator lockout / Turbine trip.	Perform Procedure 0-GME-090.01 Section 4.10. FAR 3 tested the Firing Circuit Modules [LRBB] and [LREE] with SAT results.	Refuted

<u>FIP TEAM SUPPORT / REFUTE MATRIX</u>					
Support/Refute Matrix – AR 02361794, Generator Exciter Switchgear Control Cabinet Alarms					
Failure Modes/Cause	Discussion	Supporting Evidence	Refuting Evidence	Actions	Status
12. Exciter Field Breaker ground fault	<p>A ground fault on Exciter Field Breaker may have caused the sustained high current on T-30 phase.</p> <p>(TAW report concludes cause of failure was fault external to PMG)</p>		Refuted by lack of receipt of Annunciator E-8/5. Breaker was inspected SAT under FAR #3. No signs of damage or overheating.	<p>Rack out and visually inspect field breaker.</p> <p>Perform procedure 0-GME-090.01 Section 4.3</p> <p>FAR 3 tested the Generator Field Breaker FB-4 with SAT results.</p>	Refuted
13. Failure of PS1 and PS2	<p>Failure of both power supplies would result in voltage regulator lockout, generator lockout and turbine trip. Causes annunciator to come in (E-9/3).</p>		Power supplies were functionally tested SAT during performance of FAR 3. Visual inspections of the supplies did not reveal any damage. Fuses are intact.	<p>Procedure 0-GME-090.01 Section 4.5</p> <p>FAR 3 tested the both 24VDC Power Supplies with SAT results.</p>	Refuted



FIP TEAM SUPPORT / REFUTE MATRIX

Support/Refute Matrix – AR 02361794, Generator Exciter Switchgear Control Cabinet Alarms

Failure Modes/Cause	Discussion	Supporting Evidence	Refuting Evidence	Actions	Status
14. Failure of PS1 and PS2 fuses	Failure of both power supply fuses would result in voltage regulator lockout. Causes annunciator to come in (E-9/3).		Fuses checked SAT per WO 40731687-01	Check Fuse Continuity	Refuted
15. Failure of PS1 and PS2 transformers	Failure of both power supply transformers would result in voltage regulator lockout. Causes annunciator to come in (E-9/3).		Power supplies where functionally tested SAT. Output voltages were as expected.	Procedure 0-GME-090.01 Section 4.5 FAR 3 tested the both 24VDC Power Supplies with SAT results.	Refuted
16. PMG Failure (loss of voltage to PS1 and PS2)	Failure of PMG would result in loss of voltage to PS1/PS2 and subsequent regulator lockout	Evidence of arc flash event and pressure wave in PMG stator. Melted copper beads and dislodged enclosure gasket were found in vicinity of PMG. Acrid smell at north end of generator. Electrical checks (DLRO and megger readings) per WOs		PMG Visual Inspection. PMG Electrical Checks. FAR 5 performed electrical testing of the PMG. Megger results of the PMG were 10KOhms.	Direct Cause



FIP TEAM SUPPORT / REFUTE MATRIX

Support/Refute Matrix – AR 02361794, Generator Exciter Switchgear Control Cabinet Alarms

Failure Modes/Cause	Discussion	Supporting Evidence	Refuting Evidence	Actions	Status
		40731687-04 & 40731687-17 were UNSAT as well. Removal of the PMG stator revealed severe winding and core damage. There is also indication of isolated rubbing damage between the magnet and stator which looks like interference with the debris.		Note that this is default value for the instrument and no voltage was developed with the test indicating a hard ground within the PMG.	
17. Grid Disturbance	Transient in the grid may have caused regulator lockout.		A review by Operations of the PI data as well as a discussion / review by Transmission (Mike Powers) has determined that there was no grid disturbance during the time of the event.	Review PI data Discuss with Mike Powers	Refuted

<u>FIP TEAM SUPPORT / REFUTE MATRIX</u>					
Support/Refute Matrix – AR 02361794, Generator Exciter Switchgear Control Cabinet Alarms					
Failure Modes/Cause	Discussion	Supporting Evidence	Refuting Evidence	Actions	Status
18. Roof leak causing water intrusion inside voltage regulator housing	Water intrusion into housing / voltage regulator cabinets may have caused lockout. (TAW report concludes cause of failure was fault external to PMG)		Per inspection performed via WO 40731687-01, there was no evidence of water intrusion within any circuits or equipment. There was some superficial water around edges of the room and some small drips.	Visual Inspection FAR 10 repaired/reapplied protective coating on regulator housing. FAR 3 test the Voltage Regulator system with SAT results. No components were found in a failed state.	Refuted
19. PMG Stator Coil to Magnet air gap failure	Loss of PMG air gap would result in a hard rub and severe stator core damage and fault of the PMG stator windings.	Visual inspection of the PMG following removal of the stator revealed some rubbing on the surface of the magnets and stator windings. The rubbing is not in large areas or appear to be indicative of contact between the two, but more likely the rubbing of debris within the PMG following the	Visual inspection of the disassembled PMG found indications of rubbing. The core rubbing indications appear to be secondary collateral damage; a result of copper and core material slag being dragged through the air gap following the event. No significant smearing of stator core laminations was discovered	Visual Inspection Air gap was validated SAT via FAR 5 per WO 40731687-17.	Refuted



FIP TEAM SUPPORT / REFUTE MATRIX

Support/Refute Matrix – AR 02361794, Generator Exciter Switchgear Control Cabinet Alarms

Failure Modes/Cause	Discussion	Supporting Evidence	Refuting Evidence	Actions	Status
		failure. The Unit 4 turbine/generator has had a history of vibration issues which could contribute to loss of the air gap	which would be expected with a hard rub due to loss of air gap. Discrete stator slots remained visible following the event. The sinusoidal shaft was found aligned with air gap between the shaft and spider indicating correct alignment.		
20. Winding Insulation Breakdown / Failure	Breakdown of insulation can lead to turn to turn, phase to phase, or phase to ground fault (and subsequent lockout due to loss of PMG voltage to AVR power supply). Besides accelerated ageing, temperature also affects the insulation in other ways. As the winding heats up or cools	Electrical checks (DLRO and megger readings) per WOs 40731687-04 & 40731687-17 were UNSAT. Stator windings manufactured in 1986. Discussions with TAW reinforced the potential of an age-related failure of the stator windings (like thermal degradation). Removal of the stationary coil revealed severe damage to the windings.	No OEM documents specifying rewind interval.	Visual Inspection of winding. Evaluation of winding characteristics following the failure (burn pattern in windings, core, and connections) DLRO and Megger of windings. Discussed winding failure with TAW for concurrence of	Potential Cause #1

FIP TEAM SUPPORT / REFUTE MATRIX

Support/Refute Matrix – AR 02361794, Generator Exciter Switchgear Control Cabinet Alarms

Failure Modes/Cause	Discussion	Supporting Evidence	Refuting Evidence	Actions	Status
	<p>down, the copper winding expands and contracts more than the iron core in which it is mounted. The expansion and contraction put mechanical stress on the insulation. Cyclic stress can cause separation of the insulation that develops into permanent cracks and voids</p> <p>Turn to turn shorts in a single phase would cause heating in the affected core slots, eventually degrading to a phase to ground fault. A second fault would create a return path, allowing high fault current flow between fault</p>	<p>There are areas showing phase to phase breakdown and failed insulation.</p> <p>Assessment of failed windings revealed indication of a phase to ground failure based on burn pattern around the circumference of the stator core (discrete coil failure locations). TAW found evidence of multiple connection failures in the T30 phase which would support a sudden short circuit event in the PMG due to multiple internal grounds.</p>		<p>potential failure mode.</p> <p>Send failed PMG stator out for additional analysis and forensics testing.</p>	

<u>FIP TEAM SUPPORT / REFUTE MATRIX</u>					
Support/Refute Matrix – AR 02361794, Generator Exciter Switchgear Control Cabinet Alarms					
Failure Modes/Cause	Discussion	Supporting Evidence	Refuting Evidence	Actions	Status
	locations.				
21. Foreign Material	<p>FM may have caused equipment damage or electrical fault.</p> <p>Debris entering the PMG during operation could cause impact damage to stator insulation resulting in the same failure modes described in item 20.</p> <p>Particles such as dirt, dust, soot, etc., create problems in several ways. One way is that small particles can abrade the insulation. Particles that get</p>	<p>Visual inspection of the PMG following disassembly identified heavy copper deposition throughout due to arcing and extensive core damage.</p> <p>Some Shim stock and other material was found loose within the exciter housing and PMG area.</p>	<p>No Foreign Material was identified in the failure debris during initial inspections of the failed PMG stator.</p>	<p>Further inspection with forensic disassembly of the stator windings to look for evidence FM.</p>	<p>Potential Cause #2</p>

<u>FIP TEAM SUPPORT / REFUTE MATRIX</u>					
Support/Refute Matrix – AR 02361794, Generator Exciter Switchgear Control Cabinet Alarms					
Failure Modes/Cause	Discussion	Supporting Evidence	Refuting Evidence	Actions	Status
	between the winding and the core or supports, act like sandpaper grit wearing away more insulation through vibration. Another mode is that the particles attract moisture and form a conductive path.				
22. Voltage Regulator Field Cable ground fault	A ground fault on the voltage regulator field cables may have cause the sustained high current on T-30 phase. (TAW report concludes cause of failure was fault external to PMG)		Megger of field cable from voltage regulator to PMG, with cable isolated from PMG, resulted in SAT readings (in the G Ohm range). This check was performed via FAR #5 per WO 40731687-17.	CHAR and Megger field cables once isolated from the PMG Stator Coil	Open
23. Water Intrusion inside PMG compartment	Moisture within the PMG can compromise insulation withstand leading to failure. An excessive amount of moisture can create	Water was located within the PMG and AC exciter compartments following the event. Volume was indeterminate but PMG and pedestal bolt holes in the frame contained	No direct evidence of water within the PMG itself was found with disassembly. However excessive heating that occurred with the winding failure would have removed any forensic	Perform Visual inspection on PMG once it has been removed. FAR 9 was issued to inspect/repair the	Potential Contributing Cause #1



FIP TEAM SUPPORT / REFUTE MATRIX

Support/Refute Matrix – AR 02361794, Generator Exciter Switchgear Control Cabinet Alarms

Failure Modes/Cause	Discussion	Supporting Evidence	Refuting Evidence	Actions	Status
	grounds during operation. For example, a water leak can thoroughly wet a section of the winding, weakening the insulation, and developing a fault.	standing water confirming some amount of intrusion. The PMG compartment is a highly turbulent environment due to forced air cooling airflow from the pole support fan. This could allow distribution of moisture over the PMG during operation in heavy rain events contributing to degradation of insulation quality.	evidence.	<p>seals associated with the Exciter housing.</p> <p>FAR 10 was issued to inspect/repair the VR Housing.</p> <p>FAR 16 includes steps to inspect/repair conduit seals as necessary.</p>	
24. PMG Internal Component Failure (Other than Winding)	<p>Failure of PMG would result in loss of voltage to PS1/PS2 and subsequently cause a voltage regulator lockout</p> <p>PMG is a simple design, with limited components. Component failures</p>	The inspection of the removed stator does show core damage along with insulation damage.	<p>Internals of the PMG include only a stator core. Based on disassembled inspection, core loss appears to be collateral damage due to winding failure in the core slots.</p> <p>Damage appears limited to the slot areas with no significant evidence of</p>	Perform forensics on PMG once it has been removed.	Refuted

<u>FIP TEAM SUPPORT / REFUTE MATRIX</u>					
Support/Refute Matrix – AR 02361794, Generator Exciter Switchgear Control Cabinet Alarms					
Failure Modes/Cause	Discussion	Supporting Evidence	Refuting Evidence	Actions	Status
	<p>would originate in the stator, stator core, or rotating pole support (magnets).</p> <p>Abrasion of the insulating material results from mechanical wear either from a moving object in contact with the insulation, or from the insulation itself moving against an object. As mentioned, thermal expansion and contraction of the winding causes portions of the winding to move; thus creating the possibility of the insulation wearing against the core and winding supports.</p> <p>Small localized damage</p>		<p>lamination fusing or heating in visible portions of the back iron.</p> <p>The failure characteristics indicate a short circuit / high current event rather than localized hotspots in the core.</p>		



FIP TEAM SUPPORT / REFUTE MATRIX

Support/Refute Matrix – AR 02361794, Generator Exciter Switchgear Control Cabinet Alarms

Failure Modes/Cause	Discussion	Supporting Evidence	Refuting Evidence	Actions	Status
	to the insulation allows interturn or ground leakage current to flow. The leakage current further heats the damaged insulation, causing more damage; thus, causing more leakage current, more heat, and eventually failure.				
25. Lightning Strike	Lightning Strike can cause damage to electrical equipment and subsequently cause a voltage regulator lockout (TAW report concludes cause of failure was fault external to PMG)	Through discussion with a former electrical SME at the station it was identified that there have been multiple motor failures in the past which were likely caused by indirect lightning strikes. All electrical equipment is tied together with different levels of resistance through a station ground, and equipment transients have been seen on	No evidence of lightning strike. It is unlikely that a lightning strike would only affect the PMG and no other more susceptible equipment Inspection did not reveal any lightning strike damage at or near the exciter housing or the voltage regulator housing. No similar damage or evidence of degradation	Perform visual inspection on PMG once it has been removed.	Refuted



FIP TEAM SUPPORT / REFUTE MATRIX

Support/Refute Matrix – AR 02361794, Generator Exciter Switchgear Control Cabinet Alarms

Failure Modes/Cause	Discussion	Supporting Evidence	Refuting Evidence	Actions	Status
		equipment due to lightning events.	<p>identified in the AC exciter stator which would result with a high voltage discharge through the stationary exciter assembly</p> <p>The U4 Exciter PMG stator is an ungrounded wye connected design. As such there is no direct path through the grounding grid to the stator neutral that would facilitate a lightning related failure.</p>		
26. Overcurrent from Voltage Regulator	<p>Over-excitation, excessive field current could damage the PMG field windings and potentially breakdown the insulation leading to a flashover event within the component.</p> <p>(TAW report concludes cause of failure was fault external to PMG)</p>		<p>No indication of breaker overcurrent trip.</p> <p>Assumes back feed from AVR power supply to PMG. Design is PMG powers the AVR PS</p> <p>AVR functionally tested SAT.</p> <p>No fuses blown in power supply circuit that would indicate excessive current</p>	FAR 3 was issued to functionally check the Power Drawer and Field Breaker.	Refuted



FIP TEAM SUPPORT / REFUTE MATRIX

Support/Refute Matrix – AR 02361794, Generator Exciter Switchgear Control Cabinet Alarms

Failure Modes/Cause	Discussion	Supporting Evidence	Refuting Evidence	Actions	Status
27. PMG Stator Core Failure	<p>Core lamination insulation degradation will result in inter-laminar shorts in the core. This produces hot spots in the core iron which degrade the insulation of windings installed in the core slots leading to insulation failure over time and a stator failure.</p> <p>Induced current, if not minimized, will generate heat in the iron, weakening the core and damaging the windings. Damage to the lamination insulation permits excessive current that can overheat both the laminations and windings.</p>	<p>Visual inspection of PMG stator windings found heavy copper and core iron deposition throughout due to arcing and extensive core damage.</p> <p>Inspection of failure debris identified a significant number of individual core lamination tooth tops liberated from the core assembly. These lamination teeth showed no evidence of mechanical damage on the tooth surface due to an interference rub. All of these teeth showed evidence of melting approximately ¼” down their length which would be below the stator wedge. This indicates that heating occurred down in the core slot rather than</p>	<p>Based on disassembled inspection, core loss appears to be collateral damage due to winding failure in the core slots.</p> <p>Damage appears limited to the slot areas with no significant evidence of lamination fusing or heating in visible portions of the back iron.</p> <p>The failure characteristics indicate a short circuit / high current event rather than localized hotspots in the core.</p>	Perform visual inspection during disassembly.	Refuted

<u>FIP TEAM SUPPORT / REFUTE MATRIX</u>					
Support/Refute Matrix – AR 02361794, Generator Exciter Switchgear Control Cabinet Alarms					
Failure Modes/Cause	Discussion	Supporting Evidence	Refuting Evidence	Actions	Status
		the surface as a result of localized core lamination heating.			
28. Vibration	<p>The vibrations of the unit 4 generator have been elevated and a concern since startup from the previous outage.</p> <p>Several forces act on the winding conductors. These include vibration from the exciter and generator, and the magnetic force. In rotating exciters and transformers, the magnetic force on the AC winding is at twice</p>	<p>Following the Unit 4 Exciter Rotor replacement during PT4-31, elevated vibrations have been recorded on bearing #9. The highest vibration measured following rotor replacement was 8.31mils during initial startup. Vibrations settled to 5-7mils during base load operation and have remained in this range until the Generator Lockout event on 7/5/2020.</p>		<p>1. Review of vibration profile from the last outage. Along with as left testing & measurements</p> <p>2. Review of event profile to identify magnitude and timing of the vibration changes as the related to the event.</p> <p>During Startup, Operations monitors vibrations of the Generator</p>	Potential Contributing Cause #2

<u>FIP TEAM SUPPORT / REFUTE MATRIX</u>					
Support/Refute Matrix – AR 02361794, Generator Exciter Switchgear Control Cabinet Alarms					
Failure Modes/Cause	Discussion	Supporting Evidence	Refuting Evidence	Actions	Status
	the synchronous speed. Any looseness in the wedges or winding supports will allow the winding to vibrate at the location of the looseness. This vibration not only creates cyclic stresses in the insulation, but also can allow rubbing and abrasion of the insulation against the core iron or the support.			using System1. Additionally, Siemens will have vibration Engineer monitoring the Generator vibrations remotely.	
29. Assembly Error/Damage	Mechanical impact on the laminations is the most frequent cause of damage. Work performed on exciters and motors, particularly during removal and installation of the rotor, can score or crush the ends of the	There was considerable difficulty in disassembling the exciter coupling. Several bolts could not be removed and had to be cut to enable exciter removal. It is plausible that some galling of these bolts occurred during the 14-month operating cycle due to the as-left	TAW inspection and report did not find any indication of winding damage due to direct contact between the magnets and the stator. The report identifies a potential cause involving short circuit currents damaging the stator windings and the physical damage between the magnets and stator	TAW Inspection	Refuted

<u>FIP TEAM SUPPORT / REFUTE MATRIX</u>					
Support/Refute Matrix – AR 02361794, Generator Exciter Switchgear Control Cabinet Alarms					
Failure Modes/Cause	Discussion	Supporting Evidence	Refuting Evidence	Actions	Status
	<p>laminations together if not carefully done. Abrasive particles and other foreign material striking the ends of the laminations can wear off the insulating film and form a conductive path across laminations.</p>	<p>alignment.</p> <p>Mechanical impact on winding during assembly can damage</p>	<p>coming from debris drag following the failure.</p>		
<p>30. PMG Stator Winding jumper cable ground fault</p>	<p>A ground fault on PMG Stator Winding jumper cables may have cause the sustained high current on T-30 phase.</p> <p>(TAW report concludes cause of failure was fault external to PMG)</p>	<p>Oxidation on stator windings would have degraded the insulation and air gap needed to maintain the integrity of the PMG circuit. The generator lockout which opens the field circuit breaker would have challenged the insulation which was possibly wetted due to the storm at the time of the event.</p>	<p>Megger of field cable (including jumper cable) from voltage regulator to PMG, with cable isolated from PMG Stator Windings, resulted in SAT readings (in the G Ohm range). This check was performed via FAR #5 per WO 40731687-17.</p>	<p>Megger jumper cables once isolated from the PMG Stator Coil and field cable.</p>	Open

<u>FIP TEAM SUPPORT / REFUTE MATRIX</u>					
Support/Refute Matrix – AR 02361794, Generator Exciter Switchgear Control Cabinet Alarms					
Failure Modes/Cause	Discussion	Supporting Evidence	Refuting Evidence	Actions	Status
31. Voltage Regulator local voltmeter ground fault	<p>A ground fault on the voltage regulator voltmeter may have caused the sustained high current on T-30 phase. The voltmeter is connected to T-10 and T-30 phases</p> <p>(TAW report concludes cause of failure was fault external to PMG)</p>		<p>Voltmeter is protected by 6A fuses. It is expected that the fuses would blow on a fault condition. If fault was below 6A, it would not have resulted in the damage observed on the PMG winding connections.</p>	<p>Inspect local voltmeter and voltmeter fuses</p>	Refuted
32. Governor Control Panel potential transformer ground fault.	<p>A ground fault on the Governor Control Panel PTs may have caused the sustained high current on T-30 phase. The PTs are connected to all three phases.</p> <p>(TAW report concludes cause of failure was fault external to PMG)</p>		<p>PTs are protected by 6A fuses. It is expected that the fuses would blow on a fault condition. If fault was below 6A, it would not have resulted in the damage observed on the PMG winding connections.</p>	<p>Inspect Governor Control Panel PTs and PT fuses.</p>	Refuted

<u>FIP TEAM SUPPORT / REFUTE MATRIX</u>					
Support/Refute Matrix – AR 02361794, Generator Exciter Switchgear Control Cabinet Alarms					
Failure Modes/Cause	Discussion	Supporting Evidence	Refuting Evidence	Actions	Status
33. Ground Fault on 24VDC Power Supply Transformers	<p>A ground fault on the 24VDC Power Supply Transformers may have caused the sustained high current on T-30 phase.</p> <p>(TAW report concludes cause of failure was fault external to PMG)</p>		<p>Power Supply Transformers are protected by 6A fuses. Fuses were found intact.</p> <p>FAR #3 tested the both 24VDC Power Supplies with SAT results with no work done on the transformers.</p>	<p>Visual inspection of transformers and fuses. Procedure 0-GME-090.01 Section 4.5.</p>	Refuted
34. Ground Fault on Power Amplifier drawers	<p>A ground fault on the 24VDC Power Supply Transformers may have caused the sustained high current on T-30 phase.</p> <p>(TAW report concludes cause of failure was fault external to PMG)</p>		<p>Power Amplifiers are protected by voltraps and 800A fuses. A sustained overcurrent condition from a ground fault will damage voltraps and blow fuses. Voltraps were powered up during testing under FAR #3 and no issues were identified. 800A fuses were intact. Additionally, power drawers were tested SAT under FAR #3.</p>	<p>Visual inspection of voltraps and 800A fuses</p>	Refuted

FIP TEAM SUPPORT / REFUTE MATRIX

Support/Refute Matrix – AR 02361794, Generator Exciter Switchgear Control Cabinet Alarms

Failure Modes/Cause	Discussion	Supporting Evidence	Refuting Evidence	Actions	Status
35. Ground fault on PMG Stator windings to PMG housing	<p>Ground fault on PMG Stator windings can cause sustained overcurrent condition.</p> <p>(TAW report concludes cause of failure was fault external to PMG)</p>	<p>Oxidation on stator windings would have degraded the insulation and air gap needed to maintain the integrity of the PMG circuit. That level of oxidation looks to have been caused by overheating due to a single-phase ground on the PMG, AVR Power Drawer, Field Circuit Breaker, exciter stator, and interconnecting wires. There isn't a monitoring system at PTN that would give indication of this happening.</p>	<p>No signs of arcing or overheating was found on the Exciter housing that would be indicative of a high current ground.</p>	<p>Inspect PMG housing for signs of arcing or overheating. Perform megger testing of PMG Stator Windings. Perform forensics of PMG.</p>	Refuted



Attachment 6: ROOT CAUSE TEAM’S SUPPORT / REFUTE MATRIX

RCE TEAM SUPPORT / REFUTE MATRIX					
PROBLEM STATEMENT:	On July 5th, 2020 at approximately 2107, during a heavy rainstorm Unit 4 Tripped Automatically from 100% power due to a Generator Lockout.				
Failure Modes/Cause	Discussion	Supporting Evidence	Refuting Evidence	Actions	Status
EQUIPMENT					
1. Generator Ground	A single generator ground alone will not cause a trip given the system is ungrounded. A ground would actuate the 64 and 64X relays which provide interlocks to the ground brush solenoids and cause annunciator E-8/3 to come in.		This does not result in a Generator lockout / Turbine trip. However, the ground detection system is still indicating a ground while not connected to the Rotor. A SAT megger was performed on the Rotor Shaft (106 MΩs) via FAR 5 per WO 40731687-17.	Visually and electrically check the Exciter, Diode Wheel, Slip Rings and Ground Brushes. FAR 5 performed a megger of the rotor shaft with SAT results (106MOhms) FAR 7 was issued to troubleshoot the ground detection circuit. Wires GD4 and GD5 were replaced due to bad insulation. PMT is pending.	Refuted



RCE TEAM SUPPORT / REFUTE MATRIX					
PROBLEM STATEMENT:	On July 5th, 2020 at approximately 2107, during a heavy rainstorm Unit 4 Tripped Automatically from 100% power due to a Generator Lockout.				
Failure Modes/Cause	Discussion	Supporting Evidence	Refuting Evidence	Actions	Status
2. Ground Detection System Field Brushes not making good contact with aux slip rings	Does not cause a trip but caused an annunciator to come in (E-8/3).		This does not result in a Generator lockout / Turbine trip.	Perform a visual inspection & continuity check. Perform a TEST from VR Panel and confirm no brush contact fail alarm. FAR 7 was issued to troubleshoot the ground detection circuit. Wires GD4 and GD5 were replaced due to bad insulation. PMT is pending.	Refuted
3. Ground Detection Instrument Failure	Does not cause a trip but caused an annunciator to come in (E-8/3).		This does not result in a Generator lockout / Turbine trip.	Perform TEST from VR Panel and confirm “no brush contact fail alarm”. Check Ground detector panel lights working with	Refuted



RCE TEAM SUPPORT / REFUTE MATRIX					
PROBLEM STATEMENT:	On July 5th, 2020 at approximately 2107, during a heavy rainstorm Unit 4 Tripped Automatically from 100% power due to a Generator Lockout.				
Failure Modes/Cause	Discussion	Supporting Evidence	Refuting Evidence	Actions	Status
				TEST. FAR 7 was issued to troubleshoot the ground detection circuit. Wires GD4 and GD5 were replaced due to bad insulation. PMT is pending.	
4. Over Excitation	An over excitation condition will cause a generator lockout.		Refuted by lack of receipt of Annunciator E-8/2 Generator Field Forcing/Volt Regulating Limit alarm. Voltage Regulator has Over Excitation Protection modules that would prevent the type of damage that was observed. Additionally, FAR 3 performed 0-GME-090.01 section 4.17 which confirmed the Forcing Alarm Module setpoints were set correctly. This module	None	Refuted

RCE TEAM SUPPORT / REFUTE MATRIX					
PROBLEM STATEMENT:	On July 5th, 2020 at approximately 2107, during a heavy rainstorm Unit 4 Tripped Automatically from 100% power due to a Generator Lockout.				
Failure Modes/Cause	Discussion	Supporting Evidence	Refuting Evidence	Actions	Status
			drives the E-8/2 annunciator.		
5. Generator Voltage Imbalance	Does not cause a trip but caused an annunciator to come in (E-7/6).		Refuted by lack of receipt of Annunciator E-8/5. The 260/A voltage balance relay which drives the E-8/5 annunciator monitors the generator output voltage, not the PMG and Exciter voltage. Damage was isolated to PMG/Exciter equipment.	None	Refuted

RCE TEAM SUPPORT / REFUTE MATRIX					
PROBLEM STATEMENT:	On July 5th, 2020 at approximately 2107, during a heavy rainstorm Unit 4 Tripped Automatically from 100% power due to a Generator Lockout.				
Failure Modes/Cause	Discussion	Supporting Evidence	Refuting Evidence	Actions	Status
6. Loss of Voltage Regulator Sensing Module	Does not cause a trip but caused an annunciator to come in (E-7/6).		This does not result in a Generator lockout / Turbine trip. It would explain the transfer of the voltage regulator from AC to DC control. The PMG provides the source voltage which the failing of would result in the loss of sensing.	Perform Procedure 0-GME-090.01 Section 4.6. Check Regulator PT secondary fuses. Check metering PT secondary fuses. FAR 3 tested the Loss of Sensing Module with SAT results.	Refuted
7. Loss of Voltage Regulator Transducer/s	Does not cause a trip but caused an annunciator to come in (E-7/6).		This does not result in a Generator lockout / Turbine trip. It would explain the transfer of the voltage regulator from AC to DC control. The PMG provides the source voltage which the failing of would result in the loss of XDCRs.	Perform Procedure 0-GME-090.01 Section 4.9. FAR 3 tested the Loss of Transducer Module with SAT results.	Refuted



RCE TEAM SUPPORT / REFUTE MATRIX					
PROBLEM STATEMENT:	On July 5th, 2020 at approximately 2107, during a heavy rainstorm Unit 4 Tripped Automatically from 100% power due to a Generator Lockout.				
Failure Modes/Cause	Discussion	Supporting Evidence	Refuting Evidence	Actions	Status
8. Voltage Regulator Enclosure Fan Failure	Does not cause a trip but caused an annunciator to come in (E-9/3).		This does not result in a Generator lockout / Turbine trip. Temperature was reported to be 68 degrees which would not challenge equipment threshold of 100 degrees F.	None	Refuted
9. Voltage Regulator Enclosure Over Temperature	High temperatures in the VR Enclosure can cause component malfunctions and subsequent generator trip. Annunciator E-9/3 did come in and can be triggered by enclosure overtemperature.		Refuted by Operations investigation. Temperature was reported to be 68 degrees F. Alarm trip point is 100F or greater.	None	Refuted



RCE TEAM SUPPORT / REFUTE MATRIX

RCE TEAM SUPPORT / REFUTE MATRIX					
PROBLEM STATEMENT:	On July 5th, 2020 at approximately 2107, during a heavy rainstorm Unit 4 Tripped Automatically from 100% power due to a Generator Lockout.				
Failure Modes/Cause	Discussion	Supporting Evidence	Refuting Evidence	Actions	Status
10. Voltage Regulator Power Amp Blown Fuses	Does not cause a trip but caused an annunciator to come in (E-9/3).		Fuses checked SAT per WO 40731687-01	Check fuse continuity.	Refuted
11. Loss of Voltage Regulator pulse to firing circuits	Does not cause a trip but caused an annunciator to come in (E-9/3).		This does not result in a Generator lockout / Turbine trip.	Perform Procedure 0-GME-090.01 Section 4.10. FAR 3 tested the Firing Circuit Modules [LRBB] and [LREE] with SAT results.	Refuted



RCE TEAM SUPPORT / REFUTE MATRIX					
PROBLEM STATEMENT:	On July 5th, 2020 at approximately 2107, during a heavy rainstorm Unit 4 Tripped Automatically from 100% power due to a Generator Lockout.				
Failure Modes/Cause	Discussion	Supporting Evidence	Refuting Evidence	Actions	Status
12. Exciter Field Breaker ground fault	<p>A ground fault on Exciter Field Breaker may have caused the sustained high current on T-30 phase.</p> <p>(TAW report concludes cause of failure was fault external to PMG)</p>		Refuted by lack of receipt of Annunciator E-8/5. Breaker was inspected SAT under FAR #3. No signs of damage or overheating.	<p>Rack out and visually inspect field breaker.</p> <p>Perform procedure 0-GME-090.01 Section 4.3</p> <p>FAR 3 tested the Generator Field Breaker FB-4 with SAT results.</p>	Refuted
13. Failure of power supplies PS1 and PS2	<p>Failure of both power supplies would result in voltage regulator lockout, generator lockout and turbine trip. Causes annunciator to come in (E-9/3).</p>		Power supplies were functionally tested SAT during performance of FAR 3. Visual inspections of the supplies did not reveal any damage. Fuses are intact.	<p>Procedure 0-GME-090.01 Section 4.5</p> <p>FAR 3 tested the both 24VDC Power Supplies with SAT results.</p>	Refuted



RCE TEAM SUPPORT / REFUTE MATRIX					
PROBLEM STATEMENT:	On July 5th, 2020 at approximately 2107, during a heavy rainstorm Unit 4 Tripped Automatically from 100% power due to a Generator Lockout.				
Failure Modes/Cause	Discussion	Supporting Evidence	Refuting Evidence	Actions	Status
14. Failure of power supply PS1 and PS2 fuses	Failure of both power supply fuses would result in voltage regulator lockout. Causes annunciator to come in (E-9/3).		Fuses checked SAT per WO 40731687-01	Check Fuse Continuity	Refuted
15. Failure of power supply PS1 and PS2 transformers	Failure of both power supply transformers would result in voltage regulator lockout. Causes annunciator to come in (E-9/3).		Power supplies where functionally tested SAT. Output voltages were as expected.	Procedure 0-GME-090.01 Section 4.5 FAR 3 tested the both 24VDC Power Supplies with SAT results.	Refuted
16. PMG Failure (loss of voltage to PS1 and PS2)	Failure of PMG would result in loss of voltage to PS1/PS2 and subsequent regulator lockout	Evidence of arc flash event and pressure wave in PMG stator. Melted copper beads and dislodged enclosure gasket were found in vicinity of PMG. Acrid smell at north end of generator. Electrical		PMG Visual Inspection. PMG Electrical Checks. FAR 5 performed electrical testing of the PMG. Megger	Direct Cause



RCE TEAM SUPPORT / REFUTE MATRIX					
PROBLEM STATEMENT:	On July 5th, 2020 at approximately 2107, during a heavy rainstorm Unit 4 Tripped Automatically from 100% power due to a Generator Lockout.				
Failure Modes/Cause	Discussion	Supporting Evidence	Refuting Evidence	Actions	Status
		checks (DLRO and megger readings) per WOs 40731687-04 & 40731687-17 were UNSAT as well. Removal of the PMG stator revealed severe winding and core damage. There is also indication of isolated rubbing damage between the magnet and stator which looks like interference with the debris.		results of the PMG were 10KOhms. Note that this is default value for the instrument and no voltage was developed with the test indicating a hard ground within the PMG.	
17. Grid Disturbance	Transient in the grid may have caused regulator lockout.		A review by Operations of the PI data as well as a discussion / review by Transmission (Mike Powers) has determined that there was no grid disturbance during the time of the event.	Review PI data Discuss with Mike Powers	Refuted



RCE TEAM SUPPORT / REFUTE MATRIX					
PROBLEM STATEMENT:	On July 5th, 2020 at approximately 2107, during a heavy rainstorm Unit 4 Tripped Automatically from 100% power due to a Generator Lockout.				
Failure Modes/Cause	Discussion	Supporting Evidence	Refuting Evidence	Actions	Status
18. Roof leak causing water intrusion inside Voltage Regulator housing	Water intrusion into housing / voltage regulator cabinets may have caused lockout. (TAW report concludes cause of failure was fault external to PMG)		Per inspection performed via WO 40731687-01, there was no evidence of water intrusion within any circuits or equipment. There was some superficial water around edges of the room and some small drips.	Visual Inspection FAR 10 repaired/reapplied protective coating on regulator housing. FAR 3 test the Voltage Regulator system with SAT results. No components were found in a failed state.	Refuted
19. PMG Stator Coil to Magnet air gap failure	Loss of PMG air gap would result in a hard rub and severe stator core damage and fault of the PMG stator windings.	Visual inspection of the PMG following removal of the stator revealed some rubbing on the surface of the magnets and stator windings. The rubbing is not in large areas or appear to be indicative of contact between the two, but more likely the	Visual inspection of the disassembled PMG found indications of rubbing. The core rubbing indications appear to be secondary collateral damage; a result of copper and core material slag being dragged through the air gap following the event. No significant	Visual Inspection Air gap was validated SAT via FAR 5 per WO 40731687-17.	Refuted



RCE TEAM SUPPORT / REFUTE MATRIX					
PROBLEM STATEMENT:	On July 5th, 2020 at approximately 2107, during a heavy rainstorm Unit 4 Tripped Automatically from 100% power due to a Generator Lockout.				
Failure Modes/Cause	Discussion	Supporting Evidence	Refuting Evidence	Actions	Status
		rubbing of debris within the PMG following the failure. The Unit 4 turbine/generator has had a history of vibration issues which could contribute to loss of the air gap	smearing of stator core laminations was discovered which would be expected with a hard rub due to loss of air gap. Discrete stator slots remained visible following the event. The sinusoidal shaft was found aligned with air gap between the shaft and spider indicating correct alignment.		
20. Winding Insulation Breakdown / Failure	Breakdown of insulation can lead to turn to turn, phase to phase, or phase to ground fault (and subsequent lockout due to loss of PMG voltage to AVR power supply). Besides accelerated ageing, temperature also affects the	Electrical checks (DLRO and megger readings) per WOs 40731687-04 & 40731687-17 were UNSAT. Stator windings manufactured in 1986. Discussions with TAW reinforced the potential of an age-related failure of the stator windings (like	No OEM documents specifying rewind interval.	Visual Inspection of winding. Evaluation of winding characteristics following the failure (burn pattern in windings, core, and connections) DLRO and Megger of windings.	Significant Contributing Cause #1



RCE TEAM SUPPORT / REFUTE MATRIX					
PROBLEM STATEMENT:	On July 5th, 2020 at approximately 2107, during a heavy rainstorm Unit 4 Tripped Automatically from 100% power due to a Generator Lockout.				
Failure Modes/Cause	Discussion	Supporting Evidence	Refuting Evidence	Actions	Status
	<p>insulation in other ways. As the winding heats up or cools down, the copper winding expands and contracts more than the iron core in which it is mounted. The expansion and contraction put mechanical stress on the insulation. Cyclic stress can cause separation of the insulation that develops into permanent cracks and voids</p> <p>Turn to turn shorts in a single phase would cause heating in the affected core slots, eventually degrading to a phase to ground fault. A second fault</p>	<p>thermal degradation).</p> <p>Removal of the stationary coil revealed severe damage to the windings. There are areas showing phase to phase breakdown and failed insulation.</p> <p>Assessment of failed windings revealed indication of a phase to ground failure based on burn pattern around the circumference of the stator core (discrete coil failure locations). TAW found evidence of multiple connection failures in the T30 phase which would support a sudden short circuit event in the PMG due to multiple internal grounds.</p> <p>EPRI Report discusses age</p>		<p>Discussed winding failure with TAW for concurrence of potential failure mode.</p> <p>Review any additional findings from Siemens during rewind activity.</p>	



RCE TEAM SUPPORT / REFUTE MATRIX					
PROBLEM STATEMENT:	On July 5th, 2020 at approximately 2107, during a heavy rainstorm Unit 4 Tripped Automatically from 100% power due to a Generator Lockout.				
Failure Modes/Cause	Discussion	Supporting Evidence	Refuting Evidence	Actions	Status
	would create a return path, allowing high fault current flow between fault locations.	as one of several factors that contribute to winding insulation degradation. Although age alone does not lead to failure, it does make the insulation more susceptible to other failure factors.			
21. Foreign Material	<p>FM may have caused equipment damage or electrical fault.</p> <p>Debris entering the PMG during operation could cause impact damage to stator insulation resulting in the same failure modes described in item 20.</p> <p>Particles such as dirt, dust, soot, etc., create problems in several ways. One way is that</p>	<p>Visual inspection of the PMG following disassembly identified heavy copper deposition throughout due to arcing and extensive core damage.</p> <p>Some Shim stock and other material was found loose within the exciter housing.</p>	<p>No externally originating Foreign Material (FM) was identified in the failure debris within the PMG pole support or the PMG stator following disassembly with either the FPL inspection on site, or the disassembled inspection at TAW.</p> <p>The disassembled inspection specifically looked for any debris other than native materials. Debris was limited to copper and iron slag from the PMG stator failure, along with some</p>	Further inspection with forensic disassembly of the stator windings to look for evidence FM.	Refuted



RCE TEAM SUPPORT / REFUTE MATRIX					
PROBLEM STATEMENT:	On July 5th, 2020 at approximately 2107, during a heavy rainstorm Unit 4 Tripped Automatically from 100% power due to a Generator Lockout.				
Failure Modes/Cause	Discussion	Supporting Evidence	Refuting Evidence	Actions	Status
	small particles can abrade the insulation. Particles that get between the winding and the core or supports, act like sandpaper grit wearing away more insulation through vibration. Another mode is that the particles attract moisture and form a conductive path.		<p>smaller pieces of burned fabric / strand like material, later determined to be stator coil insulation remnants. Several stator core lamination tooth tops were also mixed in the debris. These lamination teeth illustrated melting approx. 3/8" down their length with the tooth tips fully intact. This indicated heating in the core slot rather than liberation by hard surface contact due to a rub or FME in the stator to magnet air gap.</p> <p>Loose shim-stock had been found within the AC Exciter portion of the exciter housing, but none within the PMG section of the housing which is intended to be isolated by design. Following the failure event,</p>		



RCE TEAM SUPPORT / REFUTE MATRIX					
PROBLEM STATEMENT:	On July 5th, 2020 at approximately 2107, during a heavy rainstorm Unit 4 Tripped Automatically from 100% power due to a Generator Lockout.				
Failure Modes/Cause	Discussion	Supporting Evidence	Refuting Evidence	Actions	Status
			<p>a small portion of the rubber seal between the two compartments was found compromised (~8-inch length sucked inward toward the PMG compartment) leaving a potential path for FM ingress from one compartment to another.</p> <p>While this gap left potential for FM ingress, based on the size of the access path, location and type of FM (shim stock) found in the AC Exciter compartment, and lack of findings in the PMG or PMG compartment, the likelihood of FM as an initiator to the failure event is deemed low and has been refuted. It should also be noted that there was no evidence of an arc flash event (i.e. burn marks,</p>		



RCE TEAM SUPPORT / REFUTE MATRIX					
PROBLEM STATEMENT:	On July 5th, 2020 at approximately 2107, during a heavy rainstorm Unit 4 Tripped Automatically from 100% power due to a Generator Lockout.				
Failure Modes/Cause	Discussion	Supporting Evidence	Refuting Evidence	Actions	Status
			melted metal) on the loose shim stock that was recovered, further refuting the shim as a likely initiator to the event.		
22. Voltage Regulator Field Cable ground fault	A ground fault on the voltage regulator field cables may have cause the sustained high current on T-30 phase. (TAW report concludes cause of failure was fault external to PMG)		Megger of field cable from voltage regulator to PMG, with cable isolated from PMG, resulted in SAT readings (in the G Ohm range) which refutes an external fault event postulated by TAW. This check was performed via FAR #5 per WO 40731687-17.	CHAR and Megger field cables were performed SAT.	Refuted



RCE TEAM SUPPORT / REFUTE MATRIX

PROBLEM STATEMENT:	On July 5th, 2020 at approximately 2107, during a heavy rainstorm Unit 4 Tripped Automatically from 100% power due to a Generator Lockout.				
Failure Modes/Cause	Discussion	Supporting Evidence	Refuting Evidence	Actions	Status
23. Water Intrusion inside PMG compartment	<p>Moisture within the PMG can compromise insulation withstand leading to failure.</p> <p>An excessive amount of moisture can create grounds during operation. For example, a water leak can thoroughly wet a section of the winding, weakening the insulation, and developing a fault.</p> <p>The Exciter Housing is designed to be sealed from outside ambient air. Fresh air is not circulated through the housing. Therefore, the concern with water intrusion is focused on external (rain) or internal</p>	<p>Water was located within the PMG and AC exciter compartments following the event. Volume was indeterminate but PMG and pedestal bolt holes in the frame contained standing water confirming some amount of intrusion. The PMG compartment is a highly turbulent environment due to forced air cooling airflow from the pole support fan. This could allow distribution of moisture over the PMG during operation in heavy rain events contributing to degradation of insulation quality. Also, of importance is the fact that the event occurred during a heavy downpour.</p> <p>During disassembly of the</p>	<p>No direct evidence of water within the PMG itself was found during disassembly. However excessive heating that occurred with the winding failure would have removed any forensic evidence.</p>	<p>Perform Visual inspection on PMG once it has been removed.</p> <p>FAR 9 was issued to inspect/repair the seals associated with the Exciter housing.</p> <p>FAR 10 was issued to inspect/repair the VR Housing.</p> <p>FAR 16 includes steps to inspect/repair conduit seals as necessary.</p>	<p>Significant Contributing Cause #2</p>



RCE TEAM SUPPORT / REFUTE MATRIX					
PROBLEM STATEMENT:	On July 5th, 2020 at approximately 2107, during a heavy rainstorm Unit 4 Tripped Automatically from 100% power due to a Generator Lockout.				
Failure Modes/Cause	Discussion	Supporting Evidence	Refuting Evidence	Actions	Status
	(condensation) undesired moisture.	Exciter housing under WO 40731687-08, the housing door seals, partition seals, and floor gaskets all appeared degraded and were subsequently replaced. The floor seals were found dislodged and sucked inward around the perimeter of the PMG compartment. Also, vertical weather seals described in O-GMM-090.1 and MSP 02-055 were missing. The specific source of water intrusion inside the PMG and Exciter compartments is not known, however, water most likely entered these compartments through the dislodged floor gaskets and missing vertical weather seal. (Ref. Attachment 9)			



RCE TEAM SUPPORT / REFUTE MATRIX					
PROBLEM STATEMENT:	On July 5th, 2020 at approximately 2107, during a heavy rainstorm Unit 4 Tripped Automatically from 100% power due to a Generator Lockout.				
Failure Modes/Cause	Discussion	Supporting Evidence	Refuting Evidence	Actions	Status
24. PMG Internal Component Failure (Other than Winding)	<p>Failure of PMG would result in loss of voltage to PS1/PS2 and subsequently cause a voltage regulator lockout</p> <p>PMG is a simple design, with limited components. Component failures would originate in the stator, stator core, or rotating pole support (magnets).</p> <p>Abrasion of the insulating material results from mechanical wear either from a moving object in contact with the insulation, or from the insulation itself moving against an object. As mentioned,</p>	The inspection of the removed stator does show core damage along with insulation damage.	<p>Internals of the PMG include only a stator core. Based on disassembled inspection, core loss appears to be collateral damage due to winding failure in the core slots.</p> <p>Damage appears limited to the slot areas with no significant evidence of lamination fusing or heating in visible portions of the back iron.</p> <p>The failure characteristics indicate a short circuit / high current event rather than localized hotspots in the core.</p>	Complete pending any discovery from Siemens during rewind.	Refuted



RCE TEAM SUPPORT / REFUTE MATRIX					
PROBLEM STATEMENT:	On July 5th, 2020 at approximately 2107, during a heavy rainstorm Unit 4 Tripped Automatically from 100% power due to a Generator Lockout.				
Failure Modes/Cause	Discussion	Supporting Evidence	Refuting Evidence	Actions	Status
	<p>thermal expansion and contraction of the winding causes portions of the winding to move; thus creating the possibility of the insulation wearing against the core and winding supports.</p> <p>Small localized damage to the insulation allows interturn or ground leakage current to flow. The leakage current further heats the damaged insulation, causing more damage; thus, causing more leakage current, more heat, and eventually failure.</p>				



RCE TEAM SUPPORT / REFUTE MATRIX					
PROBLEM STATEMENT:	On July 5th, 2020 at approximately 2107, during a heavy rainstorm Unit 4 Tripped Automatically from 100% power due to a Generator Lockout.				
Failure Modes/Cause	Discussion	Supporting Evidence	Refuting Evidence	Actions	Status
25. Lightning Strike	Lightning Strike can cause damage to electrical equipment and subsequently cause a voltage regulator lockout (TAW report concludes cause of failure was fault external to PMG)	Through discussion with a former electrical SME at the station it was identified that there have been multiple motor failures in the past which were likely caused by indirect lightning strikes. All electrical equipment is tied together with different levels of resistance through a station ground, and equipment transients have been seen on equipment due to lightning events.	No evidence of lightning strike. It is unlikely that a lightning strike would only affect the PMG and no other more susceptible equipment Inspection did not reveal any lightning strike damage at or near the exciter housing or the voltage regulator housing. No similar damage or evidence of degradation identified in the AC exciter stator which would result with a high voltage discharge through the stationary exciter assembly The U4 Exciter PMG stator is an ungrounded wye connected design. As such there is no direct path through the grounding grid	Perform visual inspection on PMG once it has been removed. Complete.	Refuted



RCE TEAM SUPPORT / REFUTE MATRIX					
PROBLEM STATEMENT:	On July 5th, 2020 at approximately 2107, during a heavy rainstorm Unit 4 Tripped Automatically from 100% power due to a Generator Lockout.				
Failure Modes/Cause	Discussion	Supporting Evidence	Refuting Evidence	Actions	Status
			to the stator neutral that would facilitate a lightning related failure.		
26. Overcurrent from Voltage Regulator	Over-excitation, excessive field current could damage the PMG field windings and potentially breakdown the insulation leading to a flashover event within the component. (TAW report concludes cause of failure was fault external to PMG)		No indication of breaker overcurrent trip. Assumes back feed from AVR power supply to PMG. Design is PMG powers the AVR PS AVR functionally tested SAT. No fuses blown in power supply circuit that would indicate excessive current	FAR 3 was issued to functionally check the Power Drawer and Field Breaker.	Refuted



RCE TEAM SUPPORT / REFUTE MATRIX

PROBLEM STATEMENT:	On July 5th, 2020 at approximately 2107, during a heavy rainstorm Unit 4 Tripped Automatically from 100% power due to a Generator Lockout.				
Failure Modes/Cause	Discussion	Supporting Evidence	Refuting Evidence	Actions	Status
27. PMG Stator Core Failure	<p>Core lamination insulation degradation will result in inter-laminar shorts in the core. This produces hot spots in the core iron which degrade the insulation of windings installed in the core slots leading to insulation failure over time and a stator failure.</p> <p>Induced current, if not minimized, will generate heat in the iron, weakening the core and damaging the windings. Damage to the lamination insulation permits excessive current that can overheat both the laminations and</p>	<p>Visual inspection of PMG stator windings found heavy copper and core iron deposition throughout due to arcing and extensive core damage.</p> <p>Inspection of failure debris identified a significant number of individual core lamination tooth tops liberated from the core assembly. These lamination teeth showed no evidence of mechanical damage on the tooth surface due to an interference rub. All of these teeth showed evidence of melting approximately ¼” down their length which would be below the stator wedge. This indicates that heating occurred down in</p>	<p>Based on disassembled inspection, core loss appears to be collateral damage due to winding failure in the core slots.</p> <p>Damage appears limited to the slot areas with no significant evidence of lamination fusing or heating in visible portions of the back iron.</p> <p>The failure characteristics indicate a short circuit / high current event rather than localized hotspots in the core.</p>	Perform visual inspection during disassembly.	Refuted



RCE TEAM SUPPORT / REFUTE MATRIX					
PROBLEM STATEMENT:	On July 5th, 2020 at approximately 2107, during a heavy rainstorm Unit 4 Tripped Automatically from 100% power due to a Generator Lockout.				
Failure Modes/Cause	Discussion	Supporting Evidence	Refuting Evidence	Actions	Status
	windings.	the core slot rather than the surface as a result of localized core lamination heating.			
28. Vibration	<p>The vibrations of the unit 4 generator have been elevated and a concern since startup from the previous outage.</p> <p>Several forces act on the winding conductors. These include vibration from the exciter and generator, and the magnetic force. In rotating exciters and transformers, the magnetic force on the</p>	<p>Following the Unit 4 Exciter Rotor replacement during PT4-31, elevated vibrations have been recorded on bearing #9. The highest vibration measured following rotor replacement was 8.31mils during initial startup. Vibrations settled to 5-7mils during base load operation and have remained in this range until the Generator Lockout event on 7/5/2020.</p>	<p>This failure mode is conditioned on operating time and severity of the elevated vibration condition such that the material would be over stressed and driven to failure.</p> <p>As the mechanism noted is also age related, it is not a contributor to the failure.</p> <p>The recently noted response of the machine, is at a level requiring investigation and</p>	<p>1. Review of vibration profile from the last outage. Along with as left testing & measurements</p> <p>2. Review of event profile to identify magnitude and timing of the vibration changes as the related to the event.</p> <p>During Startup, Operations monitors vibrations</p>	Refuted



RCE TEAM SUPPORT / REFUTE MATRIX					
PROBLEM STATEMENT:	On July 5th, 2020 at approximately 2107, during a heavy rainstorm Unit 4 Tripped Automatically from 100% power due to a Generator Lockout.				
Failure Modes/Cause	Discussion	Supporting Evidence	Refuting Evidence	Actions	Status
	AC winding is at twice the synchronous speed. Any looseness in the wedges or winding supports will allow the winding to vibrate at the location of the looseness. This vibration not only creates cyclic stresses in the insulation, but also can allow rubbing and abrasion of the insulation against the core iron or the support.		<p>correction at the next opportunity for continued operation, it is not of the level requiring removal from service and is within the scope of design tolerance of the machine. This condition is one that has been developing as the machine ages. The vibration levels over the life of the equipment noted have not historically been abnormal and have been well below the threshold of concern.</p> <p>If operation were to continue with the present condition uncorrected, it may be a contributor to an equipment failure at a later date.</p>	of the Generator using System1. Additionally, Siemens will have vibration Engineer monitoring the Generator vibrations remotely.	



RCE TEAM SUPPORT / REFUTE MATRIX					
PROBLEM STATEMENT:	On July 5th, 2020 at approximately 2107, during a heavy rainstorm Unit 4 Tripped Automatically from 100% power due to a Generator Lockout.				
Failure Modes/Cause	Discussion	Supporting Evidence	Refuting Evidence	Actions	Status
29. Assembly Error/Damage	Mechanical impact on the laminations is the most frequent cause of damage. Work performed on exciters and motors, particularly during removal and installation of the rotor, can score or crush the ends of the laminations together if not carefully done. Abrasive particles and other foreign material striking the ends of the laminations can wear off the insulating film and form a conductive path across laminations.	<p>There was considerable difficulty in disassembling the exciter coupling. Several bolts could not be removed and had to be cut to enable exciter removal. It is plausible that some galling of these bolts occurred during the 14-month operating cycle due to the as-left alignment.</p> <p>Mechanical impact on winding during assembly can damage</p>	TAW inspection and report did not find any indication of winding damage due to direct contact between the magnets and the stator. The report identifies a potential cause involving short circuit currents damaging the stator windings and the physical damage between the magnets and stator coming from debris drag following the failure. Any evidence of assembly damage may have been lost during the fault event.	TAW Inspection	Refuted



RCE TEAM SUPPORT / REFUTE MATRIX					
PROBLEM STATEMENT:	On July 5th, 2020 at approximately 2107, during a heavy rainstorm Unit 4 Tripped Automatically from 100% power due to a Generator Lockout.				
Failure Modes/Cause	Discussion	Supporting Evidence	Refuting Evidence	Actions	Status
30. PMG Stator Winding jumper cable ground fault	A ground fault on PMG Stator Winding jumper cables may have cause the sustained high current on T-30 phase. (TAW report concludes cause of failure was fault external to PMG)	Oxidation on stator windings would have degraded the insulation and air gap needed to maintain the integrity of the PMG circuit. The generator lockout which opens the field circuit breaker would have challenged the insulation which was possibly wetted due to the storm at the time of the event.	Megger of field cable (including jumper cable) from voltage regulator to PMG, with cable isolated from PMG Stator Windings, resulted in SAT readings (in the G Ohm range). This check was performed via FAR #5 per WO 40731687-17.	Megger jumper cables once isolated from the PMG Stator Coil and field cable. Complete.	Refuted
31. Voltage Regulator local voltmeter ground fault	A ground fault on the voltage regulator voltmeter may have caused the sustained high current on T-30 phase. The voltmeter is connected to T-10 and T-30 phases (TAW report concludes cause of failure was fault		Voltmeter is protected by 6A fuses. It is expected that the fuses would blow on a fault condition. If fault was below 6A, it would not have resulted in the damage observed on the PMG winding connections. Local voltmeter functioned satisfactory following startup.	Inspect local voltmeter and voltmeter fuses Needs cleanup	Refuted



RCE TEAM SUPPORT / REFUTE MATRIX					
PROBLEM STATEMENT:	On July 5th, 2020 at approximately 2107, during a heavy rainstorm Unit 4 Tripped Automatically from 100% power due to a Generator Lockout.				
Failure Modes/Cause	Discussion	Supporting Evidence	Refuting Evidence	Actions	Status
	external to PMG)				
32. Governor Control Panel potential transformer ground fault.	<p>A ground fault on the Governor Control Panel PTs may have caused the sustained high current on T-30 phase. The PTs are connected to all three phases.</p> <p>(TAW report concludes cause of failure was fault external to PMG)</p>		PTs are protected by 6A fuses. It is expected that the fuses would blow on a fault condition. If fault was below 6A, it would not have resulted in the damage observed on the PMG winding connections. PTs and PT fuses tested satisfactory during FAR #3.	<p>Inspect Governor Control Panel PTs and PT fuses.</p> <p>Needs cleanup</p>	Refuted



RCE TEAM SUPPORT / REFUTE MATRIX					
PROBLEM STATEMENT:	On July 5th, 2020 at approximately 2107, during a heavy rainstorm Unit 4 Tripped Automatically from 100% power due to a Generator Lockout.				
Failure Modes/Cause	Discussion	Supporting Evidence	Refuting Evidence	Actions	Status
33. Ground Fault on Voltage Regulator 24VDC Power Supply Transformers	A ground fault on the 24VDC Power Supply Transformers may have caused the sustained high current on T-30 phase. (TAW report concludes cause of failure was fault external to PMG)		Power Supply Transformers are protected by 6A fuses. Fuses were found intact. FAR #3 tested the both 24VDC Power Supplies with SAT results with no work done on the transformers.	Visual inspection of transformers and fuses. Procedure 0-GME-090.01 Section 4.5.	Refuted
34. Ground Fault on Voltage Regulator Power Amplifier drawers Clarify they are VR components.	A ground fault on the 24VDC Power Supply Transformers may have caused the sustained high current on T-30 phase. (TAW report concludes cause of failure was fault external to PMG)		Power Amplifiers are protected by voltraps and 800A fuses. A sustained overcurrent condition from a ground fault will damage voltraps and blow fuses. Voltraps were powered up during testing under FAR #3 and no issues were identified. 800A fuses were intact. Additionally, power drawers were tested SAT under FAR #3.	Visual inspection of voltraps and 800A fuses. Complete.	Refuted



RCE TEAM SUPPORT / REFUTE MATRIX					
PROBLEM STATEMENT:	On July 5th, 2020 at approximately 2107, during a heavy rainstorm Unit 4 Tripped Automatically from 100% power due to a Generator Lockout.				
Failure Modes/Cause	Discussion	Supporting Evidence	Refuting Evidence	Actions	Status
35. Ground fault on PMG Stator windings to PMG housing	Ground fault on PMG Stator windings can cause sustained overcurrent condition. (TAW report concludes cause of failure was fault external to PMG)	Oxidation on stator windings would have degraded the insulation and air gap needed to maintain the integrity of the PMG circuit. That level of oxidation looks to have been caused by overheating due to a single-phase ground on the PMG, AVR Power Drawer, Field Circuit Breaker, exciter stator, and interconnecting wires. There isn't a monitoring system at PTN that would give indication of this happening.	No signs of arcing or overheating was found on the Exciter housing that would be indicative of a high current ground.	Inspect PMG housing for signs of arcing or overheating. Perform megger testing of PMG Stator Windings. Perform forensics of PMG. These were completed SAT.	Refuted
PROGRAMMATIC/ORGANIZATIONAL					
36. Timely Exciter Winding PM Implementation Inadequate PM Strategy	Level 1 Assessment AR 2327198 for Fleet Exciter PM/Spare is issued in response to the H.B. Robinson	On 12/4/2019, assignment 07 of the L1A initiates PMC-19-006814 to create new PMs to rewind both stationary and rotating		Pull up due date of new Unit 4 PM to perform at the next refueling outage	Significant Contributing Cause #1



RCE TEAM SUPPORT / REFUTE MATRIX					
PROBLEM STATEMENT:	On July 5th, 2020 at approximately 2107, during a heavy rainstorm Unit 4 Tripped Automatically from 100% power due to a Generator Lockout.				
Failure Modes/Cause	Discussion	Supporting Evidence	Refuting Evidence	Actions	Status
	event. Assessment recommends rewinding of Exciter rotating and stationary windings based on age of components. 5R Exciter overhaul PMs are recommended to include component rewind.	windings. PMC is approved on 2/3/2020. New 15R PMs 45986-58 (3K2) and 50551-60 (4K2) are activated for the rewind activity. These new PMs are given a due date of PT3-32 and PT4-36. These due dates lack pace considering the age of the Exciter windings have already exceeded the industry recommended service life of 30 years.		PT4-32.	
37. PM for Exciter Housing Door Seal inspections is reactionary vs preventive with regards to weather seals	36M Exciter Inspection PM 50551-42 performs an Exciter housing door seals and hardware inspection task. Additionally, as part of their inspections Siemens also inspects for Exciter housing seals and performs	During investigations following the Unit trip, water was observed inside the Exciter Housing. Exciter Door seal and hardware inspection task, as well as Siemens Exciter Testing reports, do not include explicit instructions to replace all weather seals of Exciter		Revise PM 50551-42 to require replacement of all Exciter housing door seals. Consider creating a new standalone 18M PM task for door seal replacements.	Potential Contributor



RCE TEAM SUPPORT / REFUTE MATRIX					
PROBLEM STATEMENT:	On July 5th, 2020 at approximately 2107, during a heavy rainstorm Unit 4 Tripped Automatically from 100% power due to a Generator Lockout.				
Failure Modes/Cause	Discussion	Supporting Evidence	Refuting Evidence	Actions	Status
	replacements only when degradation is found.	housing regardless of condition. This can allow degradation within the 36M frequency that can allow water intrusion during heavy rain.			
38. Lack of Ground Detection System on PMG Stator Windings	The current ground detection system on the Unit 4 Generator and Exciter components does not include PMG Stator Winding ground detection. This system may have notified Operations of a potential issue and allowed for a response before failure.	PMG Stator windings do not have a ground detection system installed. If one were installed, a ground condition can result in Control Room alarm and Operator actions to find the source and eliminate.	Although a ground detection system on the PMG stator can alert the Control Room of a single ground condition and provide time for troubleshooting, it would not have allowed enough time to respond to the multiple ground fault event that occurred over a short duration (approximately 166 minutes between initial ground alarm and subsequent failure).	None	Refuted
39. Limitations of Vibration Monitoring equipment.	The current Vibration Monitoring equipment provides relative vibration vs absolute.	Current Vibration is monitored with proximitors (relative vibration transducers)	This failure mode is conditioned on operating time and severity of the elevated vibration condition	Survey perform ODS testing of the existing generator & exciter structure	Refuted



RCE TEAM SUPPORT / REFUTE MATRIX					
PROBLEM STATEMENT:	On July 5th, 2020 at approximately 2107, during a heavy rainstorm Unit 4 Tripped Automatically from 100% power due to a Generator Lockout.				
Failure Modes/Cause	Discussion	Supporting Evidence	Refuting Evidence	Actions	Status
	This may mask an undesirable vibration condition	<p>measuring the vibration response difference of its mounting position (casing or bearing structure) and the target (rotating element or shaft). In its use the assumption is the structure is stiff and provides minimal input to the vibration signal. If the structure is weak and has a significant amount of vibration the value provided may not be a true value.</p> <p>The actual level of casing response is unknown as it is not measured, and the actual shaft vibration is not known because it is masked by the input of the structural vibration.</p> <p>Shims located under the exciter skid were found</p>	<p>such that the material would be over stressed and driven to failure.</p> <p>As the mechanism noted is also age related, it is not a contributor to the failure.</p> <p>The recently noted response of the machine, is at a level requiring investigation and correction at the next opportunity for continued operation, it is not of the level requiring removal from service and is within the scope of design tolerance of the machine. This condition is one that has been developing as the machine ages. The vibration levels over the life of the equipment noted have not</p>	<p>and absolute shaft vibration.</p> <p>Inspect generator foundation bolting for proper clearance.</p>	



RCE TEAM SUPPORT / REFUTE MATRIX					
PROBLEM STATEMENT:	On July 5th, 2020 at approximately 2107, during a heavy rainstorm Unit 4 Tripped Automatically from 100% power due to a Generator Lockout.				
Failure Modes/Cause	Discussion	Supporting Evidence	Refuting Evidence	Actions	Status
		<p>displaced/missing. For a shim to migrate out of its location requires differential movement between the contacting structures, in this case exciter base plate and skid.</p> <p>The level of vibration response on the exciter appears somewhat excessive for a vibration issue on the generator.</p> <p>Unit #3 Vibration response investigation (AR-02293836 & subsequent Siemens/FPL Vibration RCA Team Report) indicated potential age-related issues affecting structural response of the machine that needed investigation. These same issues, due to similarities</p>	<p>historically been abnormal and have been well below the threshold of concern.</p> <p>If operation were to continue with the present condition uncorrected, it may be a contributor to an equipment failure at a later date.</p>		



RCE TEAM SUPPORT / REFUTE MATRIX					
PROBLEM STATEMENT:	On July 5th, 2020 at approximately 2107, during a heavy rainstorm Unit 4 Tripped Automatically from 100% power due to a Generator Lockout.				
Failure Modes/Cause	Discussion	Supporting Evidence	Refuting Evidence	Actions	Status
		in design, age and environment may be evident on Unit #4.			
40. Weakness in Annunciator Response Procedures	ARP's may not provide sufficient guidance to Operators following ground alarms on the Unit 4 Generator Exciter to prevent failure from occurring.	<p>Alarm response procedure guidance for E8/4 Generator Ground is to validate alarm (by reset and going to test) and to check for TPCW leaks. Actions for valid alarms are notify Electrical and consider shutting down unit.</p> <p>Generically, the E panel alarm guidance is to notify Electrical and Transmission System Operator, or System Dispatch.</p> <p>Off normal procedure ONOP-090, Abnormal Generator MW/MVAR Oscillation, contains</p>	<p>System design is ungrounded. Operation may continue with one ground. A second ground would cause a short and result in transient / trip.</p> <p>Alarm response and Off-normal procedure philosophy is to validate alarm prior to taking action. This validation typically includes Electrical and Engineering support. Management notifications would be performed prior to a removing unit from service.</p> <p>There were approximately two hours between alarm and unit trip. This is not a</p>	None.	Refuted –



RCE TEAM SUPPORT / REFUTE MATRIX					
PROBLEM STATEMENT:	On July 5th, 2020 at approximately 2107, during a heavy rainstorm Unit 4 Tripped Automatically from 100% power due to a Generator Lockout.				
Failure Modes/Cause	Discussion	Supporting Evidence	Refuting Evidence	Actions	Status
		guidance to notify groups (Electrical, System Dispatch, System Protection, System Engineer/Component Specialist) and response by manipulating voltage regulators and power system stabilizer. Guidance does not provide hard criteria to remove unit from service.	reasonable amount of time to allow for offsite personnel to validate alarm and for management notifications to occur. In addition, removing unit from service for a valid ground does not eliminate the ground and would likely result in exciter/PMG repair/replacement.		
41. Corrective Actions Lack Priority	Corrective Actions to repair exciter door seals, address bearing #9 vibrations, and LTAM PTN-18-002 To replace voltage regulators are not addressed in a timely manner.	As an example: Multiple water intrusion events associated with the exciter housing along with past extent of cause events failed to provide sufficient remedies in prevention space regarding water ingress to a sensitive environment.		Investigate past WO designated priorities and extensions on water ingress issues.	Potential Contributor



RCE TEAM SUPPORT / REFUTE MATRIX					
PROBLEM STATEMENT:	On July 5th, 2020 at approximately 2107, during a heavy rainstorm Unit 4 Tripped Automatically from 100% power due to a Generator Lockout.				
Failure Modes/Cause	Discussion	Supporting Evidence	Refuting Evidence	Actions	Status
42. The current organizational structure at the site level, has not ensured assigned oversight has received the knowledge, training or expertise to monitor, track and develop actions to address cumulative stressors that can affect the Turbine Generator	A lack of knowledge of the Turbine / Generator/ Exciter systems may have prevented personnel from fully understanding the collateral impacts of system stressors	<p>PMG Stator failure occurred in a rainstorm and some signs of water intrusion were noted in the PMG portion of the Exciter House following the failure.</p> <p>The U4 Turbine Generator experienced elevated vibration during the previous operating cycle</p> <p>The U4 PMG Stator has been in service for approximately 34 years without a rewind. Maintenance philosophy was to inspect, test, and maintain</p>	<p>There is no evidence that the failure of the PMG stator winding was due to or affected by ineffective oversight or lack of technical assessment of aggregate stressors. Three potential stressors have been noted as potential contributors to the failure.</p> <p>Vibration: While vibration levels at the #9 bearing adjacent to the PMG were elevated during the prior operating cycle, they remained well within OEM specified limits. Vertical displacement values reached a short-term peak of ~7 mils with a max allowable peak of 14 mils. Vibration levels at the stationary PMG stator housing are not a monitored parameter, however</p>		Refuted



RCE TEAM SUPPORT / REFUTE MATRIX					
PROBLEM STATEMENT:	On July 5th, 2020 at approximately 2107, during a heavy rainstorm Unit 4 Tripped Automatically from 100% power due to a Generator Lockout.				
Failure Modes/Cause	Discussion	Supporting Evidence	Refuting Evidence	Actions	Status
			<p>periodic walkdowns of the Exciter housing over the operating cycle did not identify any significant physical vibration of note at the PMG housing compartment or surrounding deck. While vibration is known to be a long-term mechanical stressor to motor / generator winding insulation (cyclic stress), the recorded levels do not support this as a significant degradation mechanism to U4 PMG life that would require specialized actions to mitigate.</p> <p>Moisture: The U4 Exciter housing was last removed during the Spring 2019 outage. Exciter base seals were inspected for serviceability prior to re-</p>		



RCE TEAM SUPPORT / REFUTE MATRIX					
PROBLEM STATEMENT:	On July 5th, 2020 at approximately 2107, during a heavy rainstorm Unit 4 Tripped Automatically from 100% power due to a Generator Lockout.				
Failure Modes/Cause	Discussion	Supporting Evidence	Refuting Evidence	Actions	Status
			installation. There was no known indication of a leak in the PMG compartment when the unit was returned to service. During operation these base seals cannot be inspected, leaving potential for unnoted migration during an operating cycle. Following the U4 PMG failure, some migration of base seals at the corners of the PMG section of the exciter house was noted. This migration would allow moisture ingress along the floor as the PMG section of the housing operates at a high negative pressure. While moisture is a known stressor to electrical insulation, the inability to monitor for ingress online prevents a condition assessment by site or fleet		



RCE TEAM SUPPORT / REFUTE MATRIX					
PROBLEM STATEMENT:	On July 5th, 2020 at approximately 2107, during a heavy rainstorm Unit 4 Tripped Automatically from 100% power due to a Generator Lockout.				
Failure Modes/Cause	Discussion	Supporting Evidence	Refuting Evidence	Actions	Status
			personnel other than with outage inspections. Age: Aging is a known degradation mechanism. To address this, the site has historically adhered a maintenance strategy of routine inspections and electrical testing at 18-month intervals, with disassembled inspections at 7.5 years. Siemens / Westinghouse does not specify rewind intervals for Permanent Magnet Generators. According to OEM Generator Engineering, PMG stator rewind has only been done for cause, failing an electrical test, or reaching a condition that was deemed unacceptable for continued operation. Note that all inspection reports for 18		



RCE TEAM SUPPORT / REFUTE MATRIX					
PROBLEM STATEMENT:	On July 5th, 2020 at approximately 2107, during a heavy rainstorm Unit 4 Tripped Automatically from 100% power due to a Generator Lockout.				
Failure Modes/Cause	Discussion	Supporting Evidence	Refuting Evidence	Actions	Status
			<p>months and 7.5-year inspections found no degradation and were dispositioned as SAT by both OEM and site personnel for return to service. Based on test and inspection performed approximately 15 months prior to the failure, no condition concern had been noted and left unaddressed.</p> <p>Without positive confirmation of the presence of cumulative stressors prior to the PMG failure and a failure to appropriately assess or mitigate, a postulated lack of technical rigor or oversight is unsupported.</p>		
43. Insufficient vibration analysis performed on Unit 4 #9 bearing	Ongoing communication through the operating	The Fleet Team was requested to monitor the start up from this forced	This failure mode is conditioned on operating time and severity of the	None.	Refuted



RCE TEAM SUPPORT / REFUTE MATRIX					
PROBLEM STATEMENT:	On July 5th, 2020 at approximately 2107, during a heavy rainstorm Unit 4 Tripped Automatically from 100% power due to a Generator Lockout.				
Failure Modes/Cause	Discussion	Supporting Evidence	Refuting Evidence	Actions	Status
vibration response	<p>period with site personnel indicated that the exciter had an imbalance issue. The Fleet Team was requested to provide input through the period on specific vibration anomalies on the specific responses. The responses were noted to be driven by the generator response and imbalance was called out not to be the issue.</p>	<p>outage. During the event high vibration was evident on the exciter. Analysis of the response indicated the presence of an H2 Seal Rub initiating around 1700 RPM, the exciter was noted to respond to the change in phase angle of the balance vector which occurs because of a rub on the rotating assembly. While the exact cause of correction is known, the rub condition appears to have been reduced or dissipated at this time.</p> <p>Based on the above and the communication that this response was similar to the 4-31 start up, this was also reviewed. Reviewing the data indicated a similar condition on start up</p>	<p>elevated vibration condition such that the material would be over stressed and driven to failure.</p> <p>As the mechanism noted is also age related, it is not a contributor to the failure.</p> <p>The recently noted response of the machine, is at a level requiring investigation and correction at the next opportunity for continued operation, it is not of the level requiring removal from service and is within the scope of design tolerance of the machine. This condition is one that has been developing as the machine ages. The vibration levels over the life of the</p>		



RCE TEAM SUPPORT / REFUTE MATRIX					
PROBLEM STATEMENT:	On July 5th, 2020 at approximately 2107, during a heavy rainstorm Unit 4 Tripped Automatically from 100% power due to a Generator Lockout.				
Failure Modes/Cause	Discussion	Supporting Evidence	Refuting Evidence	Actions	Status
		where the seal rub was initiated during roll up, the effect continued through the subsequent run. (The rub was sustained during the subsequent run period.) Review of previous startups also indicated a similar condition on startups to varying degrees.	equipment noted have not historically been abnormal and have been well below the threshold of concern. If operation were to continue with the present condition uncorrected, it may be a contributor to an equipment failure at a later date.		
44. Nuclear Structure inhibits timely resolution of system issues.	The lack of site expertise for subject single point vulnerable host component lends itself to concerns on creating and defending work order priorities, both short term and long term scheduled issues. Representing concerns	Based on search findings to date within this RCE, substantive evidence has shown numerous water intrusion events on the exciter housing. Additionally, discerning the probable root cause being the age of the failed PMG stator windings combined with additional		Re-visit the Change Management Plan on resource allocations regarding nuclear systems personnel, work controls, and outage planners.	Potential Contributor



RCE TEAM SUPPORT / REFUTE MATRIX					
PROBLEM STATEMENT:	On July 5th, 2020 at approximately 2107, during a heavy rainstorm Unit 4 Tripped Automatically from 100% power due to a Generator Lockout.				
Failure Modes/Cause	Discussion	Supporting Evidence	Refuting Evidence	Actions	Status
	and priorities within Plant Health Sub-Committees is critical in allocating the necessary resources to ensure the SSCs are maintained properly and within the ER standards afforded for the critical equipment.	stressors including water intrusion into the housing, favors the nuclear structure in having dedicated expertise in the site owned and managed turbine, generator and exciter model, a model that is not to be treated as a generic model to all nuclear/fossil fleet owners.			

Attachment 7: Barrier Analysis chart



RCE AR 2361794: Unit 4 Exciter Failure			
Root Cause: A weak PM program philosophy had resulted from a failure to fully assess risk of equipment age making the PMG stator more susceptible to failure when exposed to water/moisture.			
Barriers to Prevent Condition	Discussion of Evidence/Facts	Conclusion: 1. Barrier Missing 2. Weak Barrier 3. Barrier Failed 4. No Failed Barrier 5. Barrier not used	Why was the barrier missing, weak, failed, or not used?
Work Management process change	Removal of Site Turbine / Generator/ Exciter representative via the CMP allowed for reduced focus/timeliness of required actions and commitments to maintain the subject single point vulnerable equipment to the degree needed for optimal availability.	4. No Failed Barrier	There was no explicit requirement from either the vendor or industry OE to perform an Exciter rewind. Proper focus and timeliness from either a site representative (prior organization) or fleet turbine/generator team (current organization) would still not have resulted in a rewind PM.



RCE AR 2361794: Unit 4 Exciter Failure

Root Cause: A weak PM program philosophy had resulted from a failure to fully assess risk of equipment age making the PMG stator more susceptible to failure when exposed to water/moisture.

Barriers to Prevent Condition	Discussion of Evidence/Facts	Conclusion: 1. Barrier Missing 2. Weak Barrier 3. Barrier Failed 4. No Failed Barrier 5. Barrier not used	Why was the barrier missing, weak, failed, or not used?
Conduct of Engineering (EN-AA-104)	A review of EN-AA-104 (Conduct of Engineering) has identified that the responsibility and ownership of Turbine components was shifted to the EOOS engineering group in 2015, an off-site group. There is no specific individual within the PTN system engineering group that is assigned as the Turbine system Engineer, they are now identified as a support group for EOOS. The failed components have not been replaced per vendor / mfg.'s recommendations and are currently experiencing age related failures.	4. No Failed Barrier	There was no explicit requirement from either the vendor or industry OE to perform an Exciter rewind. Had component ownership remained with a site representative (prior organization) it would still not have resulted in a rewind PM.



RCE AR 2361794: Unit 4 Exciter Failure

Root Cause: A weak PM program philosophy had resulted from a failure to fully assess risk of equipment age making the PMG stator more susceptible to failure when exposed to water/moisture.

Barriers to Prevent Condition	Discussion of Evidence/Facts	Conclusion: 1. Barrier Missing 2. Weak Barrier 3. Barrier Failed 4. No Failed Barrier 5. Barrier not used	Why was the barrier missing, weak, failed, or not used?
Project Oversight	<p>OEM procedures provide the technical instruction and criteria for performance of exciter maintenance. These procedures are proprietary but subject to customer review and approval prior to execution.</p> <p>A potential gap exists in that the scope of work performed by the OEM is not all inclusive. Multiple entities are involved with varying scope of responsibilities leaving potential for missed scope upon conclusion of Exciter maintenance projects. Examples: OEM performs mechanical work and electrical testing, site or contractor performs electrical de-terminations / re-terminations, site or contractor performs coatings.</p>	3. Barrier Failed	Aggregate Exciter Maintenance project scope may not have the appropriate level of review to ensure continuity between work groups.



RCE AR 2361794: Unit 4 Exciter Failure

Root Cause: A weak PM program philosophy had resulted from a failure to fully assess risk of equipment age making the PMG stator more susceptible to failure when exposed to water/moisture.

Barriers to Prevent Condition	Discussion of Evidence/Facts	Conclusion: 1. Barrier Missing 2. Weak Barrier 3. Barrier Failed 4. No Failed Barrier 5. Barrier not used	Why was the barrier missing, weak, failed, or not used?
Siemens Work Process	1. Standard for measuring and determining health and suitability of continued operability of seals. 2. Is work process inclusive of circle slash steps to ensure all steps are completed and every seal inspected and measured for suitability. 3. Is work reviewed by others? 4. Is there accountability in Siemens following their procedures? How does the equipment go through several 2 cycle cycles of OK/replace then go through several cycles in a row with seals being acceptable? 5. Are Siemens procedures required to	3. Barrier Failed	1) FPL has historically used Siemens to evaluate and recommend life expectancy of Turbine components and the frequency at which they are inspected, refurbished or replaced. This has been a weakness in the past in FPL’s organizational ownership of our Turbine generators. 2) Siemens work management process is commensurate to the FPL process utilizing step by step instruction and place-keeping methods such as “circling and slashing” each step. Retention and review of Siemens documentation can be reviewed by FPL oversight during task performance but becomes vague after the fact due to their work documents being proprietary in nature and not included in the shell work orders GFPL provides them. 3) Siemens work documents are reviewed and approved by the FPL Turbine supervisor before being included in their field packages. Siemens work steps also include the level of oversight needed to verify and validate critical steps. 4) Yes, Siemens requires verbatim compliance to their



RCE AR 2361794: Unit 4 Exciter Failure			
Root Cause: A weak PM program philosophy had resulted from a failure to fully assess risk of equipment age making the PMG stator more susceptible to failure when exposed to water/moisture.			
Barriers to Prevent Condition	Discussion of Evidence/Facts	Conclusion: 1. Barrier Missing 2. Weak Barrier 3. Barrier Failed 4. No Failed Barrier 5. Barrier not used	Why was the barrier missing, weak, failed, or not used?
	<p>be reviewed and approved by FPL? What is done if there is ever a revised procedure? Are the procedures up to date with learned information?</p> <p>6. Do existing procedures provide enough information to allow for revision for improvement?</p>		<p>work orders. Station personnel currently lacks the knowledge or expertise for challenging the frequency and technical justification for some of their decisions.</p> <p>5) Yes, Siemens work documents are reviewed by the FPL Turbine supervisor. Procedure revisions are not reviewed and/or checked to ensure latest technical learnings have been incorporated into their procedures. FPL has an over-reliance on the vendor for their technical knowledge of the Turbine and associated components.</p> <p>6) Existing Siemens procedures need to be reviewed by the most technically knowledgeable individual within the FPL EOOS organization to ensure all industry knowledge and improvement opportunities have been captured and incorporated into their procedures.</p>
Station Procedures	Site Exciter Maintenance procedures provide the technical instruction and criteria for performance of exciter	2. Weak Barrier	Significance of site OE underestimated during the procedure revision process allowing critical activities to be dispositioned as discretionary.



RCE AR 2361794: Unit 4 Exciter Failure			
Root Cause: A weak PM program philosophy had resulted from a failure to fully assess risk of equipment age making the PMG stator more susceptible to failure when exposed to water/moisture.			
Barriers to Prevent Condition	Discussion of Evidence/Facts	Conclusion: 1. Barrier Missing 2. Weak Barrier 3. Barrier Failed 4. No Failed Barrier 5. Barrier not used	Why was the barrier missing, weak, failed, or not used?
	<p>maintenance. It has been identified that previous procedure updates may not have sufficiently captured site OE when outlining specific work steps.</p> <p>In addition, site procedures are not used by all entities performing aggregate work scope leaving potential for non-performance of site-specific maintenance requirements.</p> <p>1. Standard for measuring and determining acceptability of previous</p>		<p>Vendors allowed to work to their own procedures rather than site procedures. Pertinent site-specific OE may not be incorporated into their work plans.</p> <p>The current work management process has FPL develop a “Shell” work order task for all Siemens tasks for them to use. Siemens then expands the description of the work order task by inserting the Siemens work standard (example). Perform work per Siemens 3.2.2.6 work standard.) The Siemens specific work document (Siemens 3.2.2.6) is then reviewed by an FPL Supervisor to ensure critical steps and appropriate hold points and/or adequate inspection & verification signoffs are included. If the document does not meet the FPL standards, then the document is rejected, and Siemens revises the work documents to include the revisions requested by FPL oversight.</p> <p>Because Siemens does not attach the actual work document to the work task in EWP during the package closure process, it is difficult to go back and verify or</p>



RCE AR 2361794: Unit 4 Exciter Failure			
Root Cause: A weak PM program philosophy had resulted from a failure to fully assess risk of equipment age making the PMG stator more susceptible to failure when exposed to water/moisture.			
Barriers to Prevent Condition	Discussion of Evidence/Facts	Conclusion: 1. Barrier Missing 2. Weak Barrier 3. Barrier Failed 4. No Failed Barrier 5. Barrier not used	Why was the barrier missing, weak, failed, or not used?
	<p>results</p> <p>2. Is work process inclusive of circle slash steps to ensure all steps are completed with information regarding what results are appropriate.</p> <p>3. Is work reviewed by others?</p> <p>4. Is there accountability to follow procedure?</p> <p>5. Are procedures required to be reviewed and approved? What is done if there is ever a revised procedure? Are the procedures up to date with learned information?</p> <p>6. Do existing procedures provide enough information to allow for revision</p>		<p>validate specific details of the work that was done. Siemens does download the Journeymen's work report into EWP which are most times very detailed.</p>



RCE AR 2361794: Unit 4 Exciter Failure			
Root Cause: A weak PM program philosophy had resulted from a failure to fully assess risk of equipment age making the PMG stator more susceptible to failure when exposed to water/moisture.			
Barriers to Prevent Condition	Discussion of Evidence/Facts	Conclusion: 1. Barrier Missing 2. Weak Barrier 3. Barrier Failed 4. No Failed Barrier 5. Barrier not used	Why was the barrier missing, weak, failed, or not used?
	for improvement? 7. Is there an accountability supply information on the WO.		
Seal EC process	1. What was the initial request vs. final product. 2. Is there an issue real or perceived hindering voluntary submission vs. required submission of a process or providing recommendations vs. requirements? 3. Was the issue fully understood or supplied to the EC performer. 4. Was the requester part of the approval process?	2. Weak Barrier	EC 241744 (MSP 02-055) issuance with the recommended change to the 0-GMM-090.1 'Exciter Removal, Inspection and Installation', the only site procedure associated with the exciter overhaul that provided instructions to remove and install the housing, should have mandated that new sealant shall always be applied the housing is removed. There should not be any discretionary decision from craft or planners whether sealant should be applied. Additionally, Sealant degrades with time, and will degrade at an accelerated rate with conditions at PTN. This provides greater basis for a mandated sealant application during standard housing removal intervals and for-cause removals.



RCE AR 2361794: Unit 4 Exciter Failure			
Root Cause: A weak PM program philosophy had resulted from a failure to fully assess risk of equipment age making the PMG stator more susceptible to failure when exposed to water/moisture.			
Barriers to Prevent Condition	Discussion of Evidence/Facts	Conclusion: 1. Barrier Missing 2. Weak Barrier 3. Barrier Failed 4. No Failed Barrier 5. Barrier not used	Why was the barrier missing, weak, failed, or not used?
PM to rewind exciter & PMG based on age	<p>EPRI and other industry documents provide a 10 to 30 year service life for Exciter and PMG windings. They do not explicitly require rewind activities.</p> <p>Winding gets prematurely aged and becomes more susceptible to other failure factors such as vibration, humidity, temperature and water intrusion. As the insulation ages, chemical changes make insulation dry, and brittle. Varnish and epoxy used for binding gets weakened with age.</p>	2. Weak Barrier	<p>No PM for exciter and PMG rewind prior to 2019. Siemens as OEM does not recommend rewind of exciter and PMG based on age.</p> <p>Funding has not been set aside for replacement of critical components, such as TG exciter components, that are currently at or past normal life-expectancy. Funding allocation requires LTAM approval and success hinges on competition with all other plant funding priorities.</p>
No trend indication for humidity in exciter and PMG housing	Not presently able to obtain condition inside doghouse for humidity and water considering history and outdoor unit with South Florida harsh environment.	1. Barrier Missing	Westinghouse brushless exciter design does not include trend monitoring of humidity. Voltage regulator housing has humidity meter for operator log measurement.



RCE AR 2361794: Unit 4 Exciter Failure

Root Cause: A weak PM program philosophy had resulted from a failure to fully assess risk of equipment age making the PMG stator more susceptible to failure when exposed to water/moisture.

Barriers to Prevent Condition	Discussion of Evidence/Facts	Conclusion: 1. Barrier Missing 2. Weak Barrier 3. Barrier Failed 4. No Failed Barrier 5. Barrier not used	Why was the barrier missing, weak, failed, or not used?
No exciter field and PMG ground alarm	Ground monitoring provides early indication for failures of winding if due to slow ground fault. However, ground monitoring will not help to prevent catastrophic failures. No awareness of the potential initial ground on PMG winding in days, week or month prior to trip event. Second ground results are likely the catastrophic event.	1. Barrier Missing	WTA-300 voltage regulator at PTN do not have exciter field ground monitoring installed. Only Generator field ground monitoring system at Turkey Point. Latter version of WTA-300B at Point Beach has two modules in design. One for Generator field ground and second for exciter field ground which includes PMG stator winding.
Sealing of exciter housing with exciter base to prevent water in negative pressure PMG area, especially during heavy rain condition.	Lack of direction in 0-GMM-090.01 ' <i>Exciter Removal, Inspection and Installation</i> '. Siemens procedure v/s plant procedure for doghouse sealing. Sealing history. Sealing material and process etc.	2. Weak Barrier	As proven via the inspection of Unit 3 exciter housing during this root cause investigation, the sealant was not applied at the suspect interface location.



Attachment 8: Timeline

DATE	TIME	DESCRIPTION
1986	-	PMG Stator is manufactured by Siemens/Westinghouse
12/3/1998		<p>EPRI developed a document on “Preventive Maintenance and Overhaul Experience for Rotating Brushless Exciters and other Exciter Systems”. In this document under the section on Moisture it states “The presence of contaminated water, condensation, or any type of moisture can also cause failure of diode wheel components. Electrical “tracking”, as described earlier, can occur with moisture in the same way as it does with dirt or fly ash. Moisture can also lower the insulation resistance of the diode wheel components and the windings.</p> <p>Outdoor generating units in high humidity areas are prone to having moisture form in the exciter house through condensation on the cooling coils. Condensation was so much of a problem at Florida Power & Lights (FPL) Martin, Manatee and Sanford stations that the cooling water would often be shut off when the units cycled off at night.</p> <p>Moisture can also be a problem on outdoor units, if the seal between the exciter house and the sole plate is not adequate. One of the units in southern Florida was found to be sucking water off the turbine deck and into the exciter house in the area of the PMG. The problem was found when the rotor ground detector indicated a problem. The unit was shut down and the exciter house was swabbed and then vacuumed. The base was temporarily sealed with a bead of RTV. A more permanent fix was enacted during the next refueling outage. Better seals and their correct installation solve the problem.</p> <p>Of course, cooler leaks, inside the exciter housing, can also be a source of moisture. Cooler leaks should be repaired immediately.</p> <p>Both issues mentioned in this section of the “Utility Generator Predictive Maintenance conference report” (internal and external water intrusion) have reoccurred at PTN subsequent to this report dated 12/3/1998. These issues are documented in the OE section of this RCE.</p>
9/29/2001	-	PTN U3 Water Intrusion caused a forced power reduction due to severe weather and continuous heavy rains. A large pressure differential was created in the Exciter housing by the oversized blower, sucking water into the housing and blowing water on to exciter electrical components throughout the enclosure This was caused by a failure of gaskets and removal of pipe plugs which produced a leak path from the external environmental conditions to the internal exciter components.
10/27/2001 10/31/2001		Work order (WO 31019895-01) was written on 10/27/2001 to Repair U3 Exciter housing gaskets. The work order was taken to ready status



		on 10/31/2001. Subsequently the repairs stated in the work order were not performed and the work order was placed back into the library.
6/17/2002		Subsequent water intrusion inside U3 exciter housing prompted engineering to issue an MSP 02-055 to provide direction on sealing the Exciter housing.
7/10/2002		WO 31019895-01 was taken to approved status and was awaiting implementation.
2/27/2004		On 2/27/2004 the work order (WO 31019895-01) was finally taken to working status and the repairs were made. The work was completed.
12/28/2004	-	Ten months later, a Manual reactor scram on U3 had to be initiated due to water intrusion inside the Turbine Exciter housing. The cause was due to improper gasket material and improper assembly of Exciter cooler by a vendor resulting in a (~90 gpm) leak on the TPCW piping inside the housing.
4/18/2005	-	Siemens performs Generator Inspection under Job No. 0NIT05000022. As part of this activity the Exciter housing was inspected and found in satisfactory condition. The zone and door seals were in satisfactory condition. PMG meggers at 26.37MOhms, winding resistances are below 0.0062 Ohms.
10/15/2006	-	Siemens performs Generator and Exciter inspections per Siemens Job No. 0NIT07001A52. The Exciter housing doors were found with excessively worn hardware. The door sealing rubber was found deteriorated. The door sealing rubber was replaced with new rubber. No Electrical testing of the PMG was performed as part of this activity.
4/6/02008	-	Siemens performs Exciter testing on the Unit 4 Exciter as part of the 1R PMRQ 50551-42 (FPL WO not found). The Exciter housing was inspected and found in satisfactory condition. No deficiencies observed on weather seals. PMG meggers at 48.7MOhms, winding resistances are below 0.0059 Ohms.
12/10/2008		0-GMM-090.1 was revised to include attachment 5 providing a drawing on how to properly seal the Exciter housing using in inner foam gasket to prevent water intrusion.
11/4/2009	-	Siemens performs Exciter testing on the Unit 4 Exciter as part of the 1R PMRQ 50551-42 (WO 39008715). The gasket on the Exciter housing top cover was replaced and weather sealed. The exciter PMG end rubber seal was found partially out of position and was replaced. The exciter was inspected to verify that no rubber from this or any other debris was present on any cooling passages or in the diode wheels. The inter-zone seals were replaced with new seal material. The affected inter-zone seals were removed and replaced with new seal material and Loctite 290 was applied to the bolting threads prior to torquing. The entire seal on the right-side exciter end door was replaced with new seal material. The seal on the latch side of the right-side turbine end door was also replaced. As part of the door seal replacements, the doors were adjusted to ensure proper sealing. PMG meggers at 6MOhms, winding resistances are below 0.0059 Ohms.



1/7/2010		NAMS shows 0-GMM-090.1 first revision was done on 1/7/2010. Page 69 of the procedure at that time showed section 6.23.8, an FPL Supervisor/Engineer verification step, existed prior to this time due to the date of page 69 being 8/9/2007. It also shows page 77, attachment 5 having an approval date of the page as 12/10/08.
3/25/2011	-	Siemens performs Exciter testing on the Unit 4 Exciter as part of the 1R PMRQ 50551-42 (WO 40015985). No deficiencies observed on weather seals. PMG meggers at 52.1MOhms, winding resistances are below 0.0059 Ohms.
1/6/2013	-	Siemens Field Services performs Generator Stator Rewind under Siemens Job No. 0NIT12004403. As part of this work, Electrical tests are performed on the PMG, AC stator and armature. PMG meggers at 9.62GMOhms, winding resistances are below 0.0062 Ohms.
9/29/2014	-	Siemens performs Exciter testing on the Unit 4 Exciter as part of the 1R PMRQ 50551-42 (WO 40213082). No deficiencies observed on weather seals. PMG meggers at 10MOhms, winding resistances are below 0.0059 Ohms. No task was found where the Exciter housing was removed, reinstalled and base sealing was inspected or performed.
4/2/2016	-	Siemens performs Exciter testing on the Unit 4 Exciter as part of the 1R PMRQ 50551-42 (WO 40370429). No deficiencies observed on weather seals. PMG meggers at 1.18GOhms, winding resistances are below 0.0059 Ohms. No task was found where the Exciter housing was removed, reinstalled and base sealing was inspected or performed.
10/10/2017	-	Siemens performs Exciter testing on the Unit 4 Exciter as part of the 1R PMRQ 50551-42 (WO 40497050). The top of the Exciter housing was found with opening that could allow for leaks above the diode wheel. Report states repairs are expected to be performed by FPL. PMG meggers at 1MOhms, winding resistances are below 0.0059 Ohms.
10/25/2017	-	WO 40497050-02 performs inspection of the U4 Exciter Door Seals and hardware. All seals were found in good condition. This work did not require the housing to be removed. Sealing of the base was not inspected or performed.
3/21/2019	-	Refurbished Exciter Rotor is installed on Unit 4 as part of 5R PMRQ 50551-39 (WO 40642780).
3/21/2019	-	Siemens performs Exciter testing on the Unit 4 Exciter as part of the 5R PMRQ 50551-56 (WO 40642780). The Exciter housing was inspected for signs of damage and wear. Seals were inspected for hardness and fit. Several teardrop seals were found hard and torn. Windows and doors were inspected for cracks and signs of degradation and found to be in satisfactory condition. The end wall coupling air seal was found with large clearances. Degraded seals were replaced. PMG electrical tests results are satisfactory. PMG meggers at 232 M/Ohms, winding resistances measure below 0.0059 Ohms. Siemens concluded equipment was acceptable for return to service.
3/21/2019		PT4-31 RFO Activities: 1. PMG Stator (removed from base, inspected, insulation resistance



		<p>measured)</p> <p>2. AC Exciter Stator (disassembled, horizontally split for rotor removal and inspected, insulation resistance, pole balance and impedance calc. of field winding and resistance measured)</p> <p>3. AC Exciter Armature (Including Diode Wheels and PMG Pole Support, insulation resistance w/rotor install-diode wheels to shaft and to diode wheel, replacement of complete rotating element with a spare (complete rotor overhaul at Siemens) PMG pole support w/magnets, AC Armature, diode wheels)).</p>
8/11/2019	0840	H.B. Robinson Nuclear Plant (RNP) Unit 2 experiences an automatic trip caused by a failure of the Generator Exciter Armature. The Root Cause Evaluation concluded the precise cause of failure is indeterminate. However, the failure was most likely attributed to a latent failure of the exciter armature due to either coil or core failure.
9/9/2019	-	Level 1 Assessment AR 2327198 for Fleet Exciter PM/Spare is issued in response to the H.B. Robinson event. The Level 1 Assessment identifies Exciter windings (both stationary and rotating) at PTN have not been rewound since installation. Assessment recommends rewinding of Exciter rotating and stationary windings based on age of components. 5R Exciter overhaul PMs are recommended to include component rewind.
12/4/2019	-	PMC-19-006814 is initiated to create new 15R PMs to rewind both stationary and rotating Exciter windings.
2/3/2020	-	PMC-19-006814 is approved by supervision. PMC recommends the start date of new PMs align with the next scheduled 5R overhaul activities (PT3-32 and PT4-36). An action is assigned to PM coordinators to create new PMRQs for the Exciter rewind activities.
3/14/2020	-	New PMRQs 45986-58 (3K2) and 50551-60 (4K2) are activated with a 15R frequency and initial due dates of PT3-32 and PT4-36 to align with 5R overhaul activities.
Prior to Event Date		<p>Various supplemental sealants historically used on Units 3 & 4 exciter housing to prevent water intrusion</p> <ul style="list-style-type: none"> • Dowsil 732 • 3M 5200 Marine sealant • Duromar SAR-UW • Closed-Cell Foam (Last-A-Foam Model FRL 3704 or FRL 6704 by General Plastics Mfg. Co. or Equiv.) or Dymeric Caulk (or Equiv.) <p>However, no supplemental sealant was found during the post event inspection.</p>
7/5/2020	Various	Significant amount of lightning and storms with very heavy rain occurring during the afternoon. Several components alarmed for



		trouble or ground or tripped.
7/5/2020	1844	Received AN-E-8/3: GEN CONTACT FIELD BRUSH CONTACT FAIL/GROUND.
7/5/2020	1850	Turbine Operator reports no observed water inside the Exciter housing.
7/5/2020	1900	<p>Per 4-ARP-097.CR.E, the Turbine Operator depresses the RESET pushbutton above the generator field breaker and the following occurs:</p> <ul style="list-style-type: none"> • AN-E-8/3 momentarily resets then re-alarms. • AN-E-9/3 GEN VOLT REG LOSS OF BACKUP alarms • AN-E-7/6 GEN VOLT REG TRANSFER TO MANUAL alarms <p>AN-E-9/3 cleared as soon as it was acknowledged. AN-E-8/3 and AN-E-7/6 remain locked in.</p>
7/5/2020	1901	The light indication at the Voltage Regulator switch on the Control Room console shows the red ON light off and the green OFF light on; indicating that the voltage regulator has swapped from AC regulator to the DC regulator.
7/5/2020	1930	During management call, Shift Manager reported water observed in the Voltage Regulator housing and herculite installed above housing. Shift Manager also reported that housing temperature was 68 deg F. Subject Matter Expert Hiten Patel stated to validate no alarms on local Voltage Regulator panel before swapping console switch from "On" to "Test"
7/5/2020	1940	Operations notifies System Dispatch of U4 AC Voltage Regulator automatic transfer to MANUAL (DC voltage regulator manual adjust). System dispatcher understands status of U4 AVR and generator voltage controls.
7/5/2020	2045	Operations reports one alarm on local Voltage Regulator panel: "Loss of XDCCR No. 1"
7/5/2020	2050	Received annunciators AN-E-9/3 GEN VOLT REG LOSS OF BACKUP and AN-E-8/6 GEN VOLT REG TROUBLE several times. Reactive load on the Unit 4 Generator has moved up suddenly from 115 MVAR to 200 MVAR in the last 5-minutes.
7/5/2020	2100	Operations reports Exciter field volts are oscillating.
7/5/2020	2107	<p>Unit 4 Reactor Trip caused by Turbine Trip (First Out). Investigated generator exciter switchgear control cabinet and found the following alarms:</p> <ul style="list-style-type: none"> Power Supply #1 Power Supply #2 Firing Circuit #2 Loss of XDCCR #1
7/8/2020		On 7/8/2020 the following was documented in the Siemens JWR attached to WO 40731687-08 (FAR 4,9,5 Remove / Install Exciter



		housing): Performed visual inspection of Exciter housing door seals, partition seals and floor seals. All require replacement due to normal wear and environmental degradation. All doors need minor adjustments. Floor seals need to be replaced. All window seals appear to be in adequate condition. Partition seals need to be replaced.
7/18/2020		On 7/18/2020 the following was documented in the Siemens JWR attached to WO 40731687-08 (FAR 4,9,5 Remove / Install Exciter housing): Rigged and installed Exciter housing and torqued bolting. It was verified through the work order that the team used scotch grip 1300 rubber cement to attach the rubber strips between the Exciter housing and the mating surfaces. It was also verified that new 2" x 10' pieces were issued to the team to support replacement of the degraded rubber seals identified on 7/8/2020 entry above.
7/19/2020		MM was tasked with sealing the Exciter housing on U4. MM did this as skill of the craft. Discussions with the journeyman who performed the task verified that they sealed all removable hatches on top of the housing and the hold down bolts. The WR did not direct them to seal the lower sections where the housing sits on the rubber gaskets as shown in 0-GMM-090.1 Attachment 5.
7/29/2020 7/31/2020		BHI was asked to seal the U4 Exciter housing to the turbine deck. A work order was written on 7/29/2020 (WO 40731687-52) and the crew went to the field and sealed the area that was found to be sucking air. Discussions with the Site Coatings supervisor verified that on Friday 7/31/2020 the BHI team was directed to seal the entire bottom of the Exciter housing. The crew used a backing material and 5200 Marine caulking to seal the housing. One area of concern is that the work order does not reference 0-GMM-090.1 section 6.23.8 FPL Supervisor / Engineer verification step or direct the workers to use 0-GMM-090.1 Attachment 5 as a reference.
7/31/2020		On 7/31/2020 MM was tasked with sealing the Exciter housing on Unit 3. The crew worked to a minor work request (WR 94212618) which only stated "U3 Exciter doghouse bottom edge needs sealing". Again, the work documents did not capture the requirements shown in 0-GMM-090.1 relating to the proper way to seal the Exciter housing or the type of material to use. The team used clear RTV caulking. MM found that the U3 Turbine Exciter had not been sealed per 0-GMM-090.1 instructions. The team applied DOWSIL 732 multi-purpose sealant around the base of the housing to prevent water intrusion.
8/3/2020		Verified that damaged PMG stator was received at Siemens Charlotte facility on Friday 7/31/2020. No preliminary inspection results are available at his time.
8/3/2020		A follow-up with Siemens planning revealed that the Siemens work documents only have them inspect and replace degraded seals and then land and torque the housing down. It does not have them seal the



		housing as outlined in the FPL procedure (0-GMM-090.1).
--	--	---



Attachment 9: Potential Paths of Water Ingress

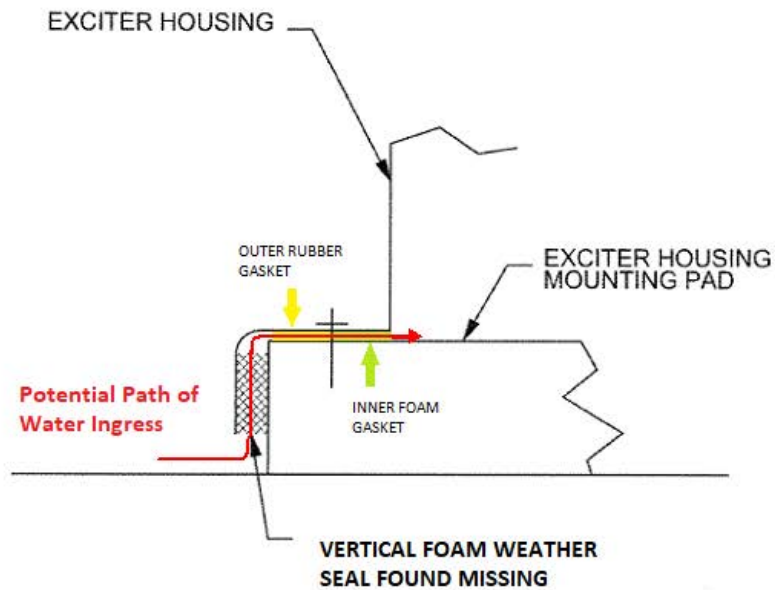
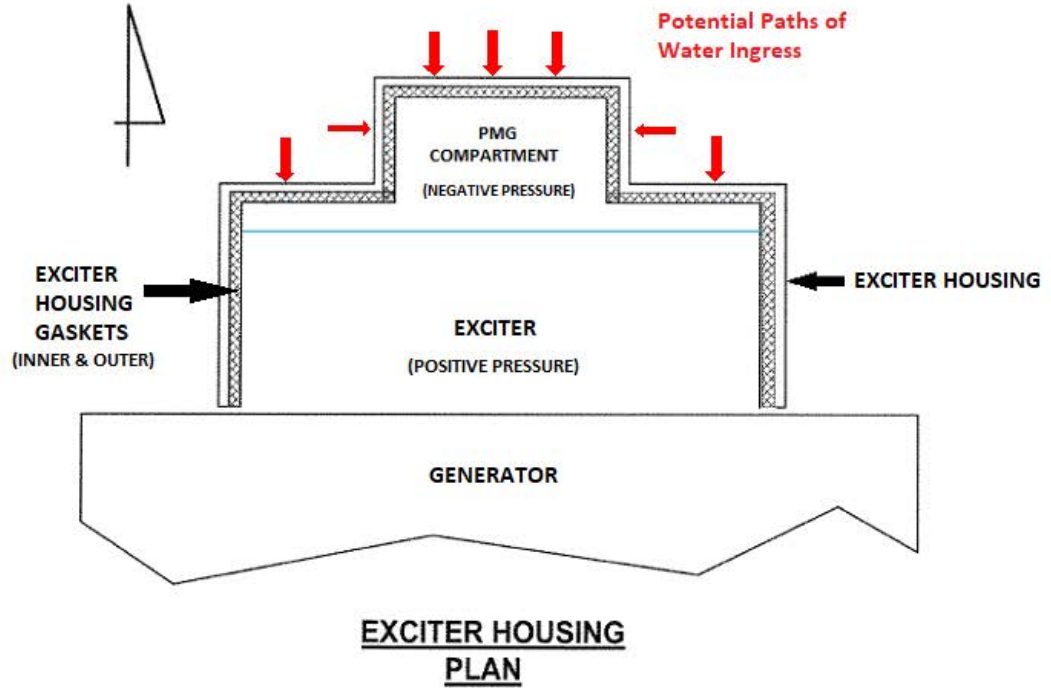

**Florida Power & Light Company
Docket No. 20220001-EI
Staff's 2nd Set of Interrogatories
Interrogatory No. 4
Page 1 of 1**

QUESTION:

The following questions are with respect to Florida Power & Light's (FPL or Company) Petition for Approval of Fuel Cost Recovery and Capacity Cost Recovery Net Final True-Ups for the Period Ending December 2021 and 2021 Asset Optimization Incentive Mechanism Results (Petition).

Please refer to the Direct Testimony of FPL witness Dean Curtland for the following question. Please provide the replacement power costs, if any, associated with the: July 2020 outage of Turkey Point Unit No. 4; November 2020 outage of Turkey Point Unit No. 3; January 2021 outage of St. Lucie Unit No. 2; March 2021 outage of Turkey Point Unit No. 3; May 2021 outage of St. Lucie Unit No. 1; and the August 2021 outage of Turkey Point Unit No. 3. Please also show how any replacement power cost amounts were calculated.

RESPONSE:

The replacement power cost for July 2020 outage of Turkey Point Unit No. 4 was \$1,453,970; November 2020 outage of Turkey Point Unit No. 3 was \$1,290,604; January 2021 outage of St. Lucie Unit No. 2 was \$1,180,450; March 2021 outage of Turkey Point Unit No. 3 was \$1,206,743; May 2021 outage of St. Lucie Unit No. 1 was \$1,517,511; August 2021 outage of Turkey Point Unit No. 3 was \$2,766,857. The calculations are provided in Attachment No. I to this Interrogatory. FPL applies the proportion of fuel used during the same period for each fuel type, as summarized on Schedule A3, to the amount of outage time, in hours, experienced. Fixed natural gas costs are removed from the calculation since those expenses have already been incurred.



**Turkey Point
 Root Cause Evaluation
 Unit 3 Trip During Restoration from RPS Testing
 Event Date: March 1, 2021 CR 2385529
 Revision 1**

Root Cause Team	Name	Dept/Group
Management Sponsor	Bob Tomonto	Engineering
Team Leader/RC Evaluator	Bob Murrell	Licensing
Team Member	Luis Mazo	Maintenance
Team Member	Richard Jackson	Operations
Team Member	Robert Rodriguez	Training
Team Member	Orlando Carol	Engineering

Root Cause Evaluator: Bob Murrell / *BGMurrell* Date: 2/20/21
 Print/Sign

Management Sponsor: Bob Tomonto / *Robert J. Tomonto* Date: 2/28/21
 Print/Sign

MRC Chair: *BGMurrell for Cashwell* Date: 2/29/21
 Print/Sign *per taken*

Electronic Signature may be obtained by assigning actions in NAMS.

Refer to PI-AA-104-1000 for details.

The root cause process is designed to be self critical to drive improvement. As such, specific organizational and/or programmatic causes within the plant's span of control are identified. The root cause process determines a functional cause and not a legal or contractual cause.



Unit 3 Reactor Trip During Restoration from RPS Testing
Root Cause Evaluation
Turkey Point

1.0 Problem Statement:2
2.0 Executive Summary:2
3.0 Event Details, Analysis, and Presentation of Findings:.....4
4.0 Extent of Condition11
5.0 Analysis of Risk and Safety Consequences11
6.0 Barrier Analysis12
7.0 Event and Causal Factor (E&CF) Analysis.....13
8.0 Organizational and Programmatic (O&P) Analysis13
9.0 Training Performance Analysis.....13
10.0 Operating Experience (OE) Review14
11.0 Safety Culture (SC) Analysis15
13.0 Extent of Cause (EOCa).....15
14.0 Corrective Actions.....16
15.0 Effectiveness Review22
16.0 CRs Generated During the Common Cause Evaluation23
17.0 Proof Statement and Lessons Learned.....23
Attachments:23
Attachment 1: Root Cause Evaluation Team Charter24
Attachment 2: Extent of Condition Evaluation.....25
Attachment 3: Extent of Cause Evaluation.....27
Attachment 4: Operating Experience Analysis30
Attachment 5: Support Refute Matrix35
Attachment 6: Barrier Analysis.....55
Attachment 7: Event and Causal Factor (E&CF) Analysis60
Attachment 8: Organizational and Programmatic (O&P) Analysis61
Attachment 9: Safety Culture (SC) Analysis.....63
Attachment 10: Corrective Action Line of Sight (LOS) Table65
Attachment 11: List of Documents Reviewed68
Attachment 12: Industry Maintenance Practices on Cell Switches69



1.0 Problem Statement:

On March 1, 2021 at 1112, Unit 3 experienced an unplanned automatic reactor trip during restoration of the 3B Reactor Protection System Logic Test, 3-SMI-049.02B (AR 2385529, WR 94220021). During performance of the SMI, the 3B Reactor Trip Bypass Breaker (BYB) is closed. As part of the restoration, the 3B Reactor Trip Breaker (RTB) breaker (Stamp 12) is closed and the BYB is locally tripped. When the BYB was tripped open, Unit 3 experienced an automatic reactor trip.

2.0 Executive Summary:

As a result of the unit trip, a Failure Investigation Process (FIP) team was established to conduct a post trip review prior to restarting the unit. The FIP team was not able to identify that cause of the trip but did identify several potential causes that this RCE evaluated in order to determine the root and contributing cause(s).

After completion of troubleshooting and replacement of the 3B Reactor Trip Breaker (RTB), Unit 3 was restarted.

Root/Contributing Causes:

RC1 - IAW 0-PME-049.01, steps for cleaning and lubricating cell switch contacts is conditional based, rather than prescriptive.

CC1 - Test points to detect failed contacts were not installed.

CC2 - Failure to follow WEC MPM cell switch maintenance and replacement frequency.

Corrective Actions:

Corrective Actions to Prevent Occurrence

CAPR1 - Revise procedure 0-PME-049.01 to require cleaning and lubrication of cell switch contacts.

Corrective Actions for Contributing Causes

CC1CA1 - Implement modification for Unit 4 to detect for standing trip signal from failed breaker cubicle cell switch contact. Scope modification into PT4-33 or the first available opportunity.

CC2CA1 - Replace cell switches in remaining Reactor Trip and Reactor Trip Bypass Breaker cubicles during upcoming refueling outages.

1. WR for Remaining Unit 3 Reactor Trip and Trip Bypass Breaker cubicles
2. Scope work into upcoming PT3-32 outage or the first available opportunity
3. WR for Unit 4 Reactor Trip and Trip Bypass Breaker cubicles



4. Scope work into upcoming PT4-33 outage or the first available opportunity

CC2CA2 – Create new PMID for Reactor Trip and Trip Bypass Breaker Cell Switch replacements and establish frequency commensurate with 100 cycle service life.

Corrective Actions for Extent of Cause (EOCa)

RC1 EOca CA1 - Review maintenance procedures for Reactor Trip Breaker switchgear cubicles inspections for other conditional steps, which if not performed, can result in equipment failure. Revise procedures as necessary.

RC1 EOca CA2 - Review maintenance procedures for CRDM MG set output breaker and Generator Field breaker cubicles inspections and ensure cleaning of cell switch contacts (if installed) is prescriptive. Revise procedures as necessary.

RC1 EOca CA3 - Review maintenance procedures for Generator Field breaker cubicles inspections and ensure cleaning of cell switch contacts (if installed) is prescriptive. Revise procedures as necessary.

RC1 EOca CA4 - Review maintenance procedures for CRDM MG set output breaker and Generator Field breaker cubicles inspections for other conditional steps, which if not performed, can result in equipment failure. Revise procedures as necessary.

Corrective Actions for Extent of Condition (EOC)

RC1 EOC CA1 - Review Westinghouse Maintenance Program Manual (MPM) and ensure all components used in Reactor Trip Switchgear have a maintenance strategy established commensurate with the MPM.

RC1 EOC CA2 - Review Westinghouse Maintenance Program Manual (MPM) and ensure all components used for CRDM MG set output breaker and Generator Field applications have a maintenance strategy established commensurate with the MPM.

RC1 EOC CA3 - Review Westinghouse Maintenance Program Manual (MPM) and ensure all components used for the Generator Field applications have a maintenance strategy established commensurate with the MPM.

CC1 EOC CA1 - Investigate whether a similar vulnerability exists for CRDM MG set output breaker and Generator Field breaker control circuits. Initiate ECs to install test points if necessary.

CC2 EOC CA1 - Create new PMID for CRDM MG set output breaker and Generator Field breaker cubicle cell switch replacements as necessary.

Other Corrective Actions

Other CA - Revise Reactor Protection System Surveillance Test Interval for Tech Spec Table 4.3-1, Functional Units Items 19, 20, 21 to 18 months.



3.0 Event Details, Analysis, and Presentation of Findings:

Investigation Scope and Methodology:

Perform a Root Cause Evaluation in accordance with PI-AA-100-1005. Analysis methodologies should include Barrier Analysis, Organizational and Programmatic Affects, Safety Culture Analysis, and Event and Causal Factors Charting.

Event Description/Problem Statement

Problem Statement

On March 1, 2021, at 1112, PTN Unit 3 automatically tripped during restoration from Reactor Protection System Testing 3-SMI-049.02B. The reactor trip was caused by an unknown failure of the 3B reactor trip breaker.

Event Description

The following is the timeline leading up to the event on March 1, 2021 (all actions occurred on day shift, times added where time stamps existed):

- Performed brief in the Control Room with Ops Supervision and I&C IAW OD-CO-044
- 10:13, entered T.S. Table 3.3.1 Action 8 for RPS Testing on B Train IAW 3-SMI-049.2B
- Closed in Reactor Trip Bypass Breaker B IAW 3-SMI-049.2B, Section 4.1.
- Performed Section 4 of 3-SIM-049.02B, Train B RPS Logic Test Above P-8
- Locally Verified Reactor Trip Breaker B properly RACKED IN by opening the cubicle door IAW steps 5.1.1.a and 5.1.1.b
- Reactor Operator CLOSES Reactor Trip Breaker B by holding Reactor Trip Reset pushbutton on the console for at least 3 seconds IAW step 5.1.1.d
- Check Reactor Trip Breaker 3B properly RACKED IN IAW 5.1.1.d
- Close Reactor Trip Breaker 3B cubicle door IAW 5.1.1.g
- Reactor Operator verifies that no reactor trip relays are tripped using DCS RPS SOE IAW 5.2
- 2 additional Reactor operators verify that BOTH Reactor Trip Breakers 3A and 3B are closed on the console and VPB
- Reactor Operator gives permission to perform steps 5.1.3-5.1.6
- Locally Verified Reactor Trip Breaker B RACKED IN and CLOSED IAW 5.1.3
- Locally Verified Reactor Trip Breaker A RACKED IN and CLOSED IAW 5.1.4
- Swapped protective cover from Reactor Trip Bypass Breaker 3B and placed over Reactor Trip Breaker B IAW 5.1.5
- Opened Reactor Trip Bypass Breaker 3B locally using mechanical trip pushbutton IAW 5.1.6
- 11:12:30.717 Turbine trip HDR Press 2/3
- 11:12:30.769 Reactor Trip breaker 'A' Opens



- 11:12:30.772 Reactor Trip Breaker ‘B’ Opens

The post trip Failure Investigation Process (FIP) team investigation was not able to identify the cause of the trip with complete certainty. A review of the sequence of events (SOE) identified that the turbine trip signal came in before the reactor trip signal. In review of the associated logic drawings, the two likely breaker parameters that would result in a turbine trip are the auxiliary contact from the RTB breaker, and the RTB cell switch (TOC) associated with the relay 94/ASB. For the 3B RTB, both the breaker and the cell switch have been replaced.

Cause Analysis

RTB Maintenance History

The Turkey Point RTBs and BYBs are DB-50 breakers originally supplied from Westinghouse Electric Corporation (WEC).

As part of the FIP investigation, Maintenance and Engineering reviewed the Unit 3 and 4 Reactor trip breaker maintenance strategy, testing, and history. A summary of work order review and PM strategy for Turkey Point reactor trip breakers was developed in Table 1 showing maintenance frequency requirement for these breakers. Table 2 shows last performed dates of each PM.

In addition to the frequencies, the scope of each PM was reviewed to ensure that PTN work orders covered the recommendations established by Westinghouse maintenance program manual for the DB breakers. The Site procedure that covers maintenance aspects is 0-PME-049.01, Reactor trip and trip bypass breaker inspection and maintenance. Overall the maintenance strategy is based on cycles. The reactor trip breakers cycle more often than the bypass breakers hence the importance for breaker overhaul frequency.

Table 1: Frequencies

Maintenance type	OEM/EPRI frequency	Site frequency
Breaker Test/inspection	200 operations or 18 months	18 months
Breaker Overhaul	8 – 12 yrs. (4,000 operations)	8 yrs. plus grace
Cubicle inspection	5 yrs.	18-month

Table 2: Current PM status

Component	Last performed Test/inspection	Last Breaker Overhaul	Last Cubicle inspection



3A Reactor trip breaker	4/2020	3/2011	4/2020
3A Reactor trip bypass breaker	4/2020	2005	4/2020
3B Reactor trip breaker	4/2020	4/2012	4/2020
3B Reactor trip bypass breaker	4/2020	2019	4/2020
4A Reactor trip breaker	10/2020	10/2017	10/2020
4A Reactor trip bypass breaker	10/2020	9/2020	10/2020
4B Reactor trip breaker	10/2020	9/2020	10/2020
4B Reactor trip bypass breaker	10/2020	9/2020	10/2020

Maintenance and engineering representatives on the FIP team reviewed work scope against the maintenance scheduled recommendations and concluded the following:

Both Unit 3 RTBs have been overhauled by WEC in their required 8 to 12 years periodicity. Current time since their last full overhaul is 8 years for 3B and 9 years for 3A. The 18-month inspection is performed through our procedures with EM resources. The scope of the 18-month PM matches the vendor recommendations for checks at an 18-month frequency. Based on WEC reports they do incorporate their WCAPs into the overhaul and parts replacements.

As part of the RCE investigation,

Actions Taken by FIP Team

The following table lists the Work Orders (WOs) and Field Action Request (FARs) completed as part of the initial investigation.

WO40766915-01 FAR 1	The purpose of this work order task was to monitor contact change of state on the RTB B breaker installed in cubicle.
WO40766915-02 FAR 2	The purpose of this work order task was to perform RTB and BYB RTB cubicle inspections. This task was performed as per procedure 0-PME-049.01 Section 4.25. Cubicles were inspected for cracking, overheating and paths which could track to ground. As per journeymen report, no issues were noted.
WO40766915-03 FAR 3 (FAR 5&6 were performed	The purpose of this work order task was to inspect the removed RTB. Inspection was performed per 0-PME-049.01. As per journeymen report, no issues were noted, auxiliary switch contacts were found to meet their acceptance criteria.



during this inspection.)	
WO40766915-04 FAR 4	The purpose of this work order task was to perform Control Voltage check for UVTA Coil. As per journeymen report voltages were satisfactory.
WO40766915-05 FAR 7	The purpose of this work order task was to inspect Reactor Trip Breaker B Cubicle and replace the 2 Cell Switches mounted on the bottom rear of the cubicle. In addition, this work order checked voltages that satisfy EC295954 PMT for train B. Voltage checks were performed after replacement with satisfactory results.
WO40766915-06	Task was canceled.
WO40766915-07 FAR 9	The purpose of this work order task was to inspect the cell switches located on the bottom rear of the RT Breaker A, Bypass Breaker A and Bypass Breaker B cubicles. In addition, this work order checked voltages that satisfy EC295954 PMT for train A. Results were sat.
WO40766915-08 FAR 8 EC40766915	The Purpose of this work order task was to install permanent U3 reactor trip and bypass breakers contacts test points to support RPS testing. Modification was completed with SAT PMT.

Westinghouse Investigation Results

Westinghouse Electric Company (WEC) conducted an exhaustive inspection and testing of the 3B RTB in order to identify any equipment related condition that could explain the cause of the RTB malfunction. WEC performed a formal failure analysis.

See Enclosure 1 for the complete WEC report.

WEC Failure Analysis Conclusions:

The breaker was received in very good condition and properly lubricated. This breaker as received was acceptable for use. The possible cause of failure could have been the bent breaker lock-out tabs on the front of the operating mechanism, they were found to be slightly bent, however the breaker operated without incident during all mechanical and electrical testing.

The cell switches appeared to be original supplied equipment. They were not properly maintained, and the hardened lubrication could cause the stationary contacts to become dislodged, as documented above. In addition, to contributing to the dislodging the stationary contacts, excess or dry grease can cause improper indications from the switch contacts. This could be considered a possible cause of failure.

WEC Recommendations:

It is recommended that the breaker be handled outside the switchgear cubicle with additional care. The breaker lock-out tabs on the front of the operating mechanism can cause the breaker not to function properly.



Please remove the Lock-Out Bar before testing and use of the breaker. It is also recommended that all DB breakers receive the attention during maintenance that this breaker has received.

The cell switches have a few areas of concern and recommendations will be provided for each concern.

If these were the original cell switches that were provided with the switchgear, it is recommended that they be replaced with safety related switch assemblies provided by Westinghouse Electric Company.

P/N: 302C517G01 Y, please include the proper switch configuration with your orders.

The Maintenance Program Manual for Westinghouse Safety Related Type DB Circuit Breakers and Associated Switchgear, Revision 1, July 2011 defines that the DB cell switch is a Category B item and the procedure provided should not exceed 5 Years. These requirements are included in Section 7.3, Item 6. The two cell switches provided for this investigation appeared to be beyond the 5-year requirement based on the hardening of the graphite grease on the switch contacts.

In addition, the spring and plunger of the cell switch may be lubricated per the recommendations in the MPM manual, Chapter 9. It is acceptable to apply 53701GW lubricant to the spring during maintenance intervals. Furthermore, the 53701GW lubricant can be applied to the cell switch plunger's penetration point through the mounting plate. The cell switches included in this investigation did not have any lubrication applied to the spring and the plungers were lubricated with a foreign type grease.

It is recommended that after the cell switches are replaced that they be maintained to the requirements provided in the Maintenance Program Manual for Westinghouse Safety Related Type DB Circuit Breakers and Associated Switchgear, Revision 1, July 2011.

After a detailed review of the data from the RTB maintenance history, WEC investigation and the FIP team actions, causal analysis was completed to determine the root and contributing causes for this event. The analysis included a Support/Refute Matrix (Attachment 5), Barrier Analysis (Section 6 and Attachment 6), Event and Causal Factor Chart (Section 7 and Attachment 7), and an Organization and Programmatic Assessment (Section 8 and Attachment 8).



Discussion on bent breaker lock-out tabs:

Although the WEC report states bent breaker lock-out tabs is a possible cause of failure for DB-50 breakers, the RCE team did not find any supporting evidence that the bent breaker lock-out tabs were causal to this event. The WEC report also stated the following:

“These photos show that without the face plate attached to the operating mechanism the Push to Trip button is free to fall below its normal position. This is not a concern as it shows that the tabs are not tight enough to hold the Push to Trip button.”

In addition, FAR 06 performed numerous cycling of the breaker once removed from the cubicle. The Trip Pushbutton was used to open the circuit breaker. No mechanical binding or resistance was noted, and no other issues were identified during cycling. If bent breaker lock-out tabs were the cause of the event, it would be expected that the first alarm to come in following the Unit trip in the SOE report would be ‘RX TRIP BKR B OPEN’. Instead, the turbine trip alarms came in first and the reactor trip breakers were opening in response to the event. See section of SOE report below:

```
LOG PRINT DATE: 03/01/21 11:12:49
Sequence of Events (NEW)
LOG DATE: 03/01/21 11:12:48
03-01-21 11:12:30.716 3SOE_01:E301S16.TBASOLC2_A ALARM TURB TRIP HDR PRESS CHNL 2
03-01-21 11:12:30.717 3SOE_01:E301S16.TBASOLC23_A ALARM TURB TRIP HDR PRESS 2/3
03-01-21 11:12:30.718 3SOE_01:E301S16.TBASOLC1_A ALARM TURB TRIP HDR PRESS CHNL 1
03-01-21 11:12:30.718 3SOE_01:E301S16.TBASOLC3_A ALARM TURB TRIP HDR PRESS CHNL 3
03-01-21 11:12:30.725 3SOE_01:E301S12.RT9_10RL_A ALARM RT 9 & 10 RELAYS
03-01-21 11:12:30.728 3SOE_01:E301S16.ASTPT_A_A ALARM AUTO SHUNT TRIP TEST A
03-01-21 11:12:30.730 3SOE_01:E301S16.ASTPT_B_A ALARM AUTO SHUNT TRIP TEST B
03-01-21 11:12:30.769 3SOE_01:E301S17.RXTPBKA_A ALARM RX TRIP BKR A OPEN
03-01-21 11:12:30.772 3SOE_01:E301S17.RXTPBKB_A ALARM RX TRIP BKR B OPEN
```

Discussion on MPM cell switch 100 cycle recommendation and Industry Practices:

Westinghouse MPM recommends a service life of 100 cycles for cell switches. PTN currently does not have a 100 cycle replacement PM in place and only performs inspections every 18 months. To gather information on industry practices for Westinghouse DB-50 cell switches, PTN polled the Circuit Breaker Users Group (CBUG). Three plants responded and only one plant has a replacement PM in place. Procedure steps from other sites were reviewed and they are similar to what is performed at PTN. Deficiencies in PTN procedures were noted when compared to other sites and include lack of plunger and spring lubrication, and confirmation of free movement of the plunger when actuated. Procedure 0-PME-049.01 should be enhanced to include these steps.

The industry review demonstrates that the majority of sites are crediting inspection PM's for continued reliability of the cell switches and are extending the recommended service life of 100 cycles. This is in line with the recommendations provided in the Westinghouse MPM which states:

With proper maintenance and inspections of the circuit breaker and cell at the interval recommended the breaker and cell values can be exceeded as addressed later in this section. The service/cycle life of the DB circuit breaker and its components are based on industry



standards, testing and analysis. Westinghouse does not recommend these components be considered run-to-failure components, however with proper maintenance and inspection of the breaker and cell components, the recommended lives could be justified beyond the values provided.

The basis for the design life of the cell switch, primary finger clusters and the secondary contacts is American National Standards Institute/Institute of Electrical and Electronics Engineers (ANSI/IEEE) C37.20.1-1987, "An American National Standard, IEEE Standard for Metal-Enclosed Low-Voltage Power Circuit-Breaker Switchgear," subsection 5.2.5. This section defines a low voltage (LV) switchgear with draw-out circuit breakers shall have mechanical endurance test cycles consisting of at least 100 operations between connected and test position. With proper maintenance and analysis of the components the 100 operation/cycle life of the cell components could be extended. The end of life condition of these components is not known. The switch that is used as the cell switch is the same switch used as an auxiliary switch on the DB breaker with a qualified life of 4,000 cycles on the DB-50 breaker. The remaining components of the cell switch consist of a metal frame, a metal operations bar and a metal return spring. None of these components are sensitive to age within 100 cycles.

If proper maintenance has been performed the breakers and cell components will operate beyond the service life recommendation. However, the support for the extended service life will be based on the documentation for those parts that have been collected during the maintenance activities.

This review demonstrates that PTN is not an outlier with regards to maintenance practices for Westinghouse DB-50 cell switches. Although, there is no 100 cycle replacement PM in place, the cell switches are being maintained via routine 18 month inspections which allows for extended service life.

Direct Cause:

While no exact direct cause was identified, the RCE team determined the most probable direct cause was hardened graphite grease on the cell switch #2 contact 1-2 causing a tracking path which incorrectly indicated the contact was closed when the contact was in an open state.

Root Cause:

RC1 - IAW 0-PME-049.01, steps for cleaning and lubricating cell switch contacts is conditional based, rather than prescriptive.

Conclusion:

DB-50 breakers and switchgear cubicles are inspected in accordance with 0-PME-049.01 which provides a methodical and proven approach to maintain the equipment. However, steps to clean and lubricate the cell switch contacts located inside the cubicle are conditional based, rather than prescriptive. This can lead to lack of proper cleaning of the cell switch and relies on skill of the craft and judgement of the journeyman performing the



inspection. A review of 0-PME-049.0.01 revision history showed that this procedural deficiency has existed since issuance of Rev 0 of the procedure in August 2009.

Contributing Causes:

CC1 - Test points to detect failed contacts were not installed.

Conclusion:

Point Beach modified their Reactor Trip and Trip Bypass breaker circuits circa 1984 in response to Generic Letter 83-28 to meet the Westinghouse Owner's Group (WOG) recommendations. The modification included test points upstream of their turbine trip relay. However, these test points were not part of the WOG recommendations. Therefore, these test points were a unique PB design. This is considered a legacy issue and would not have been identified as part of OE reviews.

CC2 - Failure to follow WEC MPM cell switch maintenance and replacement frequency.

Conclusion:

Procedure 0-PME-049.01 was developed using Westinghouse vendor manual V000211, and Westinghouse Maintenance Program Manual MPM-DB for Safety Related DB-50 Circuit Breakers and Associated Switchgear, E224A. All criteria in the site procedure meet vendor recommendations, with the exception of cell switch recommended life. Procedure does not check for cell switch cycles. There is no established PM for cell switch replacement.

4.0 Extent of Condition

The EOC was completed for this event. Corrective actions are required for Reactor Trip Breaker, Bypass Breakers, CRDM MG Set Output Breaker, and Main Generator Field Breaker Cell Switches. See Attachment 2 for full details.

5.0 Analysis of Risk and Safety Consequences

As documented in the Post Trip Review Restart Report for the U3 reactor trip, there were equipment issues related to the transient. Below is a summary of each.

- Steam dump to condenser valve, CV-3-2830, was slow to close and remained open when the other dump valves closed (AR 2385531).
- The 3A RCP had a locked in high pressure alarm (AR 2835559).
- The 3B RCP vertical vibrations increased from 11.5 mils to a peak of 16.5 mils before finally lowering to 12.5 mils (AR2385558).
- A TCS System Fault alarm associated with a chassis failure (AR 2385558).
- The U3 hotwell sample pumps tripped off (AR 2385565)



The equipment issues noted had no impact on environmental, radiological, or nuclear safety. In addition, there were no personnel safety issues associated with the event. Therefore, there were no adverse safety consequences related to the event.

The RCE team also reviewed whether the issues associated with the cell switches could lead to the breakers not opening on a open demand signal. The cell switch contacts in the Reactor Trip A and B applications are not wired to the OPEN circuits of the breakers. Therefore, the condition identified would not have prevented these breakers from opening on demand. With regards to the Reactor Trip Bypass A and B breakers, the cell switches are wired to the OPEN circuits for local manual tripping, and trip interlock circuits which prevent both Bypass A and B breakers from being racked in and closed at the same time. This interlock function is considered a backup function to administrative barriers which prevent both Bypass breakers from being racked in and closed at the same time.

This event is reportable to the NRC pursuant of 10 CFR 50.73(a)(2)(iv).

6.0 Barrier Analysis

A barrier analysis was completed as part of the causal analysis for this root cause evaluation. The following Hazard, Barriers, and Targets were evaluated:

Hazard	Barrier	Target
Quarterly Reactor Trip Testing performed IAW 3-SMI-049.02B results in a reactor trip.	Train Separation / Channel Redundancy	Successful surveillance test without automatic reactor trip.
	Plastic Barrier on Reactor Trip Breakers	
	Train Separation	
	Procedural surveillance testing	
	Training and Qualifications	
Westinghouse DB-50 Breaker and Cubicle Maintenance is inadequate to prevent breaker or cubicle reliability issues.	Review and Incorporation of Fleet OE	Breakers and cubicle perform reliably without issues.
	Procedural inspections	
	Preventive Maintenance Program Established	
	Training and Qualifications	
	Vendor Recommendations Incorporated	

Barrier Analysis Summary

The analysis identified one root cause and two contributing cause.

See Attachment 6 for more detail.

PI-AA-100-1005-F01



7.0 Event and Causal Factor (E&CF) Analysis

An E&CF chart was developed as part of the causal analysis. This technique was used in support of the barrier analysis to provide a means to graphically display the relationship between the sequence of events, inappropriate actions (IAs), and failed or weak barriers.

See Attachment 7 for more details.

8.0 Organizational and Programmatic (O&P) Analysis

The Root Cause Evaluation team identified Programmatic weaknesses that were causal to this event. Specifically, procedural inspections, implementation of WEC recommendations and the failure to install test points were all Programmatic issues.

See Attachment 8 for full details.

9.0 Training Performance Analysis

The RCE team performed a Training Analysis in order to determine if there were training gaps/deficiencies that could have contributed to this event. This review analyzed the training from both the maintenance training and operations training perspectives.

From the maintenance training perspective, every task that the Electrical Maintenance (EM) Technicians perform is analyzed and reviewed periodically (in accordance with the Maintenance ACAD requirements). As part of the Job Analysis, the Difficulty, Importance, and Frequency (DIF) is evaluated with the incumbents' input (normally 2 Senior Technicians, 2 Experienced Technicians, and 2 Junior Technician participate in the DIF process). The latest Task List Review/Job Analysis for the EM Training Program was approved on 10/08/2019. "Reactor Trip Breaker (Westinghouse DB-50) Maintenance", which is an Advanced Site-Specific Qualification (Block 4), DIF'd as "no retraining", due to the analyzed Difficulty, Importance, and Frequency of the task. Furthermore, racking in/out the RTB is not an EM task; this task belongs to Operations.

With regards to improper cleaning of cell switches in the DB-50 switchgear, Maintenance noted that the switches are difficult to get to even with a clearance on the equipment established, making inspection and cleaning of the cell switch contacts prohibitive. Therefore, the fact that the cell switches were found in a less than desirable condition does not reflect a weakness in Maintenance staff proficiency and is not considered a low level contributing cause to the event.

From the Operations Training perspective, likewise, every task that the Non-Licensed Operators perform is analyzed and reviewed periodically (in accordance with the Operations ACAD requirements), utilizing the same Task List Review/Job Analysis process delineated above. The "Rack-In & Out the Reactor Trip & Bypass Breakers" Qualification



DIF'd as "no retraining", due to the analyzed Difficulty, Importance, and Frequency of the task. The latest Task List Review/Job Analysis for the PTN Non-Licensed Operator Training Program was approved on 08/02/2019.

Based on the training analysis performed by the RCE team, training was not found to be a contributor to this event.

10.0 Operating Experience (OE) Review

The Institute of Nuclear Power Operations (INPO) Industry Reporting and Information System (IRIS) database was searched for keywords 'reactor trip breaker.' This search yielded 79 events of which 14 were screened as being relevant to this event. None of the 14 events were evaluated as OE by the site. This is aligned with the requirements of PI-AA-102-1001, Operating Experience Program Screening and Responding to Incoming Operating Experience. Since the OE was not of a high enough level to screen into the PTN OE program, there was no failure of the OE program. See Attachment 4 for a complete list of OE reviewed.

A review of LERs from the past 5 years did not identify any reactor trips related to Reactor Trip Breaker malfunctions, therefore, this is not a repeat event.

IER L2-11-2 Scram Analysis

Per LI-AA-100-1005, a review of PTN's response to INPO IER L2-11-2, 2009 – 2010 Scram Analysis, is required since this event resulted in a reactor scram. PTN's response to IER L2-11-2 is documented under CR 1673959. The IER recommendations related to the cause of this event (less than adequate maintenance procedure guidance for cleaning and lubricating RPS cell switch contacts) are contained under Maintenance recommendations. The specific recommendation was to evaluate work instructions and maintenance technical procedure details that involve SPVs, critical components, and systems that have contributed to 5 percent or more to scrams for PWRs. Attachment 5 to the IER shows that RPS contributed to > 5 percent of PWR scrams. PTN's response limited the RPS SPVs to the following:

- RPS Eagle 21
- RPS Hagan Controllers
- RPS AC Relays

Since the site response to the IER did not contain SPVs associated with RTB, RBB, and their associated cell switches, there is a gap in the response. Actions will be generated out of this RCE to revise the sites IER response. Note that corrective actions from this RCE close the gaps that would have been identified if the IER response included the RPS cell switches.



11.0 Safety Culture (SC) Analysis

The following aspects were determined to be actual or potential weaknesses contributing to the cause of this event. Corrective actions to address the root and contributing causes of this event address these safety culture aspects. See Attachment 9 for the detailed Nuclear Safety Culture Evaluation Table.

H.1	Resources: Leaders ensure that personnel, equipment, procedures, and other resources are available and adequate to support nuclear safety (LA.1).	This is directly tied to RC1.
-----	---	-------------------------------

13.0 Extent of Cause (EOCa)

Extent of Cause Summary Results:

The Root Cause Evaluation team completed an Extent of Cause (EOCa) evaluation for the root cause of this event. The team identified two corrective actions to address EOCa.

RC1 EOCa CA1 - Review maintenance procedures for Reactor Trip Breaker switchgear for other conditional steps, which if not performed, can result in equipment failure. Revise procedures as necessary.

RC1 EOCa CA2 - Review maintenance procedures for CRDM MG set output breaker and Generator Field breaker cubicles inspections and ensure cleaning of cell switch contacts (if installed) is prescriptive. Revise procedures as necessary.

RC1 EOCa CA3 - Review maintenance procedures for CRDM MG set output breaker and Generator Field breaker cubicles inspections for other conditional steps, which if not performed, can result in equipment failure. Revise procedures as necessary.

See Attachment 3 for analysis details.



14.0 Corrective Actions

Causes	NAMS #	Corrective Actions to Prevent Occurrence	Assigned Dept. or Individual and Due Date
<p>RC1 - IAW 0-PME-049.01, steps for cleaning and lubricating cell switch contacts is conditional based, rather than prescriptive.</p>	CAPR 2385529-27	Revise procedure 0-PME-049.01 to require cleaning and lubrication of cell switch contacts.	<p>Juan Pallin Due 5/21/2021</p>
	CA 2385529-28	Revise procedure 0-PME-049.01 to require Engineering be notified in order to observe the cleaning and lubricating of the cell switch contacts as revised in CAPR 2385529-27. This step will be annotated with a note stating the step can be removed from the procedure once.	<p>Juan Pallin Due 5/21/2021</p>



Corrective Actions for Contributing Causes			
Causes	NAMS #	Assignment Description	Assigned Dept. or Individual and Due Date
CC1 - Test points to detect failed contacts were not installed.	CA 2385529-29	Implement modification for Unit 4 to detect for standing trip signal from failed breaker cubicle cell switch contact. Scope modification into PT4-33 or the first available opportunity.	Rafael de la Torre Due 7/30/2021
CC2 - Failure to follow WEC MPM cell switch maintenance and replacement frequency.	CA 2385529-30	Replace cell switches in remaining Reactor Trip and Reactor Trip Bypass Breaker cubicles during upcoming refueling outages. <ol style="list-style-type: none"> 1. WR for Remaining Unit 3 Reactor Trip and Trip Bypass Breaker cubicles 2. Scope work into upcoming PT3-32 outage or the first available opportunity. 3. WR for Unit 4 Reactor Trip and Trip Bypass Breaker cubicles 4. Scope work into upcoming PT4-33 outage or the first available opportunity 	Juan Pallin Due 5/7/2021



Corrective Actions for Contributing Causes			
Causes	NAMS #	Assignment Description	Assigned Dept. or Individual and Due Date
	CA 2385529-31	Create new PMID for Reactor Trip and Trip Bypass Breaker Cell Switch replacements and establish frequency commensurate with 100 cycle service life.	Rafael Leavitt Due 5/27/2021
Extent of Cause Corrective Actions			
Causes	NAMS #	Assignment Description	Assigned Dept. or Individual and Due Date
EOCa for RC1 IAW 0-PME-049.01, steps for cleaning and lubricating cell switch contacts is conditional based, rather than prescriptive.	CA 2385529-32	Review maintenance procedures for Reactor Trip Breaker switchgear cubicles inspections for other conditional steps, which if not performed, can result in equipment failure. Revise procedures as necessary.	Rafael Leavitt Due 7/30/2021
EOCa for RC1 IAW 0-PME-049.01, steps for cleaning and lubricating cell switch contacts is conditional based, rather	CA 2385529-33	Review maintenance procedures for CRDM MG set output breaker and Generator Field breaker cubicles inspections and ensure cleaning of cell	Ramiro Duarte Due 7/30/2021



Corrective Actions for Contributing Causes			
Causes	NAMS #	Assignment Description	Assigned Dept. or Individual and Due Date
than prescriptive		switch contacts (if installed) is prescriptive. Revise procedures as necessary.	
	CA 2385529-34	Review maintenance procedures for Generator Field breaker cubicles inspections and ensure cleaning of cell switch contacts (if installed) is prescriptive. Revise procedures as necessary.	Randy Kerkes Due: 7/30/21
EOCa for RC1 IAW 0-PME-049.01, steps for cleaning and lubricating cell switch contacts is conditional based, rather than prescriptive.	CA 2385529-35	Review maintenance procedures for CRDM MG set output breaker and Generator Field breaker cubicles inspections for other conditional steps, which if not performed, can result in equipment failure. Revise procedures as necessary.	Randy Kerkes Due: 7/30/21



Extent of Condition Corrective Actions			
Causes	NAMS #	Assigned Description	Assigned Dept. or Individual and Due Date
EOC for RC1 - Failure to follow WEC MPM cell switch maintenance and replacement frequency for Reactor Trip Breakers.	CA 2385529-36	Review Westinghouse Maintenance Program Manual (MPM) and ensure all components used in Reactor Trip Switchgear have a maintenance strategy established commensurate with the MPM.	Rafael Leavitt Due 7/15/2021
	CA 2385529-37	Review Westinghouse Maintenance Program Manual (MPM) and ensure all components used for CRDM MG set output breaker and Generator Field applications have a maintenance strategy established commensurate with the MPM.	Ramiro Duarte Due 7/15/2021
	CA 2385529-38	Review Westinghouse Maintenance Program Manual (MPM) and ensure all components used for the Generator Field applications have a maintenance strategy established commensurate with the MPM.	Randy Kerkes Due 7/15/2021
EOC for CC1 - Failure to incorporate PB/GL 83-28 action of installing test points.	CA 2385529-39	Investigate whether a similar vulnerability exists for CRDM MG set output breaker and Generator Field breaker control circuits. Initiate ECs to install test points if necessary.	Rafael Leavitt Due 6/30/2021



Extent of Condition Corrective Actions			
Causes	NAMS #	Assigned Description	Assigned Dept. or Individual and Due Date
EOC for CC2 - Failure to follow WEC MPM cell switch maintenance and replacement frequency.	CA 2385529-40	Create new PMID for CRDM MG set output breaker and Generator Field breaker cubicle cell switch replacements as necessary.	Rafael Leavitt Due 5/27/2021
Other Corrective Actions			
NAMS #	Assignment Description		Assigned Dept. or Individual and Due Date
CA 2385529-41	Revise Reactor Protection System Surveillance Test Interval for Tech Spec Table 4.3-1, Functional Units Items 19, 20, 21 to 18 months.		Michael Murphy Due 6/30/2021
CA 2385529-42	Revise PTN's response to INPO IER L2-11-2, 2009 – 2010 Scram Analysis per Section 10.0, Operating Experience.		Bob Hess Due 6/30/2021



15.0 Effectiveness Review

Number:	EFR 2385529-XX		
Corrective Action:	<p>CAPR1 - Revise procedure 0-PME-049.01 to require cleaning and lubrication of cell switch contacts.</p> <p>Note – If Effectiveness review determines the CAPR was effective, 0-PME-049.01 can be revised to not require observation of cleaning and lubrication of the cell switches. This step was added to ensure the CAPR was adequately addressed by the procedure revision to 0-PME-049.01.</p>		
Method:	Review of U3 and U4 reactor trip breaker and bypass breaker cell switch inspection results		
Attributes:	Cell switches have been adequately lubricated		
Success:	All of U3 and U4 Reactor Trip and Trip Bypass Breakers cell switches are lubricated properly		
Timeliness:	Complete final effectiveness review 3 years after completion of corrective actions		
Owner Group:	Christopher Boyd	Due Date:	6/30/2022



16.0 CRs Generated During the Common Cause Evaluation

CR Number	Description
NA	NA

17.0 Proof Statement and Lessons Learned

Proof Statement

The Unit 3 trip was caused by inadequate procedure guidance in 0-PME-049.01 for cleaning and lubricating cell switch contacts, and is corrected by revising procedure 0-PME-049.01 to require cleaning and lubrication of cell switch contacts.

Lessons Learned

Lessons learned from this Root Cause Evaluation team are captured in the causal analysis and associated corrective actions.

Attachments:

- Attachment 1: Root Cause Evaluation Team Charter
- Attachment 2: Extent of Condition Evaluation
- Attachment 3: Extent of Cause Evaluation
- Attachment 4: Operating Experience Analysis
- Attachment 5: Support Refute Matrix
- Attachment 6: Barrier Analysis
- Attachment 7: Event and Causal Factor (E&CF) Analysis
- Attachment 8: Organizational and Programmatic (O&P) Analysis
- Attachment 9: Safety Culture (SC) Analysis
- Attachment 10: Corrective Action Line of Sight (LOS) Table
- Attachment 11: List of Documents Reviewed
- Attachment 12: Industry Practices on Cell Switch Maintenance



Attachment 1: Root Cause Evaluation Team Charter

Root Cause Charter

Facility/CR Number: PTN / CR# 2385529

Manager Sponsor: Bob Tomonto

Event Description: Reactor Trip During Restoration from RPS Testing

Problem Statement: On March 1, 2021, at 1112, PTN Unit 3 automatically tripped during restoration from Reactor Protection System Testing 3-SMI-049.02B. The reactor trip was caused by an unknown failure of the 3B reactor trip breaker.

Preliminary Extent of Condition: The preliminary Extent of Condition (EOC) has been analyzed as part of the FIP conducted in response to the trip. The EOC will be further analyzed by this RCE utilizing guidance from PI-AA-100-1005 to determine final Extent of Condition.

Investigation Scope and Methodology: Perform a Root Cause Evaluation in accordance with PI-AA-100-1005. Analysis methodologies should include Barrier Analysis, Organizational and Programmatic Affects, Safety Culture Analysis, and Event and Causal Factors Charting. Note: Failure Analysis of the breaker and cell switch will be performed by Westinghouse.

Team Members

Team Lead: (Qualified RCE Evaluator): Bob Murrell, Duane Arnold Licensing

Team Member: Luis Mazo, Maintenance

Team Member: Richard Jackson, Operations

Team Member: Robert Rodriguez, Training

Team Member: Orlando Carol, Engineering

Management Sponsor: Bob Tomonto, Engineering

Milestones:

Date Assigned: 3/08/21

Status Update: 3/15/21

Draft Report: 3/25/21

Final Report: 4/02/21

Communications Plan:

RCE Team Lead to hold regular briefs with PTN/Fleet managers.

Sponsor Approval: _____ Date: _____

MRC Approval: _____ Date: _____

Electronic signatures may be obtained by assigning actions in NAMS or using a routing list.



Attachment 2: Extent of Condition Evaluation

Extent of Condition (EOC) Analysis:

Extent of Condition (EOC) Evaluations were completed in order to identify other deficiencies that need to be addressed by the corrective actions from this RCE.

The following table implements the Same-Similar techniques as outlined in PI-AA-100-1005, Root Cause Analysis, Attachment 13.

<i>Condition Statement:</i>		On March 1, 2021 at 1112, Unit 3 experienced an unplanned automatic reactor trip during restoration of the 3B Reactor Protection System Logic Test, 3-SMI-049.02B. During performance of the SMI, the 3B Reactor Trip Bypass Breaker (BYB) is closed. As part of the restoration, the 3B Reactor Trip Breaker (RTB) breaker is closed and the BYB is locally tripped. When the BYB was tripped open, Unit 3 experienced an automatic reactor trip.	
<i>Object:</i>	Reactor Trip Breaker Cubicle Cell Switch	<i>Defect:</i>	Cell Switch Contact malfunctioned, resulting in an automatic reactor trip
<i>Tier</i>	<i>Object</i>	<i>Defect</i>	<i>Comments</i>
<i>(a) Same-Same</i>	Reactor Trip Breaker Cubicle Cell Switch	Cell Switch Contact malfunctioned, resulting in an automatic reactor trip	The EOC for this event must include all U3 and U4 Reactor Trip Breaker Cubicle Cell Switches, including BYP Breakers that could malfunction, resulting in a reactor trip
<i>(b) Same-Similar</i>	Reactor Trip Breaker Cubicle Cell Switch	Cell Switch Contact malfunctioned, resulting events outside of reactor trip	The EOC for this event must include all U3 and U4 Reactor Trip Breaker Cubicle Cell Switches, including BYP Breakers that could malfunction, resulting in an event other than a reactor trip



<i>(c)</i> <i>Similar-Same</i>	CRDM MG Set Output Breaker Cubicle Cell Switch And Main Generator Field Breaker Cubicle Cell Switch (Breaker Model DS-206)	Cell Switch Contact malfunctioned, resulting in an automatic reactor trip	The EOC for this event must include all U3 and U4 CRDM MG Set Output and Main Generator Field Breaker Cubicle Cell Switches that could malfunction, resulting in a reactor trip
<i>(d)</i> <i>Similar-Similar</i>	CRDM MG Set Output Breaker Cubicle Cell Switch And Main Generator Field Breaker Cubicle Cell Switch (Breaker Model DS-206)	Cell Switch Contact malfunctioned, resulting events outside of reactor trip	The EOC for this event must include all U3 and U4 CRDM MG Set Output and Main Generator Field Breakers, including BYP Breaker Cubicle Cell Switches that could malfunction, resulting in an event other than a reactor trip

Extent of Condition Conclusions

a) Same-Same

Corrective actions associated with CC2 for this event will address all issues associated with all U3 and U4 Reactor Trip Breaker, including BYP Breaker cell switches. No further actions are required for Same-Same.

b) Same-Similar

There were no events that could be initiated by a malfunction of the Reactor Trip and Bypass Breakers. Therefore, corrective actions associated with CC2 for this event will address all issues associated with U3 and U4 Reactor Trip Breaker, including BYP Breaker cell switches that could malfunction, resulting in an event other than a reactor trip. No further actions are required for Same-Similar.

c) Similar-Same

Corrective actions will be required to create a new PMID for the CRDM MG Set Output Breaker and Generator Field Breaker cubicle cell switch replacement. In addition, a review Westinghouse Maintenance Program Manual (MPM) will be conducted to ensure all components used for CRDM MG set output breaker and Generator Field applications have a maintenance strategy established commensurate with the MPM.

d) Similar-Similar

Corrective actions to address CC2 adequately address Similar-Similar. Therefore, no further actions are required for Similar-Similar.



Attachment 3: Extent of Cause Evaluation

Extent of Cause (EOCa) Analysis:

Extent of Cause (EOCa) Evaluation was completed in order to identify other deficiencies that need to be addressed by the corrective actions from this RCE.

The following table implements the Same-Similar techniques as outlined in PI-AA-100-1005, Root Cause Analysis, Attachment 14.

<i>Condition Statement:</i>		On March 1, 2021 at 1112, Unit 3 experienced an unplanned automatic reactor trip during restoration of the 3B Reactor Protection System Logic Test, 3-SMI-049.02B. During performance of the SMI, the 3B Reactor Trip Bypass Breaker (BYB) is closed. As part of the restoration, the 3B Reactor Trip Breaker (RTB) breaker is closed and the BYB is locally tripped. When the BYB was tripped open, Unit 3 experienced an automatic reactor trip.	
<i>Object:</i>	Procedure 0-PME-049.01	<i>Defect:</i>	Step for Cell Switch contact cleaning and lubrication is conditional, rather than prescriptive, thereby relying on skill of the craft to determine if cleaning and lubrication is required
Tier	Object	Defect	Comments
<i>(a) Same-Same</i>	Procedure 0-PME-049.01	Step for Cell Switch contact cleaning and lubrication is conditional, rather prescriptive.	The EOCa for this event must address all U3 and U4 Reactor Trip Breaker switchgear procedures used for inspection of the Cubicle Cell Switch. Procedure 0-PME-049.01 applies to both Unit 3 and 4 Reactor Trip Breaker switchgears and is the only procedure used for Cubicle Cell Switch inspections.



<i>(b) Same-Similar</i>	Procedure 0-PME-049.01	Procedure includes other conditional inspection steps which if not performed can result in a failure of Reactor Trip Breaker equipment	The EOCa for this event must include all other conditional steps in procedure 0-PME-049.01 which if not performed, can result in a failure of Reactor Trip Breaker equipment
<i>(c) Similar-Same</i>	CRDM MG Set Output Breaker switchgear and Main Generator Field Breaker switchgear inspection procedures	Step for Cell Switch contact cleaning and lubrication is conditional, rather prescriptive	The EOCa for this event must include Cell Switch inspection steps for procedures used on CRDM MG Set Output Breaker switchgear and Main Generator Field Breaker switchgear
<i>(d) Similar-Similar</i>	CRDM MG Set Output Breaker switchgear and Main Generator Field Breaker switchgear inspection procedures	Procedure includes other conditional inspection steps which if not performed can result in a failure of CRDM MG Set Output Breaker switchgear and Main Generator Field Breaker switchgear	The EOCa for this event must include all other conditional steps in procedures used on CRDM MG Set Output Breaker switchgear and Main Generator Field Breaker switchgear which if not performed can result in equipment failure

Extent of Cause Conclusions

a) Same-Same

Corrective actions associated with the Root Cause for this event will address all issues associated with all U3 and U4 Reactor Trip and Bypass Breaker cell switches, as well as conditional cell switch inspection steps for these components. Procedure 0-PME-049.01 is used for both units. No further actions are required for Same-Same.

b) Same-Similar

Corrective actions associated with the Root Cause for this event will address all issues associated with U3 and U4 Reactor Trip and Bypass Breaker cell switches that could malfunction, resulting in an event other than a reactor trip. Corrective actions will also include other conditional steps in procedure 0-PME-049.01 that, if not performed, can result in equipment failure. No further actions are required for Same-Similar.

c) Similar-Same



Corrective actions will be required to investigate whether the same cell switches are used in the CRDM MG Set Output Breakers and Generator Field Breakers and generate work requests as needed. Additionally, Corrective actions will be needed to investigate consequence of failure of cell switch contacts on CRDM MG set output breaker and Generator Field breakers and develop interim/final resolution actions as necessary. Corrective actions will also include review of inspection procedures for CRDM MG Set Output Breaker and Generator Field Breaker switchgears to ensure cell switch inspection steps are not conditional.

d) Similar-Similar

Corrective actions to address the root cause will include a review of inspection procedures for CRDM MG Set Output Breaker and Generator Field Breaker switchgears to ensure other conditional steps, which if not performed, can result in equipment failure.



Attachment 4: Operating Experience Analysis

Internal and External Operating Experience (OE) Review Summary

Details

Internal OE:

A review of LERs from the previous 5 years failed to identify any other reactor trips due to spurious RTB breaker trips.

External OE:

An INPO OE search yielded 79 items of which 14 items were screened as being relevant to issue identified in AR 2355529. The outcome of this review is as follows:

Surry Unit 1 - Reactor Trip Breaker Failed to Trip During Reactor Protection Testing

While performing the monthly Reactor Protection testing of train "B" Reactor Protection the shunt trip test failed to actuate properly and did not trip the "B" Reactor Trip Breaker (RTB) as expected. The cause of this event was misalignment of the contact spring on the contact block for the S1 pushbutton test switch

Conclusion - Not applicable.

Surry Unit 2 - Reactor Trip Due to Loose Lead in Reactor Protection System

Source of the trip was a spurious opening of the 'B' reactor trip breaker. Troubleshooting in the protection relay racks found a loose electrical connection on a contact pair on a relay that provides the control power for the 'B' reactor trip breaker. This loose terminal caused a reduced voltage on the UV coil opening the B reactor trip breaker (RTB) and initiating a reactor trip

Conclusion - Applicable - Failure of control power added to Support/Refute Matrix.

Salem Unit 1 - OE4022 - DEFORMED CONTACTS ON WESTINGHOUSE TYPE DB-50 CIRCUIT BREAKERS DISCOVERED DURING TESTING

Shunt trip function failed to trip the breaker; shunt coil did not energize. The coil is in series with the #7 moving contact which is installed in the DB secondary moving contact assembly. Contact was found to be compressed to the point where it was not in contact with the stab. It is currently hypothesized that the retaining hook opening on the moving contact escaped the retaining hook and protruded too far below the bottom of the contact base. As a result, when the breaker is racked in, the stab pushes against the contact and deforms the shape of the contact. Further inspection of the Unit 1 breakers identified 5



additional deformed contacts. All deformed contacts were replaced. Westinghouse feels that the failure may be related to the breaker/cell alignment.

Conclusion - Not directly applicable. Issue was not a failure to trip; breaker was not racked out during testing when failure occurred. FIP team FARs exercised breaker alignment with no issues identified.

Cook Unit 2 - OE4271 - FAULTY AUXILIARY CONTACTS IN REACTOR TRIP BYPASS BREAKER CAUSE UNEXPECTED REACTOR TRIP ACTUATION

Cause of the event was attributed to a failure of the train B bypass breaker auxiliary contacts to make up properly and provide the electrical interlock necessary to allow closure of the Train A bypass breaker. A subsequent investigation of the train B bypass breaker found an excess of lubricant on all the auxiliary contacts, causing high electrical resistance and incorrect position indication to the Reactor Protection System. The breaker's preventive maintenance procedure was found to closely follow the manufacturer's recommendations but did not contain specific inspection guidance to ensure satisfactory auxiliary contact performance. All auxiliary contacts of the breaker were cleaned, burnished and tested for proper continuity. The remaining reactor trip and bypass breakers were also inspected. One additional breaker was found with contacts having slightly high resistance and was cleaned and burnished as well. The breaker inspection procedure was revised to include checks of continuity and excessive grease. The Startup Instrumentation Check procedure was enhanced to include General Warning signal clearing verification when opening of bypass breakers prior to closing the opposite train bypass breaker.

Conclusion - Applicable – Aux contact failure was failure mode of excessive grease on the Support/Refute Matrix.

Cook Unit 2 - OE4998 - DB-50 REACTOR TRIP BREAKER UNDERVOLTAGE TRIP ATTACHMENT PREVENTS BREAKER CLOSURE

Unable to close Reactor Trip Breaker "B" with the control switch. The undervoltage trip attachment (UVTA) found the reset arm latch would intermittently fail to engage. This situation places the UVTA in a semi-tripped condition in which temperature, vibration or lower coil voltage could cause the breaker to trip instantaneously when closed. In 1986, the Westinghouse DB-50 maintenance manual was revised and added a recommendation for UVTA reset arm calibration when initially installed. The reasons for not calibrating the 1985 vintage UVTA after receipt of the revised manual could not be determined.

Conclusion - Not applicable, issue was not a breaker that tripped instantaneously when closed.

Cook Unit 2 - OE18287 - REACTOR TRIP DURING BREAKER RACKING



Reactor trip occurred while an equipment operator was attempting to rack out a DB-50 reactor trip bypass breaker. The racking bar incorrectly positioned and contacted an energized component, causing an arc inside the breaker cubicle. This resulted in loss of one phase of the power supply to the rod control cabinets, causing multiple control rods to drop into the core and triggering the reactor trip

Conclusion - Not applicable.

Diablo Canyon Unit 2 - Reactor Trip Breaker Failed to Close During Start-Up (OE27837)

Reactor trip breaker RTB failed to close and the control power fuse opened when the control switch was placed in the closed position. Breaker inertial latch was sluggish on the pivot pin and would occasionally catch the "CATCH" pin on the closing lever. Latch pivot pin and bushing was found with excessive dry lubricant which caused the sluggish motion. The apparent cause is inadequate procedural guidance to 1. Clean the latch pin and bushing and, 2. Quantitatively limit the amount of lubricant applied.

Conclusion - Not applicable.

Ginna Unit 1 - OE21379 - Westinghouse DB-50 breaker abnormal trip bar movement

Westinghouse DB-50 breaker (containment spray motor) abnormal trip bar, the trip bar rose when the breaker frame was tapped. The bar rose slightly each time the frame was tapped until the breaker tripped. Westinghouse investigation found multiple operating mechanism component tolerance deviations. The combination of these deviations resulted in the abnormal mechanism operation.

Conclusion - Not applicable.

Salem Unit 2 - OE22435 - Reactor Trip Breaker Failed to Electrically Close

Reactor Trip Breaker failed to electrically close. A loose pin inside the operating mechanism was found to have rubbed against the housing and resulted in a breaker failing to remain electrically closed (tripping free).

Conclusion - Not applicable issue was not a breaker that tripped free.

Sequoyah Unit 1 - OE23458 - Failure of Westinghouse Type DB Reactor Trip Breaker to Close and Remain Closed

Reactor Trip Breaker RT A was given a close signal from the Main Control Room immediately opened after attempting to close. After developing a list of possible causes, troubleshooting was performed but could not recreate the problem nor identify a root or apparent cause. Troubleshooting during the next outage could not recreate the problem and the most probable cause was identified as the MCR hand switch.



Conclusion - Not applicable.

Turkey Point Unit 3 - OE23298 - Failure of Unit 3 Reactor Trip Breaker to close

3A Reactor Trip Breaker failed to close, when the Reactor Trip Reset was pressed, the breaker went closed but immediately reopened. The removed breaker was found to have a loose pivot screw on the UVTA adjustable reset lever. The screw was loose enough that the adjustable part of the reset lever had moved to one side of the reset adjustment screw causing a gross mis-adjustment of the reset lever. The UVTA could not reset causing the breaker to be in a continuous trip condition.

Conclusion - Not applicable.

Kewaunee Unit 1 - OE21282 - Reactor Trip Bypass Breaker A Failed to Remain Closed During Testing

I&C Maintenance was performing SP-47-316A, Channel 1(Red) Instrument Channel Test. Step 6.7.11 requires the 52/BYA reactor trip breaker to be closed using the 52/BYA pushbutton in RR121. When the technician pushed the button, the breaker closed and then immediately opened. The apparent cause of the breaker to not close was a cotter pin that had turned 180 degrees. This positioned the long leg of the bent cotter pin against the closing mechanism. This forced the operating mechanism to go out of alignment preventing the breaker from latching closed. It is not known why the cotter pin turned 180 degrees in its mounting hole.

Conclusion - Not applicable

Prairie Island Unit 1 - Failure of contact(s) in Plant Protection System circuit breaker 1-52/RTA.

Reactor trip breaker 1-52/RTA failed to close after several attempts. No cause was identified.

Conclusion - Not applicable.

Cooper Unit 1 - Westinghouse DB 50 Breaker Reliability

Westinghouse DB 50 480-volt breaker was removed from service because of unreliable performance. It had been installed to provide power to a station air compressor and experienced several instances of blown closing coil fuses. The cause of these failures was inadequate clearance between the inertia latch and the main contact cross bar. This caused binding, resulting in an extended flow of current through the closing coil and the blown fuses.

Conclusion - Not applicable.

PI-AA-100-1005-F01



There have been a number of NSALs, Bulletins, etc., issued, some of which are listed below. None of these have been found to be directly applicable to this event.

1. NSAL-93-020, "DB/DHP Breaker Control Relay," dated 10/5/93.
2. NSAL-98-009, DB Breaker Failure to Close, dated 9/28/99.
3. NSD-TB 91 -03, DB Breaker Secondary Contact Failure, dated 4/22/91.
4. NSD-TB 92-04, DB Breaker Maintenance, Breakdown of Primary Insulation and Incorrect Torqueing of Bolts, dated 5/18/92.
5. NSD-TB-93-05-R0, "Unauthorized Switchgear Maintenance Manuals," dated 1/10/94
6. MR-H-98-0138, 10 CFR Part 21, Sticking Inertial Latch in Model DB-50.
7. IE BULLETIN 83-01, "Failure of Reactor Trip Breakers (Westinghouse DB-50) to Open on Automatic Signal," dated, 2/25/1983.
8. IE BULLETIN 83-04, "Failure of the Undervoltage Trip Function of Reactor Trip Breakers," dated March 11, 1983.
9. IE BULLETIN 85-02, "Undervoltage Trip Attachments of Westinghouse DB-50 Type Reactor Trip Breakers," dated 11/5/1985.
10. IN 83-18, "Failures of the Under voltage, Trip Function of Reactor Trip System Breakers," dated April 1, 1983.
11. IN 93-85, "Problems with X-Relays in DB- and DBH-Type Circuit Breakers Manufactured By Westinghouse," dated 10/20/1993.
12. IN 95-19, "Failure of Reactor Trip Breaker to Open Because of Cutoff Switch Material Lodged in the Trip Latch Mechanism," dated March 22v,1995.
13. IN 95-22, "Hardened or Contaminated Lubricants Cause Metal-Clad Circuit Breaker Failure," dated April 21, 1995.
14. IN 96-44, "Failure off Reactor Trip Breaker from Cracking of Phenolic Material in Secondary Contact Assembly," dated 8/5/1996.
15. IN 96-44, Supplement 1, "Failure of Reactor Trip Breaker from Cracking of Phenolic Material in a Secondary Contact Assembly," dated July 2, 1997.
16. IN 96-46, "Zinc Plating of Hardened Metal Parts and Removal of Protective Coatings in Refurbished Circuit Breakers," dated August 12, 1996.
17. NSTB-83-03 Westinghouse Models DB& DS Circuit Breaker Shunt & Under voltage (UV) Coils, dated 3/24/83.

OE Conclusions

There were no internal events that could be considered precursor events to the event being evaluated by the RCE team. Where applicable operating experience was identified, this information was added to the Fault Tree to ensure that branch element was reviewed. In accordance with PI-AA-104-1000, this was not a repeat event. There were several external events that were found to be applicable and the causes were added to the Support/Refute Matrix.



Attachment 5: Support Refute Matrix

Support/Refute Matrix				
Unit 3 Automatic Reactor Trip during restoration from B Train RPS testing 3-SMI-049.02B				
Problem statement: During restoration step 5.1.6 of Train B RPS testing procedure 3-SMI-049.02B step which opens the Reactor Trip Bypass breaker B, Unit 3 experienced an automatic reactor trip. A review of the Sequence of Events report following the trip revealed the first alarm in was Turbine Trip HDR Pressure Channels, followed by Reactor Trip Relays 9 and 10, and then Reactor Trip Breakers A and B Trip. The SOE report demonstrates that the initiating event of the Reactor Trip was Turbine Trip which is driven by the 94/AST (primary) and 94/ASB (backup) relays. The Reactor Trip Breaker B and Bypass Breaker B provide trip logic to the 94/ASB relay.				
Potential Cause	Discussion	Supporting / Refuting Evidence	Evidence Status / Source	Cause
PEOPLE				
I&C personnel depressed the wrong pushbutton (i.e. tripped Reactor Trip Breaker B) when performing step 5.1.6.	Tripping of the Reactor Trip breaker B instead of the Bypass breaker would not explain the event. With the Bypass breaker B closed, not automatic unit trip is expected.	Refuted Interview with site personnel and SOE report do not support a Human Error occurring.	Closed Interviews and SOE reports.	Not a Cause
ORGANIZATIONAL/PROGRAMMATIC/PROCESS				
Preventive Maintenance	Inadequate maintenance strategy	Supporting	Closed	Contributing Cause (CC2) - Failure to follow WEC



Support/Refute Matrix

Unit 3 Automatic Reactor Trip during restoration from B Train RPS testing 3-SMI-049.02B

Problem statement: During restoration step 5.1.6 of Train B RPS testing procedure 3-SMI-049.02B step which opens the Reactor Trip Bypass breaker B, Unit 3 experienced an automatic reactor trip. A review of the Sequence of Events report following the trip revealed the first alarm in was Turbine Trip HDR Pressure Channels, followed by Reactor Trip Relays 9 and 10, and then Reactor Trip Breakers A and B Trip. The SOE report demonstrates that the initiating event of the Reactor Trip was Turbine Trip which is driven by the 94/AST (primary) and 94/ASB (backup) relays. The Reactor Trip Breaker B and Bypass Breaker B provide trip logic to the 94/ASB relay.

Potential Cause	Discussion	Supporting / Refuting Evidence	Evidence Status / Source	Cause
Program on cubicle cell switch inadequate	can lead to end of life failures of cubicle cell switch.	Westinghouse Maintenance Program Manual (MPM) recommends a service life of 100 cycles for cell switches. Cell switches are not normally replaced as part of routine maintenance. There is no PM in place to perform cell switch replacements. The cell switches are original plant equipment. Forensic testing identified two failed normally open contacts (one on each switch) from fatigued (aged) stationary contacts. Refuting Evidence Forensic report provided by Westinghouse has stated the following with regards to the 100 cycle recommended service life:	Although forensics identified two normally open contacts with age related failures, this failure mode would not have resulted in the unit trip event.	MPM cell switch maintenance and replacement frequency



Support/Refute Matrix

Unit 3 Automatic Reactor Trip during restoration from B Train RPS testing 3-SMI-049.02B

Problem statement: During restoration step 5.1.6 of Train B RPS testing procedure 3-SMI-049.02B step which opens the Reactor Trip Bypass breaker B, Unit 3 experienced an automatic reactor trip. A review of the Sequence of Events report following the trip revealed the first alarm in was Turbine Trip HDR Pressure Channels, followed by Reactor Trip Relays 9 and 10, and then Reactor Trip Breakers A and B Trip. The SOE report demonstrates that the initiating event of the Reactor Trip was Turbine Trip which is driven by the 94/AST (primary) and 94/ASB (backup) relays. The Reactor Trip Breaker B and Bypass Breaker B provide trip logic to the 94/ASB relay.

Potential Cause	Discussion	Supporting / Refuting Evidence	Evidence Status / Source	Cause
		<p><i>The basis for the design life of the cell switch, primary finger clusters and the secondary contacts is American National Standards Institute/Institute of Electrical and Electronics Engineers (ANSI/IEEE) C37.20.1-1987, "An American National Standard, IEEE Standard for Metal-Enclosed Low-Voltage Power Circuit-Breaker Switchgear," subsection 5.2.5. This section defines a low voltage (LV) switchgear with draw-out circuit breakers shall have mechanical endurance test cycles consisting of at least 100 operations between connected and test position.</i></p> <p><i>With proper maintenance and analysis of the components the 100 operation/cycle</i></p>		



Support/Refute Matrix

Unit 3 Automatic Reactor Trip during restoration from B Train RPS testing 3-SMI-049.02B

Problem statement: During restoration step 5.1.6 of Train B RPS testing procedure 3-SMI-049.02B step which opens the Reactor Trip Bypass breaker B, Unit 3 experienced an automatic reactor trip. A review of the Sequence of Events report following the trip revealed the first alarm in was Turbine Trip HDR Pressure Channels, followed by Reactor Trip Relays 9 and 10, and then Reactor Trip Breakers A and B Trip. The SOE report demonstrates that the initiating event of the Reactor Trip was Turbine Trip which is driven by the 94/AST (primary) and 94/ASB (backup) relays. The Reactor Trip Breaker B and Bypass Breaker B provide trip logic to the 94/ASB relay.

Potential Cause	Discussion	Supporting / Refuting Evidence	Evidence Status / Source	Cause
		<p><i>life of the cell components could be extended. The end of life condition of these components is not known.</i></p> <p><i>The switch that is used as the cell switch is the same switch used as an auxiliary switch on the DB breaker with a qualified life of 4,000 cycles on the DB-50 breaker. The remaining components of the cell switch consist of a metal frame, a metal operations bar and a metal return spring. None of these components are sensitive to age within 100 cycles.</i></p> <p>In addition, response from Robinson Nuclear regarding PM strategy on cell switches revealed they previously had a 12 year replacement PM which was subsequently retired to an 8 year</p>		



Support/Refute Matrix

Unit 3 Automatic Reactor Trip during restoration from B Train RPS testing 3-SMI-049.02B

Problem statement: During restoration step 5.1.6 of Train B RPS testing procedure 3-SMI-049.02B step which opens the Reactor Trip Bypass breaker B, Unit 3 experienced an automatic reactor trip. A review of the Sequence of Events report following the trip revealed the first alarm in was Turbine Trip HDR Pressure Channels, followed by Reactor Trip Relays 9 and 10, and then Reactor Trip Breakers A and B Trip. The SOE report demonstrates that the initiating event of the Reactor Trip was Turbine Trip which is driven by the 94/AST (primary) and 94/ASB (backup) relays. The Reactor Trip Breaker B and Bypass Breaker B provide trip logic to the 94/ASB relay.

Potential Cause	Discussion	Supporting / Refuting Evidence	Evidence Status / Source	Cause
		inspection. D.C. Cook does not have a replacement PM and inspects their switches every refueling cycle.		
Inadequate inspection and cleaning of cell switch contacts during routine PM.	Improper cleaning of cell switch contacts can lead to grease hardening and dust accumulation, thereby resulting in tracking paths on the switch. This can result in switches which indicate closed when they are expected to be open.	Supporting Westinghouse forensic report noted that cell switches removed from the RTB cubicle were identified as having hardened grease on the contacts. This is indicative of improper cleaning and application of grease on the cell switch contacts. This condition most likely created a tracking path across normally closed cell switch #2 contact 1-2 when the breaker was racked in, resulting in a standing trip signal to the 94/ASB Turbine Trip relay.	Closed FAR 10 – forensics identified hardened grease on switch contacts	Root Cause –IAW 0-PME-049.01, steps for cleaning and lubricating cell switch contacts is conditional based, rather than prescriptive.



Support/Refute Matrix

Unit 3 Automatic Reactor Trip during restoration from B Train RPS testing 3-SMI-049.02B

Problem statement: During restoration step 5.1.6 of Train B RPS testing procedure 3-SMI-049.02B step which opens the Reactor Trip Bypass breaker B, Unit 3 experienced an automatic reactor trip. A review of the Sequence of Events report following the trip revealed the first alarm in was Turbine Trip HDR Pressure Channels, followed by Reactor Trip Relays 9 and 10, and then Reactor Trip Breakers A and B Trip. The SOE report demonstrates that the initiating event of the Reactor Trip was Turbine Trip which is driven by the 94/AST (primary) and 94/ASB (backup) relays. The Reactor Trip Breaker B and Bypass Breaker B provide trip logic to the 94/ASB relay.

Potential Cause	Discussion	Supporting / Refuting Evidence	Evidence Status / Source	Cause
		<p>0-PME-049.01 cell switch cleaning and application of grease is conditional and is left the judgement of the journeyman performing the inspection. Discussions with previous maintenance personnel noted that the switches are difficult to get to even with a clearance on the equipment established, which may be prohibitive to cleaning and inspecting.</p> <p>Refuting</p> <p>Breaker and cubicle inspection procedure 0-PME-049.01 includes steps to remove switch cover and inspect contacts for cleanliness. Cleaning and lubrication is performed as required. Resistance across</p>		



Support/Refute Matrix

Unit 3 Automatic Reactor Trip during restoration from B Train RPS testing 3-SMI-049.02B

Problem statement: During restoration step 5.1.6 of Train B RPS testing procedure 3-SMI-049.02B step which opens the Reactor Trip Bypass breaker B, Unit 3 experienced an automatic reactor trip. A review of the Sequence of Events report following the trip revealed the first alarm in was Turbine Trip HDR Pressure Channels, followed by Reactor Trip Relays 9 and 10, and then Reactor Trip Breakers A and B Trip. The SOE report demonstrates that the initiating event of the Reactor Trip was Turbine Trip which is driven by the 94/AST (primary) and 94/ASB (backup) relays. The Reactor Trip Breaker B and Bypass Breaker B provide trip logic to the 94/ASB relay.

Potential Cause	Discussion	Supporting / Refuting Evidence	Evidence Status / Source	Cause
		contacts is also measured to be less than 1 ohm.		
EQUIPMENT				
Reactor Trip Breaker/Cubicle Malfunction				
Reactor Trip Breaker B bounced out of position during opening of Bypass breaker B.	If the Reactor Trip Breaker B and its associated aux contacts 'bounce out' and momentarily change state with Bypass breaker B open, trip logic to the 94/ASB relay is made	Refuted Review of DB-50 breaker OE did not reveal any instances of these model breakers bouncing out of position. FAR 02 did not reveal any abnormalities.	Closed WO: 40766915 FAR 01 - SAT FAR 02 - SAT	Not a Cause



Support/Refute Matrix

Unit 3 Automatic Reactor Trip during restoration from B Train RPS testing 3-SMI-049.02B

Problem statement: During restoration step 5.1.6 of Train B RPS testing procedure 3-SMI-049.02B step which opens the Reactor Trip Bypass breaker B, Unit 3 experienced an automatic reactor trip. A review of the Sequence of Events report following the trip revealed the first alarm in was Turbine Trip HDR Pressure Channels, followed by Reactor Trip Relays 9 and 10, and then Reactor Trip Breakers A and B Trip. The SOE report demonstrates that the initiating event of the Reactor Trip was Turbine Trip which is driven by the 94/AST (primary) and 94/ASB (backup) relays. The Reactor Trip Breaker B and Bypass Breaker B provide trip logic to the 94/ASB relay.

Potential Cause	Discussion	Supporting / Refuting Evidence	Evidence Status / Source	Cause
	up and can cause Turbine Trip.			
Reactor Trip Breaker B pushbutton trip binding with lock-out tabs.	The Reactor Trip Breakers are equipped with lockout tabs that surround the face of pushbutton trip on the front of the breaker. Site experience has demonstrated that binding of the lockout tabs with the pushbutton trip can occur, preventing the trip pushbutton from fully seating back to its	Refuted Forensic investigation performed by Westinghouse has not found any evidence of binding between the trip pushbutton and the lockout tabs. The breaker has been cycled numerous times without issues. FAR 03 - performed a partial breaker inspection on the bench IAW sections of 0-PME 049.01 and found no evidence of binding. FAR 06 performed numerous cycling of the breaker once removed from the cubicle and found no	Closed WO: 40766915 FAR 03 – SAT FAR 06 - SAT FAR 10 – Forensic results find no evidence of binding between trip pushbutton and lockout tabs.	Not a Cause



Support/Refute Matrix

Unit 3 Automatic Reactor Trip during restoration from B Train RPS testing 3-SMI-049.02B

Problem statement: During restoration step 5.1.6 of Train B RPS testing procedure 3-SMI-049.02B step which opens the Reactor Trip Bypass breaker B, Unit 3 experienced an automatic reactor trip. A review of the Sequence of Events report following the trip revealed the first alarm in was Turbine Trip HDR Pressure Channels, followed by Reactor Trip Relays 9 and 10, and then Reactor Trip Breakers A and B Trip. The SOE report demonstrates that the initiating event of the Reactor Trip was Turbine Trip which is driven by the 94/AST (primary) and 94/ASB (backup) relays. The Reactor Trip Breaker B and Bypass Breaker B provide trip logic to the 94/ASB relay.

Potential Cause	Discussion	Supporting / Refuting Evidence	Evidence Status / Source	Cause
	shelf state and placing the breaker in a trip-sensitive state whereby a shock or vibration can cause the breaker to trip open from a closed state.	issues with mechanical binding or resistance.		
Reactor Trip Breaker B aux contact malfunctioned and dropped load.	A malfunction of Reactor Trip Breaker B aux contact 13-14b following opening of the Bypass B breaker would cause an actuation of the 94/ASB relay and	Refuting Review of SOE report indicates first alarm in was Turbine Trip, not Reactor Trip breakers. This indicates breaker malfunction was not the initiating event. FAR 03 - performed a partial breaker inspection on the bench IAW sections of 0-PME 049.01 and found no issues.	Closed WO: 40766915 FAR 03 - SAT FAR 05 - SAT FAR 06 - SAT FAR 10 -Breaker forensic testing	Not a Cause



Support/Refute Matrix

Unit 3 Automatic Reactor Trip during restoration from B Train RPS testing 3-SMI-049.02B

Problem statement: During restoration step 5.1.6 of Train B RPS testing procedure 3-SMI-049.02B step which opens the Reactor Trip Bypass breaker B, Unit 3 experienced an automatic reactor trip. A review of the Sequence of Events report following the trip revealed the first alarm in was Turbine Trip HDR Pressure Channels, followed by Reactor Trip Relays 9 and 10, and then Reactor Trip Breakers A and B Trip. The SOE report demonstrates that the initiating event of the Reactor Trip was Turbine Trip which is driven by the 94/AST (primary) and 94/ASB (backup) relays. The Reactor Trip Breaker B and Bypass Breaker B provide trip logic to the 94/ASB relay.

Potential Cause	Discussion	Supporting / Refuting Evidence	Evidence Status / Source	Cause
	subsequent Turbine Trip.	FAR 05 and 06 – Aux contacts were inspected for proper change of state. Breaker was cycled 25 times without issues. FAR 10 – Forensics testing by Westinghouse did not find any evidence of aux contact failure. Contacts performed as expected 100% of the time.	did not identify any issues with the breaker aux contacts	
Loss of control power on Reactor Trip Breaker 'B' and Bypass Breaker 'B' UV Trip Circuit.	A loss of control power to the RTB and BYB breakers' control circuits would cause the UVTA coil to de-energize and trip the breakers, thereby	Refuted FAR 04 verified proper voltage at the UVTA coil for the Reactor Trip B Breaker.	Closed WO: 40766915 FAR 04 - SAT	Not a Cause



Support/Refute Matrix

Unit 3 Automatic Reactor Trip during restoration from B Train RPS testing 3-SMI-049.02B

Problem statement: During restoration step 5.1.6 of Train B RPS testing procedure 3-SMI-049.02B step which opens the Reactor Trip Bypass breaker B, Unit 3 experienced an automatic reactor trip. A review of the Sequence of Events report following the trip revealed the first alarm in was Turbine Trip HDR Pressure Channels, followed by Reactor Trip Relays 9 and 10, and then Reactor Trip Breakers A and B Trip. The SOE report demonstrates that the initiating event of the Reactor Trip was Turbine Trip which is driven by the 94/AST (primary) and 94/ASB (backup) relays. The Reactor Trip Breaker B and Bypass Breaker B provide trip logic to the 94/ASB relay.

Potential Cause	Discussion	Supporting / Refuting Evidence	Evidence Status / Source	Cause
	causing actuation of the 94/ASB and subsequent Turbine Trip			
Loose wiring in Reactor Trip B or Bypass B breaker cubicles.	Loose wiring in Reactor Trip B or Bypass B breaker cubicles can cause unexpected actuation of circuit interlocks when the Bypass B breaker was open.	Refuted FAR 07 inspected wiring inside the Reactor Trip B and Bypass B breaker cubicles and found no loose wires.	Closed WO: 40766915 FAR 07 - SAT	Not a Cause
Reactor Trip B Breaker cell switch malfunction.	The cell switch changes state when the breaker is racked in and out of the cubicle. If the cell	Supporting Westinghouse Maintenance Program Manual (MPM) recommends a service life of 100 cycles for cell switches. Cell	Closed FAR 10 – forensic testing of removed cell switches in	Direct Cause



Support/Refute Matrix

Unit 3 Automatic Reactor Trip during restoration from B Train RPS testing 3-SMI-049.02B

Problem statement: During restoration step 5.1.6 of Train B RPS testing procedure 3-SMI-049.02B step which opens the Reactor Trip Bypass breaker B, Unit 3 experienced an automatic reactor trip. A review of the Sequence of Events report following the trip revealed the first alarm in was Turbine Trip HDR Pressure Channels, followed by Reactor Trip Relays 9 and 10, and then Reactor Trip Breakers A and B Trip. The SOE report demonstrates that the initiating event of the Reactor Trip was Turbine Trip which is driven by the 94/AST (primary) and 94/ASB (backup) relays. The Reactor Trip Breaker B and Bypass Breaker B provide trip logic to the 94/ASB relay.

Potential Cause	Discussion	Supporting / Refuting Evidence	Evidence Status / Source	Cause
	switch for the Reactor Trip B breaker cubicle did not properly change state when breaker was racked in, it would make up the logic to actuate the 94/ASB relay once the Bypass breaker B is opened.	switches are not normally replaced as part of routine maintenance. However, they are inspected. Forensics results. FAR 10 - Westinghouse forensics testing noted that the cell switches were most likely original plant equipment and were not properly maintained. The switch contacts had hardened grease, the switch plunger had foreign lubrication applied, and the return springs lacked lubrication. Testing of the left cell switch identified a failed 7-8 Normally Open contact. This contact remained open with both the plunger actuated and not actuated. Testing of the right cell switch identified the same failure mode for the 3-4	RTB cubicle will be performed by Westinghouse.	



Support/Refute Matrix

Unit 3 Automatic Reactor Trip during restoration from B Train RPS testing 3-SMI-049.02B

Problem statement: During restoration step 5.1.6 of Train B RPS testing procedure 3-SMI-049.02B step which opens the Reactor Trip Bypass breaker B, Unit 3 experienced an automatic reactor trip. A review of the Sequence of Events report following the trip revealed the first alarm in was Turbine Trip HDR Pressure Channels, followed by Reactor Trip Relays 9 and 10, and then Reactor Trip Breakers A and B Trip. The SOE report demonstrates that the initiating event of the Reactor Trip was Turbine Trip which is driven by the 94/AST (primary) and 94/ASB (backup) relays. The Reactor Trip Breaker B and Bypass Breaker B provide trip logic to the 94/ASB relay.

Potential Cause	Discussion	Supporting / Refuting Evidence	Evidence Status / Source	Cause
		Normally Open contact. Although these failure modes would have been inconsequential in the Reactor Trip Switchgear given these contacts are not wired out to the plant, it is indicative of wear and aging of the cell switch. The most probable direct cause is a tracking path created on the old hardened grease on the 1-2 Normally Closed contact that made up the trip logic to the 94/ASB turbine trip relay once the BYB breaker was opened. FAR 07 replaced cell switches for the Reactor Trip B cubicle.		
Excessive grease on breaker aux contacts.	OE review has identified an event where excessive	Refuting evidence	Closed FAR 03 - SAT	Not a Cause



Support/Refute Matrix

Unit 3 Automatic Reactor Trip during restoration from B Train RPS testing 3-SMI-049.02B

Problem statement: During restoration step 5.1.6 of Train B RPS testing procedure 3-SMI-049.02B step which opens the Reactor Trip Bypass breaker B, Unit 3 experienced an automatic reactor trip. A review of the Sequence of Events report following the trip revealed the first alarm in was Turbine Trip HDR Pressure Channels, followed by Reactor Trip Relays 9 and 10, and then Reactor Trip Breakers A and B Trip. The SOE report demonstrates that the initiating event of the Reactor Trip was Turbine Trip which is driven by the 94/AST (primary) and 94/ASB (backup) relays. The Reactor Trip Breaker B and Bypass Breaker B provide trip logic to the 94/ASB relay.

Potential Cause	Discussion	Supporting / Refuting Evidence	Evidence Status / Source	Cause
	grease on breaker aux contacts caused a unit trip to occur.	<p>This failure mode would not explain the trip event. The concern with excess grease is creating an open circuit in closed contact. The trip event would require an unexpected closed circuit in an open contact. Also, breaker inspection 0-PME-049.01 instructs to apply a small amount of grease on aux contact surfaces.</p> <p>FAR 03 performed a partial inspection of the RTB breaker IAW 0-PME-049.01. Aux contacts were inspected per section 4.19. No anomalies were identified. Resistance readings were</p> <p>0.2 Ohms or lower which indicates no concerns for excessive grease.</p>		

RPS Trip Relays RT-9/RT-10 Malfunction



Support/Refute Matrix

Unit 3 Automatic Reactor Trip during restoration from B Train RPS testing 3-SMI-049.02B

Problem statement: During restoration step 5.1.6 of Train B RPS testing procedure 3-SMI-049.02B step which opens the Reactor Trip Bypass breaker B, Unit 3 experienced an automatic reactor trip. A review of the Sequence of Events report following the trip revealed the first alarm in was Turbine Trip HDR Pressure Channels, followed by Reactor Trip Relays 9 and 10, and then Reactor Trip Breakers A and B Trip. The SOE report demonstrates that the initiating event of the Reactor Trip was Turbine Trip which is driven by the 94/AST (primary) and 94/ASB (backup) relays. The Reactor Trip Breaker B and Bypass Breaker B provide trip logic to the 94/ASB relay.

Potential Cause	Discussion	Supporting / Refuting Evidence	Evidence Status / Source	Cause
Reactor Trip Relays RT-9 and RT-10 actuate due to Pressurizer High Water Level, causing Reactor Trip.	Although SOE reports first alarm in was from Turbine Trip, time stamps for Turbine Trip Signals and RT 9 and 10 actuating are within milliseconds. There is a very small possibility RT 9 and 10 actuated first.	Refuted Absence of Pressurizer High Level alarm in SOE report. PI tag PZHLTR23_A does not insert prior to event.	Closed Review of PI and SOE did not indicate PRZ High Level.	Not a Cause
Reactor Trip Relays RT-9 and RT-10 actuate due to Pressurizer Low Water Level, causing Reactor Trip.	Although SOE reports first alarm in was from Turbine Trip, time stamps for Turbine Trip Signals and RT 9 and 10 actuating are within milliseconds.	Refuted Absence of Pressurizer High Level alarm in SOE report. PI tag PZHLTR23_A does not insert prior to event.	Closed Review of PI and SOE did not indicate PRZ Low Level.	Not a Cause



Support/Refute Matrix

Unit 3 Automatic Reactor Trip during restoration from B Train RPS testing 3-SMI-049.02B

Problem statement: During restoration step 5.1.6 of Train B RPS testing procedure 3-SMI-049.02B step which opens the Reactor Trip Bypass breaker B, Unit 3 experienced an automatic reactor trip. A review of the Sequence of Events report following the trip revealed the first alarm in was Turbine Trip HDR Pressure Channels, followed by Reactor Trip Relays 9 and 10, and then Reactor Trip Breakers A and B Trip. The SOE report demonstrates that the initiating event of the Reactor Trip was Turbine Trip which is driven by the 94/AST (primary) and 94/ASB (backup) relays. The Reactor Trip Breaker B and Bypass Breaker B provide trip logic to the 94/ASB relay.

Potential Cause	Discussion	Supporting / Refuting Evidence	Evidence Status / Source	Cause
	There is a very small possibility RT 9 and 10 actuated first.			
Reactor Trip Relays RT-9 and RT-10 actuate due to Power Range Hi Flux, causing Reactor Trip.	Although SOE reports first alarm in was from Turbine Trip, time stamps for Turbine Trip Signals and RT 9 and 10 actuating are within milliseconds. There is a very small possibility RT 9 and 10 actuated first.	Refuted Absence of Pressurizer High Level alarm in SOE report. PI tag NIPWRHTP_A does not insert prior to event.	Closed Review of PI and SOE did not indicate Power Range Hi Flux.	Not a Cause
Failure/malfunction of RT 9 and RT 10 relays.	A failure of Reactor Trip Relays RT 9 and 10 would cause a trip	Refuted Subject relays were tested SAT under WO 40766903-01 as part of U3 Train B RPS	Closed WO 40766903-01 SAT	Not a Cause



Support/Refute Matrix

Unit 3 Automatic Reactor Trip during restoration from B Train RPS testing 3-SMI-049.02B

Problem statement: During restoration step 5.1.6 of Train B RPS testing procedure 3-SMI-049.02B step which opens the Reactor Trip Bypass breaker B, Unit 3 experienced an automatic reactor trip. A review of the Sequence of Events report following the trip revealed the first alarm in was Turbine Trip HDR Pressure Channels, followed by Reactor Trip Relays 9 and 10, and then Reactor Trip Breakers A and B Trip. The SOE report demonstrates that the initiating event of the Reactor Trip was Turbine Trip which is driven by the 94/AST (primary) and 94/ASB (backup) relays. The Reactor Trip Breaker B and Bypass Breaker B provide trip logic to the 94/ASB relay.

Potential Cause	Discussion	Supporting / Refuting Evidence	Evidence Status / Source	Cause
	of the Reactor Trip Breakers.	Logic Testing. Both relays would have to fail simultaneously to cause reactor trip.		
94/ASB Inadvertent Actuation				
94/ASB Backup Turbine Trip relay was actuated from an AMSAC signal.	AMSAC initiation would lead to an actuation of the 94/ASB relay and subsequent Turbine Trip.	Refuted A review of SOE report shows no AMSAC alarm at the time of the Reactor Trip. PI trends also show no AMSAC actuation at the time of trip.	Closed Review of PI and SOE did not indicate AMSAC actuation at the time of reactor trip.	Not a Cause



Support/Refute Matrix

Unit 3 Automatic Reactor Trip during restoration from B Train RPS testing 3-SMI-049.02B

Problem statement: During restoration step 5.1.6 of Train B RPS testing procedure 3-SMI-049.02B step which opens the Reactor Trip Bypass breaker B, Unit 3 experienced an automatic reactor trip. A review of the Sequence of Events report following the trip revealed the first alarm in was Turbine Trip HDR Pressure Channels, followed by Reactor Trip Relays 9 and 10, and then Reactor Trip Breakers A and B Trip. The SOE report demonstrates that the initiating event of the Reactor Trip was Turbine Trip which is driven by the 94/AST (primary) and 94/ASB (backup) relays. The Reactor Trip Breaker B and Bypass Breaker B provide trip logic to the 94/ASB relay.

Potential Cause	Discussion	Supporting / Refuting Evidence	Evidence Status / Source	Cause
94/ASB Backup Turbine Trip relay was actuated from Feedwater Isolation signal.	A Feedwater Isolation signal would lead to an actuation of the 94/ASB relay and subsequent Turbine Trip.	Refuted A review of SOE report shows no Feedwater Isolation alarm at the time of the Reactor Trip. PI trends also show no Feedwater Isolation actuation at the time of trip.	Closed Review of PI and SOE did not indicate Feedwater Isolation actuation at the time of reactor trip.	Not a Cause
94/ASB Backup Turbine Trip relay was actuated from a Generator Lockout signal.	A Generator Lockout signal would lead to an actuation of the 94/ASB relay and signal.	Refuted A review of SOE report shows no Generator Lockout alarm at the time of the Reactor Trip. PI trends also show no GENLORLY_A actuation at the time of trip.	Closed Review of PI and SOE did not indicate Generator Lockout actuation	Not a Cause



Support/Refute Matrix

Unit 3 Automatic Reactor Trip during restoration from B Train RPS testing 3-SMI-049.02B

Problem statement: During restoration step 5.1.6 of Train B RPS testing procedure 3-SMI-049.02B step which opens the Reactor Trip Bypass breaker B, Unit 3 experienced an automatic reactor trip. A review of the Sequence of Events report following the trip revealed the first alarm in was Turbine Trip HDR Pressure Channels, followed by Reactor Trip Relays 9 and 10, and then Reactor Trip Breakers A and B Trip. The SOE report demonstrates that the initiating event of the Reactor Trip was Turbine Trip which is driven by the 94/AST (primary) and 94/ASB (backup) relays. The Reactor Trip Breaker B and Bypass Breaker B provide trip logic to the 94/ASB relay.

Potential Cause	Discussion	Supporting / Refuting Evidence	Evidence Status / Source	Cause
	subsequent Turbine Trip.		at the time of reactor trip.	
94/ASB Backup Turbine Trip relay was actuated from inadvertent pushbutton trip.	An inadvertent actuation of the Pushbutton Trip would lead to an actuation of the 94/ASB relay and subsequent Turbine Trip.	Refuted Review of PI point TMANPBCO_A did not assert prior or during reactor trip.	Closed PI traces show no actuation of Pushbutton Trip.	Not a Cause



Support/Refute Matrix

Unit 3 Automatic Reactor Trip during restoration from B Train RPS testing 3-SMI-049.02B

Problem statement: During restoration step 5.1.6 of Train B RPS testing procedure 3-SMI-049.02B step which opens the Reactor Trip Bypass breaker B, Unit 3 experienced an automatic reactor trip. A review of the Sequence of Events report following the trip revealed the first alarm in was Turbine Trip HDR Pressure Channels, followed by Reactor Trip Relays 9 and 10, and then Reactor Trip Breakers A and B Trip. The SOE report demonstrates that the initiating event of the Reactor Trip was Turbine Trip which is driven by the 94/AST (primary) and 94/ASB (backup) relays. The Reactor Trip Breaker B and Bypass Breaker B provide trip logic to the 94/ASB relay.

Potential Cause	Discussion	Supporting / Refuting Evidence	Evidence Status / Source	Cause
Malfunction of 94/ASB relay causing inadvertent Turbine Trip.	A malfunctioning 94/ASB relay can cause an inadvertent Turbine Trip actuation.	Refuted Relay was tested and replaced recently during PT3-31 under WO 41542117-02. Likelihood of relay malfunctioning at the same time the Bypass B breaker was opened, with the relay located in a completely separate cabinet (3C89C).	Closed	Not a Cause



Attachment 6: Barrier Analysis

Hazard	Barrier	Assessment (Missing Barrier, Barrier Not Used, Inadequate Barrier, Successful Barrier)	Target	Insights
Quarterly Reactor Trip Testing performed IAW 3-SMI-049.02B results in a reactor trip	<u>Design Barrier</u> Train Separation / Channel Redundancy	RPS system is designed with redundant trains and channels to allow for successful testing online. Successful Barrier	Successful surveillance test without automatic reactor trip.	NA
	<u>Physical Barrier</u> Plastic Barrier on Reactor Trip Breakers	Surveillance procedure instructs personnel to place plastic barrier over RTB faceplate when manipulating BYB breaker Successful Barrier		NA
	<u>Administrative Barrier</u> Surveillance Testing Procedure	The subject RPS test is performed in accordance with 3-SMI-049.02B which provides a methodical and proven approach to testing which has been successfully performed in the past. Successful Barrier		NA
	<u>Administrative Barrier</u>	I&C Journeymen performing the work have proper training and		NA



Hazard	Barrier	Assessment (Missing Barrier, Barrier Not Used, Inadequate Barrier, Successful Barrier)	Target	Insights
	<p>Training and Qualifications</p> <hr/> <p><u>Administrative Barrier</u></p> <p>Review and incorporation of fleet OE</p>	<p>qualifications to perform surveillance testing.</p> <p>Successful Barrier</p> <hr/> <p>Point Beach modified their Reactor Trip and Trip Bypass breaker circuits circa 1984 in response to Generic Letter 83-28 to meet the Westinghouse Owner's Group (WOG) recommendations. The modification included test points upstream of their turbine trip relay. However, these test points were not part of the WOG recommendations. Therefore, these test points were a unique PB design. This is considered a legacy issue and would not have been identified as part of OE reviews.</p> <p>Barrier Not Used</p>		<p>The installation of the test points would have provided a means of detecting a malfunction with the reactor trip breaker. This was not root to the issue but contributed to it.</p> <p>CC1 - Test points to detect failed contacts were not installed.</p>
Westinghouse DB-50 Breaker and Cubicle Maintenance is	<u>Administrative:</u> Procedural inspections	DB-50 breakers and switchgear cubicles are inspected in accordance with 0-PME-049.01 which provides a methodical	Breakers and cubicle perform reliably without issues	RC1 - IAW 0-PME-049.01, steps for cleaning and lubricating cell switch contacts is conditional



Hazard	Barrier	Assessment (Missing Barrier, Barrier Not Used, Inadequate Barrier, Successful Barrier)	Target	Insights
inadequate to prevent breaker or cubicle reliability issues		and proven approach to maintain the equipment. However, steps to clean and lubricate the cell switch contacts located inside the cubicle are conditional based, rather than prescriptive. This can lead to lack of proper cleaning of the cell switch and relies on skill of the craft and judgement of the journeyman performing the inspection. Inadequate Barrier		based, rather than prescriptive.
	<u>Administrative Barrier</u> Preventive Maintenance Program Established	Reactor Trip and Bypass breakers, and cubicles are inspected on an 18-month frequency which meets Westinghouse MPM-DB recommendations of no more than 24 months. Each breaker cubicle has a unique PMID established in NAMS to track and drive work. Successful Barrier		NA



Hazard	Barrier	Assessment (Missing Barrier, Barrier Not Used, Inadequate Barrier, Successful Barrier)	Target	Insights
	<u>Administrative Barrier</u> Training and Qualifications	Electrical Maintenance journeymen are properly trained and maintain required qualifications to work on DB-50 breakers and switchgears. Successful Barrier		NA
	<u>Administrative Barrier</u> Vendor Recommendations Incorporated.	Procedure 0-PME-049.01 was developed using Westinghouse vendor manual V000211, and Westinghouse Maintenance Program Manual MPM-DB for Safety Related DB-50 Circuit Breakers and Associated Switchgear, E224A. All criteria in the site procedure meet vendor recommendations, with the exception of cell switch recommended life. Procedure does not check for cell switch cycles. There is no established PM for cell switch replacement. Inadequate Barrier		Forensics performed by vendor Westinghouse on the two removed cell switches noted that the switches appeared to be original plant equipment. The contacts had hardened grease, a foreign lubrication on the plunger rod, and no lubrication on the return spring. This is indicative of no maintenance performed on these components. Additionally, testing of the two cell switches identified one failed Normally Open contact in each switch. The contacts remained in the Open state when the plunger was either actuated or not actuated. Although this failure mode



Hazard	Barrier	Assessment (Missing Barrier, Barrier Not Used, Inadequate Barrier, Successful Barrier)	Target	Insights
				<p>would not have resulted in a unit trip, it is indicative of an age related failure.</p> <p>CC2 - Failure to follow WEC MPM cell switch maintenance and replacement frequency</p>

Attachment 7: Event and Causal Factor (E&CF) Analysis

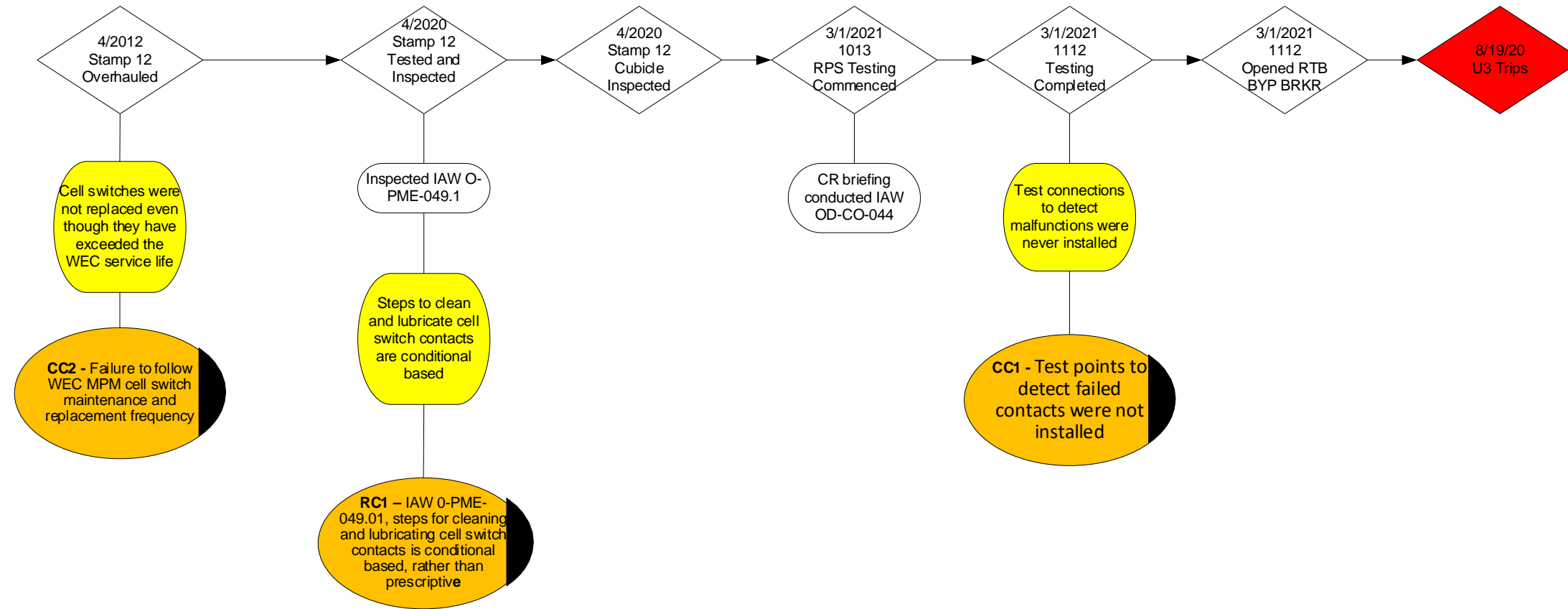



Attachment 8: Organizational and Programmatic (O&P) Analysis

Causal Factor Categorization Analysis:

People

Summary:

The Root Cause Evaluation team did not identify any human performance or people related issues that contributed to this event.

Discussion:

As detailed in the Training Analysis, Barrier Analysis, and the Support/Refute Matrix, there were no people related issues identified.

Organizational

Summary:

The Root Cause Evaluation team did not identify any human performance or People related issues that contributed to this event.

Discussion:

As detailed in the Training Analysis, Barrier Analysis, and the Support/Refute Matrix, there were no Organizational related issues identified.

Programmatic

Summary:

Inadequate procedure steps for cell switch lubrication, implementation of WEC recommendations and the failure to install test points were all Programmatic issues.

Discussion:

RC1 – IAW 0-PME-049.01, steps for cleaning and lubricating cell switch contacts is conditional based, rather than prescriptive.

CC1 - Failure to incorporate PB/GL 83-28 action of installing test points

Causal Factor Characterization		
Cause Type	Cause Statement	Category



Root Cause (RC1)	RC1 - IAW 0-PME-049.01, steps for cleaning and lubricating cell switch contacts is conditional based, rather than prescriptive	Programmatic
Contributing Cause (CC1)	CC1 - Test points to detect failed contacts were not installed	Programmatic
Contributing Cause (CC2)	CC2 - Failure to follow WEC MPM cell switch maintenance and replacement frequency	Programmatic



Attachment 9: Safety Culture (SC) Analysis

06.01 Human Performance (H)

#	Criteria	Comment
H.1	Resources: Leaders ensure that personnel, equipment, procedures, and other resources are available and adequate to support nuclear safety (LA.1).	This is directly tied to RC1.
H.2	Field Presence: Leaders are commonly seen in the work areas of the plant observing, coaching, and reinforcing standards and expectations. Deviations from standards and expectations are corrected promptly. Senior managers ensure supervisory and management oversight of work activities, including contractors and supplemental personnel (LA.2).	Not observed.
H.3	Change Management: Leaders use a systematic process for evaluating and implementing change so that nuclear safety remains the overriding priority (LA.5).	Not observed.
H.4	Teamwork: Individuals and work groups communicate and coordinate their activities within and across organizational boundaries to ensure nuclear safety is maintained (PA.3).	Not observed.
H.5	Work Management: The organization implements a process of planning, controlling, and executing work activities such that nuclear safety is the overriding priority. The work process includes the identification and management of risk commensurate to the work and the need for coordination with different groups or job activities (WP.1).	Not observed.
H.6	Design Margins: The organization operates and maintains equipment within design margins. Margins are carefully guarded and changed only through a systematic and rigorous process. Special attention is placed on maintaining fission product barriers, defense-in-depth, and safety related equipment (WP.2).	Not observed.
H.7	Documentation: The organization creates and maintains complete, accurate and, up-to-date documentation (WP.3).	Not observed.
H.8	Procedure Adherence: Individuals follow processes, procedures, and work instructions (WP.4).	Not observed.
H.9	Training: The organization provides training and ensures knowledge transfer to maintain a knowledgeable, technically competent workforce and instill nuclear safety values (CL.4).	Not observed.
H.10	Bases for Decisions: Leaders ensure that the bases for operational and organizational decisions are communicated in a timely manner (CO.2).	Not observed.
H.11	Challenge the Unknown: Individuals stop when faced with uncertain conditions. Risks are evaluated and managed before proceeding (QA.2).	Not observed.



H.12	Avoid Complacency: Individuals recognize and plan for the possibility of mistakes, latent issues, and inherent risk, even while expecting successful outcomes. Individuals implement appropriate error reduction tools (QA.4).	Not observed.
H.13	Consistent Process: Individuals use a consistent, systematic approach to make decisions. Risk insights are incorporated as appropriate (DM.1).	Not observed.
H.14	Conservative Bias: Individuals use decision making practices that emphasize prudent choices over those that are simply allowable. A proposed action is determined to be safe in order to proceed, rather than unsafe in order to stop (DM.2).	Not observed.

06.02 Problem Identification and Resolution (P)

#	Criteria	Comment
P.1	Identification: The organization implements a corrective action program with a low threshold for identifying issues. Individuals identify issues completely, accurately, and in a timely manner in accordance with the program (PI.1).	Not observed.
P.2	Evaluation: The organization thoroughly evaluates issues to ensure that resolutions address causes and extent of conditions commensurate with their safety significance (PI.2).	Not observed.
P.3	Resolution: The organization takes effective corrective actions to address issues in a timely manner commensurate with their safety significance (PI.3).	Not observed.
P.4	Trending: The organization periodically analyzes information from the corrective action program and other assessments in the aggregate to identify programmatic and common cause issues (PI.4).	Not observed.
P.5	Operating Experience: The organization systematically and effectively collects, evaluates, and implements relevant internal and external operating experience in a timely manner (CL.1).	Not observed.
P.6	Self-Assessment: The organization routinely conducts self-critical and objective assessments of its programs and practices (CL.2).	Not observed.



Attachment 10: Corrective Action Line of Sight (LOS) Table

<p>Event Description</p> <p>On March 1, 2021 at 1112, Unit 3 experienced an unplanned automatic reactor trip during restoration of the 3B Reactor Protection System Logic Test, 3-SMI-049.02B (AR 2385529, WR 94220021). During performance of the SMI, the 3B Reactor Trip Bypass Breaker (BYB) is closed. As part of the restoration, the 3B Reactor Trip Breaker (RTB) breaker (Stamp 12) is closed and the BYB is locally tripped. When the BYB was tripped open, Unit 3 experienced an automatic reactor trip.</p>
<p>Extent of Condition</p> <p>U4 Reactor Trip and Bypass Breaker Cell Switches, CRDM MG Set Output Breaker Cubicle Cell Switches, and Main Generator Field Breaker Cubicle Cell Switches (Breaker Model DS-206).</p>

Cause	Extent of Cause	Corrective Actions CAPRs and Related CAs	Effectiveness Review
<p>RC1 - IAW 0-PME-049.01, steps for cleaning and lubricating cell switch contacts is conditional based, rather than prescriptive.</p>	<p>CRDM MG Set Output Breaker Cubicle Cell Switch and Main Generator Field Breaker Cubicle Cell Switch inspection procedures</p>	<p>CAPR1 - Revise procedure 0-PME-049.01 to require cleaning and lubrication of cell switch contacts.</p> <p>RC1 EOCa CA1 - Review maintenance procedures for CRDM MG set output breaker and Generator Field breaker cubicles inspections and ensure cleaning of cell switch</p>	<p>Method - Review of U3 and U4 reactor trip breaker and bypass breaker cell switch inspection results.</p> <p>Attributes - Cell switches have been adequately lubricated.</p> <p>Success Criteria - All of U3 and U3 Reactor Trip and Trip</p>



		<p>contacts (if installed) is prescriptive. Revise procedures as necessary.</p> <p>RC1 EOCa CA2 - Review maintenance procedures for CRDM MG set output breaker and Generator Field breaker cubicles inspections for other conditional steps, which if not performed, can result in equipment failure. Revise procedures as necessary.</p> <p>CC1 EOC CA1 - Investigate whether a similar vulnerability exists for CRDM MG set output breaker and Generator Field breaker control circuits. Initiate ECs to install test points if necessary.</p> <p>CC2 EOC CA1 - Create new PMID for CRDM MG set output breaker and Generator Field breaker cubicle cell switch replacements as necessary.</p>	<p>Bypass Breakers have new PMIDs for cell switch are properly lubricated</p>
--	--	--	---



		<p>CC2 EPC CA2 - Review Westinghouse Maintenance Program Manual (MPM) and ensure all components used for CRDM MG set output breaker and Generator Field applications have a maintenance strategy established commensurate with the MPM.</p>	
--	--	--	--



Attachment 11: List of Documents Reviewed

Document #	Title
PI-AA-100-1005	Root Cause Analysis
PI-AA-104-1000	Condition Reporting
PI-AA-102-1001	Operating Experience Program Screening and Responding to Incoming Operating Experience
PTN 1507092	Inspect Reactor Trip Breaker OJT-TPE
PTN 1518092	Reactor Trip Breakers Lesson Plan
PTN ICM	RPS Logic Test JITT
Westinghouse MBM	Safety Related Type DB Breakers and Associated Switchgear
NAP-418	Equipment Repair and Refurbishment
0-ADM-115	Notification of Plant Events
0-ADM-511	Post Trip Review (PTR)
INPO	INPO OE Search Program
3-SMI-049-02B	3B Reactor Protection System Logic Test
0-PME-09.01	RTB Cubicle and Breaker Inspections
ODI-CO-044	Operations Pre-Job Briefs



Attachment 12: Industry Maintenance Practices on Cell Switches

INDUSTRY MAINTENANCE PRACTICES FOR DB-50 SWITCHGEAR CELL SWITCHES				
PLANT	INSPECTION PM FRQ	REPLACEMENT PM FRQ	INSPECTION INCLUDES:	COMMENTS
Turkey Point	18M	N/A	<ul style="list-style-type: none"> • Cover removal • Verification of clean switch contacts • If contacts require cleaning or lubrication, then: <ul style="list-style-type: none"> ○ Clean contacts ○ Apply graphite grease 53701AN00T • Plunger actuation and confirmation of: <ul style="list-style-type: none"> ○ Correct contact configuration ○ Contact resistance 	When compared to two other plants listed below, PTN does not validate for free movement of plunger. Cleaning and application of graphite grease is conditional.
Robinson Nuclear Plant	8Y	N/A	<ul style="list-style-type: none"> • Cover removal • Plunger actuation and confirmation of: <ul style="list-style-type: none"> ○ Free movement ○ Proper contact operation ○ Presence of graphite grease on contacts • Application of 53701GW lubricant to spring and plunger penetration point • Removal of old graphite grease and reapplication if no grease is present. • Contact resistance checks with switch in OPEN and CLOSED position 	RNP previously had a 12Y replacement PM but was subsequently retired to inspection PM. Cleaning and application of graphite grease is conditional.
D.C. Cook	18M	N/A	<ul style="list-style-type: none"> • Switch removal from cubicle • Plunger actuation and confirmation of: <ul style="list-style-type: none"> ○ Free movement ○ Proper contact operation • Cleaning of switch • Inspection of switch contacts for: <ul style="list-style-type: none"> ○ Cracked cases 	D.C. Cook has no replacement PM for cell switches. Cleaning of switch is prescriptive. Application of graphite grease is conditional.



			<ul style="list-style-type: none"> ○ Burned or pitted contacts ○ Loss of silver plating (exposed copper) ● Replacement of switch IF binding, damaged, burned or pitted contacts, loss of silver plating ● Inspection for very light coating of graphite grease on switch contact segments (interface with fingers) 	
Sequoyah	36M	7RO	<ul style="list-style-type: none"> ● Switch removal from cubicle ● Inspect switch for: <ul style="list-style-type: none"> ○ Loose hardware ○ Loose wiring ○ Overheating ○ Burning and pitting of contacts ○ Cracking or abnormal wear of phenolic contact housing ● Plunger actuation and confirmation of: <ul style="list-style-type: none"> ○ Free movement ○ Proper contact operation ● Clean contacts to remove hardened grease ● Lubricate contacts and plunger ● Resistance checks across contacts (0.1ohm or less) 	The 7RO replacement frequency is based on the 100 cycle recommendation from the MPM and assumes 15 cycles per RO.



Enclosure 1

WESTINGHOUSE PROPRIETARY CLASS 2



Westinghouse Electric Company Nuclear Parts Operations New Stanton, Pennsylvania

Failure Analysis Report

Florida Power & Light Company Turkey
Point Nuclear Station
Purchase Order (PO): 02423936

Westinghouse Sales Order: 160387

Westinghouse was contacted on March 3rd concerning an experienced automatic reactor trip and was provided the following information:

"Background:

On 3/2/2021, with Unit 3 at 100% power, Turkey Point Nuclear was performing a scheduled Interlock, Logic and Actuation Test in Unit 3 Train B of Reactor Protection System (RPS). This test requires the 3B RPS reactor bypass breaker to be racked-in and closed, so that actuation tests could be performed on the 3B RPS reactor trip breaker, without initiating a reactor trip. Test restoration phase includes closing the 3B reactor trip breaker and, subsequently, opening the reactor bypass breaker. With the 3B reactor trip breaker closed, and right after opening of the 3B bypass breaker, Unit 3 experienced an automatic reactor trip. A failure investigation is ongoing and, although the condition has not been replicated, currently the investigation team suspects about an equipment-related stressor that may have affected the 3B reactor trip breaker performance; thus, causing the unanticipated reactor trip. The suspected reactor trip breaker has been removed from the field.

Request:

Turkey Point Nuclear requests from Westinghouse to conduct exhaustive inspection and testing, in order to identify an equipment related condition that could explain the scenario discussed above. It is requested that a formal Failure Analysis Report be transmitted to Turkey Point that includes: basis for testing methodology, test sequence and results (including pictures), conclusions, and recommendations. Upon test completion, Turkey Point Nuclear requests Westinghouse to conduct a Turkey Point-standard refurbishment/overhaul scope and return to Turkey Point Nuclear for future use."

The Reactor Trip Breaker was received at the Westinghouse New Stanton facility at the end of the day, March 10, 2021. Also received were 2, DB cell switch assemblies. The next morning the breaker and switches were unboxed and photographed and shown here.

WESTINGHOUSE PROPRIETARY CLASS 2

Failure Analysis Report

Purchase Order (PO): 02423936
Westinghouse Sales Order: 160387



As Received Front of Breaker



As Received Rear of Breaker



As Received Left Side of Breaker Platform



As Received Right Side of Breaker Platform

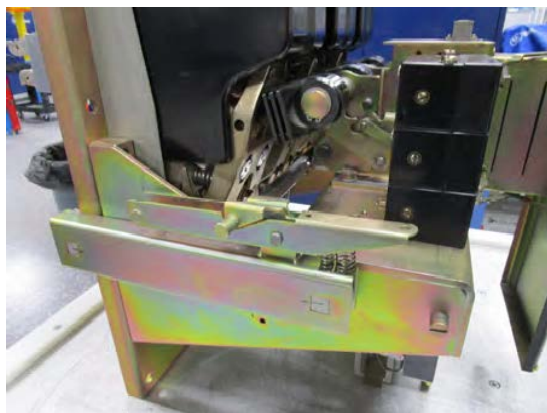

As Received Left Side of Breaker



As Received Right Side of Breaker

This breaker was received looking as it had just been refurbished, there were no visible areas of concern.

WESTINGHOUSE PROPRIETARY CLASS 2

Failure Analysis Report

Purchase Order (PO): 02423936
Westinghouse Sales Order: 160387



As Received Left-Side Cell Switch

As Received Right-Side Cell Switch

These cell switches were received and looked like they were the original switches provided with the switchgear. The switch plungers were improperly lubricated, and the plunger return spring was not lubricated.

An acceptable Purchase Order was received on March 16th and the investigation was initiated. 16-

Mar-21

Information collected from the breaker.

Breaker Shop Order Tag Number: 850.181-2
Breaker Serial Numbers: 880.510-3, 206.041-1 / IT-10 and 212.025-1 / IT-10

Customer Tag Information: Stamp 12 (4-20-2000)
CAT ID: 0000344772 1

UTC #: 0000402246

Operating Mechanism Serial Number: 212.025-1 / IT-10

Closing Solenoid Part Number: 28A2154G25
Closing Solenoid Coil Style Number: 300P606G01
Closing Solenoid Operating Voltage: 125 V DC

Control Relay Part Number: 2A10090G01
Control Relay Coil Style Number: 1529444
Control Relay Operating Voltage: 125 V DC
Control Relay Blow-Out Coil Style Number: 1589341

Shunt Trip Attachment (STA) Part Number: 508B504G01
STA Serial Number: 02YN222-083
STA Coil Style Number: 677C903G07
STA Operating Voltage: 125 V DC

WESTINGHOUSE PROPRIETARY CLASS 2

Failure Analysis Report

Purchase Order (PO): 02423936
Westinghouse Sales Order: 160387

Under Voltage Trip Attachment (UVTA) Part #: 5365C50G01
UVTA Coil Style Number: 677C903G07
UVTA Operating Voltage: 125 V DC

Cycle Counter Reading: 01699

After being refurbished, this breaker shipped from Westinghouse on 3-Jul-2012 with a counter reading of 01400. This breaker was cycled less than 300 times before being returned to Westinghouse for this investigation. The Maintenance Program Manual for Westinghouse Safety Related Type DB Circuit Breakers and Associated Switchgear, Revision 1, July 2011 provides the following recommendations:

With proper maintenance and inspections of the circuit breaker and cell at the interval recommended the breaker and cell values can be exceeded as addressed later in this section. The service/cycle life of the DB circuit breaker and its components are based on industry standards, testing and analysis. Westinghouse does not recommend these components be considered run-to-failure components, however with proper maintenance and inspection of the breaker and cell components, the recommended lives could be justified beyond the values provided.

The basis for the design life of the cell switch, primary finger clusters and the secondary contacts is American National Standards Institute/Institute of Electrical and Electronics Engineers (ANSI/IEEE) C37.20.1-1987, "An American National Standard, IEEE Standard for Metal-Enclosed Low-Voltage Power Circuit-Breaker Switchgear," subsection 5.2.5. This section defines a low voltage (LV) switchgear with draw-out circuit breakers shall have mechanical endurance test cycles consisting of at least 100 operations between connected and test position.

With proper maintenance and analysis of the components the 100 operation/cycle life of the cell components could be extended. The end of life condition of these components is not known.

The switch that is used as the cell switch is the same switch used as an auxiliary switch on the DB breaker with a qualified life of 4,000 cycles on the DB-50 breaker. The remaining components of the cell switch consist of a metal frame, a metal operations bar and a metal return spring. None of these components are sensitive to age within 100 cycles.

If proper maintenance has been performed the breakers and cell components will operate beyond the service life recommendation. However, the support for the extended service life will be based on the documentation for those parts that have been collected during the maintenance activities.

Westinghouse recommends that DB switchgear be maintained to the requirements of this Maintenance Program Manual, Westinghouse uses additional requirements and additional margin when testing a new or refurbished breaker. These requirements are included in Commercial Dedication Instructions (CDI) that are proprietary to Westinghouse Electric Company. The CDI that was used as a guide for this investigation was CDI-3416, "DB-25 and DB-50 Air Circuit Break Refurbishment Instructions," Revision 08, dated 30-May-2024.

The investigation involved the assistance of engineering, of a quality assurance technician and a mechanical or electrical technician.

WESTINGHOUSE PROPRIETARY CLASS 2

Failure Analysis Report

Purchase Order (PO): 02423936
Westinghouse Sales Order: 160387

Provided by Florida Power & Light Company was Drawing 5613-E-29, Revision 5, Sheet 22A, "Turbine Auxiliaries Turbine Trip Solenoids," that shows the breaker and cell switch series parallel contact arrangement. The applicable breaker Normally Closed (NC) auxiliary switches are in series and are wired to breaker secondary terminals 13 and 14. Before cycling the breaker or removing any item from the breaker a hand-held multimeter was used to monitor the NC contact wired to terminals 13 and 14 as shown here.

The UVTA reset arm was restrained to allow the breaker to be closed, the breaker was manually closed. These photos show that this NC contact changed state when the breaker was closed. Also verified was that there was no interference from closing the breaker.



Breaker Open, Switch Contact Closed



Breaker Closed, Switch Contact Open

The arc chute assemblies were removed, and no concerns were found. The assemblies were not disassembled at this time.

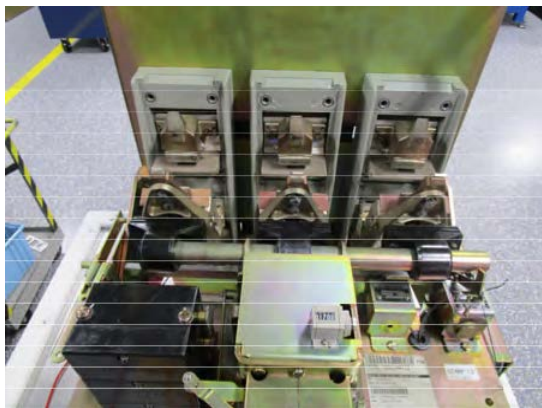

Breaker Open, With Arc Chutes Removed



Breaker Contacts

The front auxiliary switch covers were removed, and the switches were visually inspected. No concerns were found, and the switch contacts appeared to be properly lubricated.

WESTINGHOUSE PROPRIETARY CLASS 2

Failure Analysis Report

Purchase Order (PO): 02423936
Westinghouse Sales Order: 160387

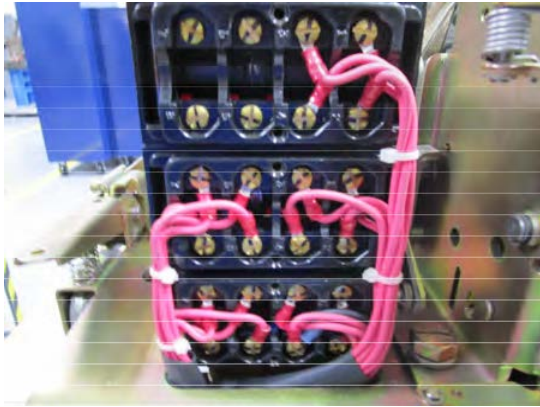

Front of Auxiliary Switches

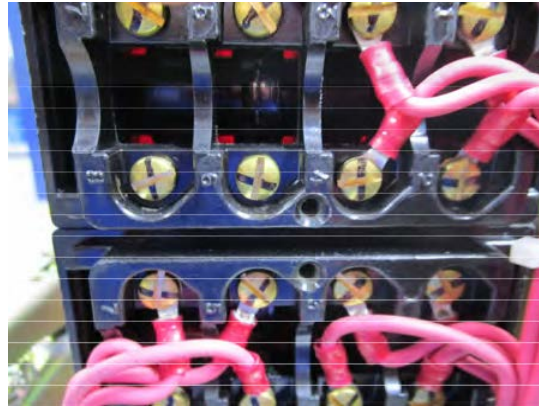

Auxiliary Switch Lubrication

The front cover of the control relay was removed, and the relay was visually inspected, no concerns were found.



Control Relay with Front Cover Removed

The breaker escutcheon plate assembly, face plate, operating mechanism cover and counter were all removed. The plating was visually inspected, the metal structure was plated with yellow zinc dichromate and the main and secondary current carrying parts were silver plated with no flaking, peeling or bubbling. The insulating materials were inspected for cracks, voids or any other damage.

The entire breaker was inspected for cleanliness. The internal parts of the operating mechanism were inspected and found to be free of foreign material. The breaker was visibly free of foreign materials.

The operating mechanism, inertia latch, UVTA, STA assembly, pole unit hinges and auxiliary switch contacts were visually inspected for proper lubrication. The breaker appeared to be sufficiently lubricated.

All retaining rings were verified to be present on the breaker and accessories. The welds and brazes were also visually inspected and found to be acceptable as received.

The breaker escutcheon plate assembly, face plate, operating mechanism cover and counter and the ground contact were all removed so that the breaker could be inserted into the alignment fixture. The meter connected to secondary terminals 13 and 14 and the switch contacts were monitored visually.

WESTINGHOUSE PROPRIETARY CLASS 2

Failure Analysis Report

Purchase Order (PO): 02423936
Westinghouse Sales Order: 160387

The breaker is shown in the alignment fixture. The back panel was properly aligned with the rear stops, the four rollers were all aligned to make contact with the rail assemblies, and the door could be properly closed without interference. The breaker was manually closed, and the DB-50 positioning trip lever trip tab and the operating trip bar gap was verified to be acceptable (0.122”).

The main and secondary contact alignment were verified and found to be acceptable. The alignment fixture door was opened to verify that the breaker would trip open, it did. The auxiliary switches changed state. The breaker was removed and moved to a breaker work cart.



Breaker in Alignment Fixture

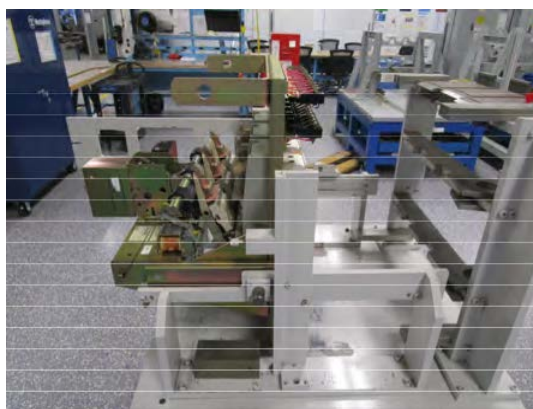

Breaker in Alignment Fixture

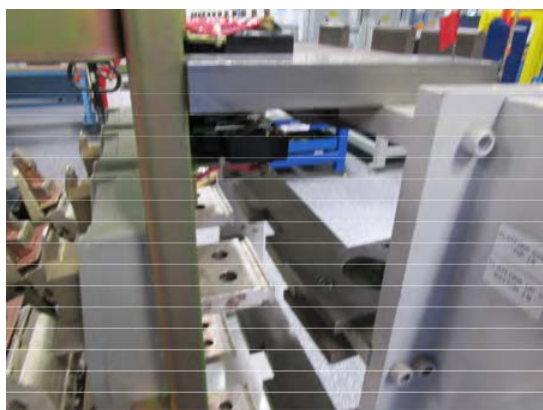

Alignment Fixture Rear Stop

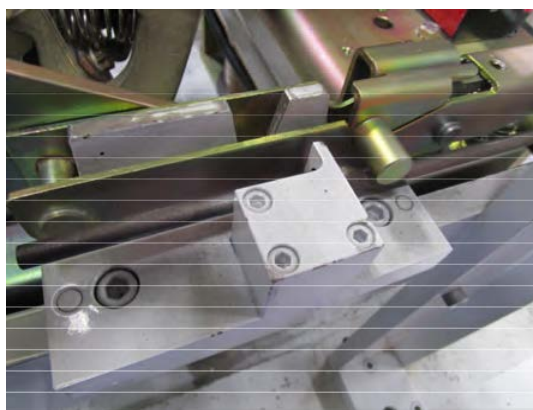

Breaker in the Connect Position

WESTINGHOUSE PROPRIETARY CLASS 2

Failure Analysis Report

Purchase Order (PO): 02423936
Westinghouse Sales Order: 160387



Breaker Stud Alignment

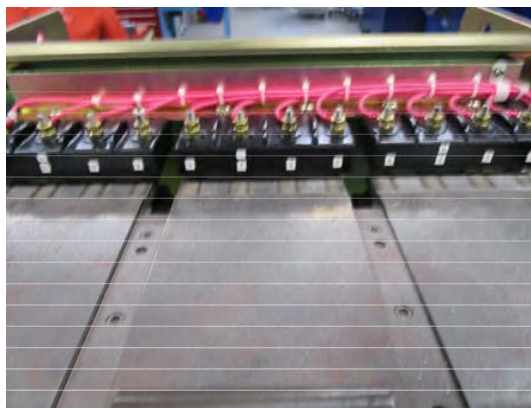

Breaker Secondary Alignment

The hand-held multimeter was used to monitor the NC contact wired to terminals 13 and 14, The operating mechanism trip bar was gently lifted to verify that it moved freely, it did.

The main and arcing contacts were inspected and were found to be properly setup.

The operating mechanism operation was verified manually. There was no binding of parts. When holding the trip bar in an up position and attempting to manually close the breaker it was found to be trip free as is expected.

The breaker trip force measured and found acceptable:	18.1 ounces
The distance to trip was measured and found acceptable:	0.101"
The breaker trip bar to platform height was measured and found acceptable:	L. H. 0.084"
R.H. 0.094"	

The face plate was reinstalled onto the breaker operating mechanism so that the gap between the Push to Trip arm and the rear of the operating mechanism trip pan can be verified, as shown below.

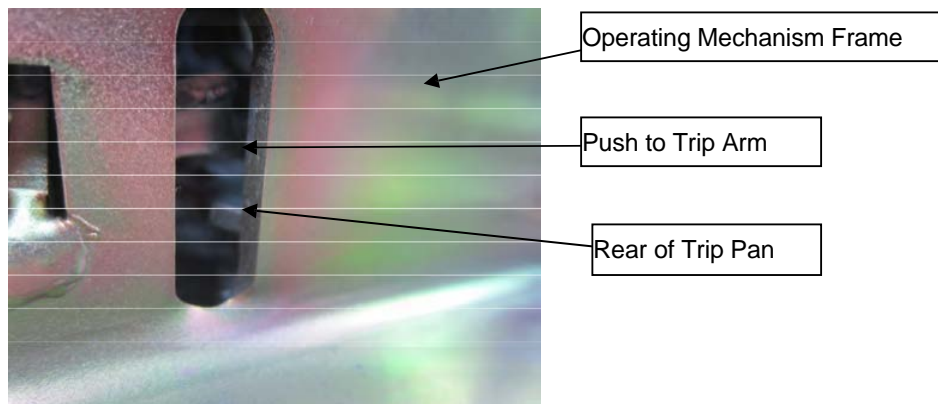

Operating Mechanism Inspection Hole

WESTINGHOUSE PROPRIETARY CLASS 2

Failure Analysis Report

Purchase Order (PO): 02423936
Westinghouse Sales Order: 160387

The manually closing shaft was rotated in each direction to verify it was free and to verify that the manual closing roller did not make contact with the rear of the trip pan. The face plate was removed from the operating mechanism.

The secondary contact gap was verified to be less than 0.010" as required. The clearances around the inertia latch were inspected and found to be acceptable. The inertia latch was removed to verify there was no plating on the pin or bushing. The inertia latch was reinstalled. The NC auxiliary switch (terminals 13 & 14) operated as required 100 % of the time the breaker was cycled. The breaker was moved to the electrical shop.

The wiring of the breaker was verified, and all of the auxiliary switches were verified to change state when the breaker was cycled.

Secondary Contact Number	Auxiliary Switch	Contact Configuration Terminal	Auxiliary Switch	Secondary Contact Number
Bottom Auxiliary Switch				
3 – STA Coil	1	NO	2	7
4	3	NC	4	8 + Closing + Relay Coils
9	5	NO	6	10
5	7	NC	8	6
Middle Auxiliary Switch				
19	1	NO	2	20
17	3	NC	4	18
15	5	NO	6	16
13	7	NC	8	14
Top Auxiliary Switch				
23	1	NO	2	24
21	3	NC	4	22
	5	NO	6	
	7	NC	8	
11		UVTA Coil		12

The resistance of the coils were measured and recorded:

Closing Coil:	6.1 Ω
Control Relay Coil:	1273 Ω
Control Relay Blow-out Coil:	0.052 Ω
STA Coil:	56.7 Ω
UVTA Coil:	997 Ω

Millivolt drop tests were performed with 100 Amps DC, between the main upper stud and the lower main stud, with a barrier between the main contacts the millivolt drop tests between the stationary and moving arcing contacts and with the barrier still installed, between the main upper stud and the lower main stud. The results are provided here:

WESTINGHOUSE PROPRIETARY CLASS 2

Failure Analysis Report

Purchase Order (PO): 02423936
Westinghouse Sales Order: 160387

Millivolt Drop Testing

Upper - Lower Stud, Phase 'A'	(< 4 mV):	11.9 mV
Upper - Lower Stud, Phase 'B'	(< 4 mV):	82.1 mV
Upper - Lower Stud, Phase 'C'	(< 4 mV):	33.9 mV

Millivolt Drop Testing

Stationary - Moving Arcing Contact, Phase 'A'	(<6.5 mV):	270.6 mV
Stationary - Moving Arcing Contact, Phase 'B'	(<6.5 mV):	192.2 mV
Stationary - Moving Arcing Contact, Phase 'C'	(<6.5 mV):	52.5 mV

Millivolt Drop Testing

Upper - Lower Stud, Phase 'A'	(< 20 mV):	325.2 mV
Upper - Lower Stud, Phase 'B'	(< 20 mV):	139.7 mV
Upper - Lower Stud, Phase 'C'	(< 20 mV):	69.6 mV

These values were greater than expected. Photos were taken of these contacts and then the contacts were cleaned with Scotchbrite and isopropyl alcohol. Additional photos were taken to show the cleaned contacts.

Stationary Arcing Contacts

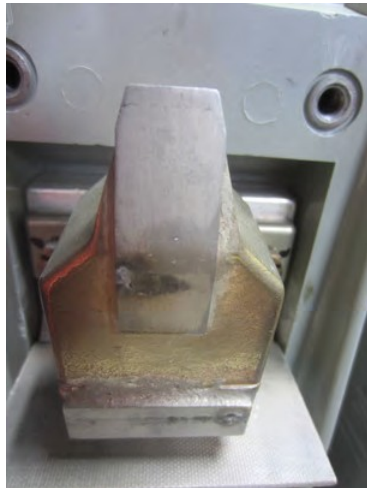

Phase A

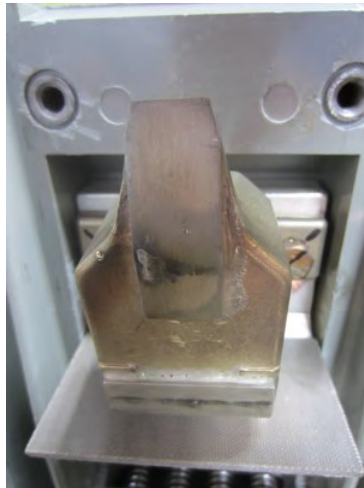

Phase B

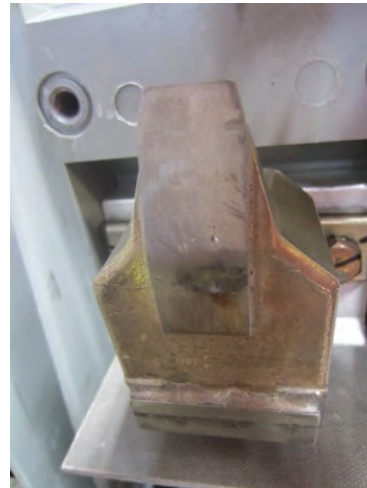

Phase C

WESTINGHOUSE PROPRIETARY CLASS 2

Failure Analysis Report

Purchase Order (PO): 02423936
Westinghouse Sales Order: 160387

Moving Arcing Contacts

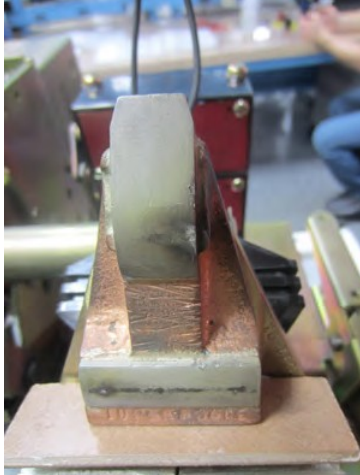

Phase A



Phase B



Phase C

Main Moving Contacts

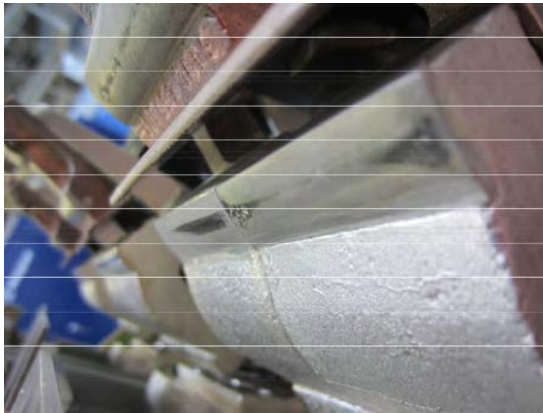

Before Cleaning



Cleaned Contacts

WESTINGHOUSE PROPRIETARY CLASS 2

Failure Analysis Report

Purchase Order (PO): 02423936
Westinghouse Sales Order: 160387

Stationary Arcing Contacts After Cleaning

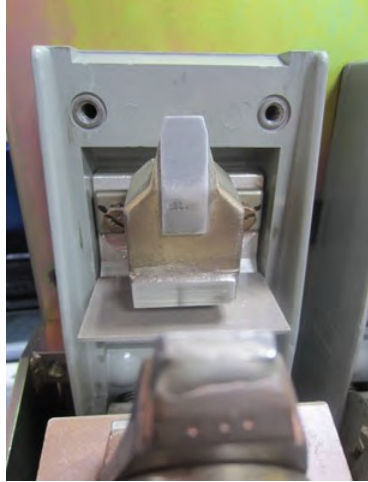

Phase A



Phase B



Phase C

Moving Arcing Contacts After Cleaning



Phase A



Phase B



Phase C

Millivolt drop tests were repeated as described above.

Millivolt Drop Testing

Upper - Lower Stud, Phase 'A'	(< 4 mV):	3.1 mV
Upper - Lower Stud, Phase 'B'	(< 4 mV):	2.1 mV
Upper - Lower Stud, Phase 'C'	(< 4 mV):	2.5 mV

WESTINGHOUSE PROPRIETARY CLASS 2

Failure Analysis Report

Purchase Order (PO): 02423936
Westinghouse Sales Order: 160387

Millivolt Drop Testing

Stationary - Moving Arcing Contact, Phase 'A'	(<6.5 mV):	3.9 mV
Stationary - Moving Arcing Contact, Phase 'B'	(<6.5 mV):	32.0 mV
Stationary - Moving Arcing Contact, Phase 'C'	(<6.5 mV):	6.1 mV

Millivolt Drop Testing

Upper - Lower Stud, Phase 'A'	(< 20 mV):	19.9 mV
Upper - Lower Stud, Phase 'B'	(< 20 mV):	47.9 mV
Upper - Lower Stud, Phase 'C'	(< 20 mV):	22.6 mV

After receiving values greater than expected the pole bases will need to be disassembled and cleaned as a standard part of a DB breaker refurbishment. These values are not a concern for the tripping of the breaker, simply that the contacts were slightly oxidized. After applying operating current to the pole bases the oxidation would burn off and the breaker would operate fine.

The hand-held multimeter was used to monitor the NC contact wired to terminals 13 and 14, 17-

Mar-21

The mechanical set-up of the control relay was verified and the closing solenoid moving core relay release arm was verified to be correct by manually slow closing the breaker and having the closing solenoid relay trip window assembly moving before the operating mechanism pawl drops. The anti-pump function of the relay was verified, and the contact sequence was correct and the contact overtravel was also found to be acceptable.

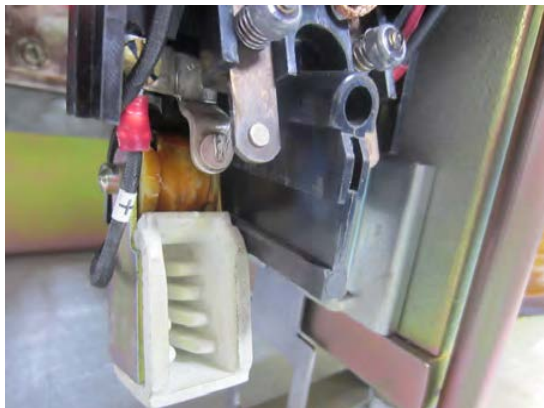

Control Relay with Arc Chamber Pulled Down The breaker was electrically cycled as outlined here.

- | | |
|---------------|----------|
| 125 V DC | 70 V DC |
| 87 V DC (x 3) | 100 V DC |
| 144 V DC (x3) | 110 V DC |
| 120 V DC | |
| 130 V DC | |
| 140 V DC | |

WESTINGHOUSE PROPRIETARY CLASS 2

Failure Analysis Report

Purchase Order (PO): 02423936
Westinghouse Sales Order: 160387

At each of these voltages the breaker successfully closed and the NC contact on terminals 13 and 14 operated as expected.

The focus of the investigation moved to the Shunt Trip Attachment.

The moving core of the shunt trip was held in to contact the stationary core, simulating the energization of the shunt trip coil. In this position an attempt was made to manually close the breaker, the breaker was trip free as was expected. The moving core was then released, and it returned to the original position. A visible gap was verified between the shunt trip attachment trip paddle and the operating mechanism trip bar. The moving core was then rotated while moving the core into the stationary core and verified that each time it returned to the original position. This was performed 12 times or at approximately 30 degree intervals. This test verified that the moving core and brass tube that it moves through is free to move without effecting the operation of the STA.

The breaker was electrically closed with 125 V DC. The STA trip lever gap was measured.

Trip Lever / Bar Gap Measured (0.031" - 0.203"): 0.130"

While the breaker was still closed a weight was added to the operating mechanism trip bar to achieve a minimum of 48 ounces, as determined by measuring the breaker trip force.

Trip bar force with added weight: 48.16 Ounces

After this weight was established the weight was removed and the breaker was closed with 125 V DC, the weight was added back onto the trip bar and the STA was energized with 69 V DC, thus tripping the breaker showing margin in the weight that the STA is able to pull with the minimum voltage applied. The breaker was successfully tripped 3 times with this setup. A photo has been provided to show the weight hung of the trip bar.



Additional Weight Added to the Operating Mechanism Trip Bar

WESTINGHOUSE PROPRIETARY CLASS 2

Failure Analysis Report

Purchase Order (PO): 02423936
Westinghouse Sales Order: 160387

With the weights removed from the trip bar the breaker was cycled 1 time at 125 V DC. The breaker was then cycled 1 time with 144 V DC.

The moving core of the shunt trip was again held in to contact the stationary core, simulating the energization of the shunt trip coil. In this position an attempt was made to manually close the breaker, the breaker was trip free as was expected.

The focus of the investigation moved to the Under-Voltage Trip Attachment.

The breaker was closed with 125 V DC and the UVTA restraining string was slowly released. The UVTA had a positive snap action before tripping the breaker open.

The reset of the UVTA was verified by pushing the center moving contact arm towards the closed position. The UVTA tripped. Then by slowly releasing the center moving contact arm. The UVTA reset just as the closing lever returns to a fully open position.

With the UVTA deenergized the manual closing handle is used to verify the breaker is trip free, it was.

The UVTA was energized with 125 V DC and the breaker was electrically closed with 125 V DC. The distance from the centerline of the UVTA trip lever pin to the edge of the mechanism trip bar was measured and recorded.

Trip Lever Pin – Trip Bar (0.406” – 0.531”): 0.515”

With the breaker closed, the gap between the UVTA trip lever and the mechanism trip bar was measure and recorded

Trip Lever / Bar Gap Measured (0.031” – 0.094”): 0.054”

The UVTA was energized with rated voltage for a minimum of 15 minutes before proceeding. As described above, while the breaker was closed a weight was added to the operating mechanism trip bar to achieve a minimum of 48 ounces, as determined by measuring the breaker trip force.

Trip bar force with added weight: 51.04 Ounces

The removal of the voltage from the UVTA did not caused the breaker to trip. The weight required to trip the breaker was reduced to 48.0 Ounces

The removal of the voltage from the UVTA successfully caused the breaker to trip. The UVTA was lubricated and then cycled several times for the lubrication to work its way into the pins. The UVTA was again energized and the breaker was electrically closed. Trip weight was added onto the trip bar (51.04 ounces). Again, the removal of the voltage from the UVTA caused the breaker to trip successfully. The weight was removed.

The UVTA drop-out voltage was measured: 1.)

- 53.8 V DC
- 2.) 51.8 V DC
- 3.) 51.9 V DC

The UVTA was again energized with 125 V DC and the breaker was closed with 125 V DC. A plastic head hammer was used to shock the breaker platform in an attempt to shock out the UVTA or cause the breaker to trip open. A photo of this is provided below. The UVTA did not release and the breaker did not open.

The UVTA and breaker operated successfully. Cycles added to the UVTA – 17.

WESTINGHOUSE PROPRIETARY CLASS 2

Failure Analysis Report

Purchase Order (PO): 02423936
Westinghouse Sales Order: 160387



Breaker Platform Shock Test Timing tests were performed on this breaker:

The breaker open by energizing the STA 29.2 m Sec.

The breaker open by de-energizing the UVTA 61.3 m Sec.

The breaker was electrically closed 164.6 m Sec

The NC auxiliary switch (terminals 13 & 14) operated as required 100 % of the time the breaker was cycled.
The incoming electrical testing of the breaker was completed.

WESTINGHOUSE PROPRIETARY CLASS 2

Failure Analysis Report

Purchase Order (PO): 02423936
Westinghouse Sales Order: 160387

DB Cell Switches, P/N: 302C517G01

The breaker was moved a side and the investigation of the DB cell switches began

The switches are identified as Left-Side Switch and Right-Side Switch as labeled in the photos.



Left-Side Switch



Right-Side Switch

The push rod of the cell switches were lubricated with a foreign lubrication and the return springs were not lubricated with anything. These two locations are to be lubricated with Molybdenum Disulfide in Isopropyl Alcohol (53701GW) lubricant during maintenance intervals.



Left-Side Switch



Right-Side Switch

WESTINGHOUSE PROPRIETARY CLASS 2

Failure Analysis Report

Purchase Order (PO): 02423936
Westinghouse Sales Order: 160387

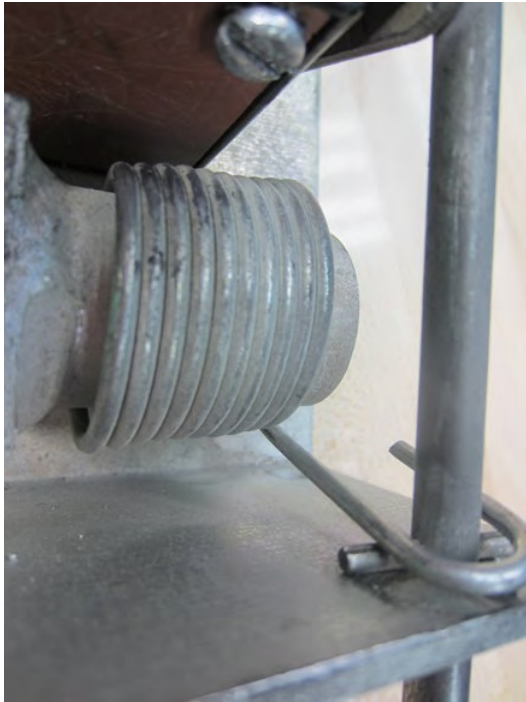

Left-Side Switch



Right-Side Switch

The front switch covers were removed and both switches appeared to have grease that had hardened on the contacts.

The left side switch was clamped to a bench, a multimeter was connected to a NC switch to monitor the operation of the switch.



Left-Side Switch



Left-Side Switch Monitoring

WESTINGHOUSE PROPRIETARY CLASS 2

Failure Analysis Report

Purchase Order (PO): 02423936
Westinghouse Sales Order: 160387

Plunger force testing and distance to change state testing were performed on this switch, the photos provided show the force test setup.

Left-Side Switch



Force Test Set-Up



Force Test Set-Up

The force was measured when the plunger started to move, when the contact changed state and the maximum force achieved. The results are:

Start of Moving:	7.23 Lbs.	6.79 Lbs.	6.98 Lbs.
Change of State:	15.21 Lbs.	14.92 Lbs.	15.34 Lbs.
Maximum Force:	21.98 Lbs.	23.49 Lbs.	20.76 Lbs.

The distance required to move the plunger to cause the switch contacts to change state was measured.

Distance required to change the switch state: 0.524"

The single contact that was monitored worked 100% of the time. Four multimeters were then connected to each of the 4 switches. The switch was cycled and the switch at the end (switch terminals 7 & 8) remained open in both states of the switch as shown in these photos.



Breaker Open Switch Position
(Plunger Not Actuated)



Breaker Closed Switch Position
(Plunger Actuated)

WESTINGHOUSE PROPRIETARY CLASS 2

Failure Analysis Report

Purchase Order (PO): 02423936
Westinghouse Sales Order: 160387

Expected switch configuration / state.

Left Side Switch	Contact 1	Contact 2	Contact 3	Contact 4
	Terminals 1 & 2	Terminals 3 & 4	Terminals 5 & 6	Terminals 7 & 8
Plunger not actuated	CLOSED	OPEN	CLOSED	OPEN
Plunger actuated	OPEN	CLOSED	OPEN	CLOSED

The rear cover of the switch was removed, the contact rotor can be seen moving. The resistance was then measured between the terminal screws and the stationary contacts. It was a closed circuit between terminal 7 and the top stationary contact, it was an open circuit between terminal 8 and the bottom stationary contact. The switch plunger was cycled 50 times while monitoring the switch contacts. Switch contacts 1, 2 and 3 changed state each time the plunger was cycled. Switch contact 4 (terminals 7 & 8) remained open for each of the cycles. The bottom stationary contact associated with terminal 8 appears to be out of place as seen in the photo below.

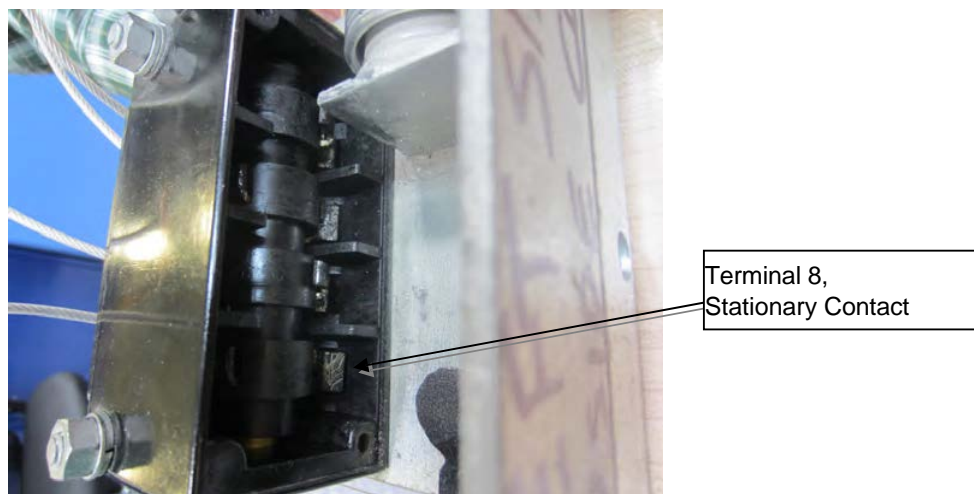

Left Side Switch - Switch Contact 4, Terminal 8

The right-side switch was clamped to a bench, a multimeter was connected to a NC switch to monitor the operation of the switch.



Right-Side Switch



Right-Side Switch Monitoring

WESTINGHOUSE PROPRIETARY CLASS 2

Failure Analysis Report

Purchase Order (PO): 02423936
Westinghouse Sales Order: 160387

Plunger force testing and distance to change state testing were performed on this switch, the same set-up was used as shown above.

The force was measured when the plunger started to move, when the contact changed state and the maximum force achieved. The results are:

Start of Moving:	7.46 Lbs.	6.21 Lbs.	6.23 Lbs.
Change of State:	13.77 Lbs.	13.06 Lbs.	13.23 Lbs.
Maximum Force:	20.48 Lbs.	19.55 Lbs.	22.37 Lbs.

The distance required to move the plunger to cause the switch contacts to change state was measured.

Distance required to change the switch state: 0.588"

The single contact that was monitored worked 100% of the time. Four multimeters were then connected to each of the 4 switches. The switch was cycled and the switch at the end (switch terminals 3 & 4) remained open in both states of the switch as shown in these photos.



Right-Side Switch Monitoring



Right-Side Switch Monitoring Connections



Breaker Open Switch Position



Breaker Closed Switch Position

WESTINGHOUSE PROPRIETARY CLASS 2

Failure Analysis Report

Purchase Order (PO): 02423936
Westinghouse Sales Order: 160387

Expected switch configuration / state.

Right Side Switch	Contact 1	Contact 2	Contact 3	Contact 4
	Terminals 1 & 2	Terminals 3 & 4	Terminals 5 & 6	Terminals 7 & 8
Plunger not actuated	CLOSED	OPEN	CLOSED	OPEN
Plunger actuated	OPEN	CLOSED	OPEN	CLOSED

The rear cover of the switch was removed, the contact rotor can be seen moving. The resistance was then measured between the terminal screws and the stationary contacts. It was a closed circuit between terminal 3 and the top stationary contact, it was an open circuit between terminal 4 and the bottom stationary contact. The switch plunger was cycled 50 times while monitoring the switch contacts. Switch contacts 1, 3 and 4 changed state each time the plunger was cycled. Switch contact 2 (terminals 3 & 4) remained open for each of the cycles. The bottom stationary contact associated with terminal 4 appears to be out of place as seen in the photo below.

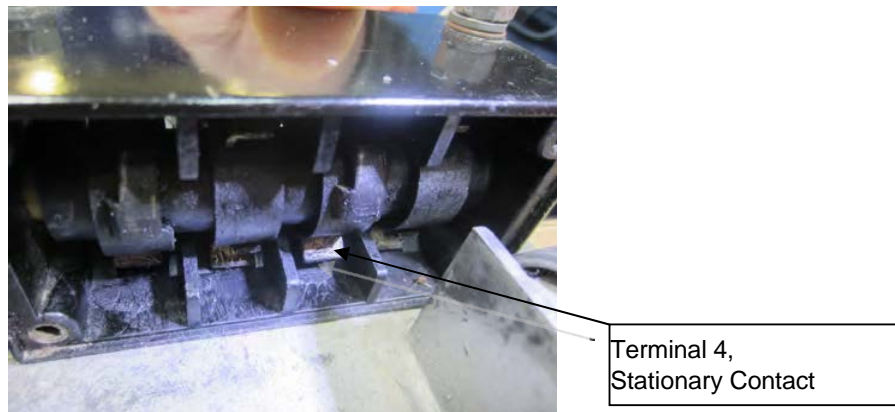

Switch Contact 2, Terminal 4

Both the left-side switch and right-side switch were removed from their base plates and were verified per drawing to be assembled correctly.



Switch Contact Verification

WESTINGHOUSE PROPRIETARY CLASS 2

Failure Analysis Report

Purchase Order (PO): 02423936
Westinghouse Sales Order: 160387

The switch rotors were removed from each of the switches and the bottom stationary contact finger in each case had come loose from the terminal point as shown here (left-hand switch and right)



Left-Side Switch Stationary Contacts



Right-Side Switch Stationary Contacts



Left-Side Switch Stationary Contacts



Right-Side Switch Stationary Contacts A

brief overview of the findings with the 2 cell switches was provided to site on 17-Mar-21.

18-Mar-21

After having a discussion with Bob Tomonto and Orlando Carol from FP&L, we all agreed that it was time to start the disassembly of the breaker.

The disassembly began with pulling on every wire connected to a terminal that could be accessed. No terminal connections were found to be loose. The auxiliary switch wires were removed from their terminal screws and again the wires and terminals were verified. No issues found. The rear covers were removed, and photos were taken.

WESTINGHOUSE PROPRIETARY CLASS 2

Failure Analysis Report

Purchase Order (PO): 02423936
Westinghouse Sales Order: 160387



Front of Auxiliary Switches



Rear of Auxiliary Switches

The auxiliary switches were removed from the platform, visually inspected, and then disassembled.



Front of Auxiliary Switches



Rear of Auxiliary Switches

WESTINGHOUSE PROPRIETARY CLASS 2

Failure Analysis Report

Purchase Order (PO): 02423936
Westinghouse Sales Order: 160387



Disassembled Auxiliary Switches No issues were found with the auxiliary switch assembly.

The control relay was removed from the breaker platform and the wires and terminals were verified.



Breaker with the Auxiliary Switches and Control Relay Removed

WESTINGHOUSE PROPRIETARY CLASS 2

Failure Analysis Report

Purchase Order (PO): 02423936
Westinghouse Sales Order: 160387

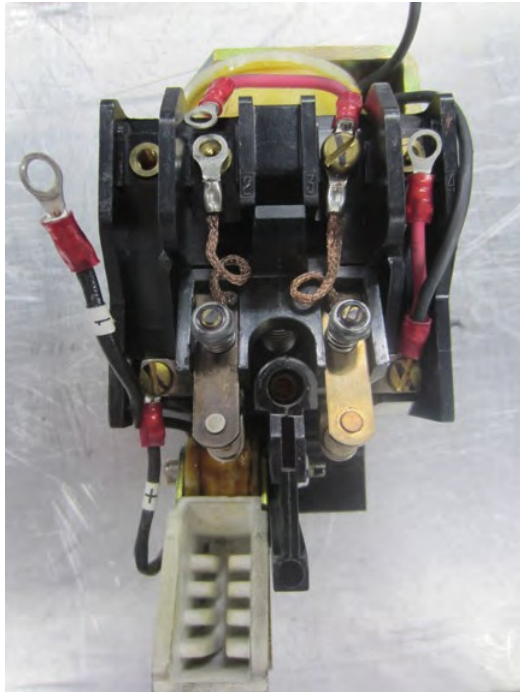

Front of Control Relay



Rear of Control Relay



Side of Control Relay



Other Side of Control Relay

WESTINGHOUSE PROPRIETARY CLASS 2

Failure Analysis Report

Purchase Order (PO): 02423936
Westinghouse Sales Order: 160387

After the control relay was removed from the platform it was visually inspected, and then disassembled.



Disassembled Control Relay No issues were found with the control relay assembly.

The wires were removed from the secondary contact assembly and the wires and terminals were verified. The secondary contact assembly and the lifting bracket were removed from the breaker.



Secondary Contact Assembly on Breaker

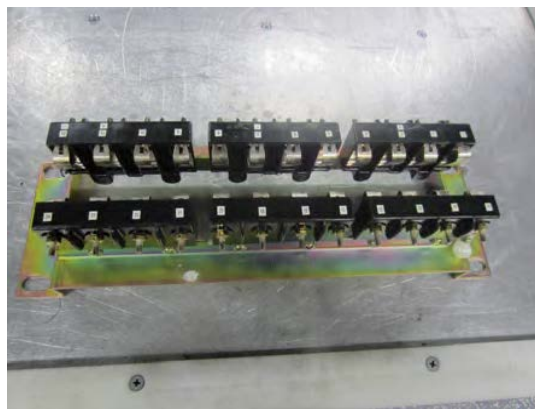

Secondary Contact Assembly Removed

No issues were found with the secondary contact assembly.

The wires were removed from the Shunt Trip Attachment and it was removed from the breaker platform.

WESTINGHOUSE PROPRIETARY CLASS 2

Failure Analysis Report

**Purchase Order (PO): 02423936
Westinghouse Sales Order: 160387**



Breaker without the STA



STA Assembly Removed

The STA was visually inspected and disassembled, no issues were found.



Disassembled STA

The wires were removed from the Under-Voltage Trip Attachment and it was removed from the breaker platform. The assembly was visually inspected but was not disassembled.

WESTINGHOUSE PROPRIETARY CLASS 2

Failure Analysis Report

Purchase Order (PO): 02423936
Westinghouse Sales Order: 160387

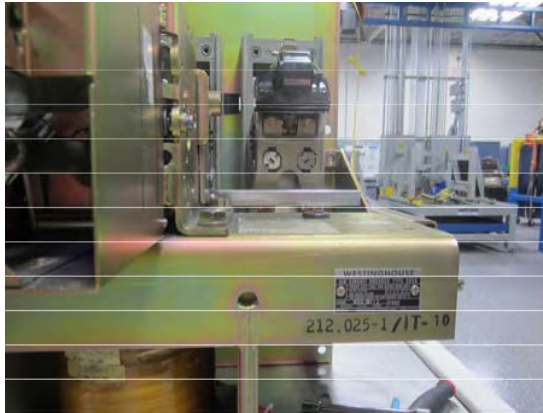

Breaker without the STA and UVTA



UVTA Assembly Removed



Side of UVTA



Other Side of UVTA

The visual inspection of the UVTA did not provide anything to be concerned about.

The cross bar was removed followed by the operating mechanism. The operating mechanism was visually inspected.



Breaker with the Operating Mechanism Removed

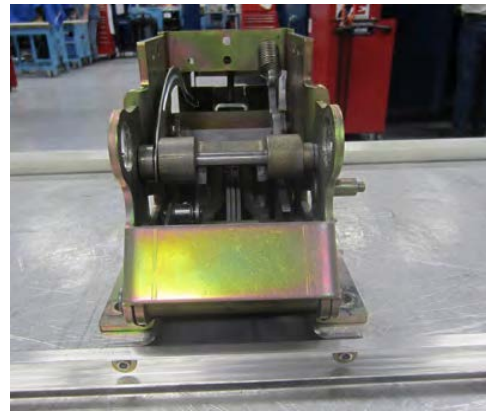

Operating Mechanism

WESTINGHOUSE PROPRIETARY CLASS 2

Failure Analysis Report

Purchase Order (PO): 02423936
Westinghouse Sales Order: 160387

The breaker lock-out tabs on the front of the operating mechanism were found to be slightly bent, however the breaker operated without incident during all mechanical and electrical testing. If these tabs had been bent enough to prevent the Push to Trip button from fully returning to the reset position the linkage within the mechanism could prevent the breaker from closing or could cause a situation that the breaker might close, but not remain closed. These photos show that without the face plate attached to the operating mechanism the Push to Trip button is free to fall below its normal position. This is not a concern as it shows that the tabs are not tight enough to hold the Push to Trip button.



Bent Breaker Lock-Out Tabs

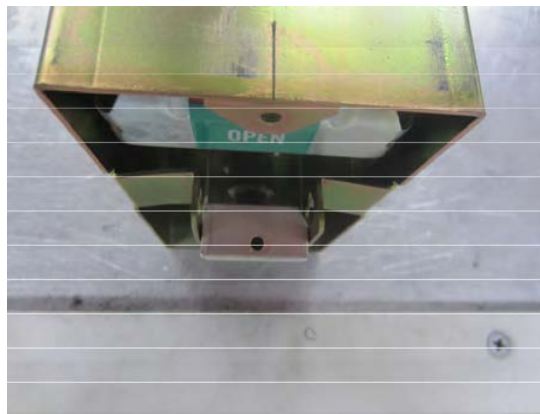

Bent Breaker Lock-Out Tabs

The following photos show the Push to Trip button in its normal position.



Push to Trip button

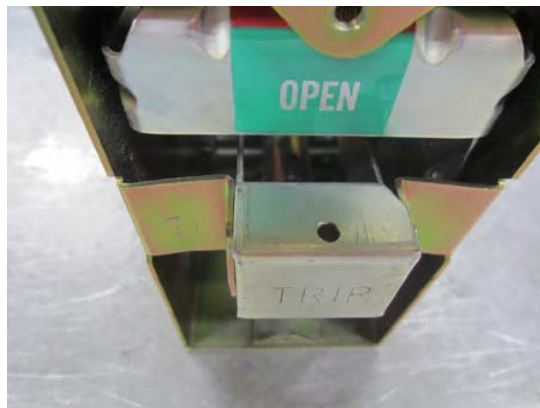

Push to Trip button

In either of these two positions above the Push to Trip lever would not make contact with the rear of the trip pan.

WESTINGHOUSE PROPRIETARY CLASS 2

Failure Analysis Report

Purchase Order (PO): 02423936
Westinghouse Sales Order: 160387

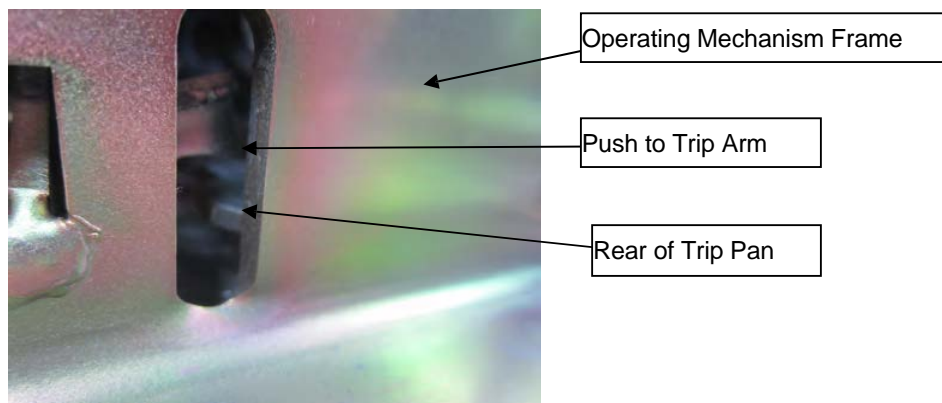

Operating Mechanism Inspection Hole

If the Push to Trip button is held in like shown below, or if the breaker lock-out tabs on the front of the operating mechanism are bent sufficiently to hold this button in the Push to Trip lever would make contact with the rear of the trip pan. This scenario could cause the breaker to be trip free and it would not close, or if the trip pan was only partially held down the breaker may have closed, but the operating mechanism trip faces may not have been completely seated and a shock in the area of the breaker cell could cause the breaker to open. Either of these cases could cause the breaker to open unexpectedly.



Operating Mechanism Inspection Hole

WESTINGHOUSE PROPRIETARY CLASS 2

Failure Analysis Report

Purchase Order (PO): 02423936
Westinghouse Sales Order: 160387

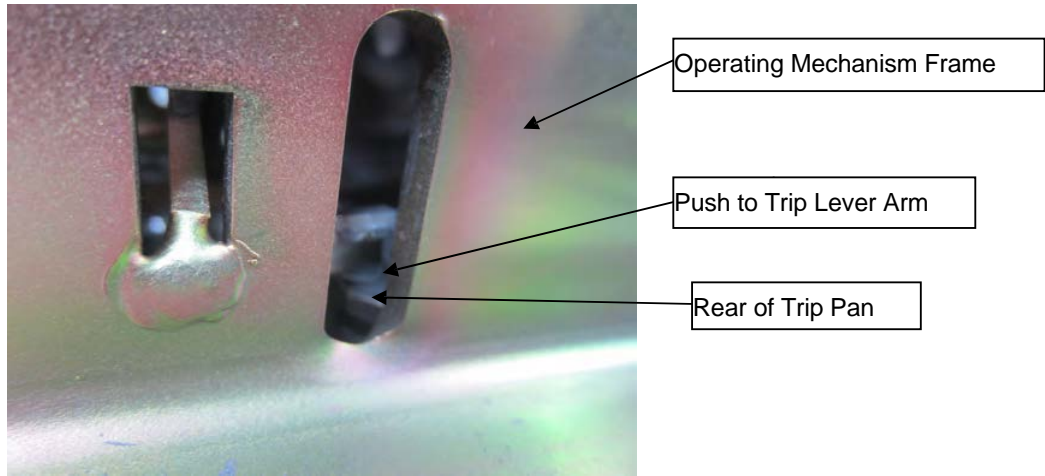

Operating Mechanism Inspection Hole

The operating mechanism was disassembled and visually inspected. No issues were found.

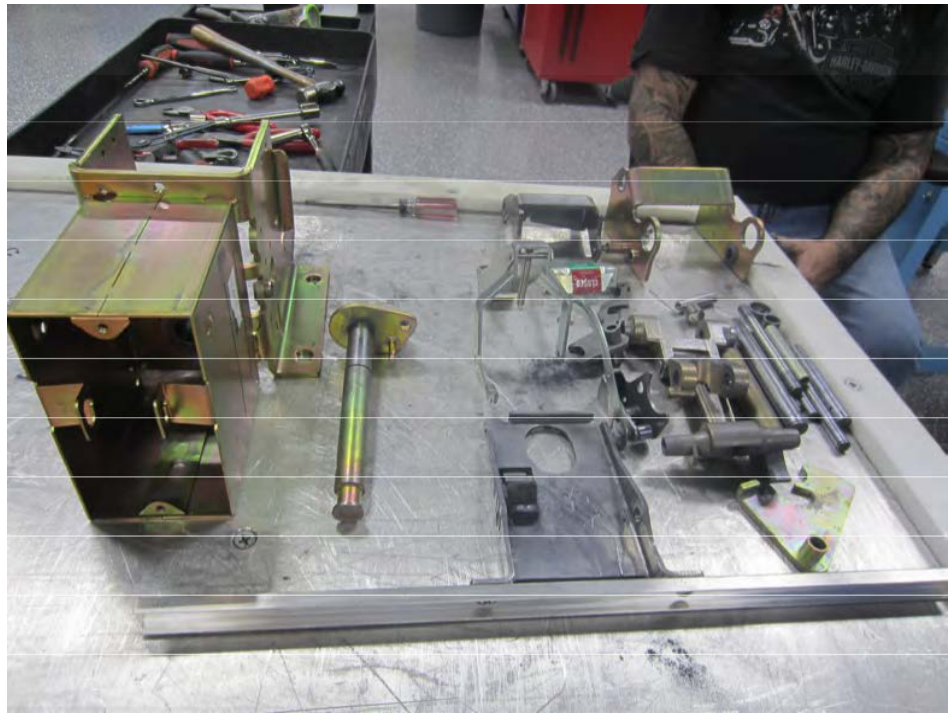

Disassembled Operating Mechanism This photo shows the trip pan and the Push to Trip linkage.

WESTINGHOUSE PROPRIETARY CLASS 2

Failure Analysis Report

Purchase Order (PO): 02423936
Westinghouse Sales Order: 160387



Push to Trip Lever Arm

Rear of Trip Pan

The pole bases were removed one at a time and were not disassembled at this time.



Phase 'A' Removed



Phase 'A' Removed



Phase 'B' Removed



Phase 'B' Removed

WESTINGHOUSE PROPRIETARY CLASS 2

Failure Analysis Report

Purchase Order (PO): 02423936
Westinghouse Sales Order: 160387



Phase 'C' Removed



Phase 'C' Removed

The closing solenoid was removed, and the closing solenoid relay release window assembly was removed and disassembled.



Closing Solenoid Assembly



Closing Solenoid Relay Release Window Disassembled No

areas of concern were found with these items.

The wiring harness was removed from the breaker frame and was inspected.

WESTINGHOUSE PROPRIETARY CLASS 2

Failure Analysis Report

Purchase Order (PO): 02423936
Westinghouse Sales Order: 160387



Breaker Wiring Harness

No areas of concern were found with the wiring harness or any of the terminations. 23-

Mar-21

A conference call was held on Tuesday, 23-Mar-21 to discuss the direction the testing was going in. A request was made to reassemble the cell switches and install them into a test cell and then use the breaker frame to verify the operation of the switches.

The left-side switch and right-side switch were properly assembled with all of the stationary fingers securely in place. The switch contacts were cleaned and properly lubricated during the assembly and each switch was mounted back onto the base plate and the plunger was attached to complete the assembly. Both the front and rear covers remained off of the switches so that the contacts could be monitored. Photos of the switches are provided:



Left-Side and Right-Side Switches

WESTINGHOUSE PROPRIETARY CLASS 2

Failure Analysis Report

Purchase Order (PO): 02423936
Westinghouse Sales Order: 160387



Left-Side Switch



Right Side Switch



Right-Side Switch Rear

Left Side Switch Rear



Right-Side Switch Rear



Left Side Switch Rear

WESTINGHOUSE PROPRIETARY CLASS 2

Failure Analysis Report

Purchase Order (PO): 02423936
Westinghouse Sales Order: 160387



Left-Side Switch and Right-Side Switch Installed in Test Cell



Left-Side Switch and Right-Side Switch Installed in Test Cell

WESTINGHOUSE PROPRIETARY CLASS 2

Failure Analysis Report

Purchase Order (PO): 02423936
Westinghouse Sales Order: 160387

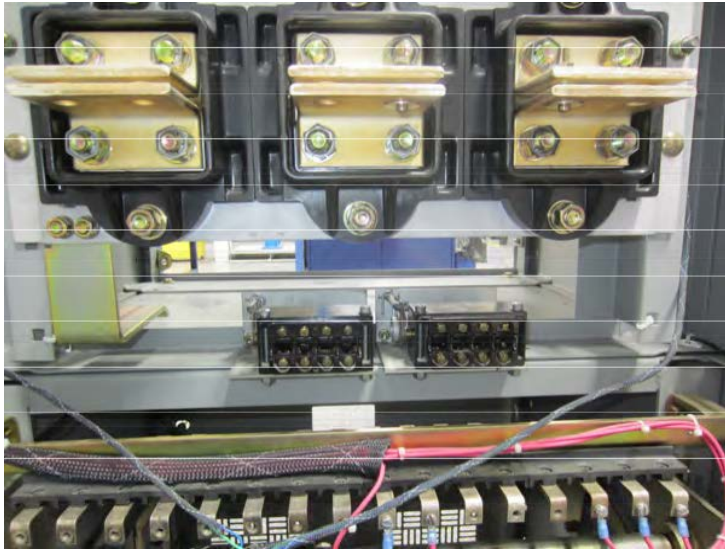

Rear of Test Cell and Cell Switches

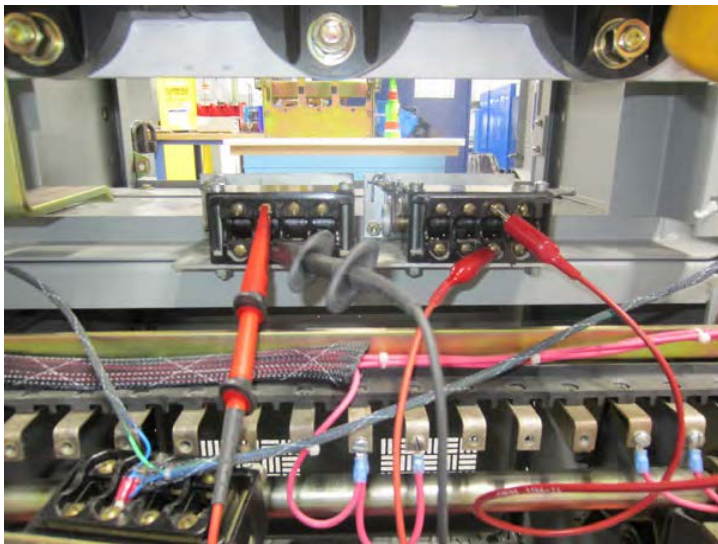

Cell Switch Monitoring Set-up

The Right-Side Switch is monitoring a Normally Open contact on switch terminals 3 and 4. The Left-Side Switch is monitoring a Normally Closed contact on switch terminals 5 and 6.

WESTINGHOUSE PROPRIETARY CLASS 2

Failure Analysis Report

Purchase Order (PO): 02423936
Westinghouse Sales Order: 160387



Right-Side Switch Monitoring (NO)



Left-Side Switch Monitoring (NC)



Breaker Frame on Test Cell Rails

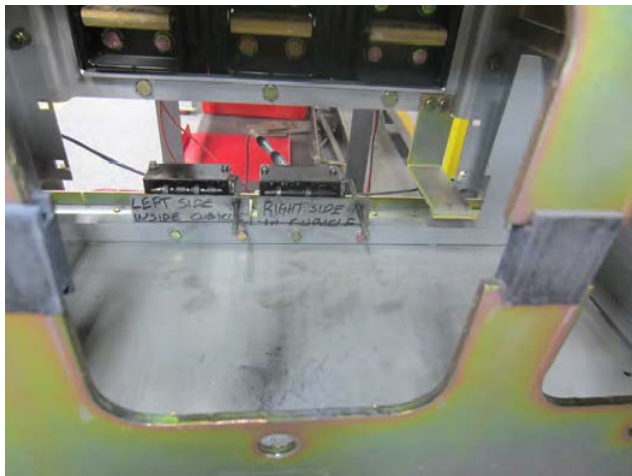

Cell Switches shown through Breaker Rear Panel

WESTINGHOUSE PROPRIETARY CLASS 2

Failure Analysis Report

Purchase Order (PO): 02423936
Westinghouse Sales Order: 160387

The next series of photos are showing the breaker frame location as defined by the cell positioning stop bracket with Disconnected, Test and Connected positioning slots and then the distance between the cell switch plungers and the rear of the breaker panel.



Breaker Frame Located before the Cell Positioning Stop Bracket

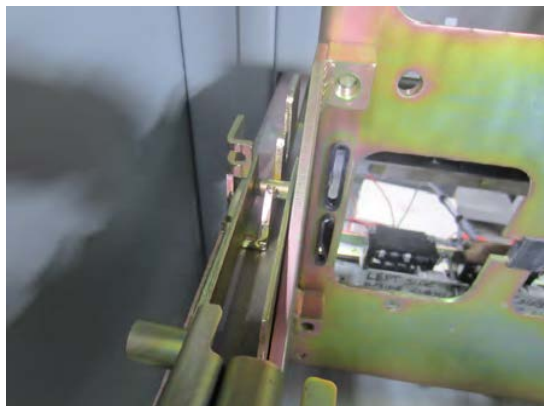

Breaker Frame Located in the Disconnect Position Stop Bracket

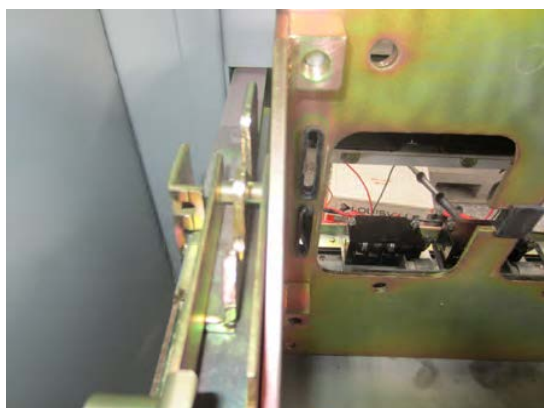

Breaker Frame Located in the Test Position Stop Bracket

WESTINGHOUSE PROPRIETARY CLASS 2

Failure Analysis Report

Purchase Order (PO): 02423936
Westinghouse Sales Order: 160387

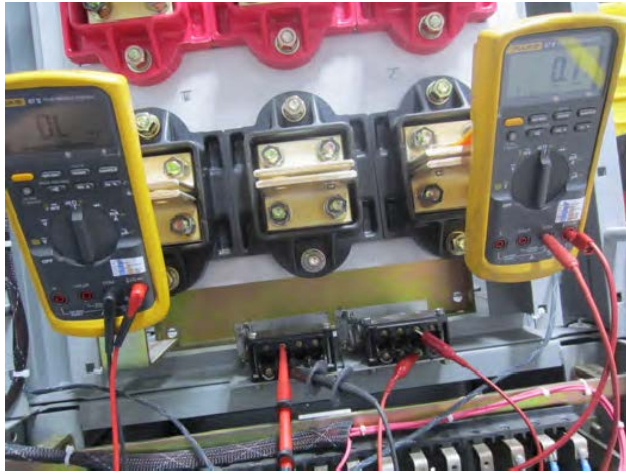

Right-Side Switch Monitoring (NO) --- Left-Side Switch Monitoring (NC)

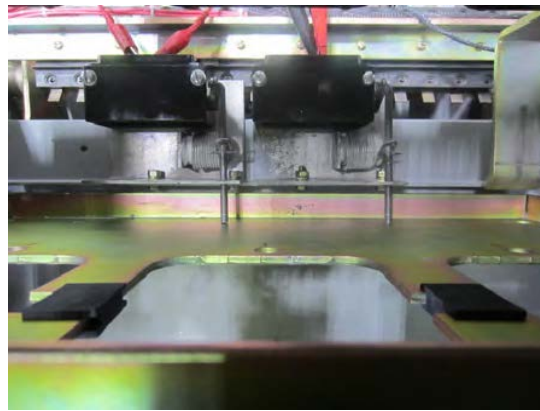

Breaker Frame Located in the Connect Position Stop Bracket



Switch Monitoring Shows a Change of State

WESTINGHOUSE PROPRIETARY CLASS 2

Failure Analysis Report

Purchase Order (PO): 02423936
Westinghouse Sales Order: 160387

Both cell switches changed state as required between the Test and Connect breaker positions. 24-

Mar-21

The breaker frame was removed from the test cell and the cell switches were also removed. The cell switch return springs were removed for testing. The springs were given to QA for force testing. The reading recorded were acceptable.

Pole bases were disassembled and nothing of concern were found.

The closing solenoid assembly was disassembled and nothing of concern were found. With the breaker disassembled the refurbishment of the breaker was initiated.

WESTINGHOUSE PROPRIETARY CLASS 2

Failure Analysis Report

Purchase Order (PO): 02423936
Westinghouse Sales Order: 160387

Conclusions:

The breaker was received in very good condition and properly lubricated. This breaker as received was acceptable for use. The possible cause of failure could have been the bent breaker lock-out tabs on the front of the operating mechanism, they were found to be slightly bent, however the breaker operated without incident during all mechanical and electrical testing.

The cell switches appeared to be original supplied equipment. They were not properly maintained, and the hardened lubrication could cause the stationary contacts to become dislodged, as documented above. In addition, to contributing to the dislodging the stationary contacts, excess or dry grease can cause improper indications from the switch contacts. This could be considered a possible cause of failure.

WESTINGHOUSE PROPRIETARY CLASS 2

Failure Analysis Report

Purchase Order (PO): 02423936
Westinghouse Sales Order: 160387

Recommendations:

It is recommended that the breaker be handled outside the switchgear cubicle with additional care. The breaker lock-out tabs on the front of the operating mechanism can cause the breaker not to function properly. When a breaker is shipped from Westinghouse the breaker lock-out tabs will include an operating mechanism lock-out bar as shown below.



Refurbished DB-50 Breaker with Operating Mechanism Lock-Out Bar

WESTINGHOUSE PROPRIETARY CLASS 2

Failure Analysis Report

Purchase Order (PO): 02423936
Westinghouse Sales Order: 160387

Please remove the Lock-Out Bar before testing and use of the breaker. It is also recommended that all DB breakers receive the attention during maintenance that this breaker has received.

The cell switches have a few areas of concern and recommendations will be provided for each concern.

If these were the original cell switches that were provided with the switchgear, it is recommended that they be replaced with safety related switch assemblies provided by Westinghouse Electric Company.

P/N: 302C517G01 Y, please include the proper switch configuration with your orders.

The Maintenance Program Manual for Westinghouse Safety Related Type DB Circuit Breakers and Associated Switchgear, Revision 1, July 2011 defines that the DB cell switch is a Category B item and the procedure provided should not exceed 5 Years. These requirements are included in Section 7.3, Item 6. The two cell switches provided for this investigation appeared to be beyond the 5-year requirement based on the hardening of the graphite grease on the switch contacts.

In addition, the spring and plunger of the cell switch may be lubricated per the recommendations in the MPM manual, Chapter 9. It is acceptable to apply 53701GW lubricant to the spring during maintenance intervals. Furthermore, the 53701GW lubricant can be applied to the cell switch plunger's penetration point through the mounting plate. The cell switches included in this investigation did not have any lubrication applied to the spring and the plungers were lubricated with a foreign type grease.

It is recommended that all original cell switches be replaced and after the cell switches are replaced that they be maintained to the requirements provided in the Maintenance Program Manual for Westinghouse Safety Related Type DB Circuit Breakers and Associated Switchgear, Revision 1, July 2011.



25-Mar-21

Patrick J. Folmar
DB Product Engineer

WESTINGHOUSE PROPRIETARY CLASS 2

Failure Analysis Report

Westinghouse Electric Company LLC Nuclear
Parts Operations
Electro-Mechanical Parts Engineering
folmarpj@westinghouse.com
(724) 722-5969 – Phone

Purchase Order (PO): 02423936
Westinghouse Sales Order: 160387