

REDACTED

RECEIVED-FPSC
State of Florida



FEB 19 AM 10:19

Public Service Commission

COMMISSION CLERK
CAPITAL CIRCLE OFFICE CENTER • 2540 SHUMARD OAK BOULEVARD
TALLAHASSEE, FLORIDA 32399-0850

-M-E-M-O-R-A-N-D-U-M-

DATE: February 19, 2009

TO: Office of Commission Clerk (Cole)

FROM: Division of Regulatory Compliance (Harvey, Hallenstein, Rich) *HH* *HR* *RR*
Office of the General Counsel (Teitzman, Brooks) *TB* *BR*

RE: Docket No. 000121A-TP – Investigation into the establishment of operations support systems permanent performance measures for incumbent local exchange telecommunications companies. (AT&T FLORIDA TRACK)

AGENDA: 03/03/09 – Regular Agenda – Proposed Agency Action – Interested Persons May Participate

COMMISSIONERS ASSIGNED: All Commissioners

PREHEARING OFFICER: Carter

CRITICAL DATES: None

SPECIAL INSTRUCTIONS: None

FILE NAME AND LOCATION: S:\PSC\RCP\WP\000121A.RCM.DOC

Case Background

By Order No. PSC-01-1819-FOF-TP, issued September 10, 2001, in Docket No. 000121A-TP, the Commission adopted a Performance Assessment Plan for the purpose of monitoring performance levels of Operations Support Systems (OSS) provided to CLECs. The performance measurement plan provides a standard against which CLECs and the Commission can measure performance over time to detect and correct any degradation of service provided to CLECs. AT&T's performance measurement plan also includes a Self-Effectuating Enforcement Mechanism (SEEM) remedy plan which includes payments to CLECs (Tier 1) and to the State of Florida (Tier 2) when AT&T's performance fails to meet the standard. The Order also recognizes the Commission's vested authority, per Section 364.01(3), Florida Statutes, to provide regulatory

DOCUMENT NUMBER-DATE

01382 FEB 19 8

FPSC-COMMISSION CLERK

oversight necessary to ensure effective competition in the telecommunications industry. This docket has remained open since that time to address issues and concerns arising from OSS performance.

Following the BellSouth and AT&T merger, AT&T began plans to migrate and consolidate the former BellSouth 9-state southeast OSS platform into a single pre-ordering and ordering operations support systems platform for use across AT&T's 22-state region. At the time of the merger, AT&T's Local Wholesale OSS operated uniformly in all of AT&T's 13-state region for many of the same CLEC customers doing business in the former BellSouth 9-state region. AT&T determined that the 13-state OSS system would produce greater efficiencies for the benefit of both AT&T and its customers throughout the 22-state region.

In 2007, AT&T started the process of providing official notification to CLECs of its OSS consolidation plans, known as the 22-state OSS Release. The 22-state OSS Release plan involves a phased-in approach over several years. The first phase commenced with the April 19, 2008 release (April Release).

Numerous CLEC-impacting issues arose in connection with the April Release. As a result, on May 12, 2008, Cbeyond Communications, LLC (Cbeyond), Time Warner Telecom, LP (TWTC), and DeltaCom, Inc. (Deltacom), jointly referred to as the petitioners, filed a petition with the Commission requesting a third-party independent audit of the April Release.¹ The petition also requested a stay of CLEC-impacting OSS Releases, that the Commission show cause AT&T to explain in detail the circumstances surrounding the April Release, and why AT&T should not be penalized for its failure to appropriately implement the April Release.

AT&T acknowledged that a variety of CLEC-impacting issues arose in connection with the April Release. On July 31, 2008, a conference call was held between staff and the parties exploring the possibility that an audit be conducted by Commission staff. After further discussion, on August 5, 2008, the parties agreed to the audit being conducted by Commission staff and entered into a stipulation. Per Commission Order No. PSC-08-0618-PAA-TP, filed in Docket 000121A-TP, the Commission approved the stipulation.

The stipulation further states that the petitioners would dismiss the request for an independent audit and hold the remaining portions of the petitioner's complaint in abeyance, pending the Commission's vote on staff's recommendation addressing the final audit report. On September 12, 2008, the petitioners filed their agreement and Notice of Dismissal of their request for an independent audit with prejudice. The remaining portions of the complaint held in abeyance are the delay of future 22-state OSS releases and the request for a show cause proceeding.

Staff's audit report was completed in January 2009, and it includes staff's opinion as to whether appropriate and adequate measures have been undertaken to prevent CLEC-impacting issues with future scheduled 22-state OSS releases. In summary, the audit report contains 18

¹ On September 26, 2008, Time Warner Telecom filed in Docket 00012A-TP a Notice of Withdrawal from participation in the complaint.

recommendations for improvement resulting from the review of AT&T's April 2008 OSS Release.

The parties to the stipulation anticipated that the final audit report and staff recommendation to the Commission will contain Commission staff's opinion as to whether appropriate and adequate measures have been undertaken to prevent CLEC-impacting issues with future scheduled 22-state OSS releases. The stipulation also required staff's opinion as to what, if any, additional corrective action is necessary and, if so, what action is recommended.

This recommendation addresses the portions of the petitioners complaint held in abeyance.

Jurisdiction

The Commission is vested with jurisdiction over this matter pursuant to Sections 364.01(3) and (4)(g), Florida Statutes. Pursuant to Section 364.01(3), Florida Statutes, the Florida Legislature has found that regulatory oversight is necessary for the development of fair and effective competition in the telecommunications industry. To that end, Section 364.01(4)(g), Florida Statutes, provides, in part, that the Commission shall exercise its exclusive jurisdiction in order to ensure that all providers of telecommunications service are treated fairly by preventing anticompetitive behavior. Furthermore, the FCC has encouraged the states to implement performance metrics and oversight for purposes of evaluating the status of competition under the Telecommunications Act of 1996.

Discussion of Issues

Issue 1: Should AT&T be allowed to move forward with the next 22-state OSS release?

Recommendation: Yes. Staff recommends that AT&T be allowed to move forward with the next 22-state OSS release on the condition that selected Tier 1 and Tier 2 Self-Effectuating Enforcement Mechanism (SEEM) remedies are doubled for each data month beginning with implementation of the next 22-state OSS release, for a period of six months. The performance measurement categories that should be included are *OSS (Pre-ordering)*, *Ordering*, *Provisioning*, and *Change Management*. After the implementation of the next 22-state OSS release, staff will recommend if the Commission should take any further action on this matter. (Harvey, Hallenstein, Rich)

Staff Analysis:

Staff's Audit Report

Staff's audit (Attachment A) revealed AT&T's management's lack of understanding of the magnitude and complexity of the conversion effort from the beginning. The report states that failures were evident in AT&T's planning, organizing, directing, and control of this project. Staff's audit report contains 18 recommendations for improvement that resulted from the review of AT&T's April 2008 OSS Release. The scope of the review included AT&T's root cause analysis of the April Release failures, the defect management process, and AT&T's commitments made to the Florida Public Service Commission. Staff believes that AT&T has taken steps to resolve many of the identified problems. However, there are still many unknowns.

Staff acknowledges that AT&T has made a strong effort to remedy the problems identified during the April Release. AT&T has implemented numerous improvements and key resolutions, such as an expanded test plan and more effective vendor coordination. Staff has been able to validate the resolution of several concerns with the April Release. Additionally, as AT&T indicated, there have been two post-April OSS releases implemented in August 2008 and November 2008. Both had fewer defects, but staff notes that these releases are not 22-state impacting and the scope and complexity are not comparable and not indicative of the management performance required for a 22-state release, such as the April Release.

As discussed in staff's audit report of the April Release, staff is concerned that AT&T has made numerous commitments which promise future compliance with policies or procedures or improved future performance. With only such statements or promises, Commission staff cannot fully opine as to whether all appropriate and adequate measures have actually been undertaken to prevent CLEC-impacting issues with future 22-state OSS releases. Staff is also concerned that AT&T has not given adequate attention to the 18 recommendations in the audit report. As a result, staff must rely on AT&T's attestation of readiness to move forward. To ensure the adequacy of future 22-state OSS releases, staff believes that AT&T should be held accountable in a material manner for its decision to move forward.

Staff's Initial Proposal

On a December 5, 2008 conference call with the parties, staff proposed that AT&T double the Florida SEEM remedies for a period of six months, beginning with implementation of the next 22-state OSS release currently scheduled for July 2009. Staff further proposed that this increase in SEEM payments would be in lieu of the petitioners' request for the Commission to initiate a show cause proceeding to require AT&T to explain why it should not be penalized for its failure to appropriately implement the April Release. After three months of negotiations, the parties failed to accept staff's proposal or to reach a compromise, therefore, on January 28, 2009 staff sought written comments from the parties to explain their positions regarding the doubling of SEEM payments to be used as an incentive to ensure the adequacy of future 22-state releases.

AT&T's Response to Staff's Initial Proposal

In AT&T's February 6, 2008 response to staff's request for written comments, AT&T argues that staff's proposal is unnecessary, counterproductive, and, if implemented, would not necessarily ensure that future OSS releases are achieved without any major defects. Furthermore, AT&T argues that staff's proposal would result in an unwarranted financial windfall to CLECs in Florida, because SEEM payments would automatically double regardless of AT&T's performance.

However, on page 9 of AT&T's written comments, AT&T appears to offer suggestions for improving staff's proposal. AT&T believes the proposal should be clear that it is limited to only the next 22-state release, limited to selected *OSS* and *Ordering* performance measures, limited to Tier I SEEM payments, and limited to a period of three months.² Additionally, AT&T believes a tiered approach, where payments for performance below the benchmark are tied to the level of performance would be less punitive. AT&T believes a SEEM liability cap is also crucial to the fairness. Without a cap, AT&T believes AT&T's exposure is excessive and unwarranted.

AT&T specifically noted that over \$5 million in SEEM remedies were paid in Florida and over \$16 million paid over its 9-state region in connection with the April Release. AT&T further notes that this \$16 million is no longer available to invest in other capital improvements, including a number of CLEC OSS improvement requests. AT&T stated that "When the cost of prospective OSS improvements exceed well beyond actual capital dollars, AT&T must re-evaluate how shareholder funds should be invested." AT&T further added, "it has cut 10-15% from its capital budget this year in response to the dire economic conditions." AT&T maintains that, "staff's proposal is likely to discourage, rather than encourage, investment in local wholesale OSS."

In response to the petitioners' request for a show cause proceeding, AT&T admits that a variety of CLEC-impacting issues arose in connection with the April Release, but denies that Order No. PSC-01-1819-FOF-TP entitles the CLECs to any requested relief. AT&T states that,

² AT&T's comments appear to suggest that only the following performance measures be included in staff's proposal: P0-2 Loop Makeup Response Time; O-2 Acknowledgement Message Completeness; 0-3 Percent Flow-Through Service Request; 0-8 Reject Interval; 0-9 Firm Order Confirmation Timeliness; 0-11 Firm Order Confirmation and Reject Response Completeness.

“Staff makes no finding or observations that AT&T Florida refused to comply with, or willfully violated, any Commission rule or order in connection with the April Release. Accordingly, there is no statutory basis for the Commission to penalize AT&T Florida in connection with the April Release.” As a result, AT&T is requesting that the Commission issue an Order dismissing the “show cause” complaint.

CLECs’ Response to Staff’s Initial Proposal

On February 6, 2009, the petitioners and CompSouth filed a response to staff’s request for written comments. Both parties support staff’s proposal and point to the proposal as a way to help ensure that future OSS releases will minimize competitive impact to the CLEC community. The petitioners maintain that remedies paid under AT&T’s SEEM Plan are for the purpose of ensuring quality OSS. The petitioners further state that, “Since these penalties do not represent damages and do not in any way recompense CLECs for the harm and damage they incurred as a result of the April Release failure, it is important that the SEEM plan actually provide the appropriate level of incentive.” The petitioners believe staff’s original proposal meets this important requirement.

The petitioners refer to Section 4.2.1 of the SEEM Plan to support their argument wherein it states:

The application of the Tier-1 and Tier-2 Enforcement Mechanisms does not foreclose other legal and regulatory claims and remedies available to each CLEC.

In addition to supporting staff’s proposal, the petitioners and CompSouth further propose that the following items be included:

- CLECs should be provided with complete access to all data underlying the audit to help them better understand exactly where the flaws and errors in the process occurred. This access will help CLECs better monitor future OSS releases for potential problems and issues.
- Selected metrics should be added to Tier 1 to further ensure that AT&T has the proper incentive to manage future software releases.³

Another CLEC, not a signatory to the petition, also responded to staff’s request for comments on the proposal to double SEEM payments. In its response, the CLEC stated, “to double the SEEM performance measurement payments does not go far enough to persuade AT&T to take prudent precautions and perform appropriate testing prior to future releases.” The CLEC further stated that staff’s proposal “. . . is not sufficient to deter AT&T from making

³ The CLECs propose that the following performance measurements be included in the SEEM Plan as Tier 1 measures: CM-1 Timeliness of Change Management Notices; CM-3 Timeliness of Documentation Associated with Change; CM-6 Percentage of Software Errors Corrected in X Business Days; OSS-2 Add LASR to OSS-2 Interface Availability Metric.

similar blunders in the future and does not adequately compensate the CLECs for the tremendous harm AT&T caused by their highly improper actions.”⁴

The petitioners’ and CompSouth are also requesting that the Commission proceed with a show cause order in the event that the Commission does not adopt staff’s proposal. The petitioners cite Order No. PSC-01-1819-FOF-TP (OSS Order) issued on September 10, 2001, in Docket No. 000121-TP, in which the Commission recognized its authority to initiate a show cause. The order states if, “BellSouth’s (now AT&T) service to ALECs (now CLECs) had deteriorated severely, we could require a show cause proceeding to investigate the causes and potential remedies. ALECs would be free to file a complaint with this Commission, as well, in this case.” The petitioners maintain the position that the April Release was fatally flawed, inadequately tested, and released without appropriate safeguards, making it impossible for CLECs to conduct business. Because the April Release negatively affected thousands of CLEC orders, the petitioners believe that each individual CLEC impacting event “constitutes a separate event for which the Commission may assess a fine of \$25,000 per event.”

Staff’s Modified Proposal and Conclusion

Staff’s audit revealed that AT&T failed to adequately plan and implement the April Release. While AT&T has done much to correct the April Release errors, there are many issues which staff cannot unequivocally affirm AT&T’s readiness for the next 22-state OSS release.

Because staff cannot fully ascertain AT&T’s readiness, staff is left to rely on AT&T’s attestation of readiness. Staff originally proposed to the parties that AT&T should be required to double the monthly Tier 1 and Tier 2 SEEM remedies for a period of six months beginning with implementation of the next 22-state OSS release. However, after reviewing comments from the parties, staff believes its proposal should be modified. The SEEM measures to be doubled should be only those performance measurement categories which may be impacted by the release. The performance measurement categories that should be included in staff’s modified proposal are *OSS (Pre-ordering)*, *Ordering*, *Provisioning*, and *Change Management*.⁵

Staff strongly disagrees with AT&T’s suggestion to limit the doubling mechanism to only Tier 1 performance measurements.⁶ To do so would eliminate the *Change Management* category from being included in the doubling mechanism since these measurements are Tier 2 only. The *Change Management* performance measurements are critical to assessing the impact and quality of an OSS release. Among other things, these measurements assess how quickly AT&T responds to software errors. Additionally, AT&T’s changes to the next 22-state OSS release will directly impact both the *OSS (Pre-ordering)* and *Ordering* performance measurements. Two of the three *Pre-Ordering* performance measurements are Tier 2 only. Staff believes that it is

⁴ Saturn Telecommunication Services, Inc. (STS) filed written comments with the Commission on February 6, 2009, in Docket 000121A-TP.

⁵ Excluded performance measurement categories are *Maintenance and Repair*, *Billing*, *Trunk Group Performance*, and *Collocation*.

⁶ SEEM Tier 1 remedies are payable to Florida CLECs each month for specific performance measures that resulted in noncompliant service. SEEM Tier 2 remedies are paid to the state and are triggered by three consecutive months of failure at the submetric level when AT&T performance is out of compliance or does not meet the benchmark for the aggregate of all CLEC data.

critical that these performance measurements be included. In sum, staff sees no reason why the doubling mechanism should be limited to only the Tier 1 performance measurements.

Staff also carefully reconsidered the duration of its proposal to double remedies for a six month period. Staff maintains that six-months is the appropriate timeframe. Staff believes AT&T took at least six-months to recover from the April Release. Staff points to the increase in SEEM total dollars paid over the six month period after the April Release as an indicator of the time it took AT&T to correct issues in connection with the Release. Furthermore, staff also considered the length of time AT&T needed to resolve its list of commitments and key learnings. In both cases, AT&T reported longer than a three month period to take corrective action.⁷

In making its original proposal, staff considered several SEEM trigger mechanisms; however, all were found to have some type of bias, be easily manipulated, or be difficult to implement and audit. Under staff's proposal, AT&T is not being required to re-program the monthly performance measurement system used to determine SEEM payments. Doubling of SEEM will be easy to implement and transparent to all. AT&T's tiered approach proposal, where payments for performance below the benchmark are tied to the level of performance, is overly complicated and would be dependent on AT&T appropriately modifying the code for the SEEM Plan. Unless another audit is conducted, staff has no way of validating whether AT&T's proposed tiered approach would be implemented correctly.

AT&T's proposal to implement a liability cap gives staff further concern that AT&T may not be ready for the next 22-state OSS release. The fact that AT&T thinks a cap is needed is a concern to staff with regards to the readiness of AT&T. AT&T has made no proposal as to what the cap should be. Staff notes that Section 4.8, Enforcement Mechanism Cap, of the SEEM Plan already exists and should suffice for the purpose of staff's proposal. This cap has been a part of the SEEM Plan since its inception.

Staff believes the doubling of selected SEEM performance measures will serve as an incentive to ensure AT&T's readiness. Over 71,000 CLEC orders in AT&T's 9-state region were negatively affected by the April Release. During the April Release, the CLECs' ability to interface with its customers was significantly impacted including the ability to bring on new customers, manage existing customers, and migrate moving customers. As a result of the April Release, the CLECs experienced lost business, poor service, and alleged discriminatory treatment. If additional problems arise with the next 22-state release, the risk of CLECs losing additional customers is greater because of the harm experienced during the April Release. It is because of this increased risk to the CLECs that staff believes these additional remedies are warranted.

Staff has calculated an approximation of the potential remedies associated with staff's revised SEEM doubling proposal and believes these remedies to be appropriate. For the six months prior to the April 2008 OSS Release (October 2007 through March 2008), Florida Tier 1 remedies for the selected performance measurements averaged \$55,192 per month and Tier 2

⁷ Over 54% percent of key learnings took longer than three months to resolve. Additionally, AT&T failed to provide the resolution or closed dates for 28% of the key learnings.

remedies averaged \$20,017 per month. Total Florida SEEM remedies for the selected performance measurements averaged \$75,209 per month. Doubling the Florida SEEM remedies, as proposed by staff in this recommendation, would increase remedies for the selected performance measurements to an average of approximately \$150,418 per month. Assuming AT&T's next 22-state release contains minimal problems, the remedies for staff's recommended performance measurements may amount to \$902,508 over a six month period. This represents an incremental difference of \$451,254 over what is paid in SEEM for these selected performance measures during a six month typical service level period.⁸

In response to AT&T's economic concerns, it is staff's position that neither AT&T's level of financial support required to meet its federal obligations to provide nondiscriminatory access to OSS, nor the encouraging and/or discouraging of "investment in local wholesale OSS" are at issue in this proceeding. However, staff would note that "dire economic conditions" do not relieve the company of the Telecommunication Act's requirements, nor do they excuse poor performance in managing the April 2008 release. Furthermore, another failed release would have a significant impact on CLECs in the same dire economic environment. Staff's proposal is directed at rectifying those failures and at preventing future recurrences.

In response to the petitioners and CompSouth's request for additional items to be included in staff's proposal, staff believes these requests are outside the scope of this recommendation. The request for access to the data underlying staff's audit should be addressed directly with AT&T. The data is currently protected under an AT&T claim of confidentiality. Additionally, the request for selected measures to be included in AT&T's wholesale Performance Assessment Plan as SEEM Tier 1 measures should be raised and addressed in staff's next review to assess and revise the Performance Assessment Plan.

Staff agrees with the petitioners and CompSouth that it is important that the SEEM plan actually provide the appropriate level of incentive. For example, AT&T pays \$10 per failed *OSS (pre-ordering)* transaction and \$20 per failed *ordering* transaction for the first month of occurrence. The April Release has made staff question whether the SEEM fee schedule is an appropriate incentive for AT&T to ensure that future OSS releases are adequately implemented.

Staff is also modifying its initial proposal regarding the petitioners' request for a show cause proceeding. Staff's initial proposal was to double SEEM remedies in lieu of the petitioners' request for the Commission to initiate a show cause proceeding. As a result of modifying the SEEM doubling proposal and to ensure the adequacy of the next 22-state OSS release, staff believes it is necessary to postpone the Commission's consideration of the petitioners' request for a show cause proceeding until after implementation of the next 22-state OSS release.

Staff recommends that AT&T be allowed to move forward with the next 22-state OSS release on the condition that selected Tier 1 and Tier 2 Self-Effectuating Enforcement

⁸ Staff's original proposal to the parties included all performance measurements. Doubling all Florida SEEM remedies would increase the remedies to an average of approximately \$176,000 per month. Over a six month period, remedies would total to \$1,056,000. This represents an incremental difference of \$527,000 over what is paid in SEEM during a six month typical service level period.

Docket No. 000121A-TP

Date: February 19, 2009

Mechanism (SEEM) remedies are doubled for each data month beginning with implementation of the next 22-state OSS release, for a period of six months. The performance measurement categories that should be included are *OSS (Pre-ordering)*, *Ordering*, *Provisioning*, and *Change Management*. After the implementation of the next 22-state OSS release, staff will recommend if the Commission should take any further action on this matter.

Issue 2: Should this docket be closed?

Recommendation: No. If the Commission approves staff's recommendation in Issue 1 the resulting Order will be issued as a Proposed Agency Action. The Order will become final upon issuance of a Consummating Order, if no person whose substantial interests are affected timely files a protest within 21 days of the issuance of the Order. Staff will bring a recommendation back to the Commission addressing the petitioners' request for the Commission to initiate a show cause proceeding at a later date. This docket should remain open pending the implementation of the Commission's decision and for purposes of future performance measure monitoring. **(Teitzman)**

Staff Analysis: If the Commission approves staff's recommendation in Issue 1, the resulting Order will be issued as a Proposed Agency Action. The Order will become final upon issuance of a Consummating Order, if no person whose substantial interests are affected timely files a protest within 21 days of the issuance of the Order. Staff will bring a recommendation back to the Commission addressing the petitioners' request for the Commission to initiate a show cause proceeding at a later date. This docket should remain open pending the implementation of the Commission's decision and for purposes of future performance measure monitoring.

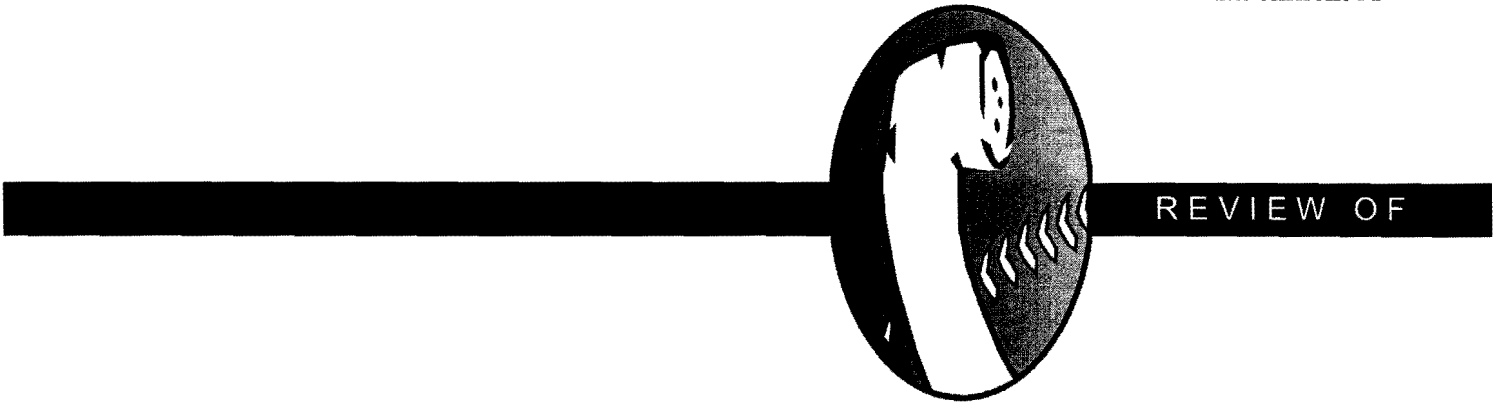

AT&T's OSS
April 2008 Release
Analysis and Resolutions

By Authority of
The State of Florida
Public Service Commission
Division of Regulatory Compliance
Bureau of Performance Analysis

DOCUMENT NUMBER-DATE

01382 FEB 19 08

FPSC-COMMISSION CLERK

Review of
**AT&T's OSS April 2008 Release
Analysis and Resolutions**

Lisa S. Harvey
Bureau Chief, Performance Analysis

Jerry Hallenstein
Government Analyst II

David Rich
Operations Review Specialist

January 2009

By Authority of
The State of Florida
Public Service Commission
Division of Regulatory Compliance
Bureau of Performance Analysis

PA-08-08-005

TABLE OF CONTENTS

| Chapter | Page |
|--|------|
| 1.0 EXECUTIVE SUMMARY | |
| 1.1 Introduction | 1 |
| 1.2 Scope and Objectives | 1 |
| 1.3 Methodology | 2 |
| 1.4 Overall Recommendations and Opinion | 2 |
| 2.0 BACKGROUND AND PERSPECTIVE | |
| 2.1 AT&T's April Release Issues | 9 |
| 2.2 Auditing and Quality Assurance | 10 |
| 2.3 August 2008 Stipulation..... | 11 |
| 3.0 KEY LEARNINGS & ROOT CAUSE ANALYSIS | |
| 3.1 Introduction | 15 |
| 3.2 Key Learnings | 15 |
| 3.3 Root Cause Analysis | 17 |
| 3.4 Resolution Analysis | 19 |
| 3.5 Open Key Learnings | 21 |
| 3.6 Prematurely Closed Key Learnings | 22 |
| 3.7 Key Learnings & Root Cause Analysis Conclusions..... | 23 |
| 4.0 DEFECT MANAGEMENT | |
| 4.1 Introduction | 27 |
| 4.2 Pre-Production Defect Management | 27 |
| 4.3 Production Defect Management..... | 31 |
| 4.4 Defect Classifications..... | 34 |
| 4.5 Defect Methodology and Organizational Changes | 36 |
| 4.6 Defect Management Conclusion..... | 37 |
| 5.0 COMMITMENTS & CLEC COMMUNICATIONS | |
| 5.1 Commitment Objectives..... | 41 |
| 5.2 Resolve April Release Defects..... | 41 |
| 5.3 Expand CLEC Communications | 42 |
| 5.4 Develop an Expanded Test Plan | 43 |
| 5.5 Provide Proactive Support to Email Manual Ordering Process | 45 |
| 5.6 Proactive Billing Adjustments | 46 |
| 5.7 Center/Support Team Responsiveness..... | 47 |
| 5.8 Commitments & CLEC Communications Conclusion | 47 |
| 6.0 APPENDICES | |
| Appendix A: Ordering Processes | 55 |
| Appendix B: Sample of Key Learnings by Category..... | 65 |
| Appendix C: Pre-Production Defect Management Key Learnings..... | 73 |

Appendix D: Production Defect Management Key Learnings 77
Appendix E: Regional Severity Comparison 81
Appendix F: Staff’s Analysis of AT&T’s Commitments 85
Appendix G: Glossary 99

7.0 COMPANY COMMENTS.....105

TABLE OF EXHIBITS

| Exhibit | | Page |
|----------------|--|-------------|
| 1 | AT&T Key Learnings by Category | 16 |
| 2 | Key Learnings Prioritizations | 17 |
| 3 | Pre-Production Defects by Severity | 28 |
| 4 | Production Defects..... | 31 |
| 5 | Warranty Period Defects..... | 32 |
| 6 | Defect Remediation Period by Severity | 34 |
| 7 | AT&T's Electronic Pre-Ordering and Ordering Process Flow Pre-April Release | 56 |
| 8 | AT&T's Manual Order Facsimile Process Flow Pre-April Release..... | 58 |
| 9 | AT&T's Partially Mechanized Order Process Flow Pre-April Release | 59 |
| 10 | AT&T's 22-State Consolidated OSS Release Plan | 62 |
| 11 | AT&T's Manual Order Email Process Flow Post-April Release | 63 |

1.0 EXECUTIVE SUMMARY

1.0 Executive Summary

1.1 Introduction

Following the BellSouth and AT&T merger, AT&T began plans to consolidate the wholesale operations support systems (OSS) of the two companies. The OSS consolidation plans are known as the 22-State OSS Release. The 22-state reference refers to the merger of the 13-state AT&T region with the 9-state BellSouth region.¹ AT&T started the process of providing official notification to CLECs in 2007. The 22-State OSS Release plan involves a phased approach over several years. The first phase commenced with the April 19, 2008 release (April Release).

Numerous CLEC-impacting issues arose in connection with the April Release. As a result, on May 12, 2008 Cbeyond Communications, LLC, Time Warner Telecom, LP, and DeltaCom, Inc., jointly referred to as the petitioners, filed a complaint with the Commission requesting a third-party independent audit of the April Release.² The complaint also requested a stay of future 22-state OSS releases and issuance of a show cause order by the Commission. The proposed show cause would require AT&T to explain why it should not be penalized for its failure to appropriately implement the April Release.

On July 31, 2008 a conference call was held between staff and the parties exploring the possibility that the audit be conducted by Commission staff. After further discussion, on August 5, 2008, the parties agreed to the audit being conducted by Commission staff and entered into a stipulation. Per Commission Order No. PSC-08-0618-PAA-TP, filed in FPSC Docket 000121A-TP, the Commission approved the stipulation. The stipulation also states that the remaining portions of the petitioners' complaint will be held in abeyance pending a vote on Commission staff's recommendation addressing the final audit report.³

1.2 Scope and Objectives

The parties to the stipulation acknowledged and accepted that the audit shall encompass the following three objectives:

- ◆ Documentation and assessment of AT&T's root cause analysis associated with the April Release.
- ◆ Documentation and assessment of the software defect resolution process associated with the April Release.

¹ The 9-state legacy BellSouth region includes the states of Florida, Georgia, Alabama, Tennessee, Mississippi, Louisiana, South Carolina, North Carolina, and Kentucky. The 13-state AT&T region refers to the pre-merger SBC Communications' region and includes the states of Texas, Kansas, Missouri, Illinois, Indiana, Michigan, Ohio, Wisconsin, California, Nevada, Arkansas, Oklahoma, and Connecticut.

² On September 26, 2008, Time Warner Telecom filed in Docket 000121A-TP a Notice of Withdrawal from participation in the complaint.

³ The remaining portions of the complaint are the delay of future 22-state OSS releases and the request for a show cause proceeding.

- ◆ Documentation and assessment of the pre-April Release and post-April Release CLEC communications.⁴

1.3 Methodology

Commission staff's review was conducted from September 2008 to November 2008. The information compiled in this report was gathered via company responses to document requests on-site interviews with key personnel, and documents filed in FPSC Docket No. 000121A-TP Established for Investigation into the Establishment of OSS Performance Measures for AT&T Florida. Specific information collected includes:

- ◆ Key learnings associated with the April Release,
- ◆ Defects and resolutions resulting from the April Release,
- ◆ Update of AT&T Commitments made to the PSC, and
- ◆ Expanded Testing Plans resulting from the April Release.

1.4 Overall Recommendations and Opinion

Staff believes AT&T's April Release was a critical failure. Some CLECs describe this April Release as the most significant competitively damaging OSS failure in the State of Florida since enactment of the Telecommunications Act of 1996. There appeared to be general lack of understanding of the magnitude and complexity of the conversion effort on the part of AT&T management from the beginning. Failures were evident in AT&T's planning, organizing, directing and control of this project.

It has now been over seven months since the April Release and many problems have since been resolved. Two minor subsequent OSS releases were implemented in August and November 2008 with fewer defects.⁵ However there are still many unknowns. Below are staff's observations and opinions that summarize what went wrong and the remedial action AT&T should take to prevent these problems from occurring in the future. Staff's conclusions and recommendations summarized below address the three audit objectives defined above.

1.4.1 Assessment of AT&T's Root Cause Analysis

Over [REDACTED] key learnings were identified by AT&T following the April Release. Staff believes the effort that AT&T has expended in its key learning process will go a long way in resolving issues with the April Release and hopefully, prevent future occurrences. Only [REDACTED] of the

⁴ Improved CLEC communications are addressed within a list of 32 commitments that AT&T made to the CLECs and Commission. Staff's documentation and assessment of CLEC communications are addressed in its review of these 32 commitments, included in Chapter 5.

⁵ The scope and complexity of the August and November release are not comparable to the April Release. Staff believes these releases are not indicative of the management performance required for a 22-state release.

key learnings remain open at this time. Staff anticipates that most, if not all of these will be resolved prior to the next 22-state release.

Staff is concerned that some of the key learnings were closed prematurely and without sufficient implementation. Staff also saw no evidence that AT&T has performed any type of follow-up to ensure that each recommendation was truly implemented, and has effectively resolved the problem. Additionally, staff believes that the root cause analysis conducted on the key learnings was weak and lacked formal process. A weak root cause analysis will result in not all of the causal relationships being identified, which will possibly result in a flawed or incomplete resolution. Staff is concerned that this may be the case for selected key learnings.

Staff further believes that AT&T missed an important opportunity to solicit input from its clients, the CLEC community, in this key learning process. AT&T made little attempt to gather lessons learned in the April Release from the CLEC community. Had it done so, valuable input regarding the AT&T and CLEC communication process may have been received.

The following are staff's recommendations based on the assessment of AT&T's Root Cause Analysis of the April Release:

- ◆ AT&T should resolve the ■ open key learnings prior to implementing the next 22-state release.
- ◆ AT&T should perform an internal review to ensure that all recommendations were completely and satisfactorily implemented and that each of the resolutions has adequately corrected the specified issue.
- ◆ AT&T should reevaluate its key learnings root cause analysis process and ensure that the approach followed is adequate.
- ◆ AT&T should reevaluate its root cause analysis for selected key learnings and ensure that all causal relationships have been identified and the resolutions identified are sufficient.
- ◆ AT&T should reevaluate resolutions which have been identified as prematurely closed, particularly those related to vendor coordination, and take appropriate action.
- ◆ AT&T should consider incorporating input from its CLEC clients in its future key learnings process.

1.4.2 Assessment of the Defect Management Process

Never before had AT&T ever encountered defect management problems such as those resulting from the April Release. The scope of defects encountered overwhelmed its ability to comprehensively respond in a timely manner and resource fatigue eventually became a problem multiplier. The scope, volume and magnitude of ■ production defects exceeded AT&T's experience, expectations, and ability to adequately respond. Problems with the defect management process exacerbated the situation.

Defect tracking management, from methodology to remediation, was often uncoordinated. Defects were captured in different applications that did not share common architecture or an ability to communicate. Disparate systems delayed the full comprehension of problems and subsequently hindered management response. Duplicative entries in two systems led to varying but continuing levels of confusion about specific responsibilities. The inability of various defect tracking systems to communicate or cross-populate denied management valuable analysis tools with which to easily and efficiently discern pre-production and production defect trends.

Prioritization of defects was impaired, allocation of resources was impacted and remediation arguably delayed in some instances. Though AT&T stated that defect analysis tools worked as designed in each region, some managers allowed that input errors and user oversights precluded optimum performance. The number of defects resulting from the April Release, particularly those of the most critical severity type, quickly outstripped AT&T's ability to immediately respond in a proactive, comprehensive, and systematic manner. Staff believes the company grossly underestimated the quantity, scope, and severity of defects that might be encountered with this release.

AT&T has demonstrated interest in getting to the core of April Release problems. Organizational structures and responsibilities for defect management have been adjusted. The defect tracking systems to be used for pre-production and production defects have been clarified. Training has increased in anticipation of future releases. Staff is concerned that it cannot fully discern the actual effectiveness of AT&T's defect resolutions until future releases take place. Additionally, staff is concerned with AT&T's defect root cause analysis, defect remediation timeframes, and accuracy and adequacy of the defect and change management service quality measures

The following are staff's recommendations based on the assessment of AT&T's defect management processes:

- ◆ AT&T should review the April Release defects and the root causes identified for each and ensure that a root cause has been identified and that appropriate action has been taken to prevent future occurrences.
- ◆ AT&T should improve its emphasis on defect root cause analysis through written policies and procedures, assignment of responsibilities and employee training.
- ◆ AT&T should continue to evaluate the consolidation of its defect management process to ensure that defects are resolved in an expedient manner and are compliant with the benchmarks established by the Florida Public Service Commission.
- ◆ AT&T should review the accuracy of data collection and reporting for all Change Management Service Quality Measures and the Self-Effectuating Enforcement Mechanism.

- ◆ AT&T should reevaluate its use of the CLEC impacting classification and either eliminate it, giving CLECs full visibility of defects, or have a clearly communicated definition of when it is applicable.

1.4.3 Assessment of CLEC Communications

AT&T implemented numerous corrective actions to address the communication failures that occurred pre- and post-April Release. Such corrective actions include having weekly status calls with CLECs to discuss April Release defects, providing CLECs with customer service contact information, implementing training guides, using the monthly Change Management Process (CMP) meetings to communicate the status of future OSS releases, and holding conference calls with CLECs after an OSS release.

While staff commends AT&T for taking necessary steps to improve communications with CLECs, staff believes that AT&T's Change Management monthly meetings, the principal outlet for communicating with CLECs, could be more effective. Staff further believes that AT&T's commitments do not address possible deficiencies or improvements needed in this Change Management Process, particularly the monthly Change Management calls, now that they have been consolidated under a 22-state umbrella. Lastly, staff believes that AT&T should give more indication or direction to the new Change Management meeting framework to evaluate and address CLEC concerns, including AT&T's 22-state process for escalating CLEC issues raised during the monthly meetings.

Staff is also concerned that AT&T's current Service Quality Measurement Plan (SQM) and Self-Effectuating Enforcement Mechanism Plan (SEEM) may not be adequately designed to capture failures of such magnitude as the April Release. AT&T's SQM and SEEM are designed to capture and compare the quality of service delivered to CLECs. AT&T's failure to comply with applicable SQM performance measurements will trigger SEEM remedy payments to CLECs and/or the state of Florida. Furthermore, the SQM and SEEM Plans methodology is based on the former BellSouth 9-state region. In some cases, system or process may have changed to be in agreement with processes used in the 13-state region. These issues need to be addressed.

The following is staff's recommendations based on the assessment of AT&T's pre- and post-April Release CLEC Communications:

- ◆ AT&T should clearly define and document the monthly Change Management meeting process.
- ◆ The Commission should commence an expedited review of AT&T's SQM and SEEM Plans prior to implementation of 22-state releases scheduled in 2009.

1.4.4 Assessment of AT&T's Commitment List

AT&T agreed to suspend future planned 22-state OSS releases until a list of 32 commitments made to the Commission was met. Staff recognizes that AT&T has taken positive steps to address these commitments and further believes action taken by AT&T should minimize

future disruptions. However, staff cannot validate that the changes that have been implemented will prevent future problems.

Of the 32 commitments staff agrees with AT&T's assessment to close 25. Staff's agreement is with the understanding that AT&T should be held accountable for upholding these commitments upon implementation of future 22-state OSS releases. For the remaining seven commitments, staff believes AT&T is closing these commitments prematurely. Staff contends that further supporting documentation is needed or the processes to resolve the commitments have yet to be fully addressed or implemented.

The following is staff's recommendations based on the assessment of AT&T's implementation of its commitments:

- ◆ AT&T should reevaluate its closure of seven commitments (items 1, 6, 11, 13, 14, 25, and 32 in Appendix F) and take necessary steps to assure the commitments have been fully addressed.
- ◆ AT&T should prepare and provide staff with pre-production and production defect status reports specific to each 22-state OSS release as they occur
- ◆ AT&T should provide staff with Expanded Test Plans for all future 22-state releases as they become available, and continue to educate CLECs on future 22-state release test plans.
- ◆ AT&T should continue to enhance the 22-state manual email ordering process to include efficiencies that previously existed in the manual processing of orders in the 9-state region.
- ◆ AT&T should provide staff with an assessment on current call center activities and staffing levels, and an assessment of call center activities based on future 22-state releases.

1.4.5 Conclusion

Overall, staff is concerned that AT&T has made numerous statements in its April Release key learning resolutions and commitments which promise future compliance with policies or procedures, or improved future performance. With only such statements or promises, Commission staff cannot fully opine as to whether all appropriate and adequate measures have actually been undertaken to prevent CLEC-impacting issues with future releases. Because the Commission cannot fully ascertain AT&T's readiness we are left in a position where we must rely on AT&T attestation of readiness. The decision to move forward with the next 22-state release must by its nature, reside with AT&T. Commission staff believes that the responsibility of readiness rests solely with AT&T management. Because staff cannot truly opine on readiness it believes that AT&T should be held accountable in a material manner for its decision to move forward with the next 22-state release.

2.0 BACKGROUND AND PERSPECTIVE

2.0 Background and Perspective

2.1 AT&T's April Release Issues

On April 19, 2008, AT&T implemented its first phase of its OSS consolidation plan. This phase consisted of a software release which mainly affected systems in the 9-state former BellSouth region. As a result of the April Release, Southeast CLEC orders submitted to AT&T following the release were adversely affected. CLECs experienced a severe impact in their ability to interface with AT&T's OSS.⁶ Staff believes numerous orders were delayed significantly due to a backlog. Additionally CLECs did not receive notifications such as: order confirmations, requests for order clarifications, disconnection notices, rejection notices, and communications related to meetings at the customer premises for installations for a period of time following the release. Numerous defects in both the software and the user documentation were identified after the release.

At a May 7, 2008, AT&T Change Management Process meeting between AT&T and participating CLECs, AT&T admitted that problems occurred with the April Release. At the meeting, AT&T provided a detailed chronology of events that occurred the first two weeks after the April release. According to AT&T, during the first week after the April Release, the following three situations caused the greatest impact:

- ◆ Outbound transactions to CLECs were monitored and appeared to be working. However, AT&T later discovered that outgoing transactions in the form of firm order confirmations, clarifications, and rejections were not being delivered to CLECs.
- ◆ A backlog of CLEC orders were created due to outages and instability of the graphical user interface (GUI) system used by AT&T Local Carrier Service Center (LCSC).
- ◆ The new manual email ordering process introduced numerous errors into CLEC orders. In some cases, information contained on the Local Service Request (LSR) was being transposed when worked by AT&T service representatives, certain fields on the orders were being changed after orders were submitted, and manual orders were reflected in the OSS as electronic. AT&T required all of these previously submitted orders to be supplemented or suffer "fatal reject" status.

The details of the second week after the Release are as follows:

- ◆ Some outgoing transactions were still not being received by CLECs, specifically those CLECs who submit orders using the XML application.

A table in the April Release Local Access Service Request System (LASR) application that the LCSC uses to process incoming transactions ran out of free space causing new orders to back up in LASR.

⁶ CLEC's pre- and post-April Release ordering processes are described in Appendix A.

2.2 Auditing and Quality Assurance

On May 15, 2008, Commission staff initiated an informal workshop to discuss issues surrounding the April Release and AT&T's plans for future OSS releases in the Southeast region. At the workshop, AT&T acknowledged that a variety of CLEC-impacting issues arose in connection with the April Release. AT&T estimated that 71,000 CLEC orders in the 9-state region were negatively affected by the April Release. Of these orders, AT&T stated that 59,000 were electronic orders, and 11,000 were backlogged manual orders.

The CLECs participating in the workshop submitted a list of nine action items in priority order that CLECs needed from AT&T to restore or improve productivity lost in the April Release. The list included the following items:

- ◆ Restore functions lost in the conversion to non-mechanized ordering via email.
- ◆ All defects, all severity levels need to be closed in 14 days.
- ◆ When editing orders, edit the complete LSR.
- ◆ Adequate trained staff must be restored.
- ◆ A new comprehensive approach to testing must be established.
- ◆ Commingled orders should be mechanized.
- ◆ Universal log-in and password for all OSS access.
- ◆ Data integrity needs to be restored.
- ◆ Remaining CLEC Best Practice Change Requests need to be accepted and scheduled.

At the workshop AT&T voluntarily committed to temporarily suspend future 22-state OSS Releases in the Southeast pending resolution of the April Release issues and to expand communications and testing of all future 22-state OSS Releases in the Southeast region. Upon Commission staff's request, AT&T memorialized and filed these commitments with the Commission on May 27, 2008. In the filing, AT&T also committed to resolve all April Release software defects, provide proactive support on the new email/manual ordering process, proactively process April Release billing adjustments, and review AT&T's call center and support team staffing levels to meet anticipated demand. AT&T's commitments and response to the CLECs action item list is discussed in detail in Chapter 5.

2.3 August 2008 Stipulation

On May 12, 2008, Cbeyond Communications, LLC (Cbeyond), Time Warner Telecom, LP (TWTC), and DeltaCom, Inc. (DeltaCom) filed a petition with the Commission requesting an audit of the April Release. The petition also requested a stay of CLEC-impacting OSS Releases and that the Commission show cause AT&T to explain in detail the circumstances surrounding the April Release and explain why AT&T should not be penalized for its failure to appropriately implement the April Release.

In the petition, the CLECs requested an independent audit be conducted that focuses on the cause of the OSS failures. In AT&T's response to the petition filed with the Commission on June 2, 2008, AT&T denies that an independent audit of the April Release is necessary. AT&T stated that it has provided, and will continue to provide, information and explanations regarding the April Release, and has fully supported CLEC requests for status, escalation, and assistance. AT&T also states that it will continue to respond to CLEC inquiries through individual customer support and weekly conference calls opened to all CLECs. AT&T asserts that its internal review and Expanded Test plan will include any necessary root cause analysis of the April Release issues.

A conference call was held between staff and the parties on July 31, 2008 exploring the possibility that the audit be conducted by Commission staff. After further discussions, on August 5, 2008, the parties entered into a stipulation and agreed to the audit being conducted by Commission staff. The scope of the audit would be to:

- ◆ Document and assess AT&T's root cause analysis associated with the April Release.
- ◆ Document and assess the software defect resolution process associated with the April Release.
- ◆ Document and assess the pre-April Release and post-April Release CLEC communications.

The scope was approved by FPSC Order PSC-08-0618-PAA-TP on September 23, 2008. Per the stipulation, AT&T also agreed to refrain from implementing future 22-State OSS releases until the Commission's vote of staff's recommendation addressing the final audit report or a mutually agreeable timeframe. Additionally, the stipulation states that AT&T shall still be accountable for its commitments filed with the Commission on May 27, 2008. The stipulation anticipated that the final audit report or staff recommendation to the Commission will contain Commission staff's view as to whether appropriate and adequate measures have been undertaken to minimize CLEC-impacting issues with future scheduled 22 State OSS releases.

3.0 KEY LEARNINGS & ROOT CAUSE ANALYSIS

3.0 Key Learnings & Root Cause Analysis

3.1 Introduction

One of the primary objectives of this audit was to document and assess AT&T's root cause analysis of the April Release. In response to a request for AT&T's root cause analysis staff was provided with a spreadsheet listing all the key learnings which were identified during the April Release.

During every software release, AT&T employs a key learning process that allows employees to identify what went right and what went wrong with the processes, tools, and other release activities. In April 2008, this same process was followed. Key findings were compiled and categorized in two phases at the conclusion of the release. Phase one was obtaining key learnings from the IT organization and was completed on May 16, 2008. Phase two was to solicit key learnings from the AT&T Business unit. This was completed on June 27, 2008. Over [REDACTED] AT&T employees identified [REDACTED] key learnings.

Once the key learnings were identified, AT&T employees formed teams and held facilitated meetings to determine the root cause for each key learning. The teams also developed action plans and assigned owners to each action plan for implementation. Meeting participants included employees from AT&T, as well as the three vendors⁷ who participated in the April Release.

3.2 Key Learnings

AT&T provided staff with a list of the [REDACTED] key learnings on August 29, 2008. Staff obtained an updated status report on the key learnings on October 24, 2008. This listing was extracted from a database maintained for purposes of tracking lessons learned after each release. The information provided to staff included the date the key learning was reported, the key learning review finding, the employee who identified the key learning, the phase in which the key learning occurred, the category of the key learning, the root cause, the employee responsible for resolution, the status, the resolution date, and the resolution.

The [REDACTED] key learning findings can be further sorted by categories as follows in **Exhibit 1**.

⁷ The vendors participating in the April Release were Amdocs, Accenture and Telcordia.

AT&T Key Learnings by Category

| Category | Number Identified ⁸ | Closed ⁹ | Open |
|------------|--------------------------------|---------------------|------------|
| [REDACTED] | [REDACTED] | [REDACTED] | [REDACTED] |
| [REDACTED] | [REDACTED] | [REDACTED] | [REDACTED] |
| [REDACTED] | [REDACTED] | [REDACTED] | [REDACTED] |
| [REDACTED] | [REDACTED] | [REDACTED] | [REDACTED] |
| [REDACTED] | [REDACTED] | [REDACTED] | [REDACTED] |
| [REDACTED] | [REDACTED] | [REDACTED] | [REDACTED] |

EXHIBIT 1

Source: Document Request 1-1

While the majority of the key learnings focused on areas for improvement, the key learnings listing also contained a type of finding classified as “what worked”. There were [REDACTED] “what worked” key learnings. These are policies, processes or procedures that AT&T employees believe worked well during the release. Generally, the “what worked” key learnings for the April Release fall into the following categories:

[REDACTED]

[REDACTED]

⁸ This includes 91 key learnings that AT&T identified as duplications relating to the April Release.

⁹ Status as of October 22, 2008.

¹⁰ Order of Magnitude 179 or OOM 179 is the project name given to the April Release.

| Key Learnings Prioritizations | | | |
|-------------------------------|-------------------------|------------|------------|
| Priority | Number of Key Learnings | | |
| [REDACTED] | [REDACTED] | [REDACTED] | [REDACTED] |
| [REDACTED] | [REDACTED] | [REDACTED] | [REDACTED] |
| [REDACTED] | [REDACTED] | [REDACTED] | [REDACTED] |
| [REDACTED] | [REDACTED] | [REDACTED] | [REDACTED] |

EXHIBIT 2 Source: Document Request 4-1

Some of the more significant key learnings identified by AT&T were:

[REDACTED]

[REDACTED]

[REDACTED]

[REDACTED]

[REDACTED]

[REDACTED]

[REDACTED]

Staff believes that the major issues experienced by AT&T include the [REDACTED]

[REDACTED] For detailed examples of key learnings see **Appendix B.**

3.3 Root Cause Analysis

AT&T's root cause analysis identified several main themes or issues. Staff believes the analysis revealed a major failure on the part of AT&T management to effectively plan, organize, direct and control the April Release. This failure is evidenced by the following root causes identified by AT&T:

[REDACTED]

[REDACTED]

^{11 11} The number following the key learning is the key learning identification number.

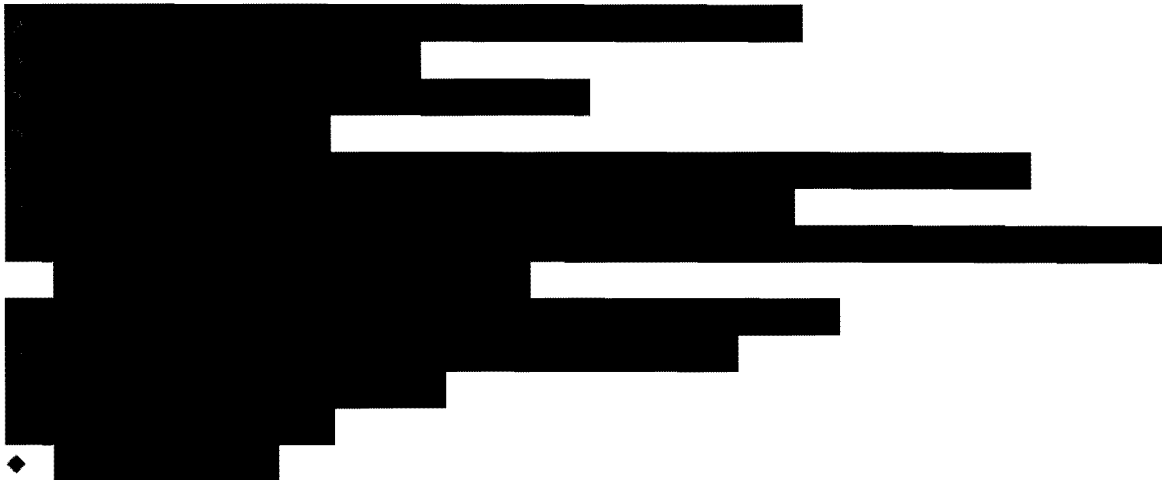

Staff is concerned about the quality of the root cause analysis performed by AT&T. One of the purposes of this audit was to ensure that AT&T had conducted an appropriate root cause analysis to ensure the problems with the April Release are prevented in the future 22-state releases. Root cause analysis is a problem-solving method aimed at identifying the root cause of problems or events. The practice is predicated on the belief that problems are best solved by attempting to correct or eliminate root causes, as opposed to merely addressing the immediately obvious symptoms. By directing corrective measures at root causes, it is hoped that the likelihood of problem recurrence will be reduced. General principles of root cause analysis are:

- ◆ Aiming performance improvement measures at root causes is more effective than treating the symptoms of a problem.
- ◆ To be effective, root cause analysis must be performed systematically, with conclusions and causes backed up by documented evidence.
- ◆ There is usually more than one root cause for any given problem.
- ◆ To be effective the analysis must establish all known causal relationships between the root cause(s) and the defined problem.

Staff does not believe that AT&T adhered to such formal principles for evaluation of the issues associated with the April Release. AT&T response to staff's request for AT&T's root cause analysis was the key learning list, which included a column labeled "root cause". A job aid describing the key learnings reporting process states

Staff does not believe any formal root cause analysis was conducted. Instead, employees merely offered opinions that were not critically examined by management. The root causes listed on the key learning document were typically one sentence in length, as shown in the above examples. Staff is not certain that all causal relationships between the root cause and the key learning issue were identified. Additionally, no supporting documentation was provided.

A general process for performing and documenting a root cause analysis is defined below:

1. Define the problem.
2. Gather data/evidence.
3. Ask “why” and identify and analyze the causal relationships associated with the defined problem.
4. Identify which causes if removed or changed will prevent recurrence.
5. Identify effective solutions that prevent recurrence, are within your control, meet your goals and objectives, and do not cause other problems.
6. Implement the recommended solutions.
7. Observe the recommended solutions to ensure effectiveness.

Staff does not believe that AT&T has adequately implemented a structured process such as this, in its root cause analysis. While employees have worked together to identify the resolutions to the key learnings, staff is concerned that AT&T has not adequately implemented steps number three, six and seven of the process defined above. Many of these resolutions have not been tested and observed to ensure effectiveness. Staff is concerned that the next 22-state release will be the first test of some of these new and improved processes.

Staff also believes that there are at least ■ root causes which should be reevaluated by AT&T.¹² In two cases, a root cause does not appear on the key learning log.¹³ In other cases, staff believes the key learning root cause analysis was weak or insufficient and can be improved by continuing to ask the question “why”. For example, ■

Another example is ■

3.4 Resolution Analysis

AT&T employees identified many beneficial resolutions to the key learnings from the April Release. Among the key resolutions identified by AT&T are:

¹² ■

¹³ ■

¹⁴ The number following the resolution represents the number of key learnings resolved by this resolution.

[REDACTED]

These resolutions directly address what staff considers to be some of the major issues during the April Release. Staff discussed most of these resolutions with AT&T during the audit to validate existence and implementation. Staff confirmed that a Technical Oversight Team and a Joint Architecture Team have been identified and that their roles and responsibilities' have been defined. Staff also reviewed the Expanded Test Plan for the November 2008 release and confirmed that the plan has been appropriately expanded. Staff also confirmed that AT&T has identified an integrated defect management process for the 22-states by requiring the Southeast to migrate to the defect system used in the 13-state region.

[REDACTED] of the [REDACTED] open key learnings are relating to the need for further vendor training. Staff confirmed that a procedure requiring a communication plan has been put in place, however staff cannot confirm whether the procedure is sufficient to address the issues raised in the key learnings.¹⁵ [REDACTED]

Staff is concerned that several of the key learnings resolutions are merely statements or promises to do better in the future.¹⁶ Staff has no way of validating statements that promise future adherence to a process. [REDACTED]

[REDACTED] Staff cannot validate the implementation of this resolution. [REDACTED]

[REDACTED] Many of the key learning resolutions to address these issues focus on a [REDACTED] While staff may be able to validate [REDACTED], staff has no way of validating [REDACTED] has adequately conveyed the needed information. [REDACTED]

[REDACTED] Staff can validate that the meetings are being held, however staff cannot guarantee that these meetings will resolve the issues. Until another major 22-state release occurs, staff will not know whether these resolutions have adequately resolved the concerns.

¹⁵ In the November 2008 Release AT&T posted information on it web-site as required by its communication plan. However, some of the information in the posting which was made for the CLEC benefit was erroneous.

¹⁶ [REDACTED]

3.5 Open Key Learnings

■ of the ■ key learnings still remain open as of October 22, 2008. Without complete closure staff is concerned that the company is still at risk of future issues. ■

■

■

■

■

■

■

¹⁷ ■

¹⁸ The number following the description is the number assigned to the key learning.

[REDACTED]

[REDACTED]

[REDACTED]

[REDACTED]

3.6 Prematurely Closed Key Learnings

Staff believes there are several key learnings that may have been closed without complete implementation.¹⁹

[REDACTED]

[REDACTED]

¹⁹ [REDACTED]

²⁰ [REDACTED]

[REDACTED]

[REDACTED]

[REDACTED]

[REDACTED]

3.7 Key Learnings & Root Cause Analysis Conclusions

Over [REDACTED] key learnings were identified by AT&T employees. AT&T has invested a good deal of time and employee resources in identifying key learnings, root causes and resolutions from the April Release. Staff believes the effort that AT&T has expended will go a long way in resolving issues with the April Release.

Staff has several concerns regarding the key learning analysis as it relates to preventing future problems. First, there are [REDACTED] key learnings that remain open as of October 22, 2008. [REDACTED]

[REDACTED] Over seven months have elapsed since the April Release. Staff questions whether AT&T paid appropriate attention to prioritization of its issues and worked its highest priority issues first. Despite this, staff anticipates, that most, if not all, of these key learning resolutions will be implemented prior to the next 22-state release.

Secondly, staff is concerned that some of the key learnings may have been closed without sufficient implementation. Staff did not see evidence that AT&T performed any type of follow-up to ensure that these recommendations were truly implemented and had effectively resolved the identified problem. Staff recommends that AT&T conduct an internal review of the key learning resolutions and validate that resolutions have been adequately implemented and that the resolution have actually resolved the issue in question. Staff also requests that AT&T review all

key learnings to determine whether other key learnings, in addition to those identified by staff, may have been prematurely closed.

Staff also believes that AT&T should reevaluate its root cause analysis for the key learning identified by staff in Section 3.3, as having weak or insufficient root causes. A weak root cause analysis will result in not all of the causal relationships being identified, which will possibly result in a flawed or incomplete resolution. Staff is concerned that this may be the case for selected key learnings. AT&T should reevaluate its key learnings root cause analysis process and ensure that the approach followed is adequate.

Staff believes that AT&T missed an important opportunity to solicit input from its clients in the CLEC community in this key learning process. AT&T made little attempt to gather lessons learned in the April Release from the CLEC community. Had it done so, valuable input regarding the AT&T and CLEC communication process may have been received.

Finally, staff is concerned that AT&T has made numerous statements in its key learnings which promise future compliance with policies or procedures, or improved future performance. With only such statements, commission staff cannot fully opine whether appropriate and adequate measures have actually been undertaken to prevent issues with future releases.

In summary:

- ◆ AT&T should resolve the ■ open key learnings prior to implementing the next 22-state release.
- ◆ AT&T should perform an internal review to ensure that all recommendations were completely and satisfactorily implemented and that each of the resolutions has adequately corrected the specified issue.
- ◆ AT&T should reevaluate its key learnings root cause analysis process and ensure that the approach followed is adequate.
- ◆ AT&T should reevaluate its root cause analysis for selected key learnings and ensure that all causal relationships have been identified and the resolutions identified are sufficient.
- ◆ AT&T should reevaluate resolutions which have been identified as prematurely closed, particularly those related to vendor coordination, and take appropriate action.
- ◆ AT&T should consider incorporating input from its CLEC clients in its future key learnings process.

4.0 DEFECT MANAGEMENT

4.0 Defect Management

4.1 Introduction

Documentation and assessment of the defect resolution process was identified as one of the three key objectives of this review. Staff reviewed both the pre-production and production defect management processes associated with the April Release. Sound defect tracking methodology is vital to correcting deficiencies in a software release and to improving internal processes.

The acceptable number of defects for a software release is generally considered dependent on the sensitivity relative to the field, enterprise, or business the software is designed to assist. For instance, air traffic control or military software would arguably have far smaller tolerances for defects than software updating a video game application. This rate should be established in the earliest stages of a scheduled software release, during the pre-design risk assessment phase, by the project development team. AT&T does not identify an acceptable number of defects in advance of a project or release. The company states its goal is zero defects.

Prior to initiation of the audit, AT&T had reported to the Commission that as of June 20, 2008 there were 229 production defects in the April Release.²¹ This information was not correct. Staff later discovered there were actually a total of [REDACTED] production defects. In addition, staff also learned there were [REDACTED] pre-production defects in the April Release.

4.2 Pre-Production Defect Management

Pre-production defects are those that are detected through software testing prior to implementation of the software on the release weekend. AT&T's objective is to ensure that all software testing defects are closed prior to the end of testing in accordance with system test exit criteria. AT&T manages pre-production defects in the application tool called Quality Center. The process begins with identification, validation and documentation of a defect. The process ends with validation of a code fix and the defect is then closed. Defect management can result in process improvement if adequate and sufficient data is captured and documented for each defect.

4.2.1 Pre-Production Defects

The April Release captured [REDACTED] total pre-production defects. The segregation by severity in **Exhibit 3** reveals:

²¹ AT&T's response to staff's data request was contained in PSC Order 08-0618-PAA-TP and stated there were 125 CLEC impacting defects and 104 non-CLEC impacting defects.

| Pre-Production Defects by Severity | | | |
|------------------------------------|---------------------|----------------------|--|
| Type | AT&T Classification | Number ²² | |
| Severity 1 | Critical | | |
| Severity 3 | Average | | |
| TOTAL | | | |

EXHIBIT 3

Source: Document Request 3

[REDACTED]

[REDACTED]

[REDACTED]

[REDACTED]

◆ [REDACTED]

At the time of the pre-release final code freeze in April, eight pre-production defects remained open.²⁴ AT&T stated that none were of the most critical type, Severity 1. AT&T further explained that each defect had a full workaround in place to allow normal operations until a permanent repair could be applied downstream, during a normally scheduled warranty or maintenance release.

²² [REDACTED]

²³ The number following the defect is the defect identification number.

²⁴ [REDACTED]

The eight pre-production defects still open at the time of the April Release were:

- ◆ Loop makeup inquiries, without data in some non-mandatory fields, resulted in the inquiry incorrectly being returned in an error status. (██████████, Severity 3)
- ◆ The LASR GUI display did not display all required fields though a test case proved the fields were addressed, and returned, in notifications. (██████, Severity 2)
- ◆ The LASR GUI was not recognizing certain field values. CLECs were instructed to use the LSR remarks section to indicate a need for special handling of these particular values, allowing LSC representatives to process the LSR manually. (██████, Severity 2)
- ◆ In LASR, duplicate error messages appeared on screen for service orders after a review had already been performed once and the item resubmitted for review. (██████, Severity 3)
- ◆ Firm Order Confirmations (FOC) and provider initiated notifications were being adversely affected for email manual local service requests (LSRs). Local Service Center (LSC) representatives could manually adjust in the LASR GUI. (██████, Severity 2)
- ◆ LASR/EU FOC view screen was displaying erroneous order numbers. (██████, Severity 2)
- ◆ There was no mechanism in place to ensure a line loss file was processed only once. LEO would process one order per day. LASR could process multiple files but had no means to ensure it didn't process the same file twice. This defect was noted in the log as minimally impacting CLECs because only eight CLECs had elected to receive line loss notices via EDI. (██████, Severity 2)
- ◆ Uncertainty whether a particular audit message appearing on pending service orders was necessary with LASR processing the orders. (██████, Severity 3)

According to AT&T, the most problematic defect associated with the April Release was lack of delivery of CLEC notifications. While this defect was not discovered until production, arguably it should have been uncovered in pre-production. Pre-production notification testing was not conducted end-to-end. AT&T admitted that, at least with respect to notifications, everyone "just sort of missed it". This proved to be a critical miss.

4.2.2 Pre-Production Defect Management Key Learnings

April Release pre-production defect management tracking was conducted using both Harvest and Quality Center, two defect management and tracking applications. Harvest was used in the 9-state region while Quality Center was used by Amdocs for all LASR-related pre-production defects. The employees in the 9-state region did not have access to Quality Center

during the April Release. This use of two defect tracking systems caused major problems for AT&T and was the subject of several key learnings.

During the April Release, [REDACTED] Selected key learnings furnished insight into the prevalent pre-production difficulties experienced by AT&T. A more detailed explanation of representative key learnings can be found in **Appendix C**. The following is a sample of the pre-production defect-related problems identified by AT&T to have been prevalent in the April Release:²⁵

- [REDACTED]
- [REDACTED]
- [REDACTED]
- [REDACTED]
- [REDACTED]
- [REDACTED]
- ◆ [REDACTED]

Several other pre-production management issues went unidentified by AT&T and ultimately proved problematic before the April Release. Perhaps most importantly, the individual responsible for pre-production defect management was replaced prior to the release and production phase. Staff believes this caused a lack of defect management operational continuity between pre-production and production environments and was a contributing factor to problems experienced.

4.2.3 Pre-Production Defect Management Resolutions

Several improvements have been incorporated to the pre-production defect management process since the April Release. In August 2008, AT&T began using Quality Center as the primary application for pre-production defect management. Not only are the two regions' processes now combined in a single reporting tool, but AT&T also asserts that communications regarding defect management have been improved and streamlined. Efforts to educate

²⁵ The number following the statement is the key learning identification number.

employees and managers on the defect process have been increased. Stricter controls are now in place for enforcement of the pre-production defect identification and tracking process.

4.3 Production Defect Management

Production defect management is the practice of managing defects found in software that has been implemented and released to the CLECs for use. This implementation occurs over the release weekend. The defect management process begins with the identification of a defect either by AT&T or its vendor. Proper validation and documentation of the defect follows, each an integral part of defect management. The process ends with validation of a code fix in the production environment. The defect is then closed.

4.3.1 Production Defects

AT&T tracks the number of defects encountered over the release weekend. This result is can compared to prior releases as a benchmark. Prior to the April Release, AT&T typically averaged [REDACTED] defects on a release weekend. During the April Release, a total of [REDACTED] defects were validated over implementation weekend, [REDACTED]

Following the April Release, a total of [REDACTED] production defects were reported as of September 5, 2008. Staff notes this number is significantly higher than the 229 production defects originally reported by AT&T to the Commission on June 30, 2008. **Exhibit 4** depicts the number of defects by CLEC impact and severity:

| Production Defects | | | | |
|-----------------------|------------------------|---------------------|-----------------------|------------|
| | Severity 1 Critical | Severity 2 Major | Severity 3 Average | Total |
| CLEC Impacting | 64 | 82 | 124 | 270 |
| TOTAL | [REDACTED] | [REDACTED] | [REDACTED] | [REDACTED] |

EXHIBIT 4

Source: Document Request 3

Staff analyzed the total production defects experienced during tri-annual releases for the two-year period 2006-2007. Comparison were made of numbers and types of defects for the entire years of 2006 and 2007, spread across three tri-annual releases each year, versus the

²⁶ CLEC impacting problems are cases where the interface is not working in accordance with the AT&T-SE baseline user requirements or the business rules that AT&T-SE has published or otherwise provided to the CLECs. These problems typically affect the CLEC's ability to exchange transactions with AT&T-SE and may include documentation that is in error, has missing information or is unclear in nature.

number and type of defects associated with only the April Release. This analysis demonstrates the magnitude of the problems and their potential for disruption to the company and to wholesale customers.



AT&T OSS software releases have a specified warranty period. This usually takes the form of a two-week period during which known defects are corrected through the execution of four maintenance releases. The goal of these maintenance releases is to fix any defects found with the software during and immediately after implementation. Because of the magnitude of problems with the April Release, the warranty period was extended from two to four weeks and defect reporting for this release continued until mid-August 2008.

Of the defects experienced during the extended warranty period for the April Release, slightly over half were CLEC impacting.



Exhibit 5 shows the warranty period defect by severity and CLEC impact.

| Warranty Period Defects | | | | |
|-------------------------|------------------------|---------------------|-----------------------|-------|
| Defects | Severity 1 Critical | Severity 2 Major | Severity 3 Average | Total |
| CLEC Impacting | 59 | 46 | 44 | 149 |
| TOTAL | | | | |

EXHIBIT 5

Source: Document Request 5

4.3.2 Production Defect Management Key Learnings

During the April Release, there were ■ key learnings derived from production testing defects. Studying a few representative examples from the key learnings provides insight into some of the more prevalent, recurring difficulties. A more detailed explanation of some of the production key learnings can be found in **Appendix D**. The following are among the most problematic production defects during the April Release:²⁷



²⁷ The number following the statement is the key learning identification number.

[REDACTED]

◆ [REDACTED]

4.3.3 Production Defect Management Resolutions

Key improvements have been implemented to the production defect management process since the April Release. A 22-state, production defect management process is now in place using Vantive. AT&T states it believes that communication regarding production defect management has been improved. AT&T states it has also implemented stricter controls of the production defect determination and tracking process. Training has been conducted to ensure that employees adequately understand the defect process.

The company stated that both the number and scope of practice exercises prior to releases have been increased to heighten operator proficiency and awareness. All managers involved with defect tracking and analysis have undergone remedial training following the April Release. Though no firm number of sessions could be identified by AT&T, the company stated that as many as three such sessions have been held since April and included not only defect managers but vendor representatives as well. These sessions were generally conducted using a teleconference bridge with PowerPoint guides sent to all participants.

As discussed in the previous chapter, [REDACTED] key learning remains open in production testing and defects category. [REDACTED]

4.3.4 Production Defect Root Cause Analysis

The defect management data base has a field for designating a root cause for each defect. Staff reviewed the root causes for the April Release defects to ensure that AT&T was taking appropriate action to prevent future occurrences. Staff found that:

[REDACTED]

◆ [REDACTED]

[REDACTED]

4.4 Defect Classifications

AT&T has two systems for classifying defects. Defects are classified by severity and by whether or not they are CLEC impacting. The manner in which the defect is classified has an impact on CLECs.

4.4.1 Severity Classification

During the April Release, AT&T did not employ a uniform severity methodology to classify defects. The 9-state and 13-state severity definitions were different, in the number of severity levels and the allowable number of days for remediation.

| Defect Remediation Period by Severity | | |
|---------------------------------------|-----------------------|-------------------------|
| Severity | 9-state Days Allowed* | 13-state Days Allowed** |
| 1 | No Information | 0 to 5 days |
| 3 | Within 30 days | 0 to 60 days |

EXHIBIT 6

* Source: AT&T SE Change Control Process Guide 10/28/08

** Source: Document Request 4-11

Application of a severity code is a manual process, requiring the employee opening a defect to assign a numerical value for the degree of severity based on established criteria. The assigned severity value is then verified prior to permanent inclusion on the defect list.

Defects within the 9-state region are classified on a severity scale of 1 (critical) to 4 (cosmetic). Defects within the 13-state region are also ranked for severity but use a different ranking system, employing only three grades of severity. Details regarding differences in the ranking can be found in **Appendix E**. As shown in **Exhibit 6** above, significant differences exist in the allowable timeframes for remediation.

AT&T stated that it recognized the disparity and has established a defect management process which includes a single severity coding protocol for future releases. Staff still has concerns regarding whether a single standard has been, or in fact, can be adopted. The AT&T

website contains a newly-published Change Control Process Manual dated October 28, 2008. This manual contains the same severity codes and remediation days as shown in **Exhibit 6** above for the 9-state region. It does not appear that any changes have been made. In fact, staff believes AT&T could not make changes to this manual without approval from the CLECs.²⁸

Additionally, staff believes changes to the remediation period would also require the approval of the Florida Public Service Commission. A wholesale service quality measure titled Percentage of Software Error Corrected in “x” Business Days (CM-6) ordered by the Florida Public Service Commission requires AT&T to report defect correction timeliness. The “x” specifically refers to the remediation period of 10, 30 and 45 days for Severity 2, 3 and 4 defects, respectively. The benchmark is that 95 percent of the defects should be corrected in the allowed timeframe.

Staff notes the CM-6 service quality measurement data report on the AT&T PMAP website reveals that AT&T failed the metric sporadically for several months following the April Release. AT&T reported that it failed the measure for Severity 2 defects for May, June, August, and September 2008. It also reported that it failed the measure for Severity 3 defects for May, July, August and September.²⁹ Despite these failures, AT&T calculated that it owed no penalties for missing this measure under the Self-Effectuating Enforcement Mechanism (SEEM). AT&T is supposed to pay \$1,000 for every defect that did not meet the 95% benchmark. While staff is aware of differences between the SQM and SEEMs calculations, staff is very concerned regarding the accuracy of the information being provided for the Change Management measures.^{30 31} When specifically asked about Change Management SQM accuracy AT&T stated that all information posted was accurate. Staff does not agree and believes further review is needed by both AT&T and staff regarding accuracy of the Change Management measures.³²

If, in fact, the information is found to be accurate, staff has further concerns regarding the adequacy of the measures which can be addressed in a future review of the SQM and SEEM plan scheduled for 2009. At a minimum, staff believes the 95 percent benchmark needs to be reviewed. Additionally, there may need to be a remediation requirement for Severity 1 defects.

4.4.2 CLEC Impacting Classification

AT&T defines CLEC impacting as those production defects which directly affect CLECs’ ability to do business. The AT&T-SE Change Control Process manual dated October 28, 2008 defines CLEC impacting as problems which typically affect the CLEC’s ability to exchange transactions with AT&T-SE and may include documentation that is in error, has missing information or is unclear in nature.

²⁸ The Change Control Manual includes that statement: Jointly Developed by the Change Control Sub-team comprised of AT&T-SE and CLEC Representatives.

²⁹ No severity 4 defects were reported.

³⁰ AT&T’s SQM website did not report any defects corrections for the month of April and June for Severity 2, and none for the month of April and July for Severity 3. However AT&T’s Enhanced Defect Report for April 29, 2008, shows numerous severity 2 and 3 defects closed during April that should have been included in the metric. Additionally, there were at least 30 severity 2 defects closed in June according to the July 2, 2008 Enhanced Defect Report.

³¹ Staff’s analysis of the defects reported in Document Request 1-4 also reveals AT&T would have failed the benchmark for both Severity 2 and 3 for May through September 2008.

³² Close or fix date was missing from the defect listing provided to staff. If this information is not populated in the data base staff questions what field is being used as input to the SQM and SEEM calculations analysis.

Staff is not sure how, when or by whom defects are classified as CLEC impacting or non-CLEC impacting. This classification is not addressed in any of the AT&T defect manuals reviewed by staff. A listing of defects, known as the Enhanced Defect Report, is published daily on the AT&T website. However, the Defect Production Management Guide states that the report is edited by Wholesale Business prior to posting. Staff questions why Wholesale Business would be editing this report provided to CLECs. Perhaps this is when the decision regarding CLEC impact is made.

If a defect is classified as non-CLEC impacting CLECs are never made aware that the defect exists. The defect will not occur on the Enhanced Defect Report. Additionally staff believes that AT&T is excluding non-CLEC impacting defects from the calculation of the defect-related SQM and SEEM measures discussed above. Staff is concerned that AT&T may be incorrectly applying the classification of non-CLEC impacting defects, and therefore a substantial number of defects are not being reported to the CLECs. In the April Release, [REDACTED] of the [REDACTED] defects were classified as non-CLEC impacting and were never seen by CLECs.

A review of the AT&T non-CLEC impacting reported defects revealed defects which appear to be CLEC impacting. For example, [REDACTED]

[REDACTED] Jeopardizes and FOCs are both notices sent to CLECs. Staff believes that missing order numbers and missing information in fields of these notifications would be CLEC impacting. CLECs need to know that this information is not available so they can plan accordingly. Staff believes that AT&T should reevaluate its use of the CLEC impacting classification.

4.5 Defect Methodology and Organizational Changes

AT&T has indicated an understanding and appreciation of the difficulties with defect management experienced in the April Release. As a result, the company has taken steps to improve pre-production and production defect identification, tracking, and remediation.

Two changes stand out as the most critical going forward. First, defect tracking for all future releases has been migrated to one manager and a single management team rather than separate region-specific oversight. Secondly, AT&T states that as of August 16, 2008, the 9-state region was incorporated into the 13-state defect management process.

AT&T states that a review of code-related defects resulting from the April Release was undertaken as a result of the problems encountered. Resolutions for future releases include a rejection of late business requirement changes, more frequent and comprehensive code walk-throughs' within the LASR development team, and additional resources added to the LASR development team.

Going forward, Quality Center will be the pre-production defect management application. Production defect management will employ the Vantive application. Depending on when in the release cycle a defect occurs, it will be initially recorded and tracked, from inception to closure, using either Quality Center or Vantive for future releases.

AT&T has also published defect management resources to further clarify individual and team responsibilities. These new publications will assist in the overall process of defect management. The three major resource guides are:

- ◆ Wholesale Production Defect Management Guide (January 2008)
- ◆ IT Defect Production Management Guide (August 2008)
- ◆ Wholesale Test Ordering Defect Management Guidelines (October 2008)

For pre-production, the defect organization has also undergone a comprehensive revision. Defect management has been made more robust than the days preceding the April Release. The company states that this is evidence of their resolve to detect defects early and devise satisfactory, non-disruptive resolutions whenever possible prior to a release. Two Assistant Vice Presidents (AVP) have now replaced the Executive Director. The AVPs are responsible, respectively, for Consumer IT and Customer Care and Billing & IT Solutions.

4.6 Defect Management Conclusion

Never before had AT&T ever encountered defect management problems such as those resulting from the April Release. The scope of defects encountered overwhelmed its ability to comprehensively respond in a timely manner and resource fatigue eventually became a problem multiplier. The scope, volume and magnitude of the ■ production defects exceeded AT&T's experience, expectations, and ability to adequately respond.

Defect tracking management, from methodology to remediation, was often uncoordinated. Defects were captured in different applications that did not share common architecture or an ability to communicate. Disparate systems delayed the full comprehension of problems and subsequently hindered management response. Duplicative entries in two systems led to varying but continuing levels of confusion about specific responsibilities. The inability of various defect tracking systems to communicate or cross-populate denied management valuable analysis tools with which to efficiently discern pre-production and production defect trends.

Prioritization of defects was impaired, allocation of resources was impacted and remediation arguably delayed in some instances. Though AT&T stated that defect analysis tools worked as designed in each region, some managers allowed that input errors and user oversights precluded optimum performance. The number of defects resulting from the April Release, particularly those of the most critical severity type, quickly outstripped AT&T's ability to immediately respond in a proactive, comprehensive, and systematic manner. Staff believes the company grossly underestimated the quantity, scope, and severity of defects that might be encountered with this release.

AT&T has demonstrated interest in getting to the core of April Release problems. As a result, organizational structures and responsibilities for defect management have been adjusted. The defect tracking system has been streamlined and rests in a single system. Training has increased in anticipation of future releases. Despite these changes, staff has some concerns regarding the overall effectiveness of the defect management at AT&T. Staff is particularly

concerned with defect root cause analysis, defect remediation timeframes and accuracy and adequacy of the defect related change management service quality measures.

The following are staff recommendations regarding defect management:

- ◆ AT&T should review the April Release defects and the root causes identified for each and ensure that a root cause has been identified and that appropriate action has been taken to prevent future occurrences.
- ◆ AT&T should improve its emphasis on defect root cause analysis through written policies and procedures, assignment of responsibilities and employee training.
- ◆ AT&T should continue to evaluate the consolidation of its defect management process to ensure that defects are resolved in an expedient manner and are compliant with the benchmarks established by the Florida Public Service Commission.
- ◆ AT&T should review the accuracy of data collection and reporting for all Change Management Service Quality Measures and the Self-Effectuating Enforcement Mechanism.
- ◆ AT&T should reevaluate its use of the CLEC impacting classification and either eliminate it, giving CLECs full visibility of defects or have a clearly communicated definition of when it is applicable.

5.0 COMMITMENTS & CLEC COMMUNICATIONS

5.0 Commitments & CLEC Communications

5.1 Commitment Objectives

As noted previously, on May 15, 2008, Commission staff held an informal workshop to discuss issues surrounding AT&T's April Release. At the workshop, AT&T agreed to suspend future planned 22-state OSS releases until the following objectives were met:

- ◆ Resolve April Release defects
- ◆ Expand CLEC communications
- ◆ Develop an Expanded Test Plan
- ◆ Provide proactive support on email manual ordering process
- ◆ Provide proactive billing adjustments
- ◆ Improve customer support team responsiveness

To satisfy these objectives, AT&T voluntarily made 32 commitments to the Commission. The list of commitments was memorialized in a subsequent filing with the Commission on May 26, 2008. During this audit, staff requested AT&T to provide updates of the implementation status of each commitment. AT&T provided supporting documentation or evidence of implementation for each commitment.

This chapter discusses and provides staff's assessment of AT&T's efforts regarding the objectives listed above and the supporting commitments for each objective. **Appendix F** discusses staff's assessment of each of the 32 commitments.

Staff notes that AT&T's objective to Expand CLEC Communications directly relates to one of the three objectives of this audit. Commission staff has documented and assessed pre-April Release and post-April Release CLEC Communications in Section 5.3.

5.2 Resolve April Release Defects

Defects are problems that occur when the OSS interfaces are not working in accordance with AT&T's baseline user requirements or business rules. Defects are discovered by AT&T in the pre-production environment and discovered by both CLECs and AT&T in the production environment.

Before moving forward with implementation of future 22-state OSS releases, AT&T agreed to first resolve defects associated with the April Release. The following three commitments were established to achieve this objective:

1. Resolve all Severity 1 and 2 defects.
2. Provide status related to the transmittal of Line Loss Notifications.
3. Provide status related to the Billing Completion Notices.

AT&T contends that each of the above commitments has been satisfied, and as a result, the objective to resolve April Release defects has been met. However, staff notes that as of

September 5, 2008, eight Severity 2 defects remained open. Staff expects these eight defects to be remedied prior to implementation of the next 22-state OSS release. Staff believes it is premature to close the following commitment until AT&T provides supporting documentation that addresses the closure of the open defects:

1. Resolve all Severity 1 and 2 defects.

5.3 Expand CLEC Communications

AT&T's primary vehicle for communicating issues to CLECs is through AT&T's Change Management Process (CMP).³³ Monthly CMP meetings are used to discuss upcoming changes to OSS interfaces, report on AT&T-initiated and CLEC-initiated Change Requests,³⁴ system outages, software documentation changes, and regulatory changes. Therefore, the CMP process is of great importance to AT&T and CLECs. AT&T uses an Accessible Letters notification process to provide CLECs with an advanced notice and agenda for the monthly CMP meetings.

CLECs raised concerns with the adequacy of AT&T's CMP shortly after the merger of AT&T and BellSouth. The development of change requests, issuance of change notifications, and administration of CMP meetings changed as a result of the merger. CLECs that operate in the former BellSouth 9-state region found that portions of the former Change Control Process (CCP) procedures were no longer in place or documented. In response, AT&T acknowledged a need for improved external communications with CLECs, particularly in connection with the April Release. AT&T committed to expand and improve on communications with CLECs, including the discussion of April Release issues, and to provide proactive communications for future 22-state OSS Releases in the Southeast region. AT&T provided staff with a list of 11 commitments specific to CLEC communications:

4. Maintain recurring status calls with customers until the earlier of the resolution of Severity 1 and 2 defects resulting from the April OSS release or consensus that calls are no longer necessary.
5. Continue to status plans for currently scheduled 22-state releases within existing monthly CMP Meetings. Enhance clarity of pre-release communications by providing a review of all systems and customer interface changes included in future 22-state releases in advance of Accessible Letter communications. Use this input to improve the clarity of Accessible Letter information.
6. Outline CLEC training plans and materials for future 22-state releases. Take into consideration customer input prior to finalization of such training. Release CLEC training materials in accordance with CMP/CCP timeframes.
7. Recorded messages will be made available during Release Implementation Weekends reporting on current status and "go/no go" readout.
8. A virtual "War Room" will be established during the initial three days after scheduled releases to update customers of any Post Release issues. Daily calls can be expanded/extended as necessary.

³³ This was formerly known as the Change Control Process (CCP) in the BellSouth 9-state region.

³⁴ Change Requests are requests to modify OSS systems.

9. Provide a single document that clearly describes roles/responsibilities/titles for the following AT&T personnel to assist with more effective customer contact and escalation points: 1) Wholesale Customer Support Managers, 2) Information Services Call Center, 3) Mechanized Customer Production Support Center.
10. Perform internal documentation review to enhance clarity of Web-based Defect Reporting (EDR Report) – Updated beginning 5/15 and ongoing.
11. Perform internal documentation review to enhance clarity of XML Documentation.
12. Correct identified issue with reject reason field to restore to pre-release length of 5 characters.
13. Perform internal documentation review to enhance clarity of Systems Outages Notifications.
14. Will take into consideration comments received from customers to date and cover results with CLECs once completed.

AT&T contends that each of the above commitments has been satisfied, and as a result, the objective to expand CLEC communications has been met. Staff agrees that AT&T has satisfied seven of the 11 commitments. Details of staff's analysis of items 4 through 14 can be found in **Appendix F**. Staff believes the following four commitments should remain open until AT&T provides additional supporting documentation for staff to concur with closure of these items:

6. Outline CLEC training plans and materials for future 22 State releases. Take into consideration customer input prior to finalization of such training. Release CLEC training materials in accordance with CMP/CCP timeframes.
11. Perform internal documentation review to enhance clarity of Web-based Defect Reporting (EDR Report) – Updated beginning 5/15 and ongoing.
13. Perform internal documentation review to enhance clarity of XML Documentation.
14. Will take into consideration comments received from customers to date and cover results with CLECs once completed.

5.4 Develop an Expanded Test Plan

The purpose of an application test plan is to coordinate all the individual efforts associated with the application. Individual test plans are developed at the project level to ensure new functionality is sufficiently designed, tested and validated. Pre-production tests are designed to ensure that all systems will function acceptably when migrated from the test environment to the production environment. Furthermore, the pre-production test environment is comprised of multiple end-to-end testing to closely replicate the production environment. The overall testing objectives include the following:

- ◆ Ensure that the software satisfies documented requirements
- ◆ Ensure that newly implemented features and defect fixes do not have a negative impact on the current systems

- ◆ Ensure that each sub-system component processes the input data correctly whether data is valid or invalid, and that the output data created can be correctly processed by the next sub-system component
- ◆ Ensure that existing operations are not degraded from earlier releases

AT&T's April Release incurred defects that went undetected during AT&T's pre-production testing process. Primarily, the errors impacted outbound transactions to CLECs such as the accuracy and completeness of the firm order confirmations (FOCs) that are sent to CLECs to acknowledge that AT&T has received and accepted a CLEC order. Specifically, AT&T failed to read and return notifications sent via the EDI and XML front-end applications. The local number porting process, disconnection process, as well as the supplemental ordering process, also experienced significant delays after AT&T implemented the April Release.

According to AT&T, 16 CLECs participated in the April Release testing; however AT&T acknowledged that additional emphasis should have been placed on end-to-end testing and CLEC participation. End-to-end testing verifies system functionality by following a set of data from its inception through all points where it is processed, including completion to billing.

AT&T also acknowledged that a larger set of regression tests should have been performed and the cumulative impact of volume tests was not recognized during the short time frame to implement the April Release. Regression testing ensures that new release changes and enhancements function as expected with prior releases. Volume testing ensures that the release operates effectively at specific volume levels.

In response to an inadequate Test Plan for the April Release, AT&T implemented a 22-state Test Plan. The AT&T's 22-state Test Plan is an Expanded Test plan with the objective of communicating the test approach and summarizing the project level test plans that are required to accomplish successful pre-production testing of OSS releases. The 22-state Test Plan is focused on Integrated System Testing and User Acceptance Guidelines.

The 22-state Test Plan will require completion of release milestone dates and tasks before entering the pre-production test phase and before exiting the pre-production test phase. In other words, actual start of testing may vary by project but testing must be completed by the "complete date" in the Test Plan schedule. If criteria are not met or resolved within an acceptable or the designated time frame, the issue will be escalated to the 22-state test lead coordinator.

The 22-state Test Plan entrance criteria require unit testing, assembly testing, and connectivity/integration testing to be complete [REDACTED] Exit criteria requires [REDACTED]

[REDACTED] Staff believes these test plan enhancements will play a significant role in preventing future release issues.

AT&T provided six commitments specific to lessons learned from the April Release to aid in the development of an Expanded Test Plan for future 22-state OSS releases.

15. Utilize root cause analysis of release defects to expand Testing Plans with special focus in the area of delivering outbound transactions. Specific tests will be established for validating that outbound transactions such as FOCs, Clarifications, Completion Notices and Billing Completion Notices are delivered to their destination point in a form compatible with existing standards and interface agreements.
16. Encourage and support greater CLEC participation in cooperative testing for all releases, utilizing existing CLEC test environments.
17. Evaluate manual process to determine what steps can be taken to test the process and allow CLECs the opportunity to practice for new forms/templates.
18. Going forward, scheduled 22 State releases for the SE region will provide overlap between the existing and new Customer Interfaces (EDI, XML and Verigate/LEX/LENS), in order to allow customers to plan/test/develop individual migration strategies to the new interfaces.
19. Testing to include appropriate back out plans for the implementation weekend.
20. Development of Emergency Plan with a focus on 1) Customer Notification and Support. 2) Defect Resolution, 3) Expanded AT&T staffing requirements.

AT&T contends that each of the above commitments has been satisfied, and as a result, the objective to develop an Expanded Test Plan has been met. Staff concurs with AT&T to close each commitment with the understanding that AT&T will fully utilize the newly Expanded Test Plan upon implementation of future OSS releases. Details of staff's analysis of items 15-20 can be found in **Appendix F**.

5.5 Provide Proactive Support to Email Manual Ordering Process

As part of the April Release, AT&T consolidated its 13-state region and Southeast region manual ordering process for complex orders. The 22-state manual ordering consolidation consisted of replacing the AT&T Southeast region manual facsimile ordering process with an email ordering process currently used in the AT&T 13-state region.

The new email process requires CLECs to access and download a choice of approximately 20 different manual LSR forms available on AT&T's CLEC Online website. The new process replaces the customized WebForms that were previously downloaded from the LENS interface used in the 9-state region. The change in this process reduced some of the functionality previously available to CLECs in the 9-state region.

AT&T acknowledges that numerous issues arose with implementation of the manual email ordering process in the Southeast region. Such issues include; CLECs' inability to get manual orders through to AT&T, AT&T not returning acknowledgements (time, date, receipt of orders) to the CLECs, incorrect manual ordering guidelines, and a 60 percent increase in CLEC calls into AT&T's call centers.

In response to the issues raised with implementation of the new manual email ordering process, AT&T committed to provide proactive CLEC support to facilitate user introduction to the new process. AT&T made eight commitments specific to the manual email ordering process:

21. Provide Support/Education by providing continued proactive, individualized customer support on Email/Manual Forms process for next 60 days to facilitate user introduction. Including customer working sessions to assist in successful submission of the Manual LSR Forms through use of the email process.
22. Lead a monthly Email/Manual Forms User Forum to provide common support and address current manual process issues until all 22 State releases are completed.
23. Continue to work with all CLEC customers who request further assistance or education on the manual LSR ordering process.
24. Assess CLEC concerns where all pages of a form are required whether or not all pages contain data. Address customer concerns regarding the requirement of additional data.
25. Review and assess the prioritized list of customer change requests for enhancements to the 22 State Email LSR Process. Reevaluate merger related OSS Change Requests previously submitted through the Change Management process.
26. Complete updates to the Local Ordering Handbook to reflect changes via the Accessible Letter.
27. Proactive review and update of the 22-state manual LSR forms and email process documentation to address customer feedback
28. Expand documentation quality control processes to ensure multiple layers of review prior to release of documents to the customers.

AT&T contends that each of the above commitments has been satisfied, and as a result, the objective to provide proactive support to the email manual ordering process has been met. Staff agrees to close seven of the eight commitments. Details of staff's analysis for items 21-28 can be found in **Appendix F**. Staff believes the following commitment should remain open until AT&T provides supporting documentation for staff to concur with closure of this item:

25. Review and assess the prioritized list of customer change requests for enhancements to the 22 State Email LSR Process. Reevaluate merger related OSS Change Requests previously submitted through the Change Management process.

5.6 Proactive Billing Adjustments

AT&T committed to respond to billing concerns that arose out of the April Release. On the May 28, 2008 April Release defect status call, AT&T discussed the goal of identifying key billing issues and proactively processing billing adjustments without the need for CLECs to file billing disputes. AT&T specifically stated that CLEC monthly recurring and non-recurring charges would be adjusted accordingly in order for bill credits to appear on either the June or July 2008 CLEC bills. Below is AT&T's specific billing adjustment commitment:

29. Proactive Billing Adjustments, Claims Clean-Up Process for addressing exceptions, Communication Plan

AT&T contends that the above commitments have been met to satisfy the objective to provide proactive billing adjustments. Staff concurs with AT&T to close this item, and would note that AT&T has 85 billing service representatives supporting the CLEC Southeast billing activities. Of these, 10 were dedicated to April Release issues. [REDACTED]

5.7 Center/Support Team Responsiveness

AT&T committed to provide CLEC support and responsiveness to resolve April Release issues. In response, AT&T provided staff with three specific commitments to handle the influx of calls associated with the April Release:

30. Implement a temporary plan of action to handle calls by other service centers.
31. Continue to manage April Release related expedites for the processing of acknowledgements for any individual situations if not addressed by the mechanized transmittal efforts.
32. Continue to review staffing levels to meet anticipated demand for Wholesale Customer Support and Centers.

AT&T contends that each of the above commitments have been met to satisfy the objective to provide improved center/support team responsiveness. Details of staff's analysis of items 30-32 can be found in **Appendix F**. Staff believes the following commitment should remain open until AT&T provides additional supporting documentation for staff to concur with closure of this item:

32. Continue to review staffing levels to meet anticipated demand for Wholesale Customer Support and Centers.

5.8 Commitments & Communications Conclusion

Of the 32 commitments provided by AT&T, staff agrees that 25 can be closed with the understanding that AT&T should be held accountable for upholding these commitments during the implementation of all future 22-state OSS releases. Staff recognizes that AT&T has taken positive steps to address these commitments and further believes action taken by AT&T should minimize future disruptions. However, until the next 22-state release, staff cannot fully validate that the changes that have been implemented will prevent future problems. Staff cannot attest to the quality of the changes made, merely that changes have been implemented. For example, staff confirmed the existence of the Expanded Test Plans for the November release, but staff can not attest to AT&T's adherence to the Expanded Test Plan in future release and the adequacy of AT&T's implementation of the plan.

Staff believes AT&T is closing the remaining seven commitments prematurely. Staff contends that further supporting documentation is warranted or the processes to resolve the commitments have yet to be fully addressed or implemented. For example, AT&T has not

provided documentation supporting the resolution of all April Release defects and the process of consolidating pre-ordering and ordering business rules has not been fully implemented. Staff recommends that AT&T reevaluate its closure of these seven commitments and take necessary steps to assure the commitments have been fully addressed.

Below are staff's conclusions based on the assessments of the seven objectives AT&T agreed to fulfill before implementing future 22-state OSS releases:

5.8.1 Resolve April Release Defects

AT&T agrees that reducing the number of software defects is beneficial to both AT&T and CLECs and that OSS releases with numerous defects can inhibit a smooth transition between releases. Unfortunately, the April Release had errors (i.e., software defects) that impacted the CLECs ability to process orders.

Staff acknowledges AT&T's remedial actions to resolve issues surrounding the April Release defects, including the consolidation of defect tracking management and revisions to the defect reporting format. However, the sheer number of software defects that emerged from the April Release is such a significant issue alone to substantiate staff's concerns with the CLECs difficulty in effectively using AT&T's pre-ordering and ordering OSS capabilities. Staff cannot fully discern the effectiveness of AT&T's defect resolutions or work-arounds and must rely on AT&T's confidence in the defect management process in place for future 22-state OSS releases. As a means of monitoring AT&T's defect management process, staff recommends that AT&T prepare and provide staff with pre-production and production defect status reports specific for each 22-state OSS release as they occur.

5.8.2 Expand CLEC Communications

AT&T implemented numerous corrective actions to address the communication failures that occurred pre- and post-April Release. Such corrective actions include having weekly status calls with CLECs to discuss April Release defects, providing CLECs with customer service contact information, implementing training guides, using the monthly Change Management Process (CMP) meetings to communicate the status of future OSS releases, and holding conference calls with CLECs after an OSS release.

While staff commends AT&T for taken necessary steps to improve communications with CLECs, staff still questions the overall effectiveness of AT&T's Change Management monthly meetings, the principal outlet for communicating with CLECs. None of AT&T's commitments address possible deficiencies or improvements needed in this Change Management Process, particularly the monthly Change Management calls, now that they have been consolidated under a 22-state umbrella. Staff believes that AT&T has not provided a clear indication or direction of the new Change Management meeting framework to evaluate and address CLEC concerns. For example, at times there were conflicts between what AT&T was saying was done and what actually was done, such as the completion of the Local Ordering Handbook. Additionally, CLECs have raise concerns that AT&T would not have the appropriate technical staff on the Change Management conference call to address an issue on the agenda. Staff has seen repeated evidence of this. Staff also notes that there remains an open item on the monthly Change Management agenda to discuss the effectiveness of the Change Management process. However,

staff has yet to see any evidence of discussion on this topic. Staff recommends that AT&T clearly define and document the monthly Change Management meeting process, including AT&T's 22-state process for escalating CLEC issues, including AT&T's 22-state process for escalating CLEC issues raised during the monthly meetings.

Staff also has a general concern that the current Service Quality Measurement Plan (SQM) and Self-Effectuation Enforcement Mechanism Plan (SEEM) not be adequately designed to capture failures of such magnitude as the April Release. AT&T's SQM and SEEM are designed to capture and compare the quality of service delivered to CLECs. AT&T's failure to comply with applicable SQM performance measurements will trigger SEEM remedy payments to CLECs and/or the state of Florida. The SQM Plan includes performance measurements for AT&T's Change Management Process. The measurements capture the timeliness of resolving software defects and implementing changes to software documentation, but staff believes the SQM does not capture the effectiveness of the defect resolution or revised documentation. In other words, the defect or documentation may have been fixed in a timely manner, but the fixes may not be acceptable by the CLEC community.

Furthermore, the SQM and SEEM Plans may incorporate processes used in the former BellSouth 9-state region that have now changed. One example is the number of days established to resolve software defects. The current SQM Plan uses the standards in accordance with 9-state procedures, yet staff has learned that AT&T's 22-state practice may be to follow the standards in accordance with the 13-state region's procedures.

Because of the possibility that the SQM and SEEM Plans do not capture several aspects of a major OSS release, including the appropriate penalties to be imposed, staff believes the Commission should commence an expedited review of AT&T's SQM and SEEM Plans prior to implementation of 22-state releases scheduled in 2009.

5.8.3 Develop an Expanded Test Plan

AT&T acknowledges that adequate testing procedures for the April Release, including end-to-end testing, could have prevented significant defects from going into production. A key feature in AT&T's newly Expanded Test Plan is the focus on the delivery of outbound transactions which was the primary issue that surrounded the April Release. AT&T is also encouraging greater CLEC participation in cooperative testing and will provide overlap between existing and new OSS interfaces to allow for CLECs to gradually transition to the new OSS interfaces. Staff has yet to see Expanded Test Plans for future 22-state releases, since those plans are necessarily unique to each release and are not finalized until shortly before release implementation. AT&T has committed to providing staff with copies of the Test Plans when they become available. Staff further recommends that AT&T continue to educate CLECs on future 22-state release test plans.

5.8.4 Provide Proactive Support to Email Manual Ordering Process

AT&T made numerous commitments and has taken numerous steps to address and correct errors associated with the implementation of the new 22-state manual email ordering process. AT&T continues to provide CLECs with customer support and education on an as-needed basis.

However, in staff's opinion, AT&T's new manual email ordering process is not equal to, or at parity, to what BellSouth previously provided to its CLEC customers in the 9-state region. While AT&T would argue that the new manual ordering process may provide the same "functionality" that existed in the 9-state region, staff believes that the new 22-state process of completing and submitting a manual LSR is more burdensome for CLECs.

Specifically, CLECs using the 9-state region manual fax ordering process would choose the Manual LSR option from the LENS interface main menu. From there, a Graphical User Interface (GUI) tool would allow for several LSR data entry fields to be auto-populated. Additionally the GUI would perform several self-edit checks prior to the submission of the order. The LSR would be completed by a CLEC representative and faxed to AT&T for processing. AT&T, upon receipt would have to manually enter the order into the order process system. In comparison, for the new 22-state manual email ordering process, CLECs must first launch several pages from AT&T's CLEC Online website to get to the manual LSR forms. From there, CLECs would choose from seven core product template forms and 17 different LSR manual forms. An LSR form may require up to 10 pages of data entry to be performed by a CLEC representative before submitting to AT&T for processing. There are no auto-population of fields and no self-edit checks. Without this functionality there is a much greater CLEC risk of error in placing an order.

Implementation of the new 22-state manual email ordering process was beneficial to AT&T, because the company incurred back-end efficiencies in the processing of orders. Email orders can be directly loaded into the order processing system without manual intervention on the part of AT&T. However, the new manual processing changes have increased the likelihood of increased order rejections and order processing time which will weaken the CLECs ability to effectively compete. Staff recommends that AT&T continue to enhance the 22-state manual email ordering process to include efficiencies, including auto population and edit checks, which previously existed in the manual processing of orders in the 9-state region.

5.8.5 Provide Proactive Billing Adjustments

Staff concludes that AT&T adequately responded to billing concerns that resulted from the April Release. AT&T took corrective action to prevent a backlog of CLEC billing disputes by proactively processing billing adjustments. According to AT&T, all April Release billing adjustments have been completed, and to the best of staff's knowledge, CLECs have yet to raise concerns with regards to the adjustments. Staff believes AT&T's actions have remedied the CLECs' concerns.

5.8.6 Improve Customer Support Team Responsiveness

Staff applauds AT&T for dedicating additional resources to resolve ordering processing issues associated with the April Release. Furthermore, shortly after the April Release, AT&T created an escalation process for CLECs to send orders that had not processed correctly or had insufficient information. However, staff is concerned that AT&T's customer support responsiveness may be short-lived.

AT&T acknowledges that CLEC April Release related calls had to be diverted to additional call centers to handle the demand, but now that business is back to normal, CLEC calls in the Southeast region are now solely handled by AT&T's Birmingham call center operations. Given the impact of the April Release and the magnitude of future 22-state releases, staff is concerned with the adequacy of resources to meet CLEC demands upon implementation of future 22-state releases. AT&T stated that call center activity is continually reviewed based on current and forecasted demand, yet staff was not provided with an assessment of current call center activities and staffing levels, nor was an assessment provided based on future 22-state releases. Staff recommends that AT&T provide staff with such assessments.

5.8.7 Summary of Commitment and CLEC Communication Recommendations

In summary, staff recommends the following actions:

- ◆ AT&T should reevaluate its closure of seven commitments (items 1, 6, 11, 13, 14, 25, and 32) and take necessary steps to assure the commitments have been fully addressed.
- ◆ AT&T should clearly define and document the monthly Change Management meeting process.
- ◆ The Commission should commence an expedited review of AT&T's SQM and SEEM Plans prior to implementation of 22-state releases scheduled in 2009.
- ◆ AT&T should prepare and provide staff with pre-production and production defect status reports specific to each 22-state OSS release as they occur
- ◆ AT&T should provide staff with Expanded Test Plans for all future 22-state releases as they become available, and continue to educate CLECs on future 22-state release test plans.
- ◆ AT&T should continue to enhance the 22-state manual email ordering process to include efficiencies that previously existed in the manual processing of orders in the 9-state region.
- ◆ AT&T should provide staff with an assessment on current call center activities and staffing levels, and an assessment of call center activities based on future 22-state releases.

6.0 APPENDICES

Appendix A

Ordering Processes

CLECs' Pre-April Release Electronic Ordering Process

Following the BellSouth and AT&T merger, AT&T began migrating and consolidating the former BellSouth 9-state southeast OSS platform into a single pre-ordering and ordering OSS platform for use across AT&T's 22-state region. At the time of the merger, AT&T's Local Wholesale OSS operated uniformly in all of AT&T's 13-state region for many of the same CLEC customers doing business in the former BellSouth 9-state region. AT&T determined that the 13-state OSS system would produce greater efficiencies for the benefit of both AT&T and its customers throughout the 22-state region.

The former BellSouth 9-state southeast OSS process flow is shown in **Exhibit 7**. The exhibit depicts a high-level system flow for electronic pre-ordering and ordering processes prior to the April Release. Provisioning service for a new CLEC customer begins with the pre-order process. CLECs submit pre-order queries to AT&T through one of two available pre-ordering electronic interfaces; the Direct XML/Telecommunication Access Gateway (TAG)³⁵ or the Local Exchange Navigation System (LENS).³⁶ The pre-order process is used by CLECs to gather preliminary customer information, such as validating customer address, selecting telephone numbers, and obtaining service order due dates. In response to a pre-order query, AT&T returns either a valid pre-order response or an error message to the CLEC.

The valid pre-order information is then used by the CLEC to begin the ordering process with the origination of a Local Service Request (LSR). A CLEC enters the LSR into AT&T's OSS via one of three available ordering interfaces: TAG, LENS, or Electronic Data Interchange (EDI).³⁷ The LSR then passes through AT&T's Service Gate Gateway (SGG)³⁸ and into AT&T's Local Exchange Ordering (LEO)³⁹ system to store and validate the format and content of the data. If the LSR is unreadable or does not contain accurate and complete information on all required and conditional fields, a reject or auto-clarification is returned to the CLEC. When the LSR is complete and accurate, the service order is then entered into AT&T's Local Service Order Generator (LESOG),⁴⁰ which coordinates downstream provisioning activity and monitors

³⁵ TAG/Direct XML interface allows CLECs to develop their own software applications to obtain information from AT&T's OSS. CLECs can incorporate various internal functions, such as downloading information directly to their own inventory/billing systems, creating their own customer databases, and generating internal reports.

³⁶ LENS is a graphical user interface (GUI) that connects directly via the Internet into AT&T's OSS and is based on the TAG architecture. This interface was developed to provide CLECs with an alternative method of connection to AT&T through the Internet.

³⁷ EDI is a batch-driven machine-to-machine interface, which uses industry standards as its foundation. Business files are exchanged between AT&T computer applications and CLEC computer applications that are encoded to comply with standard EDI transaction sets for data transmission.

³⁸ SGG is a routing and editing software application to help ensure the process of complete and error-free transactions.

³⁹ LEO stores information and is the interface for LSR processing. LEO provides first-level validation to ensure all appropriate fields of the LSR are populated.

⁴⁰ LESOG performs additional edits and flags orders with errors. LESOG validates LSRs based on AT&T's business rules. If an LSR does not adhere to the business rules, LESOG generates auto clarifications. If LESOG cannot determine the cause of a clarification, LESOG forwards the LSR to a service representative for manual review.

AT&T's Electronic Pre-Ordering and Ordering Process Flow Pre-April Release

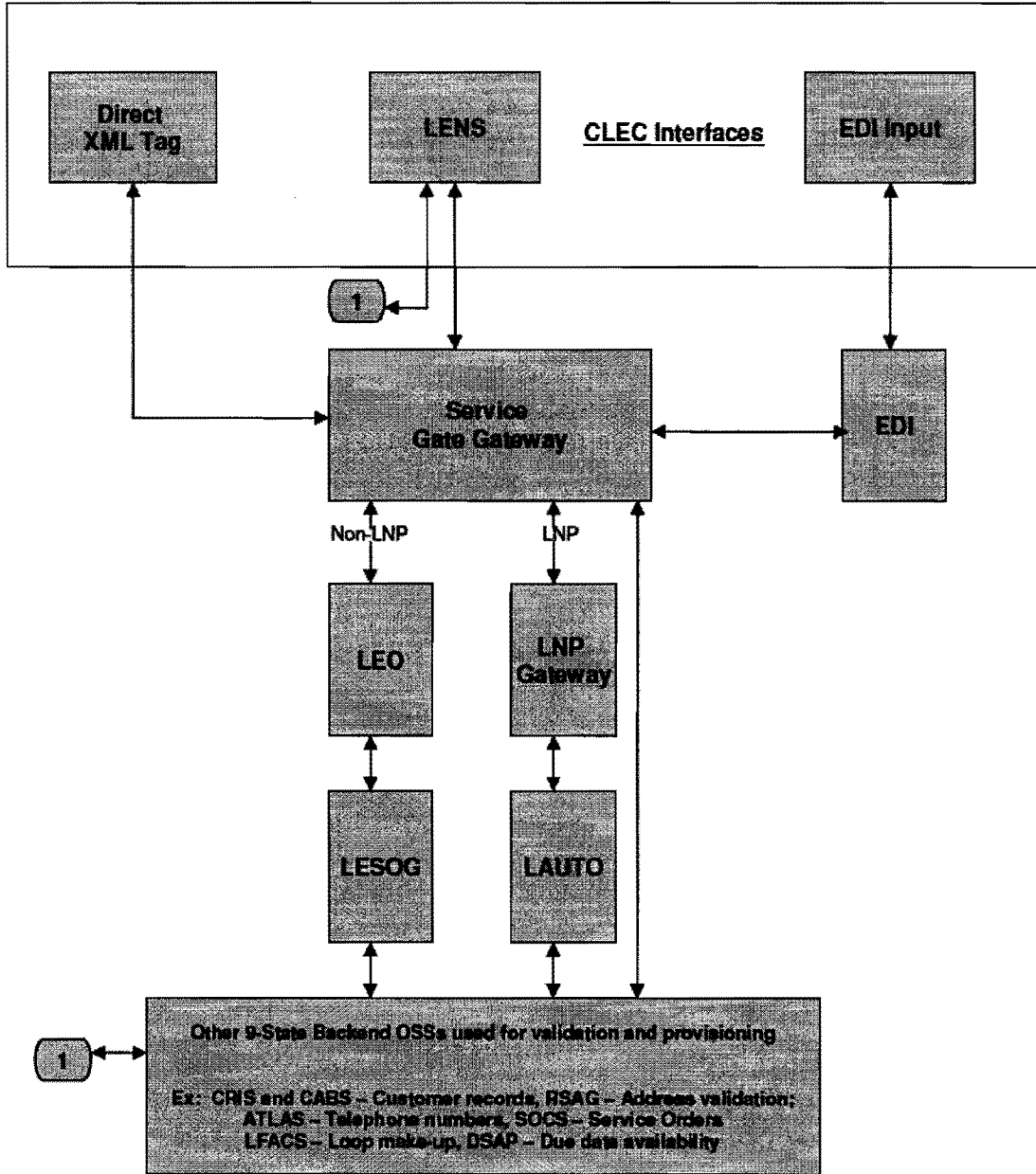

Exhibit 7

the status of the order. LESOG begins the generation process for a Firm Order Confirmation (FOC) response to be delivered to the CLEC. The FOC is confirmation that the LSR was validated by AT&T, and contains a FOC due date, which is the date AT&T commits to completing provisioning of the order.

CLEC's Pre-April Release Manual Ordering Process

In the former BellSouth 9-State region, LSRs for Complex and Resale orders are submitted via facsimile or electronically. However, both entry modes require manual intervention on the part of AT&T. All CLEC Complex and Resale orders are processed at one of AT&T's Local Carrier Service Centers (LCSC). The 9-state LCSC locations were located in Atlanta, Georgia, Fleming Island, Florida, and Birmingham, Alabama.

Exhibit 8 provides the process flow for manual orders that are submitted via facsimile. As shown, LSRs faxed by CLECs are received at an LCSC and automatically imaged, assigned an image number, and stored in the LCSC's Local Ordering Imaging System (LOIS)⁴¹ server. An AT&T clerk retrieves the LSR from the fax server, sorts and scans the LSR for legibility and completion of required fields. The LSR is then logged in to the Local Order Number (LON)⁴² tracking system on a first-in-first-out basis. Illegible or incomplete LSRs are rejected and sent back to the CLEC via LON. The completed LSR is forwarded to an AT&T Work Assignment Manager, who in turn, assigns it to an LCSC service representative for processing. The service representative will request further clarification from the CLEC if needed, or process the order and submit it to the Service Order Communication System (SOCS)⁴³ for order validation and provisioning. Upon validation, a FOC is sent back to the CLEC's facsimile server via LON.

Exhibit 9 depicts the process flow for Complex and Resale orders submitted electronically that require manual intervention (commonly referred to as partially mechanized orders). Partially mechanized orders are submitted using one of the order entry interfaces (LENS, EDI, or TAG). The order flows into the AT&T's LEO and LESOG systems to perform edit check and then stored in LEO for manual processing. LCSC service representatives retrieve the LSR from LEO and process in a similar manner as orders received via facsimile. However, upon validation, the FOC notice is returned to the CLEC via the same interface through which the order was received.

⁴¹ LOIS is a fax server that provides automated imaging of LSRs. The image is assigned an image number and is stored in LOIS until further processing.

⁴² LON is an inventory-based system responsible for tracking the processing status of LSRs.

⁴³ SOCS is responsible for the collection, storage, and distribution of service orders. SOCS performs the final validation based on AT&T's business rules to ensure that service orders can be built correctly. This is the beginning of the provisioning process.

AT&T's Manual Order Facsimile Process Flow Pre-April Release

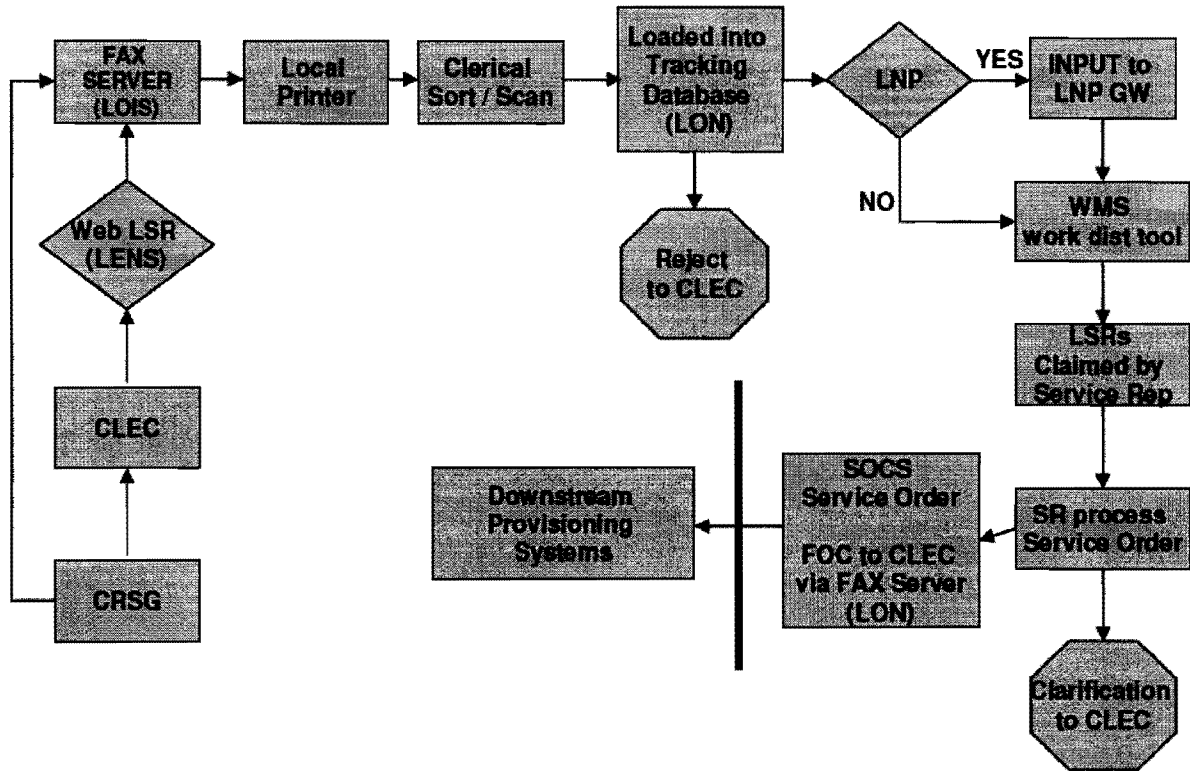

AT&T's Partially Mechanized Order Process Flow Pre-April Release

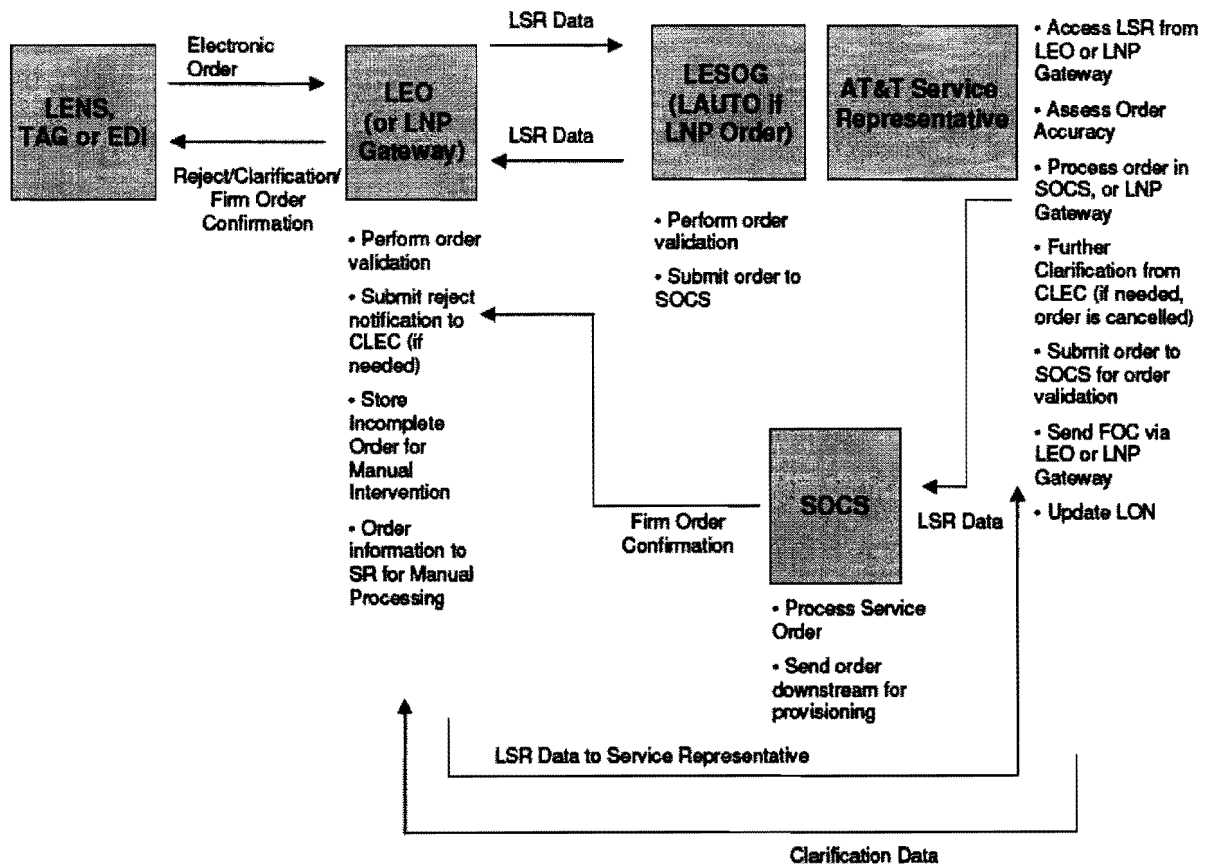

Exhibit 9

AT&T's April Release and Future 22-State OSS Releases

Part of AT&T's merger objectives is to implement a consolidated suite of external and internal interfaces, tools, and processes to support pre-order and ordering of Wholesale Local services. The 22-state consolidated OSS process flow is shown in **Exhibit 10**. The eventual goal of consolidating OSS interfaces is the retirement of three existing 9-state front-end applications; LENS, EDI, and Direct XML/Tag. To achieve this goal, AT&T's consolidated OSS Release plan consists of the following five-step phased-in strategies:

Phase 1 (April 2008 Release)

AT&T initiated the first phase of its OSS Release plan (Release 27.1) on April 19, 2008. This phase, commonly referred to as the April Release, primarily consisted of implementing the following key features and changes:

- ◆ Replaced the 9-state LEO application with Local Access Service Request (LASR) application used in AT&T's 13-state region.
- ◆ Replaced the 9-state Work Assignment Management System (WMS) with Work Flow Management (WFM) system used in AT&T's 13-state region.
- ◆ Introduced the new 22-state pre-order Verigate pre-ordering web-based application into the 9-state region.
- ◆ Replaced the 9-state manual facsimile ordering process with the 13-state manual email process.

Both LEO with LASR are AT&T backend applications (non-CLEC interface) that provide order management, tracking and exception handling for LSRs. According to AT&T, implementation of the LASR application would include the same functions that were available in LEO, with the exception of the processing of work assignments.

Work Assignments would now be handled by the WFM system which replaces the 9-state WMS. WFM is a software application that coordinates tasks, resources and data to ensure that service representatives receive the necessary work assignments to process LSRs.

The April Release also streamlined the number of tools used by AT&T center support personnel to facilitate CLEC service requests. This included adding AT&T's 13-state web-based application (Verigate) that provides preorder functionality, similar to the Local Exchange Navigator Service (LENS) used in the former BellSouth 9-state region. Additionally, with the April Release, the facsimile process CLECs use to submit manual orders in the 9-state region was replaced with a new email based manual process. The new manual email ordering process flow is depicted in **Exhibit 11**.

Phase 2

AT&T's Phase 2 will consist of enhancements to the Verigate pre-ordering browser application implemented with the April Release. Additional functionality will be added including CLECs having the ability to request an unparsed (i.e., raw data) customer service record by account number, and obtain estimated due dates. It should be noted that the former BellSouth LENS application currently being used by CLECs for pre-ordering activities in the 9-state region will still be available for use until retirement in early 2010.

Phase 3

The next phase of AT&T's OSS strategy is to introduce and implement the new 22-state XML Gateway application. XML Gateway is a front-end application and will support pre-order and ordering transactions. XML Gateway will eventually replace EDI and Direct XML/TAG systems currently being used in the 9-state region. EDI and Direct XML/Tag retirements are targeted for late 2009 or early 2010.

Phase 4

AT&T plans to introduce a second front-end application, Local Service Request Exchange System (LEX). LEX is a web-based application for online creation, submittal, and maintenance of LSRs. LEX will replace the LENS interface currently being used in the 9-state region.

Phase 5

AT&T's final phase consists of retiring the LENS, EDI, and XML front-end interfaces currently used in the 9-state region. AT&T anticipates retiring these systems in 2010. AT&T will also retire the 9-state SGG back-end application at the same time. The routing and editing functions performed by SGG will be implemented into the new 22-state LASR application, released in April 2008.

AT&T's 22-State Consolidated OSS Release Plan

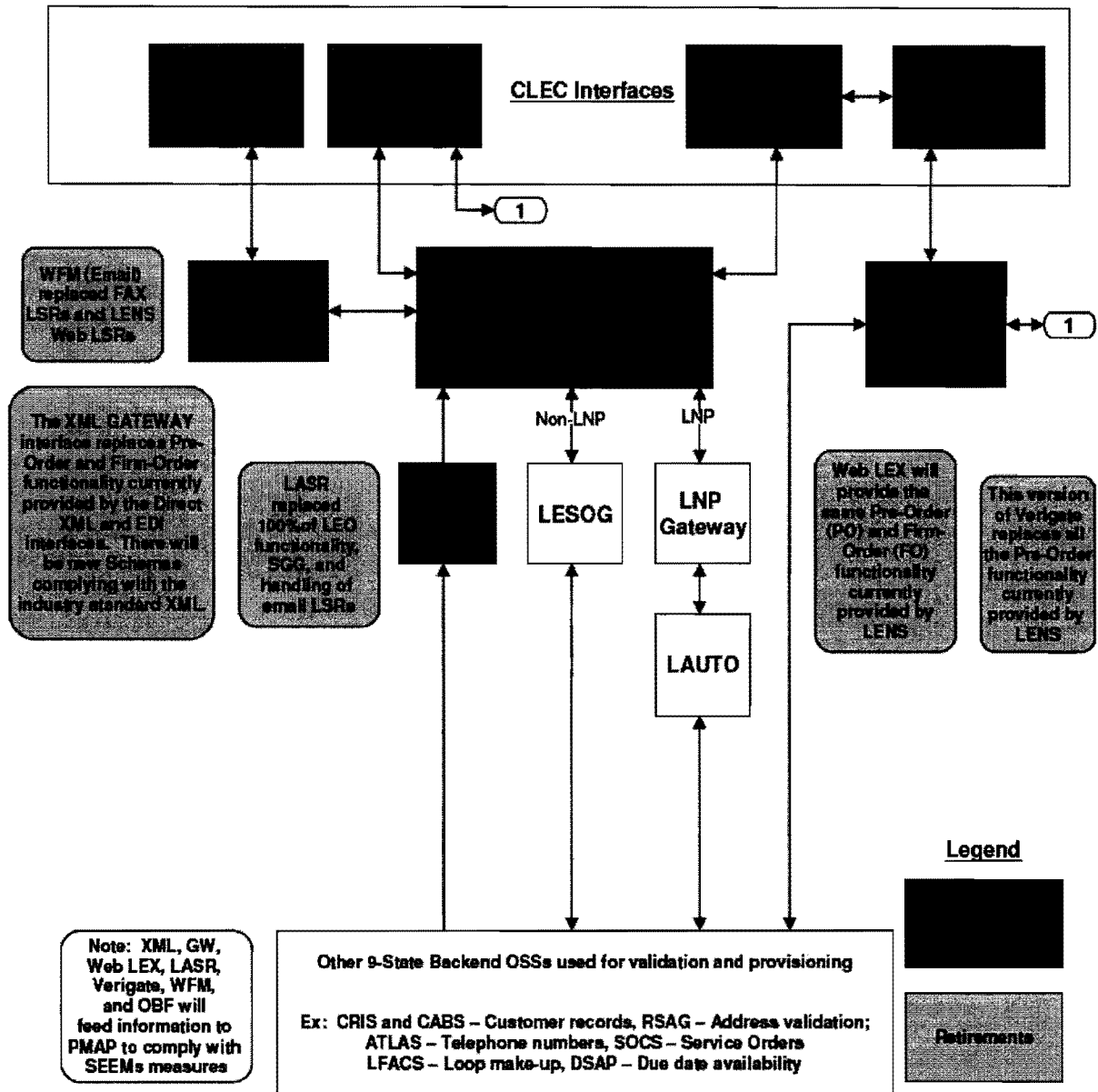

Exhibit 10

AT&T's Manual Order Email Process Flow Post-April Release

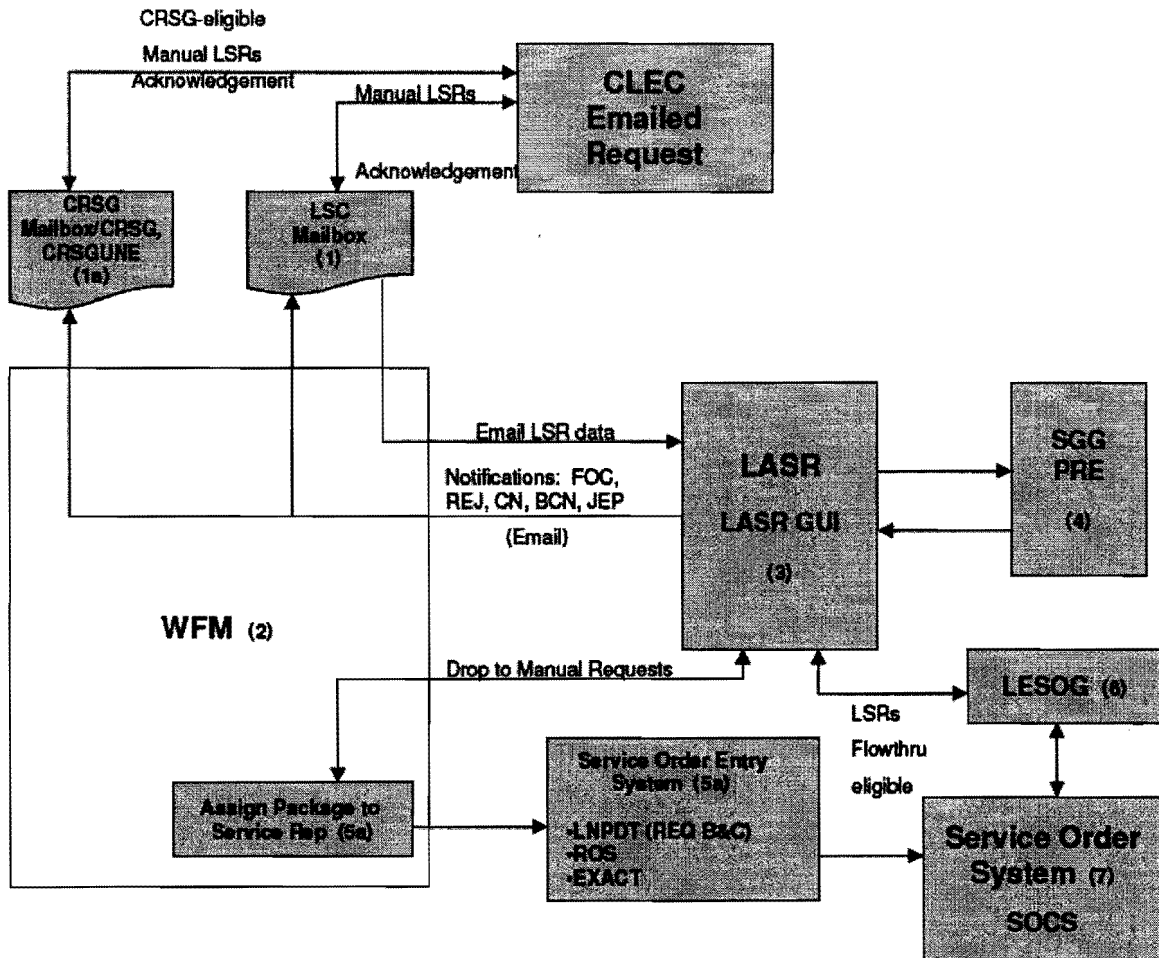

Exhibit 11

Appendix B

Sample of Key Learnings by Category

The following is a sample of some of the issues, root causes and resolutions found in each of the categories above:

Conversion and OOM 179

[Redacted]

[Redacted]

◆ [Redacted]

Project Management and Release Management

[Redacted]

[REDACTED]

- ◆ [REDACTED]

Requirements

[REDACTED]

[REDACTED]

- ◆ [REDACTED]

Implementation Weekend Testing (IWT) and Warranty Process

[REDACTED]

[REDACTED]

- ◆ [REDACTED]

Pre-Production Testing and Defects

[REDACTED]

[Redacted]

[Redacted]

◆ [Redacted]

Production Testing Monitoring and Defects

[Redacted]

[Redacted]

[Redacted]

- ◆ [Redacted]

Process Issues

[Redacted]

[Redacted]

[Redacted]

[Redacted]

◆ [Redacted]

Resource Management and Vendor Coordination

[Redacted]

[REDACTED]

[REDACTED]

◆ [REDACTED]

Appendix C

Pre-Production Defect Management Key Learnings



| Selected Pre-Production Defect Management Key Learnings | | | |
|---|------------|------------|------------|
| KLR | Finding | Root Cause | Resolution |
| [Redacted] | [Redacted] | [Redacted] | [Redacted] |
| [Redacted] | [Redacted] | [Redacted] | [Redacted] |
| [Redacted] | [Redacted] | [Redacted] | [Redacted] |

| Selected Pre-Production Defect Management Key Learnings | | | |
|---|------------|------------|------------|
| KLR | Finding | Root Cause | Resolution |
| | [REDACTED] | [REDACTED] | [REDACTED] |
| ■ | [REDACTED] | [REDACTED] | [REDACTED] |
| ■ | [REDACTED] | [REDACTED] | [REDACTED] |

| Selected Pre-Production Defect Management Key Learnings | | | |
|---|------------|------------|------------|
| KLR | Finding | Root Cause | Resolution |
| | | | [REDACTED] |
| [REDACTED] | [REDACTED] | [REDACTED] | [REDACTED] |
| | | | [REDACTED] |
| | | | [REDACTED] |
| | | | [REDACTED] |
| | | | [REDACTED] |
| | | | [REDACTED] |

Source: Document Request 1

Appendix D Production Defect Management Key Learnings



| Selected Production Defect Management Key Learnings | | | |
|---|-----------------------|-------------|------------------|
| KLR | Finding | Root Cause | Resolution |
| █ | █ █ █ █ █ | █ █ | █ █ |
| █ | █ █ | █ █ █ | █ █ █ █ |

| Selected Production Defect Management Key Learnings | | | |
|---|------------|------------|------------|
| KLR | Finding | Root Cause | Resolution |
| ■ | [REDACTED] | [REDACTED] | [REDACTED] |
| ■ | [REDACTED] | [REDACTED] | [REDACTED] |
| ■ | [REDACTED] | [REDACTED] | [REDACTED] |

| Selected Production Defect Management Key Learnings | | | |
|---|---------|------------|------------|
| KLR | Finding | Root Cause | Resolution |
| | | | |
| | | | |

Source: Document Request 1

Appendix E

Regional Severity Comparison

During the April Release, different regional severity classification methods existed between AT&T's 13-state operations and those of the 9-state legacy BellSouth system. A side-by-side comparison is insightful, providing insight into problems experienced during the release.

| Wholesale Order and Pre-Order Production Severity Levels Comparison of 9-state and 13-state Regions | | | |
|--|--------------------|---|---|
| | | 9-state* | 13-state** |
| Severity 1 | Description | <p style="text-align: center;">Critical</p> <p>Problem results in a complete system outage and/or is detrimental to the majority of the development and/or testing efforts.</p> <p>(Note: Severity 1 defects that are discovered in "Production" will be classified as a Type I System outage)</p> | <p style="text-align: center;">Extreme System Problem</p> <p>This applies to any problem which may impact the CLEC/LSC, has no manageable workaround, and also meets at least one of the following criteria:</p> <p>Blocks execution of all or a majority of implementation weekend test conditions or production order/preorder functions,</p> <p>More than 50% of multiple CLEC transactions or orders are impacted</p> <p>Extreme LSC impact (500 orders per week falling out)</p> <ul style="list-style-type: none"> • Major 271 compliance • Executive or presidential complaint • High profile customer • High volume customer |
| | Fix Time | No information. | <p style="text-align: center;">0 to 5 Days</p> <p>Fix and recover as soon as possible. Expectation is that issue will be resolved as quickly as possible. All necessary development testing, SCRIM and implementation resources moved to resolve the issue. Severity 1 defects are exempt from CMP, warranty, and maintenance release processes. However, they are reviewed for Accessible Letter impacts. If necessary, an information</p> |

| Wholesale Order and Pre-Order Production Severity Levels Comparison of 9-state and 13-state Regions | | | |
|--|--------------------|--|---|
| | | 9-state* | 13-state** |
| | Description | <p>Serious System functionality is degraded with serious impact to the users and there is not an effective work-around.</p> | <p>Major Production Problem Any defect production problem, may impact the CLEC/LSC, has NO manageable workaround, and also meets at least one of the following criteria: Blocks execution of several test conditions during Implementation Weekend Testing or production order/preorder functions. More than 20% of multiple CLEC orders impacted.</p> |
| Severity 2 | | | <p>LSC impacted by 50 to 499 orders per week. Performance measures missed; more than \$20,000 and less than \$100,000 monthly fines levied A combination of the following severe business impact considerations:</p> <ul style="list-style-type: none"> • Major 271 compliance • Executive or presidential complaint • High profile customer • High volume customer |
| | Fix Time | <p>Within 10 business days following the date upon which AT&T SE's defect validation process is scheduled to complete.</p> | <p>0 to 45 Days For defects found during the tri-annual release warranty period that do not require an Accessible Letter, fix immediately for installation in a warranty release. For defects found after the tri-annual release warranty period, development is required to provide root cause and fix description within seven calendar days. Implementation of fix required within 60 calendar days. Fix time is directly dependent on CMP, the defect position on the prioritized maintenance release packaging list, and the number of defects in queue.</p> |
| | Description | <p>Moderate System functionality is Degraded with a Moderate adverse impact to the users and there is an effective work-around.</p> | <p>Average For defects found during the tri-annual release warranty period that do not require an Accessible Letter, fix immediately for installation in a warranty release. For defects found after the tri-annual release warranty period, development is required to provide root cause and</p> |

| Wholesale Order and Pre-Order Production Severity Levels Comparison of 9-state and 13-state Regions | | | |
|--|--------------------|---|---|
| | | 9-state* | 13-state** |
| Severity 3 | | | prioritized maintenance release packaging list, and the number of defects in queue. |
| | Fix Time | Within 30 business days following the date upon which AT&T SE's defect validation process is scheduled to complete. | 0 to 60 days |
| Severity 4 | Description | Cosmetic There is no immediate adverse impact to the users. | N/A |
| | Fix Time | Within 45 business days following the date upon which AT&T SE's defect validation process is scheduled to complete. | N/A |

**Source: AT&T SE Change Control Process Guide*

***Source: Document Request 4*

Appendix F

Staff's Analysis of AT&T's Commitments

AT&T provided a list of forty commitments specific to lessons learned from the April Release and development of future 22-state OSS releases. The commitments, current status, and staff's assessment of each are discussed below:

1. Resolve all Severity 1 and 2 defects.

Defects are problems discovered in pre-production and production versions of an application interface. The problems occur when the OSS interfaces are not working in accordance with AT&T's baseline user requirements or the business rules that AT&T has established. Pre-production defects are identified and initiated by AT&T application test teams prior to an application being released into production. Production defects are identified and initiated by CLECs or AT&T through AT&T's Change Management/Control Process (CMP) after an application is released into production. CMP is the method by which AT&T manages requested changes (e.g., software, hardware, regulatory) to existing interfaces and the introduction of new interfaces.

Upon identification, defects are assigned one of four severity levels for the purpose of prioritizing the development of software correction. According to AT&T's Southeast CMP Process Guide, a Severity 1 defect is one that is *critical* and results in a complete system outage or is detrimental to the majority of the development or testing efforts. A Severity 2 is one that is *serious* and results in severe degradation of system functionality and there is not an effective work-around. A Severity 3 defect is *moderate* and results in system degradation, but there is an effective workaround. A Severity 4 defect is *cosmetic*, meaning that there is no adverse impact to the users.

AT&T further delineates defects as either CLEC-impacting and non CLEC-impacting. CLEC-impacting defects have a direct impact on the CLEC's ability to exchange transactions with AT&T and may include documentation that is in error, has missing information or is unclear in nature. Non CLEC-impacting defects impact AT&T backend interfaces and CLEC orders are not affected. The definitions of non-CLEC and CLEC impacting defects have been the subject of much debate over numerous years.

AT&T specifically committed to resolve Severity 1 and Severity 2 defects opened in the Southeast region that resulted from the April Release. AT&T identified [REDACTED] Severity 1 April Release production defects. Of these [REDACTED] defects, 64 were CLEC-impacting and [REDACTED] were non-CLEC impacting. The [REDACTED] Severity 1 defects were resolved and closed as of September 5, 2008. AT&T further identified [REDACTED] Severity 2 defects. Of these [REDACTED] defects, 82 were CLEC-impacting and [REDACTED] were non-CLEC impacting. As of September 5, 2008, eight Severity 2 defects remain open, of which six are CLEC impacting.⁴⁴

⁴⁴ As of September 5, 2008, AT&T identified the following DRs as open: 185023, 185085, 185153, 185120, 184784, 184686, 184682, and 184633.

Staff's assessment: Staff believes that it is premature to close this item. AT&T has satisfied the resolution of all Severity 1 defects; however, ■■■ Severity 2 defects remain open. Staff expects the remaining Severity 2 defects to be remedied prior to implementation of the next 22-state OSS release.

2. Provide status related to transmittal of Line Loss Notifications.

The April Release resulted in Severity 1 defects associated with the flow of status reports, such as CLEC Line Loss Notifications. According to AT&T, all outstanding defects associated with Line Loss Notifications have been fixed and all outstanding Notifications were transmitted successfully on May 16, 2008. AT&T resumed normal transmission of Line Loss Notifications on May 17, 2008. AT&T considers this item to be closed.

Staff's assessment: Staff concurs with AT&T to close this item.

3. Provide status related to the Billing Completion Notices (BCN).

Similar to the issue regarding Line Loss Notifications, Severity 1 defects were opened that impacted CLECs receipt of Billing Completion Notifications. According to AT&T, system issues impacting Billing Completion Notifications were resolved on May 20, 2008. By June 9, 2008, AT&T completed transmission of all delayed Billing Completion Notifications. AT&T considers this item to be closed.

Staff's assessment: Staff concurs with AT&T to close this item.

4. Maintain recurring status calls to discuss resolution of Severity 1 and Severity 2 April Release defects.

Beginning on May 12, 2008 AT&T held weekly status calls opened to all CLECs to discuss the resolution of the April Release Severity 1 and 2 defects. Notification of the calls was communicated to CLECs via AT&T's Accessible Letter notification process. On the July 15, 2008 call, the CLECs agreed that it was no longer necessary to continue with the weekly calls to discuss the April Release defects. AT&T now considers this item to be closed.

Staff's assessment: Staff concurs with AT&T to close this item.

5. Continue to status plans for currently scheduled 22-State releases within existing monthly CMP/CCP Meetings. Enhance clarity of pre-release communications by providing a review of all systems and customer interface changes included in future 22 State releases in advance of Accessible Letter communications. Use this input to improve the clarity of Accessible Letter information.

AT&T uses the monthly Change Management Process (CMP) meetings to communicate the status of future OSS releases and customer interface changes. According to AT&T, the Change Management team will review each system related Accessible Letter to ensure that it accurately reflects release information to the CLEC community. The CLEC input gained from the monthly meetings will also be used to improve the clarity of future Accessible Letters. AT&T further added a standing agenda item to the CMP meetings to review Accessible Letter clarity. AT&T considers this item to be closed.

Staff's assessment: Staff concurs with AT&T to close this item with the understanding that AT&T will continue to provide the status of future OSS releases via the Change Management and Accessible Letter processes. AT&T has demonstrated that the Accessible Letter format has improved and the Change Management Process agenda includes discussion of the status of all OSS releases or changes to existing OSS.

6. Provide an outline of CLEC training materials for future 22-state releases.

AT&T is developing CLEC training plans for future 22-state releases and the plans have been verbally shared with CLECs at CMP meetings to date. AT&T will further provide online leader led training sessions for the November 2008 and March 2009 Releases. In support of this commitment, AT&T provided staff with outlines of the available training, including training enrollment procedures and a timeline for the November 2008 and March 2009 Releases. The training plans will be on the agenda for the November CMP meeting. AT&T considers this item to be closed.

Staff's assessment: Staff believes that it is premature to close this commitment. While staff recognizes AT&T's efforts to develop guidelines for the next two OSS Releases, the training guidelines and specific plans have yet to be provided to staff and discussed with the CLECs.

7. Make available to CLECs a recorded message that reports the status of releases during implementation weekends.

The CLECs agreed with AT&T to provide the status of releases during implementation weekends via AT&T's CLEC Online website. According to AT&T, the release status will be updated and posted twice each day over the implementation weekends. AT&T considers this item to be closed.

Staff's assessment: Staff concurs with AT&T to close this item. Staff agrees that AT&T has implemented a process of reporting the status of releases during implementation weekends.

8. Establish a virtual "War Room" during the initial three days after scheduled releases to update CLECs of any post-release issues.

In response to this commitment, AT&T stated that it will issue an Accessible Letter one week prior to each future 22-state OSS release providing conference bridge information to the CLECs. A conference call will be held each day for three days following each scheduled release to discuss any post-release issues. AT&T also advised the Commission staff that AT&T will create and post on its CLEC online website a release status document which will be updated twice daily during a release weekend. This was announced to the CLEC community via an Accessible Letter on August 8, 2008. AT&T further noted that beginning with the November 2008 Release and for all 22-state release thereafter, AT&T will provide a brief update of the issues covered on the daily war room calls. AT&T considers this item to be closed.

Staff's assessment: Staff concurs with AT&T to close this item. Staff believes AT&T has developed a procedure that adequately documented the virtual "War Room" process which will be implemented in future 22-state OSS releases.

9. Provide a single documentation that clearly describes the roles and responsibilities of AT&T's; 1) Wholesale Customer Support Managers, 2) Information Services Call Center, and 3) Mechanized Customer Production Center.

AT&T provided documentation describing the general understanding of the roles, responsibilities, and functions of AT&T's customer service contacts listed below. The documentation was provided as an attachment to AT&T's June 12, 2008 Accessible Letter and posted to AT&T's CLEC Online website. AT&T considers this item to be closed.

- ◆ Information Services Call Center
- ◆ Mechanized Customer Production Support Center
- ◆ Senior Carrier Account Manager
- ◆ Wholesale Support Manger
- ◆ Local Service Center

Staff's assessment: Staff concurs with AT&T to close this item.

10. Perform internal documentation review to enhance clarity of web-based defect reporting.

AT&T provided revised documentation supporting the process for creating a daily defect report. The documentation further clarifies defect descriptions and also includes additional internal procedures, such as multiple peer-to-peer review prior to posting. AT&T considers this item to be closed.

Staff's assessment: Staff believes that it is premature to close this commitment. Staff acknowledges that AT&T has developed internal documentation to enhance the clarity to support the process for creating a defect report. However, staff is concerned that the information

provided on the web-based defect report does not adequately reflect enough information for CLECs to discern the status and resolution of defects. This issue was raised by the CLECs in the November 5, 2008 CMP meeting.

11. Perform internal documentation review to enhance clarity of XML documentation.

AT&T provided documentation outlining the methods and procedures for developing one consolidated repository to view the business rule requirements for pre-ordering and ordering. Via AT&T's CLEC Online website, CLECs have the ability to view the Local Ordering Handbook (LOH), Local Service Pre-Ordering Requirements (LSPOR), and Local Service Ordering Requirements (LSOR). According to AT&T, modifications will be made to each using a phased-in approach by discussing each phase (OSS Release) with the CLEC prior to implementation. AT&T considers this item to be closed.

Staff's assessment: Staff believes that it is premature to close this commitment. While the process of consolidating the pre-ordering and ordering business rules has been documented, the process itself has not been fully implemented. AT&T noted that the AT&T Southeast LSOR will be available with the November OSS Release, while the LSPOR is currently in development and will be available after implementation of the 22-state XML application.

12. Correct identified issue with reject reason field to restore to pre-release length of 5 characters.

With implementation of the April Release, LSR reject messages and codes were modified to conform to the new 22-state email manual ordering process. The reject codes were flawed. As a result, AT&T subsequently reset the LSR reject codes to the conditions used prior to the April Release. AT&T issued an Accessible Letter on May 13, 2008, advising the CLECs of the revised manual LSR reject code to be reset at a length of 5 characters. The list of the revised reject messages and codes were included as an attachment to the Accessible Letter. AT&T considers this item to be closed.

Staff's assessment: Staff concurs with AT&T to close this item.

13. Perform internal documentation review to enhance clarity of Systems Outages Notifications.

System outage notifications are currently accessible via a CLEC link posted on AT&T's CLEC Online website. The outages are sorted by interface type (e.g., LENS, EDI, and TAG) and further broken down by time of occurrence and reason for the outage. In response to the CLECs concerns regarding the clarity of the system outage notifications, AT&T states, "The system outage notification process has not changed, however organizationally, we have realigned (completed as of March 10, 2008) in such a way that the outage notifications are now

communicated across all regions of AT&T by the Information Services Call Center (ISCC). The ISCC, based upon the concerns raised following the April Release, has improved the detail and clarity of the communications.” Both the pre- and post-merger processes are to send the CLECs an email within 15 minutes that verifies the existence of an outage.

AT&T further reviewed several months of the SQM and SEEM reports as well as the corresponding pre- and post-outage reports to determine if changes should be applied to AT&T’s wholesale SQM and SEEM plans. According to AT&T, the data matches correctly and no changes are warranted.

Staff also notes that on June 12, 2008, AT&T gave a presentation to Commission staff on the overview of the April Release impacts to its wholesale Performance Measurement Analysis Platform (PMAP) and SEEM plans. An additional discussion on this topic was provided to the CLEC community on June 24, 2008, as part of an OSS status update call. AT&T assured staff and the CLECs that testing was done to ensure continued receipt of appropriate data required to produce SQM and SEEM measures and calculate remedies. AT&T considers this item to be closed.

Staff’s assessment: Staff concurs with AT&T to close this item as it relates to system outage notifications. However, staff notes that it will soon be initiating a review of AT&T’s wholesale Performance Assessment Plan.

14. Take into consideration comments received from customers to date and cover results with CLECs once completed.

In response to this commitment, AT&T noted that CLEC comments are captured and addressed within the CMP Action Logs. The Action Log contains the initiator (CLEC name) of the comment, the date comment was received, a summary of the comment, the current status, and AT&T’s reply. The results of the Action Log are discussed with the CLECs once completed. AT&T considers this item to be closed.

Staff’s assessment: Staff believes that it is premature to close this item. Although staff agrees with AT&T’s process of using the Action Log to capture CLEC comments after they have been accepted, AT&T did not elaborate on the company’s current CMP procedures and processes for escalating and denying CLEC action item requests.

15. Utilize root cause analysis of release defects to expand Testing Plans with special focus on the area of delivering outbound transactions.

AT&T will expand testing plans with special focus in the area of delivering outbound transactions. Specific tests will be established for validating that outbound transactions such as firm order confirmations, clarifications, completion notices, and billing completion notices delivered to their destination point in a form compatible with existing standards and interface

agreements. AT&T noted that relevant key learnings from the root cause analysis will be incorporated into future test plans. AT&T considers this item to be closed.

Staff's Assessment: Staff concurs with AT&T to close this item with the understanding that AT&T would fully utilize the newly expanded Test Plan upon implementation of future OSS releases. Staff notes that AT&T's expanded 22-state Test Plan incorporates end-to-end testing to include cooperative testing with CLECs and simulations to test outbound notifications. Furthermore, the scheduling of individual project test plans will be determined in alignment with the overall milestone dates for each OSS release.

16. Encourage and support greater CLEC participation in cooperative testing for all releases, utilizing existing CLEC test environments.

In response to this commitment AT&T noted that efforts have been made to encourage greater CLEC participation in pre-release testing via CMP meeting and Accessible Letters. AT&T provided an extract from the minutes of the September 10, 2008 CLEC User Forum meeting where AT&T noted acceptable CLEC testing associated with email acknowledgements for CLEC placed orders. AT&T considers this item to be closed.

Staff's assessment: Staff concurs with AT&T to close this item with the understanding that AT&T will continue to encourage CLEC cooperative testing for future OSS releases.

17. Evaluate manual process to determine what steps can be taken to test the process and allow CLECs the opportunity to practice for new forms/templates.

To satisfy this commitment AT&T offered online sessions with interested CLECs to walk through the changes to LSR forms used for manual ordering. Sessions were scheduled and announced via the CLEC Users Forum. For any implementation of new forms, AT&T will hold sessions within 30 days of the implementation date. AT&T considers this item to be closed.

Staff's assessment: Staff concurs with AT&T to close this item with the understanding that AT&T will continue working in the same manner to support any individual CLECs that may raise issues with regards to the completion and processing of LSR forms used in the manual email ordering process.

18. Going forward, schedule 22-state releases for the SE region will provide overlap between the existing and new customer interfaces (EDI, XML, and Verigate/LEX/LENS), in order to allow customers to plan/test/develop individual migration strategies to the new interfaces.

AT&T's current OSS release plans associated with implementation of new functionality and implementation of 22-state platforms will have overlap built into it. In support of this commitment, AT&T provided to staff an October 10, 2008 Accessible Letter that served as a

notice for retirement of AT&T's Southeast region interfaces in late 2009. In the letter, AT&T further noted that AT&T's Southeast region interfaces will continue to be available upon introduction of new 22-state releases, such as the XML Gateway. AT&T considers this item to be closed

Staff's assessment: Staff concurs with AT&T to close this item.

19. Testing to include appropriate back out plans for the implementation weekend.

According to AT&T, future 22-state OSS release back out plans are still in the production stage and noted that back out scripts are pre-written and approved at least a week prior to the release weekend. In response to this commitment AT&T provided a boiler-plate Back Out Plan that includes provisions for:

- ◆ Identifying impacted applications
- ◆ Identifying fixes that are not feasible
- ◆ Communicating with executive teams
- ◆ Communicating with CLECs to review back-out options.
- ◆ Stopping production
- ◆ Removing production code and reverting to the previous version

Staff's assessment: Staff concurs with AT&T to close this item with the understanding that AT&T will develop and implement back out plans, if needed, specific to each future 22-state OSS release.

20. Development of Emergency Plan with a focus on 1) Customer Notification and Support, 2) Defect Resolution, 3) Expanded AT&T staffing requirements.

AT&T has documented an Emergency Communication Plan that addresses defect identification, defect resolution, weekend release staffing, and customer notification,. The Plan further outlines communication steps to be followed within defined intervals if a back out decision is made.

Staff's assessment: Staff concurs with AT&T to close this item; however, staff believes that AT&T's Communication Plan can be improved. The Plan appears to have not been thoroughly developed and thought-out in detail. Additionally, it is unclear to staff how the Plan is communicated with AT&T personnel and incorporated into company policies and procedures.

21. Provide continuing education, individualized customer support, and customer working sessions to assist in successful submission of the manual LSR forms through use of the email process.

AT&T created an internal process of pulling together members of its Wholesale Support Management team to assist CLECs in working sessions scheduled by AT&T Account Managers. The Wholesale Support team would be able to identify the specific issue or related product information to allow the right resource to assist on the CLEC call. AT&T implemented the following steps for resolving the email process issues and now considers this item to be closed:

- ◆ Obtaining pertinent information from CLEC concerning specific issue
- ◆ Referring to manual email ordering documentation on CLEC Online to determine if it addresses the issue
- ◆ Obtaining additional assistance from manual email ordering from AT&T's subject matter experts (SMEs)
- ◆ After resolution, AT&T will provide information to the CLEC via email or phone
- ◆ Escalating issues with significant difficulty to manual email ordering subject matter experts to arrange for an on-line overview training session

Staff's assessment: Staff concurs with AT&T to close this item with the understanding that AT&T's enhanced internal process to proactively support and resolve manual email ordering issues remains intact.

22. Lead a monthly email/manual forms user forum to provide common support and address current manual process issues until all 22 state releases are completed.

AT&T created an email manual ordering forum as a standing segment to the monthly CLEC User Forum (CUF) agenda. The meeting is opened to all CLECs. In response to the commitment, AT&T provided the Accessible Letters announcing the June, July and August 2008 CLEC User Forum monthly meetings to discuss issues surrounding the manual email ordering process. AT&T considers this item to be closed.

Staff's assessment: Staff concurs with AT&T to close this item with the understanding that any manual email ordering issues that may occur in the future can be addressed via the CLEC User Forum, if necessary.

23. Continue to work with all CLEC customers who request further assistance or education on the manual LSR ordering process.

In response to this commitment, AT&T provided a listing of 23 CLEC customers who requested further assistance in resolving manual email ordering issues. AT&T noted that CLEC working sessions are held when requested. AT&T considers this item to be closed.

Staff's assessment: Staff concurs with AT&T to close this item with the understanding that AT&T will continue working in the same manner to support any individual CLECs that may raise issues with regards to the manual email ordering process.

24. Assess CLEC concerns where all pages of a form are required whether or not all pages contain data. Address customer concerns regarding the requirement of additional data.

AT&T provided a May 30, 2008 Accessible Letter submitted to CLECs to be used as assistance in preparation of the manual LSR forms. In the letter, AT&T provides details of some of necessary inputs to complete the LSR form correctly, reasons for errors, and updates made to the Manual Ordering Guidelines and Local Ordering Handbook. AT&T considers this item to be closed.

Staff's assessment: Staff concurs with AT&T to close this item with the understanding that AT&T did address the CLECs concern regarding the requirements for additional data to properly complete manual LSR forms. However, staff believes that issuance of one Accessible Letter after another is not the appropriate means to provide corrections to ordering processes. For example, below is a listing of 15 Accessible Letters addressing the manual email ordering process alone. Staff believes that AT&T and the CLECs should develop and pursue an alternative means of documenting and communicating corrections and resolutions made to existing processes that are used in a production environment.

- ◆ Accessible Letter - CLECSE08-054, April 25, 2008, re: Manual LSR Remarks -LOAs and Commingle EELs - Special Handling (All Carriers)
- ◆ Accessible Letter - CLECSE08-055, April 25, 2008, re: Manual LSR Update for the DDD-Desired Due Date and D/TSENT - Date and Time Sent fields (All Carriers)
- ◆ Accessible Letter - CLECSE08-059, May 2, 2008, re: Updated for Manual LSR Update or the DDD-Desired Due Date and D/TSENT - Date and Time Sent fields (All Carriers)
- ◆ Accessible Letter - CLECSE08-060, May 2, 2008, re: Use INIT EMAIL Field On The LSR Manual Form As Alternative Email Address For Receipt Of Notifications
- ◆ Accessible Letter - CLECSE08-061, May 2, 2008, re: SUPER FATAL AND MANUAL REJECT MESSAGES ASSOCIATED WITH 22-STATE MANUAL EMAIL FOR (ALL CARRIERS)
- ◆ Accessible Letter - CLECSE08-067, May 8, 2008, re: MANUAL LSR UPDATE FOR THE PORTED NBR (PORTED NUMBER) FIELD ON THE LOOP SERVICE W/NUMBER PORTABILITY AND NUMBER PORTABILITY FORMS (ALL CARRIERS)

- ◆ Accessible Letter - CLECSE08-068, May 8, 2008, re: Manual LSR Update for the PORTED NBR (Ported Number) field on the Loop Service w/Number Portability and Number Portability forms (All Carriers)
 - ◆ Accessible Letter - CLECSE08-070, May 13, 2008, Replacement for CLECSE08 and CLECSE08-068 - Manual LSR Update for the PORTED NBR (Ported Number) field on the Loop Service w/Number Portability and Number Portability forms (All Carriers)
 - ◆ Accessible Letter - CLECSE08-071, May 13, 2008, Update to Manual Reject Messages (All Carriers)
 - ◆ Accessible Letter - CLECSE08-072, May 14, 2008, Address Corrections for REQ TYP A (All Carriers)
 - ◆ Accessible Letter - CLECSE08-075, May 20, 2008, Complex Product Ordering Responsibility Changes (All Carriers)
 - ◆ Accessible Letter - CLECSE08-030, May 20, 2008, Billing Completion Notifications Backlog Transmission to CLECs
 - ◆ Accessible Letter - CLECSE08-077, May 21, 2008, LSR Manual Ordering Guidelines Updated and a New Frequently Asked Questions Document (All Carriers)
 - ◆ Accessible Letter - CLECSE08-086, May 30, 2008 Updated the Manual Ordering Guidelines, New Frequently Asked Questions Document and the 27.1 LOH (22-State) (All Carriers)
- 25. Review and assess the prioritized list of customer change requests for enhancements to the 22-state email LSR process. Reevaluate merger related OSS Change Requests previously submitted through the Change Management process.**

CLEC change requests for enhancements to the manual email ordering process are submitted to AT&T via the CLEC User Forum Issue Submission Form. AT&T then assigns and prioritizes the change requests internally. In response to this commitment, AT&T provided three specific change requests that address the email manual ordering process:

- ◆ CUF Issue 08-006, May 26, 2008 re: acknowledgements not being returned to CLECs on manual orders.
- ◆ CUF Issue 08-008, May 27, 2008 re: updating of Manual Ordering Guidelines.
- ◆ CUF Issue 08-009, May 27, 2008 re: LSC Manual ordering Process Flow.

ATT states that two of the three change requests have been resolved. The third, CUF Issue 08-009, is noted as “in progress” with a targeted review for discussion in the September 2008 AT&T/CLEC Email Ordering Forum. AT&T considers this item to be closed.

Staff’s assessment: Staff believes that it is premature to close this item. It appears that CUF Issue 08-008 may have been discussed and possibly resolved in the September 2008 Email Ordering Forum; however, no supporting documentation was provided to staff to concur with closure of this item.

As part of this commitment AT&T also stated that it will re-evaluate merger related OSS Change Requests previously submitted through the Change Management process. AT&T did not provide any documentation in support of the re-evaluation. Staff would point to the CLECs “Best Practices” provided to AT&T for consideration when implementing the new 22-state OSS releases. At the May 2008 staff workshop, the CLECs argued that AT&T failed to adequately address and respond to the Best Practices.

26. Complete updates to the Local Ordering Handbook to reflect changes via the Accessible Letter.

This commitment addresses the issue regarding incorrect manual ordering guidelines. According to AT&T, the updates to the manual ordering guideline, also known as the Local Ordering Handbook (LOH), have been completed. The updates and changes are reflected in the Accessible Letters issued subsequent to the April Release. Staff notes that item 4 above identifies the specific Accessible Letters. AT&T considers this item to be closed.

Staff’s assessment: Staff concurs with AT&T to close this item with the understanding that AT&T did address the CLECs concern regarding the updates to the Local Ordering Handbook. However, staff believes that issuance of one Accessible Letter after another is not the appropriate means to provide corrections to ordering processes. Staff believes that both AT&T and the CLECs should work together to develop and pursue an alternative means of documenting and communicating corrections and resolutions made to existing processes that are used in a production environment.

27. Proactive review and update of the 22-state manual LSR forms and email process documentation to address customer feedback.

In response to this commitment, AT&T provided staff with a May 21, 2008 Accessible Letter denoting that updated manual ordering documentation supporting the 22-state manual LSR forms and the email process. AT&T provided a link for viewing of the manual ordering guidelines. In the Accessible Letter, AT&T further states that a Frequently Asked Questions document has been developed to provide additional detail concerning form usage, the email process, error conditions and helpful references. AT&T considers this item to be closed.

Staff’s assessment: Staff concurs with AT&T to close this item.

28. Expand documentation quality control processes to ensure multiple layers of review prior to release of documents to the customer.

According to AT&T, the existing CLEC documentation quality process has been expanded to include additional layers of review for updates to the Local Ordering Handbook (LOH). In addition, a Southeast Local Service Order Requirement (LSOR) will be implemented for the November 2008 release which was developed using the quality review process. The LSOR will be available on AT&T's CLEC online website for the November Release. AT&T considers this item to be closed.

Staff's assessment: Staff concurs with AT&T to close this item.

29. Proactive billing adjustments, claims clean-up process for addressing exceptions that are not addressed in the proactive approach, and communication plan for the CLECs.

AT&T provided staff with an August 14, 2008 Accessible Letter discussing the resolution of the billing adjustments. The letter indicates that bill credits will appear on bill periods starting July 25, 2008 through September 30, 2008. Furthermore, support of the credits will be posted to AT&T wholesale Performance Measurement and Analysis Platform (PMAP). AT&T provided staff with an update of this commitment on October 23, 2008, wherein AT&T stated that all bill adjustments have been completed.

AT&T considers this item to be closed.

Staff's assessment: Staff concurs with AT&T to close this item.

30. Implement a temporary plan of action to handle calls by other service centers.

In March 2008, AT&T consolidated the former BellSouth Jacksonville, Florida and Birmingham, Alabama call centers, also known as Local Carrier Service Centers (LCSC) into one center located in Birmingham. As a result of the consolidation, the average speed of answer time more than doubled from February 2008 to March 2008 (41.74 seconds to 91.5 seconds). The average answer time remained high, at 62.29 seconds, in April 2008, due to the increased number of CLEC calls for orders that were backlogged by the April Release. In response, AT&T assigned call centers outside of the Southeast region to receive and expedite the processing of CLEC orders. In May, times returned to pre March levels, at 38.11 seconds. All April Release related calls temporarily handled by other service centers out of the Southeast region were moved back into AT&T's Birmingham LCSC by May 19, 2008. AT&T considers this item to be closed.

Staff's assessment: Staff concurs with AT&T to close this item.

31. Continue to manage April Release related expedites for the processing of acknowledgements for any individual situations if not addressed by the mechanized transmittal efforts.

In May 2008, AT&T implemented an escalation process for any CLEC orders that may still be missing notifications after the April Release defects appeared to be resolved. The escalation process begins with the CLEC order being assigned to AT&T's Wholesale Support Manger, who in turn, can escalate the order up to the Director of the Local Carrier Service Center (LCSC). AT&T considers this item to be closed.

Staff's assessment: Staff concurs with AT&T to close this item.

32. Continue to review staffing levels to meet anticipated demand for Wholesale Customer Support and Centers.

In response to this commitment, AT&T stated that its Local Carrier Service Centers (LCSC) continually reviews staffing requirements based on current and forecasted demand. AT&T considers this item to be closed.

Staff's assessment: Staff believes that it is premature to close this item. AT&T failed to provide staff with any documentation in support of staff requirements. At a minimum, staff expects to see an assessment of staffing levels based on current and forecasted demand and the impact to staffing levels based on implementation of future 22-state OSS releases.

Appendix G

Glossary of Acronyms and Terms

| Term or Acronym | Definition |
|-----------------|--|
| 9-state | This is the legacy BellSouth region and includes the states of Florida, Georgia, Alabama, Tennessee, Mississippi, Louisiana, South Carolina, North Carolina, and Kentucky. |
| 13-state | This is the legacy SBC Communications' region and includes the states of Texas, Kansas, Missouri, Illinois, Indiana, Michigan, Ohio, Wisconsin, California, Nevada, Arkansas, Oklahoma, Connecticut. |
| ADSL | Asymmetrical Digital Subscriber Line – A transmission technology that allows the use of one existing local twisted-pair to provide high-bandwidth data and voice services simultaneously. |
| AVP | Assistant Vice President |
| CCP | Change Control Process |
| CLEC | Competitive Local Exchange Company – An AT&T wholesale customer who competes with the Incumbent Local Exchange Carrier (ILEC) and other carriers in providing local service. |
| CMP | Change Management Process |
| CRIS | Customer Record Information System – The AT&T proprietary corporate database and billing system for non-access customers and/or services. |
| DSL | Digital Subscriber Line – Allows customers to provide simultaneous two-way transmission of digital signals at speeds of 256 kbps via a two-wire local channel. |
| EDI | Electronic Data Interchange – The computer-to-computer exchange of inter and/or intra-company business documents in a public standard format. |
| EDR | Enhanced Defect Report |
| EPE | Experienced Process Expert – Individual identified as process expert during implementation and use of Express One, and later as the IT Unified Process (IT UP) across 22-state region. |
| ETE (or ETET) | End-to-End Test is a test that verifies system functionality by following a set of data from its inception through all points where it is processed. ETET crosses multiple systems and Development Management/Test groups. Test cases are designed at a high level to prove connectivity between applications are up and working properly. |
| Express One | The IT standard Software Development Life Cycle management process used by the 13-states prior to the introduction of IT UP. |
| FOC | Firm Order Confirmation |
| FPSC | Florida Public Service Commission |
| GUI | Graphical User Interface |
| ISDN | Integrated Services Digital Network – An integrated digital network in which the same time-division switches and digital transmission paths are used to establish connections for different services. ISDN services include telephone, data, electronic mail, and facsimile. |

| Term or Acronym | Definition |
|-----------------|--|
| IT UP | IT Unified Process – A Software Development Life Cycle process introduced in late third quarter 2008 as the new 22-state standard that combines the Wireless Unified Process and Express One. |
| IWT | Implementation Weekend Testing is the User Acceptance testing of code in production. |
| KLR | Key Learnings Resolutions |
| LASR | Local Access Service Request System – System used by 22-state region to track and process Local Service Requests from CLECs |
| LAUTO | The automatic processor in LNP Gateway that validates LSRs and issues service orders. |
| LCSC | Local Carrier Service Center – The AT&T center which is dedicated to handling CLEC LSRs and preordering transactions, along with associated expedite requests and escalations. |
| Legacy System | Term used to refer to BellSouth Operations Support Systems |
| LENS | Local Exchange Navigation System – The BellSouth application developed to provide both preordering and ordering electronic interface functions for CLECs. |
| LEO | Local Exchange Ordering – The BellSouth system which accepts the output of CLEAC interfaces and provides first-level validation to ensure all appropriate fields are populated. |
| LESOG | Local Service Order Generation – A BellSouth system which accepts the service order output of LEO and enters the service order into the Service Order Control System using terminal emulation technology. |
| LEX | Local Service Request Exchange System – Interface used in 13-state region for LSR input |
| LNP | Local Number Portability – In the context of this document, the capability for a subscriber to retain their current telephone number as they transfer to a different local service provider. |
| LOIS | A fax server that provides automated imaging of LSRs. |
| LON | An inventory-based system responsible for tracking the processing status of LSRs. |
| LSC | Local Service Center |
| LSR | Local Service Request – A request from a CLEC for local resale service or unbundled network elements. |
| O&WS | Ordering & Wholesale Solutions is an organization within Customer Care and Billing (CC&B). |
| OmegaMan | Third party software product for monitoring systems/queues on mainframes. |
| OOM179 | Order of Magnitude 179 is a reference to the first estimating point of the AT&T/BellSouth Wholesale Local Merger Program. It has become the reference name for this merger program. |
| OSS | Operations Support Systems – Multiple support systems and databases which are used to mechanize the flow and performance of work. The term is used to refer to overall system consisting of complex hardware, computer operating system(s), and applications which are used to provide |

| Term or Acronym | Definition |
|-----------------|---|
| | the support functions. |
| OWS PMO | Ordering & Wholesale Solutions Project Management office |
| PGM | Program Manager |
| PMAP | Performance Measurement Analysis Platform – Provides delivery of performance reports via the web and facilitates analysis of the summary level data. |
| PMO | Project Management Organization |
| PRISM | Primary Repository for Information Systems Management is the graphical user interface and database that supports the IT Unified Process (IT UP). |
| QC | Quality Center |
| SCRM | Software Configuration Release Management team manages the code delivery from one environment to the next. |
| SEEM | Self-Effectuating Enforcement Mechanism – A tiered remedy structure in which payments are made either to the CLEC and/or state regulatory agency, depending on the type and level of parity/benchmark miss that occurs. |
| SGG | A routing and editing software application to help ensure the process of complete and error-free transactions. |
| SLA | A Service Level Agreement is an established or agreed upon commitment time frame and level of service for a given deliverable. |
| SOCS | System responsible for the collection, storage, and distribution of service orders. |
| SQM | Service Quality Measurements |
| ST2 | System Test 2 is one of the 9 state test environments used to conduct system tests. |
| TechM | Tech Mahindra – Subcontractor for Amdocs performing some testing functions during the April Release. |
| UAT | User Acceptance Testing is performed to validate the system of program t the User Requirements. |
| Vantive | The primary tool used to manage post production defects. |
| WBS | Work Breakdown Structure – Steps outlining a project plan for project management purposes. |
| WFM | Work Force Management |
| WMS | Work Assignment Management System. |
| WIT | Wholesale Integration Tests in the Amdocs system testing team. |
| XML | eXtensible Markup Language – An internal standards-based data formatting option designed for information exchange on network systems. |

7.0 COMPANY COMMENTS

1 **BEFORE THE FLORIDA PUBLIC SERVICE COMMISSION**

2
 3 In re: Investigation into the Establishment)
 4 of Operations Support System Permanent) Docket No. 000121A-TP
 5 Performance Measures for Incumbent)
 6 Local Exchange Telecommunications) Filed: January 9, 2009
 7 Companies (BellSouth Track))
 8 _____)

9
 10 **AT&T FLORIDA’S COMMENTS REGARDING**
 11 **THE COMMISSION’S STAFF’S APRIL OSS RELEASE REPORT**

12
 13 BellSouth Telecommunications, Inc. d/b/a AT&T Florida (“AT&T Florida or
 14 “AT&T”) respectfully submits the following comments regarding the Florida
 15 Commission Staff’s report entitled “Review of AT&T’s OSS April 2008 Release
 16 Analysis and Resolutions” (“Report”). The Report is the end product of Staff’s
 17 investigation into AT&T’s April 2008 OSS Release (“April Release”); an investigation
 18 which involved, among other things, Staff’s review of thousands of pages of documents
 19 provided pursuant to six separate audit data requests and Staff’s interviews with
 20 numerous AT&T subject matter experts. AT&T commends Staff’s efforts in drafting and
 21 issuing the Report on an expedited basis. That said, it is AT&T’s position that certain
 22 aspects of the Report go above and beyond the agreed upon audit scope, or fail to
 23 accurately and fully convey the efforts and processes AT&T has in place (or has
 24 developed) to ensure that future 22-state OSS Releases are implemented with minimal
 25 impact on the operations of competitive local exchange carriers (“CLECs”).
 26 Accordingly, AT&T submits the following comments regarding the Report.

27
 28 **1.0 Executive Summary**

29
 30 As explained below, much of the Report paints an inaccurate and incomplete
 31 picture of AT&T’s efforts in preparation for, execution of, and recovery from the April
 32 Release. Among other things, Staff: (1) failed to take into consideration the improvement
 33 AT&T applied to the two post-April OSS releases; (2) appears to have relied on
 34 misperceptions about the deployment of information technology, in particular that major
 35 software releases can be implemented without defects; and (3) failed to adequately
 36 recognize the extraordinary efforts AT&T has undertaken to meet the OSS needs of
 37 CLECs. Further, in many cases Staff’s recommendations go well beyond the agreed
 38 upon audit scope. Such “out of scope” recommendations should not be adopted or
 39 approved by the Commission.
 40

41 AT&T responded to the April Release issues with unprecedented levels of
 42 communication with both CLECs and Staff. It also engaged in rigorous self-examination
 43 processes. In addition to the formal Key Learnings Review (KLR) conducted by the
 44 Information Technology managers responsible for designing and implementing OSS
 45 changes, another less formal review was conducted by AT&T managers who work with
 46 CLECs on day-to-day business operations to determine what process improvement

1 needed to be made to improve CLEC communications and service. One key result of the
2 KLR was the development of an enhanced test plan for future 22-state OSS Releases.
3 The enhanced test plan has already produced two nearly flawless OSS releases which
4 occurred in August and November of 2008. The account management review produced a
5 significant list of commitments designed to insure high quality OSS releases in the
6 future—the type of releases that AT&T has provided for over ten years and more recently
7 implemented in August and November.¹ The commitments also addressed improved
8 CLEC communications---which are working so well that AT&T and its CLEC customers
9 have returned to pre-April communications processes, enhanced and improved with the
10 helpful suggestions made by AT&T's wholesale customers.

11
12 Of necessity, the Report looks backwards and focuses on April Release issues.
13 But much has changed since the time frames covered by the Report and there are many
14 improvements, some of which Staff notes in its Report, that AT&T has made that in large
15 part obviate the need for many of the recommendations Staff has proposed in its Report.
16 In other cases, AT&T has already adopted the measures Staff advocates in its
17 Recommendations. In section 7.0 below, AT&T provides its response to each Staff
18 recommendation. Notwithstanding the critical language of the Report and AT&T's
19 Comments, the Recommendations Section demonstrates that AT&T is largely in
20 agreement with Staff in that it has either already adopted, or has committed to adopt, the
21 changes Staff has recommended. Moreover, this level of consensus demonstrates that
22 AT&T has fully recovered from the April Release and has positioned itself to provide
23 high quality releases -- such as the recent August and November releases -- on a going
24 forward basis.

25 26 27 **2.0 Background and Perspective**

28
29 AT&T has no comments regarding the Background and Perspective portion of the
30 Report.

31 32 **3.0 Key Learnings & Root Cause Analysis**

33
34 AT&T Information Technology (IT) engages in a formal root cause analysis
35 process, called the Key Learnings Review (KLR), after every release to review and assess
36 what went wrong, what went right and what can be improved upon before the next
37 software release. That well-documented and detailed process has lead AT&T through
38 three major releases a year since 2002 which assisted in the creation from whole cloth of
39 local wholesale OSSs, deemed by this commission, commissions in 21 other states and
40 the FCC, to satisfy the rigorous requirements of the Telecommunications of 1996.
41 Although relying on the KLR word-for-word in many places in its Report, Staff
42 incorrectly concludes that AT&T did not properly conduct its review of the April Release
43 and that the KLR process as employed did not sufficiently adhere to what Staff believes
44 are necessary formal principles of such an evaluation (Report at p. 18). Staff also

¹ AT&T's commitments were filed with the Commission on May 27, 2008, and are set forth in Appendix F of the Report.

1 questioned the adequacy of some KLR findings and the closing of a very small
2 percentage of the issues.

4 **The KLR Process**

5 It appears that AT&T may not have helped Staff completely understand how the
6 KLR process works. AT&T's Key Learning tool is a robust and structured process that
7 has been successfully employed after every release. Based upon Staff's concern, AT&T
8 reviewed the Key Learning processes and output from the analysis of the April release
9 and determined that the process worked properly and as designed. The process is at once
10 both a very open process and also a tightly structured one; designed to insure that all
11 managers feel free to speak their minds, while those responsible for planning future
12 releases are given the task of evaluating the voluminous input and turning it into a
13 manageable action plan. The KLR is also, of necessity, a very time constrained process.
14 The highest priority findings must be identified, analyzed and acted upon, if at all
15 possible, before the next major release in order for the benefits of the process to be fully
16 realized and to go beyond a mere academic exercise.

17
18 The Report incorrectly concludes that no formal root cause analysis was
19 conducted, but rather, that employees merely offered opinions that were not critically
20 examined by management. This is not accurate. AT&T expended significant effort in
21 determining root cause of all issues identified. Not including extensive work done by
22 sub-teams, over [REDACTED] man hours were spent in management-facilitated meetings where
23 in-depth discussions were held and information gathered to determine root causes and
24 develop appropriate resolutions. The conclusions of all of these meetings were noted in
25 the Root Cause column of the on-line Key Learning tool. The findings then were used as
26 input to form improved plans for the nearly flawless August and November releases.
27 Clearly the process worked and worked well.

28
29 The process may not be elegant, but it is effective. Believing that all IT managers
30 are in a position to bring value to the process, AT&T permits and encourages every
31 manager, involved in every release, to submit comments on the release and to identify
32 what the managers believe to be areas which would benefit from improvement.
33 Managers need not have personal knowledge or expertise relevant to the item they
34 critique. As a result, not all findings are reliable or relevant. It is a bit like a suggestion
35 box in the IT foyer—all comments are welcome, but not all comments are ultimately
36 useful. As Staff notes in its Report, over [REDACTED] "learnings" were submitted by over [REDACTED]
37 managers covering everything from design to communications. The entries were then
38 assigned to teams formed around key release functions/elements for analysis and action.
39 At this time only two KLR issues remain open and they will be closed by the
40 implementation of the March Release.

43 **Specific Staff Findings**

- 44 • **Prematurely closed issues-** Staff incorrectly concludes that [REDACTED] Key Learnings (or
45 *less than 3%* [REDACTED] were closed prematurely. AT&T has reexamined
46 these [REDACTED] items and determined that any necessary corrective action was taken.

1 The confusion about whether some issues may have been prematurely closed can
 2 be attributed to ministerial error. When the resolutions were originally developed,
 3 the on-line tool was updated to indicate what corrective action was planned. After
 4 those measures were implemented, the issue owners were responsible for
 5 updating the tool to close their issues, but in some cases the wording they used
 6 was unclear. These [REDACTED] KLRs have since been updated to properly reflect action
 7 taken.

- 8 • **Adequacy of some analysis** - AT&T reviewed the [REDACTED] key learnings that Staff
 9 cited. These [REDACTED] items represent *less than 5%* of the total Key Learnings. While
 10 AT&T agrees that the documentation on these KLRs could have been more
 11 descriptive, even after re-evaluation it is clear that the tool adequately reflects the
 12 cause and, more importantly, that proper corrective action has been taken.
- 13 • **Assignment of certain issues to vendors** - Because of the close working
 14 relationship between AT&T and its vendors, and the expertise of those vendors,
 15 AT&T assigned some issues to vendors where they were in the best position to
 16 resolve an issue; in some cases a vendor was assigned along side an AT&T
 17 employee to work an issue. In all cases, every issue was subject to AT&T
 18 management oversight. Assignment of KLR issues to vendors was not an
 19 abdication of responsibility; it was an appropriate use of resources.
- 20 • **Critique of the KLR process** - Part of Staff's concern results from confusion
 21 about the purpose of KLR back up materials provided to Staff during the audit.
 22 Staff cites to a KLR job aid that instructs [REDACTED]

23 [REDACTED]
 24 [REDACTED]
 25 [REDACTED] The job aid is not a description of the KLR
 26 process, but rather instructions for inputting a KLR finding into the online tool.
 27 When an originator submits a finding, they may also provide their opinion as to
 28 the root cause of the KLR. However, no KLR can be closed before the team
 29 assigned to the KLR determines the actual root cause and corrective action is
 30 taken.

31 32 4.0 Defect Management

33
 34 In AT&T's view, the Report is unduly critical of AT&T's software defect
 35 management process and it underestimates the complexity involved with implementing
 36 software releases. As an initial matter, production defects are associated with every
 37 software release. Accordingly, the mere fact that there were an increased number of pre-
 38 production and post-production defects as compared to prior OSS releases does not
 39 necessarily demonstrate that there were inordinate problems with AT&T's defect
 40 management process. Indeed, AT&T's overall success with OSS releases since the
 41 passage of the 1996 federal Telecommunications Act squarely supports the conclusion
 42 that AT&T's defect management process is more than adequate and in no need of any
 43 major modifications. In sum, AT&T has long considered defect analysis and correction
 44 to be a priority. AT&T performs analysis on each defect that is identified and
 45 implements the appropriate corrective action as quickly as it is practicable to do so.
 46

1 AT&T strongly disagrees with Staff's belief that AT&T "grossly underestimated
2 the quantity, scope, and severity of defects that might be encountered with [the April]
3 release." (Report, at pp. 4 and 37). It is AT&T's view that unsupported and subjective
4 opinions or beliefs (such as the one quoted above) should not be included in an objective
5 investigation and analysis into the April Release.
6

7 It is AT&T's position that the Report unfairly characterizes AT&T's defect
8 reporting as inaccurate (Report, at pp. 27, 28, 31). The reporting of defects is a priority to
9 AT&T, the Florida Commission, and to the CLEC community. As part of the process of
10 reporting defects, AT&T reports the defects in a manner that is based upon the impact to
11 the end user. As background, and in connection with its performance measurement plan
12 (SQM/SEEM Plan), AT&T publishes reports of Southeast CLEC affecting defects to the
13 Florida Commission.
14

15 Due to issues immediately following the implementation of the April Release,
16 many inquiries were made regarding infrastructure changes made to systems in the
17 Southeast and the defects associated with those changes. In response to Staff's inquiries,
18 AT&T reported on the number of CLEC impacting defects and later on the number of
19 non-CLEC impacting defects in the Southeast region. These figures did not include
20 defects associated with all of the systems in other regions that required coding changes to
21 provide services throughout AT&T's regions. These reported defect counts also did not
22 include any corrected pre-production defects, which do not have any effect on production
23 system functionality.
24

25 Following these initial requests, Staff began an audit of the April Release and
26 asked for numbers of all defects associated with the April Release and all defects that
27 were identified in the pre-production environment. Because Staff's audit-related request
28 was broader in scope, the defect numbers provided by AT&T were greater than those
29 previously reported to Staff.
30

31 As part of the defect management process, defects are identified in pre-production
32 and post-production phases. The goal of the pre-production phase is to capture and
33 prevent defects from going into production. The volume of corrected defects identified
34 during pre-production timeframes is not indicative of the success or failure of any
35 particular release. In fact, with the unprecedented number of test cases that were
36 executed with the implementation of new systems into the Southeast region, it was
37 reasonable to expect a significant increase in the number of pre-production issues
38 identified and resolved that were associated with the April Release.
39

40 Regarding the execution of test cases for the April Release, AT&T relied on its
41 extensive and successful experience within the former BellSouth region as well as the
42 cross-regional experience within the 13-state region to develop and execute what AT&T
43 reasonably believed were comprehensive test case scenarios to address functionality
44 concerns.
45

1 Additionally, cooperative testing was offered to CLECs to provide these clients
2 with the functionality of the systems. Indeed, sixteen CLECs participated in the
3 cooperative testing process, and any issues that were identified during such process were
4 addressed and corrected prior to the April Release. Given such, AT&T was reasonably
5 confident that CLEC concerns had been identified and appropriately addressed prior to
6 the implementation of the April Release. In hindsight, given the issues that arose during
7 the weeks immediately following the release, AT&T has significantly enhanced its
8 testing capability as evidenced in the 22-state test plan as well as encouraging more
9 CLECs to actively participate in cooperative testing so as to effectively address this issue
10 for future releases.

11
12 The Report notes that there were ■■■ open defects at the time of the April
13 Release (Report, at p. 29). ■■■ of these defects were not CLEC impacting. The six
14 CLEC impacting defects, which were reported as going into production with the release
15 implementation, had work arounds and contingency plans to address each of them.

16
17 The Report notes that AT&T used two defect reporting tools for entering and
18 tracking pre-production defects associated with the April Release. (Report, at p. 30).
19 Issues that arose as a result of using two different reporting tools have been eliminated.
20 As part of AT&T's continued efforts to gain operational efficiencies with its merger with
21 BellSouth, all management of pre-production defects have been migrated to one tool,
22 Quality Center. This utilization of a single tool will allow more operational control and
23 management oversight in the pre-production defect management process. Indeed,
24 AT&T's plans to merge the local wholesale OSS across 22-states is to better provide and
25 sustain effective management of these important processes going forward.

26
27 Immediately following any software release, AT&T undertakes a sustained effort
28 to correct any defects that may be introduced with the implementation of new code. This
29 is typically done over a two week period following the release and is referred to as a
30 warranty period. Once this is completed, AT&T takes a more cautious approach and
31 applies defect resolution in a manner that attempts to balance the corrections needed with
32 the impacts to the client (or customer) implementing such corrections may create, as well
33 as, the possibility of creating more errors as defects are corrected.

34
35 With the implementation of the April Release, AT&T quickly identified issues
36 surrounding certain CLEC notifications. From these issues, defects were analyzed and
37 corrected, and all notifications were transmitted or retransmitted if there was question as
38 to the notification containing the appropriate Firm Order Confirmation (FOC) or Reject
39 information. A subsequent, proactive process was identified to send Billing Completion
40 notifications and, further, a proactive means was also developed to apply billing
41 adjustments to CLECs that had orders completed during the time immediately following
42 the April Release and which may not have received appropriate billing completion
43 notices. Because of the number of issues that arose from the April release, AT&T
44 significantly extended the warranty period following the release beyond the typical two
45 week period.

46

1 AT&T is constantly looking at methods to improve its processes. With the
2 migration to a unified defect reporting system, one management group has been assigned
3 responsibility for defect management. This reorganization has allowed a consolidation of
4 processes and a clearer coordination and accountability to standardize identification,
5 classification, and remediation of defects. The classification of defects includes both
6 standardization of CLEC vs. Non-CLEC impacting designations, as well as, the
7 application of appropriate standards based upon a specific region's existing or in effect
8 performance metrics.

9
10 From AT&T's perspective, it should be noted that following the April Release,
11 the issues with CLEC notifications did not prevent the provisioning processes from
12 working. The vast majority of CLEC requests were processed as expected. The CLEC
13 LSRs that were submitted had appropriate service orders created and were provisioned as
14 requested. Service to the CLEC end users was provisioned as would be expected, and
15 end users maintained continuity of service.

16
17 As noted in the Report, with the efficiencies gained in migrating to one OSS
18 platform, the production defect management process is now administered in one
19 application. This allows significant improvement in the communications between work
20 groups that are analyzing, correcting, and assessing impacts of defects across
21 applications. It also allows the administration of the defect management process to reside
22 within one manager group which inherently will provide a better coordination of efforts
23 and efficiencies in applying corrective strategies.

24
25 The Report suggests certain concerns and potential changes to AT&T's OSS-
26 related performance measurements that are contained in AT&T's performance plan (i.e.
27 SQM/SEEM Plan). (Report, at p. 35). As an initial matter, it is AT&T's position that
28 such concerns are outside the agreed upon audit scope and should not be included in the
29 Report. Rather, proposed revisions to the SQM/SEEM Plan should be proposed,
30 discussed, and debated in the context of the next periodic review of the current
31 SQM/SEEM Plan.

32
33 In any event, the accuracy of the SQM remains intact. As recently as August
34 2008, AT&T worked with a requesting CLEC to verify the accuracy of their specific
35 report and associated remedy calculations and the accuracy of the results were confirmed
36 by the inquiring CLEC. Additionally, during its investigation and report clarification
37 efforts associated with the Enhanced Defect Report (EDR), AT&T has taken steps to
38 investigate and provide additional assurances that the data being identified in the defect
39 process is properly collected and reported in the SQM measures and remedies are
40 accurately being calculated as appropriate.

41
42 AT&T has incentive to deploy flawless releases. Due to the performance issues
43 surrounding the timeliness in providing responses to CLEC requests, AT&T incurred
44 significant and substantial SEEM liability in the areas of FOC timeliness, Reject Interval,
45 and FOC and Reject Completeness. These SQM measures (and associated SEEM

1 remedies) were designed specifically to identify and remedy areas where AT&T does not
2 perform to a high level of performance as outlined in the SQM/SEEM plan.

3 4 **5.0 Commitments & CLEC Communications**

5 6 **Communications**

7 Staff's primary criticism of Communication focuses on two processes approved
8 by this Commission and by the FCC in connection with the AT&T ILECs' 271
9 applications: Change Management and SQM/SEEM. Both processes, which are subject to
10 periodic review and tweaks, are operating properly and require no out-of-process
11 modifications to account for a one-time event like the April Release.

12
13 Staff suggests that AT&T has not "provided a clear indication or direction of the
14 new change management meeting framework to evaluate and address CLEC concerns."
15 It is difficult for AT&T to respond to this assessment since it does not appear to be based
16 upon any audit documentation. From CMP and the communications in which AT&T has
17 participated, we know that it is pretty much impossible to please all CLECS, all the time.
18 The needs and objectives of AT&T's wholesale customers are not the same. And so
19 some process changes that are applauded by one segment of the market place are
20 criticized by others. AT&T strives, and believes that it is largely successful, in balancing
21 competing demands and in meeting the legitimate needs of its customers.

22
23 Staff's Report acknowledges that AT&T offers CLECs numerous avenues of
24 communications: formal processes via the CLEC User Forum (CUF), Change
25 Management (CMP) and accessible letters. But Staff fails to acknowledge equally
26 important and often more effective, the less formal processes via one-on-one
27 communications with account managers and Service Quality Managers dedicated to OSS
28 issues. AT&T sponsors many channels of communication not only to keep CLECs
29 informed, but also to solicit their input. Account teams have been staffed to assist clients
30 with identification of products and services available to CLECs. Local Service Center
31 (LSC) personnel are available to address individual concerns with CLEC orders and
32 Wholesale Customer Support Managers (WSMs) are in place to address operational
33 issues that may arise during the processing of day-to-day transactions. Moreover,
34 communication before, during and after major releases are well-defined and effective.
35 AT&T engages in extensive communications with its clients, including walk-throughs
36 and periodic status calls, in connection with every major release.

37
38 Staff also fails to give AT&T full credit for soliciting and accepting Staff and
39 CLEC input into areas where communications can be improved. The CUF was
40 established to provide an avenue for AT&T and its CLEC customers to identify and
41 resolve operational issues that arise in day-to-day business operations. After the
42 implementation of the April release, several CLECs advised AT&T of difficulties they
43 were having with the new manual processes. AT&T agreed to investigate the issue and
44 created a standing agenda item directly related to manual processes and the training and
45 accessible letters associated with these processes. AT&T went even further and

1 implemented a Manual Process Forum to discuss effectiveness and improvement to
2 processes.

3
4 AT&T responded to CLEC input received via CUF, CMP and informal
5 communications with account management, and implemented daily post-release status
6 calls to keep CLECs up-to-date on implementation issues. A more formal process was
7 created so that CLECs could provide input into OSS-release related accessible letters
8 before they are issued. Finally AT&T has made improvements to the EDR reporting
9 process to insure that CLECs have all the information they need in a timely manner about
10 defect status and resolution plans.

11
12 AT&T disagrees with Staff's statement that CMP needs to be better defined or
13 changed. The process, which was jointly developed and agreed upon by AT&T and
14 CLECs, has worked well for over ten years and already has, within its framework, a
15 process for making changes. There is a formal agenda for both CUF and CMP meetings,
16 which are closely followed and which provide necessary structure to these forums. CMP
17 is not limited to Florida. The same process is used every southeast states in which AT&T
18 operates as an incumbent local exchange carrier. In additional there is a similar process
19 in AT&T's 13-state region. There are many CLECs who participate in CMP who do not
20 provide service in Florida. To make Florida-specific changes would require AT&T to
21 manage one CMP for Florida alone, one for the other Southeast states and one for the 13-
22 state region. Such an approach would make it harder for multi-jurisdictional CLECs to do
23 business with AT&T and much harder for AT&T to meet the needs of its wholesale
24 customers. Rather than use this docket as a vehicle to instigate changes to CMP, AT&T
25 believes that the forum itself is the right place for such changes to be discussed and made,
26 if approved by participants from all regions.

27
28 Similarly, AT&T does not believe this audit is the proper forum to discuss
29 changes, if any, to the SQM/SEEM Plan. As previously stated, such concerns are outside
30 the agreed upon audit scope and should not be included in the Report. Rather, proposed
31 revisions to the SQM/SEEM Plan should be proposed, discussed, and debated in the
32 context of the next periodic review of the current SQM/SEEM Plan.

33 34 **Commitments List**

35 Staff states that it cannot validate whether or not AT&T has made the changes
36 contemplated by the Commitments List and recommends that AT&T recheck the process
37 improvements it has made and also that AT&T reopen some issues. Staff's requested
38 actions are not necessary and should not be adopted.

39
40 The Commitments List is a summary of the commitments that AT&T voluntarily
41 made in response to its post-April Release self-examination, as well as at the requests of
42 CLECs. In most cases, the Company did not sit down and write up formal methods and
43 procedures, nor create extraneous documents listing every improvement; we simply
44 identified the problems, made the necessary changes and communicated those
45 improvements to our customers via CMP and accessible letters. AT&T suggests that the
46 "proof is in the pudding." Although Staff does not acknowledge it in their Report, AT&T

1 has executed two nearly flawless releases since April. And although these releases were
2 not as large or far reaching as the April Release, the processes and personnel who
3 implemented those projects were the same ones involved in the April Release and the
4 same ones who will be responsible for future 22 state releases. The proof is not just in
5 the success of these more recent releases, but is also reflected in the detailed Test Plans
6 provided to Staff and CLECs. On September 11, 2008, AT&T provided Staff with a
7 copy of the enhanced test plan demonstrating every April Release and KLR-driven issue
8 and the corresponding improvements. Communications with CLECs are also a good
9 indication that AT&T's process improvements have worked. The daily and then weekly,
10 CLEC status calls to address April Release issues, have not been required since July 15,
11 2008. Monthly CMP meetings and other standard forms of communication show a return
12 to not only business as usual, but business improved.

13
14 AT&T committed to an enhanced 22-state test plan. The KLR process first
15 identified this need and informed the development process. This improved test plan
16 outlines methodology, responsibility, and accountability with more clarity and rigor than
17 had existed previously. The test plan also provides a channel and feedback mechanism to
18 improve communications between project managers, development and test teams, and
19 users and clients of the OSS systems. All facets of the project are reviewed and
20 consensus is developed to assure that a full test case suite is developed and implemented
21 prior to a release being deployed. The coordination of testing now resides with a 22-state
22 test manager who is responsible for the pre-deployment testing and communication of
23 testing results. AT&T has refined this role through the successful deployment of two
24 releases since April. The August 2008 and November 2008 releases were deployed
25 nearly flawlessly and the communications to the CLEC community worked as expected.
26 These indicators show that the processes AT&T has put in place will help provide a
27 greater confidence in deploying future 22-state releases.

28
29 AT&T voluntarily committed to introduce 32 improvements prior to the
30 implementation of the next 22-state release. Of those 32, Staff concurs that AT&T
31 properly closed all but seven. AT&T believes it has met all of the 32 commitments,
32 including the seven Staff questions. AT&T's specific responses to Staff comments on
33 those seven commitments are as follows:

34
35 **1. Resolve all Severity 1 and 2 defects.**

36 **Staff's assessment:** Staff believes that it is premature to close this item. AT&T has
37 satisfied the resolution of all Severity 1 defects; however, ■■■ Severity 2 defects remain
38 open. Staff expects the remaining Severity 2 defects to be remedied prior to
39 implementation of the next 22-state OSS release.

40
41 **AT&T response:** AT&T believes there is no reason to keep this issue open. AT&T
42 committed that before the next 22-state release that it would resolve and close all of the
43 Severity 1 and 2 defects resulting from the April release, which were open as of May 15.
44 AT&T has gone beyond that commitment and has now closed *all* Severity 1 and 2 defects
45 associated with the April release.

46

1 **6. Provide an outline of CLEC training materials for future 22-state releases. Staff's**
2 **assessment:** Staff believes that it is premature to close this commitment. While staff
3 recognizes AT&T's efforts to develop guidelines for the next two OSS Releases, the
4 training guidelines and specific plans have yet to be provided to staff and discussed with
5 the CLECs.

6
7 **AT&T response:** AT&T believes there is no reason to keep this issue open. Verigate
8 training was implemented in November. On-line self-paced training was made available
9 on November 24 and a leader-led virtual presentation was made available December 1,
10 2008 – December 12, 2008. A number of CLECs attended the leader-led training.
11 Specific details regarding the training plans are provided on line. LEX training will be
12 offered one month prior to the planned release, now scheduled for November, 2009
13 (when the test environment will be available). The LEX training will be similar to the
14 Verigate training in terms of comprehensiveness of material and method of delivery.

15
16
17 **10. Perform internal documentation review to enhance clarity of web-based defect**
18 **reporting.**

19 **Staff's assessment:** Staff believes that it is premature to close this commitment. Staff
20 acknowledges that AT&T has developed internal documentation to enhance the clarity to
21 support the process for creating a defect report. However, staff is concerned that the
22 information provided on the web-based defect report does not adequately reflect enough
23 information for CLECs to discern the status and resolution of defects. This issue was
24 raised by the CLECs in the November 5, 2008 CMP meeting.

25
26 **AT&T response:** AT&T believes there is no reason to keep this issue open. The
27 Company provided revised documentation supporting the process for creating a daily
28 defect report. The documentation further clarifies defect descriptions and also includes
29 additional internal procedures, such as multiple peer-to-peer review prior to posting.
30 AT&T considers this item to be closed. AT&T also added a second EDR team member to
31 review the accuracy and clarity of the data posted for the EDR and SE CRs to ensure they
32 are in sync. In addition, the descriptions are reviewed daily to ensure that they are readily
33 understandable. Each business day, the EDR report is updated and placed on CLEC
34 Online. CLECs have been advised that this is the data source for defect reporting.
35 CLECs were briefed on the improved EDR process at the January CMP meeting.

36
37 In the event that any CLEC has questions about a particular defect, they can contact their
38 Wholesale Support Manager for further information and if such communications suggest
39 that additional information would be helpful, AT&T will update EDR to provide
40 additional clarity.

41
42 **11. Perform internal documentation review to enhance clarity of XML**
43 **documentation.**

44 **Staff's assessment:** Staff believes that it is premature to close this commitment. While
45 the process of consolidating the pre-ordering and ordering business rules has been
46 documented, the process itself has not been fully implemented. AT&T noted that the
47 AT&T Southeast LSOR will be available with the November OSS Release, while the

1 LSPOR is currently in development and will be available after implementation of the 22-
2 state XML application.

3
4 **AT&T response:** AT&T believes there is no reason to keep this issue open. AT&T's
5 LSOR is currently available on the CLEC Online website. Upon the request and
6 agreement of CLECs, the LSPOR will be available for the November 2009 OSS release if
7 XML is implemented in July.

8
9 **14. Take into consideration comments received from customers to date and cover
10 results with CLECs once completed.**

11 **Staff's assessment:** Staff believes that it is premature to close this item. Although staff
12 agrees with AT&T's process of using the Action Log to capture CLEC comments after
13 they have been accepted, AT&T did not elaborate on the company's current CMP
14 procedures and processes for escalating and denying CLEC action item requests.

15
16 **AT&T response:** AT&T believes there is no reason to keep this issue open. Unlike
17 CUF, the majority of CMP action items are generally questions that arise during a
18 meeting which need further clarification. The action items are researched and responses
19 provided, typically at the next CMP meeting. CLECs always have the option of
20 escalating any issue/response via the CMP chain of command, which is posted on the
21 CLEC Online website.

22
23 **24. Assess CLEC concerns where all pages of a form are required whether or not
24 all pages contain data. Address customer concerns regarding the requirement of
25 additional data.**

26 **Staff's assessment:** Staff concurs with AT&T to close this item with the understanding
27 that AT&T did address the CLECs concern regarding the requirements for additional data
28 to properly complete manual LSR forms. However, staff believes that issuance of one
29 Accessible Letter after another is not the appropriate means to provide corrections to
30 ordering processes. For example, below is a listing of 15 Accessible Letters addressing
31 the manual email ordering process alone. Staff believes that AT&T and the CLECs
32 should develop and pursue an alternative means of documenting and communicating
33 corrections and resolutions made to existing processes that are used in a production
34 environment.

35
36 **AT&T response:** While AT&T agrees with Staff that use of multiple accessible letters
37 to advise the CLEC community of the changes in the ordering process may have lead to
38 some confusion, the Accessible Letter process should not, however, be replaced as the
39 primary method of communicating with CLECs; it is the standard means throughout
40 AT&T's 22-states of notifying wholesale customers of process changes. Moreover, it is a
41 process CLECs are familiar with and is the most efficient means of reaching the broadest
42 number of CLECs in the least amount of time. In addition, a number of ICAs require that
43 changes in process are to be communicated via Accessible Letters. To enhance
44 communication with the CLEC community, AT&T agreed in CUF meetings to provide a
45 walk through of all new forms and form changes with the CLECs via Live Meeting or
46 like medium, prior to the implementation/effective date of the form changes. The walk

1 through will occur approximately one month following the initial accessible
2 letter announcing the change.

3
4
5 **25. Review and assess the prioritized list of customer change requests for**
6 **enhancements to the 22-state email LSR process. Reevaluate merger related OSS**
7 **Change Requests previously submitted through the Change Management process.**

8 **Staff's assessment:** Staff believes that it is premature to close this item. It appears that
9 CUF Issue 08-008 may have been discussed and possibly resolved in the September 2008
10 Email Ordering Forum; however, no supporting documentation was provided to staff to
11 concur with closure of this item.

12
13 **AT&T response:** AT&T believes there is no reason to keep this issue open. Issue 08-
14 008 was closed at the September 2008 CUF meeting. From the current closed CCR log
15 posted on CLEC online: "AT&T stated that the Frequently Asked Questions document
16 and the Manual Ordering Guidelines were updated to include additional information and
17 clarification as well as requested examples. STS agreed to close this issue."

18
19 Regarding "Best Practices" provided to AT&T for consideration, AT&T has reviewed the
20 CLEC change requests to ensure that all Southeast functionality will be maintained or
21 enhanced with the implementation of 22-state LEX and XML. As discussed in the
22 CMP/CCP meetings, these change requests will be reevaluated after the implementation
23 of the 22-state release for any opportunities to further enhance AT&T's OSS capabilities
24 in compliance with CCP/CMP guidelines.

25
26 **26. Complete updates to the Local Ordering Handbook to reflect changes via the**
27 **Accessible Letter.**

28 **Staff's assessment:** Staff concurs with AT&T to close this item with the understanding
29 that AT&T did address the CLECs concern regarding the updates to the Local Ordering
30 Handbook. However, staff believes that issuance of one Accessible Letter after another
31 is not the appropriate means to provide corrections to ordering processes. Staff believes
32 that both AT&T and the CLECs should work together to develop and pursue an
33 alternative means of documenting and communicating corrections and resolutions made
34 to existing processes that are used in a production environment.

35
36 **AT&T response:** As with manual process form changes, the Accessible Letter should
37 not be replaced as the primary method of communicating with CLECs; it is the standard
38 means throughout AT&T's 22 states of notifying wholesale customers of process
39 changes. Moreover, it is a process CLECs are familiar with and it is the most efficient
40 means of reaching the broadest number of CLECs in the least amount of time. In
41 addition, a number of ICAs indicate that changes in process are to be communicated via
42 Accessible Letters.

43
44 **32. Continue to review staffing levels to meet anticipated demand for Wholesale**
45 **Customer Support and Centers.**

1 **Staff's assessment:** Staff believes that it is premature to close this item. AT&T failed to
 2 provide staff with any documentation in support of staff requirements. At a minimum,
 3 staff expects to see an assessment of staffing levels based on current and forecasted
 4 demand and the impact to staffing levels based on implementation of future 22-state OSS
 5 releases.

6
 7 **AT&T response:** AT&T believes there is no reason to keep this issue open. Appropriate
 8 staffing levels are constantly monitored to insure quality service to CLECs. AT&T has a
 9 proven history of effectively managing the balance of mechanization and force
 10 requirements to meet its' customers demands.

11 12 13 **Staff Recommendations**

14
 15 Staff's report contains 18 recommendations for additional actions AT&T should perform
 16 to resolve any remaining April Release issues. In many cases AT&T concurs in Staff's
 17 assessment and has already taken the recommended action.² In a few cases, AT&T
 18 believes Staff's recommendation does not make good business sense and will not
 19 improve service to CLECs. In these instances, AT&T opposes Staff's recommendation.
 20 AT&T's position on each recommendation is addressed below.

21 22 **KLR/Root Cause Analysis**

23
 24 • AT&T should resolve the ■ open key learnings prior to implementing the next
 25 22- state release.

26
 27 **AT&T position:** AT&T concurs. It has continued to resolve the open key learnings as
 28 per normal processes. At this time, ■ of the ■ open items have been closed. The
 29 ■ remaining open KLRs will be closed by the implementation of the March 2009
 30 release.

31
 32 • AT&T should perform an internal review to ensure that all recommendations
 33 were completely and satisfactorily implemented and that each of the resolutions has
 34 adequately corrected the specified issue.

35
 36 **AT&T position:** AT&T has engaged in such as review. The process itself insures that
 37 KLR recommendations are properly implemented. AT&T has reviewed selected
 38 recommendations associated with the most significant findings and, coupled with the
 39 successful August and November releases, is satisfied that all issues have been addressed
 40 and appropriate corrective action taken.

41
 42 • AT&T should reevaluate it key learnings root cause analysis process and ensure
 43 that the approach followed is adequate.

44

² Staff qualifies its assessment in some places; AT&T concurs in Staff's qualifications with the exception of Commitments 24 and 26 which are addressed in the Commitments Section of these Comments.

1 **AT&T position:** The key learning process has served AT&T very well. As part of the
2 organizational changes made after the April release, a more uniform approach to the
3 process is being followed. This process is working well as indicated by two successful
4 releases implemented since April.

5
6 • AT&T should reevaluate its root cause analysis for selected key learnings and
7 ensure that all causal relationships have been identified and the resolutions identified are
8 sufficient.

9
10 **AT&T position:** AT&T has reviewed the key learnings identified in the audit report and
11 is satisfied that all causal issues have been identified and resolved.

12
13 • AT&T should reevaluate resolutions which have been identified as prematurely
14 closed, particularly those related to vendor coordination, and take appropriate action.

15
16 **AT&T position:** When the resolutions were originally developed, the on-line tool was
17 updated to indicate what action was planned. After correct measures were implemented,
18 the issue owners had the responsibility for updating the tool to mark the KLR closed, but
19 in some cases the wording they used did not properly reflect past tense—in other words
20 that the issue had been resolved, but not properly recorded. These KLRs have since been
21 updated to reflect the action that was taken.

22
23 • AT&T should consider incorporating input from its CLEC clients in its future key
24 learnings process.

25
26 **AT&T position:** Staff criticizes AT&T for not seeking CLEC input, when in fact the
27 ongoing dialog that AT&T has with its customers informally and via the CMP process
28 provides ample CLEC input. CLECs also have the opportunity to provide input to the
29 KLR process via post-release conference calls that AT&T holds following each release,
30 as well as by submitting comments to the CMP mailbox. Nevertheless, AT&T will begin
31 to more formally request input from the CLECs beginning with the March 2009 release.
32 During post-Release CLEC calls, AT&T will request that CLECs email any opportunities
33 for improvements, or to identify what worked well with the release to the CMP mailbox.
34 These “learnings” will then be included and managed with all of the internally generated
35 ones. Follow-up will be provided to the CLECs via email when action plans have been
36 developed and a target date assigned for resolution and again when the action plan has
37 been implemented.

38 39 **Defect Management**

40
41 • AT&T should review the April Release defects and the root causes identified for
42 each and ensure that a root cause has been identified and that appropriate action has been
43 taken to prevent future occurrences.

44
45 **AT&T position:** AT&T has carefully reviewed the root causes associated with defects.
46 The Company has consolidated defect management responsibilities into one work group

1 to better identify, classify and coordinate corrections and apply appropriate root cause to
2 each defect.

- 3
4 • AT&T should improve its emphasis on defect root cause analysis through written
5 policies and procedures, assignment of responsibilities and employee training.

6
7 **AT&T position:** With the consolidation of the defect management responsibilities,
8 AT&T has provided more structure to the process and better control over defect
9 resolution. This includes the opportunity to provide better training and oversight leading
10 to improved remediation of root cause effects.

- 11
12 • AT&T should continue to evaluate the consolidation of its defect management
13 process to ensure that defects are resolved in an expedient manner and are compliant with
14 the benchmarks established by the Florida Public Service Commission.

15
16 **AT&T position:** As a part of the EDR review, AT&T has reviewed the processes
17 associated with the data collection and reporting of defects. This review has resulted in
18 the formulation of procedures and tracking which will insure that all defects are identified
19 and accurately reported. CLECs and Staff were briefed on the revised process during the
20 January 7, 2008 CMP call.

- 21
22 • AT&T should review the accuracy of data collection and reporting for all Change
23 Management Service Quality Measures and the Self-Effectuating Enforcement
24 Mechanism.

25
26 **AT&T position:** While not expressly within the scope of the audit, AT&T has, as part of
27 a review of the EDR, reviewed the processes and procedures associated with the data
28 collection and reporting of defects. This review has resulted in the formulation of
29 procedures and tracking done to assure that all appropriate defects are identified,
30 accurately reported and expeditiously resolved. CLECs and Staff were briefed on the
31 revised process during the January 7, 2008 CMP call.

- 32
33 • AT&T should reevaluate its use of the CLEC impacting classification and either
34 eliminate it, giving CLECs full visibility of defects, or have a clearly communicated
35 definition of when it is applicable.

36
37 **AT&T position:** AT&T has reexamined the processes of classifying defects as CLEC-
38 impacting and has documented that information. The definition of CLEC-impacting
39 defect is addressed in the SQM plan that is currently in effect in Florida.

40 41 42 **Communications and Commitments**

- 43
44 • AT&T should clearly define and document the monthly Change Management
45 meeting process.

1 **AT&T position:** The monthly meetings, which are governed by two sets of detailed
2 guidelines, are already well-defined in the Competitive Local Exchange Carrier OSS
3 Interface Change Management Process (Section 8.2) and the 9-state Change Control
4 Process guidelines, (Section 4, Part 2, Step 6). CMP meetings are divided into three
5 sections to accommodate all requirements: items affecting all regions, 13-state items, and
6 9-state items. The CMP/CCP agendas, is also divided into sections. The agendas, along
7 with action items, meeting minutes and other required documents are posted on the CMP
8 website.

9
10 • The Commission should commence an expedited review of AT&T's SQM and
11 SEEM Plans prior to implementation of 22-state releases scheduled in 2009.

12
13 **AT&T position:** Although outside the scope of the audit, the SQM/SEEM Plan is subject
14 to a periodic review process. When Staff commences such a review, AT&T will
15 participate in the review process along with the Staff and the CLEC community.

16
17 • AT&T should reevaluate its closure of seven commitments (items 1, 6, 11, 13, 14,
18 25, and 32 in Appendix F) and take necessary steps to assure the commitments have been
19 fully addressed.

20
21 **AT&T position:** As explained in the Commitments section above, AT&T has met all 32
22 voluntary commitments, including the seven cited by Staff.

23
24 • AT&T should prepare and provide Staff with pre-production and production
25 defect status reports specific to each 22-state OSS release as they occur.

26
27 **AT&T position:** Staff is effectively asking AT&T to create a special defect report. This
28 is not necessary. AT&T has an on-line tool, the EDR, which identifies CLEC-impacting
29 defects. AT&T also provides status calls for CLECs, which Staff is welcome to attend,
30 which update affected parties on the pre-implementation and post-implementation
31 environment. To pull the resources involved in identifying, reporting on and correcting
32 defects to create Staff-specific reports does not seem necessary, or a wise use of
33 resources. No such processes were in place for the August and November releases and
34 no issues were encountered.

35
36 • AT&T should provide Staff with Expanded Test Plans for all future 22-state
37 releases as they become available, and continue to educate CLECs on future 22-state
38 release test plans.

39
40 **AT&T position:** AT&T will provide Staff with copies of test plans for 22-state test
41 plans for the scheduled 22-state releases.

42
43 • AT&T should continue to enhance the 22-state manual email ordering process to
44 include efficiencies that previously existed in the manual processing of orders in the 9-
45 state region.

46

1 **AT&T position:** AT&T has compared pre-release SE manual processes to the new e-
 2 mail process and has also reviewed the CLEC change requests related to manual
 3 processes to ensure that all Southeast functionality will be maintained with the
 4 implementation of 22-state LEX and XML. As discussed in CMP/CCP meetings, these
 5 change requests will be reevaluated after the implementation of future 22-state releases
 6 for any opportunities to further enhance AT&T's OSS capabilities in compliance with
 7 CCP/CMP guidelines.

8
 9 • AT&T should provide staff with an assessment on current call center activities
 10 and staffing levels, and an assessment of call center activities based on future 22-state
 11 releases.

12
 13 **AT&T position:** Appropriate staffing levels are constantly monitored to insure good
 14 service to CLECs.

15 16 **Conclusion**

17
 18 As stated herein, AT&T commends Staff's efforts in drafting and issuing the
 19 Report. Further, AT&T is confident that AT&T has in place (or has developed) to ensure
 20 that future 22-state OSS Releases are implemented with minimal impact on the
 21 operations of CLECs.

22
 23 Respectfully submitted this 9th day of January 2009.

24
 25
 26

 27 E. EARL EDENFIELD
 28 TRACY W. HATCH
 29 MANUAL L. GURDIAN
 30 150 So. Monroe Street, Suite 400
 31 Tallahassee, FL 32301
 32 (850) 577-5508

33
 34 ROBERT A. CULPEPPER
 35 AT&T Midtown Center
 36 Suite 4300
 37 675 W. Peachtree St., NE
 38 Atlanta, GA 30375
 39 (404) 335-0841

40
 41
 42 Attorneys for AT&T Florida

43
 44
 45
 46 727113